

Protection and Deception: Discovering Game Theory and Cyber Literacy through a Novel Board Game Experience

Saboor Zahir, John Pak, Jatinder Singh, Jeffrey Pawlick, Quanyan Zhu

Abstract—Cyber literacy merits serious research attention because it addresses a confluence of specialization and generalization; cybersecurity is often conceived of as approachable only by a technological *intelligentsia*, yet its interdependent nature demands education for a broad population. Therefore, educational tools should lead participants to discover technical knowledge in an accessible and attractive framework. In this paper, we present *Protection and Deception (P&G)*, a novel two-player board game. *P&G* has three main contributions. First, it builds cyber literacy by giving participants “hands-on” experience with game pieces that have the capabilities of cyber-attacks such as worms, masquerading attacks/spoofs, replay attacks, and Trojans. Second, *P&G* teaches the important game-theoretic concepts of asymmetric information and resource allocation implicitly and non-obtrusively through its game play. Finally, it strives for the important objective of security education for underrepresented minorities and people without explicit technical experience. We tested *P&G* at a community center in Manhattan with middle- and high school students, and observed enjoyment and increased cyber literacy along with suggestions for improvement of the game. Together with these results, our paper also presents images of the attractive board design and 3D printed game pieces, together with a Monte-Carlo analysis that we used to ensure a balanced gaming experience.

Index Terms—Cyber literacy, security awareness, cybersecurity, deception, board game

I. INTRODUCTION

Cybersecurity has been directly in the limelight of contemporary media. The Sony Pictures Entertainment hack over the controversial film *The Interview*, the infamous debut of the Snowden Revelations and ensuing debate, and important security breaches at The Home Depot and Target Corporation have made

Department of Electrical and Computer Engineering, Polytechnic School of Engineering, New York University, Brooklyn, NY 11201. {sz903, jp3122, js6160, jpawlick, quanyan.zhu} @nyu.edu

This work was supported in part by the New York University Prototyping Fund, a collaborative program offered by the *Greenhouse* at NYU and the *NYU Entrepreneurial Institute*.

It was also supported in part by an NSF IGERT grant through the *Center for Interdisciplinary Studies in Security and Privacy (CRISSP)* at NYU.

national news at all levels of society. The U.S. Federal Government’s commissions of reports on big data and privacy [2] and bulk collection of signals intelligence [3] - together with the surging interest in cybersecurity from academic and commercial perspectives - suggests an intense effort to combat cybercrime from the top-down. But cybersecurity is an interdependent phenomenon. This interdependency demands cyber literacy that branches out from technology companies and computer science schools to consumers of the technology that they develop. It also requires a grassroots effort at igniting interest in cyber-careers as an investment in tomorrow’s human capital.

Serious games offer a promising means to overcome the intimidating nature of learning about cybersecurity. Because it is difficult to perceive how security threats affect individuals, and because cyber experience and vocabulary are not well-integrated among those in non-technical fields, cybersecurity can seem to pose a high barrier to entry [4]. Serious games employ the entertainment value of games towards accomplishing distinct educational objectives. They sit upon an intersection between engineering, science, and education. Our work is a serious game with the objectives of answering such basic questions as “What is a masquerading attack?” and “How is a local area network different from the internet?”

Several recent educational efforts have promise for technical professionals or aspiring STEM students. Proliferating *Capture the Flag (CTF)* competitions have placed security education in a non-technical environment. An application of *gamification*, they leverage the enjoyable properties of games in a real-life security challenge. But they may not be appropriate for novice participants. They do not (at least yet) especially represent an outreach of security education beyond the STEM fields and into populations underrepresented in technical fields. Games are needed that feature a gentle introduction to cyber-security; one that helps build cyber literacy without intimidation and teaches other concepts relevant to cybersecurity only implicitly.

In this work, we present *Protection and Deception*

(*P&G*), a two-player board game that combines a turn-based chess-like structure with elements such as infrastructure configuration that are characteristic of real-time strategy games. The basic gameplay is simple and follows a storyline related to cybersecurity. In *P&G*, both players configure local area networks (LANs) and allocate attack and defense packages. They hide “critical information” on one of their computers. Then, gameplay evolves in a sequence of turns in which players deploy attacks and navigate them through the network. Throughout the game, players learn about attack capabilities. They also face trade-offs between brute strength and maintaining information-assymetry - as when deciding whether to surveil an opponent’s LAN with a weak attack. Players achieve victory when they destroy the opponent’s computer containing the critical information.

P&G offers a gentle introduction to cyber literacy. Explicit cyber-jargon is limited to various types of cyber attacks: *e.g.*, viruses, Trojans, masquerading attacks and worms. The rest of the gameplay has parallels in traditional board games - although there are some parallels to collectable card games (*e.g. Magic: The Gathering* and *Yu-Gi-Oh!*). In this way, *P&G* attempts to lower the learning curve for serious security games so that they can reach populations outside of corporations or the university.

Indeed, we tested this game at a community center on the lower-east side of Manhattan. We found both encouraging results - in terms of interest in the game and acquired knowledge - and elements of the game that need to be improved and further simplified in order to attract young players. We were also inspired towards future work in digitalizing the game or providing game instructions in the form of a *YouTube* video.

The rest of the paper proceeds as follows. Section II describes the gameplay of *P&G* in detail. We were especially intrigued by one aspect of the gameplay design: attempting to balance the capabilities of cyber-attacks and defense packages. Towards this end, we created a Monte-Carlo simulation which we describe in Section III. Section IV describes our playtesting procedure and observations. Finally, we conclude the paper in Section VI.

II. GAMEPLAY

Protection and Deception (P&G) is a two-player board game. The goal is of the game is to locate and destroy the opponent’s computer that holds his *critical information*. This task is achieved through a combination of effective local area network (LAN) design, intelligent deployment of attacks and defenses, and quickly routing attacks and defenses to their

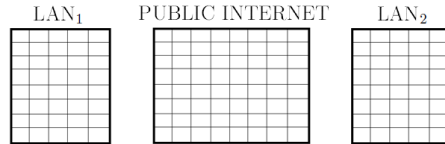

Figure 1. Basic board layout. Each player configures her own local area network, and connects via routers to the public internet. Network configuration is an optimization experience in which players need to make trade-offs between capabilities to defend critical information, utilize deception (hide critical information in unexpected computers), and rapidly deploy attacks.

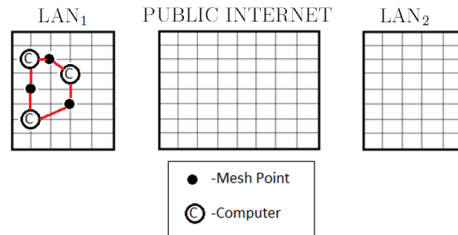

Figure 2. Basic board layout with three computers connected via mesh points and links

intended target. This requires balancing strength with maintaining the ability to deceive the other player. The first stage of *P&G* consists of LAN configuration.

A. LAN Configuration

Each player controls the following pieces:

- 1) 4 routers
- 2) 8 computers
- 3) 8 mesh points
- 4) 16 links
- 5) Deck of attack and defense cards

There are three components to the platform of the board game as shown in Fig. 1.

Each player will have a Local Area Network (LAN), which is essentially her base. The players configure these LANs. The board that is in the middle of the two LANs is the public Internet, which has static configuration.

The game begins with each player setting up her own LAN. A network topology consists of routers, computers, mesh points, and links. A mesh point is essentially a way to link two computers directly. Fig. 2 represents a sample network topology for Player A of three computers connected with the use of three mesh points.

Each player creates a network topology that consists of 8 computers, at least 4 mesh points and at most 8 mesh points, and 4 routers, which are accompanied by 4 routing links and must be connected to at least four

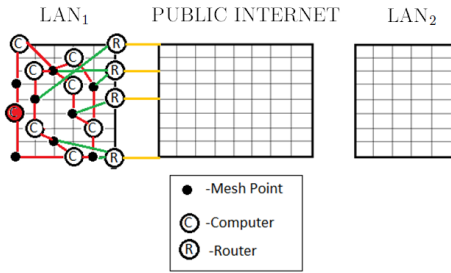

Figure 3. Sample configuration of LAN₁. The red computer holds critical information. The routing links are represented with green lines, while the computers are linked to each other or to mesh points with red lines.

mesh points. A router is used to connect computers to the public Internet. The 16 links are used in order to connect a computer to a computer, a computer to a mesh point, or a router to a mesh point. Each computer must use 2 to 3 links to connect to another computer or mesh point. Fig. 3 is a sample network topology. The routing links are represented with the green lines. In Fig. 3, the computers are linked to other computers or mesh points with the use of red links. After each player sets up his or her network topology, each player must designate one computer out of the eight computers as the computer that holds “critical information”. In Fig. 3, the computer that holds the critical information is colored in red.

Each router is connected to the public Internet with the use one link (in yellow in Fig. 3). Once each player has set up her network topology and decided on the computer that holds “critical information,” each player allocates the deck of attack and defense cards. Each computer, besides the computer that holds “critical information,” is assigned one attack card and one defense card. The next two subsections describe the attacks and the defense packages.

B. Attacks

Each attack card features a different type of attack. These attacks can be spawned from the computers equipped with the attack card. Fig. 4 depicts an image of one of the attack cards.

- 1) *Worm* - takes down a piece and then replicates if a host is taken down
- 2) *Masquerading Attack/Spoof* - propagates throughout a network without attacking a particular piece
- 3) *Denial of Service (DOS) Attack* - stops traffic within a mesh point.
- 4) *Virus* - attacks a computer and then the piece is reset

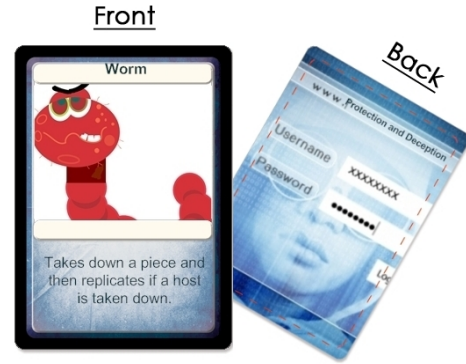

Figure 4. Sample attack card: *Worm* Attack

- 5) *Replay* - captures a packet and does not let it propagate throughout the network
- 6) *Trojan* - reveals the defenses that a particular computer has installed. A Trojan is also coupled with a weak level virus
- 7) *Modification Message* - changes the type of message/attack a computer sends. If this attack comes across the opponent’s attack at a node in the Internet, it can randomly select a different type of attack

C. Defense Packages

Players also equip computers with a defense package. The defense packages differ in terms of which attacks they block. We have counterbalanced these packages in order to prevent any one attack from becoming exceptionally powerful. (See Section III.) Fig. 5 depicts one of the defense package cards.

- 1) *Defense Package 1* - Blocks worm, replay, and masquerading attack/spoof
- 2) *Defense Package 2* - Blocks worm, denial of service (DOS), and modification message attacks
- 3) *Defense Package 3* - Blocks worm, virus, and Trojan attacks
- 4) *Defense Package 4* - Blocks worm, modification message, and masquerading attack/spoof
- 5) *Defense Package 5* - Blocks worm, Trojan, and DOS attacks
- 6) *Defense Package 6* - Blocks virus, replay, and masquerading attack/spoof
- 7) *Defense Package 7* - Blocks Trojan, replay, and DOS attacks
- 8) *Defense Package 8* - Blocks Trojan, replay, and modification message attacks

On every turn, each player is allowed to make one move. A move is defined as either spawning an attack or moving an attack one unit. An attack piece is represented as a ring. When a player spawns an



Figure 5. Sample defense package card: *Defense Package 1*

attack piece, she simply places the ring on top of the appropriate computer. An attack that is in a LAN follows the configured links. An attack that is in the public Internet moves along the sides of the squares. The attack is allowed to move either horizontally (left or right) or vertically (up or down). Each player does not know what the other player’s moving attacking is. An attack is revealed under one of two conditions:

- 1) A player attacks the opponent’s attack
- 2) A player attacks the opponent’s computer

A defense package is revealed if an attack is conducted on a computer. Below is a sample gameplay:

- 1) Player A has a worm attack. Player A attacks Player B’s computer.
- 2) Player B reveals the Defense Package that is assigned to the particular computer that is attacked: Defense Package 1.
- 3) Defense Package 1 is able to defend against a Worm, Replay, and Masquerading Attack/Spoof. Therefore, Player A’s worm attack is destroyed.

If an attack attacks a computer and the computer is successfully able to defend against the attack, the attack is destroyed. However, although the attack is destroyed, it can still be spawned from the starting point, which is the computer that the attack originated from, on another turn. If an attack attacks a computer and the computer is unable to defend against the attack, the computer is destroyed. The game ends once one player discovers and destroys the opponent’s computer that holds the “critical information”.

III. SIMULATION AND STRATEGY

Every game requires fairness for a balance of good gameplay. No single attack should dominate to the point where the game ends quickly. In this section, we first describe the results of a simulation that we used to balance the capabilities of the attacks and the defense packages, and then we describe a strategy that might

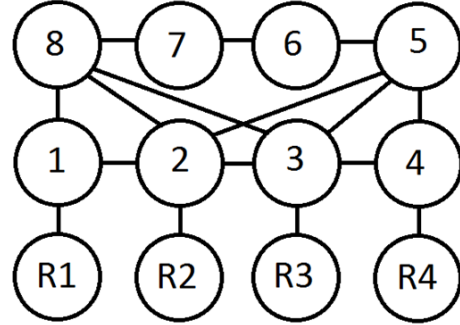

Figure 6. LAN topology used for Monte-Carlo simulation. In this simulation, we ran different attacks against different possible configurations of the defense packages. We ultimately designed the defense packages based on the configurations that created the most equal performance for the different attacks.

be employed based on insight from this simulation design process.

A. Simulation for Design

Flow is a notion developed by psychologists to describe a mental state in which one is completely involved in an activity for its own sake [1]. It is characterized as an activity where time flies. Fairness in a game is essential to induce flow [6]. We wanted to allocate defense capabilities such that no single attack was able to dominate. In order to do this, we simulated virus and worm attacks against a fixed network topology for different allocations of defense packages¹. This gave us a mapping from (number of defenses with the ability to block viruses) to (number of computers that a virus would likely destroy), and it gave us a similar mapping for worms. We then used the inverse of this mapping to allocate the capabilities of defense packages such that viruses and worms would be likely to destroy the same number of computers.

For the Monte Carlo simulation, we used the following topology in Fig. 6, one that is within limits and is symmetrical in nature.

For the random simulations, a random routing point was chosen from a uniform distribution. The virus was simulated such that it would not revisit nodes if it had the potential to explore unvisited nodes. The worm had

¹We simulated virus and worm attacks because they have least and most powerful special attack properties, respectively. The virus has no special attack power, while the worm has the power to continue to propagate if it is not destroyed. We allocated defenses against the other attacks by assuming that their special attack properties lie somewhere between those of the virus and worm. Thus, we configured between two defense packages (the number which were endowed with the ability to block viruses) and five defense packages (the number configured with the ability to block worms) with the ability to block the other attacks.

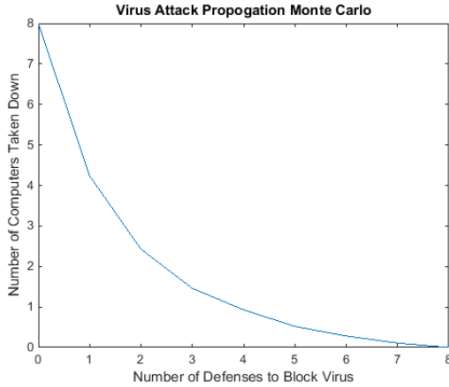

Figure 7. Number of computers destroyed by virus attack versus number of defenses equipped with the ability to block the virus. For instance, if four defenses were to be configured with the capability to block the virus, then the average virus attack would destroy approximately one computer.

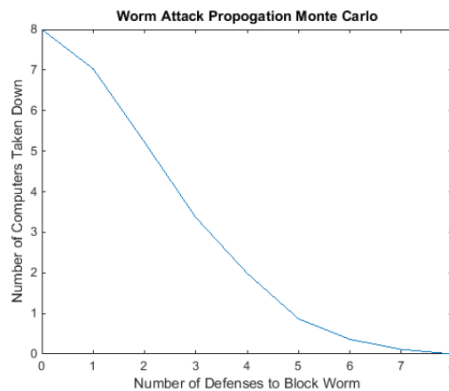

Figure 8. Number of computers destroyed by worm attack versus number of defenses equipped with the ability to block the worm

the capability to visit all nodes. For each number of defenses ranging from 0 to 8, 1000 simulations were done to average the number of nodes destroyed. Figs. 7 and 8 depict the results of these simulations.

Figs. 7 and 8 show that to give the virus and worm similar strengths, the number of defenses that protect against viruses should be less than that of worms. Based on the figures, four defense packages should be equipped with the ability to block worms and two with the ability to block viruses. This makes each able to destroy approximately 2.5 computers on average².

Based on the results of this simulation, the next subsection describes a sample strategic consideration that players might use to build a LAN and allocate defense packages.

²The first iteration of defense packages used preliminary simulation results. Thus, in the allocations discussed in Section II, there are five rather than four defense packages equipped with the ability to block worms.

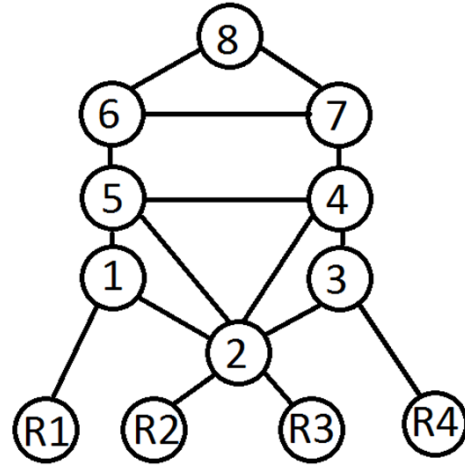

Figure 9. A topology to robustly protect against worm attacks

B. Strategy

Clearly there are some implicit guidelines for making a topology. For instance, it seems unwise to leave a direct path without worm defense to the critical computer. Such topologies arise in automatic wins if the correct attack is carried out. One particular defensive strategy that could be used is to create two *communities*.

The topology in Fig. 9 is an example of a dual-community topology. A community could be defined as a concentration of nodes with a high degree of interconnectivity. This dual-community topology in Fig. 9 also has the property that it forces attacks through certain computers on the way to computer number 8, in which the critical information is maintained. As a result, there are no short routes to get to node 8.

We conducted a simulation to analyze the effectiveness of this topology. The results of this simulation are shown in Fig. 10, which shows that fewer computers were eliminated on average for the same defensive configurations for the long dual-community strategy than for the default strategy.

From an offensive standpoint, an attack strategy might be to send out 4 attacks simultaneously. The attack that has the least probability of being defended against will attack a node. Once this node is attacked the defenses of that node are now known. If it successfully defends against one attack, the player has at least one other attack to take out this node. In fact, this method of attack is very effective when using the first attacker to be a virus because there are only two defenses against viruses.

C. Implicit Game-theoretic trade-offs

Besides explicitly teaching players basic cyber literacy, P&G also aims to give them implicit experience

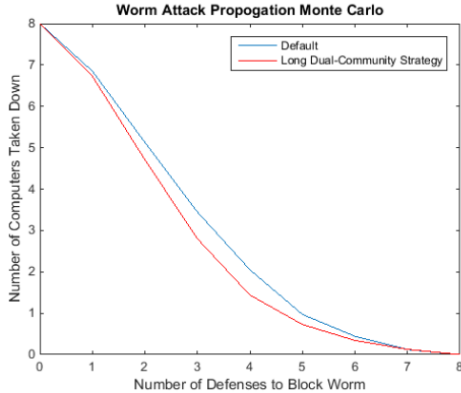

Figure 10. Computer casualties with default versus robust defense configurations

in game-theoretic optimization. This optimization is apparent in network configuration for defense and selecting optimal attack strategies.

The defensive network strategy embodied by the dual-community strategy depicted in Fig. 9, for instance, involves a trade-off. The advantage of the configuration is that it strongly protects computer number 8, which can be used to store the critical information. Unfortunately, this also reveals the likely location of the critical information to the opposing player! A more “flat” and network topology would have the advantage of more effectively disguising the location of the critical information. Such deception is heavily studied in the area of security in general [13], [14], [15], and is especially important in cybersecurity [16], [17]. In terms of game theory, choosing a flat topology amounts to preferring information asymmetry to brute force.

Information asymmetry is also important in selecting attack strategies. Initially, an attacking player has no knowledge of her opponent’s allocation of defensive packages. She has the option to use initial attacks primarily as “scouts” in order to ascertain the allocation of defense packages. Of course, this may involve sacrificing the turns that it takes to regenerate attacks. We are excited to see how players develop strategies that leverage these concepts - possibly without explicit knowledge of the scholarship behind them.

IV. PLAYTESTING

The initial target audience of *Protection and Deception (P&G)* was any person over the age of six. The game was tested out among various ages ranging from ages six to 21 years old. The testers were from two groups. The first was a combination of children who frequented a community center located in the Lower East Side of Manhattan, New York. The second

consisted of mostly college students. Our initial tests at the community center were conducted with four children.

We initially considered implementing structured pre- and post-play surveys that would have enabled statistical analysis. Encouraged, however, by advice from the educational community, we eventually opted for less structured observation that would not discourage students. Essentially, we collected evidence by open-ended observation.

Questions to the children before the game lasted no more than five minutes per player. We asked the players their age, what they know about cyber security, what academic subject they preferred, and what interests they pursued outside of school. The questions about favorite subject and interest were a means to figure out their backgrounds. We had children who were interested in math, science, basketball, painting, and other activities. These children at the community center did not have any explicit knowledge about cybersecurity. We asked whether they had heard of “hackers,” but they had not. We also tested the game with two high school students, one of which expressed interest in business and another in engineering. Finally, our second pool of testers were college students looking to pursue careers in the fields of engineering, medical, and art.

In the post-survey, all players were asked what they learned about cyber security, what they liked and disliked about the game. One 7-year old girl from the community center said, “I like the cards the most.” A 10-year old boy said, “I forgot which card I put down for the different computers” - which indicated to us an aspect of the board design that we can improve so that it is obvious which attack and defense cards have been allocated to each computer. A 20-year old college student studying medicine had a brief understanding about cybersecurity before the game, but after playing “learned how different attacks such as the worm worked and learned about cyber attacks that I didn’t know existed like masquerading.” A 17 year old in high school who expressed an interest in business said he would play the game if more of his friends knew about the game and how to play. He was asked a follow-up question if there was anything in the game he wanted to learn more about. He said he plays video games on his *PlayStation 4* console a lot and realized he “had an experience of denial of service when a group of hackers took down the *PlayStation* online network and I could not log on or use the network for a few days.” We were encouraged by this rather comical realization that cybersecurity concepts are especially embedded in non-academic activities.

For all age groups, the instructions seemed rather

complex; many times during the game, players would ask the testers whether moves were legal or ask about the results of particular actions. Importantly, we learned that it was helpful to follow the instructions with a quick demonstration of the game play. This adjustment in our introduction of the game decreased the difficulty of learning, although did not remove the learning curve completely. Based on this expressed difficulty, we are considering including video instruction or other means to make the game easier to learn. We describe these briefly in Section VI.

Finally, we noted that the game seemed enjoyable to players once the rules became clear. Players were excited when their attack successfully destroyed a computer or when their computers successfully repelled the opponent's attacks. Among the older players, we noted a competitiveness that emerged from the freedom allowed to choose different strategies. From observing the various age groups, it appeared that the testers that were around or over the age of 13 enjoyed the game the most. We will seek a much larger subject pool for further testing in order to refine the target age for *P&G*.

V. RELATED WORK

In the introduction, we described various classes of games from which *Protection and Deception (P&G)* derives its framework. Namely, *P&G* is a serious game - a game which teaches concepts which have actual value outside of serving the entertainment purpose of the game. *P&G* aims to build cyber literacy, as well as to implicitly teach about trade-offs between strength and information revelation. Furthermore, *P&G* represents an effort in the vast category of security education, a critical area of study in the light of intense regional and international conflicts in cybersecurity. Finally, *P&G* builds upon a tradition of games-based learning.

We can see similarities to *P&G* in at several recent games. From last year's *3GSE*, Microsoft's *Elevation of Privilege* [7] is a card game based on concepts from information security with a fascinating purpose: it is played between developers in order to discover security flaws of a system. *Elevation of Privilege* is an example of gamification, since it employs motivations from game-playing for a serious task. Developers in this game draw cards which prompt them to name vulnerabilities, and thereby accomplish a technical objective. *Elevation of Privilege* is obviously not geared towards a novice population.

Control-Alt-Hack [8] is a card game from *3GSE'14* which is geared towards a novice population. This game seeks to give participants an social experience

related to hacking, rather than teaching specific concepts. The network security game called *[d0x3d!]* [9] is also a similar effort to ours. It is a board game with changeable configuration achieved by tiles which are arranged at the beginning of gameplay. Players in *[d0x3d!]* deploy special abilities on their way to collecting digital resources ("loot"). Both games are attractively designed, and represent efforts to intelligently deploy and commercialize or test security games. They both use existing games re-skinned in cybersecurity concepts and terminology, whereas our game is an entirely new design.

Control-Alt-Hack and *[d0x3d!]* both seem to feature a higher degree of security vocabulary than *P&G*. Indeed, *P&G* represents an effort to reach out to non-technical, underrepresented, and young players. We are concerned not only about players who may not have the technological background to understand security concepts, but also players who may not have the attention span to learn a complicated game. In our own playtesting, we observed that even with the simple mechanics of our game, there was some learning curve. Thus, we aim to keep the security lexicon in *P&G* to a minimum. This will help us achieve the goal of engaging a diverse population in security awareness.

VI. CONCLUSIONS AND FUTURE WORK

Our initial work on *Protection and Deception (P&G)* opens up vast possibilities for future development. In terms of basic elements of gameplay, we have considered several options. First of all, the connection between security challenges and economic questions has been extensively noted in the literature [10], [11], [12]. Because of this, we are considering incorporating money or budgeting resources into the gameplay. We are also considering allowing players to elect to build up their LAN capabilities instead of deploying attacks. This trade-off pits myopic against farsighted strategies, and allows implicitly teaching the present value of future rewards. Finally, we have noted that a visual demonstration of play seemed to lower the learning curve for our participants. Because of this, we are considering deploying video instructions online that can be used to learn the game. On the more extreme end, the entire game could be digitized, or a hybrid board game and digital game combination could be considered.

In its present version, *P&G* is a board game designed to engage young, non-technical, and underrepresented players in the world of cyber security. *P&G* features a completely new design which relies on probabilistic simulation to ensure fair gameplay. The game offers three major contributions. First, by

exposing participant to various types of cyber-attacks such as *denial of service* and *masquerading attacks*, it builds cyber literacy in an inviting way. Second, it teaches aspects of game theory such as information asymmetry and deception implicitly. Finally, *P&G* engages players with little or no previous introduction to cybersecurity. Indeed, we conducted an initial set of tests with such a population at a community center in the Lower East Side of Manhattan, New York. Encouraged by these initial results, we hope to continue to improve *P&G* so that it can contribute to the important and vast contemporary challenge of cybersecurity education.

REFERENCES

- [1] M. Robert, "10 Biggest Data Breaches of 2014 (So Far)," *CreditUnionTimes*, 06-Oct-2014. [Online]. Available: <http://www.cutimes.com/2014/10/06/10-biggest-data-breaches-of-2014-so-far>. [Accessed: 16-May-2015].
- [2] President's Council of Advisers on Science and Technology, Chairs: J.P. Holdren and E.S. Lander, "Report to the President, Big Data and Privacy: A Technological Perspective," 2014.
- [3] Committee on Responding to Section 5(d) of Presidential Policy Directive 28, "Bulk Collection of Signals Intelligence: Technical Options," National Research Council of the National Academies, 2015.
- [4] S. Payne, "Developing Security Education and Awareness Programs," *Educause Quarterly*, Nov. 2003.
- [5] J. Nakamura, M. Csikszentmihalyi, "The concept of flow," in *Handbook of Positive Psychology*, 2002.
- [6] S. Baron, "Cognitive Flow: The Psychology of Great Game Design," *Gamasutra*. [Online]. Available: http://www.gamasutra.com/view/feature/166972/cognitive_flow_the_psychology_of_.php. [Accessed: 18-May-2015].
- [7] A. Shostack, "Elevation of Privilege: Drawing Developers into Threat Modeling," presented at the *Summit on Gaming, Games, and Gamification in Security Education*, San Diego, CA, 2014.
- [8] T. Denning and T. Kohno, "Practical Lessons From Creating the Control-Alt-Hack Card Game and Research Challenges for Games In Education and Research," presented at the *Summit on Gaming, Games, and Gamification in Security Education*, San Diego, CA, 2014.
- [9] M. Gondree and Z. N. Peterson, "Valuing Security by Getting [d0x3d!]," presented at the *Workshop on Cyber Security Experimentation and Test*, Washington, DC, 2013.
- [10] N. Chachra, D. M. S. Savage, and G. M. Voelker, "Empirically Characterizing Domain Abuse and the Revenue Impact of Blacklisting," presented at the *Workshop on the Economics of Information Security*, Pennsylvania State University, 2014.
- [11] M. H. R. Khouzani, V. Pham, and C. Cid, "Incentive Engineering for Outsourced Computation in the Face of Collusion," presented at the *Workshop on the Economics of Information Security*, Pennsylvania State University.
- [12] Y. Pu and J. Grossklags, "An economic model and simulation results of app adoption decisions on networks with interdependent privacy consequences," in *Decision and Game Theory for Security*, Springer, 2014, pp. 246–265.
- [13] U. Fischbacher and F. Föllmi-Heusi, "Lies in Disguise - An experimental study on cheating," *Journal of the European Economic Association*, vol. 11, no. 3, 2013.
- [14] S. Hurkens and N. Kartik, "Would I Lie to You? On Social Preferences and Lying Aversion," *Experimental Economics*, vol. 12, no. 2, 2009.
- [15] A. Vrij, P. A. Granhag, S. Mann, and S. Leal, "Outsmarting the Liars: Toward a Cognitive Lie Detection Approach," *Current Directions in Psychological Science*, vol. 20, no. 1, pp. 28–32, Feb. 2011.
- [16] *Cyber War and Cyber Terrorism*, ed. A. Colarik and L. Janczewski, Hershey, PA: The Idea Group, 2007.
- [17] J. Pawlick and Q. Zhu, "Deception by Design: Evidence-Based Signaling Games for Network Defense," to be presented at the *Workshop on the Economics of Information Security*, Delft University of Technology, the Netherlands, 2015.