

Inference of Markovian Properties of Molecular Sequences from NGS Data and Applications to Comparative Genomics

Jie Ren¹, Kai Song², Minghua Deng², Gesine Reinert³, Charles H. Cannon^{4,5} and Fengzhu Sun^{*1,6}

¹Molecular and Computational Biology Program, University of Southern California, Los Angeles, California, USA;

²School of Mathematical Sciences, Peking University, Beijing, China;

³Department of Statistics, University of Oxford, 1 South Parks Road, Oxford OX1 3TG, UK;

⁴Department of Biological Sciences, Texas Tech University, TX 79409-3131, USA;

⁵Xishuangbanna Tropical Botanic Garden, Chinese Academy of Sciences, Yunnan, China;

⁶Centre for Computational Systems Biology, School of Mathematical Sciences, Fudan University, Shanghai, China.

Abstract

Next Generation Sequencing (NGS) technologies generate large amounts of short read data for many different organisms. The fact that NGS reads are generally short makes it challenging to assemble the reads and reconstruct the original genome sequence. For clustering genomes using such NGS data, word-count based alignment-free sequence comparison is a promising approach, but for this approach, the underlying expected word counts are essential.

A plausible model for this underlying distribution of word counts is given through modelling the DNA sequence as a Markov chain (MC). For single long sequences, efficient statistics are available to estimate the order of MCs and the transition probability matrix for the sequences. As NGS data do not provide a single long sequence, inference methods on Markovian properties of sequences based on single long sequences cannot be directly used for NGS short read data.

Here we derive a normal approximation for such word counts. We also show that the traditional Chi-square statistic has an approximate gamma distribution, using the Lander-Waterman model for physical mapping. We propose several methods to estimate the order of the MC based on NGS reads and evaluate them using simulations. We illustrate the applications of our results by clustering genomic sequences of several vertebrate and tree species based on NGS reads using alignment-free sequence dissimilarity measures. We find that the estimated order of the MC has a considerable effect on the clustering results, and that the clustering results that use a MC of the estimated order give a plausible clustering of the species.

Our implementation of the statistics developed here is available as R package “NGS.MC” at <http://www-rcf.usc.edu/~fsun/Programs/NGS-MC/NGS-MC.html>.

Keywords: NGS; Alignment-free; Markov chain; Lander-Waterman model

1 Introduction

NGS technologies generate large amounts of overlapping short read data for many different organisms; for example a read is a subsequence of less than 400 bps for Illumina and 700 bps for 454 sequencing technologies, and can sometimes be much shorter. The fact that NGS reads are generally short makes it challenging to reconstruct the original genome sequence.

*to whom correspondence should be addressed; fsun@usc.edu

Recently several word-count based alignment-free sequence comparison methods have been applied to infer the relationship among different species (Song et al., 2013; Yi and Jin, 2013) and metagenomic samples (Behnam and Smith, 2014; Hurwitz et al., 2014; Jiang et al., 2012; Wang et al., 2014) based on NGS reads without assembly. Our alignment-free sequence dissimilarity measures, d_2^* and d_2^S (Song et al., 2014, 2013), and their variants (Behnam et al., 2013; Liu et al., 2011; Ren et al., 2013) have shown promise. These methods require the knowledge about the approximate distribution of word counts in the underlying sequences. While a model which assumes that all letters in the sequence are equally likely is relatively straightforward to analyse, see Reinert et al. (2009), a Markov model for the underlying sequences is more realistic.

Markov chains (MC) have been widely used to model molecular sequences (Almagor, 1983) with many applications including the study of dependencies between the bases (Blaisdell, 1985), the enrichment and depletion of certain word patterns (Pevzner et al., 1989), prediction of occurrences of long word patterns from short patterns (Arnold et al., 1988; Hong, 1990), and the detection of signals in introns (Avery, 1987). Narlikar et al. (2013) studied the effect of the order of MCs on several biological problems including phylogenetic analysis, assignment of sequence fragments to different genomes in metagenomic studies, motif discovery, and functional classification of promoters. These applications showed the importance of accurate specification of the order of MCs. Reliable estimators for the order of the MC and the transition probability matrix based on the sequence data are crucial.

Based on relatively long molecular sequences, for a general finite state MC sequence of letters from a finite alphabet $\mathcal{A} = \{1, 2, \dots, L\}$ of size L , Hoel (1954) showed, under the hypothesis that the long sequence follows a $(k - 2)$ -th order MC, that twice the log-likelihood ratio of the probability of the sequence under a $(k - 1)$ -th order MC versus that under the $(k - 2)$ -th order MC model follows approximately a χ^2 -distribution with $df_k = (L - 1)^2 L^{k-2}$ degrees of freedom under general conditions. He also approximated the log-likelihood ratio by the Pearson-type statistic

$$S_k = \sum_{\mathbf{w} \in \mathcal{A}^k} \frac{(N_{\mathbf{w}} - E_{\mathbf{w}})^2}{E_{\mathbf{w}}}, \quad (1)$$

which is also approximately χ^2 -distributed with the same degrees of freedom. Here, $\mathbf{w} = w_1 w_2 \dots w_k$ denotes a k -word formed of letters $w_i \in \mathcal{A}$, ${}^- \mathbf{w} = w_2 \dots w_k$, $\mathbf{w}^- = w_1 w_2 \dots w_{k-1}$, and ${}^- \mathbf{w}^- = w_2 \dots w_{k-1}$; $N_{\mathbf{w}}$ denotes the count of the word \mathbf{w} in the sequence, and $E_{\mathbf{w}} = \frac{N_{{}^- \mathbf{w}} N_{\mathbf{w}^-}}{N_{{}^- \mathbf{w}^-}}$ is the estimated expected count of \mathbf{w} if the sequence is generated by a MC of order $k - 2$. Here $k \geq 3$; see also Avery and Henderson (1999) for a detailed study, Billingsley (1961a,b) for an excellent exposition of statistical issues related to MCs, as well as Ewens and Grant (2005); Reinert et al. (2000, 2005); Waterman (1995) for applications to sequence analysis.

The Chi-square statistic (1) and the log-likelihood ratio statistics can be used to test the order of a MC, using all k -words $\mathbf{w} \in \mathcal{A}^k$. When a particular order of MC is rejected, we can identify particular word patterns that are exceptional, through the approximate distribution of $N_{\mathbf{w}}$. The approximate distributions of $N_{\mathbf{w}}$ in long sequences is well understood, see for example Reinert et al. (2000, 2005); Waterman (1995). In particular, suppose that the sequence follows a stationary $(k - 2)$ -th order MC and let

$$\hat{\sigma}_{\mathbf{w}}^2 = E_{\mathbf{w}} \left(1 - \frac{N_{{}^- \mathbf{w}}}{N_{{}^- \mathbf{w}^-}} \right) \left(1 - \frac{N_{\mathbf{w}^-}}{N_{{}^- \mathbf{w}^-}} \right).$$

For

$$Z_{\mathbf{w}} = \frac{N_{\mathbf{w}} - E_{\mathbf{w}}}{\hat{\sigma}_{\mathbf{w}}}, \quad (2)$$

Theorem 6.4.2 in Reinert et al. (2005) gives that, as sequence length goes to infinity, for all real values x , $\mathbb{P}(Z_{\mathbf{w}} \leq x) \rightarrow \Phi(x)$, where Φ denotes the cumulative distribution function of a standard normal

variable. We also say that Z_w converges to the standard normal distribution $N(0, 1)$ *in distribution*. This asymptotic result can then be used to find exceptional words in long sequences.

Given an NGS short read sample, it is tempting to use the test statistic S_k defined in (1) to test the order of a MC by simply counting the number of the occurrences of words in short read data. However, as the short reads from NGS data are sampled randomly from the genome, some parts of the genome are possibly not sampled and some parts are possibly sampled extensively. The sampling process introduces additional randomness to the statistic, and makes S_k deviate from its traditional χ^2 -distribution. Similarly, the approximate distribution of Z_w given in (2) will be different from the standard normal distribution.

In this paper, we study these approximate distributions, both theoretically and by simulations. First we extend the statistics S_k and Z_w for a MC sequence to S_k^R and Z_w^R for the NGS read data. Our underlying model for the distribution of reads along the genome is the potentially inhomogeneous Lander-Waterman model for physical mapping (Lander and Waterman, 1988). We discover that for a set of short reads sampled from a $(k - 2)$ -th order MC sequence, the statistic S_k^R follows approximately a gamma distribution with shape parameter $df_k/2$ and scale parameter $2d$, where d is a factor related to the distribution of the reads along the genome. We also show that, with the same factor d , the distribution of the single word statistic Z_w^R/\sqrt{d} tends to the standard normal distribution. Based on the theoretical results, we introduce an estimator for the order of the MC using NGS data. For practical purposes, we also give an estimator for the factor d when the underlying reads sampling distribution is unknown. To the best of our knowledge, this is the first study of the Markovian properties of molecular sequences based on NGS read data.

To illustrate our theoretical results and our estimators, we first carry out a simulation study based on transition probability matrices which are estimated from cis-regulatory module (CRM) DNA sequences, and insert repeats. We simulate different read lengths, numbers of reads, inhomogeneous sampling, as well as sequencing errors, and we include a regime where the sampling rate depends on the GC content. If the GC bias is not very strong or the sequencing depth is not very low, then the simulation results agree with our theoretical predictions despite the theoretical assumptions being slightly violated.

Next we apply our methods to cluster 28 vertebrate species using our alignment-free dissimilarity measures d_2^* and d_2^S under different MC models which are estimated from NGS read samples. The estimated orders based on NGS data without assembly are found to be consistent with those inferred directly from the long genome sequences. The clustering performs best when using MCs around the estimated order. Applying the same analysis to 13 tropical tree species whose genomes are unknown, based on their NGS read samples, the most plausible clustering is achieved when using a MC model of order close to the one estimated from the NGS reads.

The paper is organized as follows. The ‘‘Methods’’ section contains the probabilistic models of generating the MC sequence and sampling the short reads, as well as the theorem for the approximate distributions of S_k^R and Z_w^R for NGS data. This theorem is used to derive our estimators for the order of the MC and for the factor d . In the ‘‘Results’’ section, we first provide extensive simulation studies including the comparison of the theoretical approximate distributions and the simulated results for S_k^R and Z_w^R , the effect of inhomogeneous sampling and sequencing errors, the efficiency of the estimator of the factor d , and the evaluations of the methods for estimating the MC order. Second, we estimate the orders of the MCs for 28 vertebrate species based on the simulated whole genome NGS samples. We then use our dissimilarity measures d_2^* and d_2^S to cluster the NGS samples of the 28 species under different MC orders to see the effect on the performance of the clustering. The applications show that our new methods are effective for the inference of relationships among sequences based on NGS reads. Finally, we use our methods to study the relationships among 13 tree species whose complete genomic sequences as well as their phylogenetic relationships are unknown. Our clustering results are consistent with the physical characteristics of the tree species. The paper concludes with some discussion of the

study.

2 Methods

2.1 Probabilistic modeling of a MC sequence and random sampling of the reads using NGS

In NGS, a large number of reads are randomly sampled from the genome. Hence two random processes are involved in the generation of the short read data: the generation of the underlying genome sequence and the random sampling of the reads.

We use an r -th order homogeneous ergodic MC to model the underlying genome sequence with each letter taking values in a finite alphabet set \mathcal{A} of size L . Since our study is based on genomic sequences, $L = 4$. As in Daley and Smith (2013); Lander and Waterman (1988); Simpson (2014); Zhai et al. (2012); Zhang et al. (2008), we assume that the genome is continuous and that the distribution of reads along the genome follows a potentially *inhomogeneous* Poisson process with rate $c(x)$ at position x . If $c(x) = c$ for all x , we refer to the sampling of the reads as *homogeneous*. We assume that all sampled reads have the same length of β bps. A total of M reads are independently sampled from the genome of length G bps.

We extend the statistics S_k and $Z_{\mathbf{w}}$ in (1) and (2) to NGS short read data accordingly. Let $N_{\mathbf{w}}^R$ be the number of occurrences of the k -word \mathbf{w} in the short read data, where the superscript R refers to the “read” data, and define

$$S_k^R = \sum_{\mathbf{w} \in \mathcal{A}^k} \frac{(N_{\mathbf{w}}^R - E_{\mathbf{w}}^R)^2}{E_{\mathbf{w}}^R}, \quad (3)$$

$$Z_{\mathbf{w}}^R = \frac{N_{\mathbf{w}}^R - E_{\mathbf{w}}^R}{\hat{\sigma}_{\mathbf{w}}^R}, \quad (4)$$

where

$$E_{\mathbf{w}}^R = \frac{N_{\mathbf{w}}^R N_{\mathbf{w}^-}^R}{N_{\mathbf{w}^-}^R} \text{ and } (\hat{\sigma}_{\mathbf{w}}^R)^2 = E_{\mathbf{w}}^R \left(1 - \frac{N_{\mathbf{w}}^R}{N_{\mathbf{w}^-}^R} \right) \left(1 - \frac{N_{\mathbf{w}^-}^R}{N_{\mathbf{w}^-}^R} \right).$$

We have the following theorem on the approximate distributions of S_k^R and $Z_{\mathbf{w}}^R$; the proof is given in the Supplementary Materials. Note that for each read we discard the last $k - 1$ positions as they would lead to words of length less than k ; the error made with this approximation is asymptotically negligible when k is small relative to β .

Theorem 1 *Assume that the underlying genome follows a $(k - 2)$ -th order MC which assigns non-zero probability to every k -word \mathbf{w} . Let S_k^R and $Z_{\mathbf{w}}^R$ be defined as in (3) and (4), respectively. Suppose that the genome of length G can be divided into (not necessarily contiguous) regions with constant coverage r_i for the i -th region, so that every base is covered exactly r_i times, based on the first $\beta - k + 1$ positions of the reads. Let G_i be the length of the i -th region that changes with G in a way such that $\lim_{G \rightarrow \infty} G_i/G = f_i > 0$ for the i -th region, $i = 1, 2, \dots$. Let*

$$d = \frac{\sum_i r_i^2 f_i}{\sum_i r_i f_i}. \quad (5)$$

Then, as $G \rightarrow \infty$,

- a) For each k -word \mathbf{w} , in distribution, $Z_{\mathbf{w}}^R/\sqrt{d} \rightarrow N(0, 1)$.

- b) The statistic S_k^R/d has an approximate χ^2 -distribution with $df_k = (L-1)^2 L^{k-2}$ degrees of freedom; equivalently, the statistic S_k^R has an approximate gamma distribution with shape parameter $df_k/2$ and scale parameter $2d$.

If the M reads are sampled homogeneously along the genome with coverage c based on the first $\beta - k + 1$ positions of the reads along the genome, i.e. $c = \frac{M(\beta-k+1)}{G-k+1}$, the Lander-Waterman formula (Lander and Waterman, 1988) shows that the fraction of genome covered $r_i = i$ times is $f_i = \exp(-c)c^i/i!$. Under this assumption, we obtain

$$d = \frac{\sum_i i^2 f_i}{\sum_i i f_i} = \frac{c^2 + c}{c} = c + 1.$$

The results in Theorem 1 continue to hold when taking $d = c + 1$.

In the Lander-Waterman model for physical mapping (Lander and Waterman, 1988), the factor $c = \frac{M\beta}{G}$ is the coverage of the genome. Hence we refer to d from (5) as the *effective coverage* of the reads along the genome based on the first $\beta - k + 1$ positions of each read.

2.2 Estimating the order of the MC based on NGS reads

Based on Theorem 1, we can estimate the order r of a MC sequence using NGS reads. First, we test the null hypothesis that the sequence follows an independent identically distributed (i.i.d; MC order = 0) model. For a test at significance level α , if S_2^R/d is higher than the $1 - \alpha$ quantile of the χ^2 -distribution with $df = (L-1)^2$ degrees of freedom, the i.i.d hypothesis is rejected. If this null hypothesis is rejected, then here we propose an estimator for the order of a MC; it is an analog of a corresponding established estimator of MC orders based on long sequences that has been shown to be effective. In the Supplementary Materials we present four related estimators as well as estimators based on the AIC and BIC information criteria; the one presented here has the best performance in simulation studies.

We assume that the word length $k \geq 2$ and that the assumptions of Theorem 1 are satisfied. Then, for $k \geq r + 2$, S_k^R/d has approximately a χ^2 -distribution with $(L-1)^2 L^{k-2}$ degrees of freedom. If $k < r + 2$, then S_k^R/d will typically be larger than expected from this χ^2 -distribution. For $k \geq r + 2$, the law of large numbers gives that $\frac{S_{k+1}^R}{L S_k^R} \rightarrow 1$ for $G \rightarrow \infty$; if $k < r + 2$ then the ratio will be much larger than 1 in the limit. Therefore we can estimate r as follows:

$$\hat{r}_{S_k} = \operatorname{argmin}_k \left\{ \frac{S_{k+1}^R}{S_k^R} \right\} - 1. \quad (6)$$

In general, we want the value of $\min_k \left\{ \frac{S_{k+1}^R}{S_k^R} \right\}$ to be very small, e.g, less than 0.01.

Using the law of large numbers it can be shown that under our assumptions this estimator is consistent, in the sense that \hat{r}_{S_k} tends to r in probability as G tends to infinity.

2.3 Estimating the effective coverage d

Often the effective coverage d is not known and we would like to estimate the effective coverage d using NGS short read data. From Theorem 1, we can see that, under the general conditions stated in the theorem, $(Z_{\mathbf{w}}^R)^2/d$ follows a χ^2 -distribution with one degree of freedom. Since the median of the χ^2 -distribution with one degree of freedom is about 0.456, we can use the scaled median as a robust estimator for d ;

$$\hat{d} = \operatorname{median}\{(Z_{\mathbf{w}}^R)^2, \mathbf{w} \in \mathcal{A}^k\}/0.456. \quad (7)$$

When we assume that the underlying long sequence follows a MC of order at most m , we use $(m + 2)$ -words to estimate d using (7).

Note that for an i.i.d. model sequence, the set of 2-words would not yield meaningful results as there are only 16 different 2-words and the median based on 16 numbers is generally not reliable. As an underlying genome sequence following an r -th order MC can also be seen as an $(r + 1)$ -th, $(r + 2)$ -th, \dots , and higher order MC sequence, we can use k -words with relatively large k ($\geq r + 2$) to estimate the factor d , if the maximum order of a MC is unknown beforehand.

2.4 Simulation study

For the simulation study, we first generate MCs of different orders. For realistic parameter values, the transition probability matrices of the MCs are based on real cis-regulatory module (CRM) DNA sequences in mouse forebrain from Blow et al. (2010). We use CRM sequences here because CRM sequences are often used to study the effectiveness of alignment-free sequence dissimilarity measures (Göke et al., 2012; Ren et al., 2013; Song et al., 2014). To take into consideration that in real genomic sequences, many repeat regions are present, we insert repeats into the generated MCs. We simulate NGS data by sampling a varying number of reads of different lengths from the MC, varying genome length as well as coverage.

We include homogeneous and inhomogeneous sampling of the reads as well as sequencing errors. We also let the sampling rate of the reads depend on the GC content of the fragments based on data from the current sequencing technologies (Benjamini and Speed, 2012). We set the sequencing error rate at 10%, which is relatively high compared to the true sequencing error rate in real sequencing in order to clearly distinguish among the estimators with regards to their robustness to sequencing errors. When a sequencing error occurs at a position, the nucleotide base is changed to one of the other three nucleotides with equal probability.

Once the NGS reads are generated, we calculate the statistics S_k^R and Z_w^R for each word w , the order estimator \hat{r}_{S_k} and the estimator for effective coverage d based on (7); each procedure is repeated 1000 times. In each repeat experiment, we let the order estimator choose the model from 1st, 2nd, \dots , 5th order MCs; we estimate the effective coverage d by (7), using 3-tuples for a first order MC, and 4-tuples for a second order MC. The details are given in the Supplementary Materials.

2.5 Applications to the study of relationships among organisms

We test our methods on real and simulated NGS data from 28 vertebrate species whose complete genomic sequences are available and that are comprehensively studied in (Karolchik et al., 2008; Miller et al., 2007). We download the genomes of the 28 vertebrate species from UCSC Genome Browser, and then use MetaSim (Richter et al., 2008) to simulate reads from each of the 28 vertebrate species. In simulations the accuracy of the order estimation increases with read coverage. To reflect a worst-case scenario, we set the read coverage to be 1 as a lower bound for the performance although the current sequencing technology can generate data with very high read coverage. We set MetaSim to generate reads of length 62bp under the error rate which is estimated by Illumina in our simulations.

To estimate the order of MC based on the NGS sample for each of the 28 species, we apply the order estimator \hat{r}_{S_k} in (12); there is no sharp ratio transition found over $k = 2, \dots, 14$. Given that real genomes consist of multiple types of regions (coding, non-coding and regulatory regions) and each type may fit to different MC models, the result indicates that no suitable MC model can adequately fit all the patterns in the genome. Instead, we fit the data with a MC model that can explain the majority (say 80%) of the word patterns in the genome. Motivated by the normal approximation of a particular word statistic in Theorem 1, we study the fraction of k -words whose occurrences can be explained using the

statistic $(Z_{\mathbf{w}}^R)^2/d$ by comparison to a χ^2 -distribution with one degree of freedom with type I error 0.01. We estimate the order of MC to be the smallest $k - 2$ under which more than 80% of k -words can be explained by the $(k - 2)$ -th order MC.

To cluster the organisms, we use the inferred MC models to estimate the expected number of occurrences of word patterns and then study the relationships among the organisms using our dissimilarity measures d_2^* and d_2^S . We briefly present their definitions below, please see Song et al. (2014, 2013) for details. Then we apply a similar approach to study the relationships among 13 tree species with NGS reads, for which neither the complete genome sequences nor their relationships are known. To estimate the unknown effective coverage d using k -words by (7), we let k to be relatively large and use \hat{d} as the value at which the estimated d stabilizes as k increases.

2.6 Alignment-free sequence comparison dissimilarity measures

Consider two sets of NGS reads from two genomes. We use superscripts (1) and (2) to denote the first and the second read set, respectively. Suppose that $M^{(i)}$ reads of length $\beta^{(i)}$ are in the i -th data set. Since the reads can come from either the forward strand or the reverse strand of the genome in NGS, we supplement the observed reads by their complements and refer to the joint set of the reads and the complements as the read set.

Let $N_{\mathbf{w}}^{(i)}$ be the count of the word \mathbf{w} in the i -th data set. We define $EN_{\mathbf{w}}^{(i)}$ to be the expected number of occurrences of word \mathbf{w} based on either the i.i.d model or a Markov model, $EN_{\mathbf{w}}^{(i)} = M^{(i)}(\beta^{(i)} - k + 1)(p_{\mathbf{w}}^{(i)} + p_{\bar{\mathbf{w}}}^{(i)})$, where $M^{(i)}(\beta^{(i)} - k + 1)$ is the total number of k -word in the i -th sample, $\bar{\mathbf{w}}$ is the complement of word \mathbf{w} , and $p_{\mathbf{w}}^{(i)}$ is the probability of word \mathbf{w} in the i -th genome under a specific model. Then we define D_2^* and D_2^S as follows,

$$D_2^* = \sum_{\mathbf{w} \in \mathcal{A}^k} \frac{\tilde{N}_{\mathbf{w}}^{(1)} \tilde{N}_{\mathbf{w}}^{(2)}}{\sqrt{EN_{\mathbf{w}}^{(1)} EN_{\mathbf{w}}^{(2)}}}, \text{ and } D_2^S = \sum_{\mathbf{w} \in \mathcal{A}^k} \frac{\tilde{N}_{\mathbf{w}}^{(1)} \tilde{N}_{\mathbf{w}}^{(2)}}{\sqrt{(\tilde{N}_{\mathbf{w}}^{(1)})^2 + (\tilde{N}_{\mathbf{w}}^{(2)})^2}},$$

where $\tilde{N}_{\mathbf{w}}^{(i)} = N_{\mathbf{w}}^{(i)} - EN_{\mathbf{w}}^{(i)}$, $i = 1, 2$. Further, the dissimilarity measures d_2^* and d_2^S , ranging from 0 to 1, are defined as,

$$d_2^* = \frac{1}{2} \left(1 - \frac{D_2^*}{\sqrt{\sum_{\mathbf{w} \in \mathcal{A}^k} \frac{(\tilde{N}_{\mathbf{w}}^{(1)})^2}{EN_{\mathbf{w}}^{(1)}}} \sqrt{\sum_{\mathbf{w} \in \mathcal{A}^k} \frac{(\tilde{N}_{\mathbf{w}}^{(2)})^2}{EN_{\mathbf{w}}^{(2)}}}} \right), \text{ and}$$

$$d_2^S = \frac{1}{2} \left(1 - \frac{D_2^S}{\sqrt{\sum_{\mathbf{w} \in \mathcal{A}^k} \frac{(\tilde{N}_{\mathbf{w}}^{(1)})^2}{\sqrt{(\tilde{N}_{\mathbf{w}}^{(1)})^2 + (\tilde{N}_{\mathbf{w}}^{(2)})^2}}} \sqrt{\sum_{\mathbf{w} \in \mathcal{A}^k} \frac{(\tilde{N}_{\mathbf{w}}^{(2)})^2}{\sqrt{(\tilde{N}_{\mathbf{w}}^{(1)})^2 + (\tilde{N}_{\mathbf{w}}^{(2)})^2}}} \right).$$

For comparison, we also use a simplistic dissimilarity measure based on the non-centered correlation of the word frequencies defined as $d_2 = \frac{1}{2} \left(1 - \frac{\sum_{\mathbf{w} \in \mathcal{A}^k} N_{\mathbf{w}}^{(1)} N_{\mathbf{w}}^{(2)}}{\sqrt{\sum_{\mathbf{w} \in \mathcal{A}^k} (N_{\mathbf{w}}^{(1)})^2} \sqrt{\sum_{\mathbf{w} \in \mathcal{A}^k} (N_{\mathbf{w}}^{(2)})^2}} \right)$.

3 Results

3.1 Summary of simulation results

Due to page limitations, we summarize the simulation results here; details are given in the Supplementary Materials. Our extensive simulations show that the simulated mean, standard deviation and distributions of S_k^R and Z_w^R are very close to their corresponding theoretical approximations given by Theorem 1. Both the effective coverage and the MC order can be estimated accurately under the parameter settings of the current sequencing technologies.

3.2 The relationship among 28 vertebrate species

Table S4 shows the estimated orders of MCs for a group of 28 vertebrate species that are studied in (Karolchik et al., 2008; Miller et al., 2007) based on simulated NGS short reads. For each of the 28 species, we compute the fraction of the k -words that have $(Z_w^R)^2/\hat{d}$ within the 99% of a χ^2 -distribution with one degree of freedom, for $k = 8, 9, \dots, 14$. Using 80% as a threshold, we estimate the order of MC for each species to be the smallest $k - 2$ under which the fraction of words that can be explained by the $(k - 2)$ -th order MC is greater than the threshold.

Comparing our results with the results in Narlikar et al. (2013), where the order of MCs for a selection of vertebrate genomes was estimated by AIC and BIC criteria using whole genome sequences, we find that the estimated order based on NGS read data are almost the same as that estimated based on the whole genome sequences in Narlikar et al. (2013). Our proposed methods of estimating the order of MC based on short reads of NGS data achieve the same accuracy as that based on whole genome sequences.

For a given value of k , we compute d_2^* and d_2^S using an r -th order MC, $r = 0$ (i.i.d model), $\dots, (k - 2)$ for each pair of species, yielding a 28×28 pairwise dissimilarity matrix under each MC model. To evaluate the dissimilarity measures, we use the pairwise distance matrix obtained from Figure S1 in Miller et al. (2007) as the gold standard for the dissimilarity between each pair of the 28 species; the matrix is given as Table S5 in the Supplementary Materials. Note that the estimated orders of the 28 species range from 7 to 11, and the average order is 10. To study the performance of the dissimilarity measures under different orders of MC, we choose $k = 14$ such that we can study the results under the MC model with orders up to 12.

Table 1 shows Spearman’s rank correlation coefficient (SPCC) between the standard distance and the dissimilarity estimated by the d_2 -type measures under MC models of various orders; higher SPCC indicates better performance. Both measures, d_2^* and d_2^S , achieve their best results of SPCC=0.92 when using a MC of order 12. Note that using a simplistic dissimilarity measure d_2 only gives SPCC=0.08.

In general both d_2^* and d_2^S obtain higher SPCC with the standard matrix as the order of MC increases, except for d_2^S at order 9. In particular, the measure d_2^* has negative correlation coefficient with the standard distance under the i.i.d model. The SPCC becomes stable when the order of the MC used for the analysis is close to 11, the maximum estimated MC orders over the 28 species. Here d_2^S is less affected by the order of the MC than d_2^* . When the appropriate order of MC is used, d_2^* and d_2^S perform similarly and much better than d_2 .

d_2 -type	order=0	order=5	order=9	order=10	order=11	order=12
d_2^*	-0.21	-0.16	0.85	0.89	0.90	0.92
d_2^S	0.86	0.87	0.85	0.88	0.90	0.92

Table 1: The Spearman’s rank correlation coefficient (SPCC) between the true distance matrix and the dissimilarity matrix by d_2 -type dissimilarity measures under MC models with order 0 (i.i.d), 5, 9, 10, 11 and 12. The length of the k -tuple word is 14.

3.3 The relationship among 13 tropical tree species with unknown reference genomes

We also apply our method to the 13 tree species based on the NGS shotgun read data sets in Cannon et al. (2010). The reference genome sequences for the 13 tree species are unknown. Our objective is to cluster these tree species using d_2^* and d_2^S with MCs for the sequences.

The estimated order of the MC for all the 13 tree species is 8. We use the dissimilarity measures d_2^* and d_2^S under various orders of MC as the background model to cluster the 13 tree species from their NGS reads. We choose $k = 11$ so that we explore the MC with order up to 9. We use the Unweighted Pair Group Method with Arithmetic Mean (UPGMA) to cluster the tree species.

The 13 tree species can be generally classified into two groups: 5 tree species from *Moraceae* and 8 tree species from *Fagaceae*. The two *Moraceae*s, *Ficus altissima* and *Ficus microcarpa*, should cluster together because they are known to be closely related and are both large hemiepiphytic trees while the other three *Moraceae* species are small dioecious shrubs. Within the *Fagaceae* group, the two *Castanopsis* species should cluster together, and the five *Lithocarpus* species should also form a subgroup. *Trigonobalanus doichangensis* (*Fagaceae*) is an ancestral genus that is very divergent from the rest of the family and has undergone considerable sequence evolution. It should not group within the class of *Castanopsis* and *Lithocarpus* in *Fagaceae*.

Figure 1 shows the clustering results of the 13 tree species using d_2^* under MCs of order 0 (i.i.d), 4, 8 and 9. The trees are built based on all the reads. From the results we can see, under the i.i.d model, *Lithocarpus* mixes up with *Castanopsis*; *T. doichangensis* can not be separated from the rest of *Fagaceae*, while under the MC of order greater than 4, *T. doichangensis* is successfully separated from the rest of the *Fagaceae*. Moreover, within the *Moraceae* group, *Ficus fistulas* and *Ficus langkokensis* form a subgroup under the i.i.d model, and they are separated under the MC with order greater than 4. While *F. langkokensis* is the closest *Moraceae* to the *Fagaceae* under 4th order MC, *F. fistulosa* becomes the closest species to the *Fagaceae*s under 8th and 9th order MCs.

In order to see whether the clustering of the tree species can be correctly inferred using only a portion of the shotgun read data, we randomly sample 10% of the total read data for each tree species to cluster them. To study the variation of the clusters due to random sampling of the reads, we repeat the sampling process 30 times and calculate the frequencies of each internal branch of the clustering using all the reads occurring among the 30 clusterings. The number on the branch refers to the frequency of the branch occurring among the 30 clusterings based on random sampled 10% reads. Three branches of the tree under MC of order 9 have frequencies of occurrence less than 30. When using the MC of a very high order, the clustering becomes unstable.

For the clustering results using d_2^S , see Figure S7. Under MC with all four orders, the two *Castanopsis* and the five *Lithocarpus* species are grouped separately, and *F. altissima* (*Moraceae*) and *F. microcarpa* (*Moraceae*) are clustered together. Under the i.i.d model, *T. doichangensis* (*Fagaceae*) is successfully separated from *Lithocarpus*, but it is not the most outside species in the *Fagaceae* group. When the MC order is greater than 4, *T. doichangensis* (*Fagaceae*) gets separated from the rest of the *Fagaceae*s. It can also be seen that when using the i.i.d model, or a MC with order 8 or greater, some of the branches becomes unstable.

In general, the results show that the clustering becomes more accurate as the order of MC increases using both d_2^* and d_2^S . Under the i.i.d model, the clustering based on d_2^* does not correctly separate *Castanopsis* from *Lithocarpus*, while the clustering based on d_2^S groups the two types separately. With higher order MCs, d_2^* successfully separates *Castanopsis* from *Lithocarpus*. The general clustering structure among *Lithocarpus*, *Castanopsis*, *Trigonobalanus* and *Ficus* stays correct when order is greater than 4 for both measures. When using the MC with order higher than the estimated order, the clustering is unstable and indeed the branch for *L. Hancei* (*Fagaceae*) is not supported on the last tree when using only 10% of the data. With a large number of parameters to estimate, 10% of the data does not suffice to

capture the information in the data. The best clustering is achieved under a MC of order 8 and 9.

4 Discussion

Next generation sequencing technologies provide large amount of data in the form of short reads. Assembly of the millions of short reads to recover the long sequence is challenging, because the relative short length of the reads makes it difficult to resolve the repeat regions, not all regions may be covered, and assembly is time consuming. While multiple sequence alignment may be prohibitive, we can use word-count based dissimilarity measures to cluster the underlying species. These measures require an underlying probability model for the sequences; Markov chains are a reasonable model for such sequences. While transition probabilities can be estimated directly from count data, estimating the order of a MC here is not straightforward.

Methods for estimating the order of a MC of a long sequence have been developed since the 1950s, but estimating the order of a MC directly from a set of short reads without assembly has not been studied yet. In this paper, we develop two statistics S_k^R and Z_w^R and show that both S_k^R and Z_w^R have surprisingly simple approximate distributions with only two parameters, one of them depending on the order of the original long MC sequence, and the other one depending on the distribution of the reads along the sequence. Intriguingly, one of these parameters is $d = c + 1$ under homogeneous sampling, where c is the coverage of the reads along the genome based on the first $\beta - k + 1$ positions of each read.

Based on the property of S_k^R and Z_w^R , we develop an estimator for the order of a MC as well as an estimator for the parameter d based on NGS data. Extensive simulation studies are carried out to verify the theorem and evaluate the estimator.

Finally, we apply the estimation methods to two NGS data sets. Since the real genome sequences consist of coding, non-coding and various regulatory regions, single standard MC models do not fit the data well. Moreover, some enriched patterns, such as the motif sequences, are widespread throughout the genomes and violate the simple MC model for the whole genome sequence. Hence studying the fraction of k -words whose occurrences can be explained using the statistic $(Z_w^R)^2/d$ by comparison to a χ_1^2 distribution is a more realistic way to determine the order of the MC for a real genome sequence. The estimated orders are consistent with the orders estimated directly from the full genome sequences using BIC methods.

Our primary motivation for this study is alignment-free genome comparison using NGS data. Further, we cluster the 28 species based on the NGS data using MC models with various orders. The results show that the clustering performs best and gives stable results when using a MC model with order on and above the estimated order. In addition, we apply the same analysis to 13 tropical tree species whose reference genomes are unknown; again the best clustering is achieved under a MC with the order within the estimated range.

When the sequence length is short or the sequencing depth is low, the numbers of occurrences of some k -words become small or even zero. Then the assumption of non-zero variance for all word counts which underlies the gamma approximation for S_k^R no longer holds and the gamma approximation may not work well. In such a situation an exact test for the order of MCs in the spirit of Besag and Mondal (2013) could be very helpful. In this paper we have only made a start on the Markov chain modelling of NGS data. An exhaustive study of errors in the data, in the form of power studies, could help to further understand the application range of our results. Finally, in this work we take the estimation of the transition probabilities for granted, once the order of the MC is determined. While the estimation of the transition probabilities of the MC model of a long sequence has been studied by Anderson and Goodman (1957) and Baum and Petrie (1966), it would be interesting to extend these methods to NGS data.

Acknowledgments

The authors would like to thank anonymous referees for helpful comments on this work and on previous related work. We thank Dr. Xiaohui Xie from UCI for explanation of the 28 vertebrate species. The research is supported by National Natural Science Foundation of China (No.10871009, 10721403), and National Key Basic Research Project of China (No.2009CB918503). FS is partially supported by US NIH P50 HG 002790 and NSF DMS-1043075 and OCE 1136818. GDR is partially supported by EPSRC EP/K032402/1.

Conflict of Interest: : None declared.

References

- Almagor, H. (1983). A Markov analysis of DNA sequences. *Journal of Theoretical Biology* 104(4), 633–645.
- Anderson, T. W. and L. A. Goodman (1957). Statistical inference about Markov chains. *The Annals of Mathematical Statistics* 28(4), 89–110.
- Arnold, J., A. J. Cuticchia, D. A. Newsome, W. W. Jennings, and R. Ivarie (1988). Mono-through hexanucleotide composition of the sense strand of yeast DNA: a Markov chain analysis. *Nucleic Acids Research* 16(14), 7145–7158.
- Avery, P. J. (1987). The analysis of intron data and their use in the detection of short signals. *Journal of Molecular Evolution* 26(4), 335–340.
- Avery, P. J. and D. A. Henderson (1999). Fitting Markov chain models to discrete state series such as DNA sequences. *Journal of the Royal Statistical Society: Series C (Applied Statistics)* 48(1), 53–61.
- Baum, L. E. and T. Petrie (1966). Statistical inference for probabilistic functions of finite state Markov chains. *The Annals of Mathematical Statistics* 37(6), 1554–1563.
- Behnam, E. and A. D. Smith (2014). The amordad database engine for metagenomics. *Bioinformatics* 30(20), 2949–2955.
- Behnam, E., M. S. Waterman, and A. D. Smith (2013). A geometric interpretation for local alignment-free sequence comparison. *Journal of Computational Biology* 20(7), 471–485.
- Benjamini, Y. and T. Speed (2012). Summarizing and correcting the gc content bias in high-throughput sequencing. *Nucleic Acids Research* 40(10), e72.
- Besag, J. and D. Mondal (2013). Exact goodness-of-fit tests for Markov chains. *Biometrics* 69(2), 488–496.
- Billingsley, P. (1961a). *Statistical Inference for Markov Processes*, Volume 2. University of Chicago Press Chicago.
- Billingsley, P. (1961b). Statistical methods in Markov chains. *The Annals of Mathematical Statistics* 32(1), 12–40.
- Blaisdell, B. E. (1985). Markov chain analysis finds a significant influence of neighboring bases on the occurrence of a base in eucaryotic nuclear DNA sequences both protein-coding and noncoding. *Journal of Molecular Evolution* 21(3), 278–288.

- Blow, M. J., D. J. McCulley, Z. Li, T. Zhang, J. A. Akiyama, A. Holt, I. Plajzer-Frick, M. Shoukry, C. Wright, F. Chen, et al. (2010). Chip-seq identification of weakly conserved heart enhancers. *Nature Genetics* 42(9), 806–810.
- Cannon, C. H., C. S. Kua, D. Zhang, and J. Harting (2010). Assembly free comparative genomics of short-read sequence data discovers the needles in the haystack. *Molecular Ecology* 19(Suppl. 1), 146–160.
- Daley, T. and A. D. Smith (2013). Predicting the molecular complexity of sequencing libraries. *Nature Methods* 10(4), 325–327.
- Ewens, W. J. and G. R. Grant (2005). *Statistical methods in bioinformatics: an introduction*. Springer.
- Glenn, T. C. (2011). Field guide to next-generation DNA sequencers. *Molecular Ecology Resources* 11(5), 759–769.
- Göke, J., M. H. Schulz, J. Lasserre, and M. Vingron (2012). Estimation of pairwise sequence similarity of mammalian enhancers with word neighbourhood counts. *Bioinformatics* 28(5), 656–663.
- Hoel, P. G. (1954). A test for Markov chains. *Biometrika* 41(3/4), 430–433.
- Hong, J. (1990). Prediction of oligonucleotide frequencies based upon dinucleotide frequencies obtained from the nearest neighbor analysis. *Nucleic Acids Research* 18(6), 1625–1628.
- Hurvich, C. M. and C. L. Tsai (1989). Regression and time series model selection in small samples. *Biometrika* 76(2), 297–307.
- Hurwitz, B. L., A. H. Westveld, J. R. Brum, and M. B. Sullivan (2014). Modeling ecological drivers in marine viral communities using comparative metagenomics and network analyses. *Proceedings of the National Academy of Sciences* 111(29), 10714–10719.
- Jiang, B., K. Song, J. Ren, M. Deng, F. Sun, and X. Zhang (2012). Comparison of metagenomic samples using sequence signatures. *BMC Genomics* 13(1), 730.
- Karolchik, D., R. M. Kuhn, R. Baertsch, G. P. Barber, H. Clawson, M. Diekhans, B. Giardine, R. A. Harte, A. S. Hinrichs, F. Hsu, et al. (2008). The UCSC genome browser database: 2008 update. *Nucleic Acids Research* 36(suppl 1), D773–D779.
- Katz, R. W. (1981). On some criteria for estimating the order of a Markov chain. *Technometrics* 23(3), 243–249.
- Lander, E. S. and M. S. Waterman (1988). Genomic mapping by fingerprinting random clones: a mathematical analysis. *Genomics* 2(3), 231–239.
- Liu, X., L. Wan, J. Li, G. Reinert, M. Waterman, and F. Sun (2011). New powerful statistics for alignment-free sequence comparison under a pattern transfer model. *Journal of Theoretical Biology* 284(1), 106–116.
- Miller, W., K. Rosenbloom, R. Hardison, M. Hou, J. Taylor, B. Raney, R. Burhans, D. King, R. Baertsch, D. Blankenberg, et al. (2007). 28-way vertebrate alignment and conservation track in the UCSC genome browser. *Genome Research* 17(12), 1797–1808.
- Morvai, G. and B. Weiss (2005). Order estimation of Markov chains. *Information Theory, IEEE Transactions on* 51(4), 1496–1497.

- Narlikar, L., N. Mehta, S. Galande, and M. Arjunwadkar (2013). One size does not fit all: On how markov model order dictates performance of genomic sequence analyses. *Nucleic Acids Research* 41(3), 1416–1424.
- Peres, Y. and P. Shields (2005). Two new Markov order estimators. *arXiv preprint math/0506080*.
- Pevzner, P. A., M. Y. Borodovsky, and A. A. Mironov (1989). Linguistics of nucleotide sequences i: the significance of deviations from mean statistical characteristics and prediction of the frequencies of occurrence of words. *Journal of Biomolecular Structure and Dynamics* 6(5), 1013–1026.
- Reinert, G., D. Chew, F. Z. Sun, and M. S. Waterman (2009). Alignment-free sequence comparison (I): Statistics and power. *Journal of Computational Biology* 16(12), 1615–1634.
- Reinert, G., S. Schbath, and M. Waterman (2000). Probabilistic and statistical properties of words: an overview. *Journal of Computational Biology* 7(1-2), 1–46.
- Reinert, G., S. Schbath, and M. S. Waterman (2005). Statistics on words with applications to biological sequences. *Lothaire: Applied Combinatorics on Words, J. Berstel and D. Perrin, eds.* 105, 251–328.
- Ren, J., K. Song, F. Sun, M. Deng, and G. Reinert (2013). Multiple alignment-free sequence comparison. *Bioinformatics* 29(21), 2690–2698.
- Richter, D., F. Ott, A. Auch, R. Schmid, and D. Huson (2008). MetaSim: a sequencing simulator for genomics and metagenomics. *PLoS One* 3(10), e3373.
- Simpson, J. T. (2014). Exploring genome characteristics and sequence quality without a reference. *Bioinformatics* 30(9), 1228–1235.
- Song, K., J. Ren, G. Reinert, M. Deng, M. S. Waterman, and F. Sun (2014). New developments of alignment-free sequence comparison: measures, statistics and next-generation sequencing. *Briefings in Bioinformatics* 15(3), 343–353.
- Song, K., J. Ren, Z. Zhai, X. Liu, M. Deng, and F. Sun (2013). Alignment-free sequence comparison based on next-generation sequencing reads. *Journal of Computational Biology* 20(2), 64–79.
- Streltsov, C. C., J. P. Crutchfield, and A. W. Hübler (2007). Inferring markov chains: Bayesian estimation, model comparison, entropy rate, and out-of-class modeling. *Physical Review E* 76(1), 011106.
- Tong, H. (1975). Determination of the order of a Markov chain by Akaike's information criterion. *Journal of Applied Probability* 12, 488–497.
- Wang, Y., L. Liu, L. Chen, T. Chen, and F. Sun (2014). Comparison of metatranscriptomic samples based on k-tuple frequencies. *PloS One* 9(1), e84348.
- Waterman, M. S. (1995). *Introduction to Computational Biology: Maps, Sequences and Genomes*. Chapman & Hall/CRC Interdisciplinary Statistics. Taylor & Francis.
- Yi, H. and L. Jin (2013). Co-phylog: an assembly-free phylogenomic approach for closely related organisms. *Nucleic Acids Research* 41(7), e75.
- Zhai, Z., G. Reinert, K. Song, M. S. Waterman, Y. Luan, and F. Sun (2012). Normal and compound poisson approximations for pattern occurrences in ngs reads. *Journal of Computational Biology* 19(6), 839–854.

Zhang, Z. D., J. Rozowsky, M. Snyder, J. Chang, and M. Gerstein (2008). Modeling chip sequencing in silico with applications. *PLoS Computational Biology* 4(8), e1000158.

Zhao, L. C., C. C. Y. Dorea, and C. R. Gonçalves (2001). On determination of the order of a Markov chain. *Statistical Inference for Stochastic Processes* 4(3), 273–282.

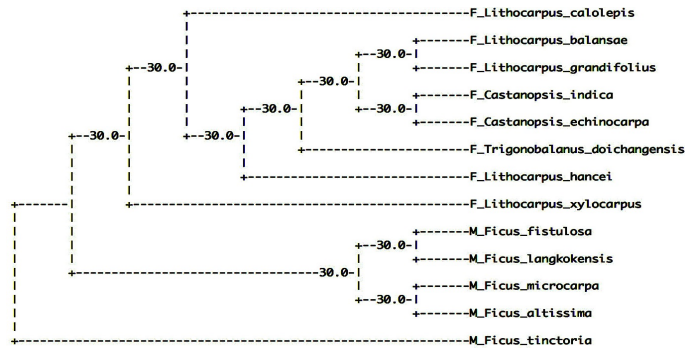

(a) k11, order0, d_2^*

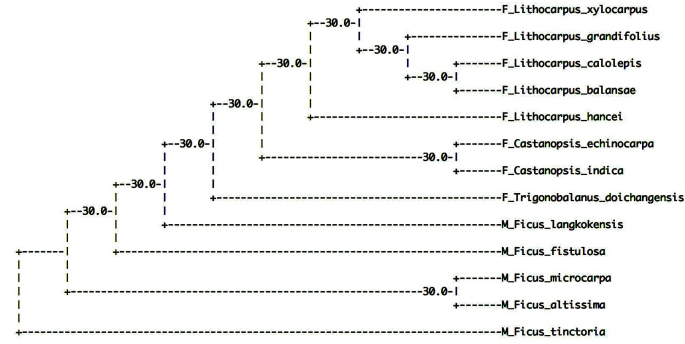

(b) k11, order4, d_2^*

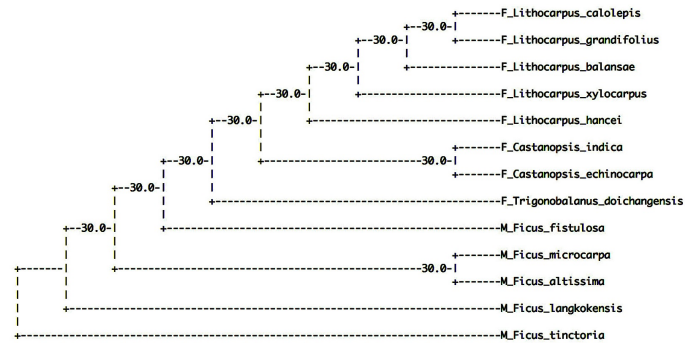

(c) k11, order8, d_2^*

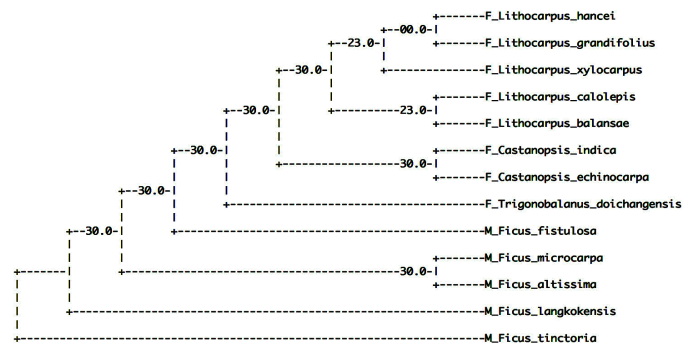

(d) k11, order9, d_2^*

Figure 1: The clustering of the 13 tropical tree species using d_2^* under MC with order 0 (i.i.d), 4, 8 and 9. The number on the branch refers to the frequency of the branch occurring among the 30 clusterings based on random sampled 10% reads. The letter 'F' at the beginning of the names represents *Fagaceae*; similarly the letter 'M' represents *Maraceae*.

Supplementary Materials

A Proof of Theorem 1

Here we assume that the conditions of Theorem 1 prevail. In order to prove Theorem 1, we introduce some notations. Let $N_{\mathbf{w}}(i)$ denote the number of occurrences of \mathbf{w} in the i -th region, $i = 1, 2, \dots$; $E_{\mathbf{w}}(i) = \frac{N_{-\mathbf{w}}(i)N_{\mathbf{w}^-}(i)}{N_{-\mathbf{w}^-}(i)}$ be the estimated expected number of occurrences of \mathbf{w} in the i -th region under the $(k-2)$ -th order MC model; and $P_{\mathbf{w}}$ be the probability of \mathbf{w} assuming that the MC starts from the stationary distribution. Similarly, let $N_{\mathbf{w}}^R$, $E_{\mathbf{w}}^R$, and $\hat{\sigma}_{\mathbf{w}}^2$ be the observed, expected, and variance of the number of occurrences of \mathbf{w} along the long genome sequence. The same notations with superscript ‘‘R’’ indicate the corresponding quantities based on the short read data. We assume that k is small compared to β , and hence the edge effects are small. Then we have the following lemma.

Lemma 1 a) For any k -word \mathbf{w} , for any region $i = 1, \dots, B$, in distribution,

$$\lim_{G \rightarrow \infty} \frac{N_{\mathbf{w}}^R(i) - E_{\mathbf{w}}^R(i)}{\hat{\sigma}_{\mathbf{w}}^R} = N \left(0, \frac{r_i^2 f_i}{\sum_j r_j f_j} \right). \quad (8)$$

b) For any k -word \mathbf{w} , in probability,

$$\lim_{G \rightarrow \infty} \frac{E_{\mathbf{w}}^R - \sum_i E_{\mathbf{w}}^R(i)}{\sqrt{E_{\mathbf{w}}^R}} = 0. \quad (9)$$

Proof of Lemma 1. To prove part a), note that under the null model that the MC is $(k-2)$ -th order, Theorem 6.4.2 in Reinert et al. (2005) gives that, as sequence length goes to infinity, in distribution,

$$\frac{N_{\mathbf{w}}(i) - E_{\mathbf{w}}(i)}{\hat{\sigma}_{\mathbf{w}}(i)} \rightarrow N(0, 1).$$

Here we use that the Markov chain assigns non-zero probability to every k -word \mathbf{w} and hence the variance $\sigma_{\mathbf{w}}$ would be non-zero. As $N_{\mathbf{w}}^R(j) = r_j N_{\mathbf{w}}(j)$ the corresponding result for $N_{\mathbf{w}}^R(j)$ follows; it remains to identify the asymptotic variance. We have for any region i

$$\lim_{G \rightarrow \infty} \frac{N_{\mathbf{w}}(i)}{G_i} = P_{\mathbf{w}}, \quad (10)$$

which does not depend on i as the MC is ergodic, and then we have approximately,

$$E_{\mathbf{w}}(i) = G_i \frac{P_{-\mathbf{w}} P_{\mathbf{w}^-}}{P_{-\mathbf{w}^-}} \text{ and}$$

$$E_{\mathbf{w}}^R = \sum_i r_i E_{\mathbf{w}}(i) = \sum_i r_i G_i \frac{P_{-\mathbf{w}} P_{\mathbf{w}^-}}{P_{-\mathbf{w}^-}}, \quad i = 1, 2, \dots,$$

Thus

$$\lim_{G \rightarrow \infty} \frac{E_{\mathbf{w}}^R(i)}{E_{\mathbf{w}}^R} = \frac{r_i f_i}{\sum_j r_j f_j};$$

$$\lim_{G \rightarrow \infty} \frac{1 - N_{-\mathbf{w}}^R(i)/N_{-\mathbf{w}^-}^R(i)}{1 - N_{-\mathbf{w}}^R/N_{-\mathbf{w}^-}^R} = 1;$$

$$\lim_{G \rightarrow \infty} \frac{1 - N_{\mathbf{w}^-}^R(i)/N_{-\mathbf{w}^-}^R(i)}{1 - N_{\mathbf{w}^-}^R/N_{-\mathbf{w}^-}^R} = 1.$$

From the above three equations, we have

$$\lim_{G \rightarrow \infty} \frac{\hat{\sigma}_{\mathbf{w}}^R(i)}{\hat{\sigma}_{\mathbf{w}}^R} = \sqrt{\frac{r_i f_i}{\sum_j r_j f_j}}.$$

Therefore

$$\begin{aligned} \frac{N_{\mathbf{w}}^R(i) - E_{\mathbf{w}}^R(i)}{\hat{\sigma}_{\mathbf{w}}^R} &= \left(\frac{r_i N_{\mathbf{w}}(i) - r_i E_{\mathbf{w}}(i)}{\hat{\sigma}_{\mathbf{w}}^R(i)} \right) \frac{\hat{\sigma}_{\mathbf{w}}^R(i)}{\hat{\sigma}_{\mathbf{w}}^R} \\ &\rightarrow N \left(0, \frac{r_i^2 f_i}{\sum_j r_j f_j} \right). \end{aligned}$$

For Part b) of this lemma, note that

$$0 \leq N_{\mathbf{w}}^R - \sum_{j=1}^B N_{\mathbf{w}}^R(j) \leq 2Mk$$

as the only differences in the counts occur due to not counting occurrences at the boundaries of the regions and there are M reads. As $N_{\mathbf{w}} \sim P_{\mathbf{w}}G$ and as $\lim_{G \rightarrow \infty} \frac{Mk}{\sqrt{G}} \rightarrow 0$, the second assertion follows. \square

From Lemma 1, we can easily show the first assertion in Theorem 1 by noting that

$$Z_{\mathbf{w}}^R = \frac{N_{\mathbf{w}}^R - E_{\mathbf{w}}^R}{\hat{\sigma}_{\mathbf{w}}^R} = \sum_i \frac{N_{\mathbf{w}}^R(i) - E_{\mathbf{w}}^R(i)}{\hat{\sigma}_{\mathbf{w}}^R} + \frac{\sum_i E_{\mathbf{w}}^R(i) - E_{\mathbf{w}}^R}{\hat{\sigma}_{\mathbf{w}}^R}.$$

The last summand tends to 0 by (9). When G_i is large then the i -th term is close to a normal distribution with mean 0 and variance $\frac{r_i^2 f_i}{\sum_i r_i f_i}$. Since the dependence between the segments is weak, we can treat the terms in the first summand as independent. Part a) of Theorem 1 is proved.

Now we prove the part b) of Theorem 1. Suppose there are only two regions with coverage r_i and region length G_i , $i = 1, 2$. With (9), S_k^R has approximately the same distribution as

$$\begin{aligned} S_k^{R,*} &= \sum_{\mathbf{w}} \frac{(N_{\mathbf{w}}^R - E_{\mathbf{w}}^R(1) - E_{\mathbf{w}}^R(2))^2}{E_{\mathbf{w}}^R} \\ &= \sum_{\mathbf{w}} \left(\sum_i \frac{N_{\mathbf{w}}^R(i) - E_{\mathbf{w}}^R(i)}{\sqrt{E_{\mathbf{w}}^R}} \right)^2 \\ &= \sum_{\mathbf{w}} \left(\sum_i \frac{N_{\mathbf{w}}(i) - E_{\mathbf{w}}(i)}{\sqrt{E_{\mathbf{w}}(i)}} \sqrt{\frac{r_i E_{\mathbf{w}}^R(i)}{E_{\mathbf{w}}^R}} \right)^2 \\ &= \sum_{\mathbf{w}} \left(\sum_i W_i \frac{N_{\mathbf{w}}(i) - E_{\mathbf{w}}(i)}{\sqrt{E_{\mathbf{w}}(i)}} \right)^2, \end{aligned}$$

where

$$W_i = \sqrt{\frac{r_i E_{\mathbf{w}}^R(i)}{E_{\mathbf{w}}^R}} \approx \sqrt{\frac{r_i^2 f_i}{\sum_j r_j f_j}}, i = 1, 2.$$

Generally suppose that the reads come from B regions with each region having the same coverage. Let r_i be the coverage and G_i be the genomic length of the i -th region. Using the same idea as above, we can approximate S_k^R by

$$S_k^{R,*} = \sum_{\mathbf{w}} \left(\sum_{i=1}^B W_i \frac{N_{\mathbf{w}}(i) - E_{\mathbf{w}}(i)}{\sqrt{E_{\mathbf{w}}(i)}} \right)^2. \quad (11)$$

Note that from Section 6.6.1 in Reinert et al. (2005), the vector

$$\tilde{\mathbf{N}}(i) := \left(\frac{N_{\mathbf{w}}(i) - E_{\mathbf{w}}(i)}{\sqrt{E_{\mathbf{w}}(i)}} \right)_{\mathbf{w} \in A^k} \rightarrow N(0, \Sigma_{L^k \times L^k}^2),$$

in distribution, where $\Sigma_{L^k \times L^k}^2$ is the covariance matrix with rank df_k . Hence, in distribution,

$$\sum_{\mathbf{w} \in A^k} \left(\frac{N_{\mathbf{w}}(i) - E_{\mathbf{w}}(i)}{\sqrt{E_{\mathbf{w}}(i)}} \right)^2 \rightarrow \chi_{(df_k)}^2,$$

where $\chi_{(df_k)}^2$ is a χ^2 random variable with $df_k = (L-1)^2 L^{k-2}$ degrees of freedom. On the other hand, we can find a $L^k \times df_k$ matrix M such that $\Sigma_{L^k \times L^k}^2 = MM^T$. Let M^{-1} be the pseudo-inverse of M , then we have

$$M^{-1} \tilde{\mathbf{N}}(i) = \begin{pmatrix} Z_1(i) \\ \dots \\ Z_{df_k}(i) \end{pmatrix} = Z(i)$$

such that approximately $Z(i) \sim N(0, I_{df_k})$. As $\tilde{\mathbf{N}}(i) = MZ(i)$ we obtain that

$$\tilde{\mathbf{N}}(i)^T \cdot \tilde{\mathbf{N}}(i) = Z(i)^T M^T M Z(i).$$

Since the left hand side has approximately a χ^2 distribution with df_k degrees of freedom, the right hand side should be in distribution close to $Z(i)^T Z(i)$. Thus approximately, $M^T M = I_{df_k \times df_k}$. Also note that M does not depend on i because the correlation structure of $\tilde{\mathbf{N}}(i)$ is the same across the regions under the null model. Then (11) for $S_k^{R,*}$ can be written as

$$\begin{aligned} S_k^{R,*} &= \left(\sum_{i=1}^B W_i \tilde{\mathbf{N}}(i) \right)^T \left(\sum_{i=1}^B W_i \tilde{\mathbf{N}}(i) \right) \\ &= \left(\sum_{i=1}^B W_i Z(i) \right)^T M^T M \left(\sum_{i=1}^B W_i Z(i) \right) \\ &= \left(\sum_{i=1}^B W_i Z(i) \right)^T \left(\sum_{i=1}^B W_i Z(i) \right) \\ &= \sum_{k=1}^{df_k} \left(\sum_{i=1}^B W_i Z_k(i) \right)^2. \end{aligned}$$

Since $Z_k(i)$ are all approximately i.i.d $N(0, 1)$ random variables and $\sum_{i=1}^B W_i^2 \approx \sum_{i=1}^B \frac{r_i^2 f_i}{\sum_j r_j f_j}$, we obtain that, in distribution,

$$Y_k = \sum_{i=1}^B W_i Z_k(i) \rightarrow N \left(0, \sum_{i=1}^B W_i^2 \right) \text{ and } \frac{Y_k}{\sqrt{\sum_{i=1}^B W_i^2}} \rightarrow N(0, 1).$$

Hence

$$S_k^R = \left(\sum_{i=1}^B W_i^2 \right) \sum_{k=1}^{df_k} \left(\frac{Y_k}{\sqrt{\sum_{i=1}^B W_i^2}} \right)^2 \rightarrow \left(\frac{\sum_{i=1}^B r_i^2 f_i}{\sum_{j=1}^B r_j f_j} \right) \chi^2(df_k). \square$$

B Methods

B.1 Estimating the order of a Markov chain based on Theorem 1

We assume that $k \geq 2$ and that the assumptions of Theorem 1 are satisfied. Moreover we assume for now that d is known; in practice, the effective coverage d is replaced by the estimated value \hat{d} . In addition to our estimator

$$\hat{r}_{S_k} = \operatorname{argmin}_k \left\{ \frac{S_{k+1}^R}{S_k^R} \right\} - 1 \quad (12)$$

we define four related estimators based on Theorem 1; they are all analogs of corresponding established estimators for the order of a Markov chain.

1. Instead of using S_k^R directly, we can calculate the p-value

$$p_k = P \left(S_k^R \geq s_k^R \right) = P \left(S_k^R / d \geq s_k^R / d \right) = P \left(\chi_{df_k}^2 \geq s_k^R / d \right),$$

where s_k^R is the observed value of S_k^R based on the short read data. We expect p_k to be small for $k < r + 2$ while p_k will not be that small for $k \geq r + 2$. Therefore, we expect $\log(p_{k+1}) / \log(p_k)$ to be the smallest when $k = r + 1$. Thus we can also estimate the order of a MC by

$$\hat{r}_{p_k} = \operatorname{argmin}_k \left\{ \frac{\log(p_{k+1})}{\log(p_k)} \right\} - 1. \quad (13)$$

2. For a given significance level α , we check consecutively if $p_{k+1} < \alpha$ and stop when $p_{k+1} \geq \alpha$. We estimate r by

$$\hat{r}_h = \operatorname{argmin}_k \{ p_{k+1} \geq \alpha \} - 1, \text{ for a given significant level } \alpha. \quad (14)$$

To avoid early stopping, we can also require that both p_k and p_{k+1} are larger than α .

3. If $k \geq r + 2$, then $Z_{\mathbf{w}}^R / \sqrt{d}$ is approximately standard normal $N(0, 1)$ and thus $(Z_{\mathbf{w}}^R)^2 / d$ has approximately a χ^2 -distribution with one degree of freedom. If $k < r + 2$, for some k -word \mathbf{w} , $(Z_{\mathbf{w}}^R)^2 / d$ is generally larger than a χ^2 -distributed random variable with one degree of freedom. Therefore we would expect $Z_{\max}^R(k)$ to be large when $k < r + 2$ and $Z_{\max}^R(k)$ to be relatively small for $k \geq r + 2$. As Z_{\max}^R is the maximum value over L^k variables, we should divide $Z_{\max}^R(k)$ by L^k . Therefore, we estimate the order of the MC r by

$$\hat{r}_{Z_k} = \operatorname{argmin}_k \left\{ \frac{Z_{\max}^R(k+1)}{Z_{\max}^R(k)} \right\} - 1, \quad (15)$$

where $Z_{\max}^R(k) = \max_{\mathbf{w}, |\mathbf{w}|=k} |Z_{\mathbf{w}}^R|$.

4. Extending the method by Morvai and Weiss (2005) and Peres and Shields (2005), for a set of short reads and a $(k - 1)$ -word $\mathbf{v} = v_1 \cdots v_{k-1}$, define

$$\Delta^{k-1}(\mathbf{v}) = \max_{a \in \mathcal{A}} \left| N_{\mathbf{v}a}^R - \frac{N_{-\mathbf{v}a}^R N_{\mathbf{v}}^R}{N_{-\mathbf{v}}^R} \right|;$$

then

$$\Delta^k = \max_{\mathbf{v} \in \mathcal{A}^{k-1}} \{\Delta^{k-1}(\mathbf{v})\} = \max_{\mathbf{w} \in \mathcal{A}^k} \left| N_{\mathbf{w}}^R - \frac{N_{\mathbf{w}^-}^R N_{\mathbf{w}^+}^R}{N_{\mathbf{w}^-}^R} \right|$$

is the maximum difference between the number of occurrences of a k -word and its estimated expectation under the $(k-2)$ -th order MC. Our Peres-Shields-type estimator is

$$\hat{r}_{\text{PS}}(x) = \operatorname{argmax}_k \left\{ \frac{\Delta^k}{\Delta^{k+1}} \right\} - 1. \quad (16)$$

B.2 Estimating the order of the MC based on modified AIC and BIC

Several methods based on the Akaike information criterion (AIC) and the Bayesian information criterion (BIC) have been proposed to estimate the order of MC based on long sequences (Hurvich and Tsai, 1989; Katz, 1981; Narlikar et al., 2013; Tong, 1975; Zhao et al., 2001). The AIC and BIC for long sequences are defined by

$$AIC(k) = -2 \log(\text{Sequence-Likelihood}, \mathcal{M}_k) + 2|\mathcal{M}_k|, \quad (17)$$

$$AICc(k) = AIC(k) + \frac{2|\mathcal{M}_k| (|\mathcal{M}_k| + 1)}{(|\mathcal{S}|_k - |\mathcal{M}_k| - 1)}, \text{ and} \quad (18)$$

$$BIC(k) = -2 \log(\text{Sequence-Likelihood}, \mathcal{M}_k) + |\mathcal{M}_k| \log |\mathcal{S}|_k, \quad (19)$$

where \mathcal{M}_k indicates the k -th order Markov chain, $|\mathcal{M}_k|$ is the number of parameters for the k -th order Markov model, i.e. $|\mathcal{M}_k| = (L-1)L^k$, and $|\mathcal{S}|_k$ is the size of the data. For a long sequence of length G , we have that $|\mathcal{S}|_k = G - k$ is the number of $(k+1)$ tuples.

However, no formulas have been defined for AIC and BIC of Markov models based on NGS data. In the following we modify the definitions of AIC and BIC given in (17), (18) and (19) respectively so that they are applicable to NGS data. For a NGS short read sample, we define the log-pseudo-likelihood under the k -th order MC model as,

$$\log({}_p LH_k^R) = \sum_{\mathbf{w} \in L^{k+1}} N_{\mathbf{w}}^R \log \frac{N_{\mathbf{w}}^R}{N_{\mathbf{w}^-}^R},$$

by replacing $N_{\mathbf{w}}$ with $N_{\mathbf{w}}^R$ in the log-likelihood of a long sequence. We think of the factor d as the effective coverage of the reads along the genome. So the pseudo-likelihood of the NGS data under the k -th order of MC model is approximately the likelihood of the effective covered region along the genome to the power of d , i.e. ${}_p LH_k^R \approx (\text{likelihood of the covered genomic region})^d$. Thus, the log-likelihood of the covered genomic region is approximately $\log({}_p LH_k^R)/d$. Based on the idea of AIC for long sequences, we minimize $-2 \log({}_p LH_k^R)/d + 2(L-1)L^k$ with respect to k . Therefore, we propose the AIC for $k=1, 2, \dots$, based on NGS data as

$$AIC^R(k) = -2 \log({}_p LH_k^R) + 2d(L-1)L^k.$$

To define BIC and AICc for NGS data, we also need to find a suitable analog of the data size $|\mathcal{S}|_k$ in (18) and (19). A naive substitute is the total effective read length $M(\beta - k)$, or in other words, the number of $(k+1)$ -tuples used to estimate the likelihood under the k -th order MC model. However, the reads can overlap and adjustments are needed. Using the effective coverage factor d as a normalization factor from the NGS to long sequence, the length of the effective covered genomic region is $\frac{M(\beta-k)}{d}$.

Then we define AICc and BIC for the NGS read data as

$$AICc^R(k) = AIC^R(k) + \frac{2(L-1)L^k((L-1)L^k + 1)}{\left(\frac{M * (\beta - k)}{d} - (L-1)L^k - 1\right)}, \text{ and}$$

$$BIC^R(k) = -2 \log({}_pLH_k^R) + d(L-1)L^k \log \frac{M * (\beta - k)}{d}.$$

We define the estimators of the order of a Markov model based on AIC, AICc and BIC for the NGS read data by

$$\hat{r}_{AIC^R} = \operatorname{argmin}_k AIC^R(k) \quad (20)$$

$$\hat{r}_{AICc^R} = \operatorname{argmin}_k AICc^R(k) \quad (21)$$

$$\text{and } \hat{r}_{BIC^R} = \operatorname{argmin}_k BIC^R(k) \quad (22)$$

In order to see the effect of the normalization by the effective coverage factor d , we denote by \hat{r}_{AIC} , \hat{r}_{AICc} and \hat{r}_{BIC} the naive estimators, which are obtained by simply substituting the log-likelihood and the size of the data by the log-pseudo-likelihood and the number of $(k+1)$ -tuples in the NGS read data without normalization by d .

C Results

C.1 Simulation studies for the validation of the theoretical results

For the simulation studies we first generate MCs of different orders. For realistic parameter values, the transition probability matrices of the MCs are based on real cis-regulatory module (CRM) DNA sequences in mouse forebrain from Blow et al. (2010). We start the sequence from the stationary distribution. In addition to the first order MC model described above, we also simulate a second order MC. Table S1 shows the transition probability of a) the first and b) the second order MC matrices we used in the simulations.

We generate MCs with length of $G = 10^5$ and 2×10^5 . We simulate NGS data by sampling a varying number of reads of different lengths from the MC as follows. We use the Lander-Waterman model for physical mapping (Lander and Waterman, 1988) to sample NGS reads homogeneously with read length $\beta = 100, 200, 300, 400, 500$ and the number of reads $M = 500, 1000$. The coverage c is calculated as $c = M\beta/G$ and the effective coverage based on the first $\beta - k + 1$ positions is $d = c_{\text{eff}} + 1$, where $c_{\text{eff}} = M(\beta - k + 1)/(G - k + 1)$. Under each combination of (G, M, β) , we calculate the values of $Z_{\mathbf{w}}^R$ for each word \mathbf{w} and S_k^R based on the NGS read data. Then we repeat the processes 2000 times to obtain the empirical distribution of $Z_{\mathbf{w}}^R$ and S_k^R . Finally, we compare the mean and variance of S_k^R with their corresponding theoretical approximations and test the fit of the data to the theoretical approximate distribution using the Kolmogorov-Smirnov (KS) test.

With the current NGS technologies, the reads are generally not homogeneously sampled from the genome. In order to see the effects of inhomogeneous sampling on the approximate distributions of S_k^R and $Z_{\mathbf{w}}^R$, similarly as in Song et al. (2013) we implement the following simulation. We divide the long sequences into 100 blocks, $b_1, \dots, b_t, \dots, b_{100}$. For each block b_t , the sampling probability λ_i for each position in this block is proportional to a random number which is drawn independently from the gamma distribution $\Gamma(1, 20)$ (one number per block).

It has been observed that the probability that a fragment is sequenced in NGS depends on its nucleotide content. Empirical studies showed that the dependency on GC content is unimodal and we use the empirical unimodal distribution on GC curve shown in the software developed by Benjamini and Speed (2012) as an example to generate the reads. The other parameters are the same as before.

(a) The transition probability matrix of the first order MC

	A	C	G	T
A	0.39	0.15	0.21	0.25
C	0.31	0.19	0.12	0.38
G	0.31	0.23	0.20	0.26
T	0.26	0.18	0.21	0.35

(b) The transition probability matrix of the second order MC

	A	C	G	T
AA	0.39	0.19	0.19	0.24
AC	0.25	0.26	0.21	0.27
AG	0.38	0.17	0.29	0.15
AT	0.30	0.24	0.22	0.24
CA	0.46	0.20	0.15	0.18
CC	0.26	0.40	0.11	0.22
CG	0.23	0.16	0.14	0.48
CT	0.29	0.20	0.15	0.37
GA	0.26	0.25	0.23	0.26
GC	0.25	0.17	0.33	0.25
GG	0.26	0.30	0.28	0.17
GT	0.29	0.12	0.22	0.37
TA	0.19	0.19	0.21	0.41
TC	0.12	0.29	0.24	0.35
TG	0.27	0.17	0.25	0.32
TT	0.11	0.18	0.24	0.47

Table S1: The transition probability matrices of a) the first and b) the second order Markov chain in our simulation studies.

Sequencing error is another factor that reduces the data quality. Currently, Illumina sequencing has an error rate about 0.1% and 454 sequencing has an error rate about 1% (Glenn, 2011). In order to see the effect of sequencing errors on the distribution of S_k^R and Z_w^R , in each position of a read, we randomly replace the letter in that position with one of the other three letters with equal probability 0.005; the different letter is drawn with equal probability. The remaining simulation steps stay the same as before.

Next we evaluate the proposed estimators of the order of MCs, \hat{r}_{S_k} , \hat{r}_{P_k} , \hat{r}_h , \hat{r}_{Z_k} and \hat{r}_{PS} and the estimator for the effective coverage d based on equation (7) in the main text, respectively. For estimating the effective coverage d by equation (7) in the main text, we using 3-tuples for a first order MC, and 4-tuples for a second order MC. For evaluating the proposed estimators, we let k range from 2 to 6, i.e. we choose the model from 1st, 2nd, \dots , 5th order MC. The performance of the estimator is measure by the precision rate, i.e. the percentage of times in 1000 repeats the estimator gives the true order. In order to see the effect of genome length and sequencing depth on the estimators, we take the genome length 5000, 7500, 10000, 20000, 50000, while fixing the read coverage to be 1; we take the read coverage 0.05, 0.1, 0.25, 0.5, 0.75, 1, while fixing the genome length to be 10^5 . We also set the sequencing error rate at 10%, which is relatively high compared to the true sequencing error rate in real sequencing, as to distinguish clearly between the estimators with respect to their robustness to sequencing errors. For the estimator \hat{r}_h , we set $\alpha = 0.05$.

When the sequence length is short or the coverage is low, it is possible that the numbers of occurrences of some k -words are close to zero and the expected numbers of occurrences are very low; the estimated expected number of occurrences may turn out to be 0 for some k -words. In order to overcome the issue, we add a pseudo count of 1 to the number of occurrence of all words, which is a common procedure to avoid division by zero and is equivalent to incorporating a flat prior during the parameter estimation in terms of Bayesian statistics, see Narlikar et al. (2013); Streliaoff et al. (2007).

C.1.1 Simulation results for Theorem 1: Homogeneous sampling of the reads

We use simulations to validate the theoretical results in Theorem 1. In our simulation study, here we first generate sequences with genome length of $G = 1 \times 10^5$ and 2×10^5 bps under the first order MC model as shown in Table S1(a). S_3^R with their corresponding theoretical approximations in Theorem 1 are given in Table S2. It can be seen from the table that the approximate mean and variance of S_3^R are very close to their simulated values except in the case of a large number ($M = 1000$) of very short reads ($\beta = 100$) in a small genome ($G = 10^5$ bps).

Moreover, Figure S1(a) shows typical Q-Q (Quantile-Quantile) plots of S_3^R/d versus the distribution of χ_{36}^2 , where the subscript 36 indicates the degree of freedom of the χ^2 distribution, under different models of sampling reads with/without sequencing errors. Similarly, Figure S2(a) show the Q-Q plots of Z_{ACT}^R/\sqrt{d} versus the standard normal distribution under different scenarios; here, the word under consideration is $w = ACT$. The theoretical approximations work well in this situation.

Simulation studies under the higher order MC model and on genomes inserted with repeated regions are carried out in a similar fashion (data not shown). The same conclusion that the theoretical approximate distributions of S_k^R and Z_w^R fit their simulated distributions well holds.

C.1.2 Simulation results for Theorem 1: The effect of inhomogeneous sampling and of sequencing error

We use Q-Q plots to show the effects of inhomogeneous sampling and sequencing errors on the distribution of S_k^R and Z_w^R for $(G, \beta, M) = (10^5, 200, 1000)$. Figure S1 (a, b, c, d) shows the Q-Q plots of the 2000 S_3^R/d scores from (a) homogeneous sampling, (b) inhomogeneous sampling with rate not depending on GC content, (c) inhomogeneous sampling with rate depending on GC content, and (d) homogeneous sampling with sequencing errors v.s. 2000 scores sampled from χ_{36}^2 distribution. The factor

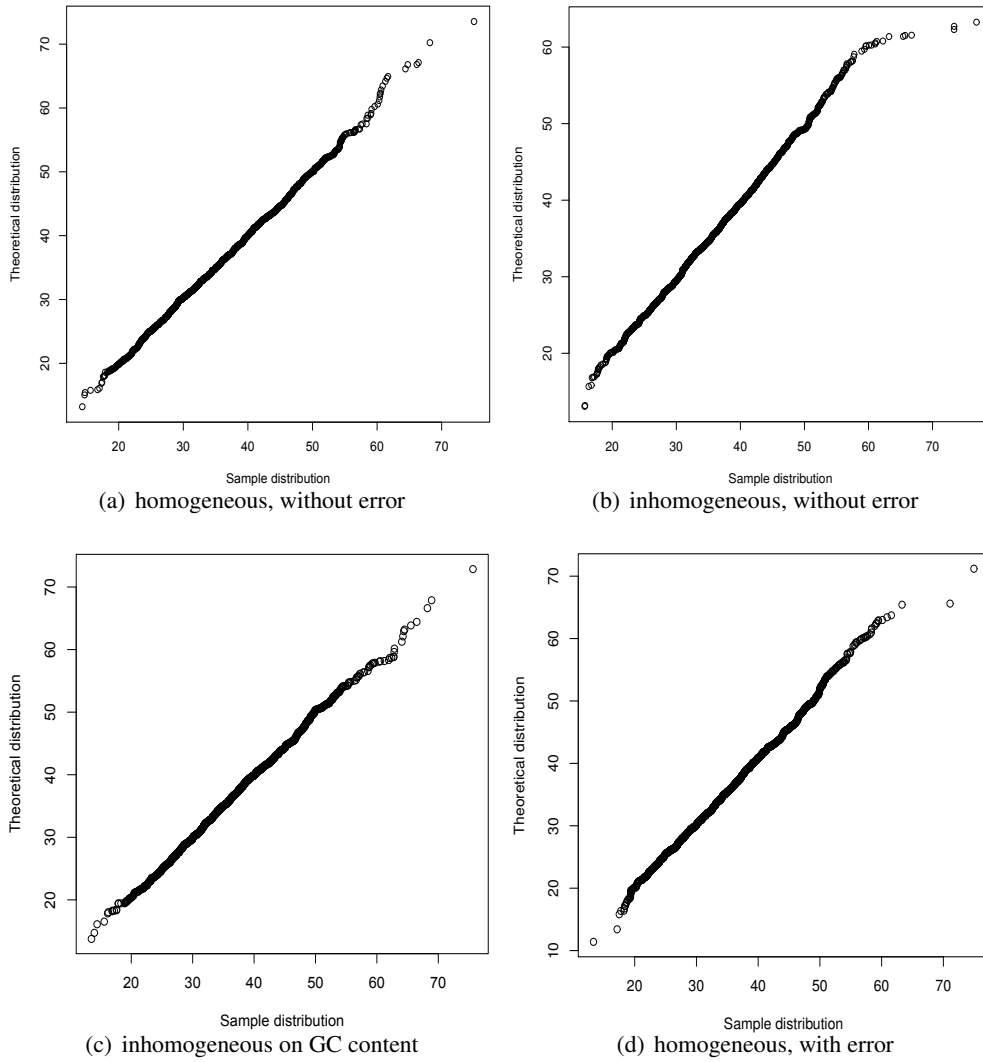

Figure S1: Q-Q plots of the 2000 S_3^R/d scores v.s. 2000 scores sampled from a χ_{36}^2 distribution; $(G, \beta, M) = (10^5, 200, 1000)$. a): homogeneous sampling without error, b): inhomogeneous sampling without error, c): inhomogeneous sampling with sampling rate depending on GC content, d): homogeneous sampling with error.

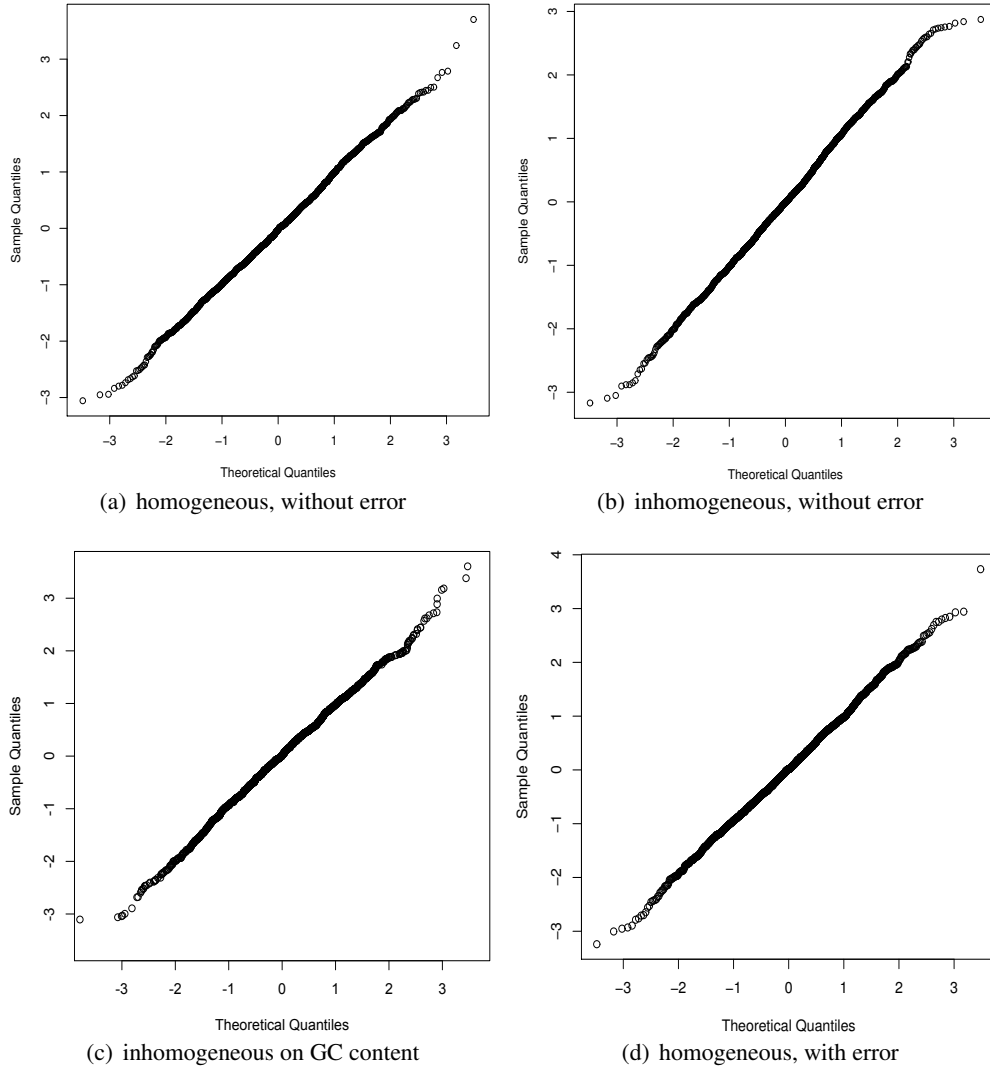

Figure S2: Q-Q plots of the 2000 Z_{ACT}^R/\sqrt{d} scores of the word *ACT* v.s. the 2000 scores sampled from the standard normal distribution; $(G, \beta, M) = (10^5, 200, 1000)$. a): homogeneous sampling without error, b): inhomogeneous sampling without error, c): inhomogeneous sampling with sampling rate depending on GC content, d): homogeneous sampling with error.

(a) Genome length $G = 1 \times 10^5$

β	$M = 500$					$M = 1000$				
	mêan	mean	vâr	var	p-value	mêan	mean	vâr	var	p-value
100	53.4	54.0	160.0	162.0	0.06	70.8	72.0	280.0	288.0	0.002
200	71.6	72.0	277.4	288.0	0.99	106.9	108.0	660.5	648.0	0.15
300	89.8	90.0	482.9	450.0	0.39	143.9	144.0	1139.5	1152.0	0.15
400	107.6	108.0	655.0	648.0	0.84	179.8	180.0	1901.3	1800.0	0.20
500	126.0	126.0	905.2	882.0	0.86	216.6	216.0	2675.3	2592.0	0.26

(b) Genome length $G = 2 \times 10^5$

β	$M = 500$					$M = 1000$				
	mêan	mean	vâr	var	p-value	mêan	mean	vâr	var	p-value
100	44.6	45.0	110.9	112.5	0.12	53.7	54.0	142.7	162.0	0.61
200	53.5	54.0	159.6	162.0	0.13	71.8	72.0	278.4	288.0	0.64
300	62.7	63.0	222.5	220.5	0.95	89.0	90.0	440.1	450.0	0.41
400	71.7	72.0	286.0	288.0	0.51	107.4	108.0	645.7	648.0	0.26
500	80.9	81.0	357.5	364.5	0.69	124.7	126.0	821.3	882.0	0.99

Table S2: Comparison of mean and variance of S_3^R with their corresponding theoretical approximations under a first order MC model and the fit of the data to the theoretical approximate distribution using the KS test. The simulation process was repeated 2000 times for each combination of (G, M, β) . The columns *mêan* and *vâr* are the simulated mean and variance; the columns *mean* and *var* are the theoretical mean and variance.

d is $c_{\text{eff}} + 1$ in homogeneous sampling; and d is calculated from the exact distribution of the sampled reads along the sequence in the inhomogeneous sampling situation. Figure S2 gives the Q-Q plots for Z_{ACT}^R/\sqrt{d} , showing the effect of inhomogeneous sampling and sequencing error on the distribution of Z_{ACT}^R/\sqrt{d} . All Q-Q plots show a satisfactory fit, confirming that the theoretical results from Theorem 1 hold even when the assumptions are not necessarily satisfied.

C.1.3 Simulation results on estimating the order of MCs based on simulated NGS reads

Figure S3 shows the effects of sequence length and read coverage on the precision of the estimators under a first and second order MCs, with homogeneous sampling and sequencing error rate 10%. It can be seen that all the five estimators perform reasonably well. In particular, the precision rate of estimators \hat{r}_{S_k} , \hat{r}_{p_k} , \hat{r}_{Z_k} and \hat{r}_{PS} reach 100% when the genome length is larger than 20000 bps and the read coverage is greater than 0.2. The estimator \hat{r}_h performs slightly worse than the other four estimators. Since the estimator \hat{r}_h is based on hypothesis testing with a given significant level α , the precision rate is not able to reach 100%. It is also possible that no k from 2 to 6 satisfies $p_{k-1} < \alpha$ and both p_k and p_{k+1} are larger than α such that the estimator \hat{r}_h fails to give an estimation. We observe that the precision of \hat{r}_h is sensitive to the accuracy of the estimation of the effective coverage d . In the simulation, if we take the underlying true value of d in place of the estimated value of \hat{d} in the computation, the precision rate of \hat{r}_h goes up to above 90%.

For inhomogeneous sampling, Figure S4 shows the effects of sequence length and read coverage on the precision of the estimators. We can see that the precision rates under the inhomogeneous sampling start at slightly lower values than those under the homogeneous case. As the genome length and the read coverage increase, the estimators perform as well as they perform under the homogeneous sampling.

Figure S5 and S6 show the disappointing precision rates of the AIC and BIC based estimators of the

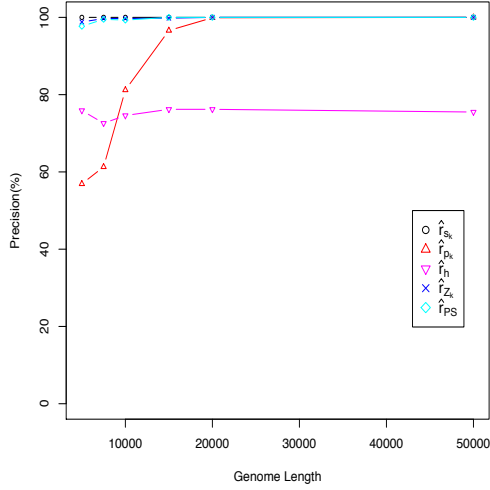

(a) a first order MC, $c = 1$, homogeneous

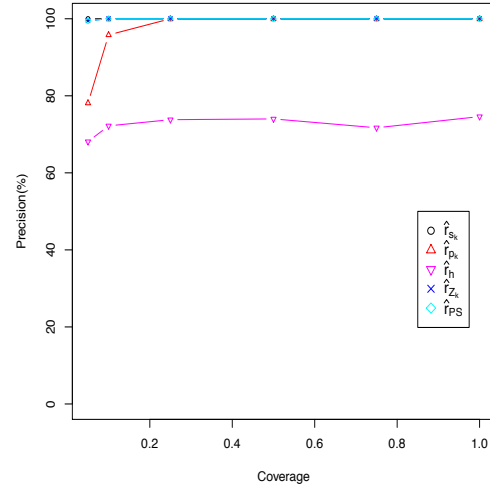

(b) a first order MC, $G = 10^5$, homogeneous

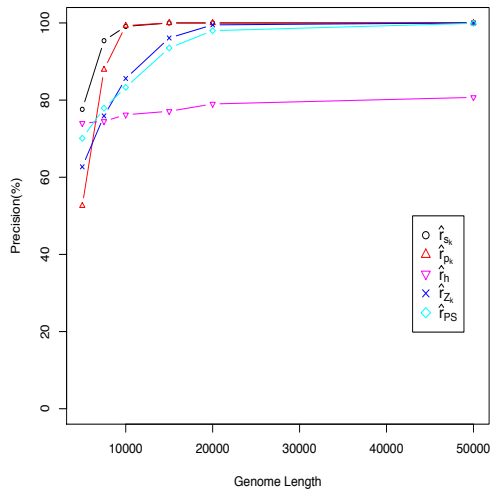

(c) a second order MC, $c = 1$, homogeneous

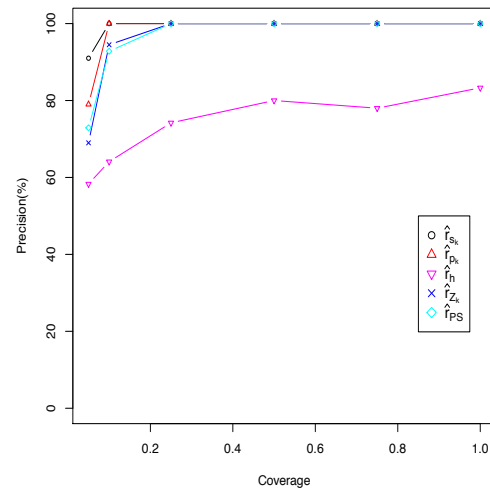

(d) a second order MC, $G = 10^5$, homogeneous

Figure S3: The precision rates of the estimators for the order of a MC under a first and a second order MC, with homogeneous sampling and sequencing error rate 10%. (a,b): The effects of genome length and read coverage to the precision rates under a first order MC. (c,d): The effects of genome length and read coverage on the precision rates under a second order MC.

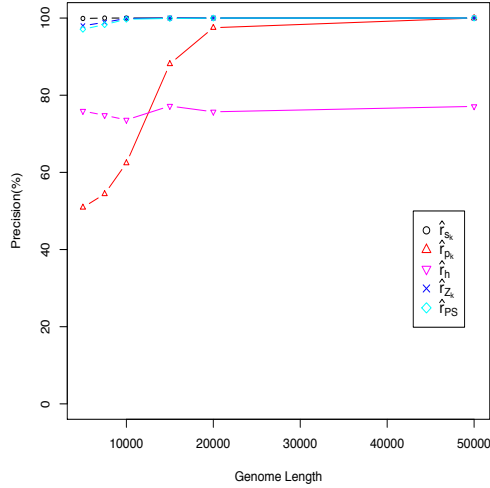

(a) a first order MC, $c = 1$, inhomogeneous

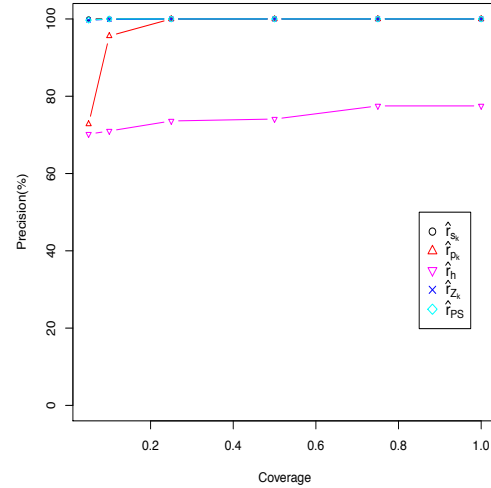

(b) a first order MC, $G = 10^5$, inhomogeneous

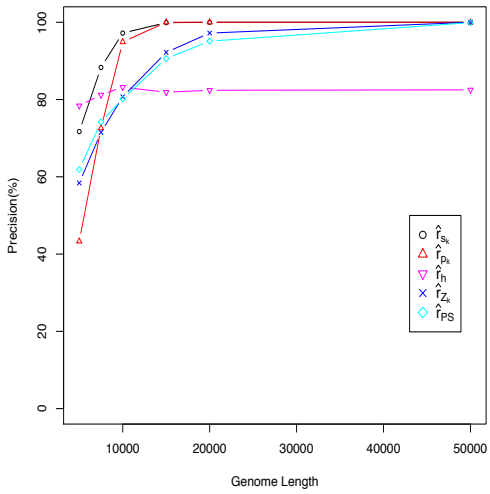

(c) a second order MC, $c = 1$, inhomogeneous

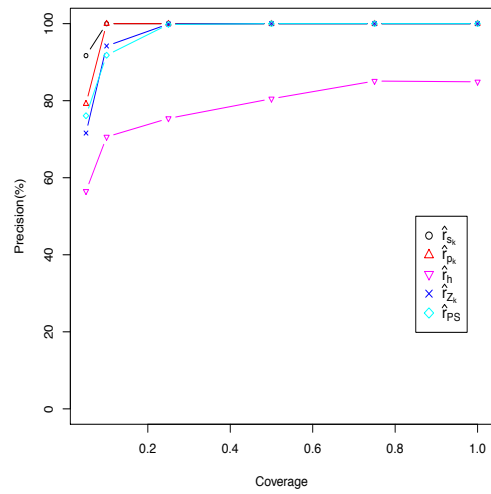

(d) a second order MC, $G = 10^5$, inhomogeneous

Figure S4: The precision rates of the estimators for the order of a MC under a first and a second order MC, with inhomogeneous sampling and sequencing error rate 10%. (a,b): The effects of genome length and read coverage to the precision rates under a first order MC. (c,d): The effects of genome length and read coverage on the precision rates under a second order MC.

order of a MC under a first and a second order MC, with homogeneous (Figure S5) and inhomogeneous sampling (Figure S6). The sequencing error rate is 10% and read length is 100. It can be seen that the normalized estimators \hat{r}_{AIC^R} , \hat{r}_{AICc^R} and \hat{r}_{BIC^R} (in solid lines) have better performance than the their corresponding naive estimators \hat{r}_{AIC} , \hat{r}_{AICc} and \hat{r}_{BIC} (in dotted lines). The BIC based estimator, \hat{r}_{BIC^R} , has generally the best performance among all the AIC and BIC based statistics. However, the precision of \hat{r}_{BIC^R} is low compared to the five estimators \hat{r}_{S_k} , \hat{r}_{p_k} , \hat{r}_h , \hat{r}_{Z_k} , and \hat{r}_{PS} . With the increase of the genome length and read coverage, although \hat{r}_{BIC^R} is able to reach a very high precision rate at some point, the precision finally drops with further increase of the genome length and the read coverage, and it fails to give a consistent estimation. The AIC and AICc based estimators, \hat{r}_{AIC} and \hat{r}_{AICc} , do not differ much in the precision rate.

C.1.4 Simulation results on estimating the effective coverage d

For inhomogeneous sampling of the reads, it is not clear how we estimate the parameter d in Theorem 1 based purely on the naive read coverage c . In equation (7) in the main text, we propose a method to estimate d based on the statistics $(Z_w^R)^2$, $\mathbf{w} \in \mathcal{A}^k$. We assess its accuracy using the average relative error, defined by $MRE = \frac{1}{T} \sum_i^T \frac{|\hat{d}_i - d|}{d}$, where \hat{d}_i is the estimated value of d in the i -th simulation out of the total T repeats, and by the root-mean-relative-squared-error (RMRSR) defined as $RMRSR = \frac{1}{d} \sqrt{\sum_i^T (\hat{d}_i - d)^2 / T}$.

The values of d for the four combinations of (β, M) and the average of their estimations are given in the first and second rows of Table S3. The MRE and RMRSR for the different combinations of (β, M) are given in the third and fourth rows of Table S3. Table S3 shows the results for (a) the homogeneous and (b) the inhomogeneous sampling of the reads using $k = 3$. In general, although the estimation of the effective coverage d becomes slightly inaccurate as the read coverage increases, the estimation is reasonably good. Under the inhomogeneous sampling, the relative errors are slightly higher than those under the homogeneous case, which reflects the greater randomness the inhomogeneous sampling brings into the model; while the MRE error seems unaffected by the choice of d , the RMRSR shows a tendency to increase with increasing d .

We only consider $(\beta, M) = (100, 2000)$ for inhomogeneous sampling with sampling rate depending on GC content as before. In this case, the value of d is 2.08. The mean value of estimated d is 2.16, the MRE is 0.273, and the RMRSR is 0.358 indicating that the value of d can be accurately estimated.

	$(\beta, M) = (100, 1000)$	$(100, 2000)$	$(500, 1000)$	$(500, 2000)$
(a) homogeneous sampling of reads				
d	2	3	6	11
\bar{d}	2.05	3.08	6.16	11.35
MRE	0.278	0.283	0.281	0.279
RMRSR	0.328	0.328	0.339	0.338
(b) inhomogeneous sampling of reads				
d	2.80	4.60	9.56	18.15
\bar{d}	2.85	4.92	10.03	18.86
MRE	0.283	0.281	0.281	0.292
RMRSR	0.321	0.348	0.353	0.359

Table S3: The estimation of the effective coverage d for a) the homogeneous and b) inhomogeneous sampling of reads with $G = 10^5$ bps, $\beta = 100, 500$ bps, and $M = 1000, 2000$; $\bar{d} = \sum_{i=1}^T \hat{d}_i / T$; $T=2000$.

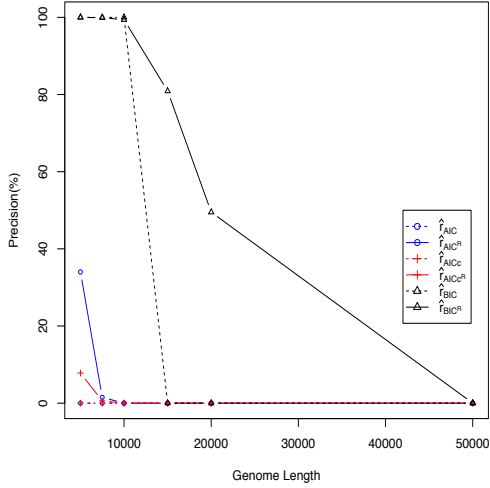

(a) a first order MC, $c = 1$, homogeneous

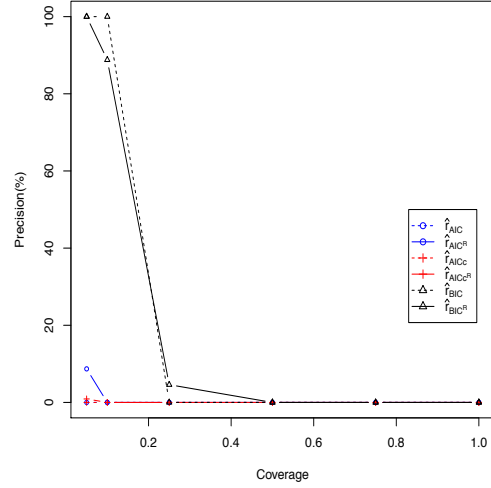

(b) a first order MC, $G = 10^5$, homogeneous

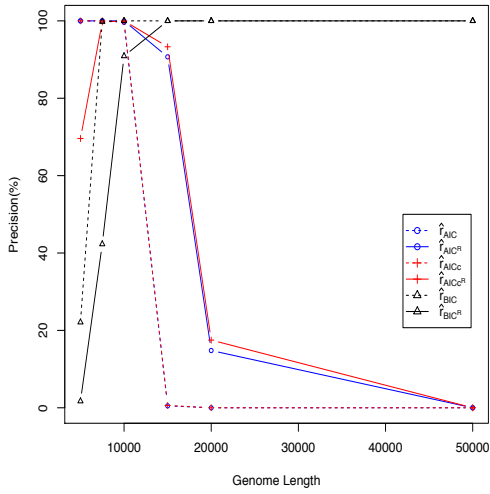

(c) a second order MC, $c = 1$, homogeneous

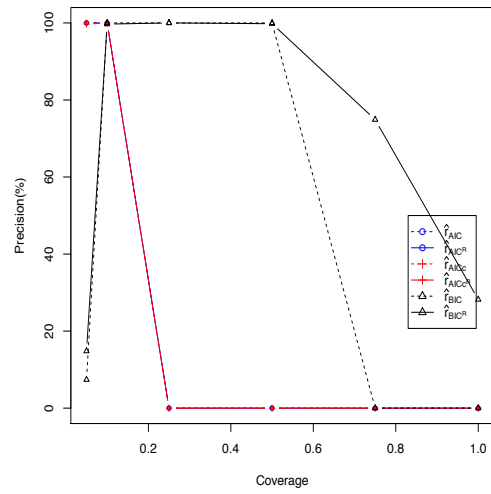

(d) a second order MC, $G = 10^5$, homogeneous

Figure S5: The precision rates of the AIC and BIC based estimators for the order of MC under a first and a second order MC, with homogeneous sampling and sequencing error rate 10%. (a,b): The effects of genome length and read coverage to the precision rates under a first order MC. (c,d): The effects of genome length and read coverage on the precision rates under a second order MC.

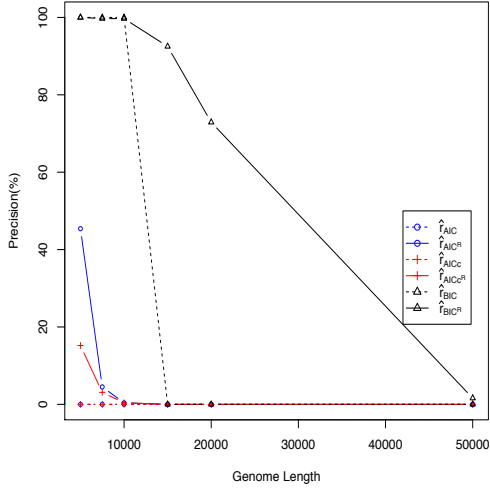

(a) a first order MC, $c = 1$, inhomogeneous

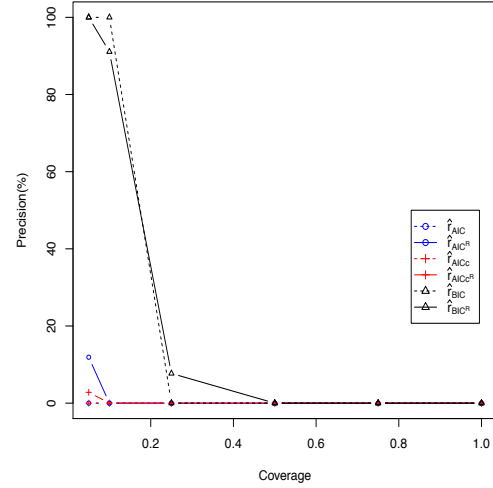

(b) a first order MC, $G = 10^5$, inhomogeneous

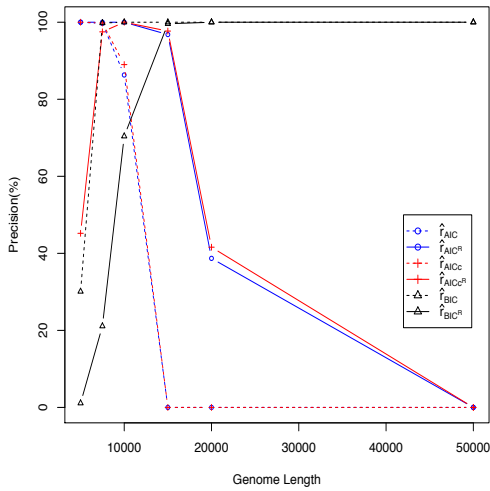

(c) a second order MC, $c = 1$, inhomogeneous

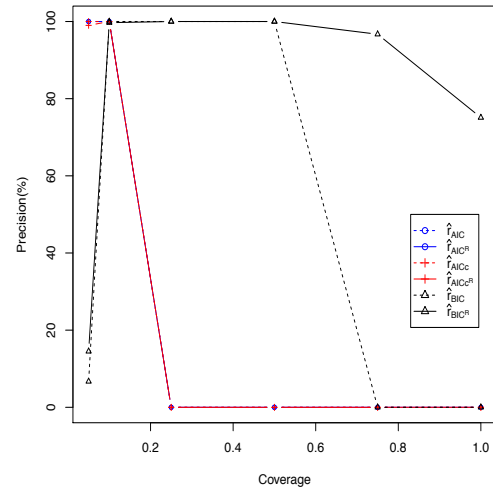

(d) a second order MC, $G = 10^5$, inhomogeneous

Figure S6: The precision rates of the AIC and BIC based estimators for the order of MC under a first and a second order MC, with inhomogeneous sampling and sequencing error rate 10%. (a,b): The effects of genome length and read coverage to the precision rates under a first order MC. (c,d): The effects of genome length and read coverage on the precision rates under a second order MC.

C.2 The relationship among 28 vertebrate species

Table S4 shows the estimated orders of MC for the 28 genomes of vertebrate species based on their NGS samples. For each of the 28 species, we compute the fraction of the k -tuple words that have $(Z_w^R)^2/\hat{d}$ within the 99% of a χ^2 distribution with one degree of freedom, for $k = 8, 9, \dots, 14$. Using 80% as a threshold, we estimate the orders of MC for each species to be the smallest $k - 2$ under which the fraction of words that can be explained by the $(k - 2)$ -th order MC is greater than the threshold. The last two columns of Table S4 are the AIC-predicted optimal and BIC-predicted optimal orders obtained in Narlikar et al. (2013).

We cluster the NGS datasets of the 28 species listed in the Table S4, using d_2^* and d_2^S under MC models of varying order. Figure S1 in Miller et al. (2007) gives the phylogenetic tree of the 28 species based on alignment methods, with branch lengths noted on it. We obtain the distance matrix of the 28 species by computing pairwise distance between each pair of the 28 species from the phylogenetic tree; the matrix is given as Table S5. We compare the dissimilarity matrices using d_2^* and d_2^S under MC models with different order to the matrix Table S5 which we use as underlying truth.

C.3 The relationship among 13 tropical tree species with unknown reference genomes

We also apply our method to the 13 tree species (8 *Fagaceae* and 5 *Moraceae*) based on the NGS shotgun read data sets in Cannon et al. (2010). The reference genome sequences for the 13 tree species are unknown. Figure 1 in the main text shows the clustering results using d_2^* under MCs of order 0, 4, 8 and 9. For the clustering results using d_2^S , see Figure S7.

References

- Almagor, H. (1983). A Markov analysis of DNA sequences. *Journal of Theoretical Biology* 104(4), 633–645.
- Anderson, T. W. and L. A. Goodman (1957). Statistical inference about Markov chains. *The Annals of Mathematical Statistics* 28(4), 89–110.
- Arnold, J., A. J. Cuticchia, D. A. Newsome, W. W. Jennings, and R. Ivarie (1988). Mono-through hexanucleotide composition of the sense strand of yeast DNA: a Markov chain analysis. *Nucleic Acids Research* 16(14), 7145–7158.
- Avery, P. J. (1987). The analysis of intron data and their use in the detection of short signals. *Journal of Molecular Evolution* 26(4), 335–340.
- Avery, P. J. and D. A. Henderson (1999). Fitting Markov chain models to discrete state series such as DNA sequences. *Journal of the Royal Statistical Society: Series C (Applied Statistics)* 48(1), 53–61.
- Baum, L. E. and T. Petrie (1966). Statistical inference for probabilistic functions of finite state Markov chains. *The Annals of Mathematical Statistics* 37(6), 1554–1563.
- Behnam, E. and A. D. Smith (2014). The amordad database engine for metagenomics. *Bioinformatics* 30(20), 2949–2955.
- Behnam, E., M. S. Waterman, and A. D. Smith (2013). A geometric interpretation for local alignment-free sequence comparison. *Journal of Computational Biology* 20(7), 471–485.
- Benjamini, Y. and T. Speed (2012). Summarizing and correcting the gc content bias in high-throughput sequencing. *Nucleic Acids Research* 40(10), e72.

- Besag, J. and D. Mondal (2013). Exact goodness-of-fit tests for Markov chains. *Biometrics* 69(2), 488–496.
- Billingsley, P. (1961a). *Statistical Inference for Markov Processes*, Volume 2. University of Chicago Press Chicago.
- Billingsley, P. (1961b). Statistical methods in Markov chains. *The Annals of Mathematical Statistics* 32(1), 12–40.
- Blaisdell, B. E. (1985). Markov chain analysis finds a significant influence of neighboring bases on the occurrence of a base in eucaryotic nuclear DNA sequences both protein-coding and noncoding. *Journal of Molecular Evolution* 21(3), 278–288.
- Blow, M. J., D. J. McCulley, Z. Li, T. Zhang, J. A. Akiyama, A. Holt, I. Plajzer-Frick, M. Shoukry, C. Wright, F. Chen, et al. (2010). Chip-seq identification of weakly conserved heart enhancers. *Nature Genetics* 42(9), 806–810.
- Cannon, C. H., C. S. Kua, D. Zhang, and J. Harting (2010). Assembly free comparative genomics of short-read sequence data discovers the needles in the haystack. *Molecular Ecology* 19(Suppl. 1), 146–160.
- Daley, T. and A. D. Smith (2013). Predicting the molecular complexity of sequencing libraries. *Nature Methods* 10(4), 325–327.
- Ewens, W. J. and G. R. Grant (2005). *Statistical methods in bioinformatics: an introduction*. Springer.
- Glenn, T. C. (2011). Field guide to next-generation DNA sequencers. *Molecular Ecology Resources* 11(5), 759–769.
- Göke, J., M. H. Schulz, J. Lasserre, and M. Vingron (2012). Estimation of pairwise sequence similarity of mammalian enhancers with word neighbourhood counts. *Bioinformatics* 28(5), 656–663.
- Hoel, P. G. (1954). A test for Markov chains. *Biometrika* 41(3/4), 430–433.
- Hong, J. (1990). Prediction of oligonucleotide frequencies based upon dinucleotide frequencies obtained from the nearest neighbor analysis. *Nucleic Acids Research* 18(6), 1625–1628.
- Hurvich, C. M. and C. L. Tsai (1989). Regression and time series model selection in small samples. *Biometrika* 76(2), 297–307.
- Hurwitz, B. L., A. H. Westveld, J. R. Brum, and M. B. Sullivan (2014). Modeling ecological drivers in marine viral communities using comparative metagenomics and network analyses. *Proceedings of the National Academy of Sciences* 111(29), 10714–10719.
- Jiang, B., K. Song, J. Ren, M. Deng, F. Sun, and X. Zhang (2012). Comparison of metagenomic samples using sequence signatures. *BMC Genomics* 13(1), 730.
- Karolchik, D., R. M. Kuhn, R. Baertsch, G. P. Barber, H. Clawson, M. Diekhans, B. Giardine, R. A. Harte, A. S. Hinrichs, F. Hsu, et al. (2008). The UCSC genome browser database: 2008 update. *Nucleic Acids Research* 36(suppl 1), D773–D779.
- Katz, R. W. (1981). On some criteria for estimating the order of a Markov chain. *Technometrics* 23(3), 243–249.

- Lander, E. S. and M. S. Waterman (1988). Genomic mapping by fingerprinting random clones: a mathematical analysis. *Genomics* 2(3), 231–239.
- Liu, X., L. Wan, J. Li, G. Reinert, M. Waterman, and F. Sun (2011). New powerful statistics for alignment-free sequence comparison under a pattern transfer model. *Journal of Theoretical Biology* 284(1), 106–116.
- Miller, W., K. Rosenbloom, R. Hardison, M. Hou, J. Taylor, B. Raney, R. Burhans, D. King, R. Baertsch, D. Blankenberg, et al. (2007). 28-way vertebrate alignment and conservation track in the UCSC genome browser. *Genome Research* 17(12), 1797–1808.
- Morvai, G. and B. Weiss (2005). Order estimation of Markov chains. *Information Theory, IEEE Transactions on* 51(4), 1496–1497.
- Narlikar, L., N. Mehta, S. Galande, and M. Arjunwadkar (2013). One size does not fit all: On how markov model order dictates performance of genomic sequence analyses. *Nucleic Acids Research* 41(3), 1416–1424.
- Peres, Y. and P. Shields (2005). Two new Markov order estimators. *arXiv preprint math/0506080*.
- Pevzner, P. A., M. Y. Borodovsky, and A. A. Mironov (1989). Linguistics of nucleotide sequences i: the significance of deviations from mean statistical characteristics and prediction of the frequencies of occurrence of words. *Journal of Biomolecular Structure and Dynamics* 6(5), 1013–1026.
- Reinert, G., D. Chew, F. Z. Sun, and M. S. Waterman (2009). Alignment-free sequence comparison (I): Statistics and power. *Journal of Computational Biology* 16(12), 1615–1634.
- Reinert, G., S. Schbath, and M. Waterman (2000). Probabilistic and statistical properties of words: an overview. *Journal of Computational Biology* 7(1-2), 1–46.
- Reinert, G., S. Schbath, and M. S. Waterman (2005). Statistics on words with applications to biological sequences. *Lothaire: Applied Combinatorics on Words, J. Berstel and D. Perrin, eds.* 105, 251–328.
- Ren, J., K. Song, F. Sun, M. Deng, and G. Reinert (2013). Multiple alignment-free sequence comparison. *Bioinformatics* 29(21), 2690–2698.
- Richter, D., F. Ott, A. Auch, R. Schmid, and D. Huson (2008). MetaSim: a sequencing simulator for genomics and metagenomics. *PLoS One* 3(10), e3373.
- Simpson, J. T. (2014). Exploring genome characteristics and sequence quality without a reference. *Bioinformatics* 30(9), 1228–1235.
- Song, K., J. Ren, G. Reinert, M. Deng, M. S. Waterman, and F. Sun (2014). New developments of alignment-free sequence comparison: measures, statistics and next-generation sequencing. *Briefings in Bioinformatics* 15(3), 343–353.
- Song, K., J. Ren, Z. Zhai, X. Liu, M. Deng, and F. Sun (2013). Alignment-free sequence comparison based on next-generation sequencing reads. *Journal of Computational Biology* 20(2), 64–79.
- Streliaff, C. C., J. P. Crutchfield, and A. W. Hübler (2007). Inferring markov chains: Bayesian estimation, model comparison, entropy rate, and out-of-class modeling. *Physical Review E* 76(1), 011106.
- Tong, H. (1975). Determination of the order of a Markov chain by Akaike’s information criterion. *Journal of Applied Probability* 12, 488–497.

- Wang, Y., L. Liu, L. Chen, T. Chen, and F. Sun (2014). Comparison of metatranscriptomic samples based on k-tuple frequencies. *PloS One* 9(1), e84348.
- Waterman, M. S. (1995). *Introduction to Computational Biology: Maps, Sequences and Genomes*. Chapman & Hall/CRC Interdisciplinary Statistics. Taylor & Francis.
- Yi, H. and L. Jin (2013). Co-phylog: an assembly-free phylogenomic approach for closely related organisms. *Nucleic Acids Research* 41(7), e75.
- Zhai, Z., G. Reinert, K. Song, M. S. Waterman, Y. Luan, and F. Sun (2012). Normal and compound poisson approximations for pattern occurrences in ngs reads. *Journal of Computational Biology* 19(6), 839–854.
- Zhang, Z. D., J. Rozowsky, M. Snyder, J. Chang, and M. Gerstein (2008). Modeling chip sequencing in silico with applications. *PLoS Computational Biology* 4(8), e1000158.
- Zhao, L. C., C. C. Y. Dorea, and C. R. Gonçalves (2001). On determination of the order of a Markov chain. *Statistical Inference for Stochastic Processes* 4(3), 273–282.

genome	common name	word length k							estimated order	APO	BPO
		8	9	10	11	12	13	14			
hg38	human	0.12	0.25	0.45	0.68	0.85	0.9	0.78	10	12	10
panTro4	chimp	0.14	0.28	0.49	0.71	0.87	0.91	0.78	10	12	10
rheMac3	macaque	0.16	0.32	0.55	0.76	0.9	0.92	0.78	10	12	10
otoGar3	bushbaby	0.18	0.37	0.58	0.78	0.9	0.92	0.77	10	na	na
tupBel1	tree shrew	0.17	0.34	0.57	0.78	0.9	0.9	0.69	10	na	na
rn5	rat	0.17	0.33	0.55	0.75	0.88	0.92	0.79	10	12	10
mm10	mouse	0.16	0.29	0.49	0.69	0.84	0.89	0.76	10	12	10
cavPor3	guinea pig	0.17	0.32	0.52	0.72	0.86	0.9	0.77	10	13	10
oryCun2	rabbit	0.12	0.25	0.45	0.7	0.87	0.91	0.78	10	na	na
sorAra2	shrew	0.13	0.27	0.47	0.71	0.87	0.91	0.76	10	na	na
eriEur2	hedgehog	0.12	0.24	0.44	0.66	0.83	0.86	0.70	10	na	na
canFam3	dog	0.15	0.32	0.56	0.79	0.91	0.93	0.77	10	12	10
felCat5	cat	0.16	0.33	0.57	0.79	0.92	0.94	0.81	10	12	10
equCab2	horse	0.17	0.34	0.56	0.78	0.9	0.93	0.81	10	12	10
bosTau7	cow	0.12	0.24	0.43	0.67	0.84	0.89	0.76	10	12	10
dasNov3	armadillo	0.12	0.24	0.41	0.63	0.81	0.88	0.78	10	na	na
loxAfr3	elephant	0.12	0.21	0.37	0.59	0.78	0.88	0.79	11	na	na
echTel2	tenrec	0.16	0.3	0.49	0.7	0.86	0.92	0.83	10	na	na
monDom5	opossum	0.14	0.26	0.44	0.64	0.81	0.86	0.73	10	13	11
ornAna1	platypus	0.13	0.29	0.51	0.75	0.89	0.91	0.69	10	12	10
galGal4	chicken	0.4	0.67	0.83	0.94	0.97	0.89	0.64	8	11	8
anoCar2	lizard	0.15	0.25	0.42	0.63	0.81	0.86	0.69	10	12	10
xenTro3	frog	0.17	0.3	0.49	0.71	0.86	0.88	0.67	10	12	10
tetNig2	tetraodon	0.54	0.78	0.91	0.97	0.98	0.82	0.40	8	na	na
fr3	fugu	0.57	0.8	0.92	0.97	0.98	0.83	0.43	7	11	8
gasAcu1	stickleback	0.48	0.7	0.85	0.94	0.97	0.9	0.54	8	11	8
oryLat2	medaka	0.34	0.5	0.69	0.85	0.94	0.88	0.58	9	na	na
danRer7	zebrafish	0.17	0.27	0.42	0.62	0.81	0.88	0.68	10	13	10

Table S4: Estimating the order of the MC for 28 species based on NGS read samples. The 'genome' column is the scientific names shown in UCSC; 'estimated order' is the minimum order of MC r that can explain greater than 80% of the $(r + 2)$ -tuple word at type I error 0.01; 'APO' and 'BPO' columns show the AIC-predicted optimal and BIC-predicted optimal orders obtained in Narlikar et al. (2013); the middle columns with order $k = 8, 9, \dots, 14$ are the fraction of words w with length k that have $(Z_w^R)^2/\hat{d}$ within the 99% of a χ^2 distribution with one degree of freedom. 'na' means the numbers are not provided in Narlikar et al. (2013).

	human	chimp	macaque	bushbaby	tree shrew	rat	mouse	guinea pig	rabbit	shrew	hedgehog	dog	cat	horse	cow	armadillo	elephant	tenrec	opossum	platypus	chicken	lizard	frog	tetraodon	fugu	stickleback	medaka	zebrafish
human	0.00	0.02	0.07	0.26	0.29	0.46	0.46	0.38	0.36	0.48	0.45	0.35	0.35	0.30	0.35	0.33	0.35	0.48	0.72	0.98	1.10	1.21	1.54	1.85	1.89	1.82	2.01	1.83
chimp		0.00	0.07	0.26	0.29	0.46	0.46	0.38	0.36	0.48	0.45	0.35	0.35	0.30	0.35	0.33	0.35	0.48	0.72	0.98	1.10	1.21	1.54	1.85	1.89	1.82	2.01	1.83
macaque			0.00	0.25	0.28	0.45	0.45	0.37	0.35	0.47	0.44	0.34	0.34	0.29	0.34	0.32	0.34	0.47	0.71	0.97	1.09	1.20	1.53	1.84	1.88	1.81	2.00	1.82
bushbaby				0.00	0.33	0.50	0.50	0.42	0.40	0.52	0.49	0.39	0.39	0.34	0.39	0.37	0.39	0.52	0.76	1.02	1.14	1.25	1.58	1.89	1.93	1.86	2.05	1.87
tree shrew					0.00	0.49	0.49	0.41	0.39	0.51	0.48	0.38	0.38	0.33	0.38	0.36	0.38	0.51	0.75	1.01	1.13	1.24	1.57	1.88	1.92	1.85	2.04	1.86
rat						0.00	0.16	0.48	0.52	0.66	0.63	0.53	0.53	0.48	0.53	0.51	0.53	0.66	0.90	1.16	1.28	1.39	1.72	2.03	2.07	2.00	2.19	2.01
mouse							0.00	0.48	0.52	0.66	0.63	0.53	0.53	0.48	0.53	0.51	0.53	0.66	0.90	1.16	1.28	1.39	1.72	2.03	2.07	2.00	2.19	2.01
guinea pig								0.00	0.44	0.58	0.55	0.45	0.45	0.40	0.45	0.43	0.45	0.58	0.82	1.08	1.20	1.31	1.64	1.95	1.99	1.92	2.11	1.93
rabbit									0.00	0.56	0.53	0.43	0.43	0.38	0.43	0.41	0.43	0.56	0.80	1.06	1.18	1.29	1.62	1.93	1.97	1.90	2.09	1.91
shrew										0.00	0.47	0.47	0.47	0.42	0.47	0.49	0.51	0.64	0.88	1.14	1.26	1.37	1.70	2.01	2.05	1.98	2.17	1.99
hedgehog											0.00	0.44	0.44	0.39	0.44	0.46	0.48	0.61	0.85	1.11	1.23	1.34	1.67	1.98	2.02	1.95	2.14	1.96
dog												0.00	0.20	0.25	0.32	0.36	0.38	0.51	0.75	1.01	1.13	1.24	1.57	1.88	1.92	1.85	2.04	1.86
cat													0.00	0.25	0.32	0.36	0.38	0.51	0.75	1.01	1.13	1.24	1.57	1.88	1.92	1.85	2.04	1.86
horse														0.00	0.27	0.31	0.33	0.46	0.70	0.96	1.08	1.19	1.52	1.83	1.87	1.80	1.99	1.81
cow															0.00	0.36	0.38	0.51	0.75	1.01	1.13	1.24	1.57	1.88	1.92	1.85	2.04	1.86
armadillo																0.00	0.28	0.41	0.67	0.93	1.05	1.16	1.49	1.80	1.84	1.77	1.96	1.78
elephant																	0.00	0.33	0.69	0.95	1.07	1.18	1.51	1.82	1.86	1.79	1.98	1.80
tenrec																		0.00	0.82	1.08	1.20	1.31	1.64	1.95	1.99	1.92	2.11	1.93
opossum																			0.00	0.90	1.02	1.13	1.46	1.77	1.81	1.74	1.93	1.75
platypus																				0.00	1.10	1.21	1.54	1.85	1.89	1.82	2.01	1.83
chicken																					0.00	0.91	1.42	1.73	1.77	1.70	1.89	1.71
lizard																						0.00	1.53	1.84	1.88	1.81	2.00	1.82
frog																							0.00	1.87	1.91	1.84	2.03	1.85
tetraodon																								0.00	0.44	0.77	0.96	1.48
fugu																								0.00	0.81	1.00	1.52	
stickleback																									0.00	0.81	1.45	
medaka																										0.00	0.81	1.45
zebrafish																											0.00	1.64

Table S5: The pairwise distance matrix obtain from the Figure S1 in Miller et al. (2007). Figure S1 in Miller et al. (2007) shows the phylogenetic tree of the 28 species based on alignment methods with branch lengths noted on it.

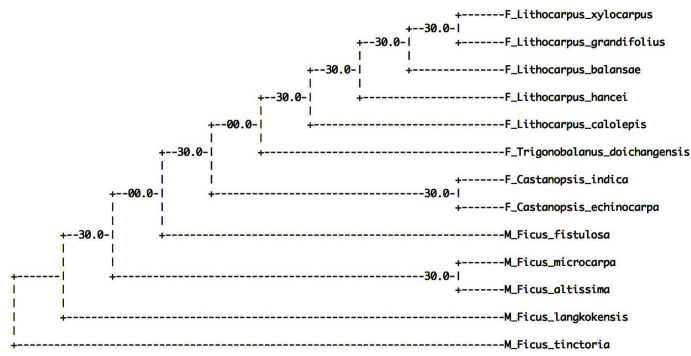

(a) k11, order0, d_2^S

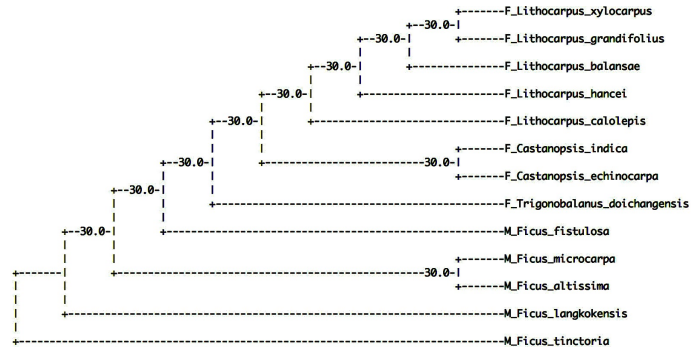

(b) k11, order4, d_2^S

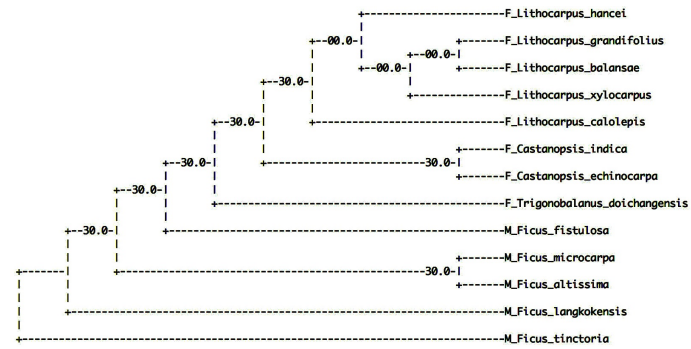

(c) k11, order8, d_2^S

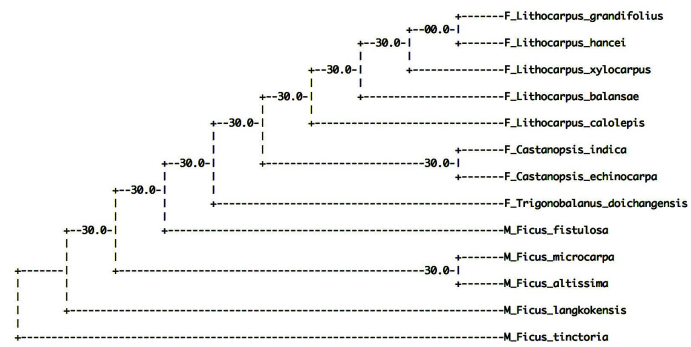

(d) k11, order9, d_2^S

Figure S7: The clustering of the 13 tropical tree species using d_2^S under MC with order of 0(i.i.d), 4, 8 and 9. The number on the branch refers to the frequency of the branch occurring among the 30 clusterings based on random sampled 10% reads. The letter 'F' at the beginning of the names represents *Fagaceae*; similarly the letter 'M' represents *Maraceae*.