

On multisoliton solutions of the constant astigmatism equation

Adam Hlaváč

Mathematical Institute in Opava, Silesian University in Opava, Na Rybníčku 1, 746 01 Opava, Czech Republic. *E-mail*: Adam.Hlavac@math.slu.cz

Abstract. We introduce an algebraic formula producing infinitely many exact solutions of the constant astigmatism equation $z_{yy} + (1/z)_{xx} + 2 = 0$ from a given seed. A construction of corresponding surfaces of constant astigmatism is then a matter of routine. As a special case, we consider multisoliton solutions of the constant astigmatism equation defined as counterparts of famous multisoliton solutions of the sine-Gordon equation. A few particular examples are surveyed as well.

1. Introduction

In this paper, we continue the investigation of the *constant astigmatism equation (CAE)*

$$z_{yy} + \left(\frac{1}{z}\right)_{xx} + 2 = 0, \quad (1)$$

the Gauss equation of *surfaces of constant astigmatism* immersed in Euclidean space. These surfaces are defined as having constant (but nonzero) difference between principal radii of curvature.

Historical roots of the constant astigmatism surfaces can be traced back in works of the 19th century mathematicians [4, 5, 6, 7, 21, 17, 16], though the surfaces were nameless at that time. For more detailed history we refer to, e.g., [20].

In 2009, after about a century in oblivion, the subject of constant astigmatism surfaces has been resurrected by Baran and Marvan in the work [3] concerning the systematic search for integrable classes of Weingarten surfaces. In the paper, the surfaces gained their name and Equation (1) was obtained as well. Recently, the Equation (1) has been examined by several authors [13, 19, 14, 18, 15].

The main result of this paper is Proposition 1, where an algebraic formula (12) provides arbitrary many solutions of Equation (1) from a given seed. The proof is based on the observation that superposition formulas [13, Eq. 21] (see also equations (6) below) can be conveniently written in a matrix form and, therefore, their iteration coincides with the composition of linear transformations, i.e. matrix multiplication. Consequently, the same conclusion holds in the case of multisoliton solutions, i.e. solutions of the CAE having their counterparts in the well known multisoliton solutions of the sine-Gordon equation. Since the algebraic formula for the n -soliton sine-Gordon solution is

well known, the corresponding solution of the CAE can be routinely computed using Proposition 2.

The results of Proposition 1 in combination with [13, Prop. 3] also enable us to construct arbitrarily many constant astigmatism surfaces by purely algebraic manipulations and differentiation once an initial step (including an integration) is successfully performed.

The most important results from the earliest history of the subject of constant astigmatism surfaces were, undoubtedly, obtained by Bianchi [4, 5, 6, 7]. He showed (see also [21]) that evolutes (focal surfaces) of constant astigmatism surfaces are pseudospherical, i.e. with constant negative Gaussian curvature. Conversely, if one equips a pseudospherical surface with parabolic geodesic coordinates and takes the corresponding involutes, then they are of constant astigmatism. Bianchi also succeeded in finding some of the constant astigmatism surfaces explicitly [4, Eq. (30)].

A remarkable class of constant astigmatism surfaces was studied by Lipschitz [17] and its subclass was later investigated by von Lilienthal [16]. Lipschitz parameterised his surfaces by spherical coordinates of the Gaussian image, see Figure 1. Recently, [14], we showed that the solutions of the constant astigmatism equation that correspond to the Lipschitz class of surfaces, are the Lie symmetry invariant solutions and constitute a four-dimensional manifold. The counterpart sine-Gordon solutions are shown to be Lie symmetry invariant as well.

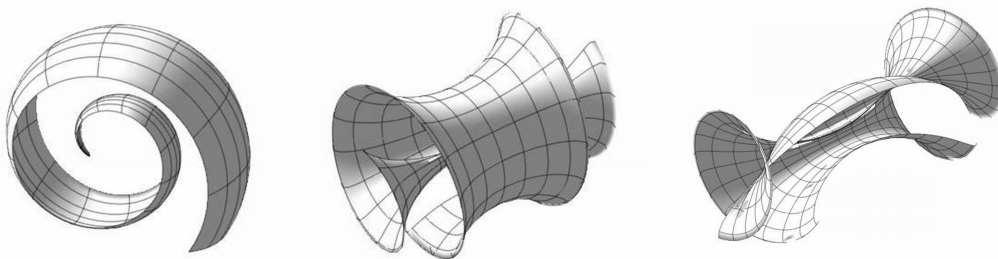

Figure 1. Lipschitz surfaces of constant astigmatism.

The aforementioned geometric link to pseudospherical surfaces served as a tool for deriving a nonlocal transformation between Equation (1) and the well-known sine-Gordon equation

$$\omega_{\xi\eta} = \frac{1}{2} \sin 2\omega, \quad (2)$$

which is the Gauss equation of pseudospherical surfaces parameterised by asymptotic coordinates. For detailed description of the transformations see [3].

By an *orthogonal equiareal pattern* (Sadowsky [23, 24]) we mean a parameterisation x, y such that the corresponding metric is of the form

$$zdx^2 + \frac{1}{z}dy^2,$$

z being an arbitrary function of x, y . An associated *slip line field* is a parameterization ξ, η such that the angle between ∂_x and ∂_ξ as well as the angle between ∂_y and ∂_η is equal to $\pi/4$. In [13] we observed that to every surface of constant astigmatism there corresponds an orthogonal equiareal pattern on the Gaussian sphere. Note that the same result was obtained by Bianchi [7, §375, eq. (20)] in the context of pseudospherical congruences. We also showed that solutions of the sine-Gordon equation (2) correspond to slip line fields on the same Gaussian sphere.

The method of [13] for generating solutions of the constant astigmatism equations and corresponding surfaces of constant astigmatism has its origin in Bäcklund transformation for the sine-Gordon equation. Let ω be a solution of the sine-Gordon equation (2). Its Bäcklund transformation, $\omega^{(\lambda)}$, is given by the system

$$\omega_\xi^{(\lambda)} = \omega_\xi + \lambda \sin(\omega^{(\lambda)} + \omega), \quad \omega_\eta^{(\lambda)} = -\omega_\eta + \frac{1}{\lambda} \sin(\omega^{(\lambda)} - \omega), \quad (3)$$

λ being called a *Bäcklund parameter*. The famous Bianchi permutability theorem [5], see also [7, 22], and the *superposition formula*

$$\tan \frac{\omega^{(\lambda_1 \lambda_2)} - \omega}{2} = \frac{\lambda_1 + \lambda_2}{\lambda_1 - \lambda_2} \tan \frac{\omega^{(\lambda_1)} - \omega^{(\lambda_2)}}{2} \quad (4)$$

enable us to compute solution $\omega^{(\lambda_1 \lambda_2)}$, the Bäcklund transformation of $\omega^{(\lambda_1)}$ with Bäcklund parameter λ_2 , by algebraic manipulations. Therefore, when a seed solution ω is given, the integration of the system (3) needs to be done only once and the further iteration of the Bäcklund transformation can be performed purely algebraically.

Pairs of sine-Gordon solutions related by Bäcklund transformation induce solutions of the constant astigmatism equation. In [13, Def. 4] we defined the *associated potentials* $f^{(\lambda)}, x^{(\lambda)}, y^{(\lambda)}$ corresponding to a pair of sine-Gordon solutions $\omega, \omega^{(\lambda)}$. In terms of $g^{(\lambda)} = e^{f^{(\lambda)}}$ the associated potentials are given by

$$\begin{aligned} g_\xi^{(\lambda)} &= g^{(\lambda)} \lambda \cos(\omega^{(\lambda)} + \omega), & g_\eta^{(\lambda)} &= g^{(\lambda)} \frac{1}{\lambda} \cos(\omega^{(\lambda)} - \omega), \\ x_\xi^{(\lambda)} &= \lambda g^{(\lambda)} \sin(\omega^{(\lambda)} + \omega), & x_\eta^{(\lambda)} &= \frac{1}{\lambda} g^{(\lambda)} \sin(\omega^{(\lambda)} - \omega), \\ y_\xi^{(\lambda)} &= \frac{\lambda \sin(\omega^{(\lambda)} + \omega)}{g^{(\lambda)}}, & y_\eta^{(\lambda)} &= -\frac{\sin(\omega^{(\lambda)} - \omega)}{\lambda g^{(\lambda)}}. \end{aligned} \quad (5)$$

Expressing $z^{(\lambda)} = 1/g^{(\lambda)^2}$ in terms of $x^{(\lambda)}$ and $y^{(\lambda)}$ one obtains a solution of the CAE.

In the same paper (Prop. 5) we succeeded in extending the superposition principle (4) to solutions of the CAE. Let $\omega, \omega^{(\lambda_1)}, \omega^{(\lambda_2)}, \omega^{(\lambda_1 \lambda_2)}$ be four sine-Gordon solutions related by the Bianchi superposition principle (4). Then the associated potentials $g^{(\lambda_1 \lambda_2)}, x^{(\lambda_1 \lambda_2)}, y^{(\lambda_1 \lambda_2)}$ corresponding to the pair $\omega^{(\lambda_1)}, \omega^{(\lambda_1 \lambda_2)}$ are related to

the associated potentials $g^{(\lambda_2)}$, $x^{(\lambda_2)}$, $y^{(\lambda_2)}$ corresponding to the pair $\omega, \omega^{(\lambda_2)}$ by formulas

$$\begin{aligned} g^{(\lambda_1\lambda_2)} &= \frac{-\lambda_1\lambda_2}{\lambda_1^2 + \lambda_2^2 - 2\lambda_1\lambda_2 \cos(\omega^{(\lambda_1)} - \omega^{(\lambda_2)})} g^{(\lambda_2)}, \\ x^{(\lambda_1\lambda_2)} &= \frac{\lambda_1\lambda_2}{\lambda_1^2 - \lambda_2^2} \left(x^{(\lambda_2)} - \frac{2\lambda_1\lambda_2 \sin(\omega^{(\lambda_1)} - \omega^{(\lambda_2)})}{\lambda_1^2 + \lambda_2^2 - 2\lambda_1\lambda_2 \cos(\omega^{(\lambda_1)} - \omega^{(\lambda_2)})} g^{(\lambda_2)} \right), \\ y^{(\lambda_1\lambda_2)} &= \frac{\lambda_1^2 - \lambda_2^2}{\lambda_1\lambda_2} y^{(\lambda_2)} - \frac{2 \sin(\omega^{(\lambda_1)} - \omega^{(\lambda_2)})}{g^{(\lambda_2)}}. \end{aligned} \quad (6)$$

The above formulas can be regarded as a starting point of our approach in this paper.

The contents of this paper are as follows. In Section 2 we observe that equations (6) can be conveniently exposed in matrix form and the iteration of the superposition principle for the CAE reduces to mere matrix multiplication. In Section 3 we handle the multisoliton case, i.e. we deal with solutions of the CAE coming from the well known n -soliton solutions of the sine-Gordon equation. Section 4 deals with constant astigmatism surfaces and slip line fields. In Section 5 we study in detail the n -soliton case for $n = 1, 2, 3$ producing exact solutions of the CAE, constant astigmatism surfaces and slip line fields, whilst the last section is devoted to the subcase when all Bäcklund parameters are equal to 1.

2. Solutions of the CAE

Let $\omega^{[0]} = \bar{\omega}^{[0]}$ be some seed solution of the sine-Gordon equation. Fix Bäcklund parameters $\lambda_1, \dots, \lambda_{k+1}$ and let us denote

$$\omega^{[k]} = \omega^{(\lambda_1\lambda_2\dots\lambda_k)}, \quad \bar{\omega}^{[k]} = \omega^{(\lambda_2\lambda_3\dots\lambda_{k+1})}, \quad (7)$$

see the diagram (a part of the well known Bianchi lattice)

$$\begin{array}{ccccccccc} \omega^{[0]} & \xrightarrow{\lambda_2} & \bar{\omega}^{[1]} & \xrightarrow{\lambda_3} & \bar{\omega}^{[2]} & \xrightarrow{\lambda_4} & \bar{\omega}^{[3]} & \xrightarrow{\lambda_5} & \bar{\omega}^{[4]} & \xrightarrow{\lambda_6} & \dots \\ \lambda_1 \downarrow & & \lambda_1 \downarrow & & \lambda_1 \downarrow & & \lambda_1 \downarrow & & \lambda_1 \downarrow & & \\ \omega^{[1]} & \xrightarrow{\lambda_2} & \omega^{[2]} & \xrightarrow{\lambda_3} & \omega^{[3]} & \xrightarrow{\lambda_4} & \omega^{[4]} & \xrightarrow{\lambda_5} & \omega^{[5]} & \xrightarrow{\lambda_6} & \dots \end{array} \quad (8)$$

Let $g^{[j]}, x^{[j]}, y^{[j]}$ denote the associated potentials (5) corresponding to the pair $\bar{\omega}^{[j-1]}, \omega^{[j]}$. In this notation, the superposition formulas (6) turn out to be

$$\begin{aligned} x^{[j+1]} &= \frac{\lambda_{j+1}\lambda_1}{\lambda_{j+1}^2 - \lambda_1^2} \left(x^{[j]} - \frac{2\lambda_{j+1}\lambda_1 \sin(\bar{\omega}^{[j]} - \omega^{[j]})}{\lambda_{j+1}^2 + \lambda_1^2 - 2\lambda_{j+1}\lambda_1 \cos(\bar{\omega}^{[j]} - \omega^{[j]})} g^{[j]} \right), \\ y^{[j+1]} &= \frac{\lambda_{j+1}^2 - \lambda_1^2}{\lambda_{j+1}\lambda_1} y^{[j]} - \frac{2 \sin(\bar{\omega}^{[j]} - \omega^{[j]})}{g^{[j]}}, \\ g^{[j+1]} &= \frac{-\lambda_{j+1}\lambda_1}{\lambda_{j+1}^2 + \lambda_1^2 - 2\lambda_{j+1}\lambda_1 \cos(\bar{\omega}^{[j]} - \omega^{[j]})} g^{[j]}. \end{aligned} \quad (9)$$

The above formulas constitute recurrence relations for the quantities $x^{[n]}, y^{[n]}, g^{[n]}$ with the initial conditions

$$x^{[1]} = x_1, \quad y^{[1]} = y_1, \quad g^{[1]} = g_1. \quad (10)$$

Proposition 1. *Let x_1, y_1, g_1 be the associated potentials corresponding to the pair $\omega^{[0]}, \omega^{[1]}$ of sine-Gordon solutions. Let $S^{[j]}$ be 4×4 matrices with entries defined by formulas*

$$\begin{aligned} S_{11}^{[j]} &= \frac{\lambda_{j+1}\lambda_1}{\lambda_{j+1}^2 - \lambda_1^2}, & S_{13}^{[j]} &= -\frac{\lambda_{j+1}^2\lambda_1^2}{\lambda_{j+1}^2 - \lambda_1^2} \cdot \frac{2\sin(\bar{\omega}^{[j]} - \omega^{[j]})}{\lambda_{j+1}^2 + \lambda_1^2 - 2\lambda_{j+1}\lambda_1 \cos(\bar{\omega}^{[j]} - \omega^{[j]})}, \\ S_{22}^{[j]} &= \frac{\lambda_{j+1}^2 - \lambda_1^2}{\lambda_{j+1}\lambda_1}, & S_{24}^{[j]} &= -2\sin(\bar{\omega}^{[j]} - \omega^{[j]}), \\ S_{33}^{[j]} &= \frac{1}{S_{44}^{[j]}} = \frac{-\lambda_{j+1}\lambda_1}{\lambda_{j+1}^2 + \lambda_1^2 - 2\lambda_{j+1}\lambda_1 \cos(\bar{\omega}^{[j]} - \omega^{[j]})} \end{aligned} \quad (11)$$

all the other entries being zero. Let

$$\begin{pmatrix} x^{[n]} \\ y^{[n]} \\ g^{[n]} \\ 1/g^{[n]} \end{pmatrix} = \prod_{i=1}^{n-1} S^{[i]} \begin{pmatrix} x_1 \\ y_1 \\ g_1 \\ 1/g_1 \end{pmatrix}. \quad (12)$$

Then $x^{[n]}, y^{[n]}, g^{[n]}$ are the associated potentials corresponding to the pair $\bar{\omega}^{[n-1]}, \omega^{[n]}$. Moreover, if $z^{[n]} = 1/g^{[n]2}$, then $z^{[n]}(x^{[n]}, y^{[n]})$ is a solution of the constant astigmatism equation (1).

Proof. One easily observes that relations (9) can be obtained by acting of 4×4 matrix $S^{[j]}$ with the only nonzero entries (11) on the column vector $X^{[j]} = (x^{[j]}, y^{[j]}, g^{[j]}, 1/g^{[j]})^T$. The recurrent formula (9) with initial conditions (10) then can be conveniently written as

$$X^{[j+1]} = S^{[j]} X^{[j]}, \quad X^{[1]} = X_1 = (x_1, y_1, g_1, 1/g_1)^T.$$

Hence

$$X^{[n]} = \prod_{i=1}^{n-1} S^{[i]} X_1.$$

□

Remark 1. Expanding the matrix formula (12) we have

$$\begin{aligned}
 x^{[n]} &= x_1 \lambda_1^{n-1} \prod_{i=1}^{n-1} \frac{\lambda_{i+1}}{\lambda_{i+1}^2 - \lambda_1^2} \\
 &- 2 \sum_{i=1}^{n-1} \left(\frac{\lambda_{i+1} \lambda_1^{n-i+1} g^{[i]} \sin(\bar{\omega}^{[i]} - \omega^{[i]})}{\lambda_{i+1}^2 + \lambda_1^2 - 2\lambda_{i+1}\lambda_1 \cos(\bar{\omega}^{[i]} - \omega^{[i]})} \prod_{p=1}^{n-i} \frac{\lambda_{n-p+1}}{\lambda_{n-p+1}^2 - \lambda_1^2} \right), \\
 y^{[n]} &= \frac{y_1}{\lambda_1^{n-1}} \prod_{i=1}^{n-1} \frac{\lambda_{i+1}^2 - \lambda_1^2}{\lambda_{i+1}} - 2 \sum_{i=1}^{n-1} \left(\frac{\sin(\bar{\omega}^{[i]} - \omega^{[i]})}{\lambda_1^{n-i-1} g^{[i]}} \prod_{p=1}^{n-i-1} \frac{\lambda_{n-p+1}^2 - \lambda_1^2}{\lambda_{n-p+1}} \right), \\
 g^{[n]} &= \lambda_1^{n-1} g_1 \prod_{i=1}^{n-1} \frac{-\lambda_{i+1}}{\lambda_{i+1}^2 + \lambda_1^2 - 2\lambda_{i+1}\lambda_1 \cos(\bar{\omega}^{[i]} - \omega^{[i]})}.
 \end{aligned}$$

3. Multisoliton solutions

Let $\omega^{[0]} = 0$. Let us define $\lambda_{kl}^+ := \lambda_k + \lambda_l$, $\lambda_{kl}^- := \lambda_k - \lambda_l$ and

$$a_i := \exp\left(\lambda_i \xi + \frac{\eta}{\lambda_i} + c_i\right).$$

Solving System (3), we get one-soliton solutions

$$\omega^{[1]} = 2 \arctan a_1, \quad \bar{\omega}^{[1]} = 2 \arctan a_2$$

and, applying the superposition principle (4) to the triple $\omega^{[0]}, \omega^{[1]}, \bar{\omega}^{[1]}$, we easily obtain the two-soliton solutions

$$\omega^{[2]} = 2 \arctan \frac{\lambda_{12}^+(a_1 - a_2)}{\lambda_{12}^-(1 + a_1 a_2)}, \quad \bar{\omega}^{[2]} = 2 \arctan \frac{\lambda_{23}^+(a_2 - a_3)}{\lambda_{23}^-(1 + a_2 a_3)}. \quad (13)$$

An exact analytic n -soliton solution, in our notation $\omega^{[n]}$, of the sine-Gordon equation has been obtained by several authors [1, 8, 9, 10, 11, 12], see also [2, 25]. The formula best suited for this paper can be found e.g. in [11] and is of the form

$$\omega^{[n]} = \frac{1}{2} \arccos \varphi^{[n]}, \quad (14)$$

where

$$\varphi^{[n]} = 1 - 2 \frac{\partial^2}{\partial \xi \partial \eta} \ln \det M \quad (15)$$

M being the $n \times n$ matrix with entries

$$M_{ij} = \frac{1}{\lambda_i + \lambda_j} \left(\sqrt{a_i a_j} + \frac{1}{\sqrt{a_i a_j}} \right).$$

Note also that $\bar{\omega}^{[n]}$ arises from $\omega^{[n]}$ by increasing all lambdas' indices by one, namely

$$\bar{\omega}^{[n]} = \frac{1}{2} \arccos \bar{\varphi}^{[n]}, \quad (16)$$

where

$$\bar{\varphi}^{[n]} = 1 - 2 \frac{\partial^2}{\partial \xi \partial \eta} \ln \det \bar{M} \quad (17)$$

\bar{M} being given by

$$\bar{M}_{ij} = \frac{1}{\lambda_{i+1} + \lambda_{j+1}} \left(\sqrt{a_{i+1} a_{j+1}} + \frac{1}{\sqrt{a_{i+1} a_{j+1}}} \right).$$

Definition 1. By a j -soliton solution of the constant astigmatism equation we shall mean a triple $(x^{[j]}, y^{[j]}, g^{[j]})$ formed by associated potentials corresponding to the j -soliton solution $\omega^{[j]}$ and the $(j-1)$ -soliton solution $\bar{\omega}^{[j-1]}$ (see Diagram (8)) of the sine-Gordon equation.

Remark 2. To obtain a solution of the CAE explicitly, one would have to express $z^{[j]} = 1/g^{[j]2}$ in terms of $x^{[j]}$ and $y^{[j]}$. However, this is almost never possible in terms of elementary functions, see examples in Section 5 and 6.

A one-soliton solution of the CAE is easy to construct. Following [4, 7], see also [13, Prop. 4], $x^{[1]} = x_1$ and $g^{[1]} = g_1$ can be obtained by differentiation, namely

$$g_1 = \frac{d\omega^{[1]}}{dc_1} = \frac{2a_1}{1+a_1^2}, \quad x_1 = -\frac{d \ln g_1}{dc_1} = \frac{a_1^2 - 1}{a_1^2 + 1}. \quad (18)$$

For $y^{[1]} = y_1$ we have the system

$$y_\xi^{[1]} = \frac{\lambda_1 \sin(\omega^{[1]} + \bar{\omega}^{[0]})}{g_1} = \lambda_1,$$

$$y_\eta^{[1]} = -\frac{\sin(\omega^{[1]} - \bar{\omega}^{[0]})}{\lambda_1 g_1} = -\frac{1}{\lambda_1}$$

with the general solution

$$y_1 = \lambda_1 \xi - \frac{\eta}{\lambda_1} + k_1, \quad (19)$$

k_1 being an arbitrary constant. Setting $z_1 = 1/g_1^2$, eliminating ξ, η and dropping the lower indices, one reveals the *von Lilienthal solution*

$$z = \frac{1}{1-x^2}, \quad (20)$$

see Figure 2 on p. 11.

Proposition 2. Let us denote $A^{[j]} = 2\bar{\varphi}^{[j]}\varphi^{[j]}$ and $B^{[j]} = 2\sqrt{(\bar{\varphi}^{[j]2} - 1)(\varphi^{[j]2} - 1)}$, where $\varphi^{[j]}$ and $\bar{\varphi}^{[j]}$ are defined by (15) and (17) respectively. Then the n -soliton solution of the CAE is given by the formula

$$\begin{pmatrix} x^{[n]} \\ y^{[n]} \\ g^{[n]} \\ 1/g^{[n]} \end{pmatrix} = \prod_{i=1}^{n-1} S^{[i]} \begin{pmatrix} x_1 \\ y_1 \\ g_1 \\ 1/g_1 \end{pmatrix}, \quad (21)$$

where the only nonzero entries of matrices $S^{[j]}$ are given by

$$\begin{aligned}
 S_{11}^{[j]} &= \frac{\lambda_{j+1}\lambda_1}{\lambda_{j+1}^2 - \lambda_1^2}, & S_{13}^{[j]} &= \frac{\lambda_{j+1}^2\lambda_1^2}{\lambda_1^2 - \lambda_{j+1}^2} \cdot \frac{\sqrt{2 - A^{[j]} - B^{[j]}}}{\lambda_1^2 + \lambda_{j+1}^2 - \lambda_{j+1}\lambda_1\sqrt{2 + A^{[j]} + B^{[j]}}} \\
 S_{22}^{[j]} &= \frac{\lambda_{j+1}^2 - \lambda_1^2}{\lambda_{j+1}\lambda_1}, & S_{24}^{[j]} &= -\sqrt{2 - A^{[j]} - B^{[j]}}, \\
 S_{33}^{[j]} &= \frac{1}{S_{44}^{[j]}} = \frac{-\lambda_{j+1}\lambda_1}{\lambda_1^2 + \lambda_{j+1}^2 - \lambda_{j+1}\lambda_1\sqrt{2 + A^{[j]} + B^{[j]}}}.
 \end{aligned} \tag{22}$$

Proof. Formulas (22) follow from plugging (14) and (16) into (11) and employing trigonometric identities. \square

4. Surfaces of constant astigmatism

Let \mathbf{r} be a pseudospherical surface corresponding to a sine-Gordon solution ω . Its Bäcklund transformation $\mathbf{r}^{(\lambda)}$ is given by the formula

$$\mathbf{r}^{(\lambda)} = \mathbf{r} + \frac{2\lambda}{1 + \lambda^2} \left(\frac{\sin(\omega - \omega^{(\lambda)})}{\sin(2\omega)} \mathbf{r}_\xi + \frac{\sin(\omega + \omega^{(\lambda)})}{\sin(2\omega)} \mathbf{r}_\eta \right). \tag{23}$$

Let us define (cf. (7))

$$\mathbf{r}^{[k]} = \mathbf{r}^{(\lambda_1\lambda_2\dots\lambda_k)}, \quad \bar{\mathbf{r}}^{[k]} = \mathbf{r}^{(\lambda_2\lambda_3\dots\lambda_{k+1})}.$$

Then we have the recurrence relation

$$\mathbf{r}^{[j+1]} = \mathbf{r}^{[j]} + \frac{2\lambda_{j+1}}{1 + \lambda_{j+1}^2} \left(\frac{\sin(\omega^{[j]} - \omega^{[j+1]})}{\sin(2\omega^{[j]})} \mathbf{r}_\xi^{[j]} + \frac{\sin(\omega^{[j]} + \omega^{[j+1]})}{\sin(2\omega^{[j]})} \mathbf{r}_\eta^{[j]} \right) \tag{24}$$

with the initial condition $\mathbf{r}^{[0]} = \bar{\mathbf{r}}^{[0]} = \mathbf{r}_0$. Surfaces $\bar{\mathbf{r}}^{[i]}$ are obtained from $\mathbf{r}^{[i]}$ simply by increasing all lambdas' indices by one and replacing $\omega^{[i]}$ with $\bar{\omega}^{[i]}$. The iteration process is shown in the diagram below, cf. (8).

$$\begin{array}{ccccccccc}
 \mathbf{r}^{[0]} & \xrightarrow{\lambda_2} & \bar{\mathbf{r}}^{[1]} & \xrightarrow{\lambda_3} & \bar{\mathbf{r}}^{[2]} & \xrightarrow{\lambda_4} & \bar{\mathbf{r}}^{[3]} & \xrightarrow{\lambda_5} & \bar{\mathbf{r}}^{[4]} & \xrightarrow{\lambda_6} & \dots \\
 \lambda_1 \downarrow & & \lambda_1 \downarrow & & \lambda_1 \downarrow & & \lambda_1 \downarrow & & \lambda_1 \downarrow & & \\
 \mathbf{r}^{[1]} & \xrightarrow{\lambda_2} & \mathbf{r}^{[2]} & \xrightarrow{\lambda_3} & \mathbf{r}^{[3]} & \xrightarrow{\lambda_4} & \mathbf{r}^{[4]} & \xrightarrow{\lambda_5} & \mathbf{r}^{[5]} & \xrightarrow{\lambda_6} & \dots
 \end{array}$$

Substituting $\lambda = 1$ into (23) one gets what is called a *complementary* pseudospherical surface

$$\mathbf{r}^{(1)} = \mathbf{r} + \frac{\sin(\omega - \omega^{(1)})}{\sin(2\omega)} \mathbf{r}_\xi + \frac{\sin(\omega + \omega^{(1)})}{\sin(2\omega)} \mathbf{r}_\eta.$$

Obviously, the surfaces $\mathbf{r}^{[j]}$ and $\bar{\mathbf{r}}^{[j-1]}$ become complementary when substituting $\lambda_1 = 1$ into $\mathbf{r}^{[j]}$.

According to [13, Prop. 3], the common involute, $\tilde{\mathbf{r}}^{[j]}$, of a pair of complementary pseudospherical surfaces, $\mathbf{r}^{[j]}|_{\lambda_1=1}$ and $\tilde{\mathbf{r}}^{[j-1]}$, is of constant astigmatism and is given by the equation

$$\tilde{\mathbf{r}}^{[j]} = \bar{\mathbf{r}}^{[j-1]} - \tilde{\mathbf{n}}^{[j]} \ln g^{[j]}|_{\lambda_1=1},$$

where $g^{[j]}$ is determined by (12) and $\tilde{\mathbf{n}}^{[j]}$, a unit normal of the constant astigmatism surface, is simply

$$\tilde{\mathbf{n}}^{[j]} = \mathbf{r}^{[j]}|_{\lambda_1=1} - \bar{\mathbf{r}}^{[j-1]}.$$

If the surfaces $\mathbf{r}^{[j]}|_{\lambda_1=1}$ and $\tilde{\mathbf{r}}^{[j-1]}$ are j -soliton and $(j-1)$ -soliton pseudospherical surfaces respectively, then the corresponding common involute, $\tilde{\mathbf{r}}^{[j]}$, will be called a *j -soliton surface of constant astigmatism*.

Let us also remark that $\tilde{\mathbf{n}}^{[j]}(\xi, \eta)$ parameterises a unit sphere by slip lines (see the Introduction, for details see [13]).

5. Examples of multisoliton solutions

In this section we provide explicit formulas for some multisoliton solutions of the constant astigmatism equation as well as corresponding constant astigmatism surfaces.

Firstly, let us introduce a notation. Let us define

$$\alpha := \xi - \eta, \quad \beta := \xi + \eta$$

which is nothing but the space and time coordinates in which sine-Gordon equation is of the form $\omega_{\beta\beta} - \omega_{\alpha\alpha} = \sin \omega$. Also recall that

$$a_i := \exp\left(\lambda_i \xi + \frac{\eta}{\lambda_i} + c_i\right), \quad \lambda_{kl}^+ := \lambda_k + \lambda_l, \quad \lambda_{kl}^- := \lambda_k - \lambda_l$$

and, in order to have short formulas, let us define

$$\begin{aligned} a &:= \exp(\xi + \eta + c), & \lambda_{kl}^\oplus &:= \lambda_k^2 + \lambda_l^2, & \lambda_{kl}^\ominus &:= \lambda_k^2 - \lambda_l^2, \\ \lambda_k^+ &:= \lambda_k + 1, & \lambda_k^- &:= \lambda_k - 1, & \lambda_k^\oplus &:= \lambda_k^2 + 1, & \lambda_k^\ominus &:= \lambda_k^2 - 1. \end{aligned}$$

5.1. One-soliton solutions

In Section 3 we constructed the one soliton solution of the CAE corresponding to the pair $\omega^{[0]} = 0$ and $\omega^{[1]} = 2 \arctan a_1$. It belongs to the von Lilienthal class. Let us proceed to the corresponding surfaces of constant astigmatism. The family of well known one-soliton Dini's surfaces is

$$\bar{\mathbf{r}}^{[1]} = \left(\frac{4\lambda_2 a_2 \cos \alpha}{\lambda_2^+(a_2^2 + 1)}, \frac{4\lambda_2 a_2 \sin \alpha}{\lambda_2^+(a_2^2 + 1)}, \beta - \frac{2\lambda_2(a_2^2 - 1)}{\lambda_2^+(a_2^2 + 1)} \right).$$

Substituting $\lambda_1 = 1$ into another Dini's surface

$$\mathbf{r}^{[1]} = \left(\frac{4\lambda_1 a_1 \cos \alpha}{\lambda_1^+(a_1^2 + 1)}, \frac{4\lambda_1 a_1 \sin \alpha}{\lambda_1^+(a_1^2 + 1)}, \beta - \frac{2\lambda_1(a_1^2 - 1)}{\lambda_1^+(a_1^2 + 1)} \right)$$

we obtain the pseudosphere

$$\mathbf{r}^{[1]}|_{\lambda_1=1} = \left(\frac{2a \cos \alpha}{a^2 + 1}, \frac{2a \sin \alpha}{a^2 + 1}, \beta + \frac{1 - a^2}{1 + a^2} \right). \quad (25)$$

Note that in this case the 'seed surface' $\mathbf{r}^{[0]} = \mathbf{r}_0$ is degenerated and coincides with the z -axis $(0, 0, \beta)$.

The Gaussian map of corresponding constant astigmatism surface is

$$\tilde{\mathbf{n}}^{[1]} = \mathbf{r}^{[1]}|_{\lambda_1=1} - \mathbf{r}_0 = \left(\frac{2a \cos \alpha}{a^2 + 1}, \frac{2a \sin \alpha}{a^2 + 1}, \frac{1 - a^2}{1 + a^2} \right),$$

forming the net of 45° loxodromes on the unit sphere. The family of one-soliton constant astigmatism surfaces is then

$$\tilde{\mathbf{r}}^{[1]} = \mathbf{r}_0 - \tilde{\mathbf{n}}^{[1]} \ln(kg^{[1]})|_{\lambda_1=1} = \begin{pmatrix} \frac{-2a}{1 + a^2} \ln\left(\frac{2ka}{1 + a^2}\right) \cos \alpha \\ \frac{-2a}{1 + a^2} \ln\left(\frac{2ka}{1 + a^2}\right) \sin \alpha \\ \beta + \frac{a^2 - 1}{a^2 + 1} \ln\left(\frac{2ka}{1 + a^2}\right) \end{pmatrix}, \quad (26)$$

k being a real constant. The surfaces coincide with the von Lilienthal class [16], see Figure 2; for detailed description and pictures see [3]. Evolutes of the surface $\tilde{\mathbf{r}}^{[1]}$ are the pseudosphere $\mathbf{r}^{[1]}|_{\lambda_1=1}$ and the z -axis \mathbf{r}_0 .

5.2. Two-soliton solutions

The two-soliton solutions of the sine-Gordon equation are given by (13) and the two soliton solution of the CAE corresponding to the pair $\bar{\omega}^{[1]}$ and $\omega^{[2]}$ is

$$\begin{aligned} x^{[2]} &= \frac{-\lambda_2 \lambda_1}{\lambda_{12}^\ominus} \cdot \frac{\lambda_{12}^{+2}(a_1^2 - a_2^2) + \lambda_{12}^{-2}(a_1^2 a_2^2 - 1)}{\lambda_{12}^{+2}(a_1^2 + a_2^2) + \lambda_{12}^{-2}(a_1^2 a_2^2 + 1) - 8\lambda_1 \lambda_2 a_1 a_2}, \\ y^{[2]} &= -\frac{\lambda_{12}^\ominus}{\lambda_1^2 \lambda_2} (\lambda_1^2 \xi - \eta) + \frac{2(1 + a_1 a_2)(a_1 - a_2)}{a_1(1 + a_2^2)}, \\ g^{[2]} &= \frac{-2\lambda_1 \lambda_2 a_1(1 + a_2^2)}{\lambda_{12}^{+2}(a_1^2 + a_2^2) + \lambda_{12}^{-2}(a_1^2 a_2^2 + 1) - 8\lambda_1 \lambda_2 a_1 a_2}, \\ z^{[2]} &= \frac{1}{g^{[2]2}} = \left(\frac{\lambda_{12}^{+2}(a_1^2 + a_2^2) + \lambda_{12}^{-2}(a_1^2 a_2^2 + 1) - 8\lambda_1 \lambda_2 a_1 a_2}{2\lambda_1 \lambda_2 a_1(1 + a_2^2)} \right)^2. \end{aligned} \quad (27)$$

The triple $z^{[2]}, x^{[2]}, y^{[2]}$ provides a solution of the CAE in parametric form; the plot can be seen in Figure 3. Eliminating ξ, η one obtains an implicit formula for the function

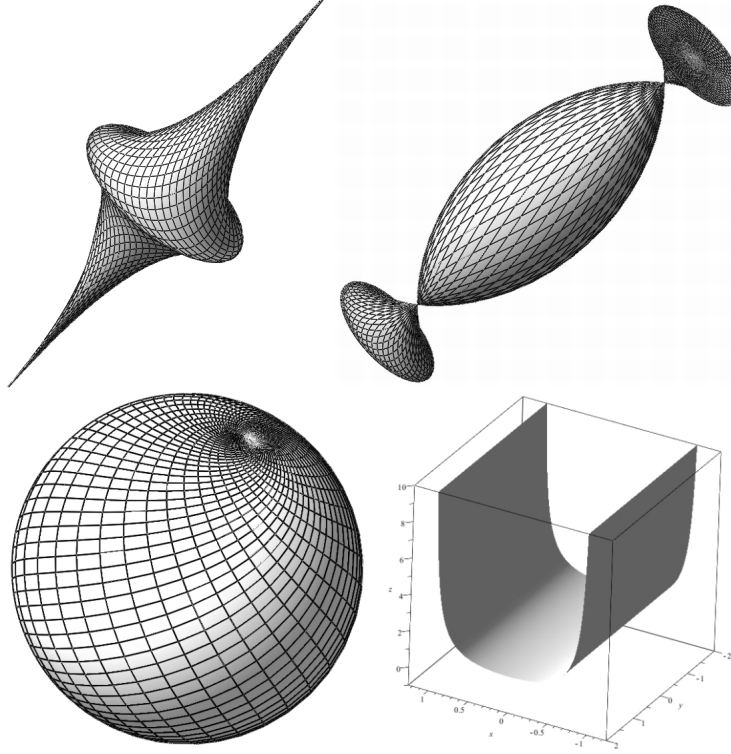

Figure 2. Pseudosphere $\mathbf{r}^{[1]}(\xi, \eta)|_{\lambda_1=1}$ (upper left); von Lilienthal surface $\tilde{\mathbf{r}}^{[1]}(\xi, \eta)$ for $\ln k = 0.3$ (upper right); Gaussian map $\tilde{\mathbf{n}}^{[1]}(\xi, \eta)$ (lower left); solution $z = 1/(1 - x^2)$ of the CAE (lower right).

$z(x, y) = z^{[2]}(x^{[2]}, y^{[2]})$, namely

$$y = 2 \ln a_2 - \frac{\lambda_{12}^{\oplus} \ln a_1}{\lambda_1 \lambda_2} + \frac{2(1 + a_1 a_2)(a_1 - a_2)}{a_1(1 + a_2^2)},$$

where

$$a_1 = \frac{-(x^2 \lambda_{12}^{\ominus 2} - \lambda_1^2 \lambda_2^2)^2 z^2 - 2\lambda_{12}^{+4} (x^2 \lambda_{12}^{-4} - \lambda_1^2 \lambda_2^2) z + 2K \lambda_1 \lambda_2 \lambda_{12}^{+2} \sqrt{z} - \lambda_{12}^{\ominus 4}}{(x \lambda_{12}^{\ominus} + \lambda_1 \lambda_2)^2 (4\lambda_1^2 \lambda_2^2 z^{\frac{3}{2}} + Kz) + 4\lambda_1^2 \lambda_2^2 \lambda_{12}^{\ominus 2} \sqrt{z} + K \lambda_{12}^{\ominus 2}},$$

$$a_2 = \frac{4\lambda_2^2 \lambda_1^2 \sqrt{z} + K}{\lambda_{12}^{\ominus 2} + (x^2 \lambda_{12}^{\ominus 2} - \lambda_1^2 \lambda_2^2) z}, \quad K = 16\lambda_2^4 \lambda_1^4 z - [\lambda_{12}^{\ominus 2} + (x^2 \lambda_{12}^{\ominus 2} - \lambda_1^2 \lambda_2^2) z]^2.$$

Using (24) one obtains the two-soliton pseudospherical surface

$$\mathbf{r}^{[2]} = \frac{4\lambda_{12}^{\ominus}}{\lambda_1^{\oplus} \lambda_2^{\oplus} R_1} \left[\begin{pmatrix} R_2 \\ R_3 \\ 0 \end{pmatrix} \sin \alpha + \begin{pmatrix} R_3 \\ -R_2 \\ 0 \end{pmatrix} \cos \alpha \right] + \begin{pmatrix} 0 \\ 0 \\ \beta + \frac{R_4}{\lambda_1^{\oplus} \lambda_2^{\oplus} R_1} \end{pmatrix},$$

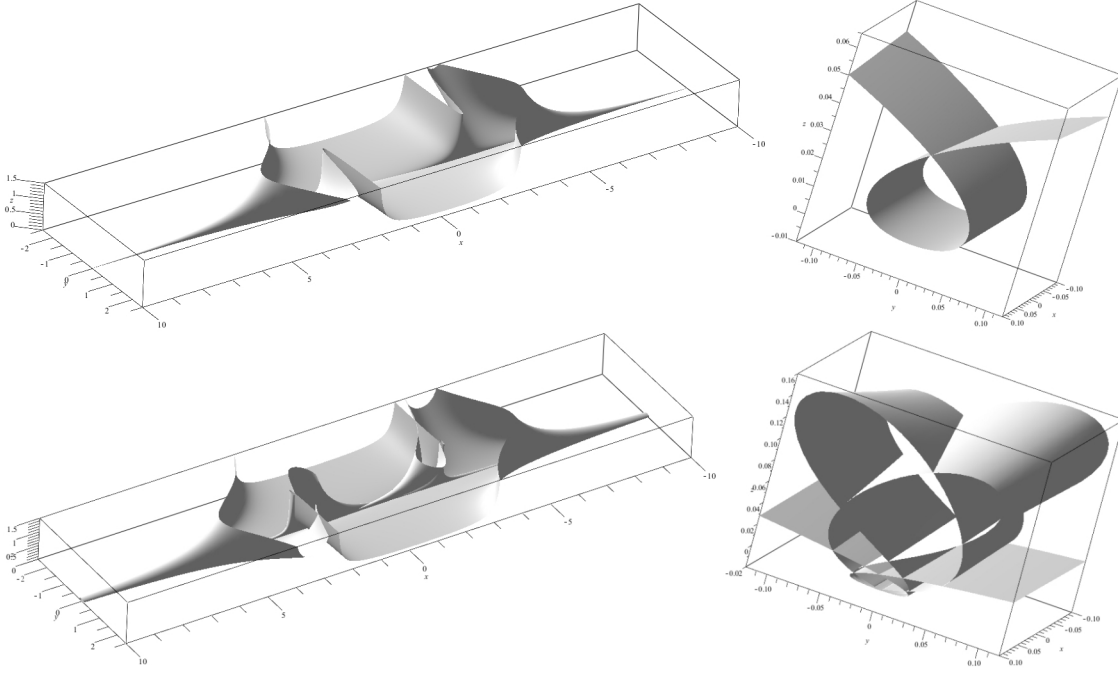

Figure 3. Two soliton solution (top) and three soliton solution (bottom) of the CAE, $\lambda_1 = 1.2$, $\lambda_2 = 1.5$, $\lambda_3 = 1.8$, $c_i = 0$. Right parts of the figures show the behavior around the origin.

where

$$\begin{aligned}
 R_1 &= \lambda_{12}^{+2}(a_1^2 + a_2^2) + \lambda_{12}^{-2}(a_1^2 a_2^2 + 1) - 8\lambda_1 \lambda_2 a_2 a_1, \\
 R_2 &= 2\lambda_1 \lambda_2 (1 + a_1 a_2)(a_1 - a_2), \\
 R_3 &= \lambda_2 \lambda_1^\ominus a_2 (1 + a_1^2) - \lambda_1 \lambda_2^\ominus a_1 (1 + a_2^2), \\
 R_4 &= 2\lambda_{12}^\ominus \lambda_{12}^+ (\lambda_1 \lambda_2 - 1)(a_1^2 - a_2^2) - 2\lambda_{12}^\ominus \lambda_{12}^- (\lambda_1 \lambda_2 + 1)(a_1^2 a_2^2 - 1),
 \end{aligned} \tag{28}$$

for picture see Figure 4. The Gaussian map of corresponding constant astigmatism surface $\tilde{\mathbf{r}}^{[2]}$ is

$$\tilde{\mathbf{n}}^{[2]} = \mathbf{r}^{[2]}|_{\lambda_1=1} - \tilde{\mathbf{r}}^{[1]} = \begin{pmatrix} N_1 \sin \alpha + N_2 \cos \alpha \\ N_2 \sin \alpha - N_1 \cos \alpha \\ N_3 \end{pmatrix},$$

where

$$N_1 = -2 \frac{\lambda_2^\ominus R_2'}{\lambda_2^\oplus R_1'}, \quad N_2 = -2 \frac{\lambda_2^\ominus R_3'}{\lambda_2^\oplus R_1'} - \frac{4a_2 \lambda_2}{\lambda_2^\oplus (a_2^2 + 1)}, \quad N_3 = \frac{R_4'}{2\lambda_2^\oplus R_1'} + \frac{2\lambda_2 (a_2^2 - 1)}{\lambda_2^\oplus (a_2^2 + 1)}.$$

Obviously, R_i' arises from R_i by substituting $\lambda_1 = 1$, namely

$$\begin{aligned}
 R_1' &= \lambda_2^{+2}(a^2 + a_2^2) + \lambda_2^{-2}(a^2 a_2^2 + 1) - 8\lambda_2 a a_2, \\
 R_2' &= 2\lambda_2 (1 + a a_2)(a - a_2), \\
 R_3' &= -\lambda_2^\ominus a (1 + a_2^2), \\
 R_4' &= -2\lambda_2^\ominus \lambda_2^+ (\lambda_2 - 1)(a^2 - a_2^2) - 2\lambda_2^\ominus \lambda_2^- (\lambda_2 + 1)(a^2 a_2^2 - 1).
 \end{aligned} \tag{29}$$

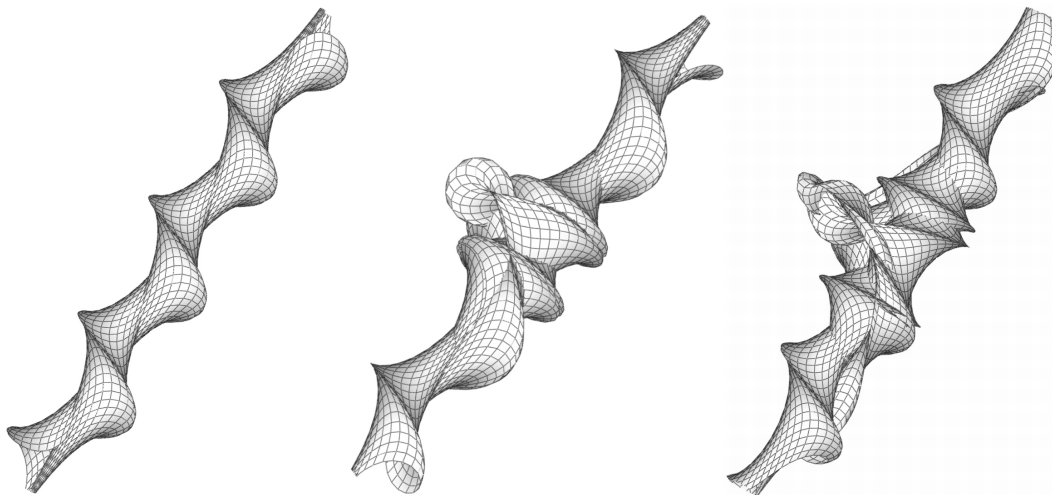

Figure 4. From the left: One-, two- and three-soliton pseudospherical surfaces, $\bar{\mathbf{r}}^{[1]}, \bar{\mathbf{r}}^{[2]}, \bar{\mathbf{r}}^{[3]}$ respectively, $\lambda_1 = 1, \lambda_2 = 1.5, \lambda_3 = 1.8, c_i = 0$.

Recall that $\tilde{\mathbf{n}}^{[2]}(\xi, \eta)$ parameterises the unit sphere by slip lines, for a picture see the left side of Figure 5. One can easily check that in the case when $c_i = 0$, the slip lines net is symmetric with respect to the point $\tilde{\mathbf{n}}^{[2]}(0, 0) = (1, 0, 0)$, i.e. if $\tilde{\mathbf{n}}^{[2]}(\xi, \eta) = (n_x, n_y, n_z)$, then $\tilde{\mathbf{n}}^{[2]}(-\xi, -\eta) = (n_x, -n_y, -n_z)$. In the picture, we observe the sphere from the positive part of the x -axis and the symmetry of the pattern can be clearly recognized. Some parts of the sphere are multiply covered and one can see singularities (envelopes) of slip lines. We leave open the question (suggested by a few numerical calculations) whether coordinate lines $\xi = \text{const}$ and $\eta = \text{const}$ converge to the poles, i.e. points $(0, 0, \pm 1)$.

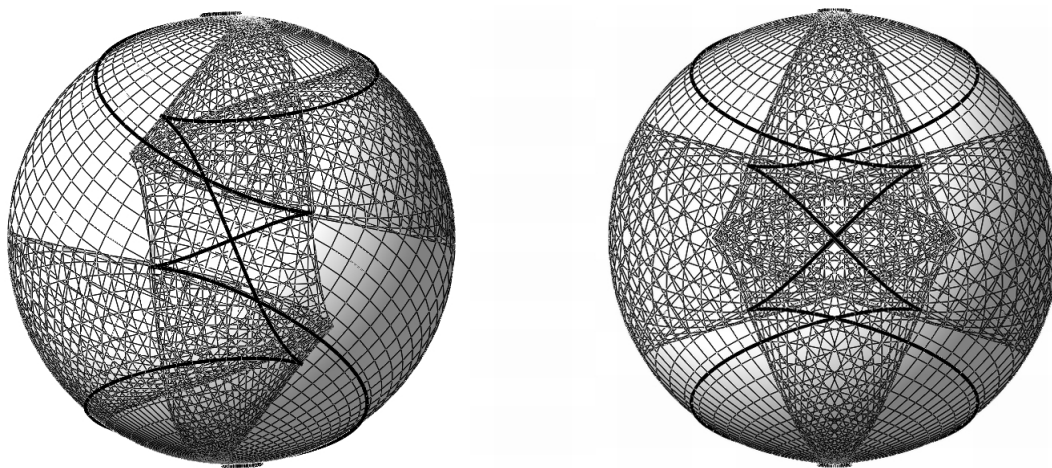

Figure 5. Slip line field $\tilde{\mathbf{n}}^{[2]}$, $\lambda_2 = 1.5, c_i = 0$ (left) and its limit $\tilde{\mathbf{n}}^{\{2\}}$, $c = 0$ (right) with coordinate lines $\xi = 0$ and $\eta = 0$ highlighted (thick black curves).

To obtain an associated orthogonal equiareal pattern one needs to invert the

transformation $(x, y) \leftrightarrow (\xi, \eta)$ given by first two equations in (27), which is not possible in terms of elementary functions. The parameterisation $\tilde{\mathbf{n}}^{[2]}(x, y)$ then would provide orthogonal equiareal net sought.

The corresponding family of two-soliton constant astigmatism surfaces having evolutes $\mathbf{r}^{[2]}|_{\lambda_1=1}$ and a Dini surface $\tilde{\mathbf{r}}^{[1]}$ is then

$$\tilde{\mathbf{r}}^{[2]} = \tilde{\mathbf{r}}^{[1]} - f\tilde{\mathbf{n}}^{[2]} = \begin{pmatrix} \tilde{R}_1 \sin \alpha + \tilde{R}_2 \cos \alpha \\ \tilde{R}_2 \sin \alpha - \tilde{R}_1 \cos \alpha \\ \beta - \tilde{R}_3 \end{pmatrix},$$

where

$$f = \ln(kg^{[2]})|_{\lambda_1=1}, \quad \tilde{R}_1 = 2f \frac{\lambda_2^\ominus R'_2}{\lambda_2^\oplus R'_1}, \quad \tilde{R}_2 = 2f \frac{\lambda_2^\ominus R'_3}{\lambda_2^\oplus R'_1} + \frac{4\lambda_2 a_2}{\lambda_2^\oplus (a_2^2 + 1)} (f + 1),$$

$$\tilde{R}_3 = \frac{1}{2} f \frac{R'_4}{\lambda_2^\oplus R'_1} + \frac{2\lambda_2 (a_2^2 - 1)}{\lambda_2^\oplus (a_2^2 + 1)} (f + 1).$$

A part of the surface can be seen in the left side of Figure 6. One can observe cuspidal edges obviously related to singularities of corresponding slip line field (Figure 5).

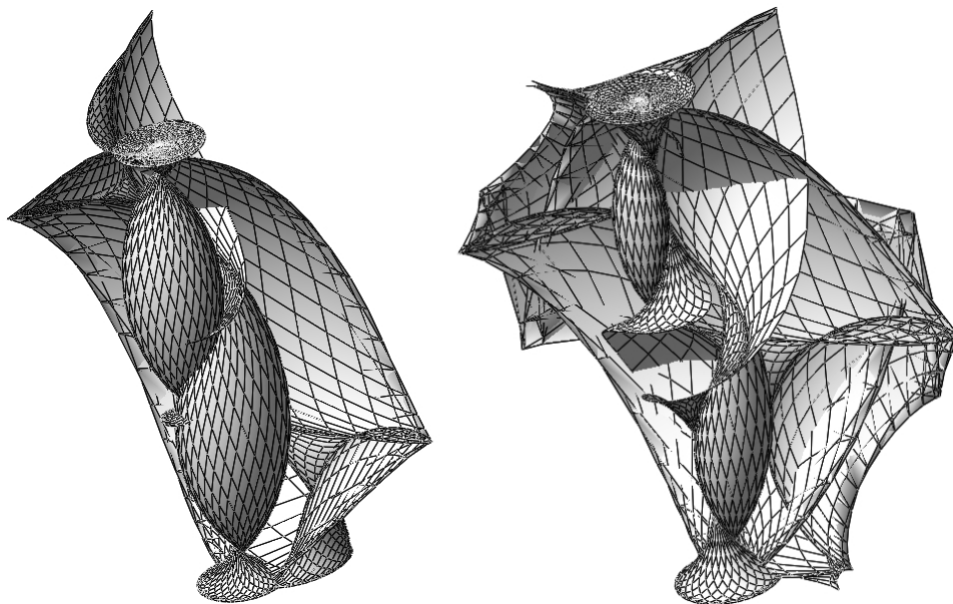

Figure 6. Two soliton surface $\tilde{\mathbf{r}}^{[2]}$ (left) and three soliton surface $\tilde{\mathbf{r}}^{[3]}$ (right) of constant astigmatism, $\lambda_2 = 1.5$, $\lambda_3 = 1.8$, $c_i = 0$, $k = 1$.

5.3. Three-soliton solutions

The 3-soliton solution, $(x^{[3]}, y^{[3]}, g^{[3]})$, of the CAE corresponding to the pair

$$\omega^{[3]} = 2 \arctan \left(\frac{\lambda_{12}^+ \lambda_{13}^+ \lambda_{23}^- a_1 - \lambda_{12}^+ \lambda_{13}^- \lambda_{23}^+ a_2 + \lambda_{12}^- \lambda_{13}^+ \lambda_{23}^+ a_3 + \lambda_{12}^- \lambda_{13}^- \lambda_{23}^- a_1 a_2 a_3}{\lambda_{12}^- \lambda_{13}^+ \lambda_{23}^+ a_1 a_2 - \lambda_{12}^+ \lambda_{13}^- \lambda_{23}^+ a_1 a_3 + \lambda_{12}^+ \lambda_{13}^+ \lambda_{23}^- a_2 a_3 + \lambda_{12}^- \lambda_{13}^- \lambda_{23}^-} \right)$$

and $\bar{\omega}^{[2]}$ can be easily obtained using Proposition 2, explicit formulas being too lengthy to be written here. The graph of the solution $z(x, y) = z^{[3]}(x^{[3]}, y^{[3]})$ can be seen in Figure 3, a multivaluedness of the function z being clearly identified. In the right side of the figure (values of z near the point $(0, 0, 0)$) one can observe that at least eight values of z may correspond to one particular choice of x and y .

Proceeding to the constant astigmatism surface we firstly compute the three-soliton pseudospherical surface (see Figure 4)

$$\mathbf{r}^{[3]} = \mathbf{r}^{[2]} + \frac{2\lambda_3}{\lambda_3^2 + 1} \left(\frac{\sin(\omega^{[2]} - \omega^{[3]})}{\sin 2\omega^{[2]}} \mathbf{r}_\xi^{[2]} + \frac{\sin(\omega^{[2]} + \omega^{[3]})}{\sin 2\omega^{[2]}} \mathbf{r}_\eta^{[2]} \right).$$

The Gaussian map of corresponding constant astigmatism surface is then

$$\tilde{\mathbf{n}}^{[3]} = \mathbf{r}^{[3]}|_{\lambda_1=1} - \bar{\mathbf{r}}^{[2]}$$

forming a net of slip lines, for picture see the left side of Figure 7.

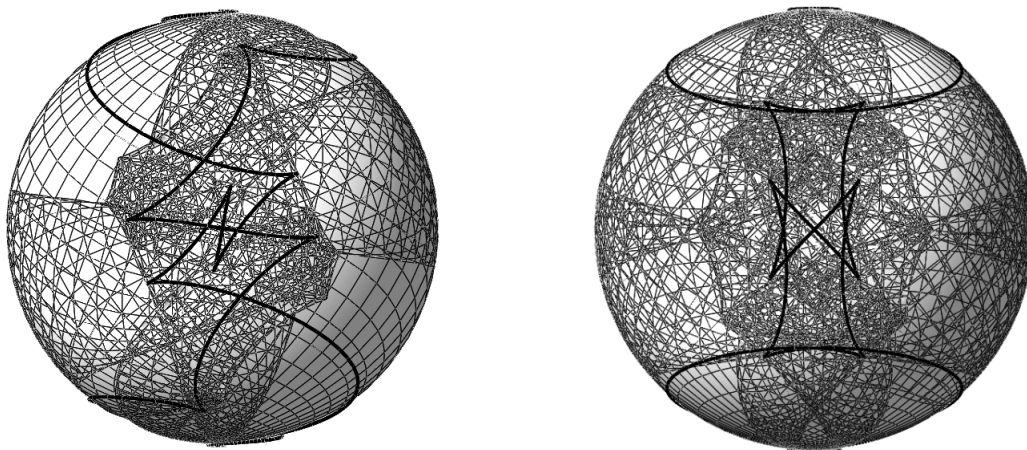

Figure 7. Slip line field $\tilde{\mathbf{n}}^{[3]}$, $\lambda_2 = 1.5$, $\lambda_3 = 1.8$, $c_i = 0$ (left) and its limit $\tilde{\mathbf{n}}^{\{3\}}$, $c = 0$ (right) with coordinate lines $\xi = 0$ and $\eta = 0$ highlighted (thick black curves).

Finally, we construct the family of constant astigmatism surfaces having evolutes $\mathbf{r}^{[3]}|_{\lambda_1=1}$ and $\bar{\mathbf{r}}^{[2]}$. They are

$$\tilde{\mathbf{r}}^{[3]} = \bar{\mathbf{r}}^{[2]} - \tilde{\mathbf{n}}^{[3]} \ln(kg^{[3]})|_{\lambda_1=1},$$

k being a constant. A picture of rather complicated surface can be seen in the right side of Figure 6.

6. Examples of multisoliton solutions with $\lambda = 1$

Computing the limit for $\lambda_i \rightarrow 1$ allows us to iterate the Bäcklund transformation with $\lambda = 1$ and construct solutions of the sine-Gordon equation and corresponding

pseudospherical surfaces. Slip-line fields are also available. However, taking the limit for $(\lambda_1, \lambda_2) \rightarrow (1, 1)$ and $(c_1, c_2) \rightarrow (c, c)$ in (27) yields

$$\lim x^{[2]} = \infty, \quad \lim y^{[2]} = 0, \quad \lim g^{[2]} = \infty.$$

Fortunately, finite limits result when applying the scaling symmetry

$$\mathcal{S}_s(x, y, g) \rightarrow (sx, y/s, sg)$$

of the CAE to the triple $(x^{[2]}, y^{[2]}, g^{[2]})$, the constant s being suitably chosen. In what follows we iterate the Bäcklund transformation with $\lambda = 1$ (the case examined e.g. in [25]) and we find the corresponding solutions of the CAE as the limits of the solutions obtained in previous section.

Let us denote the k -th iteration of the Bäcklund transformation with $\lambda = 1$ by $\omega^{\{k\}}$, according to the diagram

$$\omega^{\{0\}} \xrightarrow{1} \omega^{\{1\}} \xrightarrow{1} \omega^{\{2\}} \xrightarrow{1} \omega^{\{3\}} \xrightarrow{1} \omega^{\{4\}} \xrightarrow{1} \dots$$

The corresponding pseudospherical surface is, obviously, denoted by $\mathbf{r}^{\{k\}}$. We also extend the notation to the solutions of the constant astigmatism equation, i.e. $x^{\{k\}}, y^{\{k\}}, g^{\{k\}}$.

6.1. One-soliton solutions

Starting with the zero solution $\omega^{\{0\}} = 0$, the one-soliton solution of the sine-Gordon equation is

$$\omega^{\{1\}} = 2 \arctan a = 2 \arctan e^{\xi+\eta+c}$$

and the one-soliton pseudospherical surface, $\mathbf{r}^{\{1\}}$, is the pseudosphere (25).

The one-soliton solution of the CAE can be easily found by substituting $\lambda_1 = 1$ into Equations (18) and (19). Actually, since the solution does not depend on λ_1 (it disappears when eliminating parameters ξ, η from (18) and (19)), we obtain precisely the von Lilienthal solution (20).

Corresponding constant astigmatism surfaces are exactly those given by (26).

6.2. Two-soliton solutions

Taking the limit of $\omega^{[2]}$ for $\lambda_i \rightarrow 1$ and $c_i \rightarrow c$ yields

$$\omega^{\{2\}} = 2 \arctan \frac{2a\alpha}{1+a^2} = 2 \arctan \frac{2e^{\xi+\eta+c}(\xi-\eta)}{1+e^{2(\xi+\eta+c)}}.$$

The corresponding two-soliton pseudospherical surface is

$$\mathbf{r}^{\{2\}} = \frac{1}{a^4 + 2(2\alpha^2 + 1)a^2 + 1} \begin{pmatrix} 4a\alpha(1+a^2)\sin\alpha + 4a(1+a^2)\cos\alpha \\ 4a(1+a^2)\sin\alpha - 4a\alpha(1+a^2)\cos\alpha \\ \beta(a^4 + 2(2\alpha^2 + 1)a^2 + 1) - 2(a^4 - 1) \end{pmatrix}$$

and the slip-line field on the constant astigmatism surface's Gaussian sphere is

$$\begin{aligned} \tilde{\mathbf{n}}^{\{2\}} = \mathbf{r}^{\{2\}} - \mathbf{r}^{\{1\}} &= \frac{1}{a^6 + (4\alpha^2 + 3)(a^4 + a^2) + 1} \\ &\times \begin{pmatrix} 4a(a^2 + 1)^2\alpha \sin \alpha + 2a[a^4 + 2(1 - 2\alpha^2)a^2 + 1] \cos \alpha \\ 2a[a^4 + 2(1 - 2\alpha^2)a^2 + 1] \sin \alpha - 4a(a^2 + 1)^2\alpha \cos \alpha \\ (1 - a^2)[a^4 + 2(1 - 2\alpha^2)a^2 + 1] \end{pmatrix}, \end{aligned}$$

see the right side of the Figure 5. The picture indicates some symmetries of the pattern.

Indeed, if $c = 0$ and $\tilde{\mathbf{n}}^{\{2\}}(\xi, \eta) = (n_x, n_y, n_z)$, then

- $\tilde{\mathbf{n}}^{\{2\}}(-\xi, -\eta) = (n_x, -n_y, -n_z)$ (symmetry with respect to the point $\tilde{\mathbf{n}}^{\{2\}}(0, 0) = (1, 0, 0)$),
- $\tilde{\mathbf{n}}^{\{2\}}(\eta, \xi) = (n_x, -n_y, n_z)$ (symmetry with respect to the zero meridian – the image of the line $\xi = \eta$),
- $\tilde{\mathbf{n}}^{\{2\}}(-\eta, -\xi) = (n_x, n_y, -n_z)$ (symmetry with respect to the equator – the image of the line $\xi = -\eta$).

Coordinate lines of the slip line field $\tilde{\mathbf{n}}^{\{2\}}$ converge to the poles, namely

$$\lim_{\xi \rightarrow \pm\infty} \tilde{\mathbf{n}}^{\{2\}} = \lim_{\eta \rightarrow \pm\infty} \tilde{\mathbf{n}}^{\{2\}} = (0, 0, \mp 1).$$

According to the definition of slip lines, the corresponding orthogonal equiareal pattern has the same symmetries and the same limit behavior. Unfortunately, no picture is provided; to do that one has to reparameterise the sphere which requires expressing ξ, η in terms of $x^{\{2\}}, y^{\{2\}}$, i.e. inverting the transformation described by first two equations in (30). Plugging the functions $\xi(x, y), \eta(x, y)$ into $\tilde{\mathbf{n}}^{\{2\}}(\xi, \eta)$ then would provide the orthogonal equiareal net $\tilde{\mathbf{n}}^{\{2\}}(x, y)$.

The two soliton solution $(x^{\{2\}}, y^{\{2\}}, g^{\{2\}})$ of the CAE can be obtained by taking a limit for $\lambda_i \rightarrow 1$ and $c_i \rightarrow c$ of the triple $(x^{[2]}, y^{[2]}, g^{[2]})$ scaled by the factor $s = -(\lambda_2 - \lambda_1)^2$, i.e.

$$(x^{\{2\}}, y^{\{2\}}, g^{\{2\}}) = \lim_{\substack{\lambda_i \rightarrow 1 \\ c_i \rightarrow c}} \mathcal{S}_{-(\lambda_2 - \lambda_1)^2}(x^{[2]}, y^{[2]}, g^{[2]}).$$

We have

$$\begin{aligned} x^{\{2\}} &= \frac{4e^{2(\xi+\eta+c)}(\xi - \eta)}{e^{4(\xi+\eta+c)} + 2[2(\xi - \eta)^2 + 1]e^{2(\xi+\eta+c)} + 1}, \\ y^{\{2\}} &= \frac{e^{2(\xi+\eta+c)}[\xi + \eta - (\xi - \eta)^2 + c] + \xi + \eta + (\xi - \eta)^2 + c}{e^{2(\xi+\eta+c)} + 1}, \\ g^{\{2\}} &= \frac{2e^{\xi+\eta+c}(e^{2(\xi+\eta+c)} + 1)}{e^{4(\xi+\eta+c)} + 2[2(\xi - \eta)^2 + 1]e^{2(\xi+\eta+c)} + 1}. \end{aligned} \tag{30}$$

Then $z^{\{2\}} = 1/g^{\{2\}^2}$ as a function of $x^{\{2\}}, y^{\{2\}}$ is a solution of the CAE. Eliminating parameters ξ, η provides the implicit formula for the function $z = z(x, y) = z^{\{2\}}(x^{\{2\}}, y^{\{2\}})$, namely

$$y = \frac{L^2 - 1}{L^2 + 1} \left(\frac{xz}{zx^2 + 1} \right)^2 - \ln L, \quad L = \frac{zx^2 + 1}{\sqrt{z - (zx^2 + 1)^2} - \sqrt{z}}.$$

Finally, we write down the constant astigmatism surface $\tilde{\mathbf{r}}^{\{2\}}$ having evolutes $\mathbf{r}^{\{1\}}$ and $\mathbf{r}^{\{2\}}$. For brevity, let us denote $\ln(kg^{\{2\}})$ by f . Then

$$\tilde{\mathbf{r}}^{\{2\}} = \mathbf{r}^{\{1\}} - f\tilde{\mathbf{n}}^{\{2\}} = \begin{pmatrix} \tilde{R}_1 \sin \alpha + \tilde{R}_2 \cos \alpha \\ \tilde{R}_2 \sin \alpha - \tilde{R}_1 \cos \alpha \\ \beta + \tilde{R}_3 \end{pmatrix},$$

where

$$\begin{aligned} \tilde{R}_1 &= -\frac{4a(a^2 + 1)f\alpha}{a^4 + 2(2\alpha^2 + 1)a^2 + 1}, \\ \tilde{R}_2 &= -2a \frac{(f - 1)a^4 - 2[2\alpha^2 + (2\alpha^2 - 1)f + 1]a^2 + f - 1}{a^6 + (4\alpha^2 + 3)(a^4 + a^2) + 1}, \\ \tilde{R}_3 &= \frac{(f - 1)a^6 - [(4\alpha^2 - 1)f + 4\alpha^2 + 1](a^4 - a^2) - f + 1}{a^6 + (4\alpha^2 + 3)(a^4 + a^2) + 1}. \end{aligned}$$

The results from this example coincide with ones obtainable using a *reciprocal transformation* for the constant astigmatism equation introduced in [15], albeit the parameterisation of the results is different. For instance, one can observe apparent similarity between the surface $\tilde{\mathbf{r}}^{\{2\}}$ in Figure 8 and the surface [15, Sect. 8, Ex. 5, Fig. 3].

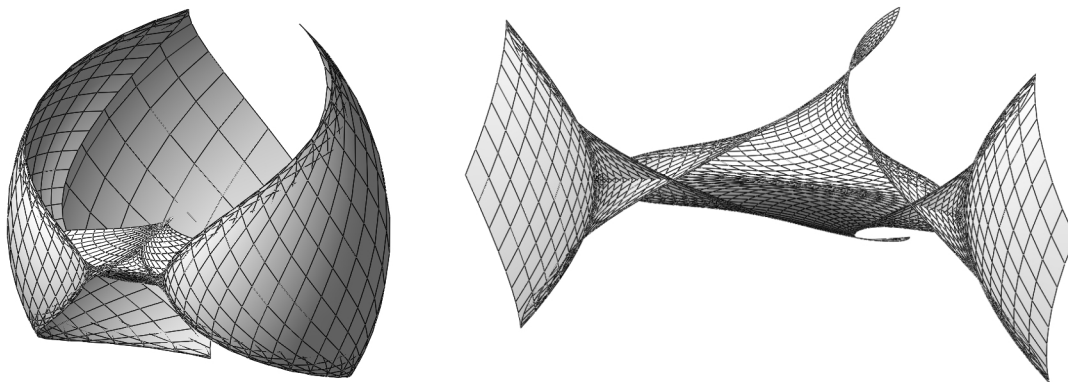

Figure 8. Two soliton surface, $\tilde{\mathbf{r}}^{\{2\}}$, of constant astigmatism, $k = 1, c = 0$. The central part of the surface is zoomed in the right.

6.3. Three-soliton solutions

The limit of $\omega^{\{3\}}$ for $\lambda_i \rightarrow 1$ and $c_i \rightarrow c$ yields

$$\omega^{\{3\}} = 2 \arctan \frac{a(2\alpha^2 + 2\beta + 1) + a^3}{a^2(2\alpha^2 - 2\beta + 1) + 1}$$

or, alternatively [25],

$$\omega^{\{3\}} = -2 \arctan \left(\frac{1}{a} \cdot \frac{\beta + \frac{1}{2} \sinh 2(\beta + c) + \cosh^2(\beta + c) + \alpha^2}{\beta + \frac{1}{2} \sinh 2(\beta + c) - \cosh^2(\beta + c) - \alpha^2} \right).$$

The corresponding three-soliton pseudospherical surface is

$$\mathbf{r}^{\{3\}} = \mathbf{r}^{\{2\}} + \left(\frac{\sin(\omega^{\{2\}} - \omega^{\{3\}})}{\sin 2\omega^{\{2\}}} \mathbf{r}_\xi^{\{2\}} + \frac{\sin(\omega^{\{2\}} + \omega^{\{3\}})}{\sin 2\omega^{\{2\}}} \mathbf{r}_\eta^{\{2\}} \right)$$

and the slip-line field on the constant astigmatism surface's Gaussian sphere is given by

$$\tilde{\mathbf{n}}^{\{3\}} = \mathbf{r}^{\{3\}} - \mathbf{r}^{\{2\}},$$

formulas being too lengthy to be written here, hence omitted. However, the picture can be seen in the right side of Figure 7 and the properties of the pattern (symmetries when $c = 0$ and limits of the coordinate lines for $\xi, \eta \rightarrow \pm\infty$) are exactly same as in the two soliton case from the previous subsection 6.2.

In order to obtain the three soliton solution $(x^{\{3\}}, y^{\{3\}}, g^{\{3\}})$ we rescale the triple $(x^{\{3\}}, y^{\{3\}}, g^{\{3\}})$ by the scaling factor $s = (\lambda_2 - \lambda_1)^2(\lambda_3 - \lambda_1)^2$ and then compute the limit for $\lambda_i \rightarrow 1$ and $c_i \rightarrow c$, i.e.

$$(x^{\{3\}}, y^{\{3\}}, g^{\{3\}}) = \lim_{\substack{\lambda_i \rightarrow 1 \\ c_i \rightarrow c}} \mathcal{S}_{(\lambda_2 - \lambda_1)^2(\lambda_3 - \lambda_1)^2}(x^{\{3\}}, y^{\{3\}}, g^{\{3\}}).$$

The result is

$$\begin{aligned} x^{\{3\}} &= \frac{-4a^2[(\alpha^2 - \beta)a^2 - \alpha^2 - \beta]}{a^6 + [4(\alpha^2 - \beta)^2 + 8\alpha^2 + 3]a^4 + [4(\alpha^2 + \beta)^2 + 8\alpha^2 + 3]a^2 + 1}, \\ y^{\{3\}} &= \frac{2\alpha}{3} \cdot \frac{(\alpha^2 - 3\beta + \frac{3}{2})a^4 - 2(\alpha^4 - \alpha^2 + 3\beta^2 - \frac{3}{2})a^2 + \alpha^2 + 3\beta + \frac{3}{2}}{a^4 + 2(2\alpha^2 + 1)a^2 + 1}, \\ g^{\{3\}} &= \frac{2a[a^4 + 2(2\alpha^2 + 1)a^2 + 1]}{a^6 + [4(\alpha^2 - \beta)^2 + 8\alpha^2 + 3]a^4 + [4(\alpha^2 + \beta)^2 + 8\alpha^2 + 3]a^2 + 1}. \end{aligned}$$

Finally, the constant astigmatism surface $\tilde{\mathbf{r}}^{\{3\}}$, part of which can be seen in Figure 9, is

$$\tilde{\mathbf{r}}^{\{3\}} = \mathbf{r}^{\{2\}} - \ln(kg^{\{3\}})\tilde{\mathbf{n}}^{\{3\}},$$

k being a real constant.

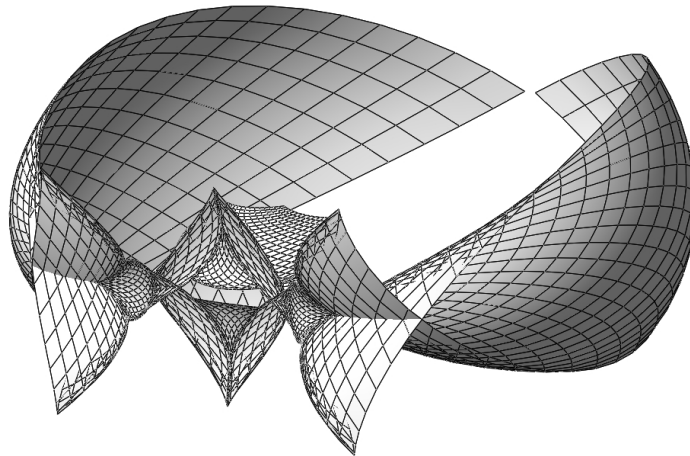

Figure 9. Three soliton surface, $\tilde{\mathbf{r}}^{\{3\}}$, of constant astigmatism, $k = 1$, $c = 0$.

Acknowledgments

The author was supported by Specific Research grant SGS/1/2013 of the Silesian University in Opava and wishes to thank Michal Marvan for his guidance and valuable advice. The author is indebted to Iosif S. Krasil'shchik for reading the manuscript and would also like to thank Petr Blaschke for useful discussions.

7. References

- [1] M.J. Ablowitz, D.J. Kaup, A.C. Newell and H. Segur, Method for Solving the Sine-Gordon Equation, *Phys. Rev. Lett.* **30** (1973) 1262–1264.
- [2] R.L. Anderson and N.H. Ibragimov, *Lie-Bäcklund Transformations in Applications* (SIAM, 1979).
- [3] H. Baran and M. Marvan, On integrability of Weingarten surfaces: a forgotten class, *J. Phys. A: Math. Theor.* **42** (2009) 404007.
- [4] L. Bianchi, Ricerche sulle superficie elicoidali e sulle superficie a curvatura costante, *Ann. Scuola Norm. Sup. Pisa, I* **2** (1879) 285–341.
- [5] L. Bianchi, Sulla trasformazione di Bäcklund per le superficie pseudosferiche, *Rend. Accad. Lincei* **5** (1892) 3–12.
- [6] L. Bianchi, *Lezioni di Geometria Differenziale*, Vol. I (E. Spoerri, Pisa, 1903).
- [7] L. Bianchi, *Lezioni di Geometria Differenziale*, Vol. II (E. Spoerri, Pisa, 1902).
- [8] A.C. Bryan, On representations of the multisoliton solutions of the sine-Gordon equation, *Nonlinear Analysis, Theory, Methods & Applications*, Vol. **12**, No. 10. pp. 1047–1052, 1988
- [9] P.J. Caudrey, J.D. Gibbon, J.C. Eilbeck, R.K. Bullough, Exact multisoliton solutions of the self induced transparency and sine-Gordon equations, *Phys. Rev. Lett.* **30** (1973), 237–239.
- [10] P.J. Caudrey, J.C. Eilbeck, J.D. Gibbon, R.K. Bullough, Multiple soliton and bisoliton bound state solutions of the sine-Gordon equation and related equations in nonlinear optics, *J. Phys. A: Math., Nucl. Gen.* **6** (1973), 112–114.
- [11] P.J. Caudrey, J.C. Eilbeck, J.D. Gibbon, The sine-Gordon equation as a model classical field theory, *Nuovo Cimento*, **25** (1975), 497–512.
- [12] R. Hirota, Exact Solution of the Sine-Gordon Equation for Multiple Collisions of Solitons, *Journ. Phys. Soc. Japan* **33** (1972) 1459–1463.

- [13] A. Hlaváč and M. Marvan, Another integrable case in two-dimensional plasticity, *J. Phys. A: Math. Theor.* **46** (2013) 045203.
- [14] A. Hlaváč and M. Marvan, On Lipschitz solutions of the constant astigmatism equation, *Journal of Geometry and Physics* (2014), 10.1016/j.geomphys.2014.05.020.
- [15] A. Hlaváč and M. Marvan, A reciprocal transformation for the constant astigmatism equation, *SIGMA* **10** (2014), 091
- [16] R. von Lilienthal, Bemerkung über diejenigen Flächen bei denen die Differenz der Hauptkrümmungsradien constant ist, *Acta Mathematica* **11** (1887) 391–394.
- [17] R. Lipschitz, Zur Theorie der krummen Oberflächen, *Acta Math.* **10** (1887) 131–136.
- [18] N. Manganaro and M. Pavlov, The constant astigmatism equation. New exact solution, *J. Phys. A: Math. Theor.* **47** (2014) 075203.
- [19] M. Pavlov and S. Zykov, Lagrangian and Hamiltonian structures for the constant astigmatism equation, *J. Phys. A: Math. Theor.* **46** (2013) 395203.
- [20] R. Prus and A. Sym, Rectilinear congruences and Bäcklund transformations: roots of the soliton theory, in: D. Wójcik and J. Cieśliński, eds., *Nonlinearity & Geometry, Luigi Bianchi Days, Proc. 1st Non-Orthodox School, Warsaw, September 21–28, 1995* (Polish Scientific, Warsaw, 1998) 25–36.
- [21] A. Ribaucour, Note sur les développées des surfaces, *C. R. Acad. Sci. Paris* **74** (1872) 1399–1403.
- [22] C. Rogers and W.K. Schief, *Bäcklund and Darboux Transformations. Geometry and Modern Applications in Soliton Theory* (Cambridge Univ. Press, Cambridge, 2002).
- [23] M.A. Sadowsky, Equiareal pattern of stress trajectories in plane plastic strain, *J. Appl. Mech.* **8** (1941) A-74–A-76.
- [24] M.A. Sadowsky, Equiareal patterns, *Amer. Math. Monthly* **50** (1943) 35–40.
- [25] M.I. Serov and L.M. Blazhko, Nonlocal formulas for the propagation of solutions and the conditional symmetry of the sine-Gordon equation. (Ukrainian) *Ukr. Mat. Visn.* **6** (2009), no. 4, 531–552, 582; translation in *Ukr. Math. Bull.* **6** (2009), no. 4, 527548.