

# Signal Formation in a Detector with one Large Dimension

Manolis Dris

*National Technical University of Athens, Department of Physics,  
9 Heron Polytechniou Street, GR 157 80, Athens, Greece*

June 17, 2021

## Abstract

We present the theory for the signal formation in a multi conductor detector with cylindrical geometry and long length. There exists electromagnetic wave propagation along the large dimension of the detector. The system is equivalent to a multi conductor transmission line. The treatment is in the TEM approximation. Each conductor is fed by its current source which is the same as in the case of small size detectors. A simple example is given for a long length Monitored Drift Tube (MDT). One could apply the result to a long micromegas-type detector or any long microstrip detector, ignoring propagation that is transverse to the strips.

## Contents

<b>1</b>	<b>Signal formation in a detector with cylindrical geometry and long length</b>	<b>1</b>
<b>2</b>	<b>Example: Long cylindrical detector of circular cross-section with a wire along its axis</b>	<b>20</b>
<b>3</b>	<b>Conclusions</b>	<b>21</b>

## 1 Signal formation in a detector with cylindrical geometry and long length

The problem of induced currents on conducting electrodes due to the motion of electrons in between the electrodes' vacuum space, dates back to the 1930's and 1940's . At that time various types of vacuum tube devices were in use and such effects were important at high enough frequencies, when the electron time of flight between the electrodes was comparable to the period of the radiofrequencies involved (see the classic papers by W. Shockley [1] and by S. Ramo [2]). Following similar techniques, the problem of signal formation in particle detectors is analysed in several papers and books, [3, 4, 5, 6, 7]. In all cases, small size detectors is assumed, since electrostatics is used with no electromagnetic wave propagation. There are applications of the above techniques for the case of long length detectors where wave propagation exists along the detector length, as in [8]. As far as we know, no rigorous justification exists for doing so. In this work we give a rigorous proof of what happens for loong length detectors.

The cylindrical geometry of the detector is shown in Fig. 1 and Fig. 2. We will start by examining an ideal detector which consists of many parallel conductors without resistance. The criterion for a material to be a very good conductor, is the relaxation time  $\tau = \epsilon/\sigma$  (i.e. permittivity divided by conductivity) to be much smaller than the periods ( $T = 1/f$ ) of the waves involved. If the opposite is true, then the material behaves more like a dielectric. Between the two extremes one has dielectric materials with conductivity.

First we assume the space between the conductors contains a homogeneous linear dielectric medium whose permittivity does not depend on frequency, i.e.  $\epsilon = \epsilon_r \epsilon_0 = \text{constant}$ . The medium could be a gas. The motion of a charge in the space between the ideal conductors, excites the system and as a result signals are formed and propagate to the ends of the conductors, where they are detected by the external circuits connected. We examine an ideal case without any dielectric "losses". This means there is no any conduction (transverse) current in the dielectric and there are no dielectric polarization losses.

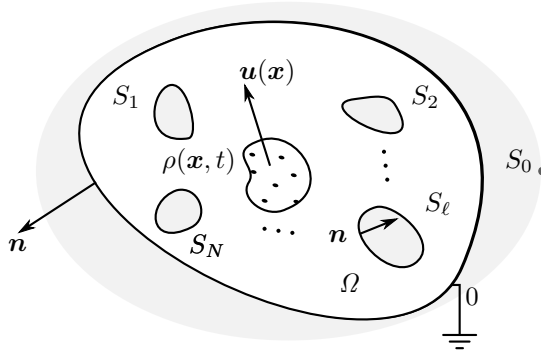

Figure 1: Cross-section of a system of  $N$  internal conductors and one external conductor, forming a long-length detector. The geometry is cylindrical.

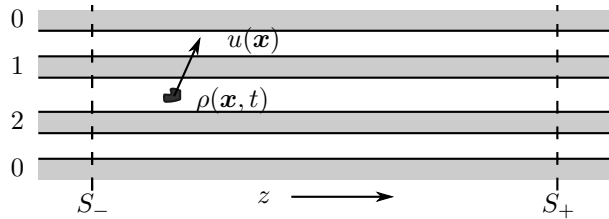

Figure 2: Longitudinal view of a transmission line with many conductors. Only two internal conductors are shown and the external conductor of zero potential. The shaded part shows the inside of the conductors, whereas the part in white is the space where the waves propagate. There is a time-dependent (moving charge) in between conductors.

The transverse dimensions of the detector are small, such that there is no electromagnetic wave propagation in the transverse plane, instead, propagation occurs along the length of the cylindrical detector (the  $z$ -axis). It is assumed that the transverse dimensions are small in comparison to the wavelengths involved in the problem. If one wants to examine even a small width plane detector with long parallel conductors, extending transversely in a large distance, our analysis is not applicable. In that case, there is propagation in both directions of the plane detector.

It is clear that we have to solve the problem of excitation of a multi conductor transmission line by moving charges in between the conductors' space. We will see that it is enough to assume that the conditions for electromagnetic wave propagation of type TEM (Transverse Electromagnetic Waves) apply. In this case, the fields  $\mathbf{E}$ ,  $\mathbf{B}$ ,  $\mathbf{D}$  and  $\mathbf{H}$  are transverse. The TEM waves are also called type-T (Transverse) or EM waves. The transmission line system consists of two or more total number of conductors  $0, 1, 2, \dots, N$ . In the study of excitation of transmission lines (the same is true for wave guides and electromagnetic cavities, but in those last two cases no TEM modes exist), we must take into account all modes of excitation, including the evanescent modes which are not propagating modes. This is necessary when there is interest to calculate the impedance the excitation source "sees". In this case, the stored energy and the energy that returns to the excitation source becomes significant. In practice, the read out of the detector conductor is "far away" from the area of the excitation (position of passage of the particle), meaning at distances of the order of several detector gaps. Note that the evanescent mode strengths decay quickly with distance, so they can be ignored. At the same time the modes with evanescence, TE (or M) and TM (or E), for the usual detectors, have very high thresholds for their cutoff frequencies, with propagation occurring only above these cutoffs. These cutoffs are of the order of tenths of GHz and more. Modeling usual detector signals is accurate enough with the use of much lower frequencies. The TEM modes can describe the detector signals very well. They do not have cutoff frequencies, so in principle, even the very low frequencies are contributing to this type of transmission. The idea of using only TEM propagation is supported from the fact mentioned before, that the wavelengths of the involved waves are much larger than the various transverse dimensions. One additional reason for using only the TEM modes, is that the electronics used are working at much lower frequencies than the above cutoff frequencies. It is worth mentioning that only for the case of the TEM transmission there is a clear meaning to the potential difference between two conductors. There is no such clear meaning for the TE and TM cases.

There exist detectors having, several (instead of one) homogeneous dielectric materials with different permittivities, distributed such that still cylindrical geometry detector is still homogeneous along its length. These are detectors with inhomogeneous media. In addition, the conductors may have significant resistances which influences the system in various ways. In this case our analysis fails. The fields are not exactly transverse, and have longitudinal components along the  $z$  axis. If permittivities are not extremely different, and resistances are not very high, one could apply the quasi-TEM method, where the fields are almost of the TEM type, with small longitudinal components. The quasi-TEM method leads to similar relations like the TEM case, with the difference that several propagation "constants" (propagation coefficients) and so propagation speeds may appear. Sometimes the propagation coefficients and speeds do not differ much from each other, so one could treat the problem as one with a single propagation coefficient and one speed. One could take an average of permittivities and use only one value. The maximum number of propagation coefficients is in general equal to the number of (internal) conductors ( $N$ ), [19].

At this point it should be noted that, even when there are currents in the dielectric, there are exact TEM waves. This is true if the dielectric is homogeneous and the conductors are ideal.

Rossi [3] seems to be the first who examined the behavior of a long length detector. Such detectors are in use in High Energy Physics experiments, e.g. in the ATLAS experiment at CERN [10, 11].

We proceed with the lossless transmission line equivalent of the detector, i.e. conductors with no resistance and dielectric without any "losses", i.e. no conductivity and polarization losses. The conductors,  $N$  internal and the surrounding 0th conductor at zero potential, could be extend from  $z < 0$  to  $z > 0$ . One or both extensions is assumed to be sufficiently large. The surrounding conductor may partially or totally include infinity. We use cartesian coordinates for positions  $\mathbf{x} = (\mathbf{x}_T, z) = (x, y, z)$ . Vectors  $\mathbf{x}_T = (x, y)$  are in the transverse plane, normal to the  $z$ -axis. The infinitesimal area on the transverse plane is  $d^2x = da = dx dy$ . The infinitesimal volume is  $d^3x = dx dy dz$ .

The time-dependent (moving) charge distribution, in the space between the conductors, will excite the system. In what follows we mainly use Jackson, [12]. The other references used are [13, 14]. The following relations

$$\rho = \rho(\mathbf{x}, t), \quad \mathbf{J} = \rho(\mathbf{x}, t)\mathbf{u}(\mathbf{x})$$

We assume that the velocity of the distributed charge is known at each time for every point in space. In general the excitation leads to signals propagating towards both, opposite to each other,  $z$  directions.

Maxwell's equations in space with a dielectric without losses ( $\mathbf{J} = 0$ ,  $\rho = 0$ ), can be written as follows

$$\begin{aligned} \nabla \times \mathbf{H} &= \epsilon \frac{\partial \mathbf{E}}{\partial t}, & \nabla \times \mathbf{E} &= -\mu \frac{\partial \mathbf{H}}{\partial t} \\ \nabla \cdot \mathbf{E} &= 0, & \nabla \cdot \mathbf{H} &= 0, & \mathbf{D} &= \epsilon \mathbf{E}, & \mathbf{B} &= \mu \mathbf{H} \end{aligned} \quad (1)$$

It is understood that the appropriate boundary conditions exist, on the ideal conductors.

Remember that for TEM waves, the fields are transverse to the  $z$  propagating direction, in the between the conductors space.

We Fourier transform the various physical quantities and end up with the quantities called amplitudes, such as  $\mathbf{E}(\mathbf{x}, \omega)$ . This way we reduce the problem to the one frequency case. The following relations hold

$$\begin{aligned} \mathbf{E}(\mathbf{x}, t) &= \frac{1}{2\pi} \int_{-\infty}^{\infty} d\omega \mathbf{E}(\mathbf{x}, \omega) e^{-j\omega t}, & \mathbf{E}(\mathbf{x}, \omega) &= \int_{-\infty}^{+\infty} \mathbf{E}(\mathbf{x}, t) e^{j\omega t} dt \\ \mathbf{H}(\mathbf{x}, t) &= \frac{1}{2\pi} \int_{-\infty}^{\infty} \mathbf{H}(\mathbf{x}, \omega) e^{-j\omega t} d\omega, & \mathbf{H}(\mathbf{x}, \omega) &= \int_{-\infty}^{+\infty} \mathbf{H}(\mathbf{x}, t) e^{j\omega t} dt \\ \rho(\mathbf{x}, t) &= \frac{1}{2\pi} \int_{-\infty}^{\infty} d\omega \rho(\mathbf{x}, \omega) e^{-j\omega t}, & \rho(\mathbf{x}, \omega) &= \int_{-\infty}^{+\infty} \rho(\mathbf{x}, t) e^{j\omega t} dt \\ \mathbf{J}(\mathbf{x}, t) &= \frac{1}{2\pi} \int_{-\infty}^{\infty} \mathbf{J}(\mathbf{x}, \omega) e^{-j\omega t} d\omega, & \mathbf{J}(\mathbf{x}, \omega) &= \int_{-\infty}^{+\infty} \mathbf{J}(\mathbf{x}, t) e^{j\omega t} dt \end{aligned} \quad (2)$$

The continuity relations are

$$\nabla \cdot \mathbf{j}(\mathbf{x}, t) + \frac{\partial \rho(\mathbf{x}, t)}{\partial t} = 0, \quad \nabla \cdot \mathbf{J}(\mathbf{x}, \omega) = j\omega\rho(\mathbf{x}, \omega)$$

Substitution into Maxwell Eqs. (1) yields

$$\begin{aligned} \nabla \times \mathbf{H}(\mathbf{x}, \omega) + j\epsilon\omega\mathbf{E}(\mathbf{x}, \omega) &= 0 \\ \nabla \times \mathbf{E}(\mathbf{x}, \omega) - j\mu\omega\mathbf{H}(\mathbf{x}, \omega) &= 0 \\ \nabla \cdot \mathbf{H}(\mathbf{x}, \omega) &= 0, \quad \nabla \cdot \mathbf{E}(\mathbf{x}, \omega) = 0 \end{aligned}$$

From these we get the wave equations

$$\begin{aligned} \nabla^2 \mathbf{E}(\mathbf{x}, \omega) + \mu\epsilon\omega^2 \mathbf{E}(\mathbf{x}, \omega) &= 0 \\ \nabla^2 \mathbf{H}(\mathbf{x}, \omega) + \mu\epsilon\omega^2 \mathbf{H}(\mathbf{x}, \omega) &= 0 \end{aligned}$$

The geometry is cylindrical with propagation only along the  $z$ -axis, so we assume solutions of the form (3)

$$\begin{aligned} \mathbf{E}(\mathbf{x}, \omega) &= \mathbf{E}_0(\mathbf{x}_T, \omega)e^{(\pm)jkz} \\ \mathbf{H}(\mathbf{x}, \omega) &= \mathbf{H}_0(\mathbf{x}_T, \omega)e^{(\pm)jkz} \\ \mathbf{x}_T &= (x, y) \end{aligned} \tag{3}$$

The plus sign in the exponential, corresponds to a propagation along the positive  $z$ -direction, and the minus sign corresponds to the negative  $z$ -direction. We get relations

$$\begin{aligned} E_z &= 0, \quad H_z = 0 \\ \nabla_T \times \mathbf{E}_0 &= 0, \quad \nabla_T \cdot \mathbf{E}_0 = 0, \quad \nabla_T = \mathbf{e}_x \frac{\partial}{\partial x} + \mathbf{e}_y \frac{\partial}{\partial y} \\ \mathbf{H}_0 &= (\pm) \frac{1}{Z_T} \mathbf{e}_z \times \mathbf{E}_0, \quad Z_T = \sqrt{\frac{\mu}{\epsilon}} = \text{the wave impedance} \\ k &= \omega\sqrt{\mu\epsilon} = \frac{\omega}{c} \approx \omega\sqrt{\mu_0\epsilon_0\epsilon_T}, \quad c = 1/\sqrt{\mu_0\epsilon_0} = \text{speed of light in the medium} \end{aligned} \tag{4}$$

Wavenumber  $k$  coincides with that of the unconfined medium. The speed of light in vacuum is  $c_0 = 1/\sqrt{\mu_0\epsilon_0}$ , so  $c = c_0/\sqrt{\mu_r\epsilon_r} \approx c_0/\sqrt{\mu_0\epsilon_r}$ .

Whenever the  $+$ ,  $-$  signs exist in an expression more than once, the upper signs go together and the down signs go together. Eqs. (4) expresses the known fact for cylindrical geometry, that we have electrostatic relations in two dimensions, in the transverse plane  $(x, y) = \mathbf{x}_T$ . This means that electric field  $\mathbf{E}_0(\mathbf{x}_T)$ , which is transverse, can be determined from the two-dimensional scalar electrostatic potential  $\Phi_0(\mathbf{x}_T)$ , as shown below in Eqs. (5), with the appropriate boundary conditions.

$$\begin{aligned} \mathbf{E}_0(x, y) &= -\nabla_T \Phi_0(x, y) \\ \nabla_T^2 \Phi_0(x, y) &= 0 \end{aligned} \tag{5}$$

Since the conductors are ideal (with no resistance), the electric field, in the outside the conductors space, is normal to the conductor surfaces and the magnetic field intensity outside each conductor and very close to it, is parallel to the conductor surface. It should be noted that, in practice, the materials used are non-magnetic, so  $\mu_r \approx 1$ .

Maxwell's equations with the appropriate boundary conditions, for the transmission lines, define a problem of eigenvalues. The eigensolutions of the problem are the normal modes of transmission, and constitute a complete set of solutions. All the modes (TE, TM, TEM) exist in the case of the transmission lines. So in the case of our detectors all modes contribute. Any electromagnetic field inside the detector, of one frequency, with the correct boundary

conditions, can be represented as a sum of the above complete set of solutions with appropriate coefficients. This is the method used for the description of the excitation of wave guides and electromagnetic cavities where no TEM modes exist, [12, 13, 14]. We will make use of this method, for the excitation of transmission lines from the motion of a charge distribution, adapting it for our case where the TEM mode exists and it is the only one. This means we will use only the eigensolutions TEM, not the complete set. We have to solve the two dimensional Laplace equation for the potential, with the appropriate boundary conditions. The equation is the second from relations (5). The solution is  $\Phi_0(x, y)$  which on the surface of each one conductor,  $\lambda$ , will have potential  $V_\lambda$ . Let us consider a cylindrical three dimensional space with cross section as in Fig.1 and small height  $\Delta z$ . This space is part of the cylindrical space of large height. We will consider that symbols  $\Omega, S_0, S_1, S_2, \dots, S_N$  in Fig. 1 are referring to this small cylindrical space. The small cylindrical space  $\Omega$  is enclosed by part of the cylindrical surfaces of all the conductors, and two imaginary plane surfaces normal to the  $z$  axis, with the between them distance (height of the small cylinder)  $\Delta z$ . As we said before for TEM mode transmission, the problem for the transverse directions is reduced to an electrostatic problem. We will see later on that application of the Gauss theorem etc, one concludes that between the (electrostatic) potentials  $V_\lambda$  for conductors  $\lambda = 1, 2, \dots, N$  and the corresponding charges  $Q_\lambda$ , the following relations hold

$$\begin{aligned}
Q_j &= \sum_{\lambda=1}^N Q_{j\lambda} = \sum_{\lambda=1}^N c_{j\lambda} V_\lambda, \quad j = 1, \dots, N \\
c_{j\lambda} &= c_{j\lambda} \leq 0 \quad \forall j \neq \lambda, \quad c_{jj} \geq 0 \\
U &= \frac{1}{2} \sum_{i,j=1}^N c_{ij} V_i V_j
\end{aligned} \tag{6}$$

$c_{j\lambda}$  is defined by  $c_{j\lambda} = Q_{j\lambda}/V_\lambda$ .  $Q_{j\lambda}$  is the induced charge on conductor  $j$  when only conductor  $\lambda$  has non zero potential equal to  $V_\lambda$  while all other conductors have zero potential.  $U$  is the electrostatic energy of the system. From these relations, dividing by the height  $\Delta x$ , we find the per unit length corresponding quantities. We will not change symbols, we will consider that the appropriate quantities in Eqs. (6) are per unit length. We remind that for this calculation there is not charge in the space in between the conductors.  $c_{jl}$  are the coefficients of electrostatic induction per unit length, another name is short circuit capacitances per unit length.  $V_\lambda$  are the electrostatic potentials of the various conductors with respect to the reference conductor (zero potential)  $S_0$ . Coefficients  $c_{jl}$  are related to the more usual coefficients  $C_{jl}$  appearing in electrical circuits, which are called capacitances with two terminals, per unit length, or simply capacitances per unit length. Capacitances with two terminals constitute the respective matrix  $[C]$ . These last coefficients are related to the potential differences between the nodes and for this reason lead to equivalent electric circuits with capacitances connected between the various nodes, making the problem easy to solve with the known methods for electrical circuits. All above capacitances are the ones used in the description of multi conductor transmission lines, see the various references from [15] to [22]. We have

$$\begin{aligned}
Q_j &= C_{jj} V_j + \sum_{l=1}^N C_{jl} (V_j - V_l), \quad j = 1, \dots, N \\
C_{jl} &= C_{lj} = -c_{lj} = -c_{jl} \geq 0 \quad \forall j \neq l, \quad C_{ll} = \sum_{j=1}^N c_{lj} \geq 0 \\
c_{ii} &= \sum_{k=1}^N C_{ik}, \quad c_{ij} = -C_{ij} \quad \forall i \neq j
\end{aligned}$$

We can invert the first of Eqs. (6) and end up with

$$\begin{aligned}
V_j &= \sum_{l=1}^N p_{jl} Q_l, \quad j = 1, \dots, N \\
p_{jl} &= p_{lj} \geq 0, \quad p_{jj} \geq p_{il} \\
U &= \frac{1}{2} \sum_{i,j=1}^N p_{ij} Q_i Q_j
\end{aligned}$$

$U$  is the electrostatic energy per unit length of the system.

Coefficients  $p_{ij}$  are called (Maxwell) potential coefficients per unit length. Let  $[c]$  be the (NxN) matrix of coefficients  $c_{ij}$  and  $[P]$  be the (NxN) matrix of  $p_{ij}$ , we then have

$$[c] = [p]^{-1}, \quad [p] = [c]^{-1}, \quad [c][p] = [E_u]$$

If we have  $N$  (internal) conductors, as shown in Fig. 1, to solve the problem of signal formation, we will proceed as follows.

We imagine that only one conductor,  $\lambda$ , has potential  $V_\lambda \neq 0$ , while all the rest have zero potential. We solve the  $N$  electrostatic problems and determine the respective potentials  $\Phi_{0\lambda}(x, y)$ . It is clear that in the case the conductors, simultaneously have potentials  $V_\lambda$ ,  $\lambda = 1, 2, \dots, N$ , respectively, we will have  $\Phi_0(x, y) = \sum_{\lambda=1}^N \Phi_{0\lambda}(x, y)$ . For the electric eigenfield  $\mathbf{E}_{0\lambda}(x, y)$  we have

$$\begin{aligned}
\mathbf{E}_{0\lambda}(x, y) &= -\nabla \Phi_{0\lambda}(x, y) \\
\mathbf{E}_0(x, y) &= -\nabla \Phi_0(x, y) = \sum_{\lambda=1}^N \mathbf{E}_{0\lambda}(x, y)
\end{aligned}$$

The eigenfields  $\mathbf{E}_{0\lambda}(x, y)$  are taken to be real. For their values in every point in the between the conductors space, and for one frequency, we have the relations:

$$\begin{aligned}
\mathbf{E}_{0\lambda}(\mathbf{x}_T) &= e^{(\pm)jkz} \mathbf{E}_{0\lambda}(\mathbf{x}_T) \\
\mathbf{H}_{0\lambda}^\pm(\mathbf{x}_T) &= \mp e^{(\pm)jkz} \\
\mathbf{H}_{0\lambda}(\mathbf{x}_T) &= \mp \frac{1}{Z_T} \mathbf{e}_z \times \mathbf{E}_{0\lambda}(\mathbf{x}_T), \quad k = \frac{\omega}{c}
\end{aligned} \tag{7}$$

The "intensities" of the electric and magnetic field for any propagating electromagnetic wave, will depend on the above eigenfields. We have

$$\begin{aligned}
\mathbf{E}^{(\pm)}(\mathbf{x}, \omega) &= \sum_{\lambda=1}^N A_\lambda^{(\pm)}(\omega) \mathbf{E}_{0\lambda}^{(\pm)}(\mathbf{x}_T, z) = \sum_{\lambda=1}^N A_\lambda^{(\pm)}(\omega) \mathbf{E}_{0\lambda}(\mathbf{x}_T) e^{(\pm)jkz} \\
\mathbf{H}^{(\pm)}(\mathbf{x}, \omega) &= \sum_{\lambda=1}^N A_\lambda^{(\pm)}(\omega) \mathbf{H}_{0\lambda}^{(\pm)}(\mathbf{x}_T, z) = \mp \sum_{\lambda=1}^N A_\lambda^{(\pm)}(\omega) \mathbf{H}_{0\lambda}(\mathbf{x}_T) e^{(\pm)jkz} \\
&= \mp \frac{1}{Z_T} \mathbf{e}_z \times \mathbf{E}^{(\pm)}(\mathbf{x}, \omega), \quad k = \frac{\omega}{c}
\end{aligned} \tag{8}$$

In general,

$$\mathbf{E}(\mathbf{x}, \omega) = \mathbf{E}^{(+)}(\mathbf{x}, \omega) + \mathbf{E}^{(-)}(\mathbf{x}, \omega) \quad \text{and} \quad \mathbf{H}(\mathbf{x}, \omega) = \mathbf{H}^{(+)}(\mathbf{x}, \omega) + \mathbf{H}^{(-)}(\mathbf{x}, \omega)$$

Finding coefficients  $A_\lambda^{(\pm)}(\omega)$  determines the fields at any point in the space we are interested in.

It can be proven that, if the fields are known in any plane normal to the  $z$ -axis, this determines completely the two coefficients, so the fields can be found at anyone point. We select as a transverse plane, the one at  $z = 0$ .

Let us assume that the transmission line is excited by a localized source, as shown in Figs 1 and 2. We use the divergence theorem and we get the following relations for the potentials and the eigenfields

$$\begin{aligned}
\nabla \cdot (\Phi_{0\lambda} \nabla \Phi_{0\lambda'}) &= \nabla \Phi_{0\lambda} \cdot \nabla \Phi_{0\lambda'} + \Phi_{0\lambda} \cdot \nabla^2 \Phi_{0\lambda'}, \quad \nabla^2 \Phi_{0\lambda'} = 0 \\
\int_{\Omega} \mathbf{E}_{0\lambda} \cdot \mathbf{E}_{0\lambda'} d^3x &= \int_{\Omega} \nabla \Phi_{0\lambda} \cdot \nabla \Phi_{0\lambda'} d^3x = \int_{\Omega} \nabla \cdot (\Phi_{0\lambda} \nabla \Phi_{0\lambda'}) d^3x \\
\Delta z \int_S \mathbf{E}_{0\lambda} \cdot \mathbf{E}_{0\lambda'} da &= \sum_{m=1}^N \int_{S_m} \Phi_{0\lambda} \nabla \Phi_{0\lambda'} \cdot \mathbf{e}_z da = V_{\lambda} \int_{S_{\lambda}} \nabla \Phi_{0\lambda'} \cdot \mathbf{e}_z da \\
&= -V_{\lambda} \int_{S_{\lambda}} \frac{\sigma_{\lambda\lambda'}}{\epsilon} da = -\frac{1}{\epsilon} V_{\lambda} Q_{\lambda\lambda'} = -\frac{1}{\epsilon} V_{\lambda} c_{\lambda\lambda'} V_{\lambda'} \\
\int_S \mathbf{E}_{0\lambda} \cdot \mathbf{E}_{0\lambda'} da &= \frac{1}{\epsilon} \frac{c_{\lambda\lambda'}}{\Delta z} V_{\lambda} V_{\lambda'}, \quad \lambda, \lambda' = 1, 2, \dots, N
\end{aligned} \tag{9}$$

hence,

$$\begin{aligned}
\int_S \mathbf{H}_{0\lambda} \cdot \mathbf{H}_{0\lambda'} da &= \frac{1}{Z_T^2 \epsilon} \frac{c_{\lambda\lambda'}}{\Delta z} V_{\lambda} V_{\lambda'} \\
\int_S (\mathbf{E}_{0\lambda} \times \mathbf{H}_{0\lambda'}) \cdot \mathbf{e}_z da &= \frac{1}{Z_T \epsilon} \frac{c_{\lambda\lambda'}}{\Delta z} V_{\lambda} V_{\lambda'}
\end{aligned}$$

Remember, we use symbol  $c_{ij}$  for the capacity per unit length coefficients, i.e.  $c_{ij}/\Delta z \rightarrow c_{ij}$ . We have  $c_{\lambda\lambda'} = Q_{\lambda\lambda'}/V_{\lambda'}$ .  $Q_{\lambda\lambda'}$  is the charge induced on conductor  $\lambda$  when only conductor  $\lambda'$  has a non zero potential  $V_{\lambda'}$ , while all other conductors have zero potentials.

In Fig. 2, outside the source, on the right of the plane surface  $S_+$  that is normal to the  $z$ -axis in position  $z = z_+$ , fields  $\mathbf{E}$ ,  $\mathbf{H}$  are given, following Eqs. (8), from

$$\begin{aligned}
\mathbf{E} &= \mathbf{E}^{(+)}(\mathbf{x}, \omega) = \sum_{\lambda=1}^N A_{\lambda}^{(+)}(\omega) \mathbf{E}_{0\lambda}(\mathbf{x}_T) e^{(+j)kz} \\
\mathbf{H} &= \mathbf{H}^{(+)}(\mathbf{x}, \omega) = \sum_{\lambda=1}^N A_{\lambda}^{(+)}(\omega) \mathbf{H}_{0\lambda}(\mathbf{x}_T) e^{(+j)kz}
\end{aligned}$$

On the left of the respective surface  $S_-$  ( $z = z_-$ ), fields  $\mathbf{E}$  are given, again following Eqs. (8), from

$$\begin{aligned}
\mathbf{E} &= \mathbf{E}^{(-)}(\mathbf{x}, \omega) = \sum_{\lambda=1}^N A_{\lambda}^{(-)}(\omega) \mathbf{E}_{0\lambda}(\mathbf{x}_T) e^{(-)jkz} \\
\mathbf{H} &= \mathbf{H}^{(-)}(\mathbf{x}, \omega) = - \sum_{\lambda=1}^N A_{\lambda}^{(-)}(\omega) \mathbf{H}_{0\lambda}(\mathbf{x}_T) e^{(-)jkz}
\end{aligned} \tag{10}$$

As mentioned above, we follow a similar procedure as in references, [12, 13, 14]. We make the needed modifications, because in our case we have only TEM propagation. We take care of the fact that the eigenfunctions are not orthogonal, see Eq. (9). We use the Lorentz reciprocity theorem, [13], which we write for the ‘‘real’’ state with quantities  $\mathbf{E}(\mathbf{x}, \omega)$ ,  $\mathbf{H}(\mathbf{x}, \omega)$ ,  $\mathbf{J}(\mathbf{x}, \omega)$  and for each one of the eigenstates  $\mathbf{E}_{\lambda}^{(\pm)}(\mathbf{x}, \omega)$ ,  $\mathbf{H}_{\lambda}^{(\pm)}(\mathbf{x}, \omega)$ ,  $\mathbf{J}(\mathbf{x}, \omega) = 0$ ,  $\lambda = 1, 2, \dots, N$ . We get

$$\int_S (\mathbf{E} \times \mathbf{H}_{\lambda}^{(\pm)} - \mathbf{E}_{\lambda}^{(\pm)} \times \mathbf{H}) \cdot \mathbf{n} da = \int_{\Omega} (\mathbf{J} \cdot \mathbf{E}_{\lambda}^{(\pm)}) d^3x, \quad \lambda = 1, 2, \dots, N$$

Fields  $\mathbf{E}(\mathbf{x}, \omega)$ ,  $\mathbf{H}(\mathbf{x}, \omega)$  come from the excitation of current  $\mathbf{J}(\mathbf{x}, \omega)$ .  $\mathbf{E}_{\lambda}^{(\pm)}(\mathbf{x}, \omega)$ ,  $\mathbf{H}_{\lambda}^{(\pm)}(\mathbf{x}, \omega)$  are the TEM-type eigenfields propagating along the positive and negative  $z$ -directions, index  $\lambda$  characterizes the propagating field when only conductor  $\lambda$  has a non-zero potential while all the rest have zero potential. The  $\Omega$  space is the space between

conductors (multiply connected), surrounded by external conductor  $S_0$  and the two imaginary plane surfaces  $S_+, S_-$ , Fig. 2; this is the space that contains all the time the (localized) field sources.

Since we have ideal conductors, the electric field is normal to their surfaces, thus the surface integral on the cylindrical part of surface  $S$  is zero, so only the integrals on the two flat surfaces need to be found. We have

$$\int_{\Omega} (\mathbf{J} \cdot \mathbf{E}_{\lambda}^{(\pm)}) d^3x = \int_{S_+} (\mathbf{E} \times \mathbf{H}_{\lambda}^{(\pm)} - \mathbf{E}_{\lambda}^{(\pm)} \times \mathbf{H}) \cdot \mathbf{n} da + \int_{S_-} (\mathbf{E} \times \mathbf{H}_{\lambda}^{(\pm)} - \mathbf{E}_{\lambda}^{(\pm)} \times \mathbf{H}) \cdot \mathbf{n} da \quad (11)$$

Field  $\mathbf{E}$  is a result of excitation in the transmission line space between surfaces  $S_-$  and  $S_+$ . This means that on the side of surface  $S_+$ ,  $\mathbf{E}$  we will propagate along the positive  $z$ -direction, while on the side of  $S_-$  along the negative  $z$ -direction.

We choose to work with the minus signs in Eqs. (11). In addition, using Eqs. (10), we find that the last surface integral is zero, i.e.  $\int_{S_-} \dots = 0$ . Thus, according to Eqs. (7) we have  $\mathbf{H}_{0\lambda} = \mp(1/Z_T)\mathbf{e}_z \times \mathbf{E}_{0\lambda}$ . The identity  $\mathbf{a} \times (\mathbf{b} \times \mathbf{c}) = (\mathbf{a} \cdot \mathbf{c})\mathbf{b} - (\mathbf{a} \cdot \mathbf{b})\mathbf{c}$  holds, so we find

$$\int_{\Omega} (\mathbf{J} \cdot \mathbf{E}_{\lambda}^{(-)}) d^3x = -\frac{2}{Z_T} \sum_{\lambda'=1}^N A_{\lambda'} \int_{S_+} (\mathbf{E}_{0\lambda} \cdot \mathbf{E}_{0\lambda'}) da, \quad \lambda = 1, 2, \dots, N$$

Using Eqs. (7) we finally get (12)

$$\int_{\Omega} (\mathbf{J} \cdot \mathbf{E}_{\lambda}^{(-)}/V_{\lambda}) d^3x = -\frac{2}{Z_T \epsilon} \sum_{\lambda'=1}^N A_{\lambda'}^{(+)} V_{\lambda'} c_{\lambda'\lambda}, \quad \lambda = 1, 2, \dots, N \quad (12)$$

Similar results hold for the plus sign in Eq. (9). At the end, we arrive at

$$\int_{\Omega} (\mathbf{J} \cdot \mathbf{E}_{\lambda}^{(\mp)}/V_{\lambda}) d^3x = -\frac{2}{Z_T} \sum_{\lambda'=1}^N A_{\lambda'}^{(\pm)} V_{\lambda'} c_{\lambda'\lambda}, \quad \lambda = 1, 2, \dots, N \quad (13)$$

From Eqs. (10) we can find the potential of conductor  $\lambda$  with respect to the reference conductor 0, by integrating the electric field intensity along an arbitrary path on the plane with constant  $z$ , from an arbitrary point of the surface of conductor  $\lambda$  to an arbitrary point on the reference conductor. The value of the voltage for conductor  $\lambda$  is

$$v_{\lambda}^{(\pm)}(z, \omega) = \int_{\lambda}^0 \mathbf{E}^{(\pm)}(\mathbf{x}, \omega) d\mathbf{r} = e^{(\pm)jkz} \sum_{\lambda'=1}^N A_{\lambda'}^{(\pm)} \int_{\lambda}^0 \mathbf{E}_{0\lambda'}(\mathbf{x}_T) \cdot d\mathbf{r} = e^{(\pm)jkz} A_{\lambda}^{(\pm)} V_{\lambda} \quad (14)$$

We multiply Eq. (13) with  $e^{(\pm)jkz} = e^{(\pm)j\omega z/c}$  and, by using Eq. (14) we get

$$\begin{aligned} e^{(\pm)jkz} \int_{\Omega} (\mathbf{J} \cdot \mathbf{E}_{\lambda}^{(\pm)}/V_{\lambda}) d^3x &= -\frac{2}{Z_T \epsilon} e^{(\pm)jkz} \sum_{\lambda'=1}^N A_{\lambda'}^{(\pm)} V_{\lambda'} c_{\lambda'\lambda} \\ &= -\frac{2}{Z_T \epsilon} \sum_{\lambda'=1}^N v_{\lambda'}^{(\pm)}(z, \omega) c_{\lambda'\lambda}, \quad \lambda = 1, 2, \dots, N \quad (15) \\ Z_T \epsilon &= \frac{1}{c} \end{aligned}$$

We proceed to the final solution of the signal formation problem. We take the inverse Fourier transform on both members of Eqs. (15). We end up with relations for the potentials of the conductors, functions of  $z, t$ . We use Eq. (2) and we get



$$\begin{aligned}
& \frac{1}{2\pi} \int_{-\infty}^{+\infty} \left[ e^{-j\omega t} \left( e^{(\pm)j\omega z/c} \int_{\Omega} \left( \mathbf{J}(\mathbf{x}', \omega) \cdot \mathbf{E}_{\lambda}^{(\mp)}(\mathbf{x}', \omega)/V_{\lambda} \right) d^3x' \right) d\omega \right] = \\
& = -2c \sum_{\lambda'=1}^N c_{\lambda'\lambda} \frac{1}{2\pi} \int_{-\infty}^{+\infty} e^{-j\omega t} v_{\lambda'}^{(\pm)}(z, \omega) d\omega \\
& = -2c \sum_{\lambda'=1}^N c_{\lambda'\lambda} v_{\lambda'}^{(\pm)}(z, t), \quad \lambda = 1, 2, \dots, N
\end{aligned}$$

The first member becomes

$$\begin{aligned}
& \frac{1}{2\pi} \int_{-\infty}^{+\infty} \left[ e^{-j\omega t} \left( e^{(\pm)j\omega z/c} \int_{\Omega} e^{(\mp)j\omega z'/c} \left( \mathbf{J}(\mathbf{x}', \omega) \cdot \mathbf{E}_{0\lambda}(\mathbf{x}'_{\text{T}})/V_{\lambda} \right) d^3x' \right) d\omega \right] \\
& = \int_{\Omega} \left[ \left( \mathbf{E}_{0\lambda}(\mathbf{x}'_{\text{T}})/V_{\lambda} \right) \cdot \left( \frac{1}{2\pi} \int_{-\infty}^{+\infty} \mathbf{J}(\mathbf{x}', \omega) e^{-j\omega \left( t \mp \frac{z-z'}{c} \right)} d\omega \right) \right] d^3x' \\
& = \int_{\Omega} \left( \mathbf{E}_{0\lambda}(\mathbf{x}'_{\text{T}})/V_{\lambda} \right) \cdot \mathbf{J} \left( \mathbf{x}', t \mp \frac{z-z'}{c} \right) d^3x'
\end{aligned}$$

Finally we get

$$\frac{-1}{2} \int_{\Omega} \left( \mathbf{E}_{0\lambda}(\mathbf{x}'_{\text{T}})/V_{\lambda} \right) \cdot \mathbf{J} \left( \mathbf{x}', t \mp \frac{z-z'}{c} \right) d^3x' = c \sum_{\lambda'=1}^N c_{\lambda'\lambda} v_{\lambda'}^{(\pm)}(z, t), \quad \lambda = 1, 2, \dots, N$$

Since  $\mathbf{E}_{\lambda}$  is transverse, evidently only the transverse current density  $\mathbf{J}_{\text{T}}$  contributes to the signal formation. More precisely, it is the projection of  $\mathbf{J}_{\text{T}}$  on  $\mathbf{E}_{\lambda}$ 's direction that contributes, so we get

$$\frac{-1}{2} \int_{\Omega} \left( \mathbf{E}_{0\lambda}(\mathbf{x}'_{\text{T}})/V_{\lambda} \right) \cdot \mathbf{J}_{\text{T}} \left( \mathbf{x}', t \mp \frac{z-z'}{c} \right) d^3x' = c \sum_{\lambda'=1}^N c_{\lambda'\lambda} v_{\lambda'}^{(\pm)}(z, t), \quad \lambda = 1, 2, \dots, N \quad (16)$$

If needed, we can translate the origin of time such that  $t \rightarrow t - t_0$ . This means that excitation starts not at  $t = 0$  but at  $t = t_0$ .

The direction of  $\mathbf{J}_{\text{T}}$  depends on magnetic field that might be present, so the value of the integral will be affected by the magnetic field.

At this point we are going to study the case of a moving point charge.

We assume that we know the travel path of the point charge as a function of time and its velocity as a function of its position,  $\mathbf{x} = \mathbf{x}_q(t)$ ,  $\mathbf{u} = \mathbf{u}(\mathbf{x}_q) = \mathbf{u}(\mathbf{x}_q) = (u_x(\mathbf{x}_q), u_y(\mathbf{x}_q), u_z(\mathbf{x}_q))$ . We also assume that we can express the two position coordinates of the point charge as a function of one of the two transverse ones, let that be  $x_q$ . Index  $q$  denotes that the respective quantity refers to the moving point charge.

The charge and current densities are given by (17)

$$\begin{aligned}
\rho &= \rho(\mathbf{x}', t) = q\delta(\mathbf{x}' - \mathbf{x}_q(t)) \\
\mathbf{J} &= (J_x, J_y, J_z) = \rho\mathbf{u} = q\delta(\mathbf{x}' - \mathbf{x}_q(t)) \mathbf{u}(\mathbf{x}_q(t)) \\
\mathbf{J}_{\text{T}} &= (J_x, J_y) = q\delta(\mathbf{x}' - \mathbf{x}_q(t)) \mathbf{u}_{\text{T}}(\mathbf{x}_q(t)) \\
\mathbf{u}_{\text{T}} &= (u_x(\mathbf{x}_q(t)), u_y(\mathbf{x}_q(t))) = (\dot{x}_q, \dot{y}_q)
\end{aligned} \quad (17)$$

The value of the integral in Eq. (16), for given  $z$  and  $t$ , depends on the values of the physical quantities involved at time  $t_q = t \mp (z - z_q(t_q))/c$ , from this relation we can determine  $t_q = t_q(z, t)$ . We have

$$\begin{aligned}
& -\frac{1}{2} \int_{\Omega} (\mathbf{E}_{0\lambda}(\mathbf{x}'_{\text{T}})/V_{\lambda}) \cdot \mathbf{J}_{\text{T}} \left( \mathbf{x}', t \mp \frac{z-z'}{c} \right) d^3x' \\
& = -\frac{1}{2} q \int_{\Omega} \delta(\mathbf{x}' - \mathbf{x}_q) (\mathbf{E}_{0\lambda}(x', y')/V_{\lambda}) \cdot \mathbf{u}_{\text{T}}(\mathbf{x}_q(t)) d^3x' \\
& = -\frac{1}{2} q (\mathbf{E}_{0\lambda}(x_q(t_q), y_q(t_q))/V_{\lambda}) \cdot \mathbf{u}_{\text{T}}(\mathbf{x}_q(t)) \\
& \qquad \qquad \qquad t_q = t \mp \frac{z-z_q(t_q)}{c}
\end{aligned} \tag{18}$$

If we set  $z = z'$ , correspondingly  $z = z_q(t_q)$  for the point charge case, the integral (without the 1/2) with the minus sign is the same with the one we know for the auxiliary current, in the case of a detector with short conductors (no propagation effects), [7]. Indeed we have

$$I_{\lambda}(t) = - \int_{\Omega} (\mathbf{E}_{0\lambda}(\mathbf{x}'_{\text{T}})/V_{\lambda}) \cdot \mathbf{J}_{\text{T}}(\mathbf{x}', t) d^3x', \quad \lambda = 1, 2, \dots \tag{19}$$

and for the point charge,

$$I_{\lambda}(t) = -q (\mathbf{E}_{0\lambda}(x_q(t), y_q(t))/V_{\lambda}) \cdot \mathbf{u}_{\text{T}}(\mathbf{x}_q(t)), \quad \lambda = 1, 2, \dots$$

It is clear that the integrals in Eqs (16), (18), describe the propagation with velocity  $c$  of currents along the corresponding conductors of the multi conductor transmission line detector. Namely it is the propagation of the currents shown in Eqs (19) which are currents induced on the conductors by the moving charges at time  $t = 0$  or  $t = t_0$  at  $z = z_q$ .

We may convince ourselves that this is so by calculating the currents from the following known equations

$$i_k(z, t) = \oint_k \mathbf{H}^{(\pm)} \cdot d\mathbf{l}$$

The line integral, with the appropriate direction, is taken on a plane with  $z = \text{constant}$ . The path of integration is along a curve outside the conductor but very close to it. We remind that the conductor currents are only on the surface because the conductors are ideal with no resistance.

So the current at point  $z$  at time  $t$  is

$$\begin{aligned}
i_{\lambda}^{(\pm)}(z, t) &= -\frac{1}{2} \int_{\Omega} (\mathbf{E}_{0\lambda}(\mathbf{x}'_{\text{T}})/V_{\lambda}) \cdot \mathbf{J}_{\text{T}} \left( \mathbf{x}', t \mp \frac{z-z'}{c} \right) d^3x' \\
&\text{or} \\
i_{\lambda}^{(\pm)}(z, t) &= -\frac{1}{2} q (\mathbf{E}_{0\lambda}(x_q(t_q), y_q(t_q))/V_{\lambda}) \cdot \mathbf{u}_{\text{T}}(\mathbf{x}_q(t))
\end{aligned} \tag{20}$$

$$t_q = t \mp \frac{z-z_q(t_q)}{c}$$

therefore

$$i_{\lambda}^{(\pm)}(z, t) = c \sum_{\lambda'=1}^N c_{\lambda'\lambda} v_{\lambda'}^{(\pm)}(z, t), \quad \lambda = 1, 2, \dots, N \tag{21}$$

The 1/2 is due to the fact that the signal is split into two signals that move towards opposite directions.

The conclusion is that the equivalent circuit for the detector is as in Fig. 3.

It consists of current sources each connected to one conductor of a the multi conductor transmission line. The current sources are the same with the ones for small size detectors. This system is the "internal" equivalent system or the detector system. The ends of the transmission lines are connected to an external system.

Remember that in the small detector size case the current sources are connected to the internal system of capacitances, and all that constitutes the "internal" equivalent system or the detector. This system is connected to the external system.

In practice, the localization domain of the excitation, which is between  $z_+$ ,  $z_-$ , is very small with respect to the distance  $|z - z_+|$  or  $|z - z_-|$  from the area we are interested to know the signal values. It is for this reason that we can accept that  $z' \approx z_- \approx z_+ \approx z_0 =$  given constant. It can also be assumed that  $\mathbf{x}'$ , which is  $(\mathbf{x}'_T, z')$ , is on the given transverse plane, in position  $z' = z_0$  at all times. In other words, we have approximately,  $\mathbf{x}' = (\mathbf{x}'_T, z_0)$ . This is because, in practice, the wave length is much bigger than  $|z_+ - z_-|$ , so for a given time, the fields do not change significantly with position  $z'$  in the domain of localization of the source. This simplifies the calculation of the integral and suggests that the current sources are not distributed, they are localized at one point along the  $z$ -axis, the same for all conductors.

Thus we get

$$\begin{aligned} I_\lambda(t) &= - \int_{\Omega} (\mathbf{E}_{0\lambda}(x'_T)/V_\lambda) \cdot \mathbf{J}_T(\mathbf{x}'_T, z_0; t) d^3x', \quad \lambda = 1, 2, \dots, N \\ I_\lambda(t) &= -q(\mathbf{E}_{0\lambda}(x_q(t), y_q(t))/V_\lambda) \cdot \mathbf{u}_T(x_q(t), y_q(t), z_0), \quad \lambda = 1, 2, \dots \end{aligned} \quad (22)$$

We will express all the above in matrix form. At first we described propagation in the two opposite directions without examining reflections at the two ends. In the matrix formulation it is easier to include reflections and small losses during the propagation. We do it by making use of the well developed theory of transmission lines in matrix form.

From the previous relations we know the currents of each conductor at each point  $(z, t)$  and we can determine the corresponding voltages. If there are not reflections it is easy to find the signals at the end of the conductors. If there are reflections things are more complicated as can be seen later on.

Let us write Eqs. (22) in a matrix form,

$$\begin{aligned} (i) &= \begin{bmatrix} i_1 \\ i_2 \\ \vdots \\ i_N \end{bmatrix}, \quad (v) = \begin{bmatrix} v_1 \\ v_2 \\ \vdots \\ v_N \end{bmatrix}, \quad (i) = c[c](v) = [Y_0](v) \\ [Y_0] &= c[c] \end{aligned} \quad (23)$$

$[c]$  is the  $(N \times N)$  matrix of the capacitance per unit length coefficients. Currents and voltages are one column matrices (column vectors) denoted by  $( )$ . All matrices, denoted by  $[ ]$ , are  $(N \times N)$  matrices. As we have seen in Eq. (6), coefficients  $c_{ij}$  can be expressed with respect to the "usual" capacitances per unit length,  $C_{lm}$ , the two terminal capacitances per unit length.  $[Y_0]$  is a conductivity matrix (it is not per unit length). It is clear that the same relations hold for its matrix elements as is the case for the matrix elements of  $[c]$ . Namely  $Y_{0j\lambda} = Y_{0j\lambda} \leq 0 \quad \forall j \neq \lambda, \quad Y_{0jj} \geq 0$ .

By inverting Eqs. (23) we find (24)

$$(v) = \frac{1}{c}[c]^{-1}(i), \quad (v) = [Z_0](i), \quad [Z_0] = [Y_0]^{-1} = \frac{1}{c}[c]^{-1} \quad (24)$$

We see that to the conductivity matrix,  $[Y_0]$ , corresponds an impedance matrix  $[Z_0]$  (not per unit length), it is the characteristic impedance matrix. For all elements of matrix  $[Z_0]$ , we have  $Z_{0ij} = Z_{0ji} \geq 0$ .

Now we will give the (differential) equations that describe propagation in ideal transmission lines, as the lines we examined so far are.

Before doing so we note that, the following equations are known from multi conductor ideal transmission line theory. In this case the conductors have not resistance, so currents flow only on the surfaces of these ideal conductors, as our case is, and we get

$$[c][L] = \epsilon\mu[E_u], \quad [L] = \epsilon\mu[c]^{-1}, \quad [L] = (1/c^2)[c]^{-1}, \quad [L][c] = \epsilon\mu/c^2$$

$[L]$  is the inductance per unit length matrix, it is the matrix for the external inductances, because there is not current flow inside the conductors, so there are not internal inductances.  $[E_u]$  is the  $(N \times N)$  unit matrix, or identity matrix. We have  $L_{ij} = L_{ji} \geq 0$  for all matrix elements. We can write

$$(v) = \frac{1}{c}[c]^{-1}(i) = c[L](i)$$

$$v_\lambda^{(\pm)}(z, t) = c \sum_{\lambda'=1}^N L_{\lambda\lambda'} i_{\lambda'}^{(\pm)}(z, t)$$

The physical meaning of the inductance per unit length coefficients becomes evident from Fig. 3. The current of conductor  $j$  creates a magnetic flux  $\Psi_{ij} = L_{ij}i_j$  per unit length (along  $z$ , penetrating the area shown as a line connecting any point on the surface of conductor  $i$  with any point on the surface of enclosing conductor 0. The total magnetic flux per unit length through that area will be the sum of all partial fluxes due to the currents of all conductors, i.e. the following relations

$$\Psi_i = \sum_{j=1}^N \Psi_{ij} = \sum_{j=1}^N L_{ij}i_j$$

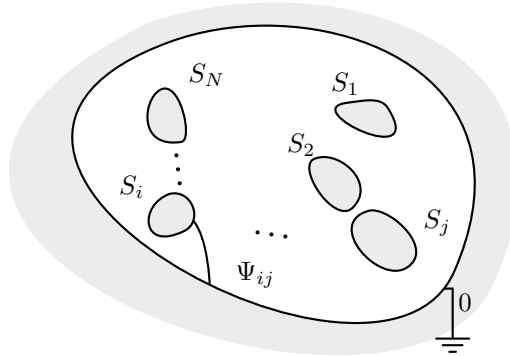

Figure 3: Magnetic flux  $\Psi_{ij}$  per unit length, through area from  $i$ -conductor to 0-conductor, due to the current of conductor  $j$ .

The (differential) equations for transmission lines are

$$-\frac{\partial i_\lambda}{\partial z} = \sum_{\lambda'=1}^N c_{\lambda'\lambda} \frac{\partial v_{\lambda'}}{\partial t}, \quad -\frac{\partial v_\lambda}{\partial z} = \sum_{\lambda'=1}^N L_{\lambda'\lambda} \frac{\partial i_{\lambda'}}{\partial t}$$

or  $-\frac{\partial}{\partial z}(i) = [c] \frac{\partial}{\partial t}(v), \quad -\frac{\partial}{\partial z}(v) = [L] \frac{\partial}{\partial t}(i)$

The wave equations for multi conductor transmission lines are the following

$$\frac{\partial^2 i_\lambda}{\partial z^2} = \frac{1}{c^2} \frac{\partial^2 i_\lambda}{\partial t^2}, \quad \frac{\partial^2 v_\lambda}{\partial z^2} = \frac{1}{c^2} \frac{\partial^2 v_\lambda}{\partial t^2} \tag{25}$$

These equations, with the proper initial and boundary conditions, solve the problem of signal propagation over detectors of many conductors (electrodes). It is clear one can treat the complicated problem of reflections by imposing the proper boundary conditions at the ends (terminals) of the detector electrodes. Remember we know the currents "injected" by the current sources, in a certain point (given  $z$ ), as functions of time.

At this point we summarize what it is proven so far for multi conductor detectors when the conductors are ideal. One may use Eqs (20),(21), (22), to conclude that any such detector is equivalent to what is depicted in Fig. 4. To each conductor is connected a current source, at the point along the  $z$  direction where the particle hits the detector. For each of these current sources the current versus time is calculated the same way as for (ideal) small size detectors. Then the propagation is treated by solving the multi conductor transmission line equations with known terminating networks. We proved that when the conductors of the ideal transmission line are excited by the respective current sources, the currents propagate along the different conductors independent of each other, without any coupling between them. After the signals reach the terminals, what happens depends on what is the connected external circuit. In general we have reflections and after reflection couplings of the currents occur. For the voltages propagating along the ideal conductors there is coupling from the start. The situation is "reversed" if the excitation is due to voltage sources, which is not the case for the analysis we follow.

We comment on a useful result about total charge through the current source of each conductor, see book by W. Blum, W. Riegler, L. Rolandi [6]. This result holds for small size detectors with no propagation effects. Since we proved that the current sources are the same for long detectors the result holds for this case too. If a point charge  $q$ , is moving along a trajectory  $\mathbf{x}(t)$  from position  $\mathbf{x}_0(t_0)$  to position  $\mathbf{x}_1(t_1)$ , the total charge that flows through current source number  $n$ , connected to conductor  $n$ , is given by (26) below

$$Q_n = \int_{t_0}^{t_1} I_n dt = -\frac{q}{V_n} \int_{t_0}^{t_1} (\mathbf{E}_{0\lambda}(x(t), y(t))) \cdot \mathbf{u}_T(x(t), y(t), z_0) dt = \frac{q}{V_n} (\Phi_{0n}(x_1, y_1) - \Phi_{0n}(x_0, y_0)) \quad (26)$$

We simplified our path description by not including the index  $q$ . The charge depends only on the end points of the trajectory, it does not depend on the specific path. If a pair of charges  $q, -q$  are at a point  $\mathbf{x}_0$ , where they were produced, and after some time  $q$  moves and arrives at position  $\mathbf{x}_1$  while  $-q$  moves and reaches position  $\mathbf{x}_2$ , the total charge through the current source is given by following Eq. (27)

$$Q_n = \frac{q}{V_n} (\Phi_{0n}(x_1, y_1) - \Phi_{0n}(x_2, y_2)) \quad (27)$$

If charge  $q$  moves to the surface of conductor (electrode of the detector)  $n$  while charge  $-q$  moves to the surface of some other electrode, the total charge through the source of the  $n$  electrode is equal to  $q$ . When both charges move to other electrodes, the total charge through the  $n$  source is zero. The conclusion is that, after all charges have arrived at the different electrodes, the total charge through the source of electrode  $n$  is equal to the charge that has arrived at electrode  $n$ . From this one also concludes that the above currents on electrodes that do not receive any charge are bipolar.

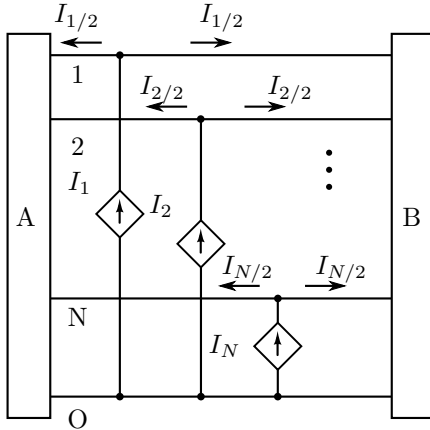

Figure 4: Equivalent circuit of multi conductor detector with external (terminal) circuits at both ends.

In what follows we consider the detector is not an ideal multi conductor transmission line. There are various "losses", these include conductor resistance and transverse currents, i.e. currents in the dielectric which could be not ideal dielectric. They may exist several different dielectric materials in a cylindrical (homogeneous along the  $z$ -axis) arrangement. We assume though, the situation is such that the currents of the current sources are calculated the same way as in the ideal case.

For the propagation the well known matrix treatment of transmission lines will be used. There are various articles and books on the subject, like [15, 16, 17, 18, 19, 20, 21, 22].

We give formulae relating currents in conductors with their voltages (potentials) relative to a reference conductor which has zero potential, see reference [21]. We have the following equations

$$(i) = [g](v), \quad g_{ij} \leq 0 \quad \forall i \neq j, g_{ii} \geq 0 \quad (28)$$

$[g]$  is the conductance matrix.

The above conductances have not direct representation (realization) with "usual" electric circuit elements. To achieve that we introduce the direct conductance matrix  $[G]$ , with elements  $G_{lk}$ , which relate currents to voltage differences between conductors. Each element of direct conductances  $R_{lk}$ , can be represented by a resistor  $R_{lk}$  connecting node  $l$  with node  $k$ , and relation  $R_{lk} = 1/G_{lk}$  holds. Elements  $G_{ll}$  correspond to resistors  $R_{ll}$  connected between node  $l$  and reference node 0. We have

$$i_l = G_{ll}v_l + \sum_{k=1}^N G_{lk}(v_l - v_k), \quad G_{ll} = \sum_{k=1}^N g_{lk} \geq 0, \quad G_{lk} = -g_{lk} \geq 0 \quad \forall l \neq k \quad (29)$$

$$g_{ll} = \sum_{k=1}^N G_{lk}.$$

In what follows,  $[g]$  and  $[G]$  are conductance matrices, with elements per unit length, referring to transverse conduction currents through the dielectric material of the transmission line and polarization losses in this material.

Let  $[R]$  be the matrix of resistances per unit length for each conductor of the transmission line. Its elements are positive and they can take values depending on the approximation used. If the reference (0th) conductor has no resistance then  $[R]$  takes the simplest form, it is diagonal with the only non zero elements  $R_{11} = r_1, R_{22} = r_2, R_{33} = r_3, \dots, R_{NN} = r_N$ . In the case the reference conductor could be considered to have unique resistance,  $r_0$  for all currents through the other  $N$  conductors, then the elements of matrix  $[R]$  are  $R_{11} = r_1 + r_0, R_{22} = r_2 + r_0, R_{33} = r_3 + r_0, \dots, R_{NN} = r_N + r_0$ , all the non diagonal elements are equal to  $r_0$ . In the more complicated case, the reference conductor resistance is different if its current goes through each of the other conductors, depending on the position of the conductor relative to the reference one, one influence of the , proximity effect. Then we have  $R_{11} = r_1 + r_{11}, R_{22} = r_2 + r_{22}, R_{33} = r_3 + r_{33}, \dots, R_{NN} = r_N + r_{NN}$ . All other non diagonal elements  $r_{ij}$ , in general, are different, the matrix could be no symmetric. For the quasi-TEM analysis to be applicable, the resistances must be sufficiently small.

In this case, even if  $[L]$  includes both external and internal inductances, it is assumed the situation is such that its matrix elements are considered independent of frequency, at least for the range of frequencies involved. Remember, the internal inductances exist only if there are currents inside the conductors, i.e. the conductors have resistance, they are not ideal. If the conductors are ideal the currents run only across their surfaces (surface currents) and there exist only external inductances. The external inductances exist always no matter where the currents through the conductors are located. The internal inductances and the resistance of each conductor, depend on the distribution of current inside the conductor. The distribution depends on the skin depth which depends on frequency. In general, the conductor resistances should be low enough so the quasi-TEM approximation holds, this means that internal inductances might not be so big comparing to external ones. The resistances will be bigger than the resistances for dc currents with constant density, all over the (transverse) cross section of the conductor.

From multi conductor transmission line theory, we have the more general than before, relations (30) that follow. Included are losses due to constant conductor resistances and transverse currents in the surrounding dielectric materials plus polarization losses, in addition, there might exist several dielectric media, with homogeneous arrangement along the  $z$ -axis. The whole situation is such that quasi-TEM analysis holds.

$$-\frac{\partial}{\partial z}(i) = [g](v) + [c]\frac{\partial}{\partial t}(v), \quad -\frac{\partial}{\partial z}(v) = [R](i) + [L]\frac{\partial}{\partial t}(i) \quad (30)$$

From the above relations we get formulae for the uncoupled wave equations, involving only the currents or only the voltages. They are generalizations of the respective formulae for a two conductor line. We give the final results

$$\begin{aligned} \frac{\partial^2}{\partial z^2}(i) - [c][L]\frac{\partial^2}{\partial t^2}(i) - ([c][R] - [g][L])\frac{\partial}{\partial t}(i) - [g][R](i) &= 0 \\ \frac{\partial^2}{\partial z^2}(v) - [c][L]\frac{\partial^2}{\partial t^2}(v) - ([c][R] - [g][L])\frac{\partial}{\partial t}(v) - [g][R](v) &= 0 \end{aligned} \quad (31)$$

The above two sets of equations can be combined into one set with column matrices ( $2N \times 1$ ) and square matrices ( $2N \times 2N$ ).

In the treatment of common transmission lines, it is usually considered (with very good accuracy) that  $[g] = 0$  and  $[G] = 0$ .

We repeat that in what we have done so far,  $[c]$ ,  $[L]$ ,  $[g]$ ,  $[G]$ ,  $[R]$  have constant matrix elements, i.e. they do not depend on frequency.

Later we give formulae to analyze more complicated cases, where there are frequency dependences. Such a case is the influence of the skin effect on  $[R]$  and  $[L]$ . Even  $[c]$  might depend on frequency. Frequency dependance may exist in the "transverse" losses through  $[g]$ .

For the ideal case with not any type of losses, we have,  $[g] = 0$ ,  $[G] = 0$  and  $[R] = 0$  and the above formulae get the appropriate forms.

We give, without proof, some relations for the various matrices, when there is a homogeneous medium between the conductors, Eqs (32). The conductors are ideal so  $[L]$  has elements the external inductances per unit length.

$$\begin{aligned} [L][c] &= [c][L] = \mu\epsilon[E_u] \\ [L][g] &= [g][L] = \mu\sigma[E_u] \end{aligned} \quad (32)$$

$\mu$  is the permeability of the homogeneous medium.  $\epsilon$  is the permittivity of the medium and  $\sigma$  is its conductivity.

In general matrix products do not generally commute so the proper order of multiplication should be observed.

The above relations are important because if we find only one of the matrices, then using the above relations we determine the other two. It is usually easier to find  $[c]$ . This can be done sometimes analytically or by solving electrostatic Maxwell's equations. We have the following relations (33)

$$\begin{aligned} [L] &= \mu\epsilon[c]^{-1} \\ [g] &= (\sigma/\epsilon)[c] \end{aligned} \quad (33)$$

Even when the medium is not homogeneous these matrices are symmetric and positive-definite.  $[L]$  depends on permeability of the medium. For the materials used  $\mu \approx \mu_0$ , which is the permeability of free space. This means that we may find  $[c_0]$  for free space, with  $\epsilon = \epsilon_0$  and from relation  $[L] = \mu_0\epsilon_0[c_0]^{-1}$  we may determine  $[L]$  even for inhomogeneous medium. This means that for the same system of ideal conductors,  $[L]$  is the same no matter what the medium is.

At this point it is worth to mention that one way to derive the above equations for multi conductor transmission lines is by using the per unit length equivalent circuit. One considers that the transmission line is represented by a large number of lumped circuits, each of small length,  $\Delta z$ , in comparison to the wavelengths involved. At the end  $\Delta z$  goes to zero and the number of those circuits goes to infinity. Figure 6 shows the general model. Notice that the capacitances shown are related to the elements of the matrix  $[C]$ , they are represented by actual capacitors. The conductances are the realizable ones, related to  $[G]$ , they are represented by actual resistors each equal to  $1/(G_{ij}\Delta z)$ . They are related to the elements of  $[c]$  and  $[g]$ , that appear in the transmission line equations. We assume the reference conductor has a

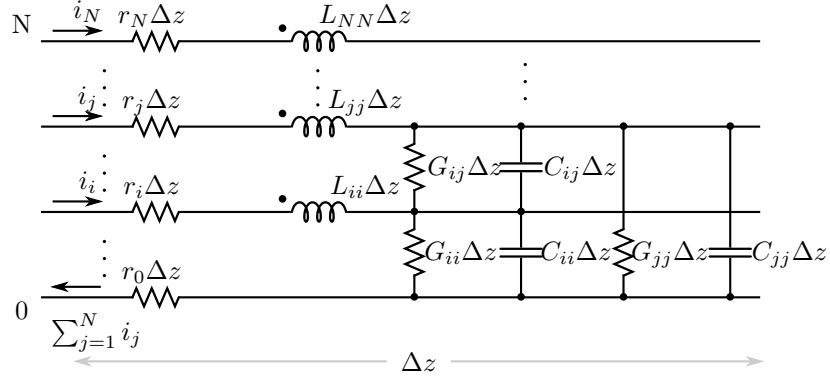

Figure 5: The per unit length circuit model for a multi conductor transmission line.

single resistance per unit length  $r_0$ . We repeat, all elements of the above matrices are independent of frequency. From those lumped circuits, by going to the limit we mentioned, one can deduce the formulae for transmission lines we gave so far.

Among the various ways to find solutions of the above equations, is by taking Laplace or Fourier transforms with respect to time. The two are related by exchanging the real frequency,  $\omega$ , with the complex one,  $s$ , according to  $j\omega \leftrightarrow s$ .

We assume that initially, at  $t = 0$ , the lines have zero voltages and currents, then by laplace transforming with respect to time, Eqs (28) lead to the following relations (34)

$$\begin{aligned} \frac{d(I(z, s))}{dz} &= -([g] + s[c]) (V(z, s)) \\ \frac{d(V(z, s))}{dz} &= -([R] + s[L]) (I(z, s)) \end{aligned} \quad (34)$$

We may proceed from Eqs (34), or from (31) to get

$$\begin{aligned} \frac{d^2(I(z, s))}{dz^2} &= ([g] + s[c]) ([R] + s[L]) (V(z, s)) \\ \frac{d^2(V(z, s))}{dz^2} &= ([R] + s[L]) ([g] + s[c]) (I(z, s)) \end{aligned}$$

These formulae hold even when some or all above matrices have elements that depend on frequency. We do not go into details about such dependences, among other references, one could consult the book by C. R. Paul, Ref. [22]. Another form of the above equations is (35)

$$\begin{aligned} [Z(s)] &= [R] + s[L], [Y(s)] = [g] + s[c] \\ \frac{d(I(z, s))}{dz} &= -[Y(s)] (V(z, s)) \\ \frac{d(V(z, s))}{dz} &= -[Z(s)] (I(z, s)) \\ \frac{d^2(I(z, s))}{dz^2} &= [Y(s)][Z(s)] (I(z, s)) \\ \frac{d^2(V(z, s))}{dz^2} &= [Z(s)][Y(s)] (V(z, s)) \end{aligned} \quad (35)$$



Usually,  $[R], [L]$  are taken to depend on frequency, while  $[c], [g]$  are constant.  $[Z]$  is the per unit length impedance matrix and  $[Y]$  the per unit length admittance matrix. One has to solve the above equations imposing the proper terminal constrains, that depend on the networks connected to the terminals of the multi conductor line.

The general case is difficult to treat. We only mention that there is attenuation along the line as it is true for (1+1) lines. As we said before, in general, if there are more than one dielectric material in a homogeneous arrangement along the  $z$ -direction, or if the conductors are not ideal, they have resistances, they might be  $N$  (maximum) number of propagation modes each one with different speed.

The generalization of the characteristic impedance is the impedance ( $N \times N$ ) matrix which is in general frequency dependent. Reflections occur at both terminals if not properly terminated.

For signals propagating along only one dimension, either  $+z$  or  $-z$ , we have for the solutions the form (36)

$$\begin{aligned} (I(z, s)) &= (I_0(s)) \exp(\pm\gamma(s)z), & (V(z, s)) &= (V_0(s)) \exp(\pm\gamma(s)z) \\ \det[[Z(s)][Y(s)] - \gamma^2(s)[E_u]] &= 0, & \det[[Y(s)][Z(s)] - \gamma^2(s)[E_u]] &= 0 \\ & & \gamma_j(s), & j = 1, 2, \dots, N \end{aligned} \quad (36)$$

The - sign in the exponentials correspond to propagation along the  $+z$  direction and the + sign along the  $-z$  direction. The relations in the second line determine the propagation coefficient  $\gamma(s)$ , from witch one could determine the signal attenuation and the various speeds of propagation. Both relations with the zeroing of determinants give the same results. In some cases the propagation coefficients take the simple form  $a + bs$ , with  $a$  and  $b$  positive constants. In this case it is easy to determine the attenuation and speed of propagation. As we said before, in general, for multi conductor transmission lines, there are (maximum)  $N$  different modes of propagation,  $N$  different  $\gamma, \gamma_1, \gamma_2, \dots, \gamma_N$ . It is taken  $\text{Real}\gamma_j \geq 0$  and  $\text{Im}\gamma_j \geq 0$ . From these  $N$  different speeds,  $v_1(s), v_2(s), \dots, v_N(s)$  could be calculated. One determines the signals as functions of position and time by taking the inverse Laplace transform of the above relations. Each solution is superposition of all modes of propagation with all different propagation coefficients. The appropriate boundary conditions at the sources and terminals should be taken into account.

At this point we analyze mainly the case of lossless multi conductor lines, in general, with many dielectric materials distributed as mentioned before.

We make  $[R] = 0$  and  $[g] = 0$ , so Eqs (35) , become

$$\begin{aligned} [Z(s)] &= s[L], [Y(s)] = s[c] \\ \frac{d(I(z, s))}{dz} &= -s[c](V(z, s)) \\ \frac{d(V(z, s))}{dz} &= -s[L](I(z, s)) \\ \frac{d^2(I(z, s))}{dz^2} &= s^2[c][L](I(z, s)) \\ \frac{d^2(V(z, s))}{dz^2} &= s^2[L][c](V(z, s)) \end{aligned}$$

Since  $[R] = 0$  then  $[L]$  is constant and equal to the external inductance matrix.  $[c]$  is constant too. It is easy to see that for a homogeneous medium there is only one propagation coefficient because the solutions for the values for the propagation coefficients are degenerate and have a single value. The final relation for the single speed is (37)

$$[L][c] = [c][L] = (1/c^2)[E_u], \quad c = v \quad (37)$$

One might want to examine the problem where, Eq. (37) is not true, this could be the case if  $[L]$  and  $[c]$  are not related to each other by Eqs (33), because there might be several dielectrics present and in addition one might include in  $[L]$  the internal (small) inductances as constants. One still ignores  $[R]$ .

For the single propagation constant we have (38)

$$\gamma = s/c \quad (38)$$

The traveling signals in both directions are given by relations (39)

$$\begin{aligned} (I(z, s)) &= (I_+(s)) \exp(-\gamma z) + (I_-(s)) \exp(+\gamma z) \\ (V(z, s)) &= [Z_0] ((I_+(s)) \exp(-\gamma z) - (I_-(s)) \exp(+\gamma z)) \end{aligned} \quad (39)$$

$I_+$  has as matrix elements the amplitudes of the current signals traveling in the  $+z$  direction.  $I_-$  the ones traveling in the  $-z$  direction. They can be estimated by imposing the proper boundary condition, exciting currents and terminal networks.  $[Z_0]$  is the characteristic impedance matrix which is not per unit length (we have seen that before, Eqs (24)).  $[Y_0]$  is the corresponding characteristic conductance matrix. The following equations relations (40)

$$[Z_0(s)] = [Y]^{-1} \sqrt{[Y][Z]}, \quad [Y_0] = [Z_0]^{-1} \quad (40)$$

It is easy to see that for (1+1) conductors line we get the simple result we know. Let us assume we have the situation of equations (41) below

$$\begin{aligned} [Y] &= s[c], \quad [Z] = s[L] \\ [Z_0(s)] &= [c]^{-1} \sqrt{[c][L]} \end{aligned} \quad (41)$$

If we assume relation between  $[L]$  and  $[c]$  holds as in Eq. (33) then we get

$$[Z_0] = \frac{1}{c} [c]^{-1}$$

This is the same result as in Eq. (24).

At this point we give some general formulae for treating a single reflection at one terminal, see [22]. The general formula for the voltage reflection matrix at the load is,  $[\Gamma_{VL}(s)]$ . The current reflection matrix is  $[\Gamma_{IL}(s)]$ . They are the generalizations of the reflection coefficients for usual (1+1) transmission lines. For the reflection matrix at the source  $L \rightarrow S$ . We have the formula

$$\begin{aligned} [\Gamma_{VL}(s)] &= ([Z_L] - [Z_0]) ([Z_L] + [Z_0])^{-1} \\ [\Gamma_{IL}(s)] &= -[Y_0][\Gamma_{VL}(s)][Z_0] \end{aligned}$$

$[Z_L]$  is the matrix form of the network connected at the terminal of the line, which has  $N$  inputs.

Let  $(V_f)$  the column of signal complex voltages that travel along the  $+z$  (forward) direction towards the load  $[[Z_L]$  at the terminal of the line at point  $z = l$ .  $(I_f)$  is the corresponding column of the complex current signals. Signals  $(V_b)$  and  $(I_b)$  are the corresponding reflected signals. The following relations

$$\begin{aligned} (V_b) &= [\Gamma_{VL}(s)] (V_f) \\ (I_b) &= [\Gamma_{IL}(s)] (I_f) \end{aligned}$$

It is clear that, if for the reflection matrices, relation  $[\Gamma] = 0$  holds, then there are not reflections. The reflection matrices are zero if the matrix of the terminal network is the same with the characteristic impedance matrix, i.e.  $[Z_L] = [Z_0]$ . This is the impedance matching condition, matched line.

For signals traveling in the  $+z$ , forward and  $-z$ , backward directions we have the formulae

$$\begin{aligned} (V_f) &= [Z_0] (I_f), \quad (I_f) = [Y_0] (V_f) \\ (V_b) &= -[Z_0] (I_b), \quad (I_b) = -[Y_0] (V_b) \end{aligned} \quad (42)$$

Another interesting concept is the transmission or transfer matrix. It is the generalization of the corresponding transfer coefficient for (1+1) lines. This matrix is  $([E_u] + [\Gamma])$ . The definition is based on the fact that, if we consider

the "incoming" and reflected signals at the terminal, the voltage or current signal  $[S_t]$  that the terminal "sees" is the sum of the two. The same is true for the currents. So we have

$$(S_t) = ([E_u] + [\Gamma]) (S_t)$$

The problem of termination of the multi electrode long detectors is a complicated procedure. Let us first generalize Eqs (28) and (29) to hold for complex values too. We refer to signals propagating in the  $+z$  direction when they reach the terminal. We may examine reflections by let us assume that the line is matched and no reflections exist. We use Eqs (42) and we get

$$\begin{aligned} (I_t) &= (I_f) = (I) \\ (V_t) &= (V_f) = (V) \\ (I) &= [Y_0] (V) \\ I_l &= G_{ll}V_l + \sum_{k=1}^N G_{lk}(V_l - V_k), \quad G_{ll} = \sum_{k=1}^N Y_{0lk}, \quad G_{lk} = -Y_{0lk} \quad \forall l \neq k \\ Y_{0ll} &= \sum_{k=1}^N G_{lk} \end{aligned}$$

We expressed the currents in terms of the voltage differences between conductors, so we could have a realization of the terminal network with usual electric components. Let us assume we have the ideal case where  $[Y_0] = c[c]$ . This means all matrix elements are real. In this case the  $[G]$  matrix has (real) non negative elements.

Eqs (42) leads us to an equivalent to a circuit in which each conduct is represented by a node, and the distinct nodes  $l, k$  are connected by a resistor  $R_{lk}$ . The node  $l$  is also connected to the ground by a resistor  $R_{ll}$ . These resistors are the elements of a (symmetric) matrix  $[R]$  with the elements  $R_{lk} = G_{lk}^{-1}$ .

To have the multi conductor transmission line matched (exactly terminated) at both ends, we have to connect to its ends a complicated network of resistors indicated by the above matrix of the direct conductances.

For the case of a 2+1 conductor line, see reference [19], one has the simple 3 resistor circuit of Fig. 7. This is accomplished following the above procedure, using the conductivity matrix  $[Y_0]$ . We have (43) below

$$\begin{aligned} G_{11} &= Y_{011} + Y_{012}, & G_{22} &= Y_{012} + Y_{022} \\ G_{12} &= G_{21} = -Y_{012}, & R_{11} &= 1/(Y_{011} + Y_{012}) \\ R_{22} &= 1/(Y_{022} + Y_{012}), & R_{12} &= -1/Y_{012}. \end{aligned} \tag{43}$$

The circuit of Fig. ?? is a different one but equivalent to it. For this case the resistors are calculated more easily from the impedance matrix  $[Z]$ , we have the following equations

$$R_1 = Z_{011} - Z_{012}, \quad R_2 = Z_{022} - Z_{012}, \quad R_0 = Z_{012}.$$

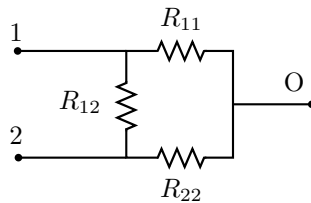

Figure 6: An exact terminating resistor circuit.

For  $N$  electrodes (the reference conductor not included) one needs  $N(N + 1)/2$  resistors! If one has three internal electrodes surrounded by the grounded electrode, one needs 6 appropriate resistors on each end. Amari and Bornemann,

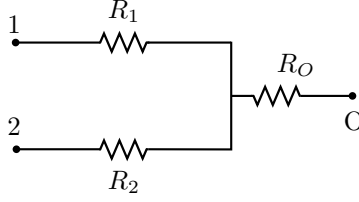

Figure 7: Another exact terminating resistor circuit .

[9], examine a case where there are electrodes of the strip type on a plane parallel to each other. They achieve a so called optimum termination (for lowest input return loss), by using resistors interconnecting only the neighboring electrodes and resistors from each electrode to the ground. For 10 electrodes exact termination needs 55 appropriate resistors. If one could apply the mentioned above approximate method, 19 appropriate resistors are needed.

At the end we should say a few things on the need or not of the use of the transmission line description. A rule of thumb is that, in general, if for the length,  $l$ , of a circuit and the wavelength  $\lambda$  of waves involved the relation  $l \geq \lambda$  then the propagation effects are important and reflections might lead to behavior different from the expected one for small size circuits. For small size circuits even though one may argue that there are propagation effects, they are such that not deviations exist from the usual description without propagation effects. In the case of detectors we can understand that the need of transmission line description taking into account reflections at the ends of a detector, could have a significant effect, depending on the detector length in relation to the wave lengths of the induced signals and on the (electronic) shaping of the pulses at the readout, which influences the wave lengths involved in the "final", after shaping signals. Our analysis is needed if the "final" wave lengths are sufficiently small in comparison to the detector length.

## 2 Example: Long cylindrical detector of circular cross-section with a wire along its axis

In this case, the position variables are the known variables of cylindrical coordinates  $\varphi, r$ . The external conductor is assumed to have zero potential ( $S_0$ ). We will examine the case of a point ion charge, whose drift velocity is given by relation  $u = \mu E$ ,  $\mu = \text{constant}$  and the motion of the charge is radial on the transverse [to the  $z$ -axis] plane, in position  $z_q = \text{constant}$ . The charge starts from initial position  $r_0$ . Obviously  $\varphi = \text{constant}$ , independent of time. It is easy to get the following relations (see, [5, 7, 6])

$$E = E_T = \frac{V_a}{\ln(b/a)} \frac{1}{r}$$

$$u_T = \mu \frac{V_a}{\ln(b/a)} \frac{1}{r}, \quad r^2 = r_0^2 + 2\mu \frac{V_a}{\ln(b/a)} t, \quad r^2 = r_0^2 \left(1 + \frac{t}{t_0}\right)$$

$$t_0 = \frac{r_0^2}{2\mu V_a} \ln\left(\frac{b}{a}\right)$$

We assume that (high) voltage, i.e. the detector bias that moves the charges is constant,  $V_a$ , so from Eqs. (18) and (25) for the current and voltage "pulse" we find

$$\begin{aligned}
i(\mathbf{x}, t) &= -\frac{1}{2} \frac{1}{2\pi} \frac{\sqrt{\mu/\epsilon} q \mu V_a}{r_0^2 \ln(b/a)} \frac{1}{\left[ \left(1 + \frac{t}{t_0}\right) \mp \frac{z - z_q}{ct_0} \right]} \\
v(\mathbf{x}, t) &= -\frac{1}{2} \frac{q \mu V_a}{r_0^2 (\ln(b/a))^2} \frac{1}{\left[ \left(1 + \frac{t}{t_0}\right) \mp \frac{z - z_q}{ct_0} \right]} \\
Z_0 &= \frac{v(z, t)}{i(z, t)} = \frac{1}{2\pi} \sqrt{\frac{\mu}{\epsilon}} \ln\left(\frac{b}{a}\right) = \text{characteristic resistance of the transmission line}
\end{aligned}$$

### 3 Conclusions

In the case of signal formation in a long length multi conductor detector, the corresponding current sources of the conductors, are calculated with the same procedure as for a short multi conductor detector. The difference is that the internal equivalent (electrotechnical) circuit of the long detector is a system of coupled transmission lines, unlike the short detector case where the various capacitances of the electrodes are involved. If the excitation (e.g. a passing particle) occurs far away from the ends of the long detector, then the corresponding current sources are connected to two identical multi conductor transmission lines, in two opposite directions. The total auxiliary currents are split into two sets of equal currents each one set feeding the corresponding coupled transmission lines. What will happen to the propagating signals in the two opposite directions after they reach the ends of the lines depends on the loads at the terminals of the lines. If the particle passes in a place very near the one end of the detector, assuming this end to be "open" with no any external circuit attached to it, and ignoring edge effects, then the current sources are connected only to one multi conductor transmission line, the other set of transmission lines mentioned above is a kind of an open circuit. Then the set of currents feeds one set of transmission lines (propagation along one direction), there is not the 1/2 in the formula for the currents since there is not any splitting in this case. The case of the cylindrical detector with only one wire inside, is a simple case where the current source "sees" the characteristic impedance of the line, which for an ideal (without any type of lossless) line, is an ohmic resistance. We treated the ideal case with no losses but one could guess that, for small losses, the current sources will be the same as in the lossless case while the propagation along the transmission line will be treated as in the lines with small losses. The problem of proper termination of a multi conductor detector is a complicated problem. It is the same problem for multi conductor transmission line. In this work it is proved (justified) that the problem of signals in long detectors is split into two parts: a) the auxiliary currents from the passage of a particle is calculated the same way it is done for small size detectors, and b) the signals propagation follows the known procedure of the multi conductor transmission lines in all respects, including possible reflections.

### Acknowledgments

I would like to thank Professor Theo Alexopoulos, because without him, my thoughts about the subject of signal formation in multi conductor detectors would be remained incomplete. He has, for many years, a continuous involvement with Micromegas detectors and strong will to understand as much as possible from the various aspects of this type of detectors. As a result he pressured me to examine in a more detail the subject. I thank Dr Stefanos Dris for making corrections and Mr Sotirios Fragkiskos for his help.

## References

- [1] W. Shockley, *Journal of Applied Physics* 9, 635 (1938)
- [2] S. Ramo, *Proc. IRE* 27 (1939) 584.
- [3] B. B. Rossi, H. H. Staub, *Ionization Chambers and Counters*, chapter 3, McGraw-Hill (1949).
- [4] E. Gatti, G. Padovini, V. Radeka, *Nucl. Instr. and Meth.* 193 (1982) 651.
- [5] Veljko Radeka, *Ann. Rev. Nucl. Part. Sci.* 1988, 38: 217-77.
- [6] W. Blum, W. Riegler, L. Rolandi, *Particle Detection with Drift Chambers*, Springer-Verlag (2008).
- [7] Manolis Dris and Theo Alexopoulos, arXiv:1406.3217v1.
- [8] F. Schneider, *The Dynamic Properties of Charge-Dividing Proportional Counters*, CERN 82-06, Experimental Physics Division, 4 June, 1982.
- [9] Smain Amari and Jens Bornemann, *IEEE Transactions on Microwave Theory and Techniques*, Vol. 45, No. 10, October 1997.
- [10] ATLAS, *Muon Spectrometer Technical Design Report*, CERN/LHCC 97-22, June 1997.
- [11] T. Alexopoulos et al, *Nucl. Instr. Meth. A*640, 110, (2011).
- [12] John David Jackson, *Classical Electrodynamics*, Third Edition, John Wiley and Sons, Inc (1998).
- [13] Robert E. Collin, *Foundations of Microwave Engineering*, McGraw-Hill Company (1966).
- [14] F. E. Borgnis and C. H. Papas, *Handbuch der Physik*, Band XVI, Herausgegeben von S. Flugge, *Electromagnetic Waveguides and Resonators*, page 285, Springer-Verlag (1958).
- [15] L. V. Bewley, *Traveling Waves on Transmission Systems*, John Wiley and Sons Inc., London, 1933.
- [16] Louis A. Pipes, *Matrix Theory of Multiconductor Transmission Lines*, *Phil. Mag. S. 7.* Vol. 24. No. 159. July 1937.
- [17] Louis A. Pipes, *Steady-State Analysis of Multiconductor Transmission Lines*, *Journal of Applied Physics*, Vol. 12, p. 782, Nov. 1941.
- [18] W. T. Weeks, *IBM J. Res. Develop.*, Nov. 1972, p. 604.
- [19] Keneth D. Marx, *IEEE Transactions on Microwave Theory and Techniques*, Vol. MTT-21, No. 7, July 1973.
- [20] Tom K. Liu, *Electromagnetic Coupling Between Multiconductor Transmission Lines in a Homogeneous Medium*, Note 309, Science Applications, Inc., Berkeley, California, Dec. 1976.
- [21] David D. Ling and Albert E. Ruehli, Elsevier Science Publishers B. V. (North-Holland), 1987.
- [22] Clayton R. Paul, *Analysis of Multiconductor Transmission Lines*, John Wiley and Sons, Inc., 2007.