

Extending Precolorings to Distinguish Group Actions

Michael Ferrara^{1,2} Ellen Gethner³ Stephen G. Hartke⁴
 Derrick Stolee⁵ Paul S. Wenger⁶

May 25, 2022

Abstract

Given a group Γ acting on a set X , a k -coloring $\phi : X \rightarrow \{1, \dots, k\}$ of X is *distinguishing* with respect to Γ if the only $\gamma \in \Gamma$ that fixes ϕ is the identity action. The *distinguishing number* of the action Γ , denoted $D_\Gamma(X)$, is then the smallest positive integer k such that there is a distinguishing k -coloring of X with respect to Γ . This notion has been studied in a number of settings, but by far the largest body of work has been concerned with finding the distinguishing number of the action of the automorphism group of a graph G upon its vertex set, which is referred to as the distinguishing number of G .

The distinguishing number of a group action is a measure of how difficult it is to “break” all of the permutations arising from that action. In this paper, we aim to further differentiate the resilience of group actions with the same distinguishing number. In particular, we introduce a precoloring extension framework to address this issue. A set $S \subseteq X$ is a *fixing set* for Γ if for every non-identity element $\gamma \in \Gamma$ there is an element $s \in S$ such that $\gamma(s) \neq s$. The *distinguishing extension number* $\text{ext}_D(X, \Gamma; k)$ is the minimum number m such that for all fixing sets $W \subseteq X$ with $|W| \geq m$, every k -coloring $c : X \setminus W \rightarrow [k]$ can be extended to a k -coloring that distinguishes X .

In this paper, we prove that $\text{ext}_D(\mathbb{R}, \text{Aut}(\mathbb{R}), 2) = 4$, where $\text{Aut}(\mathbb{R})$ is comprised of compositions of translations and reflections. We also consider the distinguishing extension number of the circle and (finite) cycles, obtaining several exact results and bounds.

Keywords: Distinguishing Coloring, Distinguishing Number, Group Action.

¹Department of Mathematical and Statistical Sciences, University of Colorado Denver, Denver, CO 80217. michael.ferrara@ucdenver.edu

²Research supported in part by Simons Foundation Grant #206692.

³Department of Computer Science and Engineering, University of Colorado Denver, Denver, CO 80217. ellen.gethner@ucdenver.edu.

⁴Department of Mathematics, University of Nebraska-Lincoln, Lincoln, NE 68588. hartke@math.unl.edu. Research supported in part by NSF Grant DMS-0914815.

⁵Department of Mathematics, Department of Computer Science, Iowa State University, Ames, IA 50011. dstolee@iastate.edu

⁶School of Mathematical Sciences, Rochester Institute of Technology, Rochester, NY 14623. pswsma@rit.edu

1 Introduction

Given a group Γ acting on a set X , a k -coloring $\phi : X \rightarrow \{1, \dots, k\}$ of X is *distinguishing* with respect to Γ if the only $\gamma \in \Gamma$ that fixes ϕ is the identity action. The *distinguishing number* of the action Γ , denoted $D_\Gamma(X)$, is then the smallest positive integer k such that there is a distinguishing k -coloring of X with respect to Γ .

The notion of distinguishing a general group action was introduced by Tymoczko in [35], where a number of results on actions of S_n appear, and was also addressed in [16, 17]. In [28], the distinguishing number of $GL_n(K)$ over a field K acting on the vector space K^n was completely determined. We are most frequently concerned with the case where Γ is the action of a symmetry group on some geometric or combinatorial object. In particular, the overwhelming body of work on this problem is concerned with determining the *distinguishing number* of a graph G , first introduced by Albertson and Collins [4] in 1996.

Specifically, a vertex coloring of a graph G , $c : V(G) \rightarrow \{1, \dots, k\}$, is said to be *distinguishing* if the only automorphism of G that preserves all of the vertex colors is the identity. The *distinguishing number* of a graph G , denoted $D(G)$, is the minimum integer r such that G has a distinguishing r -coloring. In the notation outlined above for general group actions, we therefore have that $D(G) = D_{Aut(G)}(V(G))$. The distinguishing number of a graph has been widely studied for both finite (see [3, 4, 8, 18, 19]) and, starting in [27], infinite (see [13, 14, 30, 31, 36]) graphs.

The distinguishing number of a group action is a measure of how difficult it is to “break” all of the permutations arising from that action; the more colors required, the more resilient the action. Almost all graphs have trivial automorphism group (see [12]), and hence have distinguishing number 1. Many other familiar graph classes have distinguishing number 2 (see [2, 4, 11, 22, 25, 26]) despite their diverse collection of automorphism groups and seemingly disparate structural properties. This leads us to ask the following:

How can we further differentiate the resilience of group actions with the same distinguishing number?

In this paper, we propose a precoloring extension approach to this question.

1.1 Extending Precolorings to Distinguishing Colorings

A *precoloring* of X is a k -coloring of $X \setminus W$ for some k and subset W of X . We want to understand when a precoloring can be extended to a distinguishing k -coloring of all of X . Specifically, given a set W where every precoloring of $X \setminus W$ can be extended to a distinguishing coloring of X , it follows that an arbitrary k -coloring c of X can be modified into a distinguishing k -coloring by changing at most the colors on W .

A precoloring of $X \setminus W$ cannot be extended to a distinguishing coloring if there is a nontrivial element $\sigma \in \Gamma$ such that σ pointwise stabilizes W ; hence we preclude such subsets W from our consideration. Formally, a set $S \subseteq X$ is a *fixing set* for Γ if the pointwise stabilizer of S in Γ is trivial; that is, for every non-identity element $\sigma \in \Gamma$ there is an element $s \in S$ such that $\sigma(s) \neq s$. We define the *distinguishing extension number* $\text{ext}_D(X, \Gamma; k)$ to be the minimum number m such that for all fixing sets $W \subseteq X$ with $|W| \geq m$, every precoloring $c : X \setminus W \rightarrow \{1, \dots, k\}$ can be

extended to a k -coloring of X that is distinguishing under Γ . If G is a graph, we write $\text{ext}_D(G; k)$ instead of the more cumbersome $\text{ext}_D(V(G), \text{Aut}(G); k)$, and to further simplify, we write $\text{ext}_D(G)$ instead of $\text{ext}_D(G; D(G))$ and unambiguously refer to this quantity as the *distinguishing extension number* of G . We similarly define $\text{ext}_D(X) = \text{ext}_D(X, \Gamma; D_\Gamma(X))$ to be the *distinguishing extension number* of X .

The problem of determining $\text{ext}_D(X, \Gamma; k)$ can be viewed as a partizan combinatorial game that fits under the broad umbrella of competitive graph coloring. Given a group Γ acting on a set X , $m \geq 0$ and $k \geq D_\Gamma(X)$, two players, the Hero and the Adversary, play the following game. The Adversary begins by coloring all but an m -element fixing set of X using colors from $\{1, \dots, k\}$. The Hero wins if he can extend the Adversary's coloring to a distinguishing k -coloring of X by coloring the m uncolored elements using colors from $\{1, \dots, k\}$. The distinguishing extension number $\text{ext}_D(X, \Gamma; k)$ is then the minimum m such that the Hero has a guaranteed win.

Our work in this paper is further motivated (and contextualized) by the following problem in graph coloring: Given a graph G and a k -coloring c of some subset of $V(G)$, when can c be extended to a proper k -coloring of G ? This problem was first introduced in [10, 23, 24], and has been studied over the last twenty years not only in the context of proper colorings (see also [5, 6, 32, 34]), but also for list [1, 9], circular [7, 15] and fractional [29] colorings of graphs. As is the case here, the broad class of precoloring extension problems provide a framework by which it is possible to contrast the colorability of graphs that have the same value of a particular coloring parameter.

The remainder of this paper is structured as follows. In Section 2 we present some basic notions and state our main results. In Section 3 we discuss an overview of our proof technique, with more detailed discussion of uncolored elements in Section 4 and with the final proofs of the main results in Section 5. We conclude with a discussion of future work in Section 6.

2 Preliminaries and Statement of Main Results

In this paper, we study the distinguishing extension number of the real line and the unit circle. Our investigation of the latter also allows us to naturally study the distinguishing extension number of the cycle C_n . We begin by more generally considering \mathbb{R}^n , where $\text{Aut}(\mathbb{R}^n)$ is the action of affine linear maps $\mathbf{x} \mapsto A\mathbf{x} + \mathbf{b}$ where A is a matrix with determinant in $\{+1, -1\}$. For instance, the automorphisms of \mathbb{R} are compositions of translations of \mathbb{R} and reflections of \mathbb{R} about a point.

Let \mathbb{S}^d be the set of vectors $\mathbf{x} \in \mathbb{R}^{d+1}$ with $\|\mathbf{x}\|_2 = 1$. The automorphisms of \mathbb{S}^d are given by the $(d+1) \times (d+1)$ real matrices with determinant in $\{+1, -1\}$. When considering \mathbb{S}^1 , we instead use the parameterization $\phi : \mathbb{R} \rightarrow \mathbb{S}^1$ given by $\phi(t) = (\cos(2\pi t), \sin(2\pi t))^\top$. Hence, we consider \mathbb{R}/\mathbb{Z} , the collection of preimages of ϕ , to be the *unit circle* with automorphisms given by rotations ($x \mapsto x + \alpha$) and reflections ($x \mapsto \beta - x$).

We first consider $\text{ext}_D(\mathbb{R})$. Coloring $(-\infty, 0)$ red and $[0, \infty)$ blue is a distinguishing 2-coloring of \mathbb{R} , so we have that $D_{\text{Aut}(\mathbb{R})}(\mathbb{R}) = 2$. Next, we give a lower bound on $\text{ext}_D(\mathbb{R})$.

Proposition 1. $\text{ext}_D(\mathbb{R}) \geq 4$.

Proof. Color $\mathbb{R} \setminus \{0, 1, -1\}$ red and leave the remaining three elements blank. We claim that this coloring cannot be extended to a distinguishing 2-coloring of \mathbb{R} . Indeed, suppose that c is an

extension of this coloring that uses only colors red and blue. If c assigns all three elements of $\{0, 1, -1\}$ the same color, then the reflection of \mathbb{R} about 0 fixes c . Further, if only one of the uncolored elements is colored blue, then the reflection of \mathbb{R} about that point preserves c . Hence we may assume that exactly two points in $\{-1, 0, 1\}$, call them x and y , are colored blue. It then follows that the reflection about $\frac{x+y}{2}$ preserves c . This completes the proof. ■

Our first main result shows that this lower bound is sharp.

Theorem 1. $\text{ext}_D(\mathbb{R}) = 4$.

For a graph G , an injection $\phi : V(G) \rightarrow X$ is a Γ -faithful embedding of G (into X) if the following properties hold. First, there is an isomorphism φ between the subgroup Γ' of Γ that setwise stabilizes $\text{im}(\phi)$ and $\text{Aut}(G)$, where $\text{im}(\phi)$ denotes the image of ϕ . Second, it is possible to choose φ such that for each $\gamma \in \Gamma'$, the permutation σ_γ of $\text{im}(\phi)$ corresponding to the action of γ satisfies

$$\sigma_\gamma(\phi(v)) = \phi(\varphi(\gamma)(v))$$

for all $v \in V(G)$. That is, the permutation σ_γ of $\phi(V(G))$ induced by an action $\gamma \in \Gamma$ that stabilizes $\phi(V(G))$ is equal to the permutation of $\phi(V(G))$ induced by the corresponding automorphism $\varphi(\gamma)$ of G . Note that for any $n \geq 3$, any set of n equally spaced points on the unit circle naturally corresponds to a faithful embedding of C_n into \mathbb{S}^1 . Further, if ℓ divides n , C_ℓ has an $\text{Aut}(C_n)$ -faithful embedding into $V(C_n)$. Finally, the unit cube Q_3 has a faithful embedding into \mathbb{S}^2 .

The following lemmas formalize two ways in which faithful embeddings can be used to provide useful bounds on $\text{ext}_D(X)$.

Lemma 1. *Let Γ be a group acting on a set X and $k \geq D_\Gamma(X)$. If G is a graph with a Γ -faithful embedding into X such that $D(G) \leq k$, then*

$$\text{ext}_D(X, \Gamma; k) \geq \text{ext}_D(G; k).$$

Proof. Let $\phi : V(G) \rightarrow X$ be a Γ -faithful embedding of G into X , $\ell = \text{ext}_D(G; k)$ and let Γ' be the subgroup of Γ that setwise stabilizes $X \setminus \text{im}(\phi)$. Since $\text{ext}_D(G; k) \geq \ell$, let $Y \subseteq V(G)$ be a set of size $\ell - 1$ such that there is a k -coloring $c : V(G) \setminus Y \rightarrow [k]$ which does not extend to a distinguishing k -coloring of G . Color each element of $X \setminus \text{im}(\phi)$ with color 1, and each element $x \in \text{im}(\phi) \setminus Y$ with $c(\phi^{-1}(x))$. It then follows, from the definition of c and Γ' , that this coloring of $X \setminus Y$ cannot extend to a distinguishing k -coloring of X , and the result follows. ■

Lemma 2. *Let Γ be a group acting on a set X and $k \geq D_\Gamma(X)$. If G is a graph with a Γ -faithful embedding into X such that $D(G) > k$, then*

$$\text{ext}_D(X, \Gamma; k) \geq 1 + |G|.$$

Proof. As in Lemma 1, let $\phi : V(G) \rightarrow X$ be a Γ -faithful embedding of G into X , and let Γ' be the subgroup of Γ that setwise stabilizes $X' = X \setminus \text{im}(\phi)$. If we color all of X' using color 1, then it is not possible to extend this precoloring to a distinguishing k -coloring of X , as such a k -coloring on $\text{im}(\phi)$ would induce a distinguishing k -coloring of G . ■

The distinguishing number for graphs was introduced (in the guise of an entertaining problem) and determined for finite cycles in [33]. Of particular interest here is the observation that when $n \geq 6$ we can distinguish C_n with two colors, but $D(C_3) = D(C_4) = D(C_5) = 3$. Applying Lemma 2 with C_3 , C_4 , or C_5 gives rise to the following conjecture.

Conjecture 2.

$$\text{ext}_D(C_n) = \begin{cases} 4 & \text{if } n \not\equiv 0 \pmod{4 \text{ or } 5}, \\ 5 & \text{if } n \equiv 0 \pmod{4}, \\ 6 & \text{if } n \equiv 0 \pmod{5}. \end{cases}$$

The uncolored elements and precolorings in each diagram of Figure 1 establish the sharpness of this conjecture. Note that these precolorings also demonstrate that a non-extendible coloring need not use only one color.

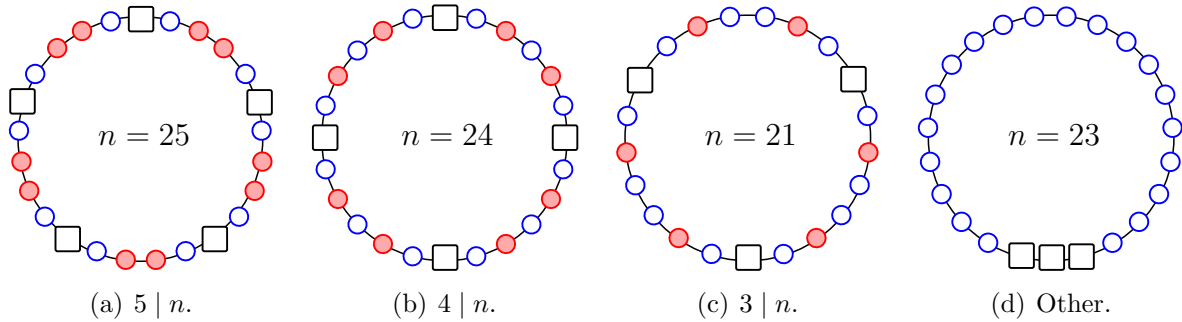

Figure 1: Sharpness examples for Conjecture 2.

We verify Conjecture 2 in infinitely many cases, based on the prime factorization of n .

Theorem 3. *If the minimum prime divisor of n is at least 7, then $\text{ext}_D(C_n) = 4$.*

We also show that for all n , both $\text{ext}_D(\mathbb{S}^1)$ and $\text{ext}_D(C_n)$ are bounded by an absolute constant.

Theorem 4. *For all $n \geq 3$, $\text{ext}_D(C_n) \leq \text{ext}_D(\mathbb{S}^1) \leq 16$.*

Note that the inequality $\text{ext}_D(C_n) \leq \text{ext}_D(\mathbb{S}^1)$ follows from Lemma 1. As C_5 has a faithful embedding into C_{10} , $\text{ext}_D(C_{10}) \geq 6$ by Lemma 2, and since C_{10} has a faithful embedding into \mathbb{S}^1 , $\text{ext}_D(\mathbb{S}^1) \geq 6$ by Lemma 1. We conjecture that this lower bound is correct.

Conjecture 5. $\text{ext}_D(\mathbb{S}^1) = 6$.

3 Overview of the Proof Technique

The proofs of Theorems 1, 3, and 4 utilize a common argument, so we prove all three results simultaneously. In this section we set up terminology and notation that is used throughout the rest of the paper.

Let X be one of C_n , \mathbb{R}/\mathbb{Z} , or \mathbb{R} . Each choice of X has two categories of automorphisms: reflections and translations. In the case of cycles and the unit circle, translations are rotations so we refer to rotations as translations for the sake of uniformity. If a reflection τ stabilizes an element $x \in X$, then we say that τ is the *reflection about x* .

Observe that every set of at least three elements in X is a fixing set. For a set $W \subset X$, let c_0 be a precoloring of $X \setminus W$. We refer to the elements of W as *blanks*. Let $\gamma \in \text{Aut}(X)$. We say that c_0 *permits* γ if there is an extension c^* of c_0 to X such that γ preserves c^* ; that is, $c^*(x) = c^*(\gamma(x))$ for all $x \in X$.

We will now give a brief outline of the proof. Assume for the sake of contradiction that $c_0 : X \setminus W \rightarrow \{\text{R}, \text{B}\}$ is a red-blue coloring of $X \setminus W$ such that no extension of c_0 to X is distinguishing. First we will prove that there exists a point $w_0 \in W$ such that the reflection about w_0 sends the elements of $W \setminus \{w_0\}$ to elements outside of W . Therefore, there is at most one extension of c_0 to $W \setminus \{w_0\}$ that permits the reflection about w_0 . Next we prove that there is at most one extension of c_0 to $W \setminus \{w_0\}$ that permits a translation. Any extensions to $W \setminus \{w_0\}$ that permits either the reflection about w_0 or a translation are *forbidden*; we show in all cases that there are at most two forbidden extensions of c_0 to $W \setminus \{w_0\}$.

Fix a non-forbidden extension of c_0 to $W \setminus \{w_0\}$; call it c . Since no extension distinguishes X and non-forbidden extensions do not permit translations, c must permit a reflection. Furthermore, since c does not permit the reflection about w_0 , no reflection permitted by c fixes w_0 . Thus the reflection permitted when c is extended by coloring w_0 red is distinct from the reflection permitted when c is extended by coloring w_0 blue, since w_0 has distinct images under these reflections. Let τ_{R} be the reflection permitted when w_0 is colored red and call it the *red reflection* permitted by c . Let τ_{B} be the reflection permitted when w_0 is colored blue and call it the *blue reflection* permitted by c . Since τ_{R} and τ_{B} are distinct, the composition $\tau_{\text{B}} \circ \tau_{\text{R}}$ yields a nontrivial translation σ of X ; we say that σ is *generated* by c . See Figure 3 for examples of τ_{R} , τ_{B} , and σ for the circle and the real line.

We consider the orbits of the elements of X under the actions of the group generated by σ . In particular, we wish to understand the colors of the elements in these orbits. Let $x \in X \setminus \{w_0, \tau_{\text{R}}(w_0)\}$. Since c permits τ_{R} , it follows that $c(x) = c(\tau_{\text{R}}(x))$, so τ_{R} is color-preserving on $X \setminus \{w_0, \tau_{\text{R}}(w_0)\}$. As c is not defined on w_0 , τ_{R} is not color-preserving on $\{w_0, \tau_{\text{R}}(w_0)\}$. Similarly, τ_{B} is color-preserving on $X \setminus \{w_0, \tau_{\text{B}}(w_0)\}$. Observe that

$$\begin{aligned} c(\sigma(w_0)) &= c(\tau_{\text{B}}(\tau_{\text{R}}(w_0))) = c(\tau_{\text{R}}(w_0)) = \text{R} \\ c(\sigma^{-1}(w_0)) &= c(\tau_{\text{R}}(\tau_{\text{B}}(w_0))) = c(\tau_{\text{B}}(w_0)) = \text{B} \end{aligned}$$

hold for our definitions of τ_{R} and τ_{B} .

Now let $x \in X \setminus \{w_0, \tau_{\text{R}}(w_0), \sigma^{-1}(w_0)\}$. It follows that $c(x) = c(\tau_{\text{R}}(x)) = c(\tau_{\text{B}}(\tau_{\text{R}}(x))) = c(\sigma(x))$. The only elements whose image do not have the same color under σ are: $\sigma^{-1}(w_0)$, whose image is a blank; $\tau_{\text{R}}(w_0)$, whose image is the blue element $\tau_{\text{B}}(w_0)$; and w_0 , which is itself a blank. Therefore σ is, in a sense, nearly color-preserving.

All of these observations regarding the behavior of the permitted reflections of non-forbidden extensions are summarized in the following fact.

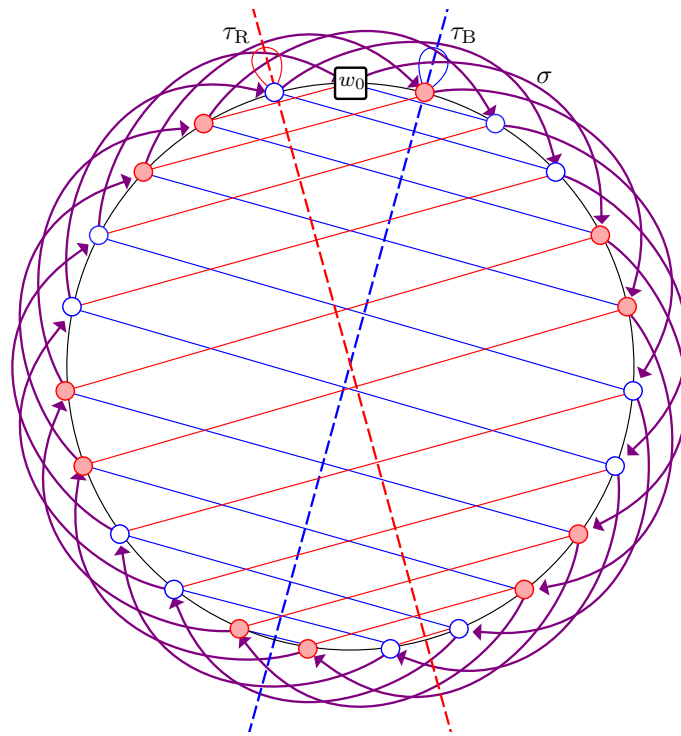

(a) Building σ from τ_R and τ_B for cycles and circles.

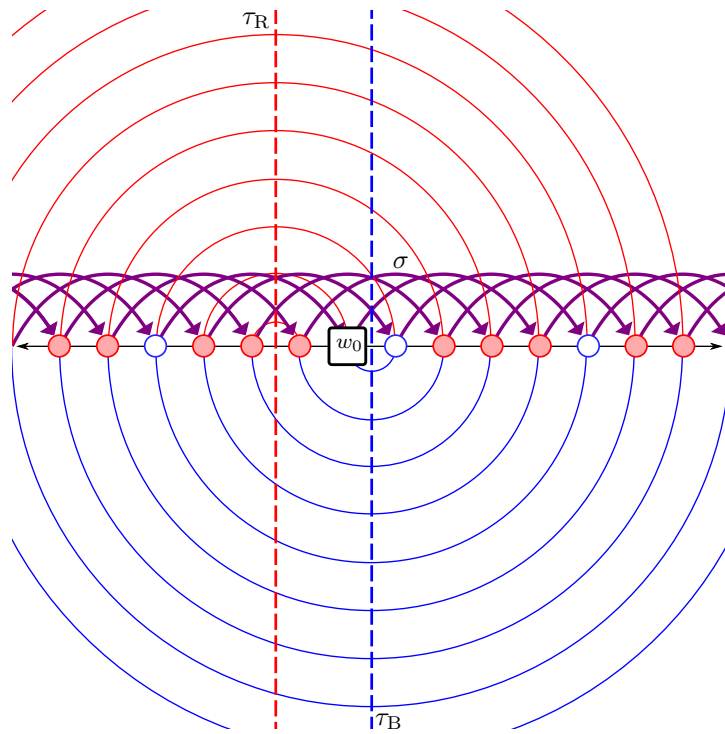

(b) Building σ from τ_R and τ_B for the real line.

Figure 2: Building σ_i .

Fact 6. Let c be a non-forbidden extension of c_0 to $W \setminus \{w_0\}$, let τ_R and τ_B be the red and blue reflections permitted by c , respectively, and let $\sigma = \tau_B \circ \tau_R$. The following properties hold:

(F0) $c(\sigma(w_0)) = R$ and $c(\sigma^{-1}(w_0)) = B$;

(F1) σ maps a red element to a blue element only at $\tau_R(w_0) \xrightarrow{\sigma} \tau_B(w_0)$;

(F2) σ never maps a blue element to a red element, and σ^2 maps a blue element to a red element only at $\sigma^{-1}(w_0) \xrightarrow{\sigma} w_0 \xrightarrow{\sigma} \sigma(w_0)$;

(F3) $c(\sigma(x)) = c(x)$ for all elements $x \notin \{\tau_R(w_0), \sigma^{-1}(w_0), w_0\}$.

Figure 3 shows the possible colorings of the orbit of σ containing w_0 . This orbit is either infinite or finite, and may or may not contain $\tau_R(w_0)$ and $\tau_B(w_0)$. In particular, when $X = \mathbb{R}$, the orbit is always infinite. When $X = \mathbb{R}/\mathbb{Z}$, the orbit may be infinite or finite. When $X = C_n$, the orbit is always finite.

Suppose that c_1 and c_2 are two non-forbidden extensions and assume that c_1 and c_2 do not extend to distinguishing colorings. For each $i \in \{1, 2\}$, let $\tau_R^{(i)}$ and $\tau_B^{(i)}$ be the red and blue reflections permitted by c_i and let σ_i be the rotation generated by c_i . Both σ_1 and σ_2 satisfy Fact 6 for their respective colorings. We consider how σ_1 and σ_2 interact. Some possible relationships between σ_1 and σ_2 are demonstrated in Figure 4.

Suppose that σ_1 has infinite order. If $\sigma_1^i \neq \sigma_2^j$ for all integers i and j (not both 0), then σ_2 has infinite order and each σ_1 -orbit intersects each σ_2 -orbit in at most one element. Thus the orbit of w_0 under the action of the group generated by σ_1 and σ_2 has a lattice structure, as in Figure 4(a). Otherwise, there are integers i, j , not both 0, such that $\sigma_1^i = \sigma_2^j$. If $i = 0$, then σ_2 has finite order, and the orbit of w_0 under σ_1 and σ_2 has a cylindrical structure. If $|i| > 0$ and $|j| \geq 2$, then σ_2 has infinite order and these actions have a shifted cylindrical structure as in Figure 4(b). When $\sigma_1^i = \sigma_2$ for some i , then we say that these actions form a *linear lattice* as in Figure 4(c).

If both σ_1 and σ_2 have finite order, then these actions define a torus as in Figure 4(d). In particular when $\sigma_1^i = \sigma_2$, we say that the actions form a circular lattice. Observe that when $X = C_n$ where n is prime, σ_1 and σ_2 automatically generate a circular lattice.

To obtain a contradiction, we choose c_1 and c_2 subject to a specified set of criteria. We then prove that σ_1 and σ_2 cannot coexist with their given color-preserving properties. This contradicts the assumption that every extension of c_1 or c_2 permits a color-preserving reflection.

4 The Arrangement of Blanks

In this section we will assume that the set W satisfies some additional geometric conditions. These conditions guarantee the existence of an element $w_0 \in W$ such that the reflection about w_0 maps elements in $W \setminus \{w_0\}$ to elements not in W . Our main theorems follow by demonstrating the existence of a subset of W satisfying these special properties.

Let X be the real line, the unit circle, or a cycle. Every cycle has a faithful embedding into the circle, so we will use the image of such an embedding. Thus every translation can be expressed as $x \mapsto x + \alpha$ for some real number $\alpha \in (0, 1)$. Given a set $W \subset X$ and a real number α , define $W + \alpha = \{w + \alpha : w \in W\}$.

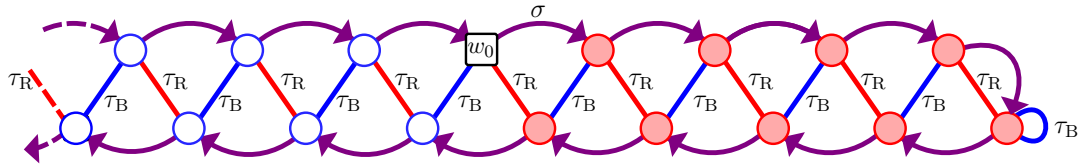

(a) *Infinite Blue Case*, $|\sigma| = \infty$ and $\tau_R(w_0) = \sigma^k(w_0)$ for $k \geq 1$.

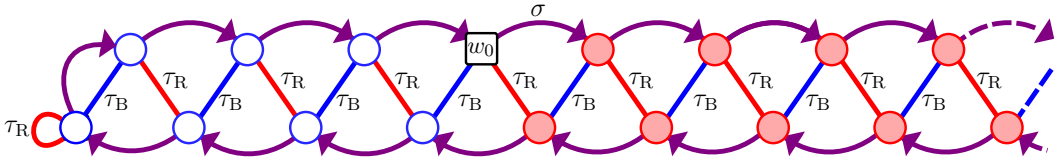

(b) *Infinite Red Case*, $|\sigma| = \infty$ and $\tau_R(w_0) = \sigma^{-k}(w_0)$ for $k \geq 1$.

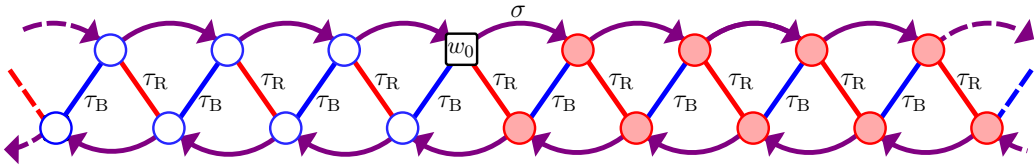

(c) *Doubly Infinite Case*, $|\sigma| = \infty$ and $\tau_R(w_0) \neq \sigma^k(w_0)$ for $k \in \mathbb{Z}$.

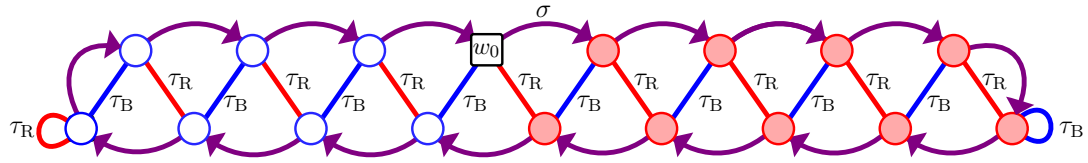

(d) *Finite Case*, $|\sigma| < \infty$.

Figure 3: The different traversals of σ .

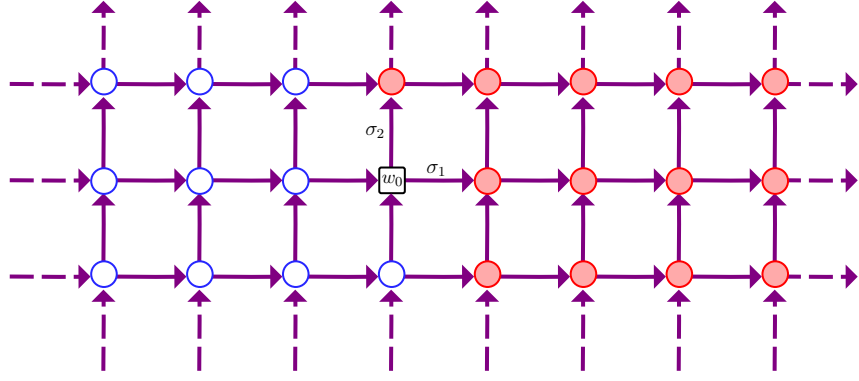

(a) A lattice when $|\sigma_1| = \infty$ and $\sigma_1^i \neq \sigma_2^j$ for all $i, j \neq 0$.

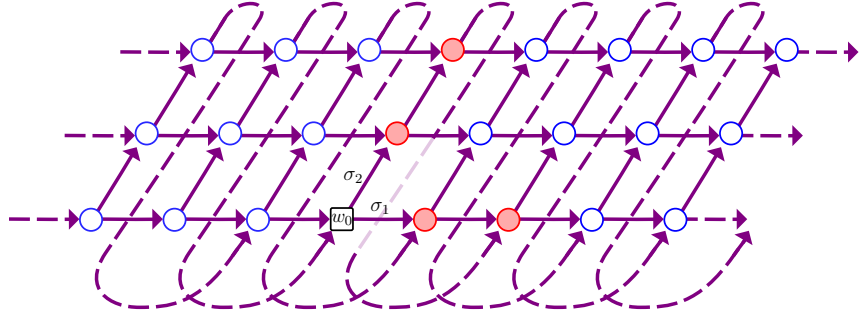

(b) A cylindrical lattice when $|\sigma_1| = \infty$ and $\sigma_1^2 = \sigma_2^3$.

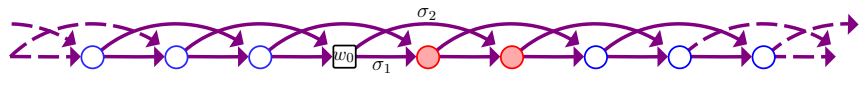

(c) A linear lattice when $|\sigma_1| = \infty$ and $\sigma_2 = \sigma_1^2$.

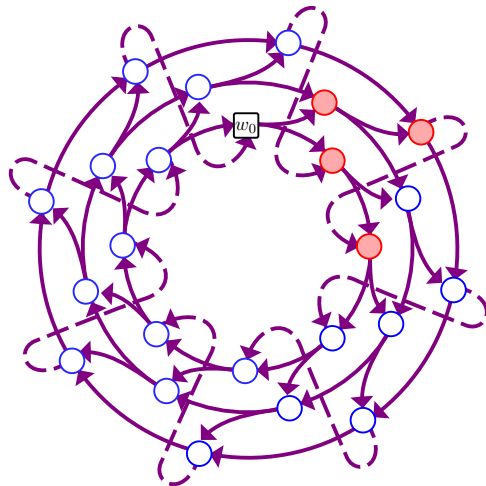

(d) A toroidal lattice when $|\sigma_1| < \infty$.

Figure 4: The translations σ_1 and σ_2 form lattices of different kinds.

Hypothesis (Divisibility Condition). Assume that W satisfies $(W + \frac{i}{k}) \cap W = \emptyset$ for all $k \in \{2, 3, 4, 5\}$ and all $i \in \{1, \dots, k-1\}$.

We will prove the following theorem.

Theorem 7. *If $W \subset X$ with $|W| = 4$ satisfies the Divisibility Condition, then every precoloring $c : X \setminus W \rightarrow \{\mathbb{R}, \mathbb{B}\}$ extends to a distinguishing 2-coloring of X .*

Note that not every choice of W will satisfy the divisibility condition. However, we will show later in Lemma 13 that when X is the unit circle or a cycle, if $W \subset X$ and $|W| \geq 16$, then there exists a 4-element subset of W that satisfies the condition. Therefore, Theorem 7 and Lemma 13 imply Theorem 4.

Observe that for any distinguishing coloring c of \mathbb{R} and any nonzero real number α , the coloring $c'(x) = c(\alpha x)$ is also distinguishing. Further note that if $W \subset \mathbb{R}$ with $|W| < \infty$ does not satisfy the divisibility condition, then there exists a nonzero α such that the set $W' = \{\alpha w : w \in W\}$ satisfies the divisibility condition. Thus, if $c : \mathbb{R} \setminus W \rightarrow \{\mathbb{R}, \mathbb{B}\}$ is a precoloring, then any distinguishing extension of the precoloring $c' : \mathbb{R} \setminus W' \rightarrow \{\mathbb{R}, \mathbb{B}\}$ defined by $c'(x) = c(\alpha x)$ induces a distinguishing extension of c . Therefore, Theorem 7 also implies Theorem 1.

Observation 1. Let W satisfy the Divisibility Condition and let $|W| \leq 4$. If σ is a translation, then every σ -orbit contains at least one element not in W . If σ has order at least 3, then every σ -orbit contains at least two elements not in W .

Lemma 3. *If $W \subset X$ has $|W| = 4$ and satisfies the Divisibility Condition, then there exists an element $w_0 \in W$ such that the reflection τ_{w_0} about w_0 maps all elements in $W \setminus \{w_0\}$ to elements not in W .*

Proof. If $X = \mathbb{R}$, then set $w_0 = \min W$. If $X = C_n$, we may assume that $W \subset \mathbb{R}/\mathbb{Z}$ by using the faithful embedding of C_n into \mathbb{R}/\mathbb{Z} , and so we assume that $X = \mathbb{R}/\mathbb{Z}$. Let $W = \{x_1, x_2, x_3, x_4\}$ labeled in clockwise order, and without loss of generality assume that $x_1 = 0$. Assume for the purposes of obtaining a contradiction that τ_{x_i} maps an element of $W \setminus \{x_i\}$ to an element of $W \setminus \{x_i\}$ for all $x_i \in W$.

If $\tau_{x_1} : x_2 \rightarrow x_4$, then $x_2 = \alpha$ and $x_4 = 1 - \alpha$ for some $\alpha \in (0, 1/2)$. Since $\alpha \neq 1/3$, we conclude that $\tau_{x_2}(x_1) \neq x_4$. Therefore $\tau_{x_2}(x_3) \in \{x_1, x_4\}$. By symmetry $\tau_{x_4}(x_3) \in \{x_1, x_2\}$. Therefore $x_3 \in \{2\alpha, 3\alpha\} \cap \{1 - 2\alpha, 1 - 3\alpha\}$. Since $1 = x_3 + (1 - x_3)$, we conclude that $1 \in \{4\alpha, 5\alpha, 6\alpha\}$. By the Divisibility Condition, we conclude that $\alpha = 1/6$. However, in this case, $x_3 = 1/2$, contradicting the Divisibility Condition. Therefore we may assume that $\tau_{x_i}(x_{i+1}) \neq x_{i-1}$ for all $i \in [4]$ with indices taken modulo 4.

Now, without loss of generality, assume that $\tau_{x_1} : x_2 \rightarrow x_3$. Thus $x_2 = \alpha$ and $x_3 = 1 - \alpha$ for some $\alpha \in (0, 1/2)$. By the Divisibility Condition, $\alpha \neq 1/3$, so $\tau_{x_3}(x_2) \neq x_1$. Since $x_3 \in (1/2, 1)$ and $x_4 \in (x_3, 1)$ it follows that $\tau_{x_3}(x_4) \neq x_1$. Therefore $\tau_{x_3}(x_2) = x_4$, and by the previous paragraph, we reach a contradiction. ■

Let $c : X \setminus W \rightarrow \{\mathbb{R}, \mathbb{B}\}$ be a precoloring of $X \setminus W$ and assume that c does not extend to a distinguishing coloring of X . Let c_1 be an extension of c to $X \setminus \{w_0\}$.

Lemma 4. *Let $W \subset X$ satisfy the Divisibility Condition with $|W| = 4$. Let w_0 be an element in W such that τ_{w_0} maps elements in $W \setminus \{w_0\}$ to elements not in W . There exist at most two forbidden extensions of c to $X \setminus \{w_0\}$.*

Proof. Since τ_{w_0} sends elements in $W \setminus \{w_0\}$ to elements not in W , the only extension that might permit τ_{w_0} is the coloring $c(w) = c(\tau_{w_0}(w))$ for all $w \in W - w_0$.

Assume that c_1 and c_2 are two distinct extensions of c that permit translations γ_1 and γ_2 , respectively, defined by $\gamma_1 : x \mapsto x + \alpha_1$ and $\gamma_2 : x \mapsto x + \alpha_2$ for some nonzero real numbers α_1 and α_2 . Let $w \in W$ such that $c_1(w) \neq c_2(w)$. For each $i \in \{1, 2\}$, define \mathcal{O}_w^i to be $\{\gamma_i^j(w) : j \in \mathbb{Z}\}$, the orbit of w under γ_i . If $\mathcal{O}_w^1 = \mathcal{O}_w^2$ then $\mathcal{O}_w^1 \subset W$, since the color of \mathcal{O}_w^1 under c_1 must disagree with the color of \mathcal{O}_w^2 under c_2 . This follows because γ_1 preserves c_1 , so $c_1(w) = c_1(x)$ for all $x \in \mathcal{O}_w$, and γ_1 preserves c_2 , so $c_2(w) = c_2(x)$ for all $x \in \mathcal{O}_w$. Therefore $2 \leq |\mathcal{O}_w| \leq 4$, violating the Divisibility Condition. Thus, if γ_1 and γ_2 have finite orders (hence $X \neq \mathbb{R}$), then they have distinct orders.

Suppose that γ_1 has order 2 and γ_2 has even order. Therefore $w + \frac{1}{2}$ is in both the γ_1 -orbit and γ_2 -orbit of w , and by the Divisibility Condition $w + \frac{1}{2} \notin W$. Therefore $c_1(w) = c_1(w + \frac{1}{2}) = c_2(w + \frac{1}{2}) = c_2(w)$, a contradiction.

In the remaining cases, we assume without loss of generality that γ_1 has order at least 3 and γ_2 either has order 2 or order greater than the order of γ_1 . Thus, for all γ_1 -orbits \mathcal{O} , we have that $|\mathcal{O}| \geq 3$, \mathcal{O} is monochromatic in c_1 , and $\gamma_2(\mathcal{O}) \cap \mathcal{O} = \emptyset$. If the order of γ_1 is at most 5, then $|\mathcal{O} \cap W| \leq 1$ and $|\gamma_2(\mathcal{O}) \cap W| \leq 1$ by the Divisibility Condition. Therefore there is $x \in \mathcal{O}$ such that x and $\gamma_2(x)$ are not in W , and both \mathcal{O} and $\gamma_2(\mathcal{O})$ are the same color under c_1 . If γ_1 has order at least 6, then there are at least six pairs of the form $(x, \gamma_2(x))$ where $x \in \mathcal{O}$, so there is $x \in \mathcal{O}$ such that x and $\gamma_2(x)$ are not in W . Therefore \mathcal{O} and $\gamma_2(\mathcal{O})$ are the same color in under c_1 . It then follows that for all integers k , the orbits \mathcal{O} and $\gamma_2^k(\mathcal{O})$ are the same color under c_1 .

By Observation 1, there is a value ℓ_2 such that $\gamma_2^{\ell_2}(w) \notin W$. Again, let \mathcal{O}_w be the γ_1 -orbit of w , and note that \mathcal{O}_w and $\gamma_2^{\ell_2}(\mathcal{O}_w)$ have the same color under c_1 . Therefore,

$$c_1(w) = c_1(\gamma_2^{\ell_2}(w)) = c_2(\gamma_2^{\ell_2}(w)) = c_2(w),$$

a contradiction. ■

5 Proofs of the Main Theorems

In this section, we will complete the proofs of Theorem 1, 3, and 4 by proving Theorem 7.

Let W be a set of four elements in X satisfying the Divisibility Condition, and let $w_0 \in W$ be the element guaranteed by Lemma 3. Let $c : X \setminus W \rightarrow \{R, B\}$ be a precoloring of $X \setminus W$. We use a sequence of extremal choices to extend c to a coloring c_1 of $X \setminus \{w_0\}$. We then select a subset $W' \subseteq W \setminus \{w_0\}$ and obtain the coloring c_2 by changing the colors of the elements in W' . Our choices will guarantee that both c_1 and c_2 are not the (at most) two forbidden colorings guaranteed by Lemma 4. By assumption, neither c_1 nor c_2 extends to a distinguishing coloring, and we then use Fact 6 to derive a contradiction.

Suppose that c_1 is a non-forbidden extension of c to $X \setminus \{w_0\}$. Let \mathcal{O}_0 be the orbit of w_0 under the rotation σ_1 generated by c_1 . Let \mathcal{O}_0^R be the set of elements in \mathcal{O}_0 colored red by c_1 and let \mathcal{O}_0^B be the set of elements in \mathcal{O}_0 colored blue by c_1 .

Hypothesis (Selection criteria for c_1). Among the non-forbidden extensions of c to $X \setminus \{w_0\}$, select c_1 so that the following conditions are satisfied:

(C0) $|\mathcal{O}_0|$ is maximum.

(C1) Subject to (C0), if c' is a nonforbidden extension of c to $X \setminus \{w_0\}$ and $\mathcal{O}_{c'}$ is the orbit of w_0 under the action of the rotation generated by c' , then $\mathcal{O}_0 \not\subseteq \mathcal{O}_{c'}$.

(C2) Subject to (C0) and (C1), $\min\{|\mathcal{O}_0^R|, |\mathcal{O}_0^B|\}$ is maximum.

Note that these conditions are satisfied by at least one coloring since there are a finite number of extensions of c to $X \setminus \{w_0\}$. We now discuss some structural relationships between the rotation σ_1 and the locations of the elements of W subject to the selection hypothesis.

Observation 2. Since the reflection about w_0 sends all elements of $W \setminus \{w_0\}$ to elements not in W , we have that

1. there is at most one element of W among $\sigma_1(w_0)$ and $\sigma_1^{-1}(w_0)$, and
2. there is at most one element of W among $\sigma_1(w_0) + \frac{1}{2}$ and $\sigma_1^{-1}(w_0) + \frac{1}{2}$.

Lemma 5. If $\min\{|\mathcal{O}_0^R|, |\mathcal{O}_0^B|\} < \infty$, then $\tau_R^{(1)}(w_0)$ and $\tau_B^{(1)}(w_0)$ are not both in W . In particular, $\tau_R^{(1)}(w_0) \notin W$ if $|\mathcal{O}_0^R| < |\mathcal{O}_0^B| - 1$ and $\tau_B^{(1)}(w_0) \notin W$ if $|\mathcal{O}_0^B| < |\mathcal{O}_0^R| - 1$.

Proof. If $|\mathcal{O}_0^R| = |\mathcal{O}_0^B| < \infty$, then $\tau_{w_0}(\tau_R^{(1)}(w_0)) = \tau_B^{(1)}(w_0)$, and the statement follows by the definition of w_0 . If $||\mathcal{O}_0^R| - |\mathcal{O}_0^B|| = 1$, then $X \neq \mathbb{R}$ and one of $\tau_R^{(1)}(w_0)$ or $\tau_B^{(1)}(w_0)$ is equal to $w_0 + \frac{1}{2}$. The element $w_0 + \frac{1}{2}$ is not a blank by the Divisibility Condition.

Otherwise, suppose that $|\mathcal{O}_0^R| < |\mathcal{O}_0^B| - 1$ and hence $|\mathcal{O}_0^R| < \infty$; the case when $|\mathcal{O}_0^B| < |\mathcal{O}_0^R| - 1$ follows by a similar argument. If $\tau_B^{(1)}(w_0) \in W$, then let c' be the coloring that matches c_1 with the exception that $c'(\tau_B^{(1)}(w_0)) = R$. Observe that \mathcal{O}_0 is the only σ_1 -orbit that is nonmonochromatic under c' . Let τ' be a reflection and σ' be a rotation. Note that $\tau'(\mathcal{O}_0)$ and $\sigma'(\mathcal{O}_0)$ are both σ_1 -orbits. Since at least half of the elements in \mathcal{O}_0 are blue under c' , the σ' -orbit of $\sigma_1(w_0)$ contains a blue element under c' , and hence c' does not permit σ' . Since $c'(\sigma_1(w_0)) \neq c'(\sigma_1^{-1}(w_0))$, c' does not permit τ_{w_0} and thus c' is not forbidden.

Therefore, the two extensions of c' to w_0 only permit reflections, call them τ'_R and τ'_B when $c'(w_0) = R$ and $c'(w_0) = B$, respectively. Observe that $\tau'_R(w_0) = \tau_R^{(1)}(w_0)$ and $\tau'_B(w_0) = \sigma_1(\tau_B^{(1)}(w_0))$. Thus $\tau'_B \circ \tau'_R = \sigma_1$, so σ_1 is the rotation generated by c' . However, \mathcal{O}_0 has more red elements under c' than c_1 , contradicting (C2) in the selection criteria for c_1 . ■

We define a set $W' \subseteq W \setminus \{w_0\}$ depending on the number of elements of each color in \mathcal{O}_0 as follows.

Hypothesis (Selection of W').

1. If $\{\tau_R^{(1)}(w_0), \tau_B^{(1)}(w_0)\} \subseteq W$, then let $W' = \{\tau_R^{(1)}(w_0), \tau_B^{(1)}(w_0)\}$.

2. If $\{\tau_{\mathbb{R}}^{(1)}(w_0), \tau_{\mathbb{B}}^{(1)}(w_0)\} \not\subseteq W$ and $\min\{|\mathcal{O}_0^{\mathbb{R}}|, |\mathcal{O}_0^{\mathbb{B}}|\} > 1$, then select

$$w' \in W \setminus \{w_0, \sigma_1(w_0), \sigma_1^{-1}(w_0), \tau_{\mathbb{R}}^{(1)}(w_0), \tau_{\mathbb{B}}^{(1)}(w_0)\},$$

and let $W' = \{w'\}$.

3. If $\{\tau_{\mathbb{R}}^{(1)}(w_0), \tau_{\mathbb{B}}^{(1)}(w_0)\} \not\subseteq W$ and $\min\{|\mathcal{O}_0^{\mathbb{R}}|, |\mathcal{O}_0^{\mathbb{B}}|\} = 1$, then select

$$w' \in W \setminus \left\{ w_0, \sigma_1(w_0), \sigma_1^{-1}(w_0), \tau_{\mathbb{R}}^{(1)}(w_0), \tau_{\mathbb{B}}^{(1)}(w_0), \sigma_1(w_0) + \frac{1}{2}, \sigma_1^{-1}(w_0) + \frac{1}{2} \right\},$$

and let $W' = \{w'\}$.

We claim that the above choice is well-defined. If $\{\tau_{\mathbb{R}}^{(1)}(w_0), \tau_{\mathbb{B}}^{(1)}(w_0)\}$ is not a subset of W and $\min\{|\mathcal{O}_0^{\mathbb{R}}|, |\mathcal{O}_0^{\mathbb{B}}|\} > 1$, then such an element w' exists by Observation 2 and Lemma 5. If $\min\{|\mathcal{O}_0^{\mathbb{R}}|, |\mathcal{O}_0^{\mathbb{B}}|\} = 1$, then either $\sigma_1(w_0) = \tau_{\mathbb{R}}^{(1)}(w_0)$ or $\sigma_1^{-1}(w_0) = \tau_{\mathbb{B}}^{(1)}(w_0)$, and by Lemma 5 there is at most one blank among $\{\sigma_1(w_0), \tau_{\mathbb{R}}^{(1)}(w_0), \tau_{\mathbb{B}}^{(1)}(w_0), \sigma_1^{-1}(w_0)\}$. Furthermore, Observation 2 implies there is at most one blank among $\sigma_1(w_0) + \frac{1}{2}$ and $\sigma_1^{-1}(w_0) + \frac{1}{2}$, and hence the choice for w' is possible.

Define c_2 to be the coloring obtained from c_1 by changing the colors of the elements in W' . We will show that c_2 is not forbidden.

Lemma 6. *The coloring c_2 does not permit the translation of order 2.*

Proof. Let γ be the translation of order 2, and hence $X \neq \mathbb{R}$. Suppose that c_2 permits γ . Fix $c_2(w_0)$ such that γ preserves c_2 ; for this proof, let $c_1(w_0) = c_2(w_0)$. Consider cases based on how W' was selected.

Suppose $W' = \{\tau_{\mathbb{R}}^{(1)}(w_0), \tau_{\mathbb{B}}^{(1)}(w_0)\}$, which implies that $|\mathcal{O}_0^{\mathbb{R}}| = |\mathcal{O}_0^{\mathbb{B}}| = \infty$ by Lemma 5. Therefore, \mathcal{O}_0 and the σ_1 -orbit containing $\tau_{\mathbb{R}}^{(1)}(w_0)$ are the two nonmonochromatic σ_1 -orbits under c_2 . Since $|\mathcal{O}_0| = \infty$, we have that $\gamma(\mathcal{O}_0)$ is a distinct σ_1 -orbit and hence $\gamma(\tau_{\mathbb{R}}^{(1)}(w_0)), \gamma(\tau_{\mathbb{B}}^{(1)}(w_0)) \in \mathcal{O}_0$. Recall $\sigma_1(\tau_{\mathbb{R}}^{(1)}(w_0)) = \tau_{\mathbb{B}}^{(1)}(w_0)$. Hence $c_2(\sigma_1^{-1}(\tau_{\mathbb{R}}^{(1)}(w_0))) = \mathbb{R}$, $c_2(\tau_{\mathbb{R}}^{(1)}(w_0)) = \mathbb{B}$, and $c_2(\sigma_1(\tau_{\mathbb{R}}^{(1)}(w_0))) = \mathbb{R}$. There does not exist an integer i such that $c_2(\sigma_1^{i-1}(w_0)) = \mathbb{R}$, $c_2(\sigma_1^i(w_0)) = \mathbb{B}$, $c_2(\sigma_1^{i+1}(w_0)) = \mathbb{R}$, and hence c_2 does not permit γ .

We may now assume that $\{\tau_{\mathbb{R}}^{(1)}(w_0), \tau_{\mathbb{B}}^{(1)}(w_0)\} \not\subseteq W$ and $W' = \{w'\}$. Observe that $c_1(\sigma_1^{-1}(w')) = c_1(w') = c_1(\sigma_1(w'))$, but $c_2(\sigma_1^{-1}(w')) \neq c_2(w')$ and $c_2(w') \neq c_2(\sigma_1(w'))$. Let $x = \gamma(w') = w' + \frac{1}{2}$. Since $|\sigma_1| \geq 3$, we conclude that $w' \notin \{\sigma_1^{-1}(x), x, \sigma_1(x)\}$ and $c_1(y) = c_2(y)$ for all $y \in \{\sigma_1^{-1}(x), x, \sigma_1(x)\}$. Therefore, $c_1(\sigma_1^{-1}(x)) \neq c_1(x)$ and $c_1(x) \neq c_1(\sigma_1(x))$. This implies that $x \in \mathcal{O}_0$ and x is the only element in \mathcal{O}_0 of color $c_1(x)$ under c_1 . Hence $\min\{|\mathcal{O}_0^{\mathbb{R}}|, |\mathcal{O}_0^{\mathbb{B}}|\} = 1$ and $\gamma(w') \in \{\sigma_1(w_0), \sigma_1^{-1}(w_0)\}$. But this implies that $w' \in \{\sigma_1(w_0) + \frac{1}{2}, \sigma_1^{-1}(w_0) + \frac{1}{2}\}$, contradicting our choice of w' . \blacksquare

The following technical lemma will be used extensively.

Lemma 7. *Let γ be a translation such that*

1. γ has order at least 3,

2. the γ -orbits of $\sigma_1^{-1}(w_0)$, w_0 , and $\sigma_1(w_0)$ are distinct, and
3. γ preserves c_2 on the γ -orbits of $\sigma_1^{-1}(w_0)$ and $\sigma_1(w_0)$.

For $j \in \{-1, 0, 1\}$, let S_j be the γ -orbit of $\sigma_1^j(w_0)$. If $1 \leq i < |\gamma|$, then

1. $|\{\gamma^i(\sigma_1(w_0)), \gamma^i(\sigma_1^{-1}(w_0))\} \cap W'| \geq 1$,
2. $|W'| \geq |\gamma| - 1$,
3. γ has order exactly 3,
4. $W' \subset S_{-1} \cup S_1$, and
5. $W' = \{\tau_R^{(1)}(w_0), \tau_B^{(1)}(w_0)\}$.

Proof. If $\{\gamma^i(\sigma_1(w_0)), \gamma^i(\sigma_1^{-1}(w_0))\} \cap W' = \emptyset$ for some $i \in [|\gamma| - 1]$, then $c_1(\gamma^i(\sigma_1^{-1}(w_0))) = B$ and $c_1(\gamma^i(\sigma_1(w_0))) = R$. Therefore, σ_1^2 maps the blue element $\gamma^i(\sigma_1^{-1}(w_0))$ to the red element $\gamma^i(\sigma_1(w_0))$ under c_1 . By Fact 6, we conclude that $\gamma^i(\sigma_1^{-1}(w_0)) = \sigma_1^{-1}(w_0)$ and $\gamma^i(\sigma_1(w_0)) = \sigma_1(w_0)$, contradicting the assumption that $1 \leq i \leq |\gamma| - 1$. Therefore $c_1(\gamma^i(\sigma_1(w_0))) = B$ or $c_1(\gamma^i(\sigma_1^{-1}(w_0))) = R$, and consequently at least one of these elements must be in W' , proving conclusion 1. Conclusions 2–4 follow directly from conclusion 1 and Lemma 6. Conclusion 5 follows since $\{\tau_R^{(1)}(w_0), \tau_B^{(1)}(w_0)\}$ is the only choice of W' that has two elements. \blacksquare

Lemma 8. c_2 is not forbidden.

Proof. The reflection about w_0 maps the red element $\sigma_1(w_0)$ to the blue element $\sigma_1^{-1}(w_0)$, and hence c_2 does not permit τ_{w_0} . Suppose c_2 permits a translation γ . By Lemma 6, γ has order at least 3. Since γ preserves c_2 and $\sigma_1(w_0), \sigma_1^{-1}(w_0) \notin W'$, the γ -orbits of $\sigma_1(w_0)$ and $\sigma_1^{-1}(w_0)$ are distinct, and hence also are distinct from the γ -orbit of w_0 . Therefore Lemma 7 applies to γ , so γ has order exactly 3 and $W' = \{\tau_R^{(1)}(w_0), \tau_B^{(1)}(w_0)\}$.

If $\gamma(\mathcal{O}_0) \neq \mathcal{O}_0$, then $\mathcal{O}_0, \gamma(\mathcal{O}_0), \gamma^2(\mathcal{O}_0)$ are distinct. Since there are at most two nonmonochromatic σ_1 -orbits under c_1 , we assume without loss of generality that $\gamma(\mathcal{O}_0)$ is monochromatic under c_1 (since c_2 also permits γ^{-1}). However, $W' \cap \gamma(\mathcal{O}_0) = \emptyset$ and therefore either the γ -orbit of $\sigma_1(w_0)$ or the γ -orbit of $\sigma_1^{-1}(w_0)$ is not monochromatic under c_2 , a contradiction. \blacksquare

Let σ_2 be the rotation generated by c_2 (as in Fact 6). We will demonstrate that σ_2 does not satisfy Fact 6 under c_2 .

Lemma 9. $|\sigma_2| < \infty$.

Proof. Suppose $|\sigma_2| = \infty$. By (C0), we also have that $|\sigma_1| = \infty$. For $i \in \mathbb{Z}$, let S_i be the σ_2 -orbit of $\sigma_1^i(w_0)$. For any $w \in W'$, $c_2(w) \neq c_2(\sigma_1(w))$ and hence $\sigma_2 \neq \sigma_1$. Since $\sigma_1^{-1}(w_0) \notin W'$, we have that $\sigma_2 \neq \sigma_1^{-1}$. Therefore, $S_0 \notin \{S_1, S_{-1}\}$.

Suppose that $S_1 \neq S_{-1}$ and hence at least one of S_1 or S_{-1} is monochromatic under c_2 . If $\min\{|\mathcal{O}_0^R|, |\mathcal{O}_0^B|\} = \infty$, then $|S_1 \cap \mathcal{O}_0| = |S_{-1} \cap \mathcal{O}_0| = 1$ and hence for some $\ell \geq 1$, $\sigma_2^\ell(\mathcal{O}_0)$ is monochromatic under c_2 . However, there are now an infinite number of integers $k > 0$ such that

$c_2(\sigma_1^k(w_0)) = \text{R}$ and $c_2(\sigma_1^{-k}(w_0)) = \text{B}$, so $c_2(\sigma_2^\ell(\sigma_1^k(w_0))) \neq c_2(\sigma_2^\ell(\sigma_1^{-k}(w_0)))$, a contradiction. Thus $\min\{|\mathcal{O}_0^{\text{R}}|, |\mathcal{O}_0^{\text{B}}|\} < \infty$ and therefore S_0 is the only nonmonochromatic σ_2 -orbit under c_2 . This implies that S_1 and S_{-1} are monochromatic under c_2 , so Lemma 7 applies and $|\sigma_2| = 3$.

Thus $S_1 = S_{-1}$. Since $\sigma_1(w_0), \sigma_1^{-1}(w_0) \in S_1$, then S_1 is not monochromatic and thus there are two nonmonochromatic σ_2 -orbits under c_2 . Hence there are an infinite number of red elements and an infinite number of blue elements in both S_0 and S_1 under c_2 . Thus by (C0)–(C2), $|\mathcal{O}_0^{\text{R}}| = |\mathcal{O}_0^{\text{B}}| = \infty$. Let $i \in \mathbb{Z}$ be such that $\sigma_2^i(\sigma_1(w_0)) = \sigma_1^{-1}(w_0)$; note $\sigma_2^i = \sigma_1^{-2}$ and $i > 0$ by Fact 6. Also by Fact 6, $c_2(\sigma_2^{-\ell}(w_0)) = \text{B}$ for all $\ell \geq 1$. However, there exists an integer $k > 0$ such that $\sigma_2^{-ik}(w_0) \notin W'$ and hence for $\ell = ik$ we have

$$\text{B} = c_2(\sigma_2^{-\ell}(w_0)) = c_2(\sigma_2^{-ik}(w_0)) = c_1(\sigma_2^{-ik}(w_0)) = c_1(\sigma_1^{2k}(w_0)) = \text{R},$$

a contradiction. ■

Theorem 1 now follows directly from Lemma 9.

Theorem 1. $\text{ext}_D(\mathbb{R}) = 4$.

Proof of Theorem 1. Let $W \subset \mathbb{R}$ be a set of size four, and let $w_0 = \min W$. Thus τ_{w_0} sends all elements of $W \setminus \{w_0\}$ to elements not in W . Let $c : \mathbb{R} \setminus W \rightarrow \{\text{R}, \text{B}\}$ be a precoloring of $\mathbb{R} \setminus W$, and let c_1 and c_2 be the extensions of c defined by the selection criteria (C0)–(C2) and the definition of W' . The coloring c_1 is not forbidden by choice, and c_2 is not forbidden by Lemma 8. Lemma 9 implies that σ_2 , the translation generated by c_2 , satisfies $|\sigma_2| < \infty$. However, all translations of \mathbb{R} are of infinite order, a contradiction. Therefore there is a distinguishing extension of c . ■

For the remainder of the paper, we assume that $X \neq \mathbb{R}$. First we will show that if $|\sigma_1| = \infty$, then there is a distinguishing extension of c to X .

Lemma 10. $|\sigma_1| < \infty$.

Proof. Suppose otherwise that $|\sigma_1| = \infty$. Observe that $\sigma_1^i = \sigma_2^j$ if and only if $i = 0$ and $|\sigma_2|$ divides j . Thus, the σ_2 -orbits of $\sigma_1^{-1}(w_0)$, w_0 , and $\sigma_1(w_0)$ are distinct. Since $|\sigma_2| < \infty$, there is exactly one nonmonochromatic σ_2 -orbit under c_2 and hence Lemma 7 applies, $|\sigma_2| = 3$, and $W' = \{\tau_{\text{R}}^{(1)}(w_0), \tau_{\text{B}}^{(1)}(w_0)\}$. The orbits $\mathcal{O}_0, \mathcal{O}_1, \mathcal{O}_2$ are distinct σ_1 -orbits, and hence W' is disjoint from \mathcal{O}_i for some $i \in \{1, 2\}$. Thus \mathcal{O}_i is monochromatic under both c_1 and c_2 , but

$$\text{B} = c_2(\sigma_1^{-1}(w_0)) = c_2(\sigma_2^i(\sigma_1^{-1}(w_0))) = c_2(\sigma_2^i(\sigma_1(w_0))) = c_2(\sigma_1(w_0)) = \text{R},$$

a contradiction. ■

We now have that $|\sigma_2| \leq |\sigma_1| < \infty$. Observe that each σ_i is a rotation about the circle $x \mapsto x + \frac{j}{|\sigma_i|}$ for some j relatively prime to $|\sigma_i|$. Therefore, $|\sigma_1| = |\sigma_2|$ if and only if σ_1 generates σ_2 and vice-versa. We want to show that σ_2 is generated by σ_1 .

Lemma 11. $|\sigma_1| = |\sigma_2|$ and hence σ_1 and σ_2 generate each other.

Proof. First note that by the extremal choice (C0), $|\sigma_2| = |\sigma_1|$ if and only if σ_2 generates σ_1 . Now suppose that $|\sigma_2| < |\sigma_1|$. Let S_j be the σ_2 -orbit of $\sigma_1^j(w_0)$. Since $|\mathcal{O}_0| = |\sigma_1| > |\sigma_2| = |S_0|$, the σ_2 -orbits S_0 and S_1 are distinct; similarly S_0 and S_{-1} are distinct. Since $|\sigma_2|$ is finite, S_0 is the only nonmonochromatic σ_2 -orbit under c_2 . Therefore, S_1 and S_{-1} are monochromatic under c_2 and $S_{-1} \neq S_1$ since $c_2(\sigma_1^{-1}(w_0)) \neq c_2(\sigma_1(w_0))$. However, since $|\mathcal{O}_0^R|, |\mathcal{O}_0^B| < \infty$, Lemmas 5 and 7 imply that $S_{-1} = S_1$, a contradiction. ■

We have now verified that σ_1 and σ_2 are both finite and generate each other. Observe that this is a trivial statement in the case that X is a cycle of prime order. We finish the proof by showing that σ_1 and σ_2 violate either Fact 6 or the extremal choices.

For all remaining cases, we will assume that $|\mathcal{O}_0^R| \leq |\mathcal{O}_0^B|$. The other case is symmetric by swapping colors and possibly negating the exponents on σ_1 . The following lemma completes the proof of Theorem 7.

Lemma 12. *If c_1 and c_2 are selected by the extremal choices (C0)–(C2) and the definition of W' , then there exists a distinguishing coloring of X .*

Proof. By Lemma 11, σ_1 and σ_2 generate each other. Since $|\mathcal{O}_0^R|, |\mathcal{O}_0^B| < \infty$, Lemma 5 implies that $W' = \{w'\}$. This further implies that $w' \in \mathcal{O}_0$, and since $w_0 \in \mathcal{O}_0 \setminus \{w'\}$, the Divisibility Condition implies that $|\mathcal{O}_0| \geq 6$. Let ℓ be the integer minimizing $|\ell|$ such that $\sigma_2 = \sigma_1^\ell$. Recall that $\sigma_1^{-1}(w_0), \sigma_1(w_0) \notin W'$ and thus $c_2(\sigma_1^{-1}(w_0)) = B$ and $c_2(\sigma_1(w_0)) = R$.

Suppose first that $\ell \in \{1, \dots, |\mathcal{O}_0^R|\}$. Thus $c_1(\sigma_1^{\ell-1}(w_0)) = R$ and $c_1(\sigma_1^{1-\ell}(w_0)) = B$. Since $\sigma_2(\{\sigma_1^{1-\ell}(w_0), \sigma_1^{-1}(w_0)\}) = \{\sigma_1(w_0), \sigma_1^{\ell-1}(w_0)\}$ and at most one of $\sigma_1^{\ell-1}(w_0)$ and $\sigma_1^{1-\ell}(w_0)$ is equal to w' , and thus σ_2 sends a blue element to a red element under c_2 , contradicting Fact 6.

Now suppose that $-\ell \in \{1, \dots, |\mathcal{O}_0^R|\}$. Thus $c_1(\sigma_1^{\ell-1}(w_0)) = B$ and $c_1(\sigma_1^{1-\ell}(w_0)) = R$. Since $\sigma_2(\{\sigma_1^{-1}(w_0), \sigma_1^{1-\ell}(w_0)\}) = \{\sigma_1^{\ell-1}(w_0), \sigma_1(w_0)\}$ and at most one of $\sigma_1^{\ell-1}(w_0)$ and $\sigma_1^{1-\ell}(w_0)$ is equal to w' , and thus σ_2 sends a blue element to a red element under c_2 , contradicting Fact 6.

Therefore we may assume that $|\mathcal{O}_0^R| < |\ell| \leq \lfloor \frac{|\sigma_1|}{2} \rfloor$. For all $x \in \mathcal{O}_0^R$, the element $\sigma_2^{-1}(x)$ is blue under c_1 . Thus $|\mathcal{O}_0^R| = 1$, but then there are two red elements in \mathcal{O}_0 (which is the σ_2 -orbit of w_0) under c_2 , violating extremal choice (C2). ■

Observe that the divisibility condition holds for any set $W \subset V(C_n)$ when the smallest prime divisor of n is at least 7, so Theorem 3 follows immediately from Theorem 7.

Theorem 3. *If the smallest prime divisor of n is at least 7, then $\text{ext}_D(C_n) = 4$.*

In the other cases, we must start with a larger set of blanks.

Lemma 13. *Let $W \subset \mathbb{R}/\mathbb{Z}$ be a set with $|W| \geq 16$. There exists a set $W' \subset W$ where $|W'| = 4$ and W' satisfies the Divisibility Condition.*

Proof. Split the circle into five intervals given by $[\frac{i}{5}, \frac{i+1}{5})$ for $i \in \{0, \dots, 4\}$. By the pigeonhole principle, there are at least four elements of W in one of these intervals. This set satisfies the Divisibility Condition. ■

Note that Theorem 7 and Lemma 13 imply Theorem 4.

Theorem 4. $\text{ext}_D(\mathbb{R}/\mathbb{Z}) \leq 16$.

Observe that the set of 15 elements given by $\{\frac{i}{15} : 0 \leq i \leq 14\}$ contains no four elements that satisfy the Divisibility Condition, so Theorem 4 is the best upper bound that is implied by Theorem 7. Further, we get the following upper bound on $\text{ext}_D(C_n)$ for general n . Let $\chi_n(i)$ be the indicator function that equals 1 if and only if i divides n .

Corollary 8. *Let $n \geq 6$. Then $\text{ext}_D(C_n) \leq 3(1 + \chi_n(2) + 2\chi_n(3) + 2\chi_n(4) + 4\chi_n(5)) + 1$.*

Proof. Let $W \subset V(C_n)$ have size $3(1 + \chi_n(2) + 2\chi_n(3) + 2\chi_n(4) + 4\chi_n(5)) + 1$. For each $w \in W$, there are at most $\chi_n(2) + 2\chi_n(3) + 2\chi_n(4) + 4\chi_n(5)$ elements in $W \cap \{w + \frac{i}{k} : 1 \leq i < k, 2 \leq k \leq 5\}$. Iteratively select a subset $W' = \{w_1, w_2, w_3, w_4\} \subset W$ of size four where $w_\ell \neq w_j + \frac{i}{k}$ for all $\ell > j$ and $1 \leq i < k \leq 5$. This restriction removes at most $1 + \chi_n(2) + 2\chi_n(3) + 2\chi_n(4) + 4\chi_n(5)$ elements from W in each of the first three selections of $w_1, w_2,$ and w_3 . At least one element remains to select w_4 . The set W' satisfies the Divisibility Condition and hence any coloring on $V(C_n) \setminus W$ extends arbitrarily to $V(C_n) \setminus W'$ and can be distinguished using Theorem 12. ■

6 Future Work

In addition to resolving Conjectures 2 and 5, we pose the following questions for future study.

Problem 9. Determine $\text{ext}_D(\mathbb{R}^k)$ for $k \geq 2$.

Problem 10. Determine $\text{ext}_D(\mathbb{S}^d)$ for $d \geq 2$.

Suppose $W \subset \mathbb{S}^d$ is a set of blanks and $c : \mathbb{S}^d \setminus W \rightarrow \{\mathbb{R}, \mathbb{B}\}$ is a 2-coloring of $\mathbb{S}^d \setminus W$ that does not extend to a distinguishing coloring of \mathbb{S}^d . Observe that $W' = W \cup \{0\} \subset \mathbb{R}^{d+1}$ is a set of blanks and

$$c'(\mathbf{x}) = \begin{cases} c(\mathbf{x}) & \text{if } \mathbf{x} \in \mathbb{S}^d, \\ \mathbb{R} & \text{otherwise} \end{cases}$$

is a 2-coloring of $\mathbb{R}^{d+1} \setminus W'$ that does not extend to a distinguishing coloring of \mathbb{R}^{d+1} . Therefore, $\text{ext}_D(\mathbb{S}^d) < \text{ext}_D(\mathbb{R}^d)$. This, together with Lemma 2 and the observation that the 3-dimensional cube has a faithful embedding into \mathbb{S}^2 , gives rise to the following conjectures, the first of which also follows from our conjecture that $\text{ext}_D(\mathbb{S}^1) = 6$.

Conjecture 11. $\text{ext}_D(\mathbb{R}^2) = 7$.

Conjecture 12. $\text{ext}_D(\mathbb{S}^2) = 9$.

Conjecture 13. $\text{ext}_D(\mathbb{R}^3) = 10$.

Finally, proper coloring and list-coloring versions of the distinguishing number were introduced in [20] and [21], respectively. We feel that studying these distinguishing parameters through the lens of precoloring extensions would be an interesting direction for further inquiry, in line with the broader precoloring extension literature discussed in the introduction.

References

- [1] M. Albertson, *You can't paint yourself into a corner*, J. Combin. Theory Ser. B **73** (1998), 189–194.
- [2] M. Albertson, *Distinguishing Cartesian powers of graphs*, Electron. J. Combin. **12** (2005), Note 17, 5 pp. (electronic).
- [3] M. Albertson and D. Boutin, *Distinguishing geometric graphs*, J. Graph Theory **53** (2006), 135–150.
- [4] M. Albertson and K. Collins, *Symmetry breaking in graphs*, Electron. J. Combin. **3** (1996), Research Paper 18, 17 pp. (electronic).
- [5] M. Albertson and J. Hutchinson, *Extending precolorings of subgraphs of locally planar graphs*, European J. Combin. **25** (2004), 863–871.
- [6] M. Albertson, A. Kostochka, and D. West, *Precoloring extensions of Brooks' theorem*, SIAM J. Discrete Math. **18** (2004), 542–553.
- [7] M. Albertson and D. West, *Extending precolorings to circular colorings*, J. Combin. Theory Ser. B **96** (2006), 472–481.
- [8] V. Arvind, C. Cheng, and Nikhil R. Devanur, *On computing the distinguishing numbers of planar graphs and beyond: a counting approach*, SIAM J. Discrete Math. **22** (2008), 1297–1324.
- [9] M. Axenovich, J. Hutchinson, and M. Lastrina, *List precoloring extension in planar graphs*, Discrete Math. **311** (2011), 1046–1056.
- [10] M. Bíró, M. Hujter, and Zs. Tuza, *Precoloring extension. I. Interval graphs*, Discrete Math. **100** (1992), 267–279.
- [11] B. Bogstad and L. Cowen, *The distinguishing number of the hypercube*, Discrete Math. **283** (2004), 29–35.
- [12] B. Bollobás, *Extremal graph theory*, Dover Publications, 2004.
- [13] A. Bonato and D. Delić, *Distinguishing number and adjacency properties*, J. Combinatorics **1** (2010), 141–148.
- [14] A. Bonato and D. Delić, *Distinguishing homomorphisms of infinite graphs*, Contrib. Discrete Math. **7** (2012), 44–53.
- [15] R. Brewster and J. Noel, *Extending precolourings of circular cliques*, Discrete Math. **312** (2012), 35–41.

- [16] M. Chan, *The distinguishing number of the direct product and wreath product action*, J. Algebraic Combin. **24** (2006), 331–345.
- [17] M. Chan, *The maximum distinguishing number of a group*, J. Combinatorics **13** (2006), R70.
- [18] C. Cheng, *On computing the distinguishing numbers of trees and forests*, Electron. J. Combin. **13** (2006), Research Paper 11, 12 pp. (electronic).
- [19] C. Cheng, *On computing the distinguishing and distinguishing chromatic numbers of interval graphs and other results*, Discrete Math. **309** (2009), 5169–5182.
- [20] K. Collins and A. Trenk, *The distinguishing chromatic number*, Electron. J. Combin. **13** (2006), Research Paper 16, 19pp. (electronic).
- [21] M. Ferrara, B. Fleisch, and E. Gethner, *List-distinguishing colorings of graphs*, Electron. J. Comb. **18** (2011), Paper 161, 17pp (electronic).
- [22] M. Fischer and G. Isaak, *Distinguishing colorings of Cartesian products of complete graphs*, Discrete Math. **308** (2008), 2240–2246.
- [23] M. Hujter and Zs. Tuza, *Precoloring extension. II. Graphs classes related to bipartite graphs*, Acta Math. Univ. Comenian. (N.S.) **62** (1993), 1–11.
- [24] M. Hujter and Zs. Tuza, *Precoloring extension. III. Classes of perfect graphs*, Combin. Probab. Comput. **5** (1996), 35–56.
- [25] W. Imrich, J. Jerebic, and S. Klavžar, *The distinguishing number of Cartesian products of complete graphs*, European J. Combin. **29** (2008), 922–929.
- [26] W. Imrich and S. Klavžar, *Distinguishing Cartesian powers of graphs*, J. Graph Theory **53** (2006), 250–260.
- [27] W. Imrich, S. Klavžar, and V. Trofimov, *Distinguishing infinite graphs*, Electron. J. Combin. **14** (2007), Research Paper 36, 12 pp. (electronic).
- [28] S. Klavžar, T-L. Wong, and X. Zhu, *Distinguishing labellings of group action on vector spaces and graphs*, J. Algebra **303** (2006), 626–641.
- [29] D. Král, M. Krnc, M. Kupec, B. Lužar, and J. Volec, *Extending fractional precolorings*, SIAM J. Discrete Math. **26** (2012), 647–660.
- [30] C. Laflamme, L. Nguyen Van Thé, and N. Sauer, *Distinguishing number of countable homogeneous relational structures*, Electron. J. Combin. **17** (2010), Research Paper 20, 12 pp. (electronic).
- [31] F. Lehner, *Random colourings and automorphism breaking in locally finite graphs*, Combin. Probab. Comput. **22** (2013), 885–909.

- [32] A. Pruchnewski and M. Voigt, *Precoloring extension for K_4 -minor-free graphs*, J. Graph Theory **60** (2009), 284–294.
- [33] F. Rubin, *Problem 729*, J. Recreational Math. **11** (1979), 128.
- [34] Z. Tuza, *Graph colorings with local constraints—a survey*, Discuss. Math. Graph Theory **17** (1997), 161–228.
- [35] J. Tymoczko, *Distinguishing numbers for graphs and groups*, Electron. J. Combin. **11** (2004), Research Paper 63, 13pp. (electronic).
- [36] M. Watkins and X. Zhou, *Distinguishability of locally finite trees*, Electron. J. Combin. **14** (2007), Research Paper 29, 10 pp. (electronic).