

QUASIGEODESIC PSEUDO-ANOSOV FLOWS in HYPERBOLIC 3-MANIFOLDS and CONNECTIONS with LARGE SCALE GEOMETRY *

Sérgio R. Fenley [†]

July 10, 2018

Abstract – In this article we obtain a simple topological and dynamical systems condition which is necessary and sufficient for an arbitrary pseudo-Anosov flow in a closed, hyperbolic three manifold to be quasigeodesic. Quasigeodesic means that orbits are efficient in measuring length up to a bounded multiplicative distortion when lifted to the universal cover. We prove that such flows are quasigeodesic if and only if there is an upper bound, depending only on the flow, on the number of orbits which are freely homotopic to an arbitrary closed orbit of the flow. The main ingredient is a proof that, under the boundedness condition, the fundamental group of the manifold acts as a uniform convergence group on a flow ideal boundary of the universal cover. We also construct a flow ideal compactification of the universal cover, and prove that it is equivariantly homeomorphic to the Gromov compactification. This implies the quasigeodesic behavior of the flow. The flow ideal boundary and flow ideal compactification are constructed using only the structure of the flow.

1 Introduction

The goal of this article is to relate dynamical systems behavior with the geometry of the underlying manifold, and in particular with the large scale geometry of the universal cover. We analyse pseudo-Anosov flows in three manifolds. This is an extremely common class of flows which is known to be closely related with the topology of the underlying manifold. We study these flows in hyperbolic three manifolds and we obtain a very simple characterization of good geometric behavior of the flow in the universal cover. We also prove that in the case of good geometric behavior the flow generates a flow ideal compactification of the universal cover which is equivariantly homeomorphic to the Gromov compactification. It follows that in these cases the flow encodes the asymptotic or large scale geometric structure of the universal cover.

The field of hyperbolic flows was started by Anosov [An] who studied geodesic flows in the unit tangent bundle of manifolds with negative sectional curvature. In fact Anosov studied much more general flows, which have since then been called Anosov flows. Anosov obtained deep and far reaching results concerning the dynamical behavior of these flows and with connections and applications to ergodic theory, foliation theory and other areas [An]. In dimension three these flows were generalized by Thurston who defined pseudo-Anosov homeomorphisms of surfaces [Th4] and used their suspensions to obtain deep results about three manifolds that fiber over the circle [Th1, Th2, Th3]. These suspension flows are the most basic examples of pseudo-Anosov flows.

Pseudo-Anosov flows are the most useful flows to study the topology of three manifolds [GK1, Mo3, Mo4, Mo5, Cal1, Cal2, Cal3, Ba2, Fe6, Fe7]. The goal of this article is to establish a strong relationship between these flows and the geometry of the manifold, and more specifically with the large scale geometry of the universal cover. This is extremely important in the case of hyperbolic manifolds [Th1, Th2, Gr,

*MSC-class: Primary: 57M50, 37D20, 37D50, 37C85, Secondary: 20F67, 34D45, 57M60, 57R30

[†]Research partially supported by a grant of the Simons foundation.

Gh-Ha]. At first it might seem that nothing can be said in general about large scale geometric properties of flows lines. This is because flows and flow lines are very flexible and floppy and apparently not very geodesic. We will give a necessary and sufficient topological and dynamical systems condition for all the flow lines in the universal cover to have good geometric behavior.

Zeghib [Ze] proved that a flow in a closed hyperbolic 3-manifold cannot be geodesic, that is, not all flow lines can be geodesics in the hyperbolic metric. The next best property is that flow lines are quasigeodesics, which we now define. A *quasi-isometric embedding* is a map between metric spaces which is bi-Lipschitz in the large. Equivalently, up to an additive constant, the map is at most a bounded multiplicative distortion in the metric. A *quasigeodesic* is a quasi-isometric embedding of the real line (or a segment) into a metric space. The work of Thurston [Th1, Th2, Th3], Gromov [Gr] and many, many others have thoroughly established the fundamental importance of quasigeodesics in hyperbolic manifolds. In this article we analyse the interaction of the quasigeodesic property with flows in 3-manifolds.

Given a flow with rectifiable orbits in a manifold we say it is quasigeodesic if every flow line of the lifted flow to the universal cover is a quasigeodesic. The metric in the domain of a flow line is the path metric along the orbit. For the remainder of this article we will only consider flows in closed 3-manifolds and their lifts to covering spaces. The first example of a quasigeodesic flow in a hyperbolic manifold was that of suspensions of pseudo-Anosov homeomorphisms of closed surfaces [Th3, Bl-Ca]. In a seminal work, Cannon and Thurston [Ca-Th] showed in 1984 that the quasigeodesic property holds for these flows and used this property to prove the sensational result that lifts of fibers to the universal cover extend continuously to the sphere at infinity and produce group invariant Peano or sphere filling curves. After the Cannon-Thurston result, Zeghib [Ze] gave a very elementary proof that all suspensions on closed manifolds are quasigeodesic – because of the minimal separation between lifts of fibers. Given the Cannon-Thurston result, the natural question arises: when is a pseudo-Anosov flow in a hyperbolic 3-manifold a quasigeodesic flow? Over the last 25 years the quasigeodesic property has been proved in several special circumstances. In this article we give a complete and very simple characterization of the quasigeodesic property.

Around the same time as the Cannon Thurston result, Goodman [Go] and Fried [Fr] produced constructions of new Anosov and pseudo-Anosov flows via Dehn surgery on closed orbits of Anosov or pseudo-Anosov flows, or Dehn surgery near closed orbits. In general most Dehn surgeries yield new Anosov or pseudo-Anosov flows in the surgered manifold, and in the majority of cases all surgeries except for the longitudinal one yield such flows [Fr]. This vastly increased the class of pseudo-Anosov flows and the known classes of manifolds supporting pseudo-Anosov flows. In this article we consider Anosov flows as a subclass of pseudo-Anosov flows. Anosov flows are the pseudo-Anosov flows without singular orbits. In addition many classes of Reebless foliations [No, Ga1, Ga2, Ga3] in atoroidal manifolds admit transverse or almost transverse pseudo-Anosov flows (see below): this has been proved for \mathbf{R} -covered foliations [Fe6, Cal1], foliations with one sided branching [Cal2], and finite depth foliations [Mo5]. It is quite possible that every Reebless foliation in an atoroidal manifold admits an almost transverse pseudo-Anosov flow [Th5, Th6, Cal3]. The conclusion is that pseudo-Anosov flows are extremely common amongst 3-manifolds.

We now describe further classes of pseudo-Anosov flows in hyperbolic manifolds which were previously shown to be quasigeodesic. The next result after Cannon and Thurston was obtained by Mosher [Mo2] who constructed an infinite class of quasigeodesic pseudo-Anosov flows transverse to depth one foliations [Ga1, Ga2]. He used the round handles of Asimov, attached them to I -bundles over surfaces with boundary, and did further glueing to produce flows in closed manifolds [Mo2]. The closed surfaces in the construction were quasi-Fuchsian [Th1, Th2]. This means that lifts to the universal cover are quasi-isometrically embedded, with the path metric in the domain. The proof that such surfaces are quasi-Fuchsian used some very deep results of Thurston [Th1, Th2] and Bonahon [Bon]. Shortly after that Mosher [Mo3, Mo4] formalized the concept of a pseudo-Anosov flow in a 3-manifold. Later the author and Mosher [Fe-Mo] proved that a pseudo-Anosov flow almost transverse to a finite depth foliation in a closed hyperbolic 3-manifold is quasigeodesic. The proof depended in an essential way on the geometric

properties of the leaves of the foliation and a hierarchy of the manifold associated with the finite depth foliation [Ga1, Ga2, Ga3]. Almost transverse means that after a possible blow up of some singular orbits of the flow, the flow becomes transverse to the foliation [Mo1, Mo3].

Later Thurston [Th5] proved that a regulating pseudo-Anosov flow transverse to a foliation coming from a slithering is quasigeodesic. Slithering is essentially equivalent to the following: any pair of leaves in the universal cover are a bounded distance from each other. The bound depends on the pair of leaves, but not on the individual points in the leaves. Regulating means that in the universal cover an arbitrary orbit intersects every leaf of the lifted foliation. The proof of the quasigeodesic property in this situation is quite simple, and very similar to the straightforward proof of Zeghib that suspensions are quasigeodesic.

In all of these results the flow is transverse, or almost transverse, to a foliation which has excellent geometric properties. In particular except for the case of slitherings, all foliations above have compact leaves. Such a compact leaf is quasi-Fuchsian, with excellent geometric properties [Th1, Th2]. This helped tremendously in the proof of quasigeodesic behavior for the flow. Notice however that any compact leaf is an incompressible surface. Unfortunately most 3-manifolds do not have incompressible surfaces [Ha-Th] so this method to prove quasigeodesic behavior for the flows is somewhat restricted.

To deal with more general pseudo-Anosov flows a completely different method is required. In this article we use an alternate method which does not require the existence of a transverse foliation, or any foliation at all. In addition the method does not assume that the manifold M is hyperbolic or even atoroidal. Very roughly the method is as follows. Suppose that there is a bound on the size of sets of freely homotopic closed orbits. We use the lifted flow to \widetilde{M} to produce a flow ideal boundary to the universal cover \widetilde{M} . Then we show that the fundamental group of the manifold acts as a uniform convergence group on the flow ideal boundary. By a result of Bowditch [Bow1] this implies that the fundamental group is Gromov hyperbolic and the flow ideal boundary is $\pi_1(M)$ equivariantly homeomorphic to the Gromov ideal boundary S_∞^2 . We then show that a natural flow ideal compactification and the Gromov compactification of \widetilde{M} are $\pi_1(M)$ equivariantly homeomorphic. The flow ideal compactification is constructed using only the stable and unstable foliations of the flow. This shows that in the bounded case the flow encodes the asymptotic or large scale geometric structure of \widetilde{M} . One crucial implication is that properties that hold in the flow compactification get transferred to the Gromov compactification. We then prove three easy properties in the flow compactification which, when transferred to the Gromov compactification, imply that the flow is quasigeodesic [Fe-Mo]. This is the basic idea, but there are some substantial complications as described below.

This method was previously employed by the author in [Fe9] in the particular case that the flow does not have *perfect fits*. This is a technical condition. Roughly, a perfect fit is a pair of a stable leaf and an unstable leaf in \widetilde{M} which do not intersect, but which are essentially “asymptotic”. Pseudo-Anosov flows without perfect fits are much simpler to analyse than the general case and they behave to an enormous extent like suspension pseudo-Anosov flows with respect to the issues in question in this article. For example the leaf spaces of the stable and unstable foliations (in the universal cover) are Hausdorff. In addition all the flow lines in the universal cover essentially go in the same direction. These properties tremendously simplify the analysis as will be very clear in this article. The goal of this article is to analyse the quasigeodesic property for general pseudo-Anosov flows, particularly in atoroidal manifolds.

But we have to be careful. As it turns out not every every pseudo-Anosov flow in a hyperbolic manifold is quasigeodesic. Twenty years ago the author produced a large class of Anosov flows in closed, hyperbolic 3-manifolds which are not quasigeodesic [Fe2]. In these flows every closed orbit of the flow is freely homotopic to infinitely many other closed orbits. Lifting coherently to the universal cover they all have the same ideal points in the sphere at infinity. In addition they cannot be very close to each other because of the pseudo-Anosov property, so they cannot accumulate in \widetilde{M} . Since quasigeodesics in such manifolds are a bounded distance from a geodesic [Th1, Th2, Gr], this implies that the flow cannot be uniformly quasigeodesic. Uniform means the same bounds work for all orbits. But a pseudo-Anosov flow in an atoroidal manifold is transitive [Mo3] so quasigeodesic implies uniformly quasigeodesic. Alternatively a result of Calegari showed that if a flow of any type in a hyperbolic manifold is quasigeodesic, then it is

uniformly quasigeodesic [Cal4]. This shows that these flows are not quasigeodesic.

Since not all pseudo-Anosov flows in hyperbolic manifolds are quasigeodesic, one must be careful to determine which ones are quasigeodesic, or what properties are equivalent or imply the quasigeodesic behavior. We were able to obtain an extremely simple condition which is equivalent to quasigeodesic behavior in all situations. First we need a clarification and a definition.

The clarification needed here is the following. For 3-manifolds supporting a pseudo-Anosov flow, Perelman's fantastic results [Pe1, Pe2, Pe3] imply that if the manifold M is atoroidal then it is in fact hyperbolic and consequently the fundamental group $\pi_1(M)$ is Gromov hyperbolic. Hence all three properties are equivalent. In the method presented in this article we will not assume Perelman's results. We will only assume a certain dynamical systems property of the flow which implies that M is atoroidal and through the results of this article, this property implies that $\pi_1(M)$ is Gromov hyperbolic.

Definition 1.1. *The free homotopy class of a closed orbit is the set of orbits which are freely homotopic to it. We say that a pseudo-Anosov flow in a closed 3-manifold is bounded if:*

i) No closed orbit is non trivially freely homotopic to itself and there is an upper bound to the cardinality of free homotopy classes.

ii) The flow is not topologically conjugate to a suspension Anosov flow.

Topologically conjugate means that there is a homeomorphism sending orbits to orbits. Suspension Anosov flows have free homotopy classes which are all singletons. There are many reasons why suspension Anosov flows are special and they need to be treated separately.

A trivial free homotopy from a closed orbit β to itself is one that can be deformed rel boundary to another homotopy with image contained in β . A simple example of a non trivial free homotopy occurs in a geodesic flow Φ of a closed hyperbolic surface S . Let α_1 be a closed orbit of Φ corresponding to a closed geodesic α in S . Turn the unit tangent vectors along α continuously by a total turn of 2π . This is a non trivial free homotopy from α_1 to itself.

The main result of this article is the following:

Main theorem – Let Φ be a pseudo-Anosov flow in M^3 with Gromov hyperbolic fundamental group. Then Φ is a quasigeodesic flow if and only if Φ is bounded.

This theorem answers a question that was open for almost thirty years [Ga4, Ga5].

The Main theorem gives a surprisingly simple and compact characterization of quasigeodesic behavior. The characterization involves only topology and the dynamical properties of the flow and it is checked directly in the manifold as opposed to an analysis in the universal cover. There are many situations where one can actually check whether orbits are freely homotopic to other orbits [Mo2, Fe5, Fe8, Fe9]. The main theorem also has applications to other problems: i) The quasigeodesic property can be used to compute Thurston norms of surfaces [Mo3, Mo4, Cal4]; ii) The quasigeodesic property can be used to prove the continuous extension property for foliations as follows. Suppose that \mathcal{F} is a foliation in M^3 closed, hyperbolic and that there is a quasigeodesic pseudo-Anosov flow almost transverse to \mathcal{F} . Then \mathcal{F} has the continuous extension property [Fe8]. This means that in the universal cover the leaves of the lifted foliation $\tilde{\mathcal{F}}$ extend continuously to the sphere at infinity. We will expand on this in the final section entitled Concluding remarks.

Strategy of proof of the Main theorem

One direction in the proof is fairly simple and it was already alluded to previously. If Φ is quasigeodesic, then Φ is uniformly quasigeodesic [Mo3, Cal4]. If a closed orbit is non trivially freely homotopic to itself, this produces a π_1 -injective map of \mathbf{Z}^2 into M contradicting that M is atoroidal. The previous explanation about the examples of non quasigeodesic flows in hyperbolic manifolds, shows that if Φ is quasigeodesic then a free homotopy class cannot be infinite. In fact since Φ is uniformly quasigeodesic, the same arguments show that a free homotopy class has bounded cardinality and this proves one direction of the Main theorem.

The other direction of the Main theorem is very complex and long. It will roughly go as follows: bounded free homotopy classes imply bounded length of chains of perfect fits and this property implies (after a lot of work) that Φ is quasigeodesic. In fact we prove:

Theorem A – Let Φ be a bounded pseudo-Anosov flow in M^3 closed. Then $\pi_1(M)$ is Gromov hyperbolic and Φ is quasigeodesic.

Notice that Gromov hyperbolicity of $\pi_1(M)$ is not part of the hypothesis of Theorem A or even that M is atoroidal. So in particular this provides an alternative proof of Gromov hyperbolicity in the setting of flows.

At this point we give a further explanation of what a perfect fit is. Let Λ^s, Λ^u be the stable and unstable foliations of the flow Φ and let $\tilde{\Lambda}^s, \tilde{\Lambda}^u$ be the respective lifts to the universal cover \tilde{M} .

We say that a stable leaf L of $\tilde{\Lambda}^s$ makes a *perfect fit* with an unstable leaf U of $\tilde{\Lambda}^u$ if L and U do not intersect, but almost intersect in the following sense. If L' is a stable leaf very near L and in the component of $\tilde{M} - L$ which contains U , then L' intersects U . In the same way for U' near U in the “side of L ” will intersect L . See formal definition and fig. 1, a in the Background section.

Why perfect fits? The first remark is that free homotopies of closed orbits always generate perfect fits. First we introduce the notion of a lozenge. A *lozenge* in \tilde{M} is made up of 4 leaves, 2 of which L_1, L_2 are stable ($\tilde{\Lambda}^s$) and 2 of which U_1, U_2 are unstable ($\tilde{\Lambda}^u$). The leaves L_1, U_1 make a perfect fit as do L_2, U_2 . In addition L_1, U_2 intersect each other as do L_2, U_1 . These four leaves form an “ideal quadrilateral” in \tilde{M} with 2 finite corners – the orbits $U_1 \cap L_2, U_2 \cap L_1$ and two “ideal” corners corresponding to the perfects L_1, U_1 and L_2, U_2 . Again see formal definition and fig. 1, b in the Background section.

If two closed orbits α, β of Φ are freely homotopic, then coherent lifts $\tilde{\alpha}, \tilde{\beta}$ are connected by a finite chain of lozenges with initial corner $\tilde{\alpha}$, final corner $\tilde{\beta}$ and consecutive lozenges having a corner orbit in common [Fe4, Fe6]. Hence free homotopies generate many perfect fits. We first prove that the converse is also true:

Theorem B – Let Φ be an arbitrary pseudo-Anosov flow. Suppose that L, U make a perfect fit. A study of the asymptotic behavior of orbits in L, U produces free homotopies between closed orbits of Φ .

The proof is done using a limiting argument going forward in the stable leaf or backwards along the unstable leaf and using the shadow lemma for pseudo-Anosov flows [Han, Man]. This result says that the topological structure of $\tilde{\Lambda}^s, \tilde{\Lambda}^u$ in the universal cover implies certain topological properties of closed orbits in the manifold. This result does not assume that M is atoroidal or that Φ is bounded.

One crucial part of the strategy to prove the Main theorem is to extend Theorem B to chains of perfect fits. A *chain of perfect fits* is a collection of distinct leaves of $\tilde{\Lambda}^s, \tilde{\Lambda}^u$ so that consecutive leaves make a perfect fit. The length of the chain is the number of leaves in it. We next prove the following:

Theorem C – Suppose that a pseudo-Anosov flow Φ does not have a closed orbit which is non trivially freely homotopic to itself. Suppose in addition that Φ has a chain of perfect fits of length k . This produces a free homotopy class of size at least k .

This is obtained by a shadowing procedure where a perfect fit may produce more than one free homotopy, that is, a free homotopy class with more than two orbits. This happens because in the limiting procedure a sequence of perfect fits may converge to a finite collection of lozenges and not only to a single lozenge. This happens because of the possible non Hausdorffness in the leaf spaces of $\tilde{\Lambda}^s, \tilde{\Lambda}^u$ and it is one of the many complications that occur when there are perfect fits.

We stress that theorems B and C do not assume anything about M or the flow Φ . The proof of Theorem C depends mostly on the fact that if a free homotopy lifts to a single lozenge (as opposed to a finite chain with more than one lozenge), then the homotopy has bounded thickness. This means that the homotopy moves every point a bounded amount. The bound depends only on M and the flow Φ . We already alluded to the fact that free homotopies cannot move points an arbitrary small distance – because of the pseudo-Anosov property. Theorem C is related to the fact that “indivisible” free homotopies do not move points too much. This gives another substantial interaction between topology, dynamics on the

one hand and the metric and geometry on the other hand.

After the result of Theorem C we can rephrase Theorem A as follows:

Theorem D – Let Φ be a pseudo-Anosov flow with an upper bound on the size of chains of perfect fits. Assume that Φ is not topologically conjugate to a suspension Anosov flow. Then $\pi_1(M)$ is Gromov hyperbolic and Φ is a quasigeodesic flow.

Suspension Anosov flows do not have any perfect fits. Geodesic flows on the other hand have free homotopy classes with two elements only, but they lift to infinite chains of perfect fits (or lozenges) – the corners of the lozenges are equivalent by certain covering translations.

Theorem D is stated in the format involving information in the universal cover and the topological structure of $\tilde{\Lambda}^s, \tilde{\Lambda}^u$. To prove Theorem D we construct and analyse the flow ideal boundary \mathcal{R} of \tilde{M} . This flow ideal boundary is obtained as a quotient of the boundary of the orbit space as follows.

The boundary of the orbit space for general pseudo-Anosov flows was constructed in [Fe9]. Let \mathcal{O} be the orbit space of $\tilde{\Phi}$, that is, the quotient space $\tilde{M}/\tilde{\Phi}$. A basic result is that \mathcal{O} is always homeomorphic to the plane \mathbf{R}^2 [Fe-Mo]. Since the stable/unstable foliations $\tilde{\Lambda}^s, \tilde{\Lambda}^u$ are flow invariant they induce one dimensional, possibly singular, foliations $\mathcal{O}^s, \mathcal{O}^u$ in the orbit space \mathcal{O} . Using only these foliations one produces the ideal boundary $\partial\mathcal{O}$ of \mathcal{O} and there is a natural topology in $\mathcal{D} = \mathcal{O} \cup \partial\mathcal{O}$ turning it into a closed disk [Fe9]. Hence $\partial\mathcal{O}$ is a circle and in addition $\pi_1(M)$ naturally acts on $\mathcal{O}, \partial\mathcal{O}$ and \mathcal{D} . One fundamental fact is that if a leaf u of \mathcal{O}^u makes a perfect fit with a leaf s of \mathcal{O}^s , then the corresponding ideal points of s, u are the same point in the ideal boundary $\partial\mathcal{O}$. These constructions have no restriction on M or Φ .

The flow ideal boundary \mathcal{R} is obtained from $\partial\mathcal{O}$ by identifying p, q in $\partial\mathcal{O}$ if they are ideal points of a leaf of either the stable or unstable foliation \mathcal{O}^s or \mathcal{O}^u . We first prove the following:

Theorem E – Let Φ be a bounded pseudo-Anosov flow. Then the flow ideal boundary \mathcal{R} is homeomorphic to a two dimensional sphere.

The bounded hypothesis is crucial. In the non quasigeodesic examples in hyperbolic 3-manifolds mentioned before, every closed orbit is freely homotopic to infinitely many other closed orbits. This lifts to infinite chains of perfect fits. Since ideal points of rays associated to perfect fits are the same point in $\partial\mathcal{O}$, this produces an infinite to one identification of points from $\partial\mathcal{O}$ to \mathcal{R} . In these examples \mathcal{R} is the union of a circle and two points x, y . The two points x, y are not separated from any point in the circle. Hence \mathcal{R} is not metrisable and cannot be homeomorphic to the Gromov ideal boundary of a Gromov hyperbolic group [Gr].

The most important ingredient in the proof of Theorem D and hence the Main theorem is the following.

Theorem F – Suppose that Φ is a bounded pseudo-Anosov flow. Then $\pi_1(M)$ acts as a uniform convergence group on the flow ideal boundary \mathcal{R} .

To prove Theorem F we first show that $\pi_1(M)$ acts as a convergence group on \mathcal{R} . This means that if (g_n) is a sequence of distinct elements of $\pi_1(M)$, there is a subsequence (g_{n_k}) with a source z and sink w in \mathcal{R} . This means that if C is a compact set in $\mathcal{R} - \{z\}$ then the sequence $(g_{n_k}(C))$ converges uniformly to $\{w\}$ in the Gromov-Hausdorff topology of closed sets of \mathcal{R} . The biggest difficulty in proving this is that the existence of perfect fits means that many points in $\partial\mathcal{O}$ are identified when projected to \mathcal{R} . For example there may be leaves in $\tilde{\Lambda}^s$ (or \mathcal{O}^s) which are non separated from each other. In particular this produces at least two perfect fits, see Theorem 2.7. The non Hausdorff behavior implies that in the limiting arguments, collections of leaves of \mathcal{O}^s may converge to more than one limit leaf and new identifications of points of $\partial\mathcal{O}$ emerge. This ends up being tricky to deal with and the proof is complex. The bounded hypothesis is used many times in the proof.

The second part of the proof of Theorem F is to prove that the action is uniform. With the previous properties, it suffices to show that an arbitrary point z in \mathcal{R} is a conical limit point for the action of $\pi_1(M)$ on \mathcal{R} [Bow1, Bow2]. This means that there is a sequence (g_n) in $\pi_1(M)$ with source z , sink w , and

with w distinct from z . It is very easy to produce sequences (g_n) where z is the source by dynamically “zooming in” to z . The big difficulty is to prove that the sink of such a sequence is distinct from z . In the metric setup, where we know that $\pi_1(M)$ is Gromov hyperbolic and c is a point in the sphere at infinity S_∞^2 , one uses a geodesic ray r with ideal point c in S_∞^2 and pulls back points along this ray to a compact set in \widetilde{M} . The collection of pull backs generate a sequence (g_n) in $\pi_1(M)$ which shows that c is a conical limit point. The problem in the flow setting is that we do not know what geodesics are, or more specifically, how geodesics interact with the flow in \widetilde{M} . In fact the main goal of this article is to show that flow lines are almost like geodesics. Continuing the analogy with the metric situation, if we were to approach the point z using a “horocycle like” path, then the sink w for the sequence (g_n) associated with the pullbacks would also be equal to z . This is what we want to disallow. The difficulty for us is that since there are perfect fits, many more points in $\partial\mathcal{O}$ are identified in \mathcal{R} . Hence we have to be extremely careful to ensure that the sink is distinct from the source. Theorem F is the hardest result proved in this article and it has the longest proof.

After Theorem F is proved, we use a very important result of Bowditch [Bow1] that shows the following: if $\pi_1(M)$ acts as a uniform convergence group on \mathcal{R} (homeomorphic to a sphere) then $\pi_1(M)$ is Gromov hyperbolic and \mathcal{R} is $\pi_1(M)$ equivariantly homeomorphic to the Gromov ideal boundary S_∞^2 . Another point of view is that Theorem F and this consequence should be interpreted as a weak hyperbolization theorem in the setting of flows: dynamical systems produce geometric information.

In addition the flow creates a flow ideal compactification of \widetilde{M} with excellent properties.

Theorem G – Let Φ be a bounded pseudo-Anosov flow. There is a natural and well defined topology in $\widetilde{M} \cup \mathcal{R}$ depending only on the foliations $\widetilde{\Lambda}^s, \widetilde{\Lambda}^u$ and satisfying the following properties. The space $\widetilde{M} \cup \mathcal{R}$ is compact and hence is a compactification of \widetilde{M} . The fundamental group acts on $\widetilde{M} \cup \mathcal{R}$ extending the actions on \widetilde{M} and \mathcal{R} . This compactification is $\pi_1(M)$ equivariantly homeomorphic to the Gromov compactification $\widetilde{M} \cup S_\infty^2$.

Theorem G implies that the terminology “flow ideal boundary” for \mathcal{R} indeed makes sense as $\widetilde{M} \cup \mathcal{R}$ is compact and is equivalent to the Gromov compactification. This theorem means that under the bounded hypothesis the flow encodes the large scale geometric structure of \widetilde{M} .

Once Theorem G is proved then properties in the flow compactification get transferred to the Gromov compactification. We show that in $\widetilde{M} \cup \mathcal{R}$ flow lines of Φ have well defined forward and backward limit points in $\widetilde{\Phi}$. For each flow line we show that the forward and backward ideal points are distinct and the forward ideal point map is continuous in \widetilde{M} (same for the backward ideal point map). This gets transferred to the Gromov compactification. Finally these three properties in $\widetilde{M} \cup S_\infty^2$ imply that Φ is a quasigeodesic flow by a previous result of the author and Mosher [Fe-Mo]. This finishes the proof of the Main theorem. One way to interpret these results is that Theorem A is the first important corollary of Theorem F.

The flow ideal boundary and compactification have many excellent properties. In order to keep this article from being overly long we omit the proof or even the statement of many of these properties. For example using only the flow one can prove that $\pi_1(M)$ acts as a convergence group on $\widetilde{M} \cup \mathcal{R}$ (for Φ bounded). We do not prove this, but instead it can be easily derived from Theorem G and the fact that this is true in the Gromov compactification.

The results of this article imply the existence of many natural group invariant Peano curves or Cannon-Thurston maps:

Theorem H – Let Φ be a bounded pseudo-Anosov flow. By theorem A the group $\pi_1(M)$ is Gromov hyperbolic. Then any section $\tau : \mathcal{O} \rightarrow \widetilde{M}$ extends to a continuous map $\bar{\tau} : \mathcal{O} \cup \partial\mathcal{O} \rightarrow \widetilde{M} \cup S_\infty^2$. The ideal map $\bar{\tau}|_{\partial\mathcal{O}} : \partial\mathcal{O} \rightarrow S_\infty^2$ is a $\pi_1(M)$ equivariant Peano curve, in this situation also called a Cannon-Thurston map. The map $\bar{\tau}|_{\partial\mathcal{O}}$ is unique for the flow Φ .

Cannon-Thurston maps are maps between ideal boundaries. These were introduced by Cannon and

Thurston [Ca-Th] in the setting of surface groups ($\pi_1(S)$) in hyperbolic 3-manifolds (M). They produced a group equivariant Peano curve from $\partial\pi_1(S)$ to $\partial\pi_1(M)$ (which is equal to S_∞^2). These maps were greatly generalized to other settings in Kleinian groups by Mj [Mj]. Theorem H produces a Cannon-Thurston map in the setting of pseudo-Anosov flows. Notice that Frankel [Fra2] produced Cannon-Thurston maps for general (not necessarily pseudo-Anosov) quasigeodesic flows in hyperbolic 3-manifolds.

An immediate corollary of theorem H is an alternate proof of a result of Frankel [Fra2] in the case of pseudo-Anosov flows:

Corollary I – Let Φ be a quasigeodesic pseudo-Anosov flow in M^3 with $\pi_1(M)$ Gromov hyperbolic. Then any section $\tau : \mathcal{O} \rightarrow \widetilde{M}$ induces a $\pi_1(M)$ equivariant Peano curve $\bar{\tau}|_{\partial\mathcal{O}} : \partial\mathcal{O} \rightarrow S_\infty^2$.

Calegari [Cal4] started the study of general quasigeodesic flows in closed hyperbolic 3-manifolds. He obtained important results, for example they are always uniformly hyperbolic, the orbit space in the universal cover is \mathbf{R}^2 and they induce $\pi_1(M)$ actions on a circle. Frankel showed that the orbit space can be naturally compactified to a disk and that quasigeodesic flows always produce group invariant Peano curves [Fra1, Fra2]. He also proved that in almost every case, a quasigeodesic flow has closed orbits [Fra1].

We thank Lee Mosher who informed us of Bowditch’s theorem on uniform convergence groups actions. This was the origin of this article. The work of this article was greatly inspired by William Thurston who, many years ago, taught us hyperbolic geometry, foliations and introduced us to pseudo-Anosov flows. We also thank Steven Frankel for comments on a preliminary version of this article.

2 Background: Pseudo-Anosov flows

Pseudo-Anosov flows are flows which are locally like suspension flows of pseudo-Anosov surface homeomorphisms. These flows behave much like Anosov flows, but they may have finitely many singular orbits which are periodic and have a prescribed behavior.

The manifold M has a Riemannian metric.

Definition 2.1. (*pseudo-Anosov flow*) Let Φ be a flow on a closed 3-manifold M . We say that Φ is a pseudo-Anosov flow if the following conditions are satisfied:

- For each $x \in M$, the flow line $t \rightarrow \Phi(x, t)$ is C^1 , it is not a single point, and the tangent vector bundle $D_t\Phi$ is C^0 .

- There are two (possibly) singular transverse foliations Λ^s, Λ^u which are two dimensional, with leaves saturated by the flow and so that Λ^s, Λ^u intersect exactly along the flow lines of Φ .

- There is a finite number (possibly zero) of periodic orbits $\{\gamma_i\}$, called singular orbits. A stable/unstable leaf containing a singularity is homeomorphic to $P \times I/f$ where P is a p -prong in the plane and f is a homeomorphism from $P \times \{1\}$ to $P \times \{0\}$. In addition p is at least 3.

- In a stable leaf all orbits are forward asymptotic, in an unstable leaf all orbits are backwards asymptotic.

Basic references for pseudo-Anosov flows are [Mo3, Mo4], and [An] for Anosov flows. A fundamental remark is that the ambient manifold supporting a pseudo-Anosov flow is necessarily irreducible – this is because the universal cover is homeomorphic to \mathbf{R}^3 [Fe-Mo]. We stress that one prongs are not allowed.

Notation/definition: We denote by $\pi : \widetilde{M} \rightarrow M$ the universal covering of M , and by $\pi_1(M)$ the fundamental group of M , considered as the group of deck transformations on \widetilde{M} . The singular foliations lifted to \widetilde{M} are denoted by $\widetilde{\Lambda}^s, \widetilde{\Lambda}^u$. If $x \in M$ let $\Lambda^s(x)$ denote the leaf of Λ^s containing x . Similarly one defines $\Lambda^u(x)$ and in the universal cover $\widetilde{\Lambda}^s(x), \widetilde{\Lambda}^u(x)$. If α is an orbit of Φ , similarly define $\Lambda^s(\alpha), \Lambda^u(\alpha)$, etc... Let also $\widetilde{\Phi}$ be the lifted flow to \widetilde{M} .

We review the results about the topology of $\widetilde{\Lambda}^s, \widetilde{\Lambda}^u$ that we will need. We refer to [Fe4, Fe5] for detailed definitions, explanations and proofs. Proposition 4.2 of [Fe-Mo] shows that the orbit space of $\widetilde{\Phi}$

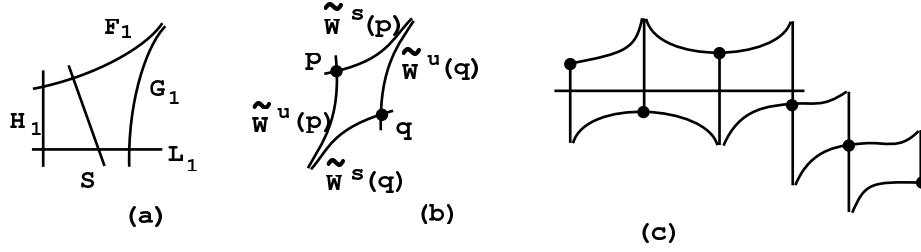

Figure 1: *a. Perfect fits in \widetilde{M} , b. A lozenge, c. A chain of lozenges.*

in \widetilde{M} is homeomorphic to the plane \mathbf{R}^2 . The orbit space is denoted by \mathcal{O} which is the quotient space $\widetilde{M}/\widetilde{\Phi}$. There is an induced action of $\pi_1(M)$ on \mathcal{O} . Let

$$\Theta : \widetilde{M} \rightarrow \mathcal{O} \cong \mathbf{R}^2$$

be the projection map. It is naturally $\pi_1(M)$ equivariant. If L is a leaf of $\widetilde{\Lambda}^s$ or $\widetilde{\Lambda}^u$, then $\Theta(L) \subset \mathcal{O}$ is a tree which is either homeomorphic to \mathbf{R} if L is regular, or is a union of p rays all with the same starting point if L has a singular p -prong orbit. The foliations $\widetilde{\Lambda}^s, \widetilde{\Lambda}^u$ induce $\pi_1(M)$ invariant singular 1-dimensional foliations $\mathcal{O}^s, \mathcal{O}^u$ in \mathcal{O} . Its leaves are the $\Theta(L)$'s as above. Similarly for $\mathcal{O}^s, \mathcal{O}^u$. If B is any subset of \mathcal{O} , we denote by $B \times \mathbf{R}$ the set $\Theta^{-1}(B)$. The same notation $B \times \mathbf{R}$ will be used for any subset B of \widetilde{M} : it will just be the union of all flow lines through points of B . If x is a point of \mathcal{O} , then $\mathcal{O}^s(x)$ (resp. $\mathcal{O}^u(x)$) is the leaf of \mathcal{O}^s (resp. \mathcal{O}^u) containing x . We stress that for pseudo-Anosov flows there are at least 3 prongs in any singular orbit ($p \geq 3$). For example the fact that the orbit space in \widetilde{M} is a 2-manifold would not be true if one allowed 1-prongs.

Definition 2.2. *Let L be a leaf of $\widetilde{\Lambda}^s$ or $\widetilde{\Lambda}^u$. A slice leaf of L is $l \times \mathbf{R}$ where l is a properly embedded copy of the real line in $\Theta(L)$. For instance if L is regular then L is its only slice leaf. If a slice leaf is the boundary of a component of $\widetilde{M} - L$ then it is called a line leaf of L . If a is a ray in $\Theta(L)$ then $A = a \times \mathbf{R}$ is called a half leaf of L . If ζ is an open segment in $\Theta(L)$ it defines a flow band L_1 of L by $L_1 = \zeta \times \mathbf{R}$.*

Important convention – In general a slice leaf is just a slice leaf of some L in $\widetilde{\Lambda}^s$ or $\widetilde{\Lambda}^u$ and so on. We also use the terms slice leaves, line leaves, perfect fits, lozenges and rectangles for the projections of these objects in \widetilde{M} to the orbit space \mathcal{O} .

If $F \in \widetilde{\Lambda}^s$ and $G \in \widetilde{\Lambda}^u$ then F and G intersect in at most one orbit. Also suppose that a leaf $F \in \widetilde{\Lambda}^s$ intersects two leaves $G, H \in \widetilde{\Lambda}^u$ and so does $L \in \widetilde{\Lambda}^s$. Then F, L, G, H form a *rectangle* in \widetilde{M} and there is no singularity of $\widetilde{\Phi}$ in the interior of the rectangle see [Fe5] pages 637-638. There will be two generalizations of rectangles: 1) perfect fits = in the orbit space this is a properly embedded rectangle with one corner removed and 2) lozenges = rectangle with two opposite corners removed.

We abuse convention and call a leaf L of $\widetilde{\Lambda}^s$ or $\widetilde{\Lambda}^u$ *periodic* if there is a non trivial covering translation g of \widetilde{M} with $g(L) = L$. Equivalently $\pi(L)$ contains a periodic orbit of Φ . In the same way an orbit γ of Φ is *periodic* if $\pi(\gamma)$ is a periodic orbit of Φ . Observe that in general the stabilizer of an element α of \mathcal{O} is either trivial, or an infinite cyclic subgroup of $\pi_1(M)$.

Definition 2.3. ([Fe2, Fe4, Fe5]) *Perfect fits - Two leaves $F \in \widetilde{\Lambda}^s$ and $G \in \widetilde{\Lambda}^u$, form a perfect fit if $F \cap G = \emptyset$ and there are half leaves F_1 of F and G_1 of G and also flow bands $L_1 \subset L \in \widetilde{\Lambda}^s$ and $H_1 \subset H \in \widetilde{\Lambda}^u$, so that the set*

$$\overline{F_1} \cup \overline{H_1} \cup \overline{L_1} \cup \overline{G_1}$$

separates M and forms an a rectangle R with a corner removed: The joint structure of $\widetilde{\Lambda}^s, \widetilde{\Lambda}^u$ in R is that of a rectangle as above without one corner orbit. The removed corner corresponds to the perfect fit of F and G which do not intersect.

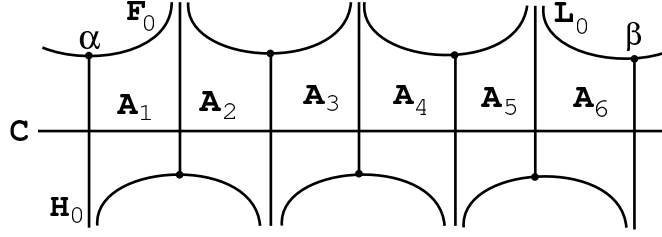

Figure 2: The correct picture between non separated leaves of $\tilde{\Lambda}^s$.

We refer to fig. 1, a for perfect fits. There is a product structure in the interior of R : there are two stable boundary sides and two unstable boundary sides in R . An unstable leaf intersects one stable boundary side (not in the corner) if and only if it intersects the other stable boundary side (not in the corner). We also say that the leaves F, G asymptotic.

Definition 2.4. ([Fe4, Fe5]) *Lozenges* - A lozenge is a region of \tilde{M} whose closure is homeomorphic to a rectangle with two corners removed. More specifically two points p, q define the corners of a lozenge if there are half leaves A, B of $\tilde{\Lambda}^s(p), \tilde{\Lambda}^u(p)$ defined by p and C, D half leaves of $\tilde{\Lambda}^s(q), \tilde{\Lambda}^u(q)$ so that A and D form a perfect fit and so do B and C . The sides of R are A, B, C, D . The sides are not contained in the lozenge, but are in the boundary of the lozenge. There may be singularities in the boundary of the lozenge. See fig. 1, b.

This is definition 4.4 of [Fe5]. Two lozenges are adjacent if they share a corner and there is a stable or unstable leaf intersecting both of the lozenges, see fig. 1, c. Therefore they share a side. A chain of lozenges is a collection $\{C_i\}, i \in I$, of lozenges where I is an interval (finite or not) in \mathbf{Z} , so that if $i, i + 1 \in I$, then C_i and C_{i+1} share a corner, see fig. 1, c. Consecutive lozenges may be adjacent or not. The chain is finite if I is finite.

Definition 2.5. Suppose A is a flow band in a leaf of $\tilde{\Lambda}^s$. Suppose that for each orbit γ of $\tilde{\Phi}$ in A there is a half leaf B_γ of $\tilde{\Lambda}^u(\gamma)$ defined by γ so that: for any two orbits γ, β in A then a stable leaf intersects B_β if and only if it intersects B_γ . This defines a stable product region which is the union of the B_γ . Similarly define unstable product regions.

The main property of product regions is the following, see [Fe5] page 641: for any $F \in \tilde{\Lambda}^s, G \in \tilde{\Lambda}^u$ so that (i) $F \cap A \neq \emptyset$ and (ii) $G \cap A \neq \emptyset$, then $F \cap G \neq \emptyset$. There are no singular orbits of $\tilde{\Phi}$ in A .

We say that two orbits γ, α of $\tilde{\Phi}$ (or the leaves $\tilde{\Lambda}^s(\gamma), \tilde{\Lambda}^s(\alpha)$) are connected by a chain of lozenges $\{C_i\}, 1 \leq i \leq n$, if γ is a corner of C_1 and α is a corner of C_n . If a lozenge C has corners β, γ and if g in $\pi_1(M) - id$ satisfies $g(\beta) = \beta, g(\gamma) = \gamma$ (and so $g(C) = C$), then $\pi(\beta), \pi(\gamma)$ are closed orbits of Φ which are freely homotopic to the inverse of each other.

Theorem 2.6. ([Fe5], theorem 4.8) Let Φ be a pseudo-Anosov flow in M closed and let $F_0 \neq F_1 \in \tilde{\Lambda}^s$. Suppose that there is a non trivial covering translation g with $g(F_i) = F_i, i = 0, 1$. Let $\alpha_i, i = 0, 1$ be the periodic orbits of $\tilde{\Phi}$ in F_i so that $g(\alpha_i) = \alpha_i$. Then α_0 and α_1 are connected by a finite chain of lozenges $\{C_i\}, 1 \leq i \leq n$ and g leaves invariant each lozenge C_i as well as their corners.

This means that each free homotopy of closed orbits generates a chain of lozenges preserved by a non trivial element g of $\pi_1(M)$.

The leaf space of $\tilde{\Lambda}^s$ (or $\tilde{\Lambda}^u$) is usually not a Hausdorff space. Two points of this space are non separated if they do not have disjoint neighborhoods in the respective leaf space. The main result concerning non Hausdorff behavior in the leaf spaces of $\tilde{\Lambda}^s, \tilde{\Lambda}^u$ is the following:

Theorem 2.7. ([Fe5], theorem 4.9) Let Φ be a pseudo-Anosov flow in M^3 . Suppose that $F \neq L$ are not separated in the leaf space of $\tilde{\Lambda}^s$. Then F and L are periodic. Let F_0, L_0 be the line leaves of F, L which

are not separated from each other. Let V_0 be the component of $\widetilde{M} - F$ bounded by F_0 and containing L . Let α be the periodic orbit in F_0 and H_0 be the component of $(\widetilde{\Lambda}^u(\alpha) - \alpha)$ contained in V_0 . Let g be a non trivial covering translation with $g(F_0) = F_0$, $g(H_0) = H_0$ and g leaves invariant the components of $(F_0 - \alpha)$. Then $g(L_0) = L_0$. This produces closed orbits of Φ which are freely homotopic in M . Theorem 2.6 then implies that F_0 and L_0 are connected by a finite chain of lozenges $\{A_i\}, 1 \leq i \leq n$, where consecutive lozenges are adjacent. They all intersect a common stable leaf C . There is an even number of lozenges in the chain, see fig. 2. In addition let $\mathcal{B}_{F,L}$ be the set of leaves of $\widetilde{\Lambda}^s$ non separated from F and L . Put an order in $\mathcal{B}_{F,L}$ as follows: The set of orbits of C contained in the union of the lozenges and their sides is an interval. Put an order in this interval. If $R_1, R_2 \in \mathcal{B}_{F,L}$ let α_1, α_2 be the respective periodic orbits in R_1, R_2 . Then $\widetilde{\Lambda}^u(\alpha_i) \cap C \neq \emptyset$ and let $a_i = \widetilde{\Lambda}^u(\alpha_i) \cap C$. We define $R_1 < R_2$ in $\mathcal{B}_{F,L}$ if a_1 precedes a_2 in the order of the set of orbits of C . Then $\mathcal{B}_{F,L}$ is either order isomorphic to $\{1, \dots, n\}$ for some $n \in \mathbf{N}$; or $\mathcal{B}_{F,L}$ is order isomorphic to the integers \mathbf{Z} . In addition if there are $Z, S \in \widetilde{\Lambda}^s$ so that $\mathcal{B}_{Z,S}$ is infinite, then there is an incompressible torus in M transverse to Φ . In particular M cannot be atoroidal. Also if there are F, L non separated from each other as above, then there are closed orbits α, β of Φ which are freely homotopic to the inverse of each other. Finally up to covering translations, there are only finitely many non Hausdorff points in the leaf space of $\widetilde{\Lambda}^s$.

Notice that $\mathcal{B}_{F,L}$ is a discrete set in this order. For detailed explanations and proofs, see [Fe4, Fe5].

Theorem 2.8. ([Fe5], theorem 4.10) *Let Φ be a pseudo-Anosov flow. Suppose that there is a stable or unstable product region. Then Φ is topologically conjugate to a suspension Anosov flow. In particular Φ is nonsingular.*

3 Ideal boundary of orbit spaces of pseudo-Anosov flows

Let Φ be an arbitrary pseudo-Anosov flow in a 3-manifold M . The orbit space \mathcal{O} of $\widetilde{\Phi}$ (the lifted flow to \widetilde{M}) is homeomorphic to \mathbf{R}^2 [Fe-Mo]. In [Fe9] we constructed a natural compactification of \mathcal{O} with an ideal circle $\partial\mathcal{O}$ called the ideal boundary of the orbit space of a pseudo-Anosov flow. The compactification $\mathcal{D} = \mathcal{O} \cup \partial\mathcal{O}$ is homeomorphic to a closed disk. The induced action of $\pi_1(M)$ on \mathcal{O} extends to an action on $\mathcal{O} \cup \partial\mathcal{O}$. We describe the main objects and results here. Detailed proofs and explanations are found in section 3 of [Fe9].

The construction of $\partial\mathcal{O}$ uses only the foliations $\mathcal{O}^s, \mathcal{O}^u$. To illustrate a simple example, consider suspension pseudo-Anosov homeomorphisms of closed surfaces. Let S be such a surface, suppose it is hyperbolic. Then a lift \widetilde{S} to \widetilde{M} is a cross section to the flow $\widetilde{\Phi}$, hence \widetilde{S} is naturally identified with the orbit space \mathcal{O} . The stable and unstable foliations of $\widetilde{\Phi}$ induce singular foliations in $\widetilde{S} \cong \mathcal{O}$. In this case the ideal boundary of $\partial\mathcal{O}$ will be identified to the circle at infinity of \widetilde{S} . A point in this circle which is not the ideal point of a stable leaf has a neighborhood system defined by stable leaves: for example a nested sequence of stable leaves which “shrinks” or converges to the ideal point. Clearly infinitely many such sequences converge to the same ideal point so one considers equivalence classes of such sequences.

For an arbitrary pseudo-Anosov flow Φ this leads to following naive approach: consider sequences (l_i) in say \mathcal{O}^s so that the leaves are nested and the sequence escapes compact sets in \mathcal{O} . In general this is not enough because of perfect fits. Consider a ray of a stable leaf l . The ray should define a point x in $\partial\mathcal{O}$ and the obvious way to try to define x is to consider a nested sequence (u_i) of unstable leaves intersecting l and so that $(u_i \cap l)$ is in the given ray of l and escapes in l . This does not work if for example that ray of l makes a perfect fit with an unstable leaf u . If this happens then the sequence (u_i) does not escape compact sets in \mathcal{O} : the leaf u is a barrier. Because of this we consider polygonal paths in leaves of \mathcal{O}^s or \mathcal{O}^u .

Definition 3.1. (polygonal path) *A polygonal path in \mathcal{O} is a properly embedded, bi-infinite path ζ in \mathcal{O} satisfying: either ζ is a leaf of \mathcal{O}^s or \mathcal{O}^u or ζ is the union of a finite collection l_1, \dots, l_n of segments and rays in leaves of \mathcal{O}^s or \mathcal{O}^u so that l_1 and l_n are rays in \mathcal{O}^s or \mathcal{O}^u and the other l_i are finite segments.*

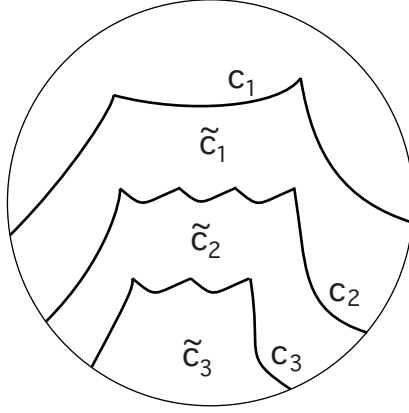

Figure 3: The paths c_1, c_2, c_3 are examples of convex polygonal paths. The set $\{c_1, c_2, c_3\}$ is nested. Here c_1 has length 3, c_2 has length 5 and c_3 has length 4. c_1 and c_3 have both rays in the same foliation (either \mathcal{O}^s or \mathcal{O}^u), and c_2 has one ray in \mathcal{O}^s and one ray in \mathcal{O}^u .

We require that l_i intersects l_j if and only if $|i - j| \leq 1$. In addition the l_i are alternatively in \mathcal{O}^s and \mathcal{O}^u . The number n is the length of the polygonal path. The points $l_i \cap l_{i+1}$ are the vertices of the path. The edges of ζ are the $\{l_i\}$.

Given z in \mathcal{O} , a sector at z is a component of $\mathcal{O} - (\mathcal{O}^s(z) \cup \mathcal{O}^u(z))$. If z is nonsingular there are exactly 4 sectors, if z is a k -prong point there are $2k$ sectors. This is also defined in \widetilde{M} using $\widetilde{\Lambda}^s, \widetilde{\Lambda}^u$. Finally this is defined locally in M using Λ^s, Λ^u .

Definition 3.2. (convex polygonal paths) A polygonal path δ in \mathcal{O} is convex if there is a complementary region V of δ in \mathcal{O} so that at any given vertex z of δ the local region of V near z is not a sector at z . Let $\widetilde{\delta} = \mathcal{O} - (\delta \cup V)$. This region $\widetilde{\delta}$ is the convex region of \mathcal{O} associated to the convex polygonal path δ .

We refer to fig. 3. The definition implies that if the region $\widetilde{\delta}$ contains 2 endpoints of a segment in a leaf of \mathcal{O}^s or \mathcal{O}^u , then it contains the entire segment. This is why δ is called convex. In some restricted situations both complementary components of δ are convex, for example if δ is contained in a single leaf of \mathcal{O}^s or \mathcal{O}^u .

Definition 3.3. (equivalent rays) Two rays l, r in leaves of $\mathcal{O}^s, \mathcal{O}^u$ are equivalent if there is a finite collection of distinct rays $l_i, 1 \leq i \leq n$, alternatively in $\mathcal{O}^s, \mathcal{O}^u$ so that $l = l_0, r = l_n$ and l_i forms a perfect fit with l_{i+1} for $1 \leq i < n$. The two rays can either be in the same foliation (\mathcal{O}^s or \mathcal{O}^u) or in distinct foliations.

This is strictly about rays in $\mathcal{O}^s, \mathcal{O}^u$ and not leaves of $\mathcal{O}^s, \mathcal{O}^u$. More specifically, consecutive perfect fits involve the same ray of the in between or middle leaf. This implies for instance that if $n \geq 3$ then for all $1 \leq i \leq n - 2$ the leaves containing l_i and l_{i+2} are non separated from each other in the respective leaf space.

Definition 3.4. (admissible sequences of paths) An admissible sequence of polygonal paths in \mathcal{O} is a sequence of convex polygonal paths $(v_i)_{i \in \mathbb{N}}$ so that the associated convex regions \widetilde{v}_i form a nested sequence of subsets of \mathcal{O} , which escapes compact sets in \mathcal{O} and for any i , the two rays of v_i are not equivalent.

The fact that the \widetilde{v}_i are nested and escape compact sets in \mathcal{O} implies that the \widetilde{v}_i are uniquely defined given the v_i . An ideal point of \mathcal{O} will be determined by an admissible sequence of paths. Different admissible sequences may define the same ideal point, so we explain when two such sequences are equivalent.

Definition 3.5. Given two admissible sequences of polygonal paths $C = (c_i), D = (d_i)$, we say that C is smaller or equal than D , denoted by $C \leq D$, if: for any i there is $k_i > i$ so that $\widetilde{c}_{k_i} \subset \widetilde{d}_i$. Two admissible sequences of polygonal paths $C = (c_i), D = (d_i)$ are related or equivalent to each other if there is a third admissible sequence $E = (e_i)$ so that $C \leq E$ and $D \leq E$.

Why not require C equivalent to D if $C \leq D$ and $D \leq C$? The conditions $C \leq D$ and $D \leq C$ together mean that C and D are eventually nested, which would seem to be the natural requirement of the relation. The reason for the unexpected definition of the relation is the following. Suppose l is a leaf of \mathcal{O}^s and (u_i) a nested sequence in \mathcal{O}^u all intersecting l and escaping in \mathcal{O} . Then (u_i) will define the ideal point x of a ray of l . Each \tilde{u}_i contains a subray l_i of l and l cuts u_i into two subrays u_i^1 and u_i^2 . Let $s_i^j = l_i \cup u_i^j$ for $j = 1, 2$. Then each s_i^j is a convex polygonal path and both (s_i^1) and (s_i^2) are admissible sequences that should define this same ideal point x . Here the 3 admissible sequences satisfy $(s_i^1) \leq (u_i)$ and $(s_i^2) \leq (u_i)$, but $\tilde{s}_k^1 \cap \tilde{s}_i^2 = \emptyset$ for any k, i in \mathbf{N} . Roughly the admissible sequences (s_i^1) and (s_i^2) approach x from “opposite” sides of x .

Lemma 3.6. *Suppose that Φ is not topologically conjugate to a suspension Anosov flow. Then the relation defined in Definition 3.5 is an equivalence relation in the set of admissible sequences of polygonal paths.*

Definition 3.7. *(Ideal boundary $\partial\mathcal{O}$) Suppose that Φ is not topologically conjugate to a suspension Anosov flow. A point in $\partial\mathcal{O}$ or an ideal point of \mathcal{O} is an equivalence class of admissible sequences of polygonal paths. Let $\mathcal{D} = \mathcal{O} \cup \partial\mathcal{O}$.*

Given R , an admissible sequence of polygonal paths, let \bar{R} be its equivalence class under the relation \cong defined in Definition 3.5.

Definition 3.8. *(master sequences) Let R be an admissible sequence. An admissible sequence C defining \bar{R} is a master sequence for \bar{R} if for any $B \cong R$, then $B \leq C$.*

The intuition here is that elements of a master sequence approach the ideal points from “both sides”.

Lemma 3.9. *Given an admissible sequence R , there is a master sequence for \bar{R} .*

Lemma 3.10. *Let p, q in $\partial\mathcal{O}$. Then p, q are distinct if and only if there are master sequences $A = (a_i)$, $B = (b_i)$ associated to p, q respectively with $(a_i \cup \tilde{a}_i) \cap (b_j \cup \tilde{b}_j) = \emptyset$ for some i, j .*

We now define the topology in $\mathcal{D} = \mathcal{O} \cup \partial\mathcal{O}$.

Definition 3.11. *(topology in $\mathcal{D} = \mathcal{O} \cup \partial\mathcal{O}$) Let \mathcal{X} be the set of subsets U of $\mathcal{D} = \mathcal{O} \cup \partial\mathcal{O}$ satisfying the following two conditions:*

(a) $U \cap \mathcal{O}$ is open in \mathcal{O} .

(b) If p is in $U \cap \partial\mathcal{O}$ and $A = (a_i)$ is any master sequence associated to p , then there is i_0 satisfying two conditions: (1) $\tilde{a}_{i_0} \subset U \cap \mathcal{O}$ and (2) For any z in $\partial\mathcal{O}$, if it admits a master sequence $B = (b_i)$ so that for some j_0 , one has $\tilde{b}_{j_0} \subset \tilde{a}_{i_0}$ then z is in U .

Definition 3.12. *(the sets U_c, V_c) For any convex polygonal path c there are associated open sets U_c, V_c of \mathcal{D} defined as follows. Let \tilde{c} be the corresponding convex set of \mathcal{O} (if c has length 1 there are two possibilities). Let $U_c = \tilde{c}$. In addition let*

$$V_c = \tilde{c} \cup \{x \in \partial\mathcal{O} \mid \text{there is a master sequence } A = (a_i) \text{ with } \tilde{a}_1 \subset \tilde{c}\}$$

It is easy to verify that V_c is always an open set in \mathcal{D} . In particular it is an open neighborhood of any point in $V_c \cap \partial\mathcal{O}$. The rays of the polygonal path c are equivalent if and only if V_c is contained in \mathcal{O} . The notation V_c will be used from now on.

Lemma 3.13. *For any ray l of \mathcal{O}^s or \mathcal{O}^u , there is an associated point in $\partial\mathcal{O}$. Two rays generate the same point of \mathcal{O} if and only if the rays are equivalent (as rays!).*

Proposition 3.14. *The space $\partial\mathcal{O}$ is homeomorphic to a circle.*

Theorem 3.15. *The space $\mathcal{D} = \mathcal{O} \cup \partial\mathcal{O}$ is homeomorphic to the closed disk D^2 .*

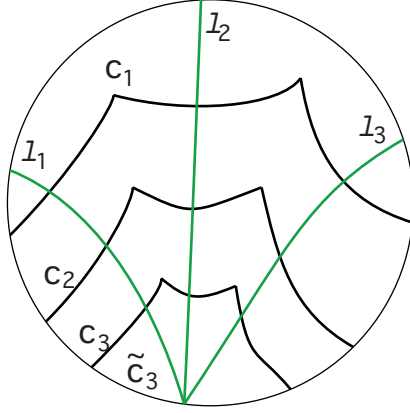

Figure 4: A standard sequence for ideal points of rays. Here l_1, l_2, l_3 is a maximal set of leaves with equivalent rays. Each convex polygonal chain c_i has length 3 with rays c_n^1, c_n^3 and a segment c_n^2 . For each j and n , c_n^j intersects l_j transversely. Finally (c_n) is nested and escapes compact sets in \mathcal{O} .

Notice that $\pi_1(M)$ acts on \mathcal{O} by homeomorphisms. The action preserves the foliations $\mathcal{O}^s, \mathcal{O}^u$ and also preserves convex polygonal paths, admissible sequences, master sequences and so on. Hence $\pi_1(M)$ also acts by homeomorphisms on \mathcal{D} .

Definition 3.16. (standard sequences associated to ideal points of rays) Suppose that Φ is a bounded pseudo-Anosov flow. Let l be a ray in \mathcal{O}^s or \mathcal{O}^u . Let $\mathcal{L} = \{l_j, 1 \leq j \leq k\}$ be the maximal collection of leaves of \mathcal{O}^s or \mathcal{O}^u so that each l_j has a ray equivalent to l . Then each sequence \mathcal{C} below is a master sequence for the ideal points of the corresponding rays of the leaves l_j : $\mathcal{C} = (c_n)$, $n \in \mathbf{N}$, where each (c_n) is a convex polygonal chain of length k , $c_n = \{c_n^1, \dots, c_n^k\}$ so that the following happens. For each n and for each j , then c_n^j intersects transversely the fixed ray of l_j . The c_n^1, c_n^k are rays, and the other elements of c_n are segments. The sequence (c_n) is nested with n and escapes compact sets in \mathcal{O} . In particular for each j , $(l_j \cap c_n^j)$ is a sequence that escapes in l_j when n converges to infinity.

We refer to fig. 4 for standard sequences of ideal points of rays.

Proposition 3.17. Let Φ be a bounded pseudo-Anosov flow in M^3 closed. Let p be an ideal point of \mathcal{O} . Then one of 2 mutually exclusive options occurs:

- 1) There is a master sequence $L = (l_i)$ for p where l_i are slices in leaves of \mathcal{O}^s or \mathcal{O}^u .
- 2) p is an ideal point of a ray l of \mathcal{O}^s or \mathcal{O}^u so that l makes a perfect fit with another ray of \mathcal{O}^s or \mathcal{O}^u . There are master sequences which are standard sequences associated to the ray l in \mathcal{O}^s or \mathcal{O}^u as described in definition 3.16.

For unbounded pseudo-Anosov flows there is one more possibility, which occurs when there is an infinite set of leaves of say \mathcal{O}^s which are pairwise non separated from each other. For simplicity of exposition we do not describe it here as it will not be needed for this article.

If l is a leaf of \mathcal{O}^s or \mathcal{O}^u , then we denote by ∂l the collection of ideal points of rays of l . So if l is a p -prong leaf, it has p ideal points.

4 Properties of perfect fits and convergence of leaves

In this section we rule out certain structures involving perfect fits and open product sets. We also discuss the possible limits of a sequence of points in a sequence of nested leaves. These properties will be used many times and in fundamental ways to prove the main results of this article.

The following is a closing lemma that works for pseudo-Anosov flows.

Proposition 4.1. (*closing lemma*)(Mangum [Man]) *Suppose that Φ is a pseudo-Anosov flow in M^3 closed. Let x be a non singular point. There is $\epsilon_0 > 0$, a priori depending on x so that if γ is a segment in an orbit of Φ with initial and end points less than $\epsilon < \epsilon_0$ from x , then γ is shadowed very close by a closed orbit. The closeness goes to zero as ϵ goes to zero. An analogous statement holds if x is singular and one assumes that the orbit return to the same sector defined by x .*

The ϵ_0 a priori depends on x . This is because if x is very close to a singular orbit, we may have a segment which returns very close, but to distinct sectors of the singular orbit. This cannot be shadowed by a closed orbit.

Definition 4.2. *A product open set is an open set Y in \widetilde{M} or \mathcal{O} so that the induced stable and unstable foliations in Y satisfy the following: every stable leaf intersects every unstable leaf.*

For example, if stable leaves A, B both intersect unstable leaves C, D , then the four of them bound a compact rectangle whose interior is a product open set. In our explorations we will also consider the closure of the open product set (in \widetilde{M} or \mathcal{O}) which is the open set union its boundary components.

We stress that product open sets and product regions in general are not the same, and the second is a subset of the first. Any pseudo-Anosov flows has product open sets, but only suspensions have product regions.

Definition 4.3. (*(3,1) ideal quadrilateral*) *A (3,1) ideal quadrilateral in \widetilde{M} (or \mathcal{O}) is a product open set Q so that the boundary has four pieces: two pieces S_1, S_2 are contained in stable leaves, and two pieces U_1, U_2 are contained in unstable leaves. In addition they satisfy: S_1 and U_1 are half leaves and S_2, U_2 are line leaves; S_1 intersects U_1 , but S_2 makes a perfect fit with both U_1 and U_2 and S_1 also makes a perfect fit with U_2 . The collection S_1, S_2, U_1, U_2 forms the sides of Q . See fig. 5, a. A (4,0) ideal quadrilateral is similarly defined.*

Notice that the sides of Q are not exactly the same as the boundary components of Q . In particular $S_1 \cup U_1$ is a boundary component of Q . In addition we will abuse notation and sometimes also call S_1 the full stable leaf containing it. If Q is an ideal (3,1) quadrilateral the following happens: if an unstable leaf Z intersects S_2 then it also intersects S_1 and similarly if a stable leaf L intersects U_2 then it also intersects U_1 . In an ideal (3,1) quadrilateral there is one actual corner in the boundary and 3 perfect fits. We show that these objects do not exist for any pseudo-Anosov flow.

Proposition 4.4. *Let Φ be an arbitrary pseudo-Anosov flow. Then there are no (3,1) or (4,0) ideal quadrilaterals.*

Proof. This is a rigidity result. We do the proof for (3,1) ideal quadrilaterals. The proof for (4,0) quadrilaterals is similar and easier, and is left to the reader. Suppose there is a (3,1) ideal quadrilateral Q with stable sides S_1, S_2 and unstable sides U_1, U_2 . Assume that S_1 intersects U_1 in an orbit γ and all other pairs of stable/unstable sides make a perfect fit.

First suppose that one side of Q is periodic. Without loss of generality assume that S_1 is left invariant under g non trivial in $\pi_1(M)$. What we mean here is that the full stable leaf containing S_1 is left invariant by g . By taking powers we may assume that g preserves orientation in \mathcal{O} and leaves invariant all the prongs in the stable leaf containing S_1 . It follows that the perfect fit S_1 with U_2 is taken to itself so $g(U_2) = U_2$. Going around the quadrilateral Q , this in turn implies that $g(S_2) = S_2$ and $g(U_1) = U_1$ – here again we are considering the full unstable leaf containing U_1 . Hence $g(U_1 \cap S_1) = U_1 \cap S_1$ or $g(\gamma) = \gamma$.

Let γ_2 be the periodic orbit in S_2 . Then $g(\gamma_2) = \gamma_2$. Since $\widetilde{\Lambda}^u(\gamma_2)$ intersects S_2 then it also intersects S_1 . Let $\beta = \widetilde{\Lambda}^u(\gamma_2) \cap S_1$. Since both S_1 and $\widetilde{\Lambda}^u(\gamma_2)$ are g -invariant, then $g(\beta) = \beta$. But then g leaves invariant two distinct orbits γ and β in S_1 . This is a contradiction and shows this cannot happen.

A very similar proof deals with the case where for instance S_2 is periodic.

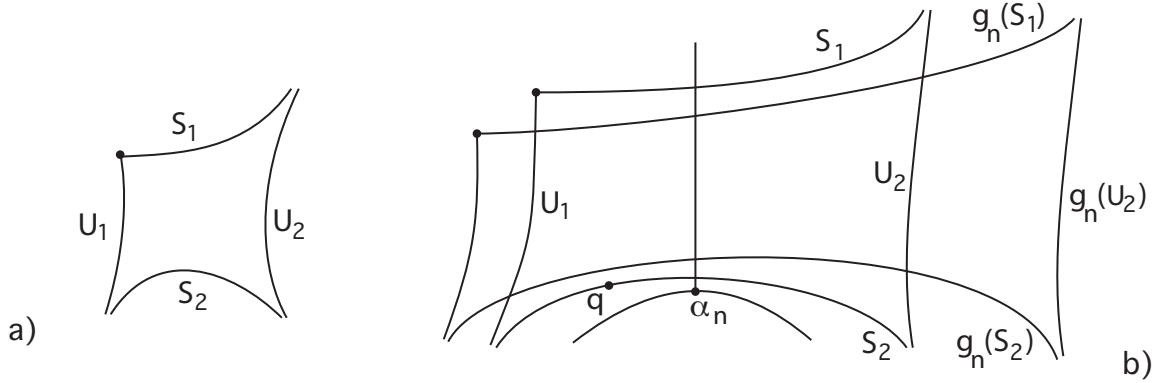

Figure 5: a. A (3,1) ideal quadrilateral. Here S_1 and U_1 intersect, but S_1, U_2 makes a perfect fit, as well as S_2, U_1 and S_2, U_2 . b) The use of covering translations to slightly perturb (3,1) ideal quadrilaterals.

From now on, suppose that no side of Q is periodic. The proof will be done by a perturbation/rigidity method. We will look at forward/backward accumulation points of an orbit in M . This orbit is the projection of an orbit in a side of Q . Then we will use the closing lemma to produce closed orbits and associated covering translations. The covering translations perturb the ideal quadrilateral Q and we analyse the perturbation.

Let α be an orbit in S_2 and let $\beta = \pi(\alpha)$. Then β is not a periodic orbit of $\tilde{\Phi}$ and neither is it in the stable or unstable leaf of a periodic orbit. Since there are finitely many singular orbits, each of which is periodic, it follows that the forward orbit of β also limits in a non singular point p_0 . We choose an initial point $q \in \alpha$ so that $p = \pi(q)$ is very close to p_0 . In order to that we most likely move forward along the orbit α and this changes the point of view in \tilde{M} . Notice however that flowing forward increases unstable distances along $\tilde{\Lambda}^u(\alpha)$ and therefore q is not close to S_1 . This is crucial. Now choose

$$t_n \rightarrow \infty, \text{ with } g_n(\tilde{\Phi}_{t_n}(q)) = q_n, \text{ and } q_n \rightarrow q_0 \text{ with } \pi(q_0) = p_0.$$

We can choose all $\pi(\tilde{\Phi}_{t_n}(q)) = \Phi_{t_n}(p)$ very close to p_0 . Since p_0 is not singular we can apply the closing lemma: it follows that the g_n are associated to periodic orbits α_n with points very close to q . This means that $g_n(\alpha_n) = \alpha_n$ and α_n has a point z_n very close to q . By changing the initial point q and taking a subsequence of (t_n) if necessary, we may assume that every g_n preserves the local transverse orientations to both $\tilde{\Lambda}^s$ and $\tilde{\Lambda}^u$.

We now analyse how this covering translation g_n acts on the (3,1) ideal quadrilateral Q . We refer to fig. 5, b.

Case 1 – Assume up to subsequence that no α_n is in Q .

Since the periodic orbit α_n has a point very z_n very close to $q \in S_2$ then $\tilde{\Lambda}^u(\alpha_n)$ intersects S_2 and hence $g_n(S_2)$. Because Q is a (3,1) ideal quadrilateral, this implies that $\tilde{\Lambda}^u(\alpha_n)$ also intersects S_1 and $g_n(S_1)$. Notice also that $g_n(S_2)$ has the point $g_n(\tilde{\Phi}_{t_n}(q))$ which is very close to q . In particular $g_n(S_2)$ separates $\tilde{\Lambda}^s(\alpha_n)$ from S_1 , because S_1 is not very close to q . This uses the property on local orientations above.

Notice that g_n acts in the backward flow direction in α_n hence g_n acts as an expansion in the ordered set of orbits in $\tilde{\Lambda}^u(\alpha_n)$. Hence $g_n(S_2)$ is farther from α_n than S_2 is. But since it separates S_1 from $\tilde{\Lambda}^s(\alpha_n)$ it follows that $g_n(S_2)$ intersects the ideal quadrilateral Q . We refer to figure 5, b for this situation. Since $g_n(S_2)$ intersects Q , then $g_n(S_2)$ intersects U_1 and U_2 . Since $g_n(S_2)$ makes a perfect fit with $g_n(U_2)$ it follows that $g_n(U_2)$ does not intersect the quadrilateral Q . Finally since $g_n(U_2)$ makes a perfect fit with $g_n(S_1)$ and $g_n(S_1)$ intersects $\tilde{\Lambda}^u(\alpha_n)$, we obtain that $g_n(S_1)$ intersects Q . Then g_n contracts the interval of orbits $\tilde{\Lambda}^u(\alpha_n) \cap Q$ between S_1 and S_2 . This forces another periodic orbit in $\tilde{\Lambda}^u(\alpha_n)$, besides α_n . This is a contradiction. This finishes the analysis of Case 1.

Case 2 – Assume up to subsequence that every α_n is in Q .

Since for every n the orbit α_n has points close to q , we may assume that the sequence (α_n) converges to an orbit α . Let $V = \tilde{\Lambda}^u(\alpha)$. Since the lengths of orbits $\pi(\alpha_n)$ converge to infinity then the sequence

$$(\tilde{\Lambda}^u(\alpha_n) \cap g_n(S_2))$$

escapes compact sets in \mathcal{O} . Let T_n be the component of $g_n(S_1) - \tilde{\Lambda}^u(\alpha_n)$ which makes a perfect fit with $g_n(U_2)$ and let T'_n the component of $g_n(S_1) - \tilde{\Lambda}^s(\alpha_n)$ which makes a perfect fit with $g_n(U_1)$. If either sequence (T_n) or (T'_n) escapes compact sets in \mathcal{O} then we produce a product region in \mathcal{O} , contradiction.

It follows that both sequences (T_n) and (T'_n) converge to a collection of leaves of \mathcal{O}^s . No leaf of \mathcal{O}^s belongs to both sets of limits because the sequence $(\tilde{\Lambda}^u(\alpha_n) \cap g_n(S_1))$ escapes in \mathcal{O} . This is the crucial fact here. Therefore the union of the leaves in the limits has at least two leaves. All of these leaves are non separated from each other in between U_1 and U_2 . By Theorem 2.7 these leaves are periodic and left invariant by a non trivial covering translation f . In addition one of the leaves in the limit of (T_n) makes a perfect fit with $V = \tilde{\Lambda}^u(\alpha)$. Hence $f(V) = V$ also. Notice that the union of the limits of (T_n) and (T'_n) is a finite set. It is the maximal collection of leaves non separated from these leaves between U_1 and U_2 .

The sequence $(g_n(U_2))$ converges to a collection of unstable leaves. Because of the finiteness of the number of leaves in the limit of the sequences (T_n) and (T'_n) , it follows that one of the leaves in the limit of $(g_n(U_2))$ makes a perfect fit with a leaf in the limit of the sequence (T_n) . Hence the leaves in the limit of $(g_n(U_2))$ are also invariant under f . Finally consider the component Y_n of $(g_n(S_2) - \tilde{\Lambda}^u(\alpha_n))$ which makes a perfect fit with $g_n(U_2)$. Since there are no product regions, then as before the sequence (Y_n) converges to a collection of leaves; and one of which makes a perfect fit with a leaf in the limit of $(g_n(U_2))$. Hence all leaves in the limit of (Y_n) are also invariant under f . In addition one leaf in the limit of (Y_n) intersects $V = \tilde{\Lambda}^u(\alpha)$ and let β be this intersection.

Let Q_1 be the product open set bounded by the limit leaves of the sequence (T_n) , the limit of $(g_n(U_2))$, the limit of (Y_n) and the half leaf of $\tilde{\Lambda}^u(\beta)$ bounded by β and making a perfect fit with a leaf in the limit of (T_n) . This region has all the boundary components left invariant by f . It has one corner in β and all other interactions between “consecutive” leaves in the boundary of Q_1 are either by perfect fits or non separated leaves. This situation was disallowed in the beginning of the proof of Proposition 4.4 which dealt with the periodic case. This finishes the analysis of Case 2.

This finishes the proof of proposition 4.4. □

Remark – What happens if one tries to apply the rigidity argument of the second possibility of this proposition to the case when S_2 is periodic? Then for any orbit β' in $\pi(S_2)$ it limits forward only in the periodic orbit in $\pi(S_2)$, hence the perturbation obtained by g_n sends S_2 to itself and likewise for U_2 and S_1 . So this in itself yields nothing. One can only apply the perturbation technique for non periodic leaves.

We can further eliminate more exotic regions in \mathcal{O} in the case of bounded pseudo-Anosov flows.

Lemma 4.5. *Suppose that Φ is a bounded pseudo-Anosov flow. Then there are no product open sets Q in \mathcal{O} so that the boundary has a single corner or no corner.*

Proof. Suppose that there is a product open set Q with one corner. Here a corner is an orbit which is in two leaves, one stable and one unstable which have half leaves contained in the boundary of Q . This is the case of a $(3, 1)$ ideal quadrilateral which has a single corner. The components of boundary of Q which do not have corners are full line leaves in their respective leaves of the stable or unstable foliations.

Since there is a corner in Q – the region Q is not the whole orbit space. Since every stable leaf intersects every unstable leaf in Q , the induced stable and unstable foliations in Q have leaf space homeomorphic to \mathbf{R} . There are 4 possible sections of the boundary of Q corresponding to escaping in stable/unstable directions. At most two sections are made of stable leaves (or subsets thereof) and at most two sections are made of unstable leaves. If any of these sections has more than one boundary leaf then these leaves are non separated from each other in their respective leaf spaces. By Theorem 2.7 these

boundary leaves are periodic and are both left invariant by some non trivial g in $\pi_1(M)$. Consider the set of non separated leaves from these leaves. Under the bounded hypothesis, theorem 2.7 implies that this set is finite – any two non separated leaves are connected by a chain of adjacent lozenges hence by a chain of perfect fits, so this is bounded. We denote this set of non separated leaves by B_1, \dots, B_n . Since there is only one corner, there is a full line leaf of some B_j contained in the boundary of Q . We still denote this by B_j . We assume that this is the last one contained in the boundary of Q . Since there is no product region and the set of non separated leaves from any leaf is bounded, it follows that B_j makes a perfect fit with another leaf in the boundary of Q . As in the previous proposition this leaf is also left invariant by g . Going around the boundary of Q we arrive at a contradiction as in the proof of Proposition 4.4.

This reduces the analysis to the case that all 4 boundary areas have only one leaf. Since there are no product regions, this forces perfect fits producing a (3, 1) ideal quadrilateral, contradiction to the previous proposition.

The same proof works if Q has no corners. This finishes the proof of lemma 4.5. \square

Remark – The theorem is false without the bounded hypothesis. It is false for example for suspension Anosov flows. Just take any orbit γ of $\tilde{\Phi}$ and consider a sector Q defined by γ . The sector is a product open set with only one corner in the boundary. In addition the theorem is also false if there is a collection of leaves non separated from each other which is infinite. This generates a scalloped region as described in [Fe9]. One can get a “quarter” of this scalloped region which is a product open set and has only one corner in the boundary.

It turns out that the bounded hypothesis is not needed for regions without corners, except for the whole of \tilde{M} in the case of suspension Anosov flows. Since we do not need this fact in this article we do not prove it.

The next result will be used many times in this article.

Proposition 4.6. *(periodic double perfect fits) Suppose that two distinct half leaves S_1, S_2 of a slice of a leaf S of $\tilde{\Lambda}^s$ (or $\tilde{\Lambda}^u$) make a perfect fit respectively with A, B , which are leaves of $\tilde{\Lambda}^u$ (or $\tilde{\Lambda}^s$). Suppose that S does not separate A from B . Then A, B and S are all periodic and leaf invariant by a non trivial covering translation g .*

Proof. The content of the proposition is in the the first conclusion (periodic behavior), as invariance of perfect fits by the action of $\pi_1(M)$ leads to the second conclusion. In fact this shows that if one of A, B, S is periodic, then so are the others.

Suppose by way of contradiction that A, B, S are not periodic. Without loss of generality assume that S is a stable leaf and hence A, B are unstable leaves. By assumption A, B, S do not have singularities and the slice leaf of S is S itself. Also since S is not singular, there is a stable leaf L near enough S and intersecting both A and B , as A, B make perfect fits with S and are in the same complementary component of S . We first will build a structure similar to two adjacent lozenges with some sides in A, B, S . The preliminary step is to eliminate singularities. Fix the leaf L .

Claim – There is no singular stable leaf F intersecting both A and B with a singular orbit η which is between $A \cap F$ and $B \cap F$ in F .

Suppose by way of contradiction there is such a leaf F . Let F_0 be the flow band in F from $A \cap F$ to $B \cap F$. Then F_0 , half leaves of A and B respectively and S bound an open region D in \tilde{M} . If there is prong F_1 of F entering D then F_1 cannot intersect A or B as stable and unstable leaves intersect in at most one orbit. Clearly F_1 cannot intersect S as both are stable leaves. Then this prong F_0 would not be properly embedded in \tilde{M} , contradiction. Hence there is no such prong F_1 . In particular this also shows that the region D has no singularities (because of perfect fits). Let η be the singular orbit in F , so $\eta \subset F_0$.

There is a prong E_0 of $\tilde{\Lambda}^u(\eta)$ intersecting S in an orbit δ , see fig. 6. Let v a point in δ and $u = \pi(v)$. Flow u forward and let u_0 be an accumulation point in M . By adjusting the initial point v we may suppose that u and $\Phi_t(u)$ are extremely close – and close to u_0 . Hence there is a covering translation

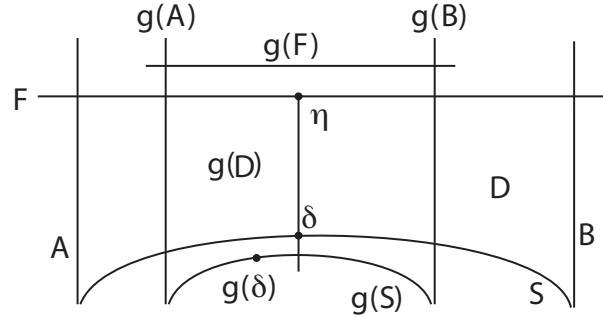

Figure 6: A double perfect fit. This figure illustrates the impossibility of a singular orbit η so that its stable leaf F intersects both A and B and η is between $F \cap A$ and $F \cap B$.

g sending a lift $\tilde{\Phi}_t(v)$ very near v . Then $g(E_0)$ intersects the region D . As in the previous proposition we can assume that g preserves the local transverse orientation to $\tilde{\Lambda}^s, \tilde{\Lambda}^u$ near δ – notice that δ is not singular by hypothesis.

Notice that $g(S) \neq S$ as S is not periodic. In addition $g(E_0) \cap E_0 = \emptyset$ because we flow the orbit of u forwards. Since D has not singularities, then $g(\eta)$ is outside D . But this forces η to be contained in $g(D)$, which is a contradiction, because η is singular and $g(D)$ does not have singularities. This proves the claim.

Now parametrize the stable leaves intersecting B beyond L as $\{L_t, t \geq 0, L_0 = L\}$. Beyond means that L_0 separates $L_t, t > 0$ from S . For t small, L_t intersects A . There are several possibilities: For such t , let V_t be the region in \tilde{M} bounded by L_t, A, B and S . This is a product open set.

Possibility 1 – For every t , L_t intersects A and $L_t \cap A$ escapes in A as $t \rightarrow \infty$.

If the collection (L_t) escapes compact sets in \tilde{M} as $t \rightarrow \infty$, then this produces a product region in \tilde{M} and Φ is topologically conjugate to a suspension Anosov flow, contradiction to assumption. If the collection (L_t) converges to a set $\{U_i, i \in I\}$ of stable leaves, then $V = \cup_{t \geq 0} V_t$ is a product open set with boundary A, B, S and (possibly a proper subset of) $\{U_i, i \in I\}$. This product open set has no corners and is disallowed by lemma 4.5.

Possibility 2 – There is t_0 so that $(A \cap L_t)$ escapes compact sets in A as $t \rightarrow \infty$.

Then $V = \cup_{t < t_0} V_t$ is a product open set with only one corner $B \cap L_{t_0}$. This is also disallowed by proposition 4.4 and lemma 4.5. The same holds if every L_t intersects A and $\lim_{t \rightarrow \infty} (A \cap L_t) = \beta$ and β is an orbit in A .

The final possibility is the most intricate:

Possibility 3 – There is $t_0 > 0$ so that for any $t < t_0$, the leaf L_t intersects A but L_{t_0} does not. Also $\lim_{t \rightarrow t_0} (L_t \cap A) = \alpha$ is an orbit in A .

Let $U_0 = \tilde{\Lambda}^s(\alpha)$ and $U_1 = \tilde{\Lambda}^s(L_{t_0} \cap B)$. Then U_0, U_1 are stable leaves which are non separated from each other. In particular U_0, U_1 are periodic and are left invariant by some non trivial $h \in \pi_1(M)$.

Let $V = \cup_{t < t_0} V_t$ which again is a product open set in \tilde{M} . But now V has 2 corners α and β . In fact this is quite possible for V could be the union of two adjacent lozenges and their common side. We consider the set of unstable leaves intersecting S starting from A . There is a first unstable leaf E intersecting S and not intersecting U_0 . Then E and U_0 make a perfect fit. This implies that E is periodic and left invariant by h .

Let $\gamma = E \cap S$. We want to prove that γ is periodic, so we assume that γ is not periodic and use a perturbation argument as done previously. Let $v \in \gamma$ and consider $u = \pi(v)$. Flow u forward and consider forward limit points. Since γ is not periodic, then as done before, we can assume that v is chosen so that there is $g \in \pi_1(M)$ with $g(\gamma)$ very close to and distinct from γ and in addition $g(\tilde{\Lambda}^u(\gamma)), \tilde{\Lambda}^u(\gamma)$ are distinct. For simplicity we only do the proof when $g(\gamma)$ is outside of V and there are only 2 leaves in the

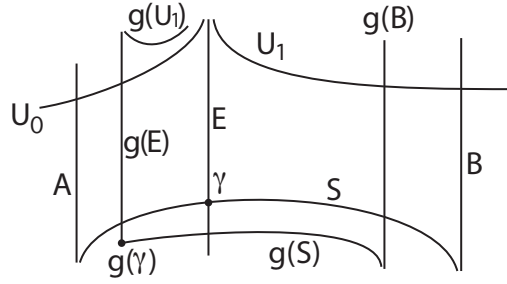

Figure 7: Another perturbation of a double perfect fit.

boundary of V non separated from U_0 . The other cases are similar.

Without loss of generality assume that $E = \tilde{\Lambda}^u(\gamma)$ separates B from $g(E)$. Notice that $g(B)$ makes a perfect with $g(S)$ and so $g(B)$ is separated from $g(E)$ by E and $g(U_1)$ is non separated from a leaf making a perfect fit with $g(E)$, see fig. 6. This shows that $g(B)$ cannot intersect $g(U_1)$, which is a contradiction.

The contradiction was obtained from the assumption that γ was not periodic. We conclude that γ is periodic. In particular S is periodic and this also implies that A, B are periodic. The rest of the proposition follows easily. This finishes the proof of proposition 4.6. \square

Lemma 4.7. (*escape lemma - bounded version*) *Let Φ be a bounded pseudo-Anosov flow. Let $(x_i), i \in \mathbf{N}$ be a sequence in \mathcal{O} with (x_i) converging to x in $\mathcal{O} \cup \partial\mathcal{O} = \mathcal{D}$. Let $y_i \in \mathcal{O}^s(x_i) \cup \partial\mathcal{O}^s(x_i)$ so that (y_i) converges to y in $\mathcal{O} \cup \partial\mathcal{O}$. Let $l_i = \mathcal{O}^s(x_i)$.*

- *Suppose x is in \mathcal{O} . If y is in \mathcal{O} then $\mathcal{O}^s(y)$ and $\mathcal{O}^s(x)$ are non separated from each other in the leaf space of \mathcal{O}^s . If y is in $\partial\mathcal{O}$ then $y \in \partial l$ where $l \in \mathcal{O}^s$ and l non separated from $\mathcal{O}^s(x)$.*
- *Suppose that x is in $\partial\mathcal{O}$. If there is a subsequence (l_{i_k}) of (l_i) which escapes compact sets in \mathcal{O} , then $(l_{i_k} \cup \partial l_{i_k})$ converges to x in $\mathcal{O} \cup \partial\mathcal{O}$ and hence $y = x$. Otherwise assume up to subsequence that (l_i) converges to a collection $\{s_j, j \in I\}$ of non separated leaves in \mathcal{O}^s . Then x is an ideal point of some s_j and $y \in \bigcup_{j \in J} (s_j \cup \partial s_j)$. In particular corresponding ideal points of $\mathcal{O}^s(x_i)$ converge to an ideal point of one of s_j .*

Proof. Suppose first that x is in \mathcal{O} . If y is in \mathcal{O} then the statement is obvious, because for big i , then y_i is in \mathcal{O} and therefore in $\mathcal{O}^s(x_i)$. Let then $y \in \partial\mathcal{O}$. If there is a subsequence (x_{i_k}) with $\mathcal{O}^s(x_{i_k})$ constant, then the conclusion follows immediately. Suppose then up to subsequence that the $\{\mathcal{O}^s(x_i)\}$ are all distinct and forming a nested sequence of leaves in \mathcal{O}^s , all in a complementary component of $\mathcal{O}^s(x)$ in \mathcal{O} . Since Φ is bounded there are finitely many leaves of \mathcal{O}^s non separated from $\mathcal{O}^s(x)$ and we can order then so that z_1 is the first one and z_k (for some k) is the last one. Let R be the complementary region in \mathcal{O} of the union of the $\{z_j\}$ which contains all the l_i . Theorem 2.7 shows that consecutive z_j, z_{j+1} are connected by two adjacent lozenges which have a common side in an unstable leaf u_j . Let a_j be the common ideal point of these 3 leaves. Let a_0 be the ideal point of z_0 which is not a_1 but is still an ideal point of the region R . Similarly let a_k be the corresponding ideal point of z_k . If $k = 1$, then a_0, a_1 are ideal points of z_1 . Choose master sequences defining a_0, a_k . Since z_1 is the first leaf non separated from $\mathcal{O}^s(x)$, then the master sequence can be chosen to have at most one more piece after crossing z_1 . This means that there may be an unstable leaf u contained in R with ideal point a_0 , hence we need one more piece in the polygonal path. But there cannot be another stable leaf in R with ideal point a_0 . In particular the ideal points of $\mathcal{O}^s(x_i)$ in this direction converge to a_0 . So if y_i is in $\partial\mathcal{O}$ this shows that the sequence (y_i) converges to either a_0 or a_k .

Suppose then that up to subsequence (y_i) is contained in \mathcal{O} . Choose master sequences for each $a_j, 0 < j < k$. Let c_j be one such polygonal path in the master sequence for a_j . Then the intersection $U_{c_j} \cap R$ has boundary made up of 5 pieces: 1) one ray in z_j with ideal point a_j , 2) one finite segment in

an unstable leaf with endpoint in z_j , 3) one finite segment in a stable leaf intersecting u_j in the interior, 4) one finite segment in an unstable leaf with an endpoint in z_{j+1} , and 5) one ray in z_{j+1} with ideal point a_j . The leaves l_i are converging to the collection $\{z_j\}$ so they intersect the U_{c_j} , and also corresponding subsets for a_0 and a_k . If the y_i are not in the union of the U_{c_j} (and respective sets for a_0 and a_k), then up to subsequence the y_i converge to a point in one of the z_j . But this point is y assumed to be in $\partial\mathcal{O}$, contradiction. So the y_i are eventually in the union above. Since the U_{c_j} can be arbitrarily close to a_j this shows that y_i converges to one of $a_j, 0 \leq j \leq k$. This finishes the analyses in this case.

Suppose otherwise that x is in $\partial\mathcal{O}$. If $y \in \mathcal{O}$, reverse the roles of x and y and obtain the same result. Notice that $y \in \mathcal{O}$ implies that no subsequence (l_{i_k}) escapes compact sets in \mathcal{O} . So assume that $y \in \partial\mathcal{O}$, that is, both x and y are in $\partial\mathcal{O}$. Suppose first that up to subsequence (l_i) escapes compact sets in \mathcal{O} . Consider a neighborhood of x in $\mathcal{O} \cup \partial\mathcal{O}$ defined by a polygonal path c and let $V = V_c$ (see Definition 3.12 for V_c) containing x in its closure. For i big enough $\mathcal{O}^s(x_i)$ has points x_i in V , since (x_i) converges to x in $\mathcal{O} \cup \partial\mathcal{O}$. If $\mathcal{O}^s(x_{i_k}) \cup \partial\mathcal{O}^s(x_{i_k})$ is not contained in V for a subsequence (i_k) and any k , then the sequence $(\mathcal{O}^s(x_{i_k}))$ limits in a non trivial interval K of $\partial\mathcal{O}$. This is because (l_{i_k}) escapes compact sets in \mathcal{O} . But then the interval K cannot have any ideal points of leaves. This is a contradiction [Fe9]. Hence $\mathcal{O}^s(x_{i_k}) \subset V$ for i big and so $y_{i_k} \in \bar{V} \subset (\mathcal{O} \cup \partial\mathcal{O})$. This implies that $y_i \rightarrow x$ as $i \rightarrow \infty$.

Finally suppose that $(\mathcal{O}^s(x_i))$ does not escape compact sets. Then assume up to subsequence that (l_{i_k}) converges to $\{s_j, j \in J\}$. Then choose $z_{i_k} \in \mathcal{O}^s(x_{i_k})$ with (z_{i_k}) converging to z in \mathcal{O} and apply the proof of the first case twice: once with (z_{i_k}) in the place of (x_i) and (y_{i_k}) in the place of (y_i) . The second time apply it to (z_{i_k}) in place of (x_i) and (x_{i_k}) in place of (y_i) . This completes the proof of the lemma. \square

There is also an unbounded version of the escape lemma. Since it will not be used in this article we do not state or prove it.

5 Metric properties and bounds on free homotopies

A free homotopy between closed orbits of pseudo-Anosov flows lifts to a chain of lozenges in the universal cover, where all corner orbits project to closed orbits which are freely homotopic to each other (alternatively reversing flow direction).

Definition 5.1. *A free homotopy is called indivisible if any minimal chain of lozenges associated to it has only one lozenge.*

Minimal means that there is no backtracking in the chain of lozenges.

The goal of this section is to relate pseudo-Anosov flows with the geometry of the manifold. We will focus on the size of free homotopies of closed orbits, distance between corner orbits of lozenges, and how chains of perfect fits produce chains of free homotopies. This will show a strong connection with the geometry of the manifold. The first result is fundamental.

Theorem 5.2. *Let Φ be a pseudo-Anosov flow. There is a constant a_0 depending only on the geometry of M and on the flow Φ , so that if α, β are corner orbits of a lozenge C in \widetilde{M} , then they are a bounded distance from each other: $d_H(\alpha, \beta) < a_0$, where d_H denotes Gromov-Hausdorff distance.*

Proof. This result says that dynamics (pseudo-Anosov flow) is strongly connected with geometry (distance in \widetilde{M}). The proof is by contradiction. We get lozenges with corner orbits farther and farther away and in the limit we produce a product open set of the type ruled out by lemma 4.5.

So suppose this is not true. Then there are lozenges C_i with corner orbits α_i, β_i and p_i in say α_i with $d(p_i, \beta_i) \rightarrow \infty$ as $i \rightarrow \infty$. Up to the action of $\pi_1(M)$ we will assume that $p_i \rightarrow p_0$ and p_i is always in the same sector of p_0 . It follows that the sequence β_i escapes compact sets in \widetilde{M} and the projections to \mathcal{O} also escape compact sets as $i \rightarrow \infty$.

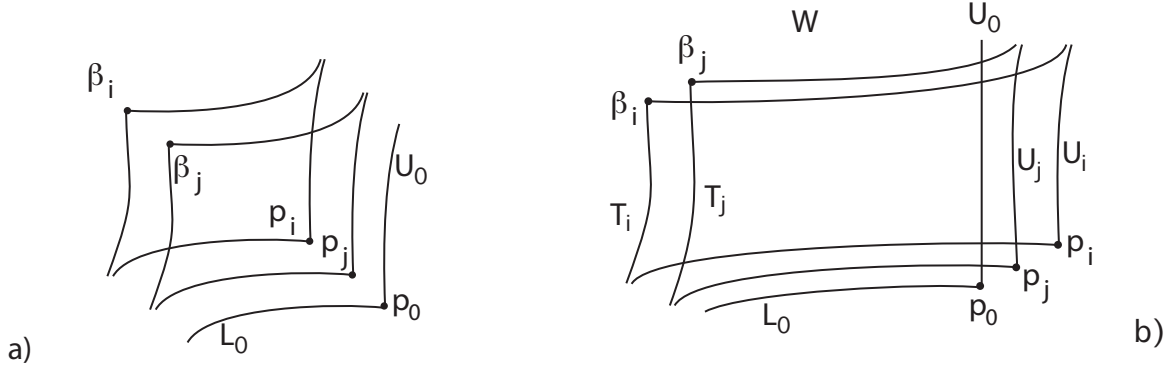

Figure 8: The perturbation method applied to lozenges. In both cases $j > i$ so p_j is closer to p_0 than p_i . In case a) the lozenges C_i are contained in the sector W . In part b) the lozenges C_i are not contained in W . In particular in case b), $\tilde{\Lambda}^u(p_i)$ is disjoint from W for all i .

Let $L_i \subset \tilde{\Lambda}^s(p_i)$, $U_i \subset \tilde{\Lambda}^u(p_i)$ be the sides of C_i containing p_i . Up to subsequence we assume that $L_i \rightarrow L_0$ contained in a line leaf of $\tilde{\Lambda}^s(p_0)$ and $U_i \rightarrow U_0$ contained in a line leaf of $\tilde{\Lambda}^u(p_0)$ (and maybe other leaves as well). Let W be the sector of p_0 bounded by L_0 and U_0 . Suppose up to subsequences that both sequences $(\tilde{\Lambda}^s(p_i))$ and $(\tilde{\Lambda}^u(p_i))$ are nested.

There are 3 possibilities.

Option 1 – $C_i \subset W$.

Suppose up to subsequence that all p_j are very near p_0 . In particular we may assume that p_i is in C_j if $i < j$. Let β_i be the other corner of C_i . The conditions above imply that β_j is in C_i if $j > i$, see figure 8, a. There is an unstable leaf Y intersecting L_0 and every C_i and a stable leaf S intersecting U_0 and every C_i . This is because $\tilde{\Lambda}^u(\beta_i)$ cannot intersect L_0 and $\tilde{\Lambda}^s(\beta_i)$ cannot intersect U_0 . Fix one such i . This implies that if $j > i$ then β_j is contained in a fixed rectangle with sides contained in $S, Y, \tilde{\Lambda}^s(\beta_i), \tilde{\Lambda}^u(\beta_i)$. Therefore the sequence (β_j) does not escape compact sets in \mathcal{O} , contradiction to hypothesis.

Option 2 – C_i is not contained in W and p_0 is not in C_i , see figure 8, b.

Assume without loss of generality that $U_i \cap W = \emptyset$ as depicted in figure 8, b. This implies that L_i have half leaves contained in W . Let

$$S_i \subset \tilde{\Lambda}^s(\beta_i) \quad \text{and} \quad T_i \subset \tilde{\Lambda}^u(\beta_i)$$

be the other 2 sides of C_i . Here p_i is not contained in C_j for $j > i$ or $j < i$. Similarly β_i is not contained in C_j for $j > i$ or $j < i$. Since the sequence (U_i) converges to U_0 and $U_i \cap W = \emptyset$, then the sequence (T_i) is nested and contained in W . Therefore the sequence (T_i) limits to a collection of leaves $\{V_j\}, j \in J$, at least one of which (let it be V_0) makes a perfect fit with L_0 . Consider the sequence (S_i) . Each S_i intersects U_0 and since (p_i) converges to p_0 , then $(S_i \cap U_0)$ escapes in U_0 . If the sequence (S_i) escapes compact sets in \tilde{M} , this produces an unstable product region, contradiction. We conclude that (S_i) converges to a collection of leaves $\{R_n\}, n \in N$, at least one (let it be R_0) makes a perfect fit with U_0 . If one the limit leaves $\{R_n\}$ intersects one of the other limit leaves $\{V_j\}$ in q_0 this forces the sequence of corners (β_i) to converge to q_0 . This contradicts the assumption that (β_i) escapes compact sets in \tilde{M} . Therefore these two sets of leaves are disjoint as subsets of \tilde{M} . Let A be the limit of the sequence (C_i) of lozenges. It is a region in \tilde{M} bounded by $L_0, U_0, \{R_j\}, j \in J, \{R_n\}, n \in N$. It is a product open set with a single corner p_0 . This was disallowed by lemma 4.5.

The last option is:

Option 3 – p_0 is in C_i for all i .

Here p_i is in C_i if $j > i$ and β_j is not in C_i if $j > i$. Exactly as in Option 2 the sequence (S_i) cannot escape in \mathcal{O} or it produces an unstable product region. In fact the same argument shows in Option 3, that the sequence (T_i) cannot escape in \mathcal{O} either. The limits of these sequences have one leaf making a perfect fit with L_0 and one leaf making a perfect fit with U_0 and as in Option 2, no leaves in the limits of these sequences can intersect. We obtain a contradiction as in Option 2.

This is the last possibility. Notice that in this last option p_0 cannot be singular. This finishes the proof of proposition 5.2. \square

This already has consequences for free homotopies:

Corollary 5.3. *Suppose that periodic orbits α, β of a pseudo-Anosov flow Φ are freely homotopic by an indivisible free homotopy. Then there is a free homotopy so that every point moves at most a_0 by the homotopy.*

Proof. The orbits α, β lift to the corner orbits of a lozenge. Then apply the previous theorem. \square

We will now proceed to show that any chain of perfect fits of length k generates a chain of free homotopies of length at least k . First we need to analyse forward limits of orbits. We need the following technical result.

Lemma 5.4. *Let γ be an orbit of Φ . Then either γ is in the stable leaf of a periodic orbit or the forward limit set of γ intersects infinitely many local stable sheets near some point.*

Proof. Fix $a_1 > 0$. There are finitely many rectangle disks transverse to Φ whose union intersects every segment of orbit of Φ of length at least a_1 . A rectangle disk is a closed disk transverse to Φ so that the induced stable and unstable foliations form a product structure in the rectangle disk. Near a p -prong singularity we can use for instance $2p$ rectangle disks. The leaves of the induced stable/unstable foliations in the rectangle disks are called local stable/unstable sheets. Notice that if an orbit intersects a stable sheet twice then this orbit is in the stable leaf of a periodic orbit.

Let α be an orbit in the forward limit set of γ . If α is dense we are done. Otherwise let B be a minimal closed set in the closure of α where we may assume that B is not a singular orbit. This is because if γ only limits in a singular closed orbit, then γ is in the stable leaf of this closed orbit. If B is the closure of an almost periodic orbit [Bowe] we obtain the conclusion of the lemma. An almost periodic orbit δ is a non periodic orbit so that its closure δ is a minimal set for the flow. Suppose finally that B is a closed orbit intersecting a rectangle disk D in the interior. The orbit γ keeps returning to D very close to $B \cap D$. We can assume D is fairly small so that $B \cap D$ is a single point. But γ does not intersect $\Lambda^s(B) \cap D$ more than once or else we would be in the first option of the lemma. So the holonomy along B pushes γ closer to the unstable local sheet $\Lambda^s(B) \cap D$ and farther from the stable local sheet $\Lambda^s(B) \cap D$ until the first return escapes D . Since γ has to forward limit on B , then it has to intersect infinitely many stable leaves. This finishes the proof of the lemma. \square

A very useful result in this section is the following:

Proposition 5.5. *(from perfect fits to lozenges) Suppose that leaves L, U form a perfect fit. Then there are orbits α in U and β in L so that α, β are the corners of a lozenge which has a side in L and a side in U which make the perfect fit above.*

Proof. Up to taking a double cover assume that M is orientable. Hence any local return map of the flow restricted to a transverse disk in M is orientation preserving. Suppose that L is a stable leaf, U unstable. Let α_0 be an orbit of L – all orbits in L are forward asymptotic. If α_0 is in the stable leaf of a periodic orbit α_1 , then $\alpha_1 \subset L$ and U is periodic and has a periodic orbit β_1 so that α_1, β_1 are the corners of a lozenge as desired.

Hence from now on we assume that L is not a periodic leaf. By the previous lemma $\pi(\alpha_0)$ forward intersects infinitely many distinct local stable sheets. Consider two of these intersections which are

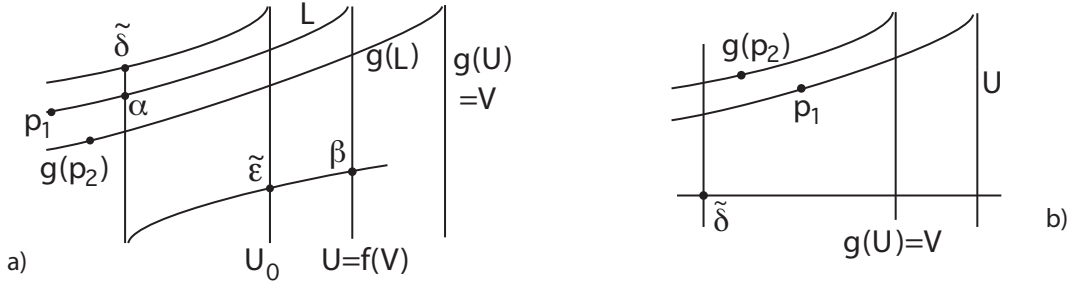

Figure 9: *Perturbing a perfect fit to produce a lozenge. The pictures depict the situation in \tilde{M} , therefore $g(p_2)$ is very close to p_1 . Recall that \mathcal{O} does not have a metric.*

sufficiently close, and not close to a singular orbit, so we can apply the closing lemma. These lift to p_1, p_2 in α_0 , with $p_i = \tilde{\Phi}_{t_i}(p_0)$ and $t_2 \gg t_1 \gg 0$. In addition they satisfy $\pi(p_1), \pi(p_2)$ are very close and there is g in $\pi_1(M)$ so that $g(p_2)$ is very close to p_1 and $g(p_2)$ is in the component of $M - \tilde{\Lambda}^s(p_1)$ containing U , see figure 9, a.

Here we are using that the forward limit set of $\pi(\alpha_0)$ goes through infinitely many stable leaves nearby. So we can choose the sides accordingly. Notice that p_1 is not very close to U or else $\tilde{\Lambda}^s(p_1)$ would intersect U and not make a perfect fit with it. By the closing lemma the element g of $\pi_1(M)$ is associated to a periodic orbit δ . δ has a lift $\tilde{\delta}$ to \tilde{M} , which is very close to all of p_1, p_2 and $g(p_2)$. Since g is associated to the backwards direction of the flow, then g acts as a contraction on the set of orbits of $\tilde{\Lambda}^s(\tilde{\delta})$ and as an expansion on the set of orbits of $\tilde{\Lambda}^u(\tilde{\delta})$. This implies that $\tilde{\delta}$ is in the component of $\tilde{M} - L$ not containing U .

We first claim that $g(L)$ intersects U . We have to be careful. From the starting point p_0 there is a distance $\epsilon > 0$ so that if x is in $\tilde{\Lambda}^u(p_0)$ in the component of $\tilde{M} - \tilde{\Lambda}^s(p_0)$ containing U , and $d(x, p_0) < \epsilon$ then $\tilde{\Lambda}^s(x)$ intersects U . This is because L, U make a perfect fit. But now the basepoint changed from p_0 to p_1 . This is not a problem in this case, because going forward from p_0 to p_1 increases the unstable distances. Therefore from the point of view of p_1 even a stable leaf much farther away will intersect U . It follows that $g(L)$ intersects U .

Let $V = g(U)$ and let $f = g^{-1}$. Then $f(V) = U$ and $f(V)$ intersects $g(L)$. Therefore $f^2(V)$ intersects $f g(L) = L$ and so intersects $g(L)$. This is again because g is acting as an expansion in the set of unstable orbits in $\tilde{\Lambda}^u(\tilde{\delta})$. It follows that the sequence $(f^n(V))$ cannot escape compact sets in \tilde{M} and limits to a leaf U_0 making a perfect fit with $\tilde{\Lambda}^s(\tilde{\delta})$. This leaf is invariant under g and so has a periodic orbit $\tilde{\epsilon}$. Then $\tilde{\delta}, \tilde{\epsilon}$ are the corners of a lozenge C_0 which has sides also in $S = \tilde{\Lambda}^s(\tilde{\epsilon})$ and $T = \tilde{\Lambda}^u(\tilde{\delta})$. For n big enough the leaf $f^n(V)$ intersects S and therefore $U = f(V)$ also intersects S , by f invariance. Let

$$\beta = S \cap U \quad \text{and} \quad \alpha = \tilde{\Lambda}^u(\tilde{\delta}) \cap L$$

Then α, β are the corners of a lozenge C which has sides contained in L and U , which make a perfect fit. The other two sides of C are contained in S and T which also makes a perfect fit. This finishes the proof of the proposition. \square

Remark – Why was lemma 5.4 needed? The concern was that we would only get a situation as in figure 9, b. In this situation the leaves $f^n(V)$ move away from $\tilde{\Lambda}^u(\tilde{\delta})$ when n increases. Recall that $\tilde{\delta}$ is the periodic orbit. A priori it could well happen that the sequence $(f^n(V))$ escapes compact sets in \tilde{M} and therefore we do not produce an unstable leaf invariant under g . Notice that the unstable band from $\tilde{\Lambda}^s(\tilde{\delta}) \cap \tilde{\Lambda}^u(g(p_2))$ to $g(p_2)$ along $\tilde{\Lambda}^u(g(p_2))$ is larger than that from $\tilde{\Lambda}^s(\tilde{\delta}) \cap \tilde{\Lambda}^u(p_1)$ to p_1 along $\tilde{\Lambda}^u(p_1)$. This is because p_2 is flow forward of p_1 and unstable objects grow forward. This is the reason it was necessary to have the alignment of $L = \tilde{\Lambda}^s(p_1)$ and $g(L) = \tilde{\Lambda}^s(g(p_2))$ as in figure 9, a in order to get an unstable leaf invariant under g .

Proposition 5.5 immediately implies Theorem B:

Corollary 5.6. *Suppose that Φ is a pseudo-Anosov flow which has a perfect fit L, U . A study of the asymptotic behavior of orbits in L, U produces free homotopies between closed orbits of Φ .*

Proof. Use the setup of the previous proposition. The free homotopy is from $\delta = \pi(\tilde{\delta})$ to $\epsilon = \pi(\tilde{\epsilon})$. The orbits $\tilde{\delta}, \tilde{\epsilon}$ are very close to L, U respectively and are obtained by a shadowing process. If L (and hence U) is not periodic this process a priori produces infinitely many free homotopies. This is because longer and longer segments in $\pi(L)$ are shadowed by a priori different closed orbits. \square

We now prove the main metric property we will use: A *forward ray* is just the set of points flow forward from some point. Similarly one defines a *backward ray*.

Remark – Notice that up to powers δ is freely homotopic to ϵ^{-1} . Therefore a flow forward ray in $\tilde{\delta}$ is a bounded distance from a backward ray in $\tilde{\epsilon}$. This shows that the flow in \tilde{M} is metrically “twisted” and is not pointed in a single direction. This is opposed to the situation when Φ has no perfect fits.

Theorem 5.7. *Let Φ be a pseudo-Anosov flow in M^3 closed. There is $a_1 > 0$ so that if $L \in \tilde{\Lambda}^s$ makes a perfect fit with $U \in \tilde{\Lambda}^u$ then for any forward ray in an orbit in L , it is eventually a bounded distance a_1 from a backwards ray in U . More formally given p in L , q in U , there are t_0, t_1 in \mathbf{R} so that if*

$$A = \tilde{\Phi}_{[t_0, \infty)}(p), \quad B = \tilde{\Phi}_{(-\infty, t_1]}(q), \quad \text{then} \quad d_H(A, B) < a_1,$$

where d_H is Hausdorff distance of closed sets in \tilde{M} .

Proof. This is a very strong result in that not only a forward ray in L is a bounded distance from U , but rather a bounded distance from a single orbit in U . By the previous proposition there are orbits α in L and β in U so that α, β are the corners of a lozenge. Then by theorem 5.2 the Hausdorff distance $d_H(\alpha, \beta) < a_0$ for some fixed constant a_0 depending only on M and Φ . In particular a forward ray of α is $< a_0$ away from either a forward or a backward ray of β .

This is because orbits of $\tilde{\Phi}$ are properly embedded in \tilde{M} and the distance between the two ends goes to infinity. Notice that the distance between points in a forward ray and points in a backward ray of the same orbit goes to infinity. Otherwise there is v in \tilde{M} , and there are $a_2 > 0$, $t_i \rightarrow \infty$, $s_i \rightarrow -\infty$ so that

$$d(\tilde{\Phi}_{t_i}(v), \tilde{\Phi}_{s_i}(v)) < a_2.$$

Up to subsequence assume that the sequences $(\pi(\tilde{\Phi}_{t_i}(v)))$, $(\pi(\tilde{\Phi}_{s_i}(v)))$ converge in M . Hence there are g_i in $\pi_1(M)$ with

$$g_i(\tilde{\Phi}_{t_i}(v)) \rightarrow p_0, \quad g_i(\tilde{\Phi}_{s_i}(v)) \rightarrow p_1.$$

If p_0 and p_1 are in the same orbit of $\tilde{\Phi}$ then since $\mathcal{O} \cong \mathbf{R}^2$ there is a product neighborhood of the orbit segment from p_0 to p_1 and all segment lengths are bounded, contradicting that $t_i \rightarrow \infty$, $s_i \rightarrow -\infty$. Hence p_0, p_1 are not in the same orbit of $\tilde{\Phi}$, contradicting that $\mathcal{O} \cong \mathbf{R}^2$ is Hausdorff.

We now use the proof of the previous proposition and its setup. The corners of the lozenge α in L and β in U were obtained so that α is contained in $\tilde{\Lambda}^u(\tilde{\delta})$, β is in $\tilde{\Lambda}^s(\tilde{\epsilon})$. In addition $\tilde{\delta}, \tilde{\epsilon}$ are periodic and their projections δ, ϵ to M are freely homotopic. Since $\tilde{\delta}, \tilde{\epsilon}$ are the corners of a lozenge then δ is freely homotopic to the inverse of ϵ . In particular a backward ray of $\tilde{\delta}$ is less than a_0 from a forward ray of $\tilde{\epsilon}$. But a backward ray of α is asymptotic to a backward ray of $\tilde{\delta}$ – they are in the same unstable leaf. In the same way a forward ray of β is asymptotic to a forward ray of $\tilde{\epsilon}$. The conclusion is that a backward ray of α is less than say $a_0 + 1$ from a forward ray of β . Notice that this is not yet the conclusion that we want. We want information about forward rays in α .

But we know that a forward ray of α is a bounded distance from either a forward ray of β or a backward ray of β . Suppose that the forward ray of α is a bounded distance from a forward ray of β .

We have just proved that a forward ray of β is a bounded distance from a backward ray of α . Then we would conclude that a forward ray of α is a bounded distance from a backward ray of α . This is what was disallowed in the first part of the proof.

Therefore we conclude that a forward ray of α is less than a_0 from a backward ray of β . This finishes the proof of the theorem. \square

Remark – Theorem 5.7 is one strong interaction of pseudo-Anosov flows and geometry in \widetilde{M} . Clearly if L, U make a perfect fit, then points in L cannot be too close to points in U , because of the local product picture of hyperbolic dynamics. However, a priori, appropriate rays in L, U could be as far away from each other in \widetilde{M} . Theorem 5.7 shows this is not the case. This should be contrasted with flows without perfect fits. For example if Φ is a suspension pseudo-Anosov flow, then no rays in \widetilde{M} are boundedly away from each unless they are either in the same stable leaf or the same unstable leaf.

We now prove theorem C:

Theorem 5.8. *Suppose that no closed orbit of Φ is non trivially freely homotopic to itself. Suppose that L_0, L_1, \dots, L_k is chain of leaves, alternatively in $\widetilde{\Lambda}^s$ and $\widetilde{\Lambda}^u$ satisfying: L_i makes a perfect with both L_{i+1} and L_{i-1} ($0 < i < k$) and for each i either 1) L_i separates L_{i-1} from L_{i+1} or 2) The half leaves of L_i which make a perfect fit with L_{i-1} and L_{i+1} respectively are distinct half leaves of L_i . This structure generates a (non unique) free homotopy class of closed orbits of Φ of cardinality at least k .*

Proof. Conditions 1) and 2) are used to guarantee that the leaves $\{L_i, 0 \leq i \leq k\}$ are distinct from each other – this is just another way of ensuring that condition. First of all we can assume that no leaf L_i is periodic for otherwise the result follows easily as perfect fits are preserved by appropriate powers of covering translations which preserve one of the leaves of the perfect fit.

Let a_0 be the global constant produced by the previous theorem (denoted by a_1 in that theorem).

Without loss of generality assume that L_0 is a stable leaf. For each i let α_i be an arbitrary orbit in L_i . By the previous proposition there is a forward ray of α_0 which is $< a_0$ Gromov-Hausdorff distance from a backward ray of α_1 . Also a backward ray of α_1 is $< a_0$ from a forward ray of α_2 and so on. By taking subrays we may assume that the same ray in α_i works for both conditions. Choose initial points p_0^i in α_i .

Choose sequences (p_n^i) , $0 \leq i \leq k$, $n \in \mathbf{N}$, inductively with i as follows. We may have to take subsequences at will. First choose

$$p_n^0 \in \alpha_0 \text{ and } p_n^0 = \widetilde{\Phi}_{t_n^0}(p_0^0), \text{ with } \lim_{n \rightarrow \infty} t_n^0 = \infty.$$

In addition assume that the sequence (t_n^0) is monotone with n . Up to subsequence assume that $(\pi(p_n^0))$ converges to q_0 in M and all of the elements are in the same sector of q_0 . Recall that L_0 is not periodic.

Now choose p_n^1 in α_1 with $d(p_n^1, p_n^0) < a_0$. Let $p_n^1 = \widetilde{\Phi}_{t_n^1}(p_0^1)$. By theorem 5.7 we know that (t_n^1) converges to minus infinity. We assume that (t_n^1) is monotone. Up to a subsequence assume that $\pi(p_n^1) \rightarrow q_1$ and all $\pi(p_n^1)$ are in the same sector of q_1 .

Continuing by induction on $i \leq k$, we choose for each i a sequence (p_n^i) satisfying:

- $d(p_n^i, p_n^{i-1}) < a_0$ for all n ,
- $p_n^i = \widetilde{\Phi}_{t_n^i}(p_0^i)$,
- $t_n^i \rightarrow -\infty$ if i is odd and $t_n^i \rightarrow \infty$ if i is even. Each sequence (t_n^i) is monotone in n ,
- Up to subsequence (in n) we may assume that for each i , $\pi(p_n^i) \rightarrow q_i$ in M and $\pi(p_n^i)$ are all in the same sector of q_i for each i . Also assume that all $\{\pi(p_n^i)\}$ are sufficiently close to q_i to be able to apply the Closing lemma.

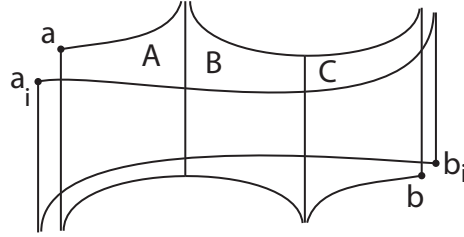

Figure 10: A chain of lozenges of length 3 from a to b . These orbits are near orbits a_i, b_i whose stable/unstable leaves form a perfect fit. In this way a sequence of perfect fits, or a sequence of lozenges with corners a_i, b_i converges to the union of 3 lozenges A, B, C .

Notice that $\pi(p_n^i) = q_i$ for at most one n for each i . Otherwise $\pi(p_n^i)$ is in a periodic orbit of Φ , contrary to assumption that L_i is not periodic.

Now consider minimal geodesic segments $\beta_n^i, 1 \leq i \leq k, n \in \mathbf{N}$ from p_n^{i-1} to p_n^i . These segments are oriented from p_n^{i-1} to p_n^i . They all have length smaller than a_0 in \widetilde{M} . So now fix n, m sufficiently big, with $m \gg n$ and so that for each $1 \leq i \leq k$, then $\pi(\beta_n^i), \pi(\beta_m^i)$ are geodesic segments which are very close to each other in M . Let γ_i be the segment in α_i from p_n^i to p_m^i . It projects to an almost closed orbit segment in M . By the closing lemma the segment is shadowed by a closed orbit τ_i of Φ in M for each $0 \leq i \leq k$. As done in great detail in [Fe3] consider the closed curve

$$\gamma_{i-1} \circ (\beta_m^i)^{-1} \circ (\gamma_i)^{-1} \circ \beta_n^i$$

in \widetilde{M} , where the inverses mean the segments or flow segments are traversed against their orientations. This projects to a closed curve which is null homotopic in M . The images of γ_{i-1} and $(\gamma_i)^{-1}$ are almost closed and shadowed by the closed orbits τ_{i-1} and τ_i . The images $\pi(\beta_n^i), \pi(\beta_m^i)$ are very close geodesic segments which can be closely connected to each other. This produces a free homotopy from τ_{i-1} to τ_i in M . This free homotopy lifts to a free homotopy between coherent lifts $\widetilde{\tau}_{i-1}$ and $\widetilde{\tau}_i$. These are corners of a finite chain of lozenges so that the initial corner $\widetilde{\tau}_{i-1}$ is near α_{i-1} and the final corner $\widetilde{\tau}_i$ is near α_i . The corresponding stable or unstable leaves of α_{i-1} and α_i form a perfect fit. The chain may have more than one lozenge because in the limit leaves can split into a collection of non separated leaves in the chain of lozenges making up the free homotopy, see figure 10. In addition no $\widetilde{\tau}_i$ is equal to $\widetilde{\tau}_j$ if $i \neq j$. Otherwise, since $\widetilde{\tau}_i$ has points very close to α_i , it would follow that α_i, α_j have points very close to each other which is impossible.

Since no closed orbit of Φ is non trivially freely homotopic to itself, the $\{\tau_i\}$ are all distinct closed orbits. Therefore the free homotopy class of τ_0 has cardinality at least k .

This finishes the proof of theorem 5.8. □

In fact in the unbounded case we can prove that there are chains of perfect fits of infinite length:

Theorem 5.9. *Suppose that Φ is an unbounded pseudo-Anosov flow and in addition that Φ is not topologically conjugate to a suspension Anosov flow. Then Φ has chains of perfect fits of infinite length.*

Proof. If there is a non trivial free homotopy from a periodic orbit to itself the result is obvious. Otherwise Theorem 5.8 shows that for each natural n there are chains of free homotopies of length $2n + 1$. These lift to chains of lozenges \mathcal{L}_n of length $2n + 1$. Let the ordered corners of \mathcal{L}_n be denoted by $\{\gamma_i^n, -n \leq i \leq n\}$. Up to covering translations we may assume that the sequence (γ_0^n) converges to an orbit, which will be denoted by β_0 . Let C_n be the lozenge with corners γ_0^n and γ_1^n . Theorem 5.2 shows that the Gromov-Hausdorff distance $d_H(\gamma_0^n, \gamma_1^n)$ is bounded. Therefore up to another subsequence, the sequence (γ_1^n) also converges to an orbit, which will be denoted by β_1 . It follows that $\widetilde{\Lambda}^s(\beta_0)$ and $\widetilde{\Lambda}^u(\beta_1)$ are connected by a chain of perfect fits.

We can use induction in i and then use a diagonal process of subsequences, to show that there is a subsequence of (\mathcal{L}_n) still denoted by (\mathcal{L}_n) so that for each $i \in \mathbf{N}$ the following limit exists

$$\lim_{n \rightarrow \infty} \gamma_i^n := \beta_i$$

in \mathcal{O} . Then $\tilde{\Lambda}^s(\beta_i), \tilde{\Lambda}^u(\beta_{i+1})$ are connected by a chain of perfect fits. This proves theorem 5.9. \square

Remark – One natural question is why Theorem 5.9 is not stated for freely homotopic orbits. That is, why can't one prove there are chains of free homotopies of infinite length? For example one could start with the infinite chain of perfect fits $\{L_i, i \in \mathbf{N}\}$ given by Theorem 5.9 and use the perturbation methods of Theorem 5.8 to try to produce an infinite free homotopy class. This is subtle. Start with an infinite chain of perfect fits. Recall the method of Theorem 5.8: for each i we pick a sequence (in n) of points (p_n^i) in L_i and then take subsequences of these so we apply the Closing lemma to produce closed orbits. The problem is that to apply the Closing lemma, the points in question have to be very close. In particular one may have to go forward or backward a lot in that orbit. So when that gets mapped back to the initial leaf L_1 one cannot guarantee that the starting point is in a bounded region. This is a finite process. One then takes limits. Even if the orbits are periodic, when one takes limits, they may not be periodic in the limit, so we cannot guarantee free homotopies of infinite length.

Theorem 5.10. *Let Φ be an arbitrary pseudo-Anosov flow in M^3 atoroidal. Suppose there is an infinite chain of perfect fits. Then there are chains of lozenges \mathcal{C} of any given finite length satisfying the following: \mathcal{C} has periodic corners, \mathcal{C} does not have any singular corner and \mathcal{C} does not have any adjacent lozenges. In the same way if there is an infinite chain of lozenges with periodic corners, then there is an infinite chain of lozenges with periodic corners, and no singular corners and no adjacent lozenges.*

Proof. An infinite chain of perfect fits is $\{L_i, i \in \mathbf{N}\}$ so that L_i are leaves in $\tilde{\Lambda}^s$ or $\tilde{\Lambda}^u$ (or $\mathcal{O}^s, \mathcal{O}^u$) and L_i makes a perfect fit with L_{i+1} for every i . The indexing set could be \mathbf{Z} also. The previous theorem shows that Φ admits finite chains of periodic lozenges of any finite length. There are finitely many singular orbits of Φ . Up to covering translations there are only finitely many leaves of \mathcal{O}^s or \mathcal{O}^u which are non separated from another leaf in the same foliation [Fe4, Fe5]. In addition any of these leaves is periodic, by Theorem 2.7. Therefore there is n_0 integer so that up to covering translations there are finitely many $\leq n_0$ orbits γ of $\tilde{\Phi}$ so that γ is periodic and either γ singular, or one of $\mathcal{O}^s(\gamma)$ or $\mathcal{O}^u(\gamma)$ is non separated from another leaf in its respective foliation.

We prove the first assertion of the theorem. Suppose that there is $n_1 \in \mathbf{N}$ so that there are no chains of periodic lozenges of length n_1 with no corners which are singular orbits and no adjacent lozenges. Let \mathcal{C} be a chain of periodic lozenges of length bigger than $(n_0 + 1)(n_1 + 1)$. Since the corners of \mathcal{C} are periodic there is g in $\pi_1(M)$ non trivial so that g leaves invariant all corners of \mathcal{C} . Start at one end of \mathcal{C} . By hypothesis after at most n_1 steps the chain hits a corner γ so that either 1) γ is a singular orbit, 2) $\mathcal{O}^s(\gamma)$ is non separated from another leaf in \mathcal{O}^s or 3) $\mathcal{O}^u(\gamma)$ is non separated from another unstable leaf. Since the length of \mathcal{C} is $> (n_0 + 1)(n_1 + 1)$ there are at least $n_0 + 1$ instances of 1), 2) or 3) above. By choice of n_0 it follows that there are corners α, β of \mathcal{C} which project to the same orbit of Φ . So there is f in $\pi_1(M)$ with $f(\alpha) = \beta$. Then $f^{-1}gf(\alpha) = \alpha$. This implies that $f^{-1}gf = g^i$ for some non zero i in \mathbf{Z} . In addition $fgf^{-1}(\beta) = \beta$ so also $fgf^{-1} = g^j$ for some non zero j in \mathbf{Z} . Since $\pi_1(M)$ does not have torsion it follows that $f^{-1}gf = g^{\pm 1}$. It follows that f^2, g generate a \mathbf{Z}^2 subgroup of $\pi_1(M)$. This contradicts that M is atoroidal. This proves the first assertion of the theorem.

Suppose now that \mathcal{C} is an infinite chain of lozenges with periodic corners. If there are infinitely many corners which are either singular or in a leaf which is non separated from another leaf, then the arguments in the proof of the first assertion imply that M is toroidal, contradiction to hypothesis. We conclude that there are only finitely many corners which are either singular or in a leaf non separated from another leaf. We conclude that there is an infinite subchain \mathcal{C}' which has the desired property.

This finishes the proof of the theorem. \square

Remark – As in the case of Theorem 5.9 there is an issue with the upgrading from perfect fits to lozenges with periodic corners. In the second assertion in the theorem, suppose one starts with an infinite chain \mathcal{C} of lozenges, not a priori with periodic corners. Then one can approximate any finite subchain of \mathcal{C} by one with periodic corners. But as explained before, the perturbation methods do not produce an infinite chain of lozenges with periodic corners.

6 Convergence group action

In the next few sections we prove Theorem F and Theorem D, which imply the Main theorem. In this section we prove that if Φ is bounded, then $\pi_1(M)$ acts as a convergence group on a candidate for the flow ideal boundary of \widetilde{M} . The bounded hypothesis will be fundamental for many steps and the result does not work without this hypothesis.

Decomposition of $\partial(\mathcal{D} \times I)$ – equivalence relation \simeq in $\partial(\mathcal{D} \times I)$

Let Φ be a pseudo-Anosov flow. In

$$\partial(\mathcal{D} \times I) = \mathcal{O} \times \{1\} \cup \mathcal{O} \times \{0\} \cup \partial\mathcal{O} \times [-1, 1]$$

we consider the following decomposition which is generated by:

- 1) For any $(p, 1) \in \mathcal{O} \times \{1\}$ consider the element $I_p^s = (\mathcal{O}^s(p) \cup \partial\mathcal{O}^s(p)) \times \{1\}$
- 2) For any $(p, -1) \in \mathcal{O} \times \{1\}$ consider the element $I_p^u = (\mathcal{O}^u(p) \cup \partial\mathcal{O}^u(p)) \times \{-1\}$
- 3) For any $(p, t) \in \partial\mathcal{O} \times I$ consider the element $I_p^\partial = \{p\} \times I$.

We let \simeq be the equivalence relation in $\partial(\mathcal{D} \times I)$ generated by these decomposition elements.

Here p is an arbitrary point in $\mathcal{D} = \mathcal{O} \cup \partial\mathcal{O}$. Notice that if $p \in \partial\mathcal{O}^s(x)$ then I_p^∂ and I_x^s intersect in $(p, 1)$ and similarly if $p \in \mathcal{O}^u(x)$, then I_p^∂ and I_x^u intersect in $(p, -1)$.

Definition 6.1. (*equivalence relation \sim in $\partial\mathcal{O}$*) The equivalence relation \simeq in $\partial(\mathcal{D} \times I)$ induces an equivalence relation in $\partial\mathcal{O}$, denoted by \sim . Explicitly: if x, y are in $\partial\mathcal{O}$, then $x \sim y$ if and only if there are leaves l, u each of which can be either stable or unstable and so that: a) $x \in \partial l$, $y \in \partial u$, and b) l, u are connected by a chain of perfect fits. This includes the case that x, y are ideal points of the same leaf.

In particular $x \sim y$ if and only if $(x, 1) \simeq (y, 1)$.

Notation – If Z is a subset of $\partial\mathcal{O}$, all of whose elements are related under \sim , then we let

$$\mathcal{E}(Z) = \text{the union of the equivalence classes of } \sim \text{ intersecting } Z.$$

Examples of this are $\mathcal{E}(\partial\mathcal{O}^s(p)), \mathcal{E}(\partial\mathcal{O}^u(p))$ where p is in \mathcal{O} and for example $\partial\mathcal{O}^s(p)$ is the set of ideal points of prongs of $\mathcal{O}^s(p)$. If z is a point in $\partial\mathcal{O}$, we also denote by $\mathcal{E}(z)$ the equivalence class $\mathcal{E}(\{z\})$.

Definition 6.2. (*flow ideal boundary*) Let \mathcal{R} be the quotient space of $\partial(\mathcal{D} \times I)$ by the equivalence relation \simeq . Every point in $\mathcal{O} \times \{-1, 1\} \cup \partial\mathcal{O} \times I$ is related to a point in $\partial\mathcal{O} \times \{1\}$. So we may think of \mathcal{R} as a quotient space of $\partial\mathcal{O}$ by the equivalence relation \sim . Here we are naturally identifying $\partial\mathcal{O}$ with $\partial\mathcal{O} \times \{1\}$. The topology in \mathcal{R} is the same as the quotient topology from $\partial\mathcal{O}$.

In other words the equivalence relation induced by \simeq in $\partial\mathcal{O}$ is exactly the relation \sim . Since we obtain \mathcal{R} as a quotient of either $\partial(\mathcal{D} \times I)$ or $\partial\mathcal{O}$, the last statement means that the quotient topology is the same for both quotients.

The boundary $\partial(\mathcal{D} \times I)$ of $\mathcal{D} \times I$ is homeomorphic to the two sphere \mathbf{S}^2 .

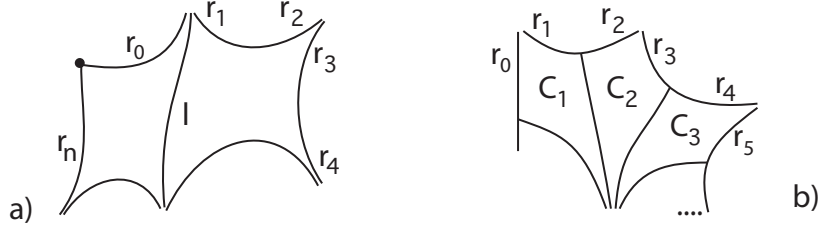

Figure 11: a. Closing up of leaves making perfect fits, b. Long chains of leaves making perfect fits.

(Counter) Example – Consider the case of a skewed \mathbf{R} -covered Anosov flow in an atoroidal manifold [Fe2]. Then the corresponding orbit space has boundary $\partial\mathcal{O}$ made up of 2 special points and 2 lines l_1, l_2 . Any point in l_2 is identified to a point in l_1 . In addition there is a translation in l_1 induced by a composition of perfect fit maps [Fe2]. This is the slithering map as defined by Thurston in this situation [Th5]. In this case the quotient \mathcal{R} of $\partial\mathcal{O}$ as in the definition above is as follows: $\mathcal{R} = \mathbf{S}^1 \cup \{a_1, a_2\}$. The circle \mathbf{S}^1 is the quotient of l_1 (or l_2) by the slithering map. Any point in \mathbf{S}^1 is not separated from both a_1 and a_2 and so a_1, a_2 are not separated from each other. The quotient space \mathcal{R} in this case satisfies only the T_0 topological separation property. This pseudo-Anosov flow (in fact Anosov) is not bounded. The action of $\pi_1(M)$ on \mathcal{R} in this case is definitely not a convergence group.

One important property we need is that there are no identifications between points of $\partial\mathcal{O}^s(x)$ and $\partial\mathcal{O}^u(x)$ under \sim .

Proposition 6.3. *If x is a point in \mathcal{O} then no point of $\partial\mathcal{O}^s(x)$ is equivalent to any point of $\partial\mathcal{O}^u(x)$ under \sim . In addition if r is a ray of $\mathcal{O}^s(x)$ there is no chain of perfect fits from r to another ray of $\mathcal{O}^s(x)$ except for $\mathcal{O}^s(x)$ itself.*

Proof. Observe that we consider $\mathcal{O}^s(x)$ a trivial chain of perfect fits between ideal points of $\mathcal{O}^s(x)$. In addition we are only considering minimal chains – no backtracking allowed.

Suppose there is a chain of perfect fits from a ray r of $\mathcal{O}^s(x)$ to a ray r' of $\mathcal{O}^u(x)$. This is a chain of rays $r = r_0, r_1, \dots, r_m = r'$ in leaves of \mathcal{O}^s or \mathcal{O}^u so that either

- r_i, r_{i+1} are rays in the same leaf of \mathcal{O}^s or \mathcal{O}^u – in which case we assume that $r_i \cup r_{i+1}$ forms a slice of this leaf, or
- r_i, r_{i+1} have the same ideal point in $\partial\mathcal{O}$. In this case there are $r_i = \tau_0, \tau_1, \dots, \tau_k = r_{i+1}$ so that τ_j are rays alternatively in leaves of \mathcal{O}^s and \mathcal{O}^u , and τ_j makes a perfect fit with τ_{j+1} . By truncating some slices and rays if necessary, we may assume that each point y of $\partial\mathcal{O}$ occurs as an ideal point of at most two consecutive rays. Maybe y is also the ideal point of some other ray in the chain, but not consecutive with the first two.

There are several possibilities each of which leads to some contradiction. The conditions imply that by eliminating rays with the same ideal points in $\partial\mathcal{O}$ if necessary, then the chain may be reformatted to have the following format: $r_0, r_1 \cup r_2, r_3 \cup r_4, \dots, r_n$ where r_{2i} and r_{2i+1} have the same ideal point in $\partial\mathcal{O}$, and $r_{2i-1} \cup r_{2i}$ forms a slice in a leaf of \mathcal{O}^s or \mathcal{O}^u . In particular no 3 consecutive rays have the same ideal point in \mathcal{O} .

Suppose that we have a chain as above with minimum number of rays amongst all such chains and all points x in \mathcal{O} . With the notation above the number of rays is $n + 1$. In particular there are no transverse self intersections between all the rays and slice leaves, except for the first and the last rays. Otherwise we could cut the parts before and after the intersection z to produce a chain with a smaller number of rays. We can also assume that r_0 and r_n start at x . It now follows that

$$c = r_0 \cup r_1 \cup \dots \cup r_n$$

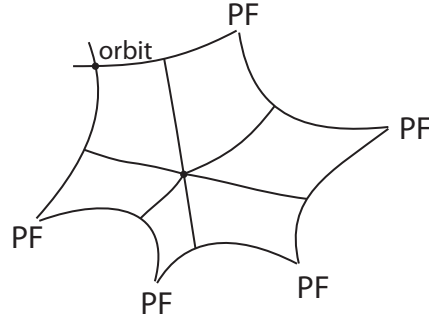

Figure 12: *a.* A sequence of perfect fits closing up around a singular periodic orbit and with one actual intersection.

bounds an open region R in \mathcal{O} . This is because there are no self intersections in \mathcal{O} and any ideal point of \mathcal{O} is only traversed once. We cannot skip any leaves in between.

There are two possibilities: either for all i the rays r_{2i} and r_{2i+1} make a perfect fit or for some i this is not true.

We first analyse the second possibility and suppose without loss of generality that $i = 0$. Then there is a τ_1 making a perfect fit with r_0 and τ_1 contained in a leaf l of say \mathcal{O}^u with l separating r_0 from $r_1 \cup r_2$.

There are several possibilities each of which leads to some contradiction. It could be that the leaf l contains another ray in the chain $\{r_j\}$. Then we can produce a chain from a ray of l to another ray of l with less rays than the original chain, contradicting the minimality of the chain $\{r_j, 0 \leq j \leq n\}$. Another option is that l intersects a leaf in ∂R transversely. It cannot be that consecutive rays are contained in leaves that intersect transversely. This is because if that were the case then either the rays make a perfect fit and a nearby pair of leaves one in \mathcal{O}^s and one in \mathcal{O}^u intersect twice, or the rays are separated by more than one perfect fit which also leads to a contradiction. By similar arguments no two leaves in the union of $\mathcal{O}^s \cup \mathcal{O}^u$ can share more than one ideal point in $\partial \mathcal{O}$. Hence if l intersects a leaf in ∂R transversely, then again cut out a chain of smaller length, contradiction. Finally it could be that two rays of l limit in ideal points of some of the $\{r_j\}$, see fig. 11, a. Then again we can cut the region R along l to decrease the number of leaves/rays in the chain $\{r_j, 0 \leq j \leq n\}$. We conclude that this situation cannot happen.

We conclude that the only remaining possibility is that for all i , r_{2i} and r_{2i+1} make a perfect fit and $r_{2i+1} \cup r_{2i+2}$ does not separate consecutive perfect fits. Suppose that $n \geq 3$. Then $r_1 \cup r_2$ is a slice which makes a double perfect fit with r_0 and r_3 . By proposition 4.6, $r_1 \cup r_2$ is periodic and in fact, all rays $r_j, 0 \leq j \leq n$ are periodic and left invariant by the same non trivial element g of $\pi_1(M)$. Then r_1, r_2 are in the boundary of adjacent lozenges C_1, C_2 . Therefore r_3 cannot intersect r_0 , see fig. 11, b. If $n \geq 4$ then $r_3 \cup r_4$ is in the boundary of adjacent lozenges $C_2 \cup C_3$ see fig. 11 b. Then it is impossible for the chain r_0, \dots, r_n to close up.

Notice that with the reformatting above n has to be odd. Hence the only remaining possibility is that $n = 1$. If $n = 1$ this means that a ray of $\mathcal{O}^s(x)$ makes a perfect fit with a ray of $\mathcal{O}^u(x)$. This is impossible, because nearby leaves of $\mathcal{O}^s, \mathcal{O}^u$ would intersect twice, a contradiction.

Exactly the same type of arguments show the second statement of the proposition.

This finishes the proof of proposition 6.3. □

Remark – This shows that one cannot close up a chain of perfect fits by going around a singular orbit as in figure 12. In this figure each PF is a perfect fit. If this were possible, then $\partial \mathcal{O}^u(p)$ would be identified with $\partial \mathcal{O}^s(p)$ under \sim . This is disallowed by proposition 6.3.

Before we prove the convergence group theorem we will establish several preliminary results which will simplify the proof of the theorem. We first prove that the flow ideal boundary \mathcal{R} is homeomorphic to the two dimensional sphere. We also analyse the action on $\partial \mathcal{O}$ of an element g of $\pi_1(M)$ with a fixed point in \mathcal{O} . We will also establish a rigidity property of the foliations $\tilde{\Lambda}^s, \tilde{\Lambda}^u$. These results will establish

some easy cases of the convergence theorem. There are additional useful results.

We recall Moore's theorem on cellular decompositions. A decomposition Q of a space X is a collection of disjoint nonempty closed sets whose union is X . In other words this is the same as the equivalence classes of an equivalence relation so that the equivalence classes are closed subsets of X . Consider the quotient space X/Q and the quotient map $\nu : X \rightarrow X/Q$. The decomposition Q satisfies the *upper semicontinuity property* provided that, given q in Q and V open in X containing q , then the union of those q' of Q that are contained in V is an open subset of X . This is equivalent to the map ν being a closed map.

A decomposition Q of a closed 2-manifold B is *cellular* if the following properties hold: 1) Q is upper semicontinuous, 2) Each q in Q is a compact subset of B , 3) Each q of Q has a non separating embedding in the plane \mathbf{R}^2 . The following result was proved by R. L. Moore for the case of a sphere:

Theorem 6.4. *(Moore's theorem)(approximating cellular maps)[Mu] Let Q denote a cellular decomposition of a 2-manifold X homeomorphic to a sphere. Then the quotient map $\nu : X \rightarrow X/Q$ can be approximated by homeomorphisms. In particular X and X/Q are homeomorphic.*

Theorem 6.5. *If Φ is a bounded pseudo-Anosov flows then the map $\partial\mathcal{O} \rightarrow \mathcal{R}$ is finite to one (bounded) and \mathcal{R} is homeomorphic to the 2-dimensional sphere.*

Proof. For most of the proof we will consider \mathcal{R} as the quotient of $\partial(\mathcal{D} \times I)$ by \simeq .

Let e be an element of \mathcal{R} . We consider an equivalence class of \simeq as both an element of \mathcal{R} and as a subset of $\mathbf{S}^2 = \partial(\mathcal{D} \times I)$. We first show that e is a closed subset of $\mathbf{S}^2 = \partial(\mathcal{D} \times I)$. Let $pr : \mathcal{D} \times I \rightarrow \mathcal{D}$ be the projection to the first factor. Given a subset B of $\mathcal{D} \times I$, the projection of B to \mathcal{O} is the set $\mathcal{O} \cap pr(B)$. Similarly for the projection of B to $\partial\mathcal{O}$. The first step is to show the following:

Lemma 6.6. *Let e be an arbitrary element e of \mathcal{R} thought of as a subset of $\partial(\mathcal{D} \times I)$. Suppose that the projection of e to \mathcal{O} is non empty and contains a leaf l of \mathcal{O}^s or \mathcal{O}^u . Then this projection to \mathcal{O} is exactly the set of leaves of $\mathcal{O}^s \cup \mathcal{O}^u$ which can be connected to l by a chain of perfect fits. In addition the projection of e to $\partial\mathcal{O}$ is the union of the ideal points of these leaves.*

Proof. Suppose that l is (say) a stable leaf. Suppose that $z \in e$. Then z can be connected to $l \times \{1\}$ by finitely many steps either vertical in $\partial\mathcal{O} \times I$ – type 3) in the decomposition of $\partial(\mathcal{D} \times I)$ – or horizontal in $\mathcal{O} \times \{1, -1\}$ – type 1) and 2) in the decomposition of $\partial(\mathcal{D} \times I)$. The paths may jump from $\mathcal{O} \times \{1\}$ to $\mathcal{O} \times \{-1\}$ along a vertical fiber which is associated to $p \in \partial\mathcal{O}$ which is the ideal point of both stable and unstable leaves s, u respectively. This can only occur if s, u have ideal point p and hence are connected by a chain of perfect fits. This yields the result. \square

The lemma shows that since Φ is bounded, then an equivalence class e of \simeq is a finite union of compact sets in $\mathcal{D} \times \{1\}, \mathcal{D} \times \{-1\}$ and finitely many vertical stalks in $\partial\mathcal{O} \times I$. Therefore e is a compact subset of $\partial(\mathcal{D} \times I)$. In addition there are no loops in e because in Proposition 6.3 we proved that the only chain of perfect fits between rays in a leaf of \mathcal{O}^s or \mathcal{O}^u is the leaf itself. Hence the the equivalence classes of \simeq are simply connected subsets of $\partial(\mathcal{D} \times I)$. In addition the lemma shows the first statement of theorem 6.5.

To be able to use Moore's theorem, what is left to prove is to show the upper semicontinuous property of the equivalence classes of \simeq . Suppose that e is an equivalence class of \simeq and B is an open subset of $\mathbf{S}^2 = \partial(\mathcal{D} \times I)$ containing e . Let B' be the union of the equivalence classes e' of \simeq entirely contained in B . We need to show that B' is open. Given x in $\partial(\mathcal{D} \times I)$ we denote by $e(x)$ the equivalence class of \simeq containing x . It suffices to show the following: if $x_i \in \partial(\mathcal{D} \times I)$ converges to x in e then $e(x_i)$ is eventually contained in B . Let n_0 be the upper bound on the cardinality of chains of perfect fits – that is – the number of leaves which are connected to any given leaf by a chain of perfect fits.

Case 1 – Suppose x is in $\mathcal{O} \times \{1\}$.

Let $x = p \times \{1\}, x_i = p_i \times \{1\}$. If the $\{p_i\}$ are all in $\mathcal{O}^s(p)$ the fact $e(x_i) \subset B$ is obvious. Assume without loss of generality that the x_i are all in a fixed complementary component of $\mathcal{O}^s(p)$. Let $\{d_j, 1 \leq j \leq n_1\}$

be the set of leaves of \mathcal{O}^s non separated from $\mathcal{O}^s(p)$ in the component of $\mathcal{O} - \mathcal{O}^s(p)$ containing p_i . We call this the *side* containing p_i . The escape lemma (Lemma 4.7) shows that any point of $\mathcal{D} = \mathcal{O} \cup \partial\mathcal{O}$ which is in a limit of a sequence in $\mathcal{O}^s(p_i) \cup \partial\mathcal{O}^s(p_i)$ is in $\cup_j d_j \cup \partial d_j$. Since

$$((\cup_j d_j \cup \partial d_j) \times \{1\}) \subset e$$

it follows that for i big enough, then $(\mathcal{O}^s(p_i) \cup \partial\mathcal{O}^s(p_i)) \times \{1\} \subset B$. Let q_i be the ideal points of $\mathcal{O}^s(p_i)$ so that the sequence (q_i) converges to q ideal point of say d_1 . Since $d_1 \times \{1\} \subset e$, then $q \times I \subset e$ and also a neighborhood of it in $\partial(\mathcal{D} \times I)$ is contained in B . Suppose for instance that q_i is also an ideal point of leaves different from $\mathcal{O}^s(p_i)$. Without loss of generality assume that $q_i \in \partial u_i$, $u_i \in \mathcal{O}^u$. If the sequence (u_i) escapes compact sets in \mathcal{O} , then the escape lemma shows that $u_i \rightarrow q$ in $\mathcal{O} \cup \partial\mathcal{O}$. Hence for i big $u_i \times \{-1\} \subset B$.

If on the other hand the sequence (u_i) does not escape compact sets in \mathcal{O} , assume up to subsequence that (u_i) converges to $\{c_j, 1 \leq j \leq n_2\}$ – a finite collection of unstable leaves. As ∂u_i contains q_i and (q_i) converges to q , it follows again from the escape lemma that one c_j , say c_1 has ideal point q . Then $(c_j \cup \partial c_j) \times \{-1\}$ is contained in e . The escape lemma applied to these sequences shows that $u_i \times \{-1\} \subset B$ for i big.

We can iterate this process: suppose that u_i has ideal point t_i and t_i is also an ideal point of δ_i leaf of \mathcal{O}^s . We apply the same argument as above now switching unstable and stable leaves. The important point is that since Φ is bounded, then any such chain of perfect fits is bounded in length, therefore eventually all $e(x_i) \subset B$.

If x is in $\partial\mathcal{O} \times \{-1\}$ this is treated similarly. Finally:

Case 2 – Suppose that x is in $\partial\mathcal{O} \times I$.

Suppose first that $x_i \in \partial\mathcal{O} \times I$. Here $x \in \{p\} \times I$, $p \in \partial\mathcal{O}$. If $e(x_i) = p_i \times I$, then $e(x_i) \subset B$ for i big as B is open. Otherwise p_i is an ideal point of l_i , say without loss of generality that l_i are in \mathcal{O}^s . If the sequence (l_i) escapes compact sets in \mathcal{O} , then (l_i) converges to p in \mathcal{D} – otherwise we obtain a non trivial segment in $\partial\mathcal{O}$ without ideal points of leaves of \mathcal{O}^s or \mathcal{O}^u . It follows that

$$(l_i \cup \partial l_i) \times \{1\} \subset B \quad \text{for } i \text{ big.}$$

If the sequence (l_i) does not escape compact sets in \mathcal{O} then there are $z_i \in l_i \times \{1\}$ with (z_i) converging to z in \mathcal{O} . The escape lemma then implies that p is an ideal point of $s \in \mathcal{O}^s$ with s non separated from $\mathcal{O}^s(z)$. This reduces the proof the arguments in Case 1.

Finally assume that (say) $x_i \in \mathcal{O} \times \{1\}$. If $(\mathcal{O}^s(x_i))$ does not escape compact sets in \mathcal{O} , use the argument in the previous paragraph. Otherwise $(\mathcal{O}^s(x_i))$ converges to p in \mathcal{D} and we are done. In the same way one deals with $x_i \in \mathcal{O} \times \{-1\}$.

This finishes the proof of theorem 6.5. This is because Moore's theorem implies that \mathcal{R} is homeomorphic to the two sphere \mathbf{S}^2 . \square

Remark – We stress that the main tool used in the above proof was the escape lemma bounded version (Lemma 4.7). As the reader can attest, it simplifies the proof tremendously.

Definition 6.7. (*attracting set for an action*) Suppose that (g_n) is a sequence acting on a compact metric space X . We say that Y is the attracting set for the sequence (g_n) if Y is closed and the following happens: let z be a point in X which is not fixed for any g_n with sufficiently high n . Then the distance from $g_n(z)$ to Y converges to zero. In addition Y is minimal with respect to this property. In the same way define the repelling fixed set of (g_n) . Finally if g is a single transformation of X , we let the attracting fixed set of g to be that of the sequence (g_n) where $g_n = g^n$.

It is crucial here that Y need not be a single point. In general it may not even be finite.

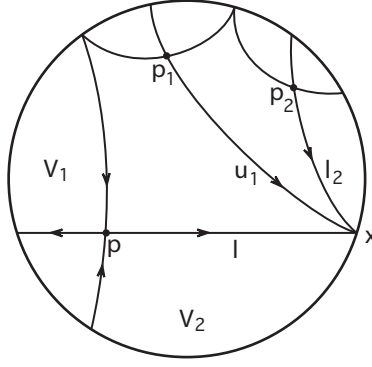

Figure 13: The action of periodic transformations on the orbit space and its boundary.

Lemma 6.8. (action of periodic transformations on \mathcal{O}) Let $\tilde{\Phi}$ be a bounded pseudo-Anosov flow. Let g in $\pi_1(M)$ so that g has a fixed point p in \mathcal{O} . Then g has finitely many fixed points in $\partial\mathcal{O}$ (possibly zero). There is an even number of fixed points of g acting on $\partial\mathcal{O}$ and the fixed points alternate between attracting and repelling fixed points.

Proof. Let γ be an orbit of $\tilde{\Phi}$ with $\Theta(\gamma) = p$. Without loss of generality assume that g acts on γ in the flow forward direction. This means that if $z \in \gamma$ then $g(z) = \tilde{\Phi}_{t(z)}(z)$ with $t(z) > 0$. Let $A = \mathcal{E}(\partial\mathcal{O}^s(p))$, $B = \mathcal{E}(\partial\mathcal{O}^u(p))$. Then A, B are finite sets. We will show:

- I) points in A, B alternate in $\partial\mathcal{O}$,
- II) both A, B are invariant under the action of g on $\partial\mathcal{O}$, and
- III) the set A is the attracting set for g acting on $\partial\mathcal{O}$, and B is the repelling set for g acting on $\partial\mathcal{O}$.

The set \mathcal{O} is one dimensional like the real numbers. Instead of speaking of convergence from the left or right as in \mathbf{R} , we prove convergence on each side of the point in question. The side can be determined by the closure of sets in \mathcal{O} .

Suppose first that g leaves invariant all prongs at p . Let l be a prong of $\mathcal{O}^s(p)$ at p with ideal point x . The goal is to show that x is an attracting fixed point of g acting on $\partial\mathcal{O}$. We will show that locally g contracts any interval small interval I in $\partial\mathcal{O}$ with one endpoint x . In order to analyse that fix a line leaf l' of l with one ideal point x . Then the components V_1, V_2 of $\mathcal{O} - l'$ define the two complementary intervals in $\partial\mathcal{O}$ each of which has x as an endpoint. Since g is associated with the forward direction of the flow then g acts as a contraction on $\mathcal{O}^u(p)$ with p as a fixed point, and as an expansion on $\mathcal{O}^s(p)$. We can depict this in $\mathcal{O} \cup \partial\mathcal{O}$ as follows: if z is a fixed point of g in \mathcal{O} we put an arrow away from z in each prong of $\mathcal{O}^s(z)$ if g acts as an expansion on $\mathcal{O}^s(z)$, otherwise we put an arrow towards z . Similarly we put arrows in the prongs of $\mathcal{O}^u(z)$. Hence in each prong of $\mathcal{O}^s(p)$ put an arrow which moves away from p and put an arrow in each prong of $\mathcal{O}^u(p)$ which points towards p . We refer to fig. 13.

Suppose now that this prong l makes a perfect fit with a leaf u_1 of \mathcal{O}^u . Because g leaves invariant all prongs at p , then g leaves invariant u_1 (in the general case g^n leaves u_1 invariant for some $n > 0$). Hence u_1 has a fixed point p_1 under g . Since g acts as a contraction on $\mathcal{O}^u(p)$, it follows that g acts as an expansion on u_1 . This is the key point and we explain this. Here p and p_1 are the corners of a lozenge C in \mathcal{O} . The transformation g acts as an expansion in $\mathcal{O}^s(p)$, hence as a contraction in $\mathcal{O}^u(p)$. It follows that it acts as an expansion in $\mathcal{O}^u(p_1)$. This is because both $\mathcal{O}^u(p), \mathcal{O}^u(p_1)$ have a prong in the boundary of the lozenge C . The structure of the lozenge means that contraction in the prong of $\mathcal{O}^u(p)$ is equivalent to expansion in the prong of $\mathcal{O}^u(p_1)$. Therefore the prong u'_1 of u_1 with ideal point x has an arrow pointing towards x . In other words, just as in the prong of $\mathcal{O}^s(p)$, the arrow in $\mathcal{O}^u(p_1)$ points towards x . Assume that u_1 is contained in V_1 . Suppose now that u_1 makes a perfect fit with a stable leaf l_2 with ideal point x and l_2 contained in V_1 . In particular l and l_2 are not separated from each other. Then l_2 has a fixed point p_2 under g . Using the same arguments as in the case from l to u_1 , it now follows that g acts as an expansion on $l_2 = \mathcal{O}^s(p_2)$.

By the bounded condition on the flow Φ , there is a last leaf in this process. Call this last leaf v_0 . Then g leaves v_0 invariant. Without loss of generality assume that v_0 is an unstable leaf. The arguments in the previous paragraph show that g acts as an expansion on v_0 . Let p' be the fixed point in v_0 . Let v_1 be the stable prong of $\mathcal{O}^s(p')$ which together with the prong of $\mathcal{O}^u(p')$ with ideal point x bounds a sector Q which is contained in V_1 and Q not contained in the same component of $\mathcal{O} - v_0$ which contains l . Then g acts as a contraction on v_1 . Let now u be an unstable leaf intersecting v_1 . Then $(g^n(u))$ converges to v_0 as $n \rightarrow +\infty$. If there are other leaves in the limit of the sequence $(g^n(u))$ in the sector Q then by theorem 2.7 there is a stable leaf e' making a perfect fit with v_0 and in this sector Q . This contradicts the construction of v_0 as the last leaf with a prong with ideal prong x in V_1 . This shows that x is an attracting fixed point for g in the side contained in ∂V_1 . The same proof applied to the other side of x in $\partial \mathcal{O}$ shows that x is an attracting fixed point for g .

Let y be the ideal point of the prong v_1 . Then v_1 is invariant under g and y is fixed by g . The same proof as above applied to v_1 and y shows that y is a repelling fixed point of g acting on $\partial \mathcal{O}$.

We need to show that g has no other fixed points in the interval (x, y) of $\partial \mathcal{O}$ in the ideal boundary of Q . Let then s_1 be a regular stable leaf intersecting the prong of $\mathcal{O}^u(p') = v_0$ which has ideal point x . Let s be the prong of $s_1 - v_0$ contained in the sector Q . Let z be the ideal point of s . Consider the limit of $(g^n(s))$ as $n \rightarrow +\infty$. The intersection with v_0 escapes in v_0 as $n \rightarrow +\infty$. If the sequence does not escape compact sets in \mathcal{O} , then it has at least one limit leaf b which makes a perfect fit with v_0 and b contained in Q . This contradicts the choice of v_0 as the last leaf in V_1 with ideal point x . Hence $(g^n(s))$ escapes compact sets as $n \rightarrow +\infty$ and therefore the limit of $(g^n(z))$ as $n \rightarrow +\infty$ is x .

Now consider $(g^n(s))$ as $n \rightarrow -\infty$. Clearly this limits on v_1 . If this sequence has other limits, then they are non separated from v_1 and contained in Q . In particular they are connected to v_1 by a finite chain of adjacent lozenges which are invariant under g and all contained in Q . It follows that the first lozenge has a corner in p' . But this implies that this lozenge has another side (contained in Q as well) which makes a perfect fit with v_0 . This again contradicts the choice of v_0 . We conclude that there are no fixed points of g in (x, y) .

We can restart the proof from y and go around the circle to obtain that g has a finite, even number of fixed points in $\partial \mathcal{O}$, which are alternatively attracting and repelling. By the arguments A is the attracting set and B is the repelling set for the action of g on $\partial \mathcal{O}$. This finishes the proof of Lemma 6.8 in the case that g leaves all prongs of $\mathcal{O}^s(p), \mathcal{O}^u(p)$ invariant.

Finally if g does not leave each prong of $\mathcal{O}^s(p)$ invariant, it still leaves the collection of such prongs invariant. Therefore it leaves invariant the collection of leaves making perfect fits with $\mathcal{O}^s(p)$ and likewise the collection of other leaves making perfect fits with these and so on. Hence $g(A) = A$ and $g(B) = B$. On the other hand, for some fixed $i_0 > 0$, g^{i_0} leaves invariant each prong of $\mathcal{O}^s(p), \mathcal{O}^u(p)$ so the proof above can be applied to powers to g^{i_0} . This implies that A is the attracting set of g^{i_0} and B is the repelling set for g^{i_0} . Since g itself leaves A and B invariant then A is the attracting set of g and B is the repelling set for g . Notice that it may well be that g itself does not have fixed points in $\partial \mathcal{O}$.

This finishes the proof of lemma 6.8. □

This has a quick consequence:

Corollary 6.9. *Let g be a non trivial covering translation. Then the action of g on \mathcal{R} has a source and sink and they are different from each other.*

Proof. Suppose first that g has a fixed point p in \mathcal{O} . Without loss of generality assume that g is associated with the forward direction in the flow line γ projecting to p . The previous Lemma shows that the equivalence class of $\partial \mathcal{O}^s(p)$ is the attracting set for the action of g on $\partial \mathcal{O}$ and the equivalence class of $\mathcal{O}^u(p)$ is the repelling set. Each class projects to a point in \mathcal{R} and this proves the source sink property for the action of g on \mathcal{R} . In addition Proposition 6.3 shows that the source and sink are different from each other.

Suppose otherwise that g does not fix any point in \mathcal{O} . Let \mathcal{H}^s be the leaf space of $\tilde{\Lambda}^s$ or equivalently \mathcal{O}^s . Similarly define \mathcal{H}^u . Then as shown in [Fe4] the action of g on \mathcal{H}^s has an axis A_s . Let l be a leaf in A_s . If this axis is not properly embedded in \mathcal{H}^s , say in the forward g direction then $(g^n(l))$ converges to a finite collection of leaves $\{S_i, 1 \leq i \leq j\}$. Since g does not fix any leaf, then j is even, that is, $j = 2k$, and $g(S_k) = S_{k+1}$. The stable leaves S_k, S_{k+1} are in the boundary of two adjacent lozenges which share an unstable side U . Then $g(U) = U$ which proves that g does not act freely on \mathcal{O} , contradiction to assumption. We conclude that A_s is properly embedded. If the sequence is not a master sequence for some point in $\partial\mathcal{O}$, then all $g_n(l)$ have a common ideal point. This is not possible under the bounded condition. It follows that the sequence $(g^n(l))$ is a master sequence for a point a in $\partial\mathcal{O}$ and $(g^{-n}(l))$ (still with $n \rightarrow +\infty$) is a master sequence for a point b in $\partial\mathcal{O}$. Clearly b, a are the source and sink for the action of g on $\partial\mathcal{O}$. Their projections to \mathcal{R} are the source/sink for the action of g on \mathcal{R} .

The arguments above with the sequence $(g^n(l))$ show that a is not an ideal point of a stable leaf. In the same way, applying the same arguments to the action of g on \mathcal{H}^u shows that the point a is not an ideal point of an unstable leaf. It follows that $\mathcal{E}(a) = \{a\}$, $\mathcal{E}(b) = \{b\}$. If $a = b$ then a is the source and sink of the transformation g acting on $\partial\mathcal{O}$. But then all the leaves $g_n(l)$ have to have an ideal point in a . This contradicts the fact that a is not an ideal point of a stable leaf. It follows that the source and sink of the action of g on \mathcal{R} are different from each other.

This finishes the proof of corollary 6.9. □

Recall that two rays s_0, s_1 in leaves of \mathcal{O}^s or \mathcal{O}^u define the same ideal point in $\partial\mathcal{O}$ if and only if there is a chain of rays $s_0 = \tau_0, \dots, \tau_1 = s_1$ in \mathcal{O}^s and \mathcal{O}^u alternatively so that τ_i and τ_{i+1} form a perfect fit.

Corollary 6.10. *Let a, b be points in $\partial\mathcal{O}$. Then there is a most one finite chain $\{r_j, 1 \leq j \leq k\}$ of slice leaves of \mathcal{O}^s and \mathcal{O}^u so that: a is an ideal point of r_1 , b is an ideal point of r_k ; for every $1 \leq j \leq k - 1$ r_j, r_{j+1} share an ideal point, and no two consecutive slices share a subray.*

Proof. Otherwise take a minimal subchain and obtain a non trivial path from $\mathcal{O}^s(x)$ (or $\mathcal{O}^u(x)$) to itself (for some x). This contradicts the second assertion of Proposition 6.3. □

Definition 6.11. *The chain described in corollary 6.10 is called the minimal path from a to b .*

Corollary 6.12. *Suppose that a sequence (g_n) in $\pi_1(M)$ satisfies the following: there are h, f in $\pi_1(M)$ and i_n in \mathbf{Z} so that for all n in \mathbf{N} , either $g_n = hf^{i_n}$ or $g_n = f^{i_n}h$. Suppose that either $i_n \rightarrow \infty$ or $i_n \rightarrow -\infty$. Then the sequence (g_n) has a source and sink for its action on \mathcal{R} and they are different from each other.*

Proof. The point is that the transformation f is fixed for these sequences. For simplicity assume that $i_n \rightarrow \infty$. Let a_1, b_1 be the source/sink pair of f acting on \mathcal{R} , which exist by corollary 6.9. If $g_n = hf^{i_n}$ then it is immediate to see that the source of the sequence (g_n) is a_1 and the sink is $h(b_1)$. If $g_n = f^{i_n}h$, then the source of (g_n) is $h^{-1}(a_1)$ and the sink is b_1 . If $i_n \rightarrow -\infty$ then the roles of a_1 and b_1 get reversed. □

We can now improve some properties of the escape lemma 4.7:

Lemma 6.13. *Let Φ be a bounded pseudo-Anosov flow. Suppose that (l_n) is a sequence of leaves in \mathcal{O}^s (or in \mathcal{O}^u). Suppose that for each n there are distinct ideal points a_n, b_n of l_n so that both $\lim_{n \rightarrow \infty} a_n, \lim_{n \rightarrow \infty} b_n$ exist and are equal to a_∞, b_∞ respectively. Then*

- *If $a_\infty = b_\infty = z$ then (l_n) converges to a_∞ in $\mathcal{O} \cup \partial\mathcal{O}$, unless (l_n) has a subsequence (l_{n_k}) satisfying the following: each l_{n_k} is a singular leaf, (l_{n_k}) does not escape compact sets in \mathcal{O} , and $(a_{n_k}), (b_{n_k})$ converge to z from the same side.*
- *If $a_\infty \neq b_\infty$ then the sequence (l_n) converges to a finite collection $\{E_j, 1 \leq j \leq m_0\}$ of leaves non separated from each other, so that $a_\infty \in \partial E_1, b_\infty \in \partial E_{m_0}$. The collection $\{E_j\}$ is completely determined by a_∞, b_∞ .*

Proof. Suppose first that $a_\infty = b_\infty = z$. Suppose that (l_n) does not escape compact sets in \mathcal{O} . Then a subsequence (l_{n_k}) converges to a sequence of non separated leaves $\{E_j, 1 \leq j \leq m_0\}$. We may assume that the sequence (l_{n_k}) is nested. The escape lemma shows that a_∞, b_∞ are ideal points of the first and last of these leaves. Here we need to use the property on “sides” of z . The concern is that the leaves l_{n_k} could be singular and two ideal points a_{n_k}, b_{n_k} of l_{n_k} could converge to the same point in $\partial\mathcal{O}$ and still the sequence (l_{n_k}) does not escape in \mathcal{O} . With the additional hypothesis we obtain that a_∞, b_∞ could not be equal, contradiction. We conclude that in this case (l_n) escapes compact sets. In addition the escape lemma implies that the sequence (l_n) can only accumulate in a_∞ . This finishes the proof in this case.

Now suppose that a_∞, b_∞ are distinct. Take a subsequence (l_{n_k}) which converges to a finite collection of leaves $\{E_j, 1 \leq j \leq m_0\}$. The escape lemma shows that this collection produces a path from a_∞ to b_∞ . This path is minimal, it only includes the leaves non separated from each other. Lemma 6.10 shows that this path is unique. Consider any other subsequence (l_{m_k}) which converges in $\mathcal{O} \cup \partial\mathcal{O}$. If it escapes in \mathcal{D} , then the escape lemma implies that $a_\infty = b_\infty$, contradiction. Otherwise the arguments above show that the subsequence limits to a chain producing a path from a_∞ to b_∞ . As such it must be the path above. This implies that the full sequence (l_n) converges to $\{E_j, 1 \leq j \leq k_0\}$.

This finishes the proof of the lemma. \square

The next proposition will be used throughout the arguments in this section. It involves a type of rigidity of the foliations $\tilde{\Lambda}^s, \tilde{\Lambda}^u$, which implies the convergence group property for certain sequences.

Proposition 6.14. *Let (g_n) be a sequence of distinct elements in $\pi_1(M)$, so that one of the following conditions occur:*

- i) *There is a periodic point x in \mathcal{O} with $(g_n(x))$ not escaping in \mathcal{O} ; or*
- ii) *There are distinct leaves l_0, l_1 of \mathcal{O}^s (or \mathcal{O}^u) which are non separated from each other in their respective leaf space and so that: for a subsequence $(n_i), i \in \mathbf{N}$ then both $g_{n_i}(l_0)$ and $g_{n_i}(l_1)$ intersect a fixed compact set K of \mathcal{O} for all i .*

Then: in Case i) there is a subsequence (n_i) with $g_{n_i}(x) = y$ for all i , which implies that: there are fixed h, f in $\pi_1(M)$ so that $g_{n_i} = f^{m_i}h$ for some m_i in \mathbf{Z} , where $h(x) = y$ and f is a generator $\text{Stab}(y)$. In Case ii) there is a subsequence (n_i) and f, h in $\pi_1(M)$ so that for all i

$$g_{n_i}(l_0) = e_0, g_{n_i}(l_1) = e_1; \quad g_{n_i} = f^{m_i}h \quad \text{where } h(l_0) = e_0, h(l_1) = e_1 \text{ and } f \in \text{Stab}\{e_0 \cup e_1\}$$

By the previous corollary, in either case it follows that (g_n) has a subsequence with a source/sink for its action on \mathcal{R} and they are different from each other.

Proof. In case i) since $g_n(x)$ does not escape in \mathcal{O} , there is a subsequence (n_i) with $g_{n_i}(x) \rightarrow y$ and $y \in \mathcal{O}$. Since the orbit of x under $\pi_1(M)$ is discrete in \mathcal{O} as x is periodic, we may assume that $g_{n_i}(x) = y$ for all i . The conclusion of case i) follows.

In case ii) up to subsequence assume that $(g_{n_i}(l_0))$ converges to e_0 and $(g_{n_i}(l_1))$ converges to e_1 . Furthermore e_0 cannot be equal to e_1 because $g_n(l_0), g_n(l_1)$ are distinct. In particular e_0 is non separated from e_1 . In addition the only distinct non separated leaves which are very close to both e_0 and e_1 respectively are e_0, e_1 themselves. It follows that for i big enough $g_{n_i}(l_0) = e_0$ and $g_{n_i}(l_1) = e_1$. We may assume this is true for all i . The conclusion of case ii) follows. This finishes the proof of the proposition. \square

We are now ready to prove the convergence group theorem.

Theorem 6.15. *Let Φ be a bounded pseudo-Anosov flow and let \mathcal{R} be the flow ideal boundary. Then $\pi_1(M)$ acts as a convergence group on \mathcal{R} .*

Proof. The proof is somewhat tricky. This is in great part due to the existence of perfect fits and/or pairs of non separated leaves in $\mathcal{O}^s, \mathcal{O}^u$. For example it may be that a sequence of leaves (l_n) in \mathcal{O}^s

converges to more than one leaf $e_1 \cup \dots \cup e_j$. Then in the limit many more points in $\partial\mathcal{O}$ are identified by the equivalence relation. Since we are considering the action on \mathcal{R} , one has to be really careful when considering these additional possible identifications.

We will use the induced actions on $\mathcal{R}, \mathcal{O}, \partial\mathcal{O}, \widetilde{M}$ as needed. We use the same notation for an element g in $\pi_1(M)$ acting on any of these spaces. Let (g_n) be a sequence of distinct elements of $\pi_1(M)$. In each case we prove the convergence group property in that particular situation. Since the convergence group property concerns subsequences, we will take subsequence at will and many times abuse notation and keep the same notation for the subsequence. Almost all of the proof will be done looking at the action on $\mathcal{D} = \mathcal{O} \cup \partial\mathcal{O}$. This is because, as we will see, there is a very good control of the action on the foliations $\mathcal{O}^s, \mathcal{O}^u$.

First a preliminary step concerning whether g_n preserves orientation in \mathcal{O} or not. Up to subsequence we may assume that either all g_n preserve orientation in \mathcal{O} , or all reverse orientation. In the second case consider a second sequence $h_n = g_n(g_1)^{-1}$. The sequence (h_n) preserves orientation in \mathcal{O} . If we prove the convergence group property for a subsequence of (h_n) then the same follows for (g_n) . Hence we can do the following:

Assumption in all cases – Every element in the sequence (g_n) preserves orientation in \mathcal{O} . It follows that they preserve orientation in \widetilde{M} . If M is non orientable then since all g_n preserve orientation in \widetilde{M} , we can lift to a double cover if necessary and assume that M is orientable.

Case 1 – No open interval in $\partial\mathcal{O}$ converges to a point in $\partial\mathcal{O}$ under some subsequence of (g_n) .

This case cannot happen and it is reasonably simple to deal with, so we eliminate it first. First we show that if l is a leaf of \mathcal{O}^s or \mathcal{O}^u , there cannot be a subsequence (g_{n_k}) of (g_n) so that $(g_{n_k}(l))$ escapes compact sets in \mathcal{O} . Suppose this is not true and let l and (g_{n_k}) satisfying this. If the endpoints of $g_{n_k}(l)$ are not getting close together, then we produce a non trivial interval of $\partial\mathcal{O}$ which does not contain any ideal point of a leaf of \mathcal{O}^s or \mathcal{O}^u . This is impossible. Hence the endpoints of $g_{n_k}(l)$ are getting arbitrarily close together. Up to another sequence these endpoints converge to a single point b in $\partial\mathcal{O}$. Then one of the intervals J of $\partial\mathcal{O}$ defined by the ideal points of l will satisfy that $(g_{n_k}(J))$ converges to b . This contradicts the hypothesis in this case.

Suppose that the leaf space of one of \mathcal{O}^s or \mathcal{O}^u , say \mathcal{O}^s is non Hausdorff. Let l, r be leaves of \mathcal{O}^s which are non separated from each other. Since the images of these under any subsequence of (g_n) cannot escape compact sets we take a subsequence (g_{n_k}) so that both the sequences $(g_{n_k}(l))$ and $(g_{n_k}(r))$ converge to (possibly more than one) leaf of \mathcal{O}^s . Then all $g_{n_k}(l)$ and $g_{n_k}(r)$ intersect a fixed compact set K of \mathcal{O} . Since l and r are non separated from each other, then we can apply Proposition 6.14 part ii). It follows that there are f, h in $\pi_1(M)$ and a further subsequence n_{k_i} so that $g_{n_{k_i}} = f^{m_i}h$ for all i . Since h is fixed, Lemma 6.8 implies that there are non trivial intervals of $\partial\mathcal{O}$ which converge to a single point under the subsequence $(g_{n_{k_i}})$. Again this contradicts the hypothesis in this case.

We conclude that the hypothesis of case 1 implies that the leaf spaces of $\mathcal{O}^s, \mathcal{O}^u$ are Hausdorff. In particular if l is a leaf of \mathcal{O}^s or \mathcal{O}^u and (g_{n_k}) is a subsequence so that $(g_{n_k}(l))$ converges, then it converges to a single leaf of either \mathcal{O}^s or \mathcal{O}^u .

Let now p in \mathcal{O} non singular. Up to a subsequence still denoted by (g_n) assume that $(g_n(x))$ converges for any x ideal point of $\mathcal{O}^s(p)$ or $\mathcal{O}^u(p)$. There are 4 such ideal points. The ideal points $\partial\mathcal{O}^s(p)$ link $\partial\mathcal{O}^u(p)$ in $\partial\mathcal{O}$. The limits cannot be the same or else some non degenerate interval of $\partial\mathcal{O}$ converges to a point. Therefore both $(g_n(\mathcal{O}^s(p)))$ and $(g_n(\mathcal{O}^u(p)))$ converge. Let A, B be the respective limits. If A does not intersect B then some of the limits of ideal points of $(g_n(\mathcal{O}^s(p)))$ or $(g_n(\mathcal{O}^u(p)))$ collapse together, which again is not allowed. We conclude that A intersects B and let the intersection be y . Then $(g_n(p))$ converges to y .

This is impossible. Suppose that p is periodic and non singular. Since the sequence $(g_n(p))$ converges to y , Proposition 6.14 implies that there is a subsequence with a source and sink for its action on \mathcal{R} . Again this contrary to hypothesis in this case.

This contradiction finally shows that Case 1 cannot happen. This finishes the analysis of Case 1.

Case 2 – There is a non trivial interval I_1 of $\partial\mathcal{O}$ so under some sequence (g_{n_k}) all points of I_1 converge to a single point w_0 of $\partial\mathcal{O}$.

In order to analyse this case we need a couple of preliminary results.

Proposition 6.16. *Suppose that (g_n) is a sequence of distinct elements of $\pi_1(M)$. Suppose that there are $p \neq q \in \mathcal{O}$ so that $\lim_{n \rightarrow \infty} g_n(p) = \lim_{n \rightarrow \infty} g_n(q)$ and this is a point in \mathcal{O} . Let y_0 be the limit. Then either $\mathcal{O}^s(p) = \mathcal{O}^s(q)$ or $\mathcal{O}^u(p) = \mathcal{O}^u(q)$. In addition suppose that all $g_n(p), g_n(q)$ are very near y_0 so that g_n has a fixed point u_n near y_0 . Let $\gamma_n = \Theta^{-1}(u_n)$. Then*

- If for all n big enough, g_n is associated with the forward direction of γ_n then $\mathcal{O}^u(p) = \mathcal{O}^u(q)$,
- If for all n big enough, g_n is associated with the backwards direction of γ_n then $\mathcal{O}^s(p) = \mathcal{O}^s(q)$.

Proof. Up to subsequence assume that all $g_n(p), g_n(q)$ are in the closure of a sector of y_0 . Suppose first that there is some subsequence of $(g_n(p))$ (or $(g_n(q))$) (still denoted in the same way) which is constant; say the first option. Up to precomposition with g_1^{-1} we may assume that $p = y_0$ also. Let f be the generator of $Stab(y_0)$ associated to the positive flow direction in $\gamma_0 = \Theta^{-1}(y_0)$. Then $g_n = f^{i_n}$ where $|i_n| \rightarrow +\infty$ as $n \rightarrow \infty$. Suppose that $i_n \rightarrow +\infty$. Then the following happens: locally near y_0 , g_n expands the stable direction and contracts the unstable direction. If $g_n(q) \rightarrow y_0$ this can only happen if $q \in \mathcal{O}^u(p)$.

Hence from now on assume that each of the sequences $(g_n(p)), (g_n(q))$ is a sequence of distinct points. By way of contradiction, up to taking subsequences, we may assume that all sequences $(\mathcal{O}^s(g_n(p))), (\mathcal{O}^u(g_n(p))), (\mathcal{O}^s(g_n(q)))$ and $(\mathcal{O}^u(g_n(q)))$ are nested sequences of leaves. Notice they do not escape in \mathcal{O} because y_0 is a point in \mathcal{O} .

Since all $(g_n(p))$ are in same sector of y_0 and very close to y_0 then $g_n g_1^{-1}$ has a fixed point u_n very close to y_0 . Remove a few initial terms and replace p, q by $g_1(p), g_1(q)$ and (g_n) by $(g_n g_1^{-1})$. After this modification g_n has a fixed point u_n near y_0 . Since $g_n(p), p$ are close to u_n then $\mathcal{O}^s(u_n)$ intersects both $\mathcal{O}^u(p), \mathcal{O}^u(g_n(p))$ and likewise $\mathcal{O}^u(u_n)$ intersects both $\mathcal{O}^s(p), \mathcal{O}^s(g_n(p))$. Let $\gamma_n = \Theta^{-1}(u_n)$. Since (g_n) are all distinct then the length of the periodic orbits $\pi(\gamma_n)$ converges to infinity. This length is counted with multiplicity if all the orbits $\pi(\gamma_n)$ are traversed more than once.

Up to subsequence we may assume that either all g_n are associated with the forward or backwards direction in $\pi(\gamma_n)$. Without loss of generality assume that g_n is associated with the forward direction. We will prove that $\mathcal{O}^u(p) = \mathcal{O}^u(q)$. If on the other hand we assume that g_n is associated with the backwards direction of $\pi(\gamma_n)$ then an entirely analogous proof shows that $\mathcal{O}^s(p) = \mathcal{O}^s(q)$.

As $g_n(p) \rightarrow y_0$ and g_n associated to positive flow direction in $\pi(\gamma_n)$ then

- $\mathcal{O}^u(u_n) \rightarrow \mathcal{O}^u(p)$,
- $\mathcal{O}^s(u_n) \rightarrow \mathcal{O}^s(y_0)$.

The reason for this is the following. The lengths of $\pi(\gamma_n)$ go to infinity. If $(\mathcal{O}^u(u_n))$ does not converge to $\mathcal{O}^u(p)$ suppose that $(\mathcal{O}^u(u_n))$ converges to an unstable leaf w which is not $\mathcal{O}^u(p)$. Then $\mathcal{O}^u(p) \cap \mathcal{O}^s(u_n)$ gets pushed farther and farther away from u_n under g_n . This is because $\mathcal{O}^u(u_n)$ is not very close to $\mathcal{O}^u(p)$. But then it follows that $(g_n(p))$ cannot converge to y_0 , contradiction. This shows that $(\mathcal{O}^u(u_n))$ converges to $\mathcal{O}^u(p)$. An entirely analogous argument proves that $(\mathcal{O}^s(u_n))$ converges to $\mathcal{O}^s(y_0)$.

Now suppose that $\mathcal{O}^u(p) \neq \mathcal{O}^u(q)$. Then first notice that $\mathcal{O}^u(q)$ also intersects $\mathcal{O}^s(u_n)$. This is because the same arguments as above applied to $q, g_n(q)$ produce a fixed point u'_n of g_n very close to y_0 . But the transformation g_n can only have one fixed point near y_0 , so it follows that $u_n = u'_n$ and hence $\mathcal{O}^u(q)$ intersects $\mathcal{O}^s(u_n)$. Once we get that then the same arguments we had before shows that $(g_n(q))$ cannot converge to y_0 . We conclude that $\mathcal{O}^u(p) = \mathcal{O}^u(q)$.

This finishes the proof of proposition 6.16. □

Remark – Notice that this proposition does not assume the bounded hypothesis on Φ .

Lemma 6.17. *Let Φ be a bounded pseudo-Anosov flow. There is m_0 in \mathbf{N} so that the following happens. Suppose (g_n) is a sequence of distinct elements of $\pi_1(M)$. Let p_1, \dots, p_m be a finite collection of points in \mathcal{O} so that:*

- *The sequence $(g_n(p_i))$ converges to a point in \mathcal{O} for each i ,*
- *$\{\mathcal{O}^s(p_i), 1 \leq i \leq m\}$ is a collection of pairwise distinct leaves of \mathcal{O}^s ,*
- *$\{\mathcal{O}^u(p_i), 1 \leq i \leq m\}$ is a collection of pairwise distinct leaves of \mathcal{O}^u .*

Then $m \leq m_0$.

Proof. Since Φ is a bounded pseudo-Anosov flow there is an upper bound to the number of fixed points of any g in $\pi_1(M)$ by Theorem 2.6. Let m_0 be such an upper bound.

Let $y_i = \lim_{n \rightarrow \infty} g_n(p_i)$ for each i . By Proposition 6.16 the last two conditions of the hypothesis imply that the set $\{y_1, \dots, y_m\}$ is a collection of distinct points. Up to a subsequence of (g_n) assume that for each i , then all $g_n(p_i)$ are very near p_i and in the same sector of p_i . So for big enough n_0 and fixed $n > j > n_0$ it follows that $g_n g_j^{-1}$ has a fixed point u_i very near y_i . If the u_i are sufficiently near y_i then the points $\{u_1, \dots, u_m\}$ are distinct. Since they are all fixed points of the fixed transformation $g_n g_j^{-1}$ it follows that $m \leq m_0$. This proves the lemma. \square

Definition 6.18. *We say that the sequence $(g_n|_I)$ locally uniformly converges to z if for any compact set $K \subset I$, the functions $g_n|_K$ converge uniformly to the constant function with value z .*

Analysis of case 2 of theorem 6.15.

Recall that in this case there is a non degenerate interval I_1 in $\partial\mathcal{O}$ with $(g_n(I_1))$ converging to a point up to subsequence. We assume up to subsequence that $\lim g_n(I_1) = w_0$. Let J be the maximal open interval so that $(g_n|_J)$ locally uniformly converges to w_0 . Let a, b be the endpoints of J . First we consider the case that $a = b$, that is, $J = \partial\mathcal{O} - \{a\}$. Then we are done: a is the source for the sequence (g_n) and w_0 is the sink. Projecting to \mathcal{R} we obtain the convergence group property for (g_n) .

Therefore we assume from now on that a, b are distinct.

We will prove 2 facts which will be enough to finish the analysis of Case 2.

Fact 1 – There is a non trivial open interval $I \subset \partial\mathcal{O} - J$ and with an endpoint a so that $(g_n|_I)$ locally uniformly converges to w_1 with $w_1 \sim w_0$.

Fact 2 – $b \sim a$.

Proof of fact 1 – As an initial subcase suppose first that a is not an ideal point of a leaf of \mathcal{O}^s or \mathcal{O}^u . Then let $\mathcal{T} = (l_n)$ be a master sequence for the point a made up of stable leaves and likewise let $\mathcal{T}_1 = (u_n)$ be a master sequence for a made up of unstable leaves. For simplicity we assume that no l_n or u_n is singular. For i big one of the endpoints a_i of l_i is in J , so $(g_n(a_i))$ converges to w_0 . The other endpoint b_i of l_i is not in J (for i big). Up to taking subsequences we assume that $(g_n(b_i))$ converges to a point x_i for i big. If there is a subsequence i_k so that $x_{i_k} = w_0$ for all k , this implies that $a = b$ which was dealt with before. Hence assume that $x_i \neq w_0$ for all i big.

By lemma 6.13 x_i and w_0 are connected by a path of non separated stable leaves. Hence we may assume that for i big x_i is constant and so equal to some point x' . The same argument applies to the master sequence of unstable leaves. Since (l_n) and (u_n) are eventually nested it follows that the x' is also connected to w_0 by a path of non separated unstable leaves. By proposition 6.3 the path connecting w_0 to x' is unique hence

$$\lim_{n \rightarrow \infty} g_n(l_i) = \lim_{n \rightarrow \infty} g_n(u_i)$$

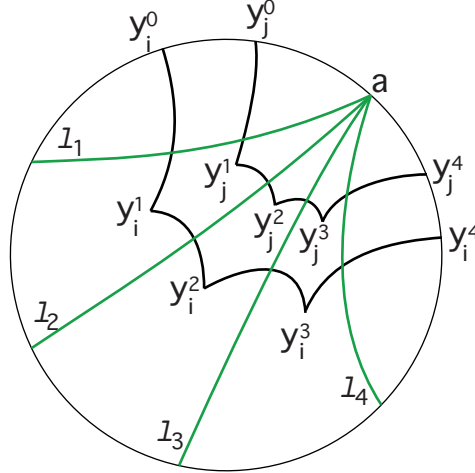

Figure 14: A standard sequence for the ideal point a . In this case $k_0 = 4$. We depict the convex chains E_i and E_j where $i < j$.

for i big. But this is impossible as one is made of stable leaves and the other is made of unstable leaves..

We conclude that the point a and likewise b is an ideal point of a leaf of \mathcal{O}^s or \mathcal{O}^u . Let l_1, \dots, l_{k_0} be the leaves with ideal point a and order them so that l_k separates $l_{k'}$ from $l_{k''}$ if $k' < k < k''$. Then l_k makes a perfect fit with the leaves l_{k-1} and l_{k+1} both of which are in the other foliation.

As in Definition 3.16 we use a standard sequence $\mathcal{V} = (E_i)$ of convex chains defining the point a , where each E_i is made up of $k_0 - 2$ segments in \mathcal{O}^s or \mathcal{O}^u and 2 rays of these foliations. Call these segments/rays e_i^k , where $1 \leq k \leq k_0$. Then each e_i^k intersects the ray l_i with ideal point a . Both $e_i^1, e_i^{k_0}$ are rays and the other e_i^k are compact segments. Let y_i^0 be the ideal point of the first ray (with ideal point in J) and y_i^k , $1 \leq k \leq k_0$ be the other corners of E_i . Notice that y_i^k is in \mathcal{O} for any i and for $1 \leq k < k_0$. The collection $\{y_i^{k_0}, i \in \mathbf{N}\}$ is a collection of points in $\partial\mathcal{O}$. We refer to fig. 14. The goal here is to show that for big enough i then $(g_n(y_i^{k_0}))$ converges to a fixed point w_1 (independent of i) which is equivalent to w_0 under \sim . Then we will obtain the interval I as required. This will prove fact 1.

We do the proof for $k_0 \geq 2$, that is, there is more than one leaf of $\mathcal{O}^s \cup \mathcal{O}^u$ with ideal point a . The case $k_0 = 1$ is much easier.

Since there are countably many $\{y_i^k, 1 \leq k \leq k_0, i \in \mathbf{N}\}$ we assume up to subsequence (in n) that for each i and for each k , $0 \leq k \leq k_0$, then

$$\lim_{n \rightarrow \infty} g_n(y_i^k) \text{ exists in } \mathcal{O} \cup \partial\mathcal{O}. \text{ Notice that } w_0 = \lim_{n \rightarrow \infty} g_n(y_i^0).$$

The difficulty is that we do not know for any given i , whether the limits are in \mathcal{O} or in $\partial\mathcal{O}$, for $1 \leq k < k_0$. Consider the points y_i^k, y_j^r , where $1 \leq k, r < k_0$. Then these points are in \mathcal{O} . If $|k - r| \geq 2$ then $\mathcal{O}^s(y_i^k), \mathcal{O}^s(y_j^r)$ are distinct leaves and so are $\mathcal{O}^u(y_i^k), \mathcal{O}^u(y_j^r)$. Even for $|k - r| = 1$ this is true for $i \neq j$. By Lemma 6.17 there are at most m_0 points in the collection $\{y_i^k, 1 \leq k < k_0, i \geq 1\}$ so that $\lim_{n \rightarrow \infty} g_n(y_i^k)$ is a point in \mathcal{O} . Therefore

Conclusion – There is i_0 so that if $i > i_0$ then $\lim_{n \rightarrow \infty} g_n(y_i^k)$ is in $\partial\mathcal{O}$ for any $1 \leq k < k_0$.

We now proceed by induction on $k, 1 \leq k \leq k_0$. Fix $i \geq i_0$. If $(g_n(e_i^1))$ escapes compact sets in \mathcal{O} , then $\lim_{n \rightarrow \infty} g_n(y_i^1) = w_0$ as well, because $\lim_{n \rightarrow \infty} g_n(y_i^0) = w_0$. Suppose this is not the case. Then $\lim_{n \rightarrow \infty} g_n(e_i^1)$ is a collection of leaves of \mathcal{O}^s or \mathcal{O}^u , which are non separated from each other, at least one of which has one ideal point a . Since y_i^1 are in e_i^1 , then by the escape lemma, Lemma 4.7, it follows that

$$\lim_{n \rightarrow \infty} g_n(y_i^1) = x_i^1$$

is an ideal point of one of these non separated leaves. In particular x_i^1 and w_0 are ideal points of stable leaves which are non separated from each other and in particular $x_i^1 \sim w_0$.

Now proceed by induction on k . Suppose that

$$\lim_{n \rightarrow \infty} g_n(y_i^{k-1}) = x_i^{k-1} \quad \text{and} \quad x_i^{k-1} \sim w_0.$$

If $(g_n(e_i^k))$ escapes compact sets in \mathcal{O} , then $\lim_{n \rightarrow \infty} g^n(y_i^k) = x_i^{k-1}$. Otherwise the same proof as above shows that $\lim_{n \rightarrow \infty} g_n(y_i^k) = x_i^k$ and $x_i^k \sim x_i^{k-1}$. Consequently $x_i^k \sim w_0$. We conclude that

$$\lim_{n \rightarrow \infty} g_n(y_i^{k_0}) = t_i \sim w_0.$$

We stress that this works for any $i \geq i_0$. Since there are only finitely many points in $\partial\mathcal{O}$ which are equivalent to w_0 and there is a weak monotonicity property, it follows that t_i is constant equal to w_1 for i big. In particular this produces an open interval $I \subset \partial\mathcal{O} - J$ with one ideal point a so that for any $z \in I$ then $\lim_{n \rightarrow \infty} g_n(z) = w_1$ for $i \geq i_0$ and so that $w_1 \sim w_0$. Then $(g_n|_I)$ locally uniformly converges to $w_1 \sim w_0$.

This finishes the proof of fact 1.

Proof of fact 2

The proof will make essential use of Fact 1 and its proof as well.

We apply the arguments we have done so far to the sequence (f_n) where $f_n = g_n^{-1}$. This is a sequence of distinct elements of $\pi_1(M)$. As before we know that case 1 cannot happen to the sequence (f_n) . Recall the maximal open interval J so that $(g_n|_J)$ converges locally uniformly to w_0 . We may assume that J is not $\partial\mathcal{O} - \{a\}$ for otherwise we are done. Hence there is an interval I as in the proof of fact 1.

We now apply a similar construction as in the proof of fact 1 to the sequence (f_n) and w_0 . Let $\mathcal{D} = (d_i)$ be a master sequence defining the ideal point w_0 . We assume that all convex chains d_i have length k_1 and ideal points/corners $\{v_i^k\}, 0 \leq k \leq k_1$, where $v_i^0, v_i^{k_1}$ are in $\partial\mathcal{O}$ and the rest in \mathcal{O} . As in the proof of fact 1, lemma 6.17 implies that there is i_1 so that

$$\forall i \geq i_1, \quad \lim_{n \rightarrow \infty} f_n(v_i^k) \quad \text{exists and is in } \partial\mathcal{O} \quad \text{for all } 1 \leq k < k_1.$$

Let

$$a_i = \lim_{n \rightarrow \infty} f_n(v_i^0), \quad b_i = \lim_{n \rightarrow \infty} f_n(v_i^{k_1}).$$

Exactly as in the proof of fact 1, we obtain that $a_i \sim b_i$ for any $i \geq i_1$.

Now let I_i be the interval of $\partial\mathcal{O}$ defined by $v_i^0, v_i^{m_0}$ and containing w_0 . Fix a compact set C contained in the interval J from the proof of fact 1. Recall that J is an open interval in $\partial\mathcal{O}$. For any fixed i then $g_n(C) \subset I_i$ for n sufficiently big. This is because $(g_n|_J)$ converges locally uniformly to w_0 .

Up to a subsequence in i we may assume that $\lim_{i \rightarrow \infty} a_i$ exists and similarly $\lim_{i \rightarrow \infty} b_i$ exists. Let these limits be a', b' respectively. In particular

$$a' = \lim_{i \rightarrow \infty} \left(\lim_{n \rightarrow \infty} f_n(v_i^0) \right), \quad b' = \lim_{i \rightarrow \infty} \left(\lim_{n \rightarrow \infty} f_n(v_i^{k_1}) \right).$$

Since $g_n(C) \subset I_i$ for n big, then $C \subset f_n(I_i)$ for n big. Therefore one of the intervals of $\partial\mathcal{O}$ determined by a', b' , call it $[a', b']$ contains J . Suppose that the interval is strictly bigger than J , that is the closure of J is not equal to $[a', b']$. Recall that $\partial J = \{a, b\}$. For example suppose that b is in the interior of $[a', b']$, so there is c in $[a', b']$, with $[c, b]$ disjoint from J and $[c, b]$ contained in $[a', b']$. The definition of a', b' then implies that $J \cup (c, b]$ is an open interval strictly bigger than J where (g_n) locally converges to w_0 . This is a contradiction to the assumption of maximality of J .

We conclude that $[a', b']$ is equal to the closure of J . Since $a' = \lim_{i \rightarrow \infty} a_i$ and $b' = \lim_{i \rightarrow \infty} b_i$. Up to switching a', b' then $a' = a, b' = b$. But $a_i \sim b_i$ and \sim is a closed equivalence relation in $\partial\mathcal{O}$. It follows that $a \sim b$ as we wanted to prove.

This finishes the proof of Fact 2.

With this property we can quickly finish the proof of Case 2. By Fact 2 if J is the maximal open interval with $(g_n|_J)$ locally uniformly converges to w_0 , then $\partial J = \{a, b\}$ and $a \sim b$. Using Fact 1, there is an open interval I_0 , with

$$I_0 \cap J = \emptyset, \quad a \in \partial I, \quad \text{and} \quad (g_n|_{I_0}) \text{ converges to } w_1, \quad w_1 \sim w_0.$$

Let I_1 be the maximal open interval with $(g_n|_{I_1})$ locally uniformly converges to w_1 . Then Fact 2 shows that $\partial I_1 = \{a, c\}$ and $c \sim a$ and so $c \sim b$. Since there are finitely many intervals in $\partial\mathcal{O} - \mathcal{E}(a)$ we show that for any such interval I' , then $(g_n|_{I'})$ converges locally uniformly to a point w with $w \sim w_0$. This shows that $\mathcal{E}(a)$ is the source and $\mathcal{E}(w_0)$ is the sink for the appropriate subsequence of (g_n) acting on $\partial\mathcal{O}$. This finishes the proof of Case 2.

This shows that (g_n) always has a subsequence with source/sink behavior. This finishes the proof of theorem 6.15. \square

7 Uniform convergence group

The purpose of this section is to prove the following result.

Theorem 7.1. *Let Φ be a bounded pseudo-Anosov flow. Let \mathcal{R} be the quotient of $\partial\mathcal{O}$ by the equivalence relation \sim . Then the action of $\pi_1(M)$ on \mathcal{R} is a uniform convergence group.*

Proof. By the convergence group theorem, theorem 6.15, we only have to prove that any point in \mathcal{R} is a conic limit point for the action of $\pi_1(M)$ on \mathcal{R} : given p in \mathcal{R} there is a sequence (g_n) in $\pi_1(M)$ and $a \neq b$ in \mathcal{R} so that the sequence $(g_n(p))$ converges to a and the sequence $(g_n(q))$ converges to b for any q in \mathcal{R} , with $q \neq p$.

Notation – We denote by $\eta : \partial\mathcal{O} \rightarrow \mathcal{R}$ the projection map.

We will mostly work in $\partial\mathcal{O}$ and $\mathcal{D} = \mathcal{O} \cup \partial\mathcal{O}$ analysing the actions of $\pi_1(M)$ on these spaces. Let x in $\partial\mathcal{O}$ with $p = \eta(x)$. Very roughly the sequence (g_n) will be obtained by zooming in to x . This is easily done in $\mathcal{D} = \mathcal{O} \cup \partial\mathcal{O}$. This will need adjustments to take into account the three dimensional situation in \widetilde{M} .

Being a conical limit point is associated with a *geometrical* property in \widetilde{M} . Let us recall the situation of $\pi_1(M)$ Gromov hyperbolic: if y is a point in $\partial\widetilde{M}$, then to show that y is a conical limit point, one “zooms in” to y . To do that one gets a geodesic ray r in \widetilde{M} with ideal point y . Then using that M is compact, take accumulation points of the projection of r in M . Use this to produce covering translations g_n and points v_n in r with (v_n) converging to y in $\widetilde{M} \cup S_\infty^2$ so that $(g_n(v_n))$ converges to a point v^* in \widetilde{M} . Assuming that $(g_n(r))$ also converges then one gets the following. The limit of $(g_n(r))$ is a full geodesic r' and the ideal points of $(g_n(r))$ converge to an ideal point a of r' . Let b be the other ideal point of r' . Then one can easily show that $(g_n(y))$ converges to a and $(g_n(z))$ converges to b for any $z \in S_\infty^2 = \partial\widetilde{M}$ distinct from y . Here $a \neq b$ as they are the ideal points of a geodesic r' .

The major problem that we have in the flow setting is that, at this point, we do not have any connection between the flow ideal boundary and the geometry of \widetilde{M} . In particular one cannot do the “geometrical zooming in” which easily proves the conical limit point property in the case that $\pi_1(M)$ is Gromov hyperbolic. The proof here will be to use the flow Φ and the foliations $\mathcal{O}^s, \mathcal{O}^u$ to zoom in to a point in \mathcal{R} or in $\partial\mathcal{O}$. So if p is a point in \mathcal{R} one can produce a sequence (g_n) with $(g_n(p))$ converging to a and $(g_n(z))$ converging to b for any $z \neq p$. By far the biggest problem is that one does not know a priori

that $b \neq a$. As explained above this comes essentially for free in the geometric situation. In our case this is much, much trickier because of the existence of perfect fits, which produce many identifications between points of $\partial\mathcal{O}$ under \sim . It is complicated to rule out identifications in the limit.

There are three cases in the proof. Two of them are very simple and are called Preliminary cases 1 and 2. The much, much harder case is called the main case. The main case will have two main subcases, denoted by Case A and Case B and subcases within these. In our setup p is an arbitrary point in \mathcal{R} and x is a point in $\partial\mathcal{O}$ with $\eta(x) = p$.

Preliminary case 1 – Periodic ideal point.

Suppose that x is an ideal point of a periodic leaf l of \mathcal{O}^s or \mathcal{O}^u . Let g be a generator of the stabilizer of l so that in \mathcal{R} , $p = \eta(x)$ is the source for the action of g on \mathcal{R} . This is guaranteed by Corollary 6.9. Then $g_n(p) = p$ and $(g_n(q))$ converges to b – the attracting fixed point of g for any $q \neq p$. Since the two fixed points of g acting on \mathcal{R} are distinct, this proves the conical limit point property for p .

Preliminary case 2 – The point x is an ideal point of a leaf l of \mathcal{O}^s or \mathcal{O}^u , which is not periodic.

Without loss of generality assume that l is a stable leaf. Let $L = l \times \mathbf{R}$ and fix an orbit γ in L . Consider a sequence (q_n) in γ escaping in the positive flow direction so that the sequence $(\pi(q_n))$ converges to v^* in M . Up to a subsequence assume that all $\pi(q_n)$ are in a fixed local sector of v^* . Let τ_n be the segment of γ between q_0 and q_n . By the closing Lemma, up to subsequence (removing a few terms may change q_0) we can assume that, for each n , the flow segment $\pi(\tau_n)$ is shadowed by a closed orbit, denoted by δ_n . Let g_n in $\pi_1(M)$ associated to δ_n and so that $g_n(q_n)$ is very near q_0 . In that way g_n is associated with negative flow direction in the invariant orbit near τ_n . Let $\gamma_n = g_n(\gamma)$. By construction, the orbit γ_n has a point $g_n(q_n)$ very near q_0 .

Consider $\gamma, g_n(\gamma)$ as points in \mathcal{O} . Up to subsequence assume that $(g_n(\gamma))$ converges in \mathcal{O} to α . Let u_n in \mathcal{O} near γ with $g_n(u_n) = u_n$. That is, u_n are the orbits associated to coherent lifts of the closed orbits δ_n . Since g_n is associated with the negative flow direction in $\Theta^{-1}(u_n)$ then the following happens. The arguments in the end of the proof of Proposition 6.16 imply that

$$(\mathcal{O}^s(u_n)) \text{ converges to } l = \mathcal{O}^s(\gamma) \text{ and } (\mathcal{O}^u(u_n)) \text{ converges to } \mathcal{O}^u(\alpha).$$

Consequently (u_n) converges to $l \cap \mathcal{O}^u(\alpha)$. We already proved the convergence group property for the action of $\pi_1(M)$ on \mathcal{R} and we will use that to great effect here. By the convergence group theorem, Theorem 6.15, we may assume up to subsequence that (g_n) has a source/sink for the action on \mathcal{R} . Equivalently this sequence has source and sink sets (or equivalence classes of \sim) for the action on $\partial\mathcal{O}$. By the escape lemma, we know that $(g_n(x))$ converges to a point in $\mathcal{E}(\partial\mathcal{O}^s(\alpha))$. The leaf l is not periodic, so in particular it is not singular. Therefore for any z in l , then for big enough n , the unstable leaf $\mathcal{O}^u(z)$ intersects $\mathcal{O}^s(u_n)$. We stress that this is necessarily true because l is not singular. Then again because g_n is associated with the negative flow direction along $\Theta^{-1}(u_n)$ it follows that, for any z in l , the sequence $(g_n(\mathcal{O}^u(z)))$ converges to $\mathcal{O}^u(\alpha)$ – and perhaps to other leaves of \mathcal{O}^u . In particular for any such z the ideal points of $g_n(\mathcal{O}^u(z))$ converge to points in $\mathcal{E}(\partial\mathcal{O}^u(\alpha))$. But there are uncountably many such z , only boundedly many of which can generate points in $\partial\mathcal{O}$ which are equivalent to each other under \sim . It follows that the sink set for the sequence (g_n) acting on $\partial\mathcal{O}$ is $\mathcal{E}(\partial\mathcal{O}^u(\alpha))$. In other words the sink for the sequence (g_n) acting on \mathcal{R} is $\eta(\partial\mathcal{O}^u(\alpha))$.

On the other hand the points in the sequences $(g_n(\partial l))$ converge to points in $\mathcal{E}(\partial\mathcal{O}^s(\alpha))$. By Proposition 6.3, $\mathcal{E}(\partial\mathcal{O}^s(\alpha)), \mathcal{E}(\partial\mathcal{O}^u(\alpha))$ are disjoint subsets of $\partial\mathcal{O}$. This implies that $\mathcal{E}(\partial l)$ is the source set for the sequence (g_n) acting on $\partial\mathcal{O}$. Again because $\mathcal{E}(\partial\mathcal{O}^s(\alpha))$ and $\mathcal{E}(\partial\mathcal{O}^u(\alpha))$ are disjoint subsets of $\partial\mathcal{O}$, this shows that $\eta(\partial l) = \eta(x) = p$ is a conic limit point for the action of $\pi_1(M)$ on \mathcal{R} .

This finishes the analysis of preliminary case 2.

Main case – x is not an ideal point of a leaf of \mathcal{O}^s or \mathcal{O}^u .

In particular this implies that $\mathcal{E}(x) = \{x\}$ is a singleton. This is by far the hardest case. For simplicity of notation the subcases will be denoted without explicit referral to the main case. There will be many

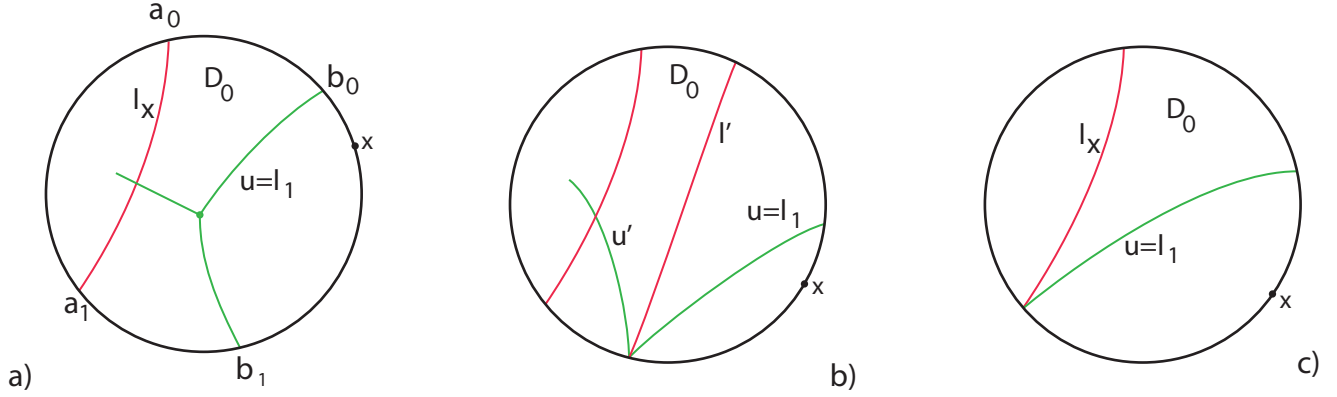

Figure 15: *Production of the next leaf in the standard path. a. Singular next leaf, b. Non Hausdorff next leaf, c. Perfect fit next leaf. The figures depict $\mathcal{O} \cup \mathcal{O}$. The red curves are stable leaves, the green curves are unstable leaves.*

steps. It is much more convenient to prove the result in $\partial\mathcal{O}$. In this setup we will first prove that there is a sequence (g_n) in $\pi_1(M)$ so that when acting on $\partial\mathcal{O}$: $(g_n(x))$ converges to a point z and for any y in $\partial\mathcal{O}$ with $y \neq x$ then $(g_n(y))$ converges to a point w . This is not too hard. Then we will show that we can choose, perhaps another sequence (g'_n) , so that the corresponding limits z', w' of $(g'_n(x)), (g'_n(y))$ are not equivalent under \sim . This will prove the conical limit property for $p = \eta(x)$.

Terminology: leaf separating ideal points – The following terminology will be extremely useful. Let l be a leaf or line leaf or slice leaf in \mathcal{O}^s or \mathcal{O}^u . Let A, B be connected subsets of $\partial\mathcal{O}$. We say that l separates A from B if l does not have any ideal points in A or B and the set of ideal points of l , (the set ∂l) disconnects A from B in $\partial\mathcal{O}$. That is, A and B are contained in distinct components of $\partial\mathcal{O} - \partial l$. A lot of the time this will be used when A is a point – the image of x under g_n , and B is $g_n(K)$ for K a compact set in $\partial\mathcal{O}$. In the same way given sets C, D in $\mathcal{D} = \mathcal{O} \cup \partial\mathcal{O}$ and l a leaf of \mathcal{O}^s or \mathcal{O}^u we say that l separates C from D if C, D are in different components of $\mathcal{D} - (l \cup \partial l)$.

Step 1 – Standard path in \mathcal{O} associated to the ideal point x .

This is made up of rays, segments and slice leaves of \mathcal{O}^s or \mathcal{O}^u . There are infinitely many parts of this path. The starting leaf of the path is non canonical but once a starting leaf is chosen, everything else will be canonical. Let l_x be (say) a stable, non periodic leaf. By hypothesis x is not an ideal point of l_x .

Let the ideal points of l_x be a_0, a_1 . Let C be the interval of $\partial\mathcal{O}$ bounded by a_0, a_1 and not containing x . This compact set C will be used throughout the proof.

Consider the collection $\{u \in \mathcal{O}^u, u \cap l_x \neq \emptyset\}$. We are interested in the component of $u - l_x$ contained in the component D_0 of $\mathcal{O} - l_x$ that limits on x . There are 3 possibilities:

- 1) There is a unique unstable leaf u intersecting l_x so that u has a singularity s_1 in D_0 and two full prongs P_1, P_2 of u are contained in D_0 with ideal points b_0, b_1 with a_1, b_1, x, b_0, a_0 circularly ordered in $\partial\mathcal{O}$. We refer to figure 15, a. In this case let $l_1 = u$. Notice that the union of the two prongs of l_1 in question separate x from l_x and $\mathcal{O}^s(s_1) \cap l_x = \emptyset$.

In this case the path has to cross two prongs of s_1 at least one stable and one unstable to get closer to x . In other words, both $\mathcal{O}^s(u_1)$ and $\mathcal{O}^u(u_1)$ separate x from l_x .

- 2) There is a unique unstable leaf u' intersecting l_x satisfying: u' is non separated from a leaf u contained in D_0 so that u separates x from l_x , see figure 15, b. In this case let $l_1 = u$. Notice that there is a stable leaf l' contained in D_0 , having an ideal point in common with u and separating u from u' . This leaf l' separates x from l_x . Let $s_1 = l'$.

In this case the path has to cross the leaf l' and the leaf l_1 to get closer to x and l', l_1 form a perfect

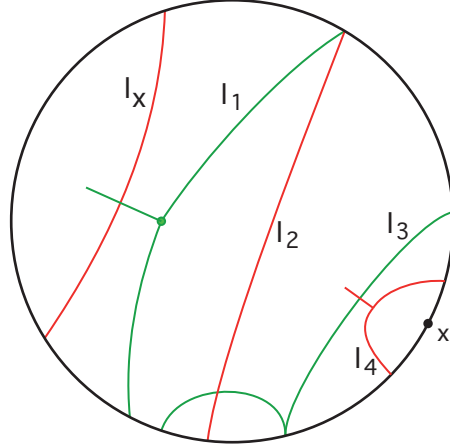

Figure 16: *The standard path to x with starting leaf l_x . This figure depicts $\mathcal{O} \cup \partial\mathcal{O}$ and the first 4 steps l_1, \dots, l_4 of the standard path to x . Stable leaves are red and unstable leaves are green. Leaves l_1 and l_4 are chosen according to Option 1 of Step 1. Leaf l_2 is chosen according to Option 3 of Step 1. Leaf l_3 is chosen according to Option 2 of Step 1. Accordingly there is a stable leaf intersecting l_2 which is non separated from l_3 and l_3 separates x from l_x .*

fit.

- 3) There is a unique unstable leaf u making a perfect fit with l_x , contained in D_0 and separating x from l_x . In this case let $l_1 = u$, see figure 15, c.

Conclusion – We stress the very important fact that in situations 1), 2) and 3) there is a unique stable (or unstable) leaf l_1 produced by the process and l_1 has a line leaf which separates x from l_x .

We now proceed by induction, starting with l_1 which is unstable and reversing the roles of stable and unstable to produce l_2 stable, contained in D_0 , with a line leaf separating x from l_1 and: either l_2 is singular and intersecting l_1 , or l_2 is non separated from a leaf intersecting l_1 , or l_2 makes a perfect fit with l_1 . By induction we produce a sequence of leaves (l_i) which are alternatively stable and unstable. In the same way as above under option 2) we define leaves s_i as we defined s_1 . See fig. 16.

Once the first leaf l_x is chosen the process is canonical. It produces a way to zoom to x in $\mathcal{D} = \mathcal{O} \cup \partial\mathcal{O}$. Notice that the sequence of even numbered leaves (l_{2i}) with $i \in \mathbf{N}$ provides a master sequence for x with stable leaves, whereas the sequence of odd numbered leaves (l_{2i+1}) with $i \in \mathbf{N}$ provides a master sequence for x with unstable leaves. Let

$$\mathcal{P} = \{ l_i, s_i \}, \quad i \in \mathbf{N}$$

be the path that zooms in to x in \mathcal{D} . This path is called a *standard path* associated to x . This is the canonical path associated to x given the initial leaf l_x . Notice that if s_i exists if and only if for such i , the leaf l_i is chosen according to option 2 in Step 1.

This finishes Step 1.

There is a bound on any chain of perfect fits, so a bound on how many consecutive times option 3) can occur. Then we have to have at least one instance of option 1) or 2). Therefore there is a subsequence (m_n^*) of \mathbf{N} so that for each m_n^* , $l_{m_n^*}$ is produced by either option 1) or option 2). Since there are only finitely many singular orbits of Φ and finitely many non Hausdorff pairs up to covering translations, there is a subsequence (m_n) of the sequence (m_n^*) so that for each m_n , (l_{m_n}) projects to the same leaf in M (stable or unstable). Assume without loss of generality that these leaves are stable leaves. Since each of these leaves is periodic let p_{m_n} be the periodic point in l_{m_n} .

Setup – At this point we have a subsequence (m_n) so that for each n , l_{m_n} is produced according to

either option 1) or option 2) in Step 1) and in addition every l_{m_n} projects to the same leaf in M , which is assumed to be stable.

Step 2 – Pulling back to a compact set. Let

$$g_n \in \pi_1(M) \quad \text{with} \quad g_n(l_{m_n}) = l_0, \quad \text{where } l_0 \text{ is a fixed leaf.}$$

Let v_0 be the periodic point in l_0 . By the convergence group theorem, up to another subsequence assume that the sequence (g_n) has a source and sink for the action on \mathcal{R} . Similarly there are source and sink sets for the sequence (g_n) acting on $\partial\mathcal{O}$. Each of these is an equivalence class of \sim , possibly the same class.

We define line leaves l'_i of l_i as follows. 1) The union of the two ideal points of l'_i separates x from ∂l_x in $\partial\mathcal{O}$; 2) The ideal points of l'_i are the ideal points of l_i closest to x satisfying property 1). The l'_i are uniquely defined under these properties. Let A_i be the closed interval of $\partial\mathcal{O}$ bounded by the ideal points of these line leaves l'_i and not containing x . Clearly $\cup_{i \in \mathbf{N}} A_i = \partial\mathcal{O} - \{x\}$. The l'_i form a nested sequence of line leaves converging to x in $\mathcal{O} \cup \partial\mathcal{O}$.

Claim 1 – The point x is the source for the action of the sequence (g_n) acting on $\partial\mathcal{O}$.

This implies that $p = \eta(x)$ is the source for the sequence (g_n) acting on \mathcal{R} , since $\mathcal{E}(x) = \{x\}$. We first prove:

Claim 2 – For any fixed i , $(g_n(A_i))$ shrinks to a point, that is, $(\text{diam } g_n(A_i))$ converges to zero as $n \rightarrow \infty$.

We prove Claim 2. If the claim is not true then this is not true for some i_0 and a subsequence of (g_n) – which we assume here is the original sequence. Then for any $i > i_0$ the set $g_n(A_i)$ also does not shrink to a point when $n \rightarrow \infty$, because $A_{i_0} \subset A_i$. Using a diagonal process of subsequences in n , we can assume that for any i , the sequence $(g_n(A_i))$ converges as $n \rightarrow \infty$. The limit is an interval (a_i, b_i) in $\partial\mathcal{O}$ bounded by points a_i, b_i . The limit cannot be a point by assumption when $i > i_0$. In addition it cannot be the whole of $\partial\mathcal{O}$ minus a point, because for each n , one has $g_n(l_{m_n}) = l_0$ and $m_n \rightarrow \infty$ when $n \rightarrow \infty$. Therefore for each $i > i_0$, a_i, b_i are distinct from each other. Furthermore notice that there is a monotonicity involved, if $j > i$ then $(a_j, b_j) \supset (a_i, b_i)$. The ideal points of l'_i for different values of i can be equivalent under \sim for only finitely many values of i . Increasing i_0 if necessary, we may assume that no such ideal point is in the source set for the action of the sequence (g_n) on $\partial\mathcal{O}$. Therefore for all $i > i_0$ the sequences $(g_n(\partial l'_i))$ converge to points in the sink set for the action of (g_n) on $\partial\mathcal{O}$. There are finitely many points in this set; for each j there are finitely many i for which the ideal points of l_i are equivalent to the ideal points of l_j ; finally there is the monotonicity property above. This means that there is i_1 so that if $i > i_1$ then $a_i = a_{i_1}$, $b_i = b_{i_1}$. Then for each such i , the sequence $(g_n(l'_i)), n \in \mathbf{N}$ converges to collections of stable and unstable leaves which form a path from the point a_{i_1} to b_{i_1} . The paths are alternatively stable/unstable with i . This is a contradiction to the second property stated in Proposition 6.3. This proves claim (2).

Claim 1 follows immediately from Claim 2 and the fact that $(l_i), i \in \mathbf{N}$ forms a master sequence for x . It now follows that

$$\lim_{n \rightarrow \infty} g_n(x) = z_1, \quad \text{and} \quad \lim_{n \rightarrow \infty} g_n(c) = w_0$$

for every c in $\partial\mathcal{O}$ with $c \neq x$. Suppose first that z_1 is equivalent to the ideal points of l_0 and w_0 is not equivalent to the ideal points of l_0 . Then we are done. What we mean is that if this is true, it proves the conical limit point property for $p = \eta(x)$ with the sequence (g_n) in question. This will be phrased like this throughout the proof of this theorem.

Suppose this is not the case.

Recall that v_0 is the periodic orbit in l_0 .

Push off method – This method keeps the property that $g_n(l_{m_n}) = l_0$ and pushes the limit of $(g_n(x))$ away from the equivalence classes $\mathcal{E}(\partial\mathcal{O}^s(v_0))$ and $\mathcal{E}(\partial\mathcal{O}^u(v_0))$.

Let f_0 be one of the generators of the stabilizer of v_0 and each of its prongs. There is a sequence (k_n) so that $(f_0^{k_n} g_n(x))$ converges to a point z_0 that is not in the equivalence class of $\partial\mathcal{O}^s(v_0)$ or $\partial\mathcal{O}^u(v_0)$ under \sim . Up to a subsequence assume that $(f_0^{k_n} g_n)$ has a source and sink set in $\partial\mathcal{O}$. Then as proved in the arguments of Claim 2, $(f_0^{k_n} g_n(C))$ converges to a point w . If $w \sim \partial\mathcal{O}^s(v_0)$ or $w \sim \partial\mathcal{O}^u(v_0)$, again we are done because z_0 is not equivalent to $\partial\mathcal{O}^s(p_0)$ or to $\partial\mathcal{O}^u(p_0)$. This is the Push off method.

Notice that

$$f_0^{k_n} g_n(l_{i_n}) = g_n(l_{i_n}),$$

so now we can rename g_n to be $f_0^{k_n} g_n$.

We have to deal with the case $z_0 \sim w$. Notice that z_0, w are distinct. We will adjust the sequence (g_n) as needed.

Intermediate set up – At this point we only have to deal with the case that $\lim_{n \rightarrow \infty} g_n(x) = z_0$, $\lim_{n \rightarrow \infty} g_n(C) = w$ and $z_0 \sim w$. In addition $g_n(l_{i_n}) = l_0$ is periodic with periodic point v_0 and $z_0 \not\sim \partial\mathcal{O}^s(v_0)$, $z_0 \not\sim \partial\mathcal{O}^u(v_0)$. Furthermore l_0 separates $g_n(C)$ from z_0 .

Step 3 – For each fixed $i \geq i_0$, then for big enough n , $g_n(A_i)$ does not contain w .

Suppose this is not true. Then there is a fixed j so that for a subsequence $(n_k), k \in \mathbf{N}$, the set $g_{n_k}(A_j)$ contains w . Since $w \sim z_0$ and $z_0 \neq w$, there is a leaf l of \mathcal{O}^s or \mathcal{O}^u with ideal point w .

For each $i \geq j$, then $w \in g_{n_k}(A_i)$. Suppose k big enough, that is, $k \geq k(i)$ depending on i . Since n_k is very big and $g_n(A_i) \rightarrow w$ as $n \rightarrow \infty$ for any $i \geq i_0$, then we have

$$g_{n_k}(\partial l'_i) \text{ separates the ideal points of } l \text{ in } \partial\mathcal{O}.$$

Apply $g_{n_k}^{-1}$. Notice that $w \in g_{n_k}(A_j)$ for the fixed j . Hence $r_i = g_{n_k(i)}^{-1}(l)$ intersects both l'_j which is fixed and l'_i . For i big, l'_j and l'_i do not share ideal points. Therefore the sequence $(r_i), i \in \mathbf{N}, i > j$ cannot escape compact sets in \mathcal{O} and has a convergent subsequence to a collection of leaves non separated from each other. As ∂l_i shrinks to x when $i \rightarrow \infty$, then by the escape lemma, one of the limits leaves has to have ideal point x . This is a contradiction to the hypothesis in the main case. This proves Step 3.

We now consider the unique minimal chain $\mathcal{T} = \{e_1, \dots, e_{k_0}\}$ from w to z_0 so that consecutive leaves share an ideal point and w is an ideal point of e_1 and z_0 and ideal point of e_{k_0} . We consider the curves e_k as slice leaves in leaves of \mathcal{O}^s or \mathcal{O}^u .

Step 4 – We may assume that every leaf in the minimal chain $\mathcal{T} = \{e_k, 1 \leq k \leq k_0\}$ is separating for this collection: e_k separates $e_{k'}$ from $e_{k''}$ if $k' < k < k''$.

Suppose this is not true. Then there is a fixed k so that e_k does not separate e_{k-1} from e_{k+1} .

There is a component U of $\mathcal{O} - e_k$ which contains both e_{k-1} and e_{k+1} . We will assume without loss of generality that e_k is a stable leaf. Suppose first that e_k does not make a perfect fit with say e_{k-1} . Since e_k and e_{k+1} share an ideal point in $\partial\mathcal{O}$, there is at least one other leaf of \mathcal{O}^s or \mathcal{O}^u with this ideal point and which separates e_k from e_{k-1} . It follows that e_k is non separated from some leaf in \mathcal{O}^s , and in particular e_k is periodic. Suppose now that e_k makes a perfect fit with both e_{k-1} and e_{k+1} . Since e_k does not separate these other two leaves the three leaves e_k, e_{k-1}, e_{k+1} form a double perfect fit. By Proposition 4.6 all three leaves are periodic. It follows that in either case e_k is in the union of the boundary of two adjacent lozenges C_1 and C_2 , see fig. 17. It may be that e_k is singular. Then e_k does not have a prong contained in U .

Up to switching C_1, C_2 we have the following properties: either e_{k-1} has a half leaf in the boundary of C_1 or there is a leaf containing a side of C_1 and separating C_1 from e_{k-1} . Similarly for e_{k+1} and a half leaf in the boundary of C_2 . There are two stable leaves S_1, S_2 distinct from e_k so that S_1 has a half leaf in the boundary of C_1 and similarly for S_2 . There is an unstable leaf u_1 which has a half leaf in the boundary of both C_1 and C_2 , see fig. 17.

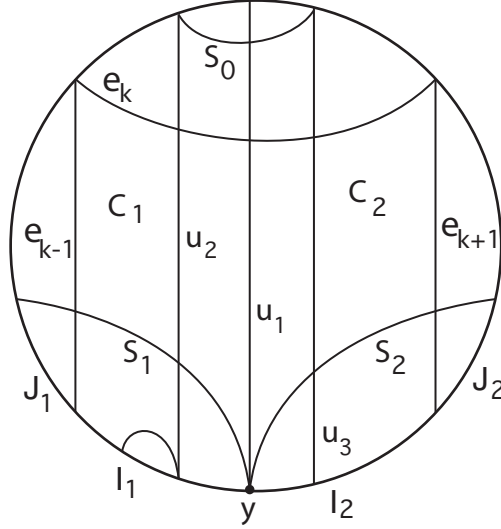

Figure 17: *The situation where e_k does not separate e_{k-1} from e_{k+1} . The figure illustrates the pair of adjacent lozenges barrier method. The adjacent lozenges here are C_1, C_2 . The leaves S_1, S_2 are non separated from each other and contain sides in the lozenges S_1, S_2 respectively.*

To prove Step 4 we employ a method that will be used many times in the proof of the theorem. The method is called the pair of adjacent lozenges barrier method.

The pair of adjacent lozenges barrier method – This method uses the pair of adjacent lozenges C_1, C_2 , and it produces another sequence (g'_n) in $\pi_1(M)$ which shows the conical limit point property for $p = \eta(x)$. This will be done by showing that the limits of $(g'_n(x))$ and $(g'_n(C))$ cannot be equivalent, because any hypothetical chain connecting them cannot “cross the barrier” of the adjacent lozenges C_1, C_2 .

Let y in $\partial\mathcal{O}$ be the ideal point of u_1 which is in the boundary of both C_1 and C_2 . For simplicity of exposition we will assume that all leaves $e_{k-1}, e_{k+1}, S_1, S_2$ are non singular. We will also assume that e_{k-1} and e_{k+1} have half leaves in the boundary of C_1, C_2 respectively. The same proof holds in general. Let $Z_i, i = 1, 2$ be the intervals in $\partial\mathcal{O} - \partial S_i$ not containing any point of ∂e_k . Let I_i be the open interval of Z_i with one endpoint y and the another in either ∂e_{k-1} or ∂e_{k+1} . Let J_i be the interior of $Z_i - I_i$. The path \mathcal{T} goes from w to z_0 as k increases. Then for any j and for any n big:

$$g_n(A_j) \subset J_1 \text{ or } I_1 \quad \text{and} \quad g_n(x) \in I_2 \text{ or } J_2.$$

This is because $g_n(A_j) \subset Z_1$ for n big, $g_n(x) \in Z_2$ for n big and $g_n(x)$ is not an ideal point of any leaf and by Step 3 the ideal point of e_{k-1} is not in $g_n(A_j)$ for n big. Here we let f be a generator of the stabilizer of C_1 and C_2 . Post composing g_n with powers f^{i_n} of f , we may assume that the sequence $(f^{i_n} g_n(x))$ converges to $z_2 \not\sim z_0$ and in addition $z_2 \not\sim y$. This is saying that $z_2 \notin \mathcal{E}(y) \cup \mathcal{E}(z_0)$, which is possible by the Push off method. In addition the limit of $(f^{i_n} g_n(x))$ is in J_2 or I_2 . As before we can assume that the sequence $(f^{i_n} g_n)$ has a source and sink and therefore $(f^{i_n} g_n(\partial\mathcal{O} - \{x\}))$ converges locally uniformly to a point w_1 which is in \bar{Z}_1 . If $w_1 \sim z_0$ or $w_1 \sim y$ then we are done, because then $\lim f^{i_n} g_n(x) = z_2$, $\lim f^{i_n} g_n(t) = w$ for any $t \neq x$; and $z_2 \not\sim z_0, z_2 \not\sim y$, while either $w_1 \sim z_0$ or $w_1 \sim y$. This would prove the conical limit point property for $p = \eta(x)$.

Hence we can assume that $w_1 \not\sim z_0$. The goal is to show that $w_1 \not\sim z_2$. This will prove the conical limit point property for $p = \eta(x)$ and finish the proof of Step 4.

Suppose first that w_1 is in I_1 . There has to be a chain \mathcal{V} of slice leaves, consecutive ones making perfect fits or same ideal points so that this chain connects w_1 to z_2 . We refer to fig. 17.

Since $w_1 \sim z_2$ and $z_2 \not\sim y$ and $z_2 \not\sim z_0$, then the ideal points of the chain \mathcal{V} cannot go through y . Hence the chain has to intersect S_1 transversely. This intersection is contained in the unstable leaf u_2 which is part of the chain \mathcal{V} . Since C_1 is a lozenge then u_2 intersects e_k also, see fig. 17. Some subsequent leaf in the chain \mathcal{V} has to be stable and has to intersect the unstable leaf u_1 - otherwise the chain will not be able to go to the other component of $\mathcal{O} - u_1$ which contains z_2 in its ideal boundary. Let this stable leaf in the chain be denoted by S_0 . If for example z_2 is in J_2 the only possibility is that the chain \mathcal{V} has to first have an ideal point in I_2 and then cross S_2 to have an ideal point in J_2 . So in any case \mathcal{V} has an ideal point in I_2 . So the next leaf in \mathcal{V} has to be unstable, call it u_3 . In addition u_3 has to intersect e_k (and hence S_2). The construction implies that the stable leaf containing S_0 does not have a prong in the component of $\mathcal{O} - S_0$ containing e_k . Again by Proposition 4.6, u_2, u_3 and S_0 are periodic and on the boundary of two adjacent lozenges C_3 and C_4 .

This is an impossible situation and that is the barrier method. Here is why: Let u_4 be the unstable leaf which has a half leaf in the boundary of both C_3 and C_4 . If u_4 intersects C_2 then u_4 cannot make a perfect fit with any stable leaf l^* intersecting u_2 - because of the adjacent lozenges C_1 and C_2 . We explain this. Since l^* makes a perfect fit with u_4 and u_4 has ideal point in I_2 then l^* is contained in the component of $\mathcal{O} - S_2$ limiting on x . Since S_2 separates this component from u_2 then l^* cannot intersect u_2 . This is a contradiction. If on the other hand u_4 intersects C_1 , then u_4 cannot make a perfect fit with a stable leaf l^* intersecting u_3 , also contradiction. If u_4 and u_1 are in the same unstable leaf, then the periodic orbits are the same and $S_0 = e_k$, also leading to a contradiction. We conclude that this case cannot occur.

The second possibility here is that w_1 is in J_1 . By a similar argument, the path from w_1 to z_2 has a leaf u_2 intersecting S_1 . If this intersection is in the closure of C_1 then we apply the proof of the first situation. But here it may be that u_2 does not intersect C_1 - that is, u_2 is contained in the component of $\mathcal{O} - e_{k-1}$ disjoint from C_1 . If this happens then the next leaf in the path \mathcal{V} is stable (S') and has to intersect both lozenges C_1 and C_2 , as well as the leaf e_{k+1} . The next leaf (u_3) in the path \mathcal{V} has to be unstable and S' does not separate u_2 from u_3 . Then as in the first possibility S', u_2 and u_3 have half leaves in the boundary of the union of 2 adjacent lozenges C_3, C_4 . An argument exactly as in the first possibility shows this is not possible.

These arguments show that $w_1 \not\sim z_2$ and hence in this case $p = \eta(x)$ is a conic limit point.

Therefore we may assume from now on that Step 4 holds.

Remark - The barrier method uses that two pairs of adjacent lozenges C_1, C_2 and D_1, D_2 cannot intersect in certain ways as disallowed in the proof of Step 4. However it is not true that they cannot always intersect: it could be that D_1 intersects both C_1 and C_2 but D_2 does not intersect either of them. We will have to rule out this possibility in future uses of the barrier method.

Step 4.a - In the same way we may assume that e_k makes a perfect fit with e_{k+1} for every k .

This means that there is no leaf e sharing an ideal point with both e_k and e_{k+1} and separating them. If that were the case, a proof entirely analogous to Step 4 would show that $p = \eta(x)$ is a conical limit point. It is even harder for the corresponding chain \mathcal{V} to go from w_1 to z_2 .

Claim 3 - The chain \mathcal{T} from w to z_0 has to have length at least 2.

Roughly this is because for n big, $g_n(x)$ is close to z_0 and $g_n(C)$ is close to w . If \mathcal{T} has length one then \mathcal{T} is a slice in a single leaf of \mathcal{O}^s or \mathcal{O}^u . By the pushoff method we know that z_0 is not an ideal point of $\mathcal{O}^s(v_0)$ or $\mathcal{O}^u(v_0)$. So if \mathcal{T} contains either of these leaves, then \mathcal{T} will have length at least two. Suppose then that $\mathcal{O}^s(v_0)$ and $\mathcal{O}^u(v_0)$ are not part of the chain \mathcal{T} . Recall that $l_0 = g_n(l_{m_n})$. If l_{m_n} is chosen according to possibility 1) of Step 1, then the chain \mathcal{T} has to cross at least 2 prongs of v_0 : at least one stable and one unstable prong of v_0 . This implies that the chain \mathcal{T} cannot have length one, because a single leaf of \mathcal{O}^s or \mathcal{O}^u could not cross both of these leaves. If on the other hand l_{m_n} is chosen according to possibility 2) of Step 1, then the chain \mathcal{T} has to cross a pair of leaves forming a perfect fit, one of which is l_0 and the other is $g_n(s)$ - where s is the leaf described in possibility 2) of Step 1. This proves claim 3.

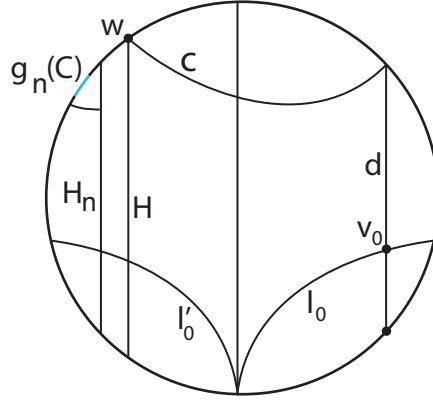

Figure 18: *The leaves H, c, d are in the boundary of adjacent lozenges C_1, C_2 . The position of the leaves H_n forces the next leaf in the path $g_n(\mathcal{P})$ to be l'_0 and l_0 .*

The intermediate setup is that $z_0 \not\sim \partial l_0$. Therefore l_0 cannot be part of the chain \mathcal{T} , but \mathcal{T} has to cross l_0 . Let z be the first ideal point of the chain \mathcal{T} attained after crossing the leaf l_0 . Let \mathcal{T}_0 be the subpath of \mathcal{T} from w to z .

The proof of Claim 3 shows that \mathcal{T}_0 has length at least 2.

Claim 4 – We may assume that the line leaf l_0^* of l_0 which separates $g_n(x)$ from $g_n(C)$ intersects some leaf e_{k_1} of \mathcal{T}_0 transversely.

This is stronger than l_0 intersects a leaf of \mathcal{T}_0 transversely. Suppose that the claim is not true. If l_0 shares an ideal point with a leaf of \mathcal{T}_0 , then $\partial l_0 \sim w$. But $(g_n(C))$ converges to w and $(g_n(x))$ converges to a point $z_0 \not\sim \partial l_0$. This proves the conical limit point property for $p = \eta(x)$.

So we may assume that l_0 does not share an ideal point with a leaf in \mathcal{T} . Therefore the union of the leaves in \mathcal{T} is contained in a single complementary component V of l_0^* in \mathcal{O} . Notice that l_0^* separates $g_n(C)$ from $g_n(x)$, so it now follows that \mathcal{T} cannot be contained V . This complementary component V does not limit on $z_0 = \lim_{n \rightarrow \infty} g_n(x)$ because l_0^* separates \mathcal{T} from $g_n(x)$ and $z_0 \notin \partial l_0$. This contradicts the fact that the chain \mathcal{T} connects w to z_0 .

This proves Claim 4.

Let k_1 so that l_0^* intersects e_{k_1} transversely. Obviously $k_1 \leq k_0$, the length of \mathcal{T} . Here k_1 is the length of the chain \mathcal{T}_0 , so we know that $k_1 \geq 2$. For simplicity for the rest of the proof let

$$d = e_{k_1}, \quad c = e_{k_1-1}$$

Since l_0 intersects d transversely, then d is an unstable leaf and c is a stable leaf.

Recall that $l_0 = g_n(l_{m_n})$ for a subsequence (m_n) in \mathbf{N} . Consider the previous step in $g_n(\mathcal{P})$, that is, the leaf $g_n(l_{m_n-1})$, which we denote here by H_n . We will do this operation many times in the proof of theorem 7.1. We stress that the path $g_n(\mathcal{P})$ is standard from $g_n(l_1)$ to $g_n(x)$. In other words $g_n(l_{m_n-1})$ determines $g(l_{m_n})$ but not the other way round. So whenever we consider a previous leaf in $g_n(\mathcal{P})$ such as $g_n(l_{m_n-1})$ we will discuss the 3 options of Step 1 to obtain $g_n(l_{m_n})$ from $g_n(l_{m_n-1})$.

Let U be the component of $\mathcal{O} - c$ which limits in z .

Claim 5 – We can assume that the leaves H_n intersect c .

Suppose that this is not true. Recall that $H_n = g_n(l_{m_n-1})$ either intersects l_0 , or makes a perfect fit with l_0 or intersects a leaf non separated from l_0 . Therefore H_n intersects U as l_0 is contained in U .

Since H_n does not intersect c then it is contained in U . Recall that H_n has a line leaf separating $g_n(x)$ from $g_n(C)$. Since the sequence $(g_n(C))$ converges to w , it now follows that $k_1 = 2$, $c = e_1$, $d = e_2$ and w is an ideal point of c . In addition H_n has an ideal point y_n so that the sequence (y_n) converges to w . Since

H_n satisfies one of the 3 conditions of the previous paragraph, it follows that (H_n) converges to a leaf H making a perfect fit with c and so that c does not separate H from d . This is because all H_n intersect a leaf which does not share an ideal point with c . Hence the sequence (H_n) cannot escape compact sets in \mathcal{O} . Then H, c, d form a double perfect fit, see fig. 18. By Proposition 4.6, there are adjacent lozenges C_1, C_2 both with a side in c and other sides respectively in H and d . If $l_0 = g_n(l_{m_n})$ is obtained from the previous step by option 1 of Step 1, then the following happens. The leaf l_0 is singular and intersects both H and d , and l_0 has a singularity between $H \cap l_0$ and $d \cap l_0$. This was disallowed in the proof of Proposition 4.6. Therefore l_0 is obtained using Option 2 of Step 1 and there is $l'_0 = g_n(s_{m_n})$ non separated from l_0 and intersecting H_n . Analysing the interaction of this with the two adjacent lozenges C_1, C_2 one sees that the only possibility is that l_0 and l'_0 contain sides of C_2 and C_1 respectively, see fig. 18. In this situation $(g_n(C))$ converges to w in ∂H . But $\partial H \sim \partial c \sim \partial d$. Since d has a side in the boundary of the lozenge C_2 as does l_0 and l_0 is periodic with periodic orbit v_0 , it follows that $l_0 = \mathcal{O}^s(v_0)$, $d = \mathcal{O}^u(v_0)$. In addition v_0 is a corner of C_2 , see fig. 18. This implies that $w \sim \partial \mathcal{O}^u(v_0)$. Since $z_0 \not\sim \partial \mathcal{O}^u(v_0)$ by the push off method, this proves the conical limit point property for $p = \eta(x)$.

This proves Claim 5. Therefore from now on, we can assume that H_n intersects c for all n .

Notice the following fact. It may be that H_n intersects l_0 if $l_0 = g_n(l_{m_n})$ is chosen according to Option 1 of Step 1, but in any case H_n does not intersect the line leaf l_0^* of l_0 . In particular no subsequence of (H_n) can converge to the leaf d .

In Step 3 we proved that we can assume $w \notin g_n(C)$ for n sufficiently big.

Now there are two options depending on whether the subchain \mathcal{T}_0 has length 2 or higher.

Case A – The chain \mathcal{T}_0 has length 2.

Here $\mathcal{T}_0 = \{c, d\}$. Here w is an ideal point of $c = e_1$ and z is an ideal point of $d = e_2$.

Now we will consider the preceding leaves in $g_n(\mathcal{P})$, that is, the leaves $g_n(l_{m_n-2})$.

Claim 6 – The sequence $(g_n(l_{m_n-2}))$ escapes compact sets and therefore converges to w .

We have the following facts. 1) The leaf $g_n(l_{m_n-2})$ has a line leaf separating $g_n(C)$ from $g_n(x)$, 2) $(g_n(C))$ converges to w and does not contain w for n big, 3) w is an ideal point of c and $g_n(l_{m_n-2})$ is disjoint from c – since $g_n(l_{m_n-1})$ intersects c by Claim 5.. Therefore $g_n(l_{m_n-2})$ has an ideal point, call it q_n , so that (q_n) converges to w .

Suppose that the sequence $(g_n(l_{m_n-2}))$ does not escape in \mathcal{O} . Then up to subsequence it converges to a stable leaf t .

Suppose first that $t = c$. Since no subsequence of (H_n) can converge to d , then this can only happen if $g_n(l_{m_n-2})$ is not contained in U . Here we initially deal with the case that c is singular. Then there is a singular orbit v_2 in c . As $(g_n(l_{m_n-2}))$ converges to c it now follows that for all n big $H_n = \mathcal{O}^u(v_2)$, and in addition $H_n = g_n(l_{m_n-1})$ is obtained by option 1 in Step 1. Also v_2 is a corner of a lozenge C^* which has one side in a half leaf of d and a corner v_3 that is the periodic orbit in d . It follows that this lozenge has a stable side in $\mathcal{O}^s(v_3)$. In particular the construction of the standard path $g_n(\mathcal{P})$ implies that the next leaf of $g_n(\mathcal{P})$ has to be $\mathcal{O}^s(v_3)$ as this separates $g_n(x)$ from c (and hence from $g_n(C)$). This is the leaf $l_0 = g_n(l_{m_n}) = \mathcal{O}^s(v_3)$. Finally $\mathcal{O}^s(v_3)$ makes a perfect fit with $H_n = g_n(l_{m_n-1})$. This means that $l_0 = l_{m_n}$ is chosen according to option 3 in Step 1. But we specifically picked out the subsequence (m_n) so that in each step $m_n - 1$ either options 1 or 2 is used to produce the next leaf. We conclude that this cannot happen and hence c is non singular in this setting.

We now have that $(g_n(l_{m_n-2}))$ converges to the full leaf c . Since c makes a perfect fit with d this would imply that $(g_n(l_{m_n-1}))$ converges to the leaf d . This was disallowed just before the statement of Case A.

We conclude that $t \neq c$. But t, c share an ideal point. Hence there is a leaf t' (possibly $t' = t$) so that t' is non separated from c and c, t, t' have an ideal point in common. In addition t is the limit of leaves intersecting H_n , or leaves making a perfect fit with H_n or leaves non separated from H_n . Since H_n intersects c this is impossible.

Therefore the sequence $(g_n(l_{m_n-2}))$ escapes compact sets in \mathcal{O} . In particular $(g_n(l_{m_n-2}))$ has to converge to w . This proves Claim 6.

End of the analysis of Case A

Since the sequence $(g_n(l_{m_n-2}))$ converges to w , we claim that this implies that H_n has an ideal point q_n so that (q_n) converges to w . This is clear if $H_n = g_n(l_{m_n-1})$ is produced by either option 1 or option 3 of Step 1. Suppose that $g_n(l_{m_n-1})$ is produced by option 2, so there are two leaves $g_n(u_{m_n-1})$ and $g_n(l_{m_n-1})$ which are non separated from each other. The first sequence has ideal points converging to w as they intersect $g_n(l_{m_n-2})$. This implies that they cannot be eventually constant and so one of them has to escape compact sets in \mathcal{O} . Since H_n intersects c then the sequence $(H_n = g_n(l_{m_n-1}))$ does not escape compact sets in \mathcal{O} .

This implies that the sequence $(g_n(u_{m_n-1}))$ escapes compact sets in \mathcal{O} , for otherwise we obtain a contradiction as in the end of the proof of claim 6. This now implies that H_n has an ideal point which converges to w as $n \rightarrow \infty$. This in turn implies that the sequence $(H_n \cap c)$ converges to w .

We have so far proved that (H_n) does not escape compact sets in \mathcal{O} , and $(H_n \cap c)$ converges to w . Then the arguments in the proof of Claim 5 imply the conical limit point property for $p = \eta(x)$.

This finishes the analysis of Case A.

Case B – The chain \mathcal{T}_0 from w to z has length ≥ 3 .

Why is this different from the situation in Case A? The crucial property in Case A was that the sequence $(H_n \cap c)$ escapes in c (recall that $c = e_1$ in that case). This was obtained because w is an ideal point of $e_1 = c$ and $(g_n(C))$ converges to w . In case B the point w is not an ideal point of $c = e_{k_1-1}$. A priori the fact that $(g_n(C))$ converges to w gives no information concerning the sequence $(H_n \cap c)$. Conceivably $(H_n \cap c)$ is not escaping in c and perhaps (H_n) is even constant. Conceivably H_n could be a fixed singular leaf with one prong intersecting e_{k_1-1} and a line leaf separating $g_n(C)$ from $g_n(x)$. A priori this structure is certainly possible. In the same way, conceivably $(g_n(l_{m_n-2}))$ could be a constant sequence which is a fixed singular leaf with a line leaf separating $g_n(C)$ from $g_n(x)$ and intersecting H_n and also with a prong intersecting $g_n(e_{k_1-3})$; and so on. The information we have in Case B is that $(g_n(C))$ converges to w which is an ideal point of e_1 . Therefore we need to start with the leaf e_1 and proceed to $e_i, i \geq 1$.

As in Case A, we denote by c and d the last two leaves of \mathcal{T}_0 . The path of perfect fits \mathcal{T}_0 is

$$\mathcal{T}_0 = \{e_1, e_2, \dots, e_{k_0}\}, \text{ where } e_i, e_{i+1} \text{ share an ideal point.}$$

In addition we proved in Steps 4 and 4.a that e_i separates e_{i-1} from e_{i+1} and e_i, e_{i+1} make a perfect fit. Also $e_{k_0} = d, e_{k_0-1} = c$. The chain \mathcal{T} is chosen to be minimal so that e_{i-1}, e_{i+1} do not share an ideal point. Finally $e_1 \neq c, d$.

Claim 7 – The leaf e_1 is not part of the path $g_n(\mathcal{P})$.

Suppose on the contrary that e_1 is a leaf in the standard path $g_n(\mathcal{P})$ from $g_n(C)$ to $g_n(x)$. Then the following happens: if e_1 is part of the path $g_n(\mathcal{P})$ then the standard path $g_n(\mathcal{P})$ from $g_n(C)$ to $g_n(x)$ will have to follow the chain \mathcal{T} at least until the leaf c . This is because the properties above imply that once e_i is in $g_n(\mathcal{P})$, then e_{i+1} is the next leaf chosen in $g_n(\mathcal{P})$ under option 3 of Step 1. This works until at least $c = e_{k_0-1}$. We do not know if d is chosen because it may not separate $g_n(x)$ from the leaf c (or from $g_n(C)$).

Subclaim – The setting with e_1 in the path $g_n(\mathcal{P})$ implies that l_0 cannot be part of the path $g_n(\mathcal{P})$ which is contrary to the set up that l_0 is always a leaf in $g_n(\mathcal{P})$.

To prove that l_0 is not part of $g_n(\mathcal{P})$, suppose first that d is not the last leaf of \mathcal{T} (so $\mathcal{T} \neq \mathcal{T}_0$). Then $(g_n(x))$ converges to z_0 which is not z and d separates $g_n(x)$ from $g_n(C)$. It follows that d is the next leaf in the path $g_n(\mathcal{P})$ – the one after c , again using option 3 in Step 1. For simplicity of notation let the next leaf in \mathcal{T} after d be denoted by e , that is, $e = e_{k_1+1}$. If e separates $g_n(x)$ from $g_n(C)$, then this leaf

e is also in $g_n(\mathcal{P})$ obtained by option 3 of Step 1. In addition e separates l_0 from $g_n(x)$, and then from then on the leaf l_0 could not be a leaf in $g_n(\mathcal{P})$, contradiction. If on the other hand e does not separate $g_n(x)$ from l_0 , it follows that e is the last leaf in the chain \mathcal{T} and z_0 is an ideal point of e . Since d is in the path $g_n(\mathcal{P})$, and l_0 in $g_n(\mathcal{P})$ intersects d then the next leaf in the path $g_n(\mathcal{P})$ is l_0 . The ideal points of l_0 are not equivalent to z_0 because $z_0 \sim z \sim \partial d$ and $l_0 \cap d \neq \emptyset$. It follows that $(g_n(x))$ cannot converge to z_0 , contradiction.

The other possibility is that d is the last leaf in the path \mathcal{T} , that is, $\mathcal{T} = \mathcal{T}_0$. Then the sequence $(g_n(x))$ converges to z (that is, $z_0 = z$). Let u_n be the next leaf in the path $g_n(\mathcal{P})$ after c . Suppose first that up to subsequence $u_n = d$ for every n . If d is a leaf in the path $g_n(\mathcal{P})$, then d has a line leaf d^* separating $g_n(x)$ from $g_n(C)$. Since l_0^* does not share an ideal point with d , it follows that $g_n(x)$ cannot converge to z_0 , if l_0 is the next leaf in $g_n(\mathcal{P})$, contradiction.

Finally suppose then that $u_n \neq d$ for all n . This implies that d does not separate $g_n(x)$ from c . In addition u_n cannot be produced according to Option 3 of Step 1. This also implies that there is not a leaf τ non separated from d and with τ separating d from $g_n(x)$. Otherwise d would be the next leaf in $g_n(\mathcal{P})$. Also since $(g_n(x))$ converges to $z = z_0$, then the sequence (u_n) converges to d – whether it is produced by Option 1 or Option 2 in Step 1. In addition, if u_n does not intersect l_0 for n sufficiently big, then l_0 cannot be in $g_n(\mathcal{P})$ so this implies that u_n intersects l_0 for all n big. Then the next leaf in the path $g_n(\mathcal{P})$ will separate l_0 from $g_n(x)$. This implies that l_0 cannot be the next leaf in the path $g_n(\mathcal{P})$.

In any of the cases we obtain l_0 is not a leaf in $g_n(\mathcal{P})$, which is a contradiction to the setup. This finishes the proof of the Subclaim and hence proves Claim 7.

In case B let U be the component of $\mathcal{O} - e_1$ which accumulates in z .

Case B.1 – The leaf e_1 separates $g_n(C)$ from $g_n(x)$.

Since e_1 cannot be part of the path $g_n(\mathcal{P})$ and e_1 separates $g_n(C)$ from $g_n(x)$, it follows that there is a leaf F_n in the path $g_n(\mathcal{P})$ which intersects e_1 transversely. Assume first that w is an ideal point of U . Let W be the component of $\mathcal{O} - e_1$ which accumulates in w and is not U .

Let d_n be the previous leaf in the path $g_n(\mathcal{P})$. We may assume up to subsequence that one of the following holds for all n .

- Suppose that this leaf F_n of $g_n(\mathcal{P})$ is obtained from d_n by Option 1 of Step 1. The leaf F_n has a line leaf which separates $g_n(x)$ from $g_n(C)$. Let v_n be the singularity in F_n . Suppose first that v_n is not in W . Then since F_n intersects e_1 , the singularity v_n is in $U \cup e_1$. Since Option 1 of Step 1 is used to choose F_n then F_n intersects d_n .

The first possibility is that v_n is in U . Then all the other prongs of F_n which do not intersect e_1 are contained in U . As d_n is not contained in U then the prong of F_n not contained in U is the one intersecting d_n . It follows that the line leaf of F_n separating $g_n(C)$ from $g_n(x)$ is contained in U and in fact would separate $g_n(x)$ from e_2 as well, a contradiction to the property of e_2 . Therefore v_n cannot be in U for n big enough.

The second possibility is that v_n is in e_1 . Then (v_n) and hence (H_n) are constant sequences. In particular in this case all the leaves e_i are periodic and have periodic orbits which will be denoted by z_i . In addition the $\{z_i\}, 1 \leq i \leq k_0$ are connected by a chain of lozenges $\{C_i, 1 \leq i < k_0\}$ so that C_i has corners in z_i and z_{i+1} . For the sake of argument suppose that e_1 is a stable leaf, hence $e_1 = \mathcal{O}^s(z_1)$. Here d_n intersects F_n (and F_n is independent of n), while also separating $g_n(C)$ from $g_n(x)$. Since the sequence $(g_n(C))$ converges to w , it follows that d_n has an ideal point t_n so that the sequence t_n converges to w when $n \rightarrow \infty$.

Special subcase –

Suppose first that (d_n) does not escape compact sets. Then it converges to a leaf d^* which has an ideal point w and either intersects F_n or has an ideal point distinct from w which is equivalent to the ideal points of F_n . This is only possible if d^* is the leaf e_1 , and in that case d^* intersects F_n for

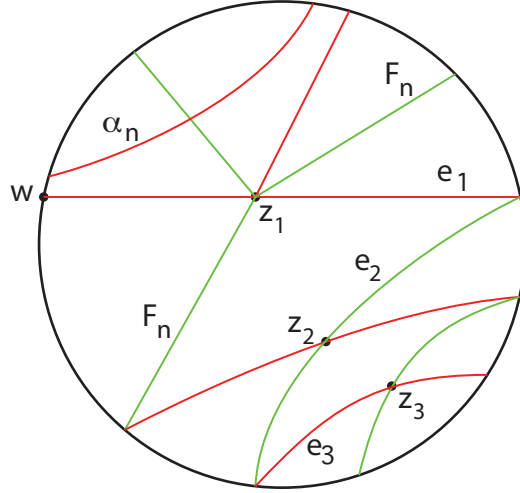

Figure 19: *This depicts the situation in the special subcase. Without loss of generality assume that e_1 is stable. Then e_2 is unstable, e_3 is stable and so on. Here $e_1 = \mathcal{O}^s(z_1)$. Also $F_n = \mathcal{O}^u(z_1)$ is in the path $g_n(\mathcal{P})$ as are $\mathcal{O}^s(z_2)$, $\mathcal{O}^u(z_3)$ and so on. In this figure the stable leaves are red and the unstable ones are green.*

n big, see fig. 19. Since e_1 is singular, this now implies that $\mathcal{O}^u(z_1)$ has a line leaf which separates $g_n(C)$ from $g_n(x)$. As (d_n) converges to e_1 , it now follows that $\mathcal{O}^u(z_1)$ is in $g_n(\mathcal{P})$ for any n big enough, that is, $F_n = \mathcal{O}^u(z_1)$ for n big. Then the lozenge C_1 implies that the next leaf in $g_n(\mathcal{P})$ is $\mathcal{O}^s(z_2)$. Notice here that $\mathcal{O}^u(z_2) = e_2$ is in \mathcal{T} . In the same way the next leaf in $g_n(\mathcal{P})$ is $\mathcal{O}^u(z_3)$, whereas $\mathcal{O}^s(z_3) = e_3$ is in \mathcal{T} . All of these leaves of $g_n(\mathcal{P})$ are obtained using option 3 of Step 1. Proceeding by induction on i it follows that the leaf of $g_n(\mathcal{P})$ that intersects d is $\mathcal{O}^s(z_{k_0})$ (because d is an unstable leaf) and $d = \mathcal{O}^u(z_{k_0})$. But recall that this leaf of $g_n(\mathcal{P})$ is l_0 and we proved here it is obtained using option 3 of Step 1. But this contradicts the setup constructing l_0 . It follows that this is impossible.

We conclude that the only possibility here is that v_n is in W . As above consider the previous leaves d_n in $g_n(\mathcal{P})$. Suppose first that the sequence (d_n) does not escape compact sets in \mathcal{O} . As in the analysis above $(g_n(C))$ converges to w , which implies that the leaves d_n have ideal points converging to w , which implies that (d_n) converges to e_1 . The difference here is that perhaps the leaf e_1 is not singular, or more to the point that e_1 is not periodic, so we do not a priori have lozenges $\{C_i\}$ as in the previous argument. But if (d_n) converges to e_1 and e_1 is not singular, then the next leaves in the path (the F_n) have to converge to e_2 . So here the conclusion is that (F_n) converges to e_2 .

At this point we know that either (d_n) escapes compact sets in \mathcal{O} or if not then (F_n) converges to e_2 .

We analyse further the possibility that (d_n) escapes compact sets in \mathcal{O} . Since F_n intersects e_1 for all n , this shows that the sequence $(F_n \cap e_1)$ converges to w . Suppose first that $(F_n \cap U)$ does not escape in \mathcal{O} then it limits to a leaf e_0 making a perfect fit with e_1 and so that e_1 does not separate e_0 from e_2 . By proposition 4.6 this produces two adjacent lozenges C_1, C_2 , each with a side in a half leaf of e_1 . The analysis of Case A.1 proves the conical limit point property for $p = \eta(x)$ because as in Case A.1 this setup implies that w is equivalent to either $\partial\mathcal{O}^u(v_0)$ or $\partial\mathcal{O}^s(v_0)$, where v_0 is the periodic orbit in l_0 . So if (d_n) escapes compact sets in \mathcal{O} we can assume that $(F_n \cap U)$ escapes compact sets in \mathcal{O} .

The final conclusion in this case is that either $(F_n \cap U)$ escapes compact sets in \mathcal{O} or (F_n) converges to e_2 .

- Suppose that F_n is obtained by option 2 of Step 1 (non separated leaves). Then similar arguments as in the previous case imply that either the sequence $(F_n \cap U)$ converges to w and therefore escapes

compact sets in \mathcal{O} or (F_n) converges to e_2 .

- Finally in the case that F_n is produced using perfect fits, then as in the first case above we obtain that either the sequence $(F_n \cap U)$ escapes in \mathcal{O} or (F_n) converges to e_2 .

Intermediate conclusion in Case B.1 – We can assume that either $(F_n \cap U)$ escapes in \mathcal{O} or that (F_n) converges to e_2 .

Induction on the leaves e_i

Induction means we are going to analyse the subsequent leaves $\{e_i\}$ in the path $g_n(\mathcal{P})$. First we show the conical limit point property for $p = \eta(x)$ unless the sequence (in n) of subsequent leaves in $g_n(\mathcal{P})$ converges to either e_1 or e_3 . Then we iterate this process.

Subcase 1 – We suppose first that we are in the case that $(F_n \cap U)$ escapes in \mathcal{O} .

The next leaf in the standard path $g_n(\mathcal{P})$ will be denoted by v_n^1 . It has to intersect e_2 since it separates $g_n(C)$ from $g_n(x)$. It is also contained in U . Here v_n^1 either intersects $F_n \cap U$ or v_n^1 is non separated from a leaf intersecting $(F_n \cap U)$ or v_n^1 is non separated from $(F_n \cap U)$. In any case $(F_n \cap U)$ converges to w and it follows that the sequence (v_n^1) limits to e_1 .

The concern is that this sequence (v_n^1) also limits also to another leaf e_1^* making a perfect fit with e_2 and so that e_2 separates e_1^* from e_1 and e_1, e_1^* share an ideal point. Then e_1, e_1^* are in the boundary of two adjacent lozenges D_1, D_2 which have a common side in a half leaf of e_2 . In addition since e_2 makes a perfect fit with e_3 , there is also a lozenge D_3 with sides in e_2 and e_3 . Notice that D_1 and D_2 are adjacent and intersecting a common stable leaf. Also D_2 and D_3 are adjacent and intersecting a common unstable leaf. Here D_1 and D_3 do not intersect a common leaf.

As explained previously we can use a combination of the push off method and the barrier of adjacent lozenges method to show the conical limit point property for $p = \eta(x)$.

We conclude that we can assume that (v_n^1) limits only to e_1 .

Intermediate conclusion – In Case B.1 with $(F_n \cap U)$ escaping in \mathcal{O} , we can now assume that the sequence (v_n^1) limits only to e_1 .

Now we iterate the process. Let $b_i \in \partial\mathcal{O}$ be the common ideal point of e_i and e_{i+1} . By induction we will show that if the leaf v_n^k is the k -th leaf after F_n in $g_n(\mathcal{P})$, then (v_n^k) converges to e_k . We also assume that (v_n^k) has ideal points y_n so that (y_n) converges to b_k . Here v_n^k intersects e_{k+1} . This has been proved for $k = 1$, so suppose it is true for $k - 1$ where $k < k_0$. We claim that the next leaf v_n^k has to intersect e_{k+1} . Otherwise e_{k+1} separates $g_n(x)$ from v_n^k and from further leaves in $g_n(\mathcal{P})$. This is a contradiction because $(g_n(x))$ converges to z_0 and $k + 1 \leq k_0$. Suppose that e_k is non separated from another leaf e_k^* so that e_k, e_{k+1} and e_k^* share the ideal point b_i and e_{k+1} separates e_k from e_k^* . Then as before e_k, e_k^* are sides in adjacent lozenges C'_1, C'_2 . Then the push off method and the barrier method of adjacent lozenges can be used to show the conical limit point property for $p = \eta(x)$. This shows that we can assume that (v_n^k) converges only to e_k .

The induction works that for all $k \leq k_1 - 1$. For $k = k_1 - 1$ this means that $(v_n^{k_1-1})$ converges to $e_{k_1-1} = c$ and $v_n^{k_1-1}$ intersects $e_{k_1} = d$. Since there is only one leaf in $g_n(\mathcal{P})$ intersecting d transversely, it follows that for all n big $v_n^{k_1-1} = l_0$. This contradicts the fact that $(v_n^{k_1-1})$ converges to e_{k_1-1} .

This finishes the proof of Subcase 1.

Subcase 2 – Suppose now that the sequence (F_n) converges to e_2 .

Here we let $v_n^2 = F_n$ and as in Subcase 1 we let the subsequent leaves in $g_n(\mathcal{P})$ be denoted by v_n^i where $i \geq 3$. Suppose first that no subsequence of (v_n^3) is constant and equal to e_3 . It follows that the leaves v_n^3 have to intersect e_2 . Suppose that $(v_n^3 \cap e_2)$ does not escape in e_2 and converge to a point y . This contradicts the fact that $(g_n(x))$ converges to z_0 which is either an ideal point of e_3 or e_3 separates it from $\mathcal{O}^s(y)$ and $\mathcal{O}^u(y)$. The fact that v_n^3 intersects e_2 also implies that e_3 does not separate $g_n(x)$ from $g_n(C)$. It follows that $z = z_0$ is an ideal point of e_3 and $d = e_3$. Recall that l_0 intersects d transversely. It

follows that v_n^3 intersects l_0 for n big enough. As seen in the proof of the Subclaim of Claim 7 this leads to a contradiction that $(g_n(x))$ cannot converge to z_0 .

The other possibility is that up to subsequence $(v_n^3) = e_3$. Then proof proceeds exactly as in Subcase 1.

The other option here is that w is not an ideal point of the region U . This forces e_1 to be singular with singular point denoted by z_1 . It follows that the sequence (F_n) converges to $\mathcal{O}^u(z_1)$. In addition it follows that all e_i are periodic leaves and let z_i be the periodic point in e_i . These points are connected by lozenges C_i from z_i to z_{i+1} . This is depicted in figure 19 associated with the proof of the Special subcase. Notice however that unlike in the Special subcase, $F_n \neq \mathcal{O}^u(z_1)$, but we only have that the sequence (F_n) converges to $\mathcal{O}^u(z_1)$. But similar to the proof of the Special subcase it now follows that the following leaves in $g_n(\mathcal{P})$ (for each n) converge to $\mathcal{O}^s(z_2)$ when n converges to infinity. The following leaves in $g_n(\mathcal{P})$ converge to $\mathcal{O}^u(z_3)$ and so on. Proceeding in this manner we eventually get that a sequence with leaves in $g_n(\mathcal{P})$ converges to the leaf d . So for n big enough the next leaf in $g_n(\mathcal{P})$ cannot be l_0 , and this contradicts the fact that l_0 is a leaf in $g_n(\mathcal{P})$ for every n . This finishes the proof in this case.

This finishes the analysis of Subcase 2 and hence of Case B.1.

The final case to be analyzed is the following:

Case B.2 – The leaf e_1 does not separate $g_n(C)$ from $g_n(x)$.

Since e_1 makes a perfect fit with e_2 and $g_n(C)$ is in the same component U of $(\mathcal{O} - e_1)$ limiting on $g_n(x)$, then the canonical path $g_n(C)$ to $g_n(x)$ need not intersect e_1 . But it has to intersect e_2 . Suppose that up to subsequence e_2 is a leaf of $g_n(\mathcal{P})$. Then e_i is a leaf of $g_n(\mathcal{P})$ for $2 \leq i < k_1$. If $d = e_{k_1}$ separates $g_n(x)$ from $g_n(C)$ then d is the next leaf in $g_n(\mathcal{P})$ and as in the proof of Case B.1, Subcase 1 this contradicts the fact that l_0 is in $g_n(\mathcal{P})$. If on the other hand $d = e_{k_1}$ does not separate $g_n(x)$ from $g_n(C)$, then $k_0 = k_1$ and d is the last leaf of \mathcal{T} . Since $g_n(x)$ converges to an ideal point of d and l_0 intersects d transversely, this leads to a contradiction as in the proof of Case B.1, Subcase B.1.

We assume from now on that e_2 is not a leaf of $g_n(\mathcal{P})$ for any n . Let v_n^1 be the leaf in the path $g_n(\mathcal{P})$ intersecting e_2 . The leaves $\{v_n^1\}$ intersect e_2 so they belong to the same foliation as e_1 . The previous leaf in the canonical path $g_n(\mathcal{P})$ are denoted by v_n^0 . The previous leaf to those in $g_n(\mathcal{P})$ are denoted by v_n^{-1} .

Claim 8 – The sequence (v_n^{-1}) converges to w .

These leaves are in the same foliation as e_1 . Since they separate $g_n(x)$ from $g_n(C)$ and e_1 does not separate $g_n(x)$ from $g_n(C)$, then for n big v_n^{-1} is contained in U . In addition since each has a line leaf separating $g_n(C)$ from $g_n(x)$ and $(g_n(C))$ converges to w , then v_n^{-1} has ideal points y_n so that (y_n) converges to w .

Suppose that (v_n^{-1}) does not converge to w . Then it converges to a leaf t which has an ideal point w . Notice that it cannot converge to e_1 as v_n^{-1} does not intersect e_2 . Rather it is the leaves v_n^1 which intersect e_2 . Therefore t, e_1 are non separated and hence periodic. There are two adjacent lozenges C_1, C_2 with sides contained in t, e_1 respectively. In addition since e_1 and e_2 make a perfect fit, then there is a third lozenge C_3 with sides in e_1 and e_2 . All 3 lozenges C_1, C_2, C_3 intersect a common (stable or unstable) leaf. We now employ the arguments in the beginning of the analysis of Case B.1, the first subcase (option 1 in step 1, the special subcase) and arrive at a contradiction concerning how the leaf l_0 in $g_n(\mathcal{P})$ is obtained.

We conclude that (v_n^{-1}) converges to w . This proves claim 8.

Now consider the sequence (v_n^0) . Since (v_n^{-1}) converges to w then no matter which option in Step 1 is used to produce v_n^0 from v_n^{-1} , it follows that v_n^0 has an ideal point r_n with (r_n) converging to w . Suppose first that (v_n^0) does not escape compact sets. Then it converges to a leaf t' with ideal point w and we may assume that t' makes a perfect fit with e_1 . Notice that t' and e_1 are in distinct foliations. Then e_1 does not separate e_2 from t' so t', e_1 and e_2 form a double perfect fit. By Proposition 4.6 there are adjacent lozenges C_1, C_2 so that C_1 has sides contained in t' and e_1 , whereas C_2 has sides contained in e_1, e_2 . Also there are two leaves S_1, S_2 which are non separated from each other and S_1 contains a side of

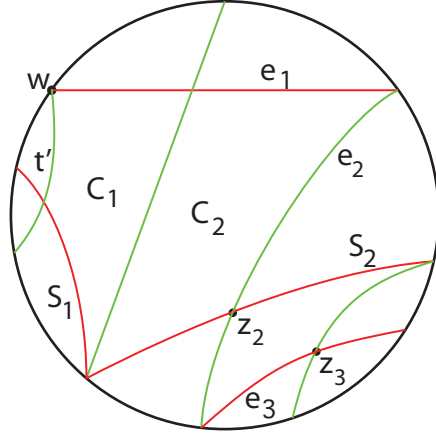

Figure 20: *Case B.2.* Here we produce leaves t', e_1, e_2 forming a double perfect fit. After the first step the argument is very similar to the proof of the Special case. Here again stable leaves are red and unstable leaves are green.

C_1, S_2 contains a side of C_2 . Since (v_n^0) converges to t' and t' intersects S_1 , it follows that the next step in $g_n(\mathcal{P})$ is given by the leaves S_1, S_2 . This means that there is j_n with $S_1 = g_n(u_{j_n}), S_2 = g_n(l_{j_n})$ and $g_n(l_{j_n})$ is obtained using Option 2 of Step 1. In this case the next leaf $g_n(l_{j_n})$ is constant with n . As in the proof of claim 8, using the Special subcase, this leads to a contradiction to how the leaf l_0 of $g_n(\mathcal{P})$ is obtained. See also fig. 20 where we use the periodic orbits z_i in e_i as in the Special subcase.

We conclude that (v_n^0) not escaping compact sets leads to a contradiction. Therefore (v_n^0) escapes compact sets. Since it has ideal points which converge to w , it follows that (v_n^0) converges to w .

Recall that v_n^1 intersects e_2 transversely and they are contained in U . Using that (v_n^0) converges to w it now follows that (v_n^1) converges to e_1 . This is the same as the Intermediate conclusion as in Case B.1. From here on the proof is exactly as in Case B.1.

This finishes the analysis of Case B.2 and therefore of Case B.

This finishes the proof of the uniform convergence theorem. □

This immediately implies part of theorem D:

Corollary 7.2. *If Φ is a bounded pseudo-Anosov flow in M then $\pi_1(M)$ is Gromov hyperbolic and the flow ideal boundary \mathcal{R} is $\pi_1(M)$ equivariantly homeomorphic to the Gromov ideal boundary.*

Proof. Theorem 7.1 shows that $\pi_1(M)$ acts as a uniform convergence group on \mathcal{R} . The space \mathcal{R} is homeomorphic to a sphere, and hence metrisable and perfect. Under these conditions Bowditch [Bow1] proved that $\pi_1(M)$ is Gromov hyperbolic and S_∞^2 is $\pi_1(M)$ equivariantly homeomorphic to \mathcal{R} . □

Notation – The $\pi_1(M)$ equivariant homeomorphism from S_∞^2 to \mathcal{R} is unique as its value is prescribed on fixed points of covering translations and they are dense in S_∞^2 [Gr, Gh-Ha]. This homeomorphism is denoted by $\tau : S_\infty^2 \rightarrow \mathcal{R}$.

8 Flow ideal compactification and equivalent models of compactification of \widetilde{M}

The flow ideal compactification $\widetilde{M} \cup \mathcal{R}$.

Once and for all fix a section $\nu_0 : \mathcal{O} \rightarrow \widetilde{M}$. Also fix a homeomorphism ν_1 from \mathbf{R} to $(-1, 1)$ which is monotone increasing. We define a homeomorphism

$$\nu_2 : \widetilde{M} \rightarrow \mathcal{O} \times (-1, 1)$$

as follows. Given x in \widetilde{M} let $y = \Theta(x)$ and let $t(x)$ be the unique real number so that $x = \widetilde{\Phi}_{t(x)}(\nu_0(y))$. Let now $t_1(x) = \nu_1(t(x))$. Define

$$\nu_2(x) = (\Theta(x), t_1(x))$$

It is immediate that ν_2 is a homeomorphism. We have an induced action of $\pi_1(M)$ on $\theta \times (-1, 1)$ given by conjugation of the action on \widetilde{M} by ν_2 . Now consider the space

$$Z = \mathcal{D} \times [-1, 1] = (\mathcal{O} \cup \partial\mathcal{O}) \times [-1, 1],$$

with the product topology. We are using the topology in \mathcal{D} that was previously defined, making it into a closed disk, and $[-1, 1]$ has the standard topology. In particular

$$\partial Z = \mathcal{D} \times \{-1, 1\} \cup \partial\mathcal{O} \times [-1, 1].$$

We previously defined the topological quotient of ∂Z by the equivalence relation \simeq to be the space \mathcal{R} . The quotient map is denoted by $\zeta : Z = \partial(\mathcal{D} \times [-1, 1]) \rightarrow \mathcal{R}$. Recall the other quotient map $\eta : \partial\mathcal{O} \rightarrow \mathcal{R}$. Define a quotient map

$$\psi : \mathcal{D} \times [-1, 1] \rightarrow \widetilde{M} \cup \mathcal{R}$$

as follows:

$$\begin{aligned} \text{if } x \text{ is in } \mathcal{O} \times (-1, 1) \text{ let } \psi(x) &= \nu_2^{-1}(x), \\ \text{if } x \text{ in } \partial Z \text{ let } \psi(x) &= \zeta(x). \end{aligned}$$

Topology in $\widetilde{M} \cup \mathcal{R}$ – The map ψ is surjective and induces a quotient topology in $\widetilde{M} \cup \mathcal{R}$.

We define an action of $\pi_1(M)$ on $\widetilde{M} \cup \mathcal{R}$ by glueing the actions of $\pi_1(M)$ on \widetilde{M} by covering translations and the action on \mathcal{R} . At this point we only know that the individual actions are continuous. Instead of proving continuity of the joint action it can be immediately derived from Theorem 8.2 to be proved later.

In the last section we proved that if Φ is a bounded pseudo-Anosov flow then $\pi_1(M)$ is Gromov hyperbolic and that \mathcal{R} is $\pi_1(M)$ equivariantly homeomorphic to the Gromov ideal boundary $\partial\pi_1(M) = S_\infty^2$ by a homeomorphism $\tau : S_\infty^2 \rightarrow \mathcal{R}$. We now define

$$f : \widetilde{M} \cup S_\infty^2 \rightarrow \widetilde{M} \cup \mathcal{R}$$

as follows:

$$\text{if } x \in \widetilde{M}, \text{ let } f(x) = x$$

$$\text{if } x \in S_\infty^2, \text{ let } f(x) = \tau(x).$$

We will show that the map f is a $\pi_1(M)$ equivariant homeomorphism.

Lemma 8.1. *The space $\widetilde{M} \cup \mathcal{R}$ is Hausdorff.*

Proof. Let x, y distinct points in $\widetilde{M} \cup \mathcal{R}$. Suppose first that one of them, say x is in \widetilde{M} . Let W_0 be an open neighborhood of x in \widetilde{M} with y not in W_0 . Let W_1 be an open neighborhood of x in \widetilde{M} with

$$x \in W_1 \subset \overline{W_1} \subset W_0,$$

where the closure is in \widetilde{M} . The set $\widetilde{M} \cup \mathcal{R} - \overline{W_1}$ is open in $\widetilde{M} \cup \mathcal{R}$ because its inverse image in $\mathcal{D} \times [-1, 1]$ is $(\mathcal{D} \times [-1, 1]) - \overline{W_1}$, which is open in $\mathcal{D} \times [-1, 1]$. Clearly $y \in (\widetilde{M} \cup \mathcal{R}) - \overline{W_1}$ and $x \in W_1$ (notice W_1 is also open in $\widetilde{M} \cup \mathcal{R}$) hence x, y have disjoint neighborhoods.

From now on suppose that both x, y are in \mathcal{R} . Put a metric d in $\mathcal{D} \times [-1, 1]$ compatible with the topology. Since \mathcal{R} is homeomorphic to a 2-sphere, which is Hausdorff, there are open sets V_0, V_1 of \mathcal{R} with disjoint closures in \mathcal{R} and $x \in V_0, y \in V_1$. Notice that the induced topology from $\widetilde{M} \cup \mathcal{R}$ in \mathcal{R} is

the same topology we defined before in \mathcal{R} . Let $Z_i = \zeta^{-1}(V_i)$ which are open sets in $\partial(\mathcal{D} \times [-1, 1])$, and they have disjoint closures. Therefore in the metric d of $\mathcal{D} \times [-1, 1]$ there is $\epsilon > 0$ so that if $a \in Z_0$ and $b \in Z_1$ then $d(a, b) > 2\epsilon$. For each $t \in Z_i$ choose a ball $B(t, r_t)$ in $\mathcal{D} \times [-1, 1]$ of radius $r_t > 0$ centered at t so that also

$$B(t, r_t) \cap \partial(\mathcal{D} \times [-1, 1]) \subset Z_i, \quad r_t < \epsilon \quad (1)$$

Let

$$Y_i = \bigcup_{t \in Z_i} B(t, r_t)$$

Clearly Y_0, Y_1 are open sets in $\mathcal{D} \times [-1, 1]$ and they are disjoint. In addition they are saturated by the quotient map, that is $Y_i = \psi^{-1}(\psi(Y_i))$. This is because condition (1) implies that

$$Y_i \cap \partial(\mathcal{D} \times [-1, 1]) = Z_i$$

In this case let $W_i = \psi(Y_i) \subset \widetilde{M} \cup \mathcal{R}$. The last property implies that W_0, W_1 are open in $\widetilde{M} \cup \mathcal{R}$. Since they are disjoint and $x \in W_0, y \in W_1$, then x, y are separated in $\widetilde{M} \cup \mathcal{R}$.

This finishes the proof that $\widetilde{M} \cup \mathcal{R}$ is Hausdorff. \square

Theorem 8.2. *The bijection $f : \widetilde{M} \cup S_\infty^2 \rightarrow \widetilde{M} \cup \mathcal{R}$ is a $\pi_1(M)$ equivariant homeomorphism.*

Proof. From the definition of f it is obvious that it is a bijection and in addition that it is $\pi_1(M)$ equivariant. In addition $\widetilde{M} \cup S_\infty^2$ is compact (Gromov compactification) and $\widetilde{M} \cup \mathcal{R}$ is a Hausdorff space. By elementary point set topology [Mu] it suffices to show that f is continuous, which will imply that f is a homeomorphism. Finally since $\widetilde{M} \cup S_\infty^2$ is a metric space, it is first countable. Therefore in order to check that f is continuous, we only need to check that f is sequentially continuous.

Before we prove that f is continuous notice we have the least amount of properties of $\widetilde{M} \cup \mathcal{R}$ in order to obtain the result. In particular at this point we do not know that $\widetilde{M} \cup \mathcal{R}$ is compact, or that the action of $\pi_1(M)$ on $\widetilde{M} \cup \mathcal{R}$ is continuous. Both of these properties can be proved directly, but for the sake of brevity this is deduced immediately from Theorem 8.2.

Let then (x_n) be a sequence in $\widetilde{M} \cup S_\infty^2$ converging to x in $\widetilde{M} \cup S_\infty^2$. If x is in \widetilde{M} then x_n is in \widetilde{M} for n big, so $f(x_n) = x_n$ (in \widetilde{M}) converges to $x = f(x)$ in \widetilde{M} and hence in $\widetilde{M} \cup \mathcal{R}$.

Therefore suppose from now on that x is in S_∞^2 . We will show that any subsequence of (x_n) has a further subsequence (x_{n_k}) so that $(f(x_{n_k}))$ converges to $f(x)$ in $\widetilde{M} \cup \mathcal{R}$. This proves continuity of f at x . Consider first a sequence (x_n) in S_∞^2 with $x_n \rightarrow x$ in $\widetilde{M} \cup S_\infty^2$. Since the topology of $\widetilde{M} \cup S_\infty^2$ induces the Gromov topology in S_∞^2 , it follows that (x_n) converges to x in S_∞^2 . So $f(x_n)$ converges to $f(x)$ in \mathcal{R} and it follows that $(f(x_n))$ converges to $f(x)$ in $\widetilde{M} \cup \mathcal{R}$.

Therefore we may assume that x_n is in \widetilde{M} for all n . We will take subsequences at will. First, up to subsequence there are $g_n \in \pi_1(M)$ and y_n in \widetilde{M} with $g_n(y_n) = x_n$ and $y_n \rightarrow y$ in \widetilde{M} . This is because M is compact. Up to another subsequence assume that (g_n) is a sequence of distinct elements.

Since (g_n) is a sequence of distinct elements of $\pi_1(M)$ and $\pi_1(M)$ acts as a convergence group in $\widetilde{M} \cup S_\infty^2$ [Gr, Gh-Ha], there is a subsequence (still denoted by (g_n) by abuse of notation) so that (g_n) has a source $a \in S_\infty^2$ and a sink $b \in S_\infty^2$ for the action on $\widetilde{M} \cup S_\infty^2$. In fact the same is true for the action on $\widetilde{M} \cup \mathcal{R}$, but this takes quite a bit longer to prove. We will first prove that f is a homeomorphism which also implies this fact from convergence group property of $\pi_1(M)$ on $\widetilde{M} \cup S_\infty^2$. Notice however that we proved in Theorem 6.15 that $\pi_1(M)$ acts as a convergence group on \mathcal{R} .

Notice that by the convergence group properties on $\widetilde{M} \cup S_\infty^2$, the sink for the sequence (g_n) is x , and so it follows that $b = x$. Therefore the sink for the sequence (g_n) acting on \mathcal{R} is $f(b) = f(x)$.

We previously explained that $f(a), f(b)$ are the source/sink pair for the sequence (g_n) acting on \mathcal{R} . Let

$$A = \eta^{-1}(f(a)), \quad B = \eta^{-1}(f(b))$$

Then A, B are the source/sink sets for the sequence (g_n) acting on $\partial\mathcal{O}$.

Let now

$$v_n = \Theta(y_n), \quad v = \Theta(y)$$

These are points in \mathcal{O} . Let $z_0 = \mathcal{E}(\partial\mathcal{O}^s(v))$, $z_1 = \mathcal{E}(\partial\mathcal{O}^u(v))$. We will think of these as subsets of $\partial\mathcal{O}$ and also as points in \mathcal{R} .

Case 1 – Suppose first that z_0, z_1 are both not equal to $f(a)$.

Then in $\partial\mathcal{O}$ the sequence $(g_n(\partial\mathcal{O}^s(v)))$ converges to a subset of B and so by the convergence group property the sequence $(g_n(\partial\mathcal{O}^s(v_n)))$ converges to a subset of B (1). This is because for n big the equivalence class of $\partial\mathcal{O}^s(v_n)$ under \sim

$$\text{is in a fixed compact set } C \text{ of } \partial\mathcal{O} - \eta^{-1}(f(a)) = \partial\mathcal{O} - A. \quad (2)$$

Similarly $(g_n(\partial\mathcal{O}^u(v_n)))$ converges to a subset of B (2). We claim that the sequence $(g_n(v_n))$ (contained in \mathcal{O}) cannot have a convergent subsequence in \mathcal{O} . Suppose that up to subsequence $(g_n(v_n))$ converges to w in \mathcal{O} . Then the escape lemma and (2) above show that $\partial\mathcal{O}^s(w)$ is related to B . In addition the escape lemma and property (2) shows that $\partial\mathcal{O}^u(w)$ is also related to B . This would imply that $\partial\mathcal{O}^s(w)$ is related to $\partial\mathcal{O}^u(w)$. This is impossible by Proposition 6.3. We conclude that this cannot happen.

Since $(g_n(v_n))$ escapes compact sets in \mathcal{O} , then the escape lemma and (2) show that in $\mathcal{O} \cup \partial\mathcal{O}$ this sequence can only converge to points in B . Then in $\mathcal{D} \times [-1, 1]$ the sequence $(g_n(\Theta^{-1}(v_n)))$ converges to vertical stalks in $B \times [-1, 1]$. Therefore in $\widetilde{M} \cup \mathcal{R}$ the sequence $(g_n(y_n)) = (x_n) = (f(x_n))$ converges to $f(b) = f(x)$. This finishes the analysis in this case.

Case 2 – Suppose that either $\eta(\partial\mathcal{O}^s(v)) = f(a)$ or $\eta(\partial\mathcal{O}^u(v)) = f(a)$.

Without loss of generality suppose that $\eta(\partial\mathcal{O}^s(v)) = f(a)$. Therefore $\eta(\partial\mathcal{O}^u(v))$ is not equal to $f(a)$. By the arguments in the analysis of case 1, it follows that $(g_n(\partial\mathcal{O}^u(v_n)))$ converges to a subset of $B = \eta^{-1}(f(b))$.

Suppose that a subsequence of $(g_n(v_n))$ escapes compact sets in \mathcal{O} and converges in $\mathcal{O} \cup \partial\mathcal{O}$. By the escape lemma, this sequence converges to a point in B . Then $(f(x_n))$ converges to $f(b) = f(x)$ as in Case 1.

Therefore from now on we assume that the sequence $(g_n(v_n)) = w_n$ converges to w which is a point in \mathcal{O} . Recall that $\Theta(x_n) = w_n$.

In addition $g_n(\partial\mathcal{O}^u(v_n)) = \mathcal{O}^u(w_n)$ converges to a subset of $\partial\mathcal{O}^u(w)$. Therefore $\partial\mathcal{O}^u(w) \subset B$ is contained in the sink set for the sequence (g_n) acting on $\partial\mathcal{O}$.

Let $z_n \in \widetilde{M}$ with $\Theta(z_n) = w_n$ and (z_n) converging to z , hence $\Theta(z) = w$. Let D be a small closed disk in \widetilde{M} , transverse to $\widetilde{\Phi}$, where we may assume that D contains all $\{z_n\}$ and z in its interior. Let $t_n \in \mathbf{R}$ with

$$x_n = \widetilde{\Phi}_{t_n}(z_n)$$

Since (x_n) converges to x in $\widetilde{M} \cup S_\infty^2$, it follows that the sequence of absolute values $(|t_n|)$ converges to infinity. Suppose by way of contradiction that there is a subsequence, still denoted by (t_n) so that $t_n \rightarrow +\infty$. Assume furthermore that all y_n are in a sector of y .

Consider an arbitrary point ρ in $\widetilde{\Lambda}^u(y)$ very near y and in the half leaf of $\widetilde{\Lambda}^u(y)$ that intersects $\widetilde{\Lambda}^s(y_n)$ for some n sufficiently big. For the time being fix the point ρ . For each such ρ we will define a sequence (c_n^ρ) as follows. The points c_n^ρ are points in $\widetilde{\Lambda}^u(y_n) \cap \widetilde{\Lambda}^s(\rho)$ so that the sequence (c_n^ρ) converges to a point very near y . Then

$$d(c_n^\rho, y_n) = d(g_n(c_n^\rho), g_n(y_n)) = d(g_n(c_n^\rho), x_n)$$

is very small. Recall that (t_n) converges to $+\infty$ so z_n is lot flow backwards of x_n . Since $g_n(c_n^\rho)$ is in $\tilde{\Lambda}^u(x_n)$, then there is a unique point

$$s_n = \tilde{\Phi}_{\mathbf{R}}(g_n(c_n^\rho)) \cap D$$

By assumption $t_n \rightarrow +\infty$ so s_n is a point which is extremely flow backwards of $g_n(c_n^\rho)$. It follows that $(d(s_n, z_n))$ converges to zero. In particular

$$(g_n(\tilde{\Lambda}^s(c_n^\rho))) = (\tilde{\Lambda}^s(g_n(c_n^\rho))) = ((\tilde{\Lambda}^s(s_n)))$$

converges to $\tilde{\Lambda}^s(z)$. Therefore $(g_n(\partial\mathcal{O}^s(\rho)))$ converges to a subset of $\mathcal{E}(\partial\mathcal{O}^s(w))$. The set $\mathcal{E}(\partial\mathcal{O}^s(w))$ is not equivalent to B under \sim because B contains $\partial\mathcal{O}^u(w)$.

In addition this is true for any ρ near enough y in $\tilde{\Lambda}^u(y)$. Since only finitely many ideal points of stable leaves can be equivalent to each other by the relation \sim , it now follows that $\mathcal{E}(\partial\mathcal{O}^s(w))$ is the sink for the sequence (g_n) acting on $\partial\mathcal{O}$. This contradicts the fact that $\mathcal{E}(\partial\mathcal{O}^u(w))$ is inequivalent to B and the last one is the sink set of (g_n) acting on $\partial\mathcal{O}$.

This contradiction shows that no subsequence of (t_n) can converge to $+\infty$. It follows that (t_n) converges to $-\infty$. Then in $\mathcal{D} \times [-1, 1]$, the sequence (x_n) converges to $z \times \{-1\}$. Therefore in $\tilde{M} \cup \mathcal{R}$, the sequence (x_n) converges to $\eta(\mathcal{E}(\partial\mathcal{O}^u(w)))$ (recall that $\Theta(z) = w$). Since

$$\partial\mathcal{O}^u(w) \sim B$$

it follows that (x_n) converges to $f(b)$ in $\tilde{M} \cup \mathcal{R}$. This finishes the proof that f is continuous.

As explained before this implies that f is a $\pi_1(M)$ equivariant homeomorphism. As a consequence $\pi_1(M)$ acts continuously on $\tilde{M} \cup \mathcal{R}$ and $\pi_1(M)$ acts as a convergence group on $\tilde{M} \cup \mathcal{R}$. \square

9 Quasigeodesic pseudo-Anosov flows

Theorem 9.1. *Let Φ be a bounded pseudo-Anosov flows which is not topologically equivalent to a suspension Anosov flow. Then $\pi_1(M)$ is Gromov hyperbolic and Φ is a quasigeodesic pseudo-Anosov flow.*

Proof. The first part was proved in Corollary 7.2. We prove the second part. We first show the following facts in $\tilde{M} \cup \mathcal{R}$ using some very easy properties of this compactification.

1) For any x in \tilde{M} , there is a limit $\lim_{t \rightarrow +\infty} \tilde{\Phi}_t(x)$ in $\tilde{M} \cup \mathcal{R}$.

Using the homeomorphism ν_2 between \tilde{M} and $\mathcal{O} \times (-1, 1)$ we analyse this in $\mathcal{D} \times [-1, 1]$ and then in $\tilde{M} \cup \mathcal{R}$. Considering x in $\mathcal{O} \times (-1, 1)$ the limit $\lim_{t \rightarrow 1} (\Theta(x), t)$ obviously exists in $\mathcal{D} \times [-1, 1]$ – it is just $(\Theta(x), 1)$. Since $\psi : \mathcal{D} \times [-1, 1] \rightarrow \tilde{M} \cup \mathcal{R}$ is continuous property 1) is true in $\tilde{M} \cup \mathcal{R}$. We denote the limit above by x_+ which is a point in \mathcal{R} . Clearly this is independent of the point in $\gamma = \tilde{\Phi}_{\mathbf{R}}(x)$ and is also denoted by γ_+ . Similarly $\lim_{t \rightarrow -\infty} \tilde{\Phi}_t(x)$ exists in $\tilde{M} \cup \mathcal{R}$ for any x in \tilde{M} . This is denoted by x_- or γ_- .

2) For any x in \tilde{M} then $x_+ \neq x_-$.

Let $\gamma = \tilde{\Phi}_{\mathbf{R}}(x)$. If $\gamma_- = \gamma_+$ then $\mathcal{E}(\partial\mathcal{O}^s(x))$ is equivalent to $\mathcal{E}(\partial\mathcal{O}^u(x))$. This was proved not to be true in Proposition 6.3 so $\gamma_+ \neq \gamma_-$.

3) The map $P_+ : \tilde{M} \rightarrow \mathcal{R}$ given by $P_+(x) = x_+$ is continuous and similarly for $P_- : \tilde{M} \rightarrow \mathcal{R}$.

There is a map $PP_+ : \mathcal{O} \times (-1, 1) \rightarrow \partial(\mathcal{D} \times [-1, 1])$ given by $PP_+(y) = (y, 1)$. This map is obviously continuous. The map P_+ is equal to $\psi \circ (PP_+)$, hence P_+ is continuous.

Theorem 8.2 shows that $\widetilde{M} \cup S_\infty^2$ is homeomorphic to $\widetilde{M} \cup \mathcal{R}$ via the map f . Therefore the same 3 properties 1), 2), 3) also hold in $\widetilde{M} \cup S_\infty^2$. By a result of the author and Lee Mosher [Fe-Mo] this implies that Φ is a quasigeodesic flow.

This finishes the proof of the theorem. \square

Corollary 9.2. *Let Φ be a pseudo-Anosov flow in M with $\pi_1(M)$ Gromov hyperbolic. Then Φ is quasigeodesic if and only if Φ is a bounded pseudo-Anosov flow.*

10 Concluding remarks

Examples of quasigeodesic flows with freely homotopic orbits

Mosher [Mo5] showed that a Reebless finite depth foliation in M^3 hyperbolic admit an almost transverse pseudo-Anosov flow Φ . The author and Mosher proved that these flows are quasigeodesic [Fe-Mo]. Mosher proved a large class of these flows have freely homotopic orbits. In fact for each n one can construct examples with free homotopy classes of size at least n which are quasigeodesic. This implies that the Main theorem is optimal.

Unbounded pseudo-Anosov flows

Suppose Φ is a pseudo-Anosov flow which is not bounded and which is not topologically conjugate to a suspension Anosov flow. In section 5 we saw how to construct chains of perfect fits of infinite length. One open question is whether one can also construct chains of free homotopies of infinite length. Perhaps more refined perturbation methods will yield this result.

Suppose in addition that M is atoroidal. There are examples, for example \mathbf{R} -covered Anosov flows in hyperbolic 3-manifolds [Fe2]. One very important open question is the following: are these the only examples? In other words if Φ is unbounded in M atoroidal does it imply that Φ is an \mathbf{R} -covered Anosov flow?

In particular if the answer to this very general question is true, it will imply that there are many examples of quasigeodesic Anosov flows in hyperbolic manifolds. This is because there are many examples of Anosov flows in hyperbolic 3-manifolds which are not \mathbf{R} -covered [Fe4]. Up to now there are no examples of quasigeodesic Anosov flows in hyperbolic 3-manifolds. On the other hand it would be very interesting also to construct counterexamples to the general question.

Applications to asymptotic properties of foliations

Suppose that \mathcal{F} is a Reebless foliation in M^3 hyperbolic [No]. Reebless roughly means that leaves are π_1 injective. [No]. These foliations are very common in 3-manifolds [Ga1, Ga2, Ga3, Ro1, Ro2, Ro3]. In addition Candel [Ca] proved that there is a metric in M so that every leaf of \mathcal{F} is a hyperbolic surface. Therefore each leaf L of the lifted foliation $\widetilde{\mathcal{F}}$ to \widetilde{M} can be thought of as an embedding

$$i : L \cong \mathbf{H}^2 \rightarrow \widetilde{M} \cong \mathbf{H}^3$$

The *continuous extension question* asks whether for each L the map i extends to a continuous map $i : L \cup \partial L \rightarrow \widetilde{M} \cup S_\infty^2$, where ∂L is the ideal circle of L . The continuous extension property has been proved in the following settings: 1) \mathcal{F} is a finite depth foliation. See [Ga1, Ga2, Ga3] for finite depth foliations and [Fe8] for the proof of the continuous extension property in this case; 2) \mathbf{R} -covered foliations [Fe9]. Here \mathbf{R} -covered means that the leaf space of $\widetilde{\mathcal{F}}$ is homeomorphic to the reals; 3) Foliations with one sided branching [Fe9]. One sided branching means that the leaf space of $\widetilde{\mathcal{F}}$ has non Hausdorff behavior only in one direction – positive or negative.

In the generic two sided branching case the conjecture is that \mathcal{F} admits an almost transverse pseudo-Anosov flow [Th5, Th6, Cal3]. Calegari [Cal3] has done substantial work in this direction – he produced two essential laminations which are transverse to \mathcal{F} . Perhaps these can be used to produce a pseudo-Anosov flow Φ almost transverse to \mathcal{F} . If this flow Φ is quasigeodesic, this would imply the continuous extension property for \mathcal{F} because of the following result. The author proved in [Fe8] that for a general \mathcal{F}

in M hyperbolic, if there is a *quasigeodesic* pseudo-Anosov flow almost transverse to \mathcal{F} , then \mathcal{F} has the continuous extension property.

References

- [An] D. V. Anosov, *Geodesic flows in closed Riemannian manifolds with negative curvature*, Proc. Steklov Inst. Math. **90** (1969).
- [Ba1] T. Barbot, *Characterization des flots d'Anosov pour les feuilletages*, Erg. Th. Dyn. Sys. **15** (1995) 247-270.
- [Ba2] T. Barbot, *Mise en position optimale de tores para rapport à un flot d'Anosov*, Comm. Math. Helv. **70** (1995) 113-160.
- [Be-Fe] M. Bestvina and M. Feighn, *The boundary of negatively curved groups*, Jour. Amer. Math. Soc. **4** (1991) 469-481.
- [Bl-Ca] S. Bleiler and A. Casson, *Automorphisms of surfaces after Nielsen and Thurston*, Cambridge Univ. Press, 1988.
- [Bon] F. Bonahon, *Bouts des varietes hyperboliques de dimension 3*, Ann. of Math. **124** (1986) 71-158.
- [Bow1] B. Bowditch, *A topological characterization of hyperbolic groups*, Jour. Amer. Math. Soc. **11** (1998) 643-667.
- [Bow2] B. Bowditch, *Convergence groups and configuration spaces*, in "Group Theory Down Under", Ed. J. Cossey, C.F. Miller, W.D. Newmann, M. Shapiro, 23-54, de Gruyter, Berlin 1999.
- [Bowe] R. Bowen, *Symbolic dynamics for hyperbolic flows*, Amer. Jour. Math. **95** (1973) 429-460.
- [Cal1] D. Calegari, *The geometry of \mathbf{R} -covered foliations*, Geom. Topol. **4** (2000) 457-515.
- [Cal2] D. Calegari, *Foliations with one-sided branching*, Geom. Ded. **96** (2003) 1-53.
- [Cal3] D. Calegari, *Promoting essential laminations*, Inven. Math. **166** (2006) 583-643.
- [Cal4] D. Calegari, *Universal circles for quasigeodesic flows*, Geom. Topol. **10** (2006) 2271-2298.
- [Ca-Du] D. Calegari and N. Dunfield, *Laminations and groups of homeomorphisms of the circle*, Inven. Math. **152** (2003) 149-204.
- [Ca] A. Candel, *Uniformization of surface laminations*, Ann. Sci. Ecole Norm. Sup. **26** (1993) 489-516.
- [Ca-Th] J. Cannon and W. Thurston, *Group invariant Peano curves*, Geom. Topol. **11** (2007) 1315-1355.
- [Fe1] S. Fenley, *Asymptotic properties of depth one foliations in hyperbolic 3-manifolds*, Jour. Diff. Geom. ?????
- [Fe2] S. Fenley, *Anosov flows in 3-manifolds*, Ann. of Math. **139** (1994) 79-115.
- [Fe3] S. Fenley, *Quasigeodesic Anosov flows and homotopic properties of flow lines*, Jour. Diff. Geom. **41** (1995) 479-514.
- [Fe4] S. Fenley, *The structure of branching in Anosov flows of 3-manifolds*, Comm. Math. Helv. **73** (1998) 259-297.
- [Fe5] S. Fenley, *Foliations with good geometry*, Jour. Amer. Math. Soc. **12** (1999) 619-676.
- [Fe6] S. Fenley, *Foliations, topology and geometry of 3-manifolds: \mathbf{R} -covered foliations and transverse pseudo-Anosov flows*, Comm. Math. Helv. **77** (2002) 415-490.
- [Fe7] S. Fenley, *Pseudo-Anosov flows and incompressible tori*, Geom. Ded. **99** (2003) 61-102.
- [Fe8] S. Fenley *Geometry of foliations and flows I: Almost transverse pseudo-Anosov flows and asymptotic behavior of foliations*, Jour. Diff. Geom. **81** (2009) 1-89.
- [Fe9] S. Fenley *Ideal boundaries of pseudo-Anosov flows and uniform convergence groups, with connections and applications to large scale geometry*, Geom. Topol. **17** (2012) 1-110.
- [Fe-Mo] S. Fenley and L. Mosher, *Quasigeodesic flows in hyperbolic 3-manifolds*, Topology **222** (2001) 503-537.
- [Fo-Ha] P. Foulon and B. Hasselblatt, *Contact Anosov flows on hyperbolic 3-manifolds*, Geom. Topol. **17** (2013) 1225-1252.
- [Fra1] S. Frankel, *Quasigeodesic flows and Möbius like groups*, Jour. Diff. Geom. **93** (2013) 401-429.
- [Fra2] S. Frankel, *Quasigeodesic flows and sphere filling curves*, arXiv:1210.7050.
- [Fr] D. Fried, *Transitive Anosov flows and pseudo-Anosov maps*, Topology **22** (1983) 299-303.
- [Ga1] D. Gabai, *Foliations and the topology of 3-manifolds*, J. Diff. Geo. **18** (1983) 445-503.
- [Ga2] D. Gabai, *Foliations and the topology of 3-manifolds II*, J. Diff. Geo. **26** (1987) 461-478.
- [Ga3] D. Gabai, *Foliations and the topology of 3-manifolds III*, J. Diff. Geo. **26** (1987) 479-536.
- [Ga4] D. Gabai, *8 problems in foliations and laminations*, in Geometric Topology, W. Kazez, ed., Amer. Math. Soc. 1987, 1-33.
- [Ga5] D. Gabai, *3 lectures on foliations and laminations on 3-manifolds*, Laminations and foliations in dynamics, geometry and topology (Stony Brook, NY 1998), 87-109, Contemp. Math., 269, Amer. Math. Soc. Providence, 2001.
- [GK1] D. Gabai and W. Kazez, *Pseudo-Anosov maps and surgery on fibred 2-bridge knots*, Topol. Appl. **37** (1990) 93-100.
- [GK2] D. Gabai and W. Kazez, *Group negative curvature for 3-manifolds with genuine laminations*, Geom. Topol. **2** (1998) 65-77.
- [Gh-Ha] *Sur les groupes hyperboliques d'après Mikhael Gromov*, E. Ghys and P. De la Harpe, editors, Birkhäuser, 1990.
- [Go] S. Goodman, *Dehn surgery on Anosov flows*, Lec. Notes Math. **1007** (1983) 300-307, Springer.

- [Gr] M. Gromov, *Hyperbolic groups*, in Essays on Group theory, Springer-Verlag, 1987, pp. 75-263.
- [Han] M. Handel, *Global shadowing pseudo-Anosov homeomorphisms*, Erg.Th. Dyn. Sys. **5** (1985) 373-377.
- [Ha-Th] A. Hatcher and W. Thurston, *Incompressible surfaces in 2-bridge knot complements*, Inven. Math. **79** (1985) 225-246.
- [He] J. Hempel, *3-manifolds*, Ann. of Math. Studies 86, Princeton University Press, 1976.
- [Man] B. Mangum, *Incompressible surfaces and pseudo-Anosov flows*, Topol. Appl. **87** (1998) 29-51.
- [Mj] Mj, Mahan, *Cannon-Thurston maps for surface groups*, Ann. of Math. **179** (2014) 1-80.
- [Mo1] L. Mosher, *Surfaces and branched surfaces transverse to pseudo-Anosov flows on 3-manifolds*, Jour. Diff. Geom. **34** (1990) 1-36.
- [Mo2] L. Mosher, *Examples of quasigeodesic flows on hyperbolic 3-manifolds*, Proceedings of the Ohio State University Research Semester on Low-Dimensional topology, W. de Gruyter, 1992.
- [Mo3] L. Mosher, *Dynamical systems and the homology norm of a 3-manifold I. Efficient intersection of surfaces and flows*, Duke Math. Jour. **65** (1992) 449-500.
- [Mo4] L. Mosher, *Dynamical systems and the homology norm of a 3-manifold II*, Invent. Math. **107** (1992) 243-281.
- [Mo5] L. Mosher, *Laminations and flows transverse to finite depth foliations*, Part I: Branched surfaces and dynamics – available from <http://newark.rutgers.edu:80/~mosher/>, Part II in preparation.
- [Mo-Ti] J. Morgan and G. Tian, *Ricci flow and the Poincaré conjecture*, Clay Mathematical Monographs, **3**, 2007.
- [Mu] J. Munkres, *A first course in Topology*, Prentice Hall, 2000.
- [No] S. P. Novikov, *Topology of foliations*, Trans. Moscow Math. Soc. **14** (1963) 268-305.
- [Pe1] G. Perelman, *The entropy formula for the Ricci flow and its geometric applications*, math arxiv math.DG/0211159.
- [Pe2] G. Perelman, *Ricci flow with surgery on 3-manifolds*, math arxiv math.DG/0303109.
- [Pe3] G. Perelman, *Finite extinction time for the solutions to the Ricci flow in certain 3-manifolds*, math arxiv math.DG/0307245.
- [Ro1] R. Roberts, *Constructing taut foliations*, Comm. Math. Helv. **70** (1995) 516-545.
- [Ro2] R. Roberts, *Taut foliations in punctured surfaces bundles, I*, Proc. London Math. Soc. (3) **82** (2001) 747-768.
- [Ro3] R. Roberts, *Taut foliations in punctured surface bundles, II*, Proc. London Math. Soc. (3) **83** (2001) 443-471.
- [Th1] W. Thurston, *The geometry and topology of 3-manifolds*, Princeton University Lecture Notes, 1982.
- [Th2] W. Thurston, *Three dimensional manifolds, Kleinian groups and hyperbolic geometry*, Bull. A.M.S. **6** (1982) 357-381.
- [Th3] W. Thurston, *Hyperbolic structures on 3-manifolds II: Surface groups and 3-manifolds that fiber over the circle*, preprint.
- [Th4] W. Thurston, *On the geometry and dynamics of diffeomorphisms of surfaces*, Bull. A.M.S. **19** (1988) 417-431.
- [Th5] W. Thurston, *3-manifolds, foliations and circles II: Transverse asymptotic geometry of foliations*, preprint.
- [Th6] W. Thurston, *The universal circle for foliations and transverse laminations*, lectures in M.S.R.I., 1997.
- [Ze] A. Zeghib, *Sur les feuilletages géodésiques continus des variétés hyperboliques*, Invent. Math. **114** (1993) 193-206.

Florida State University
Tallahassee, FL 32306-4510
and
Princeton University
Princeton, NJ 08544-1000