

A SET-OPERAD OF FORMAL FRACTIONS AND DENDRIFORM-LIKE SUB-OPERADS

FRÉDÉRIC CHAPOTON, FLORENT HIVERT, AND JEAN-CHRISTOPHE NOVELLI

ABSTRACT. We introduce an operad of formal fractions, abstracted from the Mould operads and containing both the Dendriform and the Tridendriform operads. We consider the smallest set-operad contained in this operad and containing four specific elements of arity two, corresponding to the generators and the associative elements of the Dendriform and Tridendriform operads. We obtain a presentation of this operad (by binary generators and quadratic relations) and an explicit combinatorial description using a new kind of bi-colored trees. Similar results are also presented for related symmetric operads.

CONTENTS

1. Background	3
1.1. Operads	3
1.2. The dendriform and tridendriform operads	4
2. The operads of formal fractions	4
2.1. Formal fractions	5
3. Dendriform and tridendriform operads in formal fractions	6
3.1. Generators and relations	7
3.2. Canonical trees	8
4. The operads of red and white trees	10
4.1. Red and white trees	10
4.2. Operad structure on labelled red and white trees	12
4.3. The operad RW and recursively labelled red-white trees	14
4.4. From red and white trees to \mathcal{FF}_4	17
5. Remarkable sub-operads	19
5.1. The operad RW_T	19
5.2. The operad RW_D	20
5.3. The operad RW_{DS}	21
6. Symmetric operads	22
6.1. The symmetric operad on red and white trees	22
6.2. The symmetric sub-operads	24
7. More general operads on more generators	25
7.1. The 6-generator operad and more	26
7.2. Symmetric counterparts	28
References	29

The main theme of this article is about combinatorial and algebraic descriptions of some set-operads. The notion of operad has its historical roots in algebraic topology,

Date: October 17, 2018.

and has become a useful and classical tool in this field. More recently, operads have also been considered from a more algebraic point of view, namely in the monoidal categories of vector spaces and chain complexes instead of the monoidal category of topological spaces. The homology functor is a natural way to pass from topological operads to algebraic operads.

But operads can also be considered with a combinatorial state of mind, and the natural ambient category is then the monoidal category of finite sets. If one is given an operad P in the category of vector spaces, there is a simple idea to obtain an operad in the category of finite sets: choose a finite set of elements of P and consider the closure of this set under the composition maps of P . One can then try to count the finite sets obtained in this way, and to describe their elements in an explicit way.

As a side remark, let us note that there is an algebraic motivation for doing this, related to categorification. If the underlying vector spaces of an operad could be considered as the Grothendieck groups of some Abelian categories, and composition maps as coming from functors between these categories, then elements of the operad would correspond to objects of these categories. Finding subsets of elements closed under the composition maps and describing their combinatorics could be a way to find hints on the nature of objects in the Abelian categories.

This article started with the aim to apply this closure procedure to the generators and their sums, in two operads in the category of vector spaces introduced by J.-L. Loday, namely the dendriform [19] and tridendriform operads [20]. It has been proved in [2] and [5] (see also [21]) that these operads can be considered as sub-operads of two different operads of fractions. Our problem is therefore to describe combinatorially the fractions that can be obtained by iterated compositions of the fractions corresponding to generators of \mathcal{Dend} or $\mathcal{Tridend}$ and their sums.

Because these two operads of fractions have very similar composition maps, one can define a set-operad of formal fractions \mathcal{FF} in which the closure problems for \mathcal{Dend} and $\mathcal{Tridend}$ can be considered simultaneously. Indeed, the chosen subset of \mathcal{Dend} is contained in the chosen subset of $\mathcal{Tridend}$, when both are considered as formal fractions. One is therefore lead to the following question: describe the closure of four fractions in $\mathcal{FF}(2)$ (associated with three generators of $\mathcal{Tridend}$ and their sum) under the compositions of the operad \mathcal{FF} . This defines a set-operad, denoted by \mathcal{FF}_4 .

Our main results are a presentation by binary generators and quadratic relations and an explicit combinatorial description of \mathcal{FF}_4 using a new kind of bicolored trees, called the red and white trees.

The main interest of those trees is to provide simple ways to answer two natural questions: compute the automorphism group of a given element and check if a given tree is in a given set-operad. Indeed, on the description of an element as a composition of generators, none of these questions can easily be answered, and on the description as a fraction, only the automorphism group can effortlessly be seen.

We also consider the similar closure properties for symmetric operads (with actions of the symmetric groups) and obtain a symmetric analog of the isomorphism between \mathcal{FF}_4 and the operad of red and white trees.

The article is organized as follows:

In Section 1, we briefly recall general facts about operads, dendriform and tridendriform algebras.

In section 2, we recall two known operads on fractions, introduce the operad of formal fractions, and describe two inclusions of formal fractions in fractions.

In section 3, we describe the images of the chosen elements of the Dendriform and Tridendriform operads in formal fractions and define the operad \mathcal{FF}_4 as the closure of these images. We then introduce an operad \mathcal{GR}_4 given by generators and relations, and proceed to prove that it is isomorphic to \mathcal{FF}_4 , using rewriting techniques.

In section 4, we introduce an operad RW on the sets of red and white trees, its composition maps being given by combinatorial rules. We prove that this operad is isomorphic to the operad \mathcal{GR}_4 by comparing their generating series. We then prove the main theorem, which states that all three operads \mathcal{FF}_4 , \mathcal{GR}_4 and RW are isomorphic.

In section 5, we use the previous construction to consider various sub-operads generated by some subsets of the four chosen generators.

In section 6, we extend some of the previous results to the closure as symmetric operads (instead of non-symmetric operads). In particular, we obtain a symmetric analog of the isomorphism between \mathcal{FF}_4 and RW.

In section 7, we sketch, mostly without proofs, an extension of all this work to a set-operad on 6 generators inside a more general kind of formal fractions and its relation with a more general kind of red and white trees.

Acknowledgment. This research was partially supported by projet ANR-12-BS01-0017. The authors thank the Centro di Giorgi (Pise) for its hospitality. This research was driven by computer exploration, using the open-source mathematical software Sage [27] and its algebraic combinatorics features developed by the Sage-Combinat community [28].

1. BACKGROUND

1.1. Operads. We will consider in this article various kinds of operads. Let us fix our terminology.

First, we will use the word *operad* to mean a non-symmetric operad, and otherwise talk of *symmetric operad*.

An operad P in a monoidal category with tensor product \otimes is a collection of objects $P(n)$ for integers $n \geq 1$, endowed with composition maps \circ_i from $P(m) \otimes P(n) \rightarrow P(m+n-1)$ for all integers $m, n \geq 1$ and $1 \leq i \leq m$ satisfying appropriate associativity axioms. One also requires a unit in $P(1)$. The detailed definition can be found in many references, for example [].

Symmetric operads are slightly more complex structures. A symmetric operad can be defined as a collection $P(n)$ with an action of the symmetric group S_n on $P(n)$, these actions being moreover compatible in the appropriate sense with the composition maps. An alternative definition can be given using the language of species [1]: a symmetric operad is then a species P and natural composition maps

\circ_i from $P(I) \otimes P(J) \rightarrow P(I \setminus \{i\} \sqcup J)$ for all finite sets I and J and every element $i \in I$.

Almost all operads that will be considered are operads in the category of sets endowed with the cartesian product. They will sometimes be called *set-operads* to avoid ambiguity.

1.2. The dendriform and tridendriform operads. The notion of a dendriform algebra has been introduced by Loday, in a sequence of articles involving several other new kinds of algebras, including Leibniz algebras. A dendriform algebra is an associative algebra where the associative product \odot can be written as a sum of two bilinear operations:

$$(1) \quad x \odot y = x \prec y + x \succ y,$$

in such a way that \prec and \succ satisfy three axioms. Conversely, these three axioms on the operations \prec and \succ imply that the \odot product is associative. Loday has described the free dendriform algebras, and therefore the dendriform operad, using planar binary trees. For more details, the reader may consult [19].

The notion of tridendriform algebra is a variation on the same idea, where the associative product is cut into three pieces

$$(2) \quad x \odot y = x \prec y + x \circ y + x \succ y,$$

in such a way that \circ is associative and \prec, \circ and \succ satisfy 6 other axioms. The free algebras are then described by planar trees instead of planar binary trees. For more details, see for example [20].

2. THE OPERADS OF FORMAL FRACTIONS

Inspired by Écalle's mould calculus [8], the first author defined in [2] an operad structure \mathcal{Mould}^0 on the vector spaces

$$(3) \quad \mathcal{Mould}^0(n) := \mathbb{Q}(u_1, \dots, u_n)$$

of rational fractions in the variables $\{u_1, \dots, u_n\}$.

The composition is defined for $F \in \mathcal{Mould}^0(m)$ and $G \in \mathcal{Mould}^0(n)$ by

$$(4) \quad F \circ_i G := S_{i,n} F(u_1, \dots, u_{i-1}, S_{i,n}, u_{i+1}, \dots, u_{m+n-1}) G(u_i, \dots, u_{i+n-1})$$

where $S_{i,n} = u_i + u_{i+1} + \dots + u_{i+n-1}$. It was proved in [2] that the sub-operad of \mathcal{Mould}^0 generated by the fractions $\frac{1}{u_1(u_1+u_2)}$ and $\frac{1}{u_2(u_1+u_2)}$ is isomorphic to the dendriform operad.

The natural action on the symmetric groups endows \mathcal{Mould}^0 with a symmetric operad structure. The symmetric sub-operad generated by $\frac{1}{u_1(u_1+u_2)}$ is isomorphic to the Zinbiel operad [5].

A very similar operad called \mathcal{Mould}^1 , over the same vector spaces, has been defined in [25]. In \mathcal{Mould}^1 , the composition is defined by

$$(5) \quad F \circ_i G := (P_{i,n} - 1) F(u_1, \dots, u_{i-1}, P_{i,n}, u_{i+1}, \dots, u_{m+n-1}) G(u_i, \dots, u_{i+n-1})$$

where $P_{i,n} = u_i u_{i+1} \dots u_{i+n-1}$. The operad \mathcal{Mould}^1 contains the tridendriform operad, as the sub-operad generated by

$$(6) \quad \frac{1}{(u_1 - 1)(u_1 u_2 - 1)}, \quad \frac{1}{(u_2 - 1)(u_1 u_2 - 1)}, \quad \text{and} \quad \frac{1}{u_1 u_2 - 1}.$$

It is also a symmetric operad and its symmetric sub-operad generated by $\frac{1}{(u_1 - 1)(u_1 u_2 - 1)}$ and $\frac{1}{u_1 u_2 - 1}$ is called CTD^1 by Loday [22].

Interestingly, these two operads are particular cases of a family of operads indexed by a parameter λ defined by Loday in [21] and denoted by $\lambda\text{-}\mathcal{Rat}\mathcal{Fct}$. He showed that \mathcal{Mould}^0 and $0\text{-}\mathcal{Rat}\mathcal{Fct}$ are isomorphic. In [25], it is showed that \mathcal{Mould}^1 and $1\text{-}\mathcal{Rat}\mathcal{Fct}$ are isomorphic too.

2.1. Formal fractions. Let us denote by $\text{SET}(\mathcal{O})$, the set-operad obtained from an operad \mathcal{O} by forgetting about its linear structure. In the present paper, we deal with some sub-operads of $\text{SET}(\mathcal{Mould}^0)$ and $\text{SET}(\mathcal{Mould}^1)$. It will be handy, as an intermediate tool, to encode all computations by means of a common sub-operad of both, namely the operad of formal fractions \mathcal{FF} .

Let $\mathcal{FF}(n)$ be the set of fractions whose numerator and denominator are products of formal symbols $[S]$ where S is any non-empty subset of $\{1, \dots, n\}$. As usual, we simplify the fraction if the same symbol appears on top and bottom. For readability, $\{1, 3, 5, 6\}$ is written $[1356]$. The empty product is denoted by 1, which should not be confused with the symbol $[1]$.

For $F \in \mathcal{FF}(n)$ and i_1, \dots, i_n integers, we write $F(i_1, \dots, i_n)$ the fraction where k is replaced by i_k . We extend naturally the definition to the case where i_k is itself a set by taking union. For example,

$$(7) \quad \frac{[1][34]}{[13][2]}(2, 5, 6, 9) = \frac{[2][69]}{[26][5]} \quad \text{and} \quad \frac{[1][34]}{[13][2]}(2, 5, \{6, 8\}, 9) = \frac{[2][689]}{[268][5]}.$$

Let $F \in \mathcal{FF}(m)$ and $G \in \mathcal{FF}(n)$. Define composition $F \circ_i G \in \mathcal{FF}(m+n-1)$ by

$$(8) \quad F \circ_i G := [S_{i,n}] F(u_1, \dots, x_{i-1}, S_{i,n}, u_{i+1}, \dots, u_{m+n-1}) G(u_i, \dots, u_{i+n-1})$$

where $S_{i,n} := \{i, i+1, \dots, i+n-1\}$.

For example, using

$$(9) \quad \frac{[123]}{[1234][12][2][3]}(1, \{2, 3, 4, 5\}, 6, 7) = \frac{[123456]}{[1234567][12345][2345][6]},$$

$$(10) \quad \frac{1}{[12][34]}(2, 3, 4, 5) = \frac{1}{[23][45]},$$

one finds that

$$(11) \quad \frac{[123]}{[1234][12][2][3]} \circ_2 \frac{1}{[12][34]} = \frac{[123456]}{[1234567][12345][6][23][45]}.$$

¹standing for Commutative TriDendriform

Similarly,

$$(12) \quad \frac{[123]}{[1234][12][2][3]} \circ_1 \frac{1}{[12][34]} = \frac{[123456][1234]}{[1234567][12345][5][6][12][34]}.$$

Proposition 2.1. (1) *The family $\mathcal{FF} := (\mathcal{FF}(n))_{n \in \mathbb{N}}$ together with the compositions \circ_i is a set-operad.*

(2) *The map ϕ^0 sending $[S]$ to $\sum_{i \in S} u_i$ and formal fractions to fractions is an injective morphism of set-operads from \mathcal{FF} to $\text{SET}(\mathcal{Mould}^0)$.*

(3) *The map ϕ^1 sending $[S]$ to $(\prod_{i \in S} u_i) - 1$ and formal fractions to fractions is an injective morphism of set-operads from \mathcal{FF} to $\text{SET}(\mathcal{Mould}^1)$.*

Proof. It is clear from the definitions of compositions in Equations (4), (5) and (8) that both maps ϕ^0 and ϕ^1 are injective and commute with all compositions. Therefore \mathcal{FF} itself is an operad. \blacksquare

The symmetric groups act naturally on \mathcal{Mould}^0 , \mathcal{Mould}^1 and \mathcal{FF} , endowing these with symmetric operad structures. We shall denote these operads by adding a Σ as exponent.

Proposition 2.2. *The maps ϕ^0 and ϕ^1 are respectively injective morphisms from \mathcal{FF}^Σ to $\mathcal{Mould}^{0\Sigma}$ and $\mathcal{Mould}^{1\Sigma}$.*

3. DENDRIFORM AND TRIDENDRIFORM OPERADS IN FORMAL FRACTIONS

Recall that according to [2], the map $\succ \mapsto \frac{1}{u_1(u_1+u_2)}$ and $\prec \mapsto \frac{1}{u_2(u_1+u_2)}$ is an injective morphism from the dendriform operad to \mathcal{Mould}^0 . Note that by definition

$$(13) \quad \phi_0 \left(\frac{1}{[1][12]} \right) = \frac{1}{u_1(u_1+u_2)} \quad \text{and} \quad \phi_0 \left(\frac{1}{[2][12]} \right) = \frac{1}{u_2(u_1+u_2)}.$$

Therefore, the sub-operad of $\text{SET}(\mathcal{Dend})$ generated by \succ and \prec is isomorphic to the sub-operad of \mathcal{FF} generated by $\frac{1}{[1][12]}$ and $\frac{1}{[2][12]}$. Moreover, the associative product $\prec + \succ$ of \mathcal{Dend} is associated to

$$(14) \quad \frac{1}{u_1(u_1+u_2)} + \frac{1}{u_2(u_1+u_2)} = \frac{1}{u_1 u_2} = \phi_0 \left(\frac{1}{[1][2]} \right),$$

and therefore also lives in \mathcal{FF} .

In a similar way, according to [25], the tridendriform operad is a sub-operad of \mathcal{Mould}^1 via the map

$$(15) \quad \succ \mapsto \frac{1}{(u_1-1)(u_1 u_2-1)} = \phi_1 \left(\frac{1}{[1][12]} \right),$$

$$(16) \quad \prec \mapsto \frac{1}{(u_2-1)(u_1 u_2-1)} = \phi_1 \left(\frac{1}{[2][12]} \right),$$

$$(17) \quad \circ \mapsto \frac{1}{(u_1 u_2-1)} = \phi_1 \left(\frac{1}{[12]} \right).$$

Moreover

$$(18) \quad (\prec + \circ + \succ) \mapsto \frac{1}{(u_1 - 1)(u_2 - 1)} = \phi_1 \left(\frac{1}{[1][2]} \right).$$

So we can study both the dendriform and tridendriform cases by studying the case of formal fractions:

Definition 3.1. We denote by \mathcal{FF}_4 the sub-set-operad of \mathcal{FF} generated by the fractions

$$(19) \quad F_{\succ} := \frac{1}{[1][12]}, \quad F_{\prec} := \frac{1}{[2][12]}, \quad F_{\circ} := \frac{1}{[12]}, \quad F_{\odot} := \frac{1}{[1][2]}.$$

The main goal of this paper is to understand \mathcal{FF}_4 and several of its sub-operads.

3.1. Generators and relations. The first problem is to determine the relations between the four generators. As we shall see, it turns out that the relations are all in degree 2. They are

$$(20) \quad \begin{aligned} \frac{1}{[12][2]} \circ_1 \frac{1}{[12][1]} &= \frac{1}{[123][1][3]} = \frac{1}{[12][1]} \circ_2 \frac{1}{[12][2]} \\ \frac{1}{[12]} \circ_1 \frac{1}{[12]} &= \frac{1}{[123]} = \frac{1}{[12]} \circ_2 \frac{1}{[12]} \\ \frac{1}{[12]} \circ_1 \frac{1}{[12][1]} &= \frac{1}{[123][1]} = \frac{1}{[12][1]} \circ_2 \frac{1}{[12]} \\ \frac{1}{[12]} \circ_1 \frac{1}{[12][2]} &= \frac{1}{[123][2]} = \frac{1}{[12]} \circ_2 \frac{1}{[12][1]} \\ \frac{1}{[12][2]} \circ_1 \frac{1}{[12]} &= \frac{1}{[123][3]} = \frac{1}{[12]} \circ_2 \frac{1}{[12][2]} \\ \frac{1}{[1][2]} \circ_1 \frac{1}{[1][2]} &= \frac{1}{[1][2][3]} = \frac{1}{[1][2]} \circ_2 \frac{1}{[1][2]} \\ \frac{1}{[12][2]} \circ_1 \frac{1}{[12][2]} &= \frac{1}{[123][2][3]} = \frac{1}{[12][2]} \circ_2 \frac{1}{[1][2]} \\ \frac{1}{[12][1]} \circ_1 \frac{1}{[1][2]} &= \frac{1}{[123][1][2]} = \frac{1}{[12][1]} \circ_2 \frac{1}{[12][1]} \end{aligned}$$

Note that they correspond to the tridendriform relations:

$$(21) \quad \begin{aligned} (x \succ y) \prec z &= x \succ (y \prec z), \\ (x \circ y) \circ z &= x \circ (y \circ z), \\ (x \succ y) \circ z &= x \succ (y \circ z), \\ (x \prec y) \circ z &= x \circ (y \succ z), \\ (x \circ y) \prec z &= x \circ (y \prec z), \\ (x \odot y) \odot z &= x \odot (y \odot z), \\ (x \prec y) \prec z &= x \prec (y \odot z), \\ (x \odot y) \succ z &= x \succ (y \succ z). \end{aligned}$$

To show that these are the only relations of \mathcal{FF}_4 , we need to consider the quotient of the free set-operad on $\{\prec, \succ, \circ, \odot\}$ by these relations. Recall that the free operad on a set G of binary generators is the set of binary trees with nodes labelled by the elements of G . To simplify the notations, when drawing a tree we never write the leaves of the tree: for example, the following trees are equal and we shall draw the first one in the rest of the paper:

$$(22) \quad \prec \circ_1 \odot = \begin{array}{c} \prec \\ \circ \\ \odot \end{array} = \begin{array}{c} \prec \\ \odot \\ \circ \end{array}$$

Definition 3.2. Let us denote by \mathcal{GR}_4 the quotient of the free set-operad \mathcal{G}_4 generated by $\{\prec, \succ, \circ, \odot\}$ by the relations:

$$(23) \quad \begin{array}{c} \prec \\ \succ \end{array} = \begin{array}{c} \succ \\ \prec \end{array} \\ \begin{array}{c} \circ \\ \odot \end{array} = \begin{array}{c} \odot \\ \circ \end{array} \quad \begin{array}{c} \prec \\ \odot \end{array} = \begin{array}{c} \odot \\ \prec \end{array} \quad \begin{array}{c} \succ \\ \odot \end{array} = \begin{array}{c} \odot \\ \succ \end{array} \quad \begin{array}{c} \prec \\ \circ \end{array} = \begin{array}{c} \circ \\ \prec \end{array} \\ \begin{array}{c} \odot \\ \circ \end{array} = \begin{array}{c} \circ \\ \odot \end{array} \quad \begin{array}{c} \prec \\ \odot \\ \circ \end{array} = \begin{array}{c} \odot \\ \prec \\ \circ \end{array} \quad \begin{array}{c} \succ \\ \odot \\ \circ \end{array} = \begin{array}{c} \odot \\ \succ \\ \circ \end{array}$$

The next paragraphs are devoted to the proof that \mathcal{GR}_4 is isomorphic to \mathcal{FF}_4 .

3.2. Canonical trees. Let us begin our study of \mathcal{GR}_4 by computing the generating series of its cardinalities. This is done using rewriting theory.

We start by choosing a tree in each equivalence class modulo the relation:

Definition 3.3. We say that a tree in \mathcal{G}_4 is canonical if it avoid all patterns on the right-hand side of each of the Relations (23).

Lemma 3.4. Each equivalence class modulo Relations (23) contains at least one canonical tree.

Proof. Consider a tree T . We want to show that there is a canonical tree in the class of T .

If it avoids all patterns, the property is true; otherwise, replace any pattern by its (left-hand side) image. If one denotes by f the function that associates with a tree the sum of the cardinality of the right sub-tree of each node, then f strictly decreases from T to the new tree T' , hence proving that the process stops after a certain number of steps. ■

Note that f is the classical invariant that shows that the Tamari order is anti-symmetric.

Definition 3.5. We say that an edge of T is rewritable if its extremities belong to one of the relations above, either on the left or on the right.

So if one changes a rewritable edge into its rewriting thanks to the relations, it remains rewritable by definition. Then one can check that for all 5 shapes of binary trees with 3 nodes, there exists exactly 16 trees whose two edges are rewritable. Using the rewriting relations, we can group those trees into 16 pentagons of equivalent trees where each shape appears exactly once and each edge is rewritable. Here is an example:

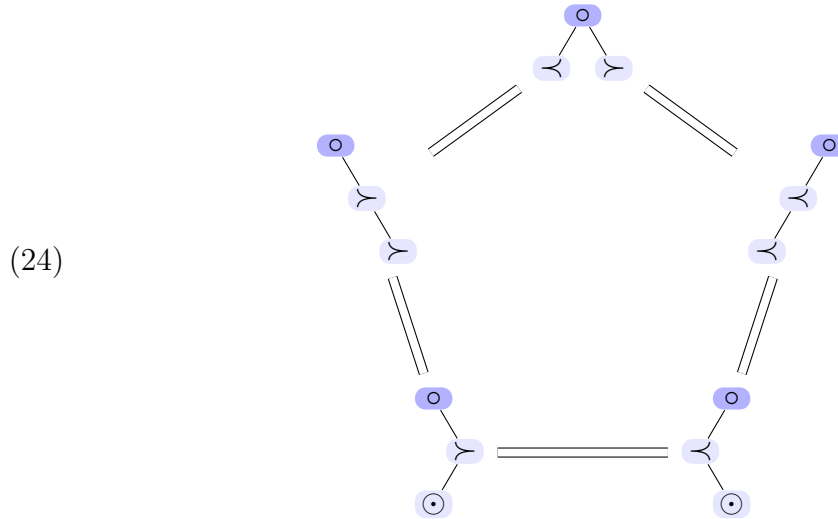

Note that each pentagon contains exactly one canonical tree. As a consequence, there are only three kinds of equivalence classes of trees with three nodes: singleton (tree with no rewriting), pairs (trees with only one rewriting), and pentagons (trees with two rewritings). This has the fundamental consequence that rewriting an edge in any tree does not create new rewritable edges. We can therefore prove that:

Lemma 3.6. Each equivalence class modulo Relations (23) contains exactly one canonical tree.

Proof. We claim that given tree T , the number of rewritable edges does not change if one rewrites a given edge. It is obvious for a rewritable edge that has no node in common with any other rewritable edge. Thanks to the pentagonal relations, this is also true if one rewrites an edge adjacent to another one. Now, if two rewritable edges do not share a node, one can rewrite both in any order and obtain the same final tree. If two rewritable edges share a node, the pentagonal relations show that if one rewrites any of the two edges, one will always end ultimately with the same tree. Otherwise said, the rewriting system is *locally confluent* and hence confluent.

Hence, one can do the rewritings in any order, the resulting tree is always the same. So there only is one tree that avoids all patterns on the right-hand sides in each class. ■

Note 3.7. *Note that two different trees of the same shape are necessarily in different classes. Otherwise, one could find two sequences of rewritings starting from these trees and leading to the same canonical form. Using the pentagons (and squares), one can assume that the underlying sequences of rotations of trees are the same. But then the sequences of rewritings are the same, hence the trees are the same, which is absurd.*

Moreover, all shapes of trees appearing in a class form an interval of the Tamari lattice (thanks to the observation about rewritable edges) and the representative of a class is the tree closest to the left comb.

Finally, note that thanks to the existence of simple canonical trees, one easily obtains an equation satisfied by the generating series of the cardinalities of the operad. Indeed, the eight relations (23) when oriented provide the following relations. Let us denote by F , l , m , r , s respectively the generating series of all canonical trees, all canonical trees having \prec , \circ , \succ , and \odot as their root.

We then get

$$(25) \quad \begin{cases} F = l + m + r + s + 1, \\ l = x F (l + m + r + 1), \\ m = x F (s + 1), \\ r = x F (s + 1), \\ s = x F (l + m + r + 1). \end{cases}$$

Then, summing the last four equations, one finds

$$(26) \quad F - 1 = x F 2(F + 1),$$

which is also

$$(27) \quad 2x F^2 + (2x - 1)F + 1 = 0.$$

In the system of equations (25), binary trees are counted according to the number of internal nodes, whereas in the context of operads, it is more natural to count trees by the number of leaves. To compare Equation (27) with Equation (37), it is therefore necessary to replace F by F/x in the former.

We shall show in section 4.4.2 that this generating series is also the generating series of \mathcal{FF}_4 . We first need a third operad isomorphic to these first two, based on trees.

Note 3.8. *The presentation given here is quadratic and confluent. By choosing an appropriate monomial order, this gives a quadratic Groebner basis. By a known result [7, 14], this implies that \mathcal{GR}_4 is Koszul.*

4. THE OPERADS OF RED AND WHITE TREES

4.1. Red and white trees. Let us consider topological rooted trees, that is, rooted trees with no order on the children, so that each node can have either none, one, or multiple dots in it. If a node has no dots, then it must have at least two children.

The weight of a tree is its number of dots. This set of trees is known in [29] as Sequence A050381, except for the first term that is not 2 but 1.

The first values are

$$(28) \quad 1, 3, 10, 40, 170, 785, 3770, 18805, 96180, 502381, 2667034, 14351775, \dots$$

We shall make use of a small variation on these trees: the nodes will be colored either red or white following the simple rule: a nonempty node is always white and an empty node is red if and only if all its children are white. Since there is only one such way to color the nodes, this set is obviously in bijection with the previous one and is called the *red and white trees* and denoted by \mathbb{RW} . The set $\mathbb{RW}(n)$ is the set of \mathbb{RW} trees of weight n . Depending on what we are discussing, we shall make use of the red and white trees or of the non-colored version.

We shall represent all trees in the following way: the red nodes are represented in red and the others are represented in light blue ².

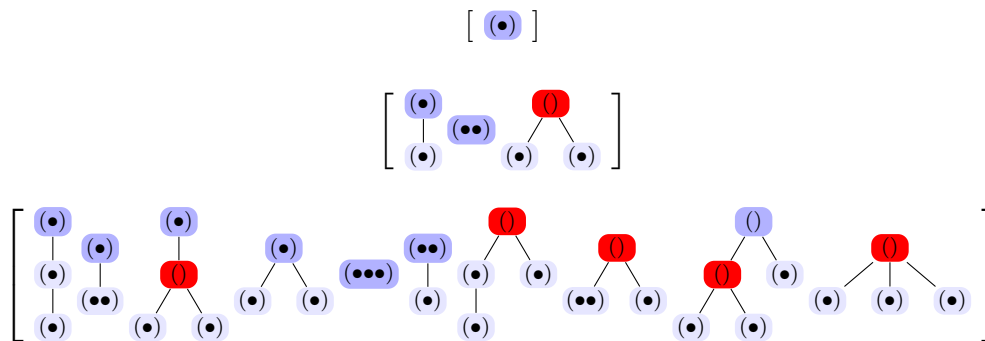

4.1.1. *Labelling red and white trees.* We shall now replace the dots by numbers and label our trees. The first labelling is easy: if a tree belongs to $\mathbb{RW}(n)$, replace each dot by a different integer from $[n] = \{1, \dots, n\}$. We shall denote this set of labellings by $\mathbb{RW}^\Sigma(n)$. The number of such labellings is Sequence A005172 of [29] by definition of this sequence, and their first values are

$$(29) \quad 1, 4, 32, 416, 7552, 176128, 5018624, 168968192, 6563282944, 288909131776, \dots$$

One can give an equivalent definition using the language of species [1] or labeled combinatorial classes [11]. Let \mathcal{Set} be the species of sets (such that $\mathcal{Set}[U] := \{U\}$) and $\mathcal{Set}_{\geq k}$ the species of sets of cardinality at least k . Let \mathcal{Z} denote the singleton species (one object in size 1). We denote by $+$ the sum of species (disjoint union of labelled classes) and by \cdot the product of species (Cartesian product of labelled classes). Finally the substitution is denoted functionally (as in $\mathcal{A}(\mathcal{B})$).

Then $\mathcal{F} := \mathbb{RW}^\Sigma$ is the solution of the equation

$$(30) \quad \mathcal{F} = \mathcal{Set}_{\geq 2}(\mathcal{F}) + \mathcal{Set}_{\geq 1}(\mathcal{Z}) \cdot \mathcal{Set}(\mathcal{F}).$$

As a consequence, their exponential generating function $F = F_{\mathbb{RW}^\Sigma}$ satisfies

$$(31) \quad F = \exp(F) - 1 - F + (\exp(x) - 1) \exp(F).$$

²When viewed in black-and-white, red appears dark and blue appears light.

4.2. Operad structure on labelled red and white trees. Let us consider two trees T_1 and T_2 and a label x inside T_1 belonging to node z . To ensure that the composition of two trees is a tree labelled by distinct integers, we shall first renumber T_1 and T_2 as follows: shift all labels greater than x in T_1 by the size of T_2 , and shift all labels of T_2 by $x - 1$.

The composition $T_1 \circ_x T_2$ is then defined as

- (W) If the root of T_2 is not red, erase x in z , add the labels (if any) of the root of T_2 to z and put the children of the root of T_2 as new children of z .
- (R) If the root of T_2 is red, consider three cases:
 - (R1) If T_1 is the tree with one node labelled x , then the result is T_2 .
 - (R2) If z is not a leaf or if z is a leaf with multiple labels, start with T_1 , remove x from the labels of z and glue the root of T_2 as a child of z .
 - (R3) Otherwise, z is a leaf and not the root, and x is its only label. Consider z' , the parent of z . Then remove the leaf z and put all children of the root of T_2 as new children of z' .

In all cases, if z has no remaining labels, it is colored as white.

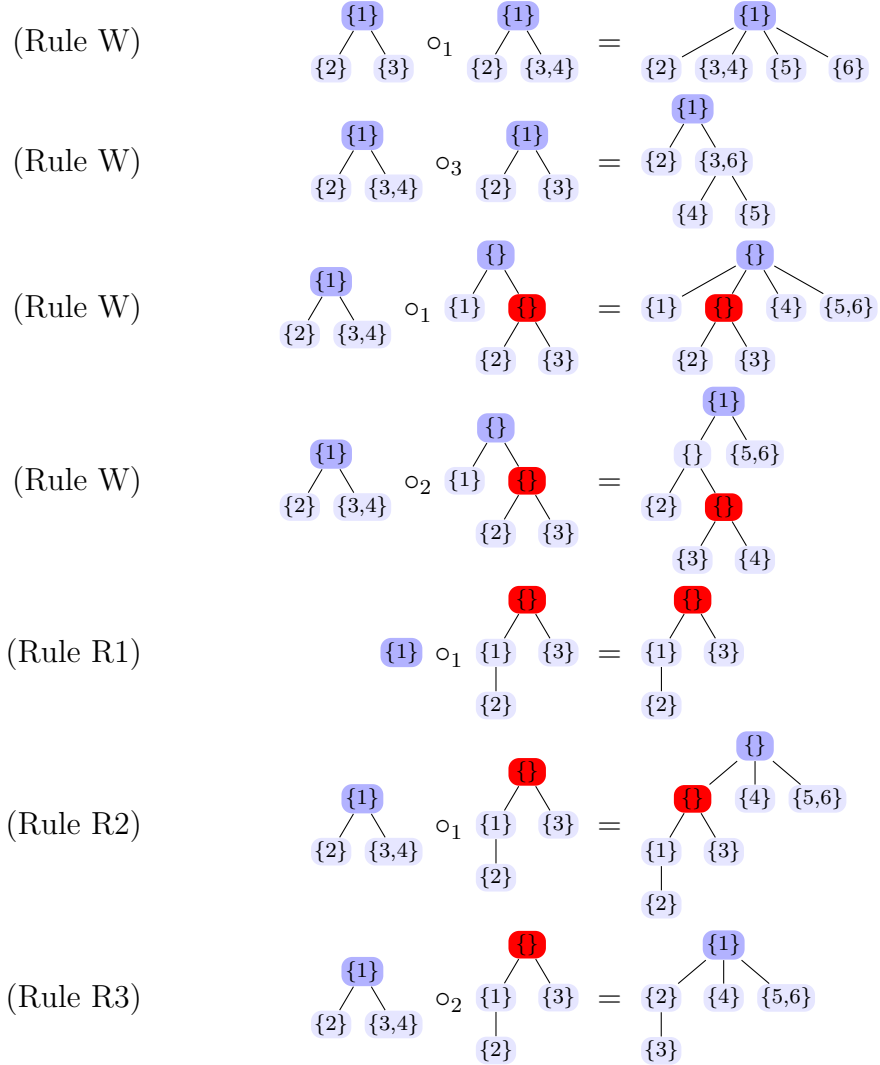

Theorem 4.1. *The set RW^Σ endowed with operations \circ_x is a symmetric set-operad.*

Proof – Let us first check that the \circ_i are internal. The only problem that could arise would be to have two red nodes as father and child, one being created by emptying a node of the first tree. But any new empty node has at least two children, so that this cannot happen.

Let us now check that the operations \circ_x satisfy the axioms of an operad, that is: if x and y are two labels of a tree A , and t a label of a tree B ,

$$(32) \quad (A \circ_x B) \circ_y C = (A \circ_y C) \circ_x B, \quad (A \circ_x B) \circ_t C = A \circ_x (B \circ_t C).$$

Note that when applying the composition rule $A \circ_x B$, only the node labelled x in A is changed. So the first equation is trivial except in the case where x and y are in the same node z . In that case, we need to consider all four cases for the roots of B and C . If both are not red, case (W) applies twice and the result is obvious. If one is red, say the root of B and not the other, then case (R2) applies twice when substituting

B since z cannot both be a leaf and have only one label. Case W applies twice when substituting C so the result of both hand-sides is the same. Now, if both roots of B and C are red, for the same reason as before, both substituting go by application of rule $(R2)$ again, so the same result holds.

Let us now check the second rule of operads. If any tree is a single root with one label, the equality is clear. Now, the root of B can never become red after $B \circ_z C$. So the substitution of B into A goes along the same case as the substitution of $B \circ_z C$ into A since the distinction between the (R) cases only relies on properties of A . Now, the substitution of C into B also in obtained by applying the same case as its substitution into $A \circ_x B$, so that the result on both sides is always the same. ■

Note 4.2. *In fact, this composition defines a symmetric operad, which will be considered in Section 6.*

4.3. The operad RW and recursively labelled red-white trees. We shall be interested now in the sub-operad RW of the operad RW^Σ on all labelled red and white trees, which is generated by the four elements of size 2 (and containing the element of size 1):

$$(33) \quad \left[\begin{array}{c} \{1\} \\ | \\ \{2\} \end{array}, \{1,2\}, \begin{array}{c} \{2\} \\ | \\ \{1\} \end{array}, \begin{array}{c} \{1\} \\ / \quad \backslash \\ \{2\} \quad \{1\} \end{array} \right].$$

4.3.1. *Recursively labelled red-white trees.*

Definition 4.3. *We say that a labelling of a tree in $\text{RW}(n)$ is recursive if, for any node, the set of labels of all its descendants (including its own labels) is an interval of $[n]$.*

We shall denote this set of labellings by $\text{RW}(n)$. The number of such labeled trees is given by Sequence A156017 of [29] and their first values are

$$(34) \quad 1, 4, 24, 176, 1440, 12608, 115584, 1095424, 10646016, 105522176, 1062623232, \dots$$

Here are the first examples:

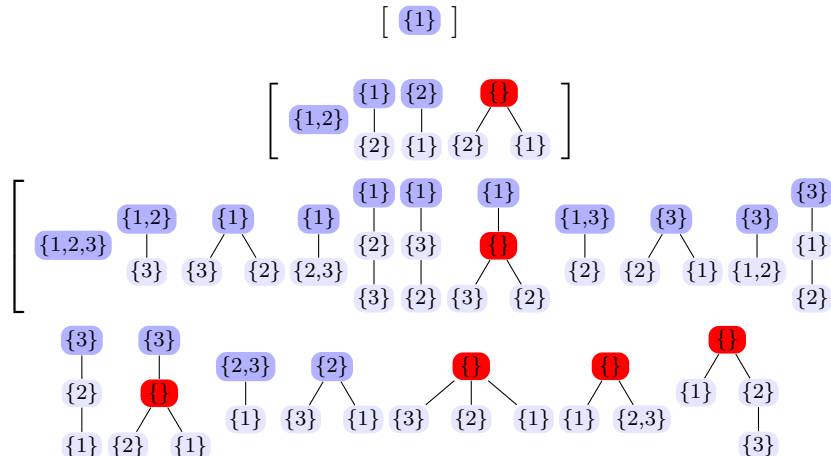

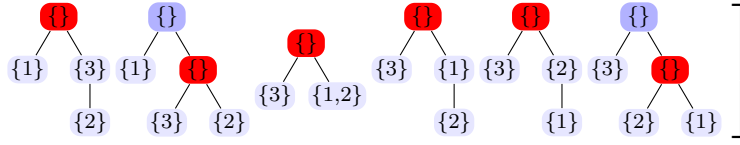

Let $F := F_{\text{RW}}$ be the ordinary generating series of such trees. Because of the recursive labeling, trees having an empty root (and thus at least two sub-trees) are in bijection with sequences of length at least 2 of trees as follows: the sequence (t_1, t_2, \dots, t_r) with $r \geq 2$ of trees of sizes (s_1, \dots, s_r) , corresponds to the following trees

$$(35) \quad (t_1, t_2, \dots, t_r) \longleftrightarrow \begin{array}{c} \boxed{\{\}} \text{ or } \boxed{\{1\}} \\ \swarrow \quad \downarrow \quad \searrow \\ t_1 \quad t_2[s_1] \quad \dots \quad t_r[s_1 + \dots + s_{r-1}] \end{array}$$

where $t[k]$ denote the tree obtained from t by adding k to all integers in the labels. Therefore the generating series of those trees is given by $1/(1 - F) - 1 - F$. In a similar fashion, there is a bijection between trees and non-empty sequences of either a dot (labelled 1) or a tree, by shifting the labels (including dots) as previously and gathering dots into the roots. Here is an example:

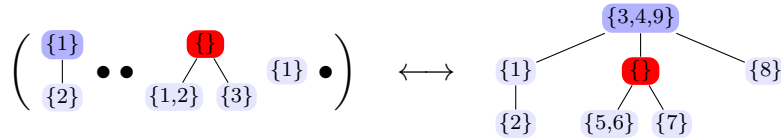

Since we are here only considering trees without empty root, their generating series is therefore $(x + F)/(1 - (x + F)) - F/(1 - F)$. Summarizing the previous reasoning we get that, the ordinary generating series $F := F_{\text{RW}}$ satisfies

$$(36) \quad F = 1/(1 - F) - 1 - F + (x + F)/(1 - (x + F)) - F/(1 - F),$$

that is, after simplifications and clearing the denominator

$$(37) \quad F = x + 2xF + 2F^2.$$

One then easily checks that this equation is the same as Equation (27) (up to multiplication by x) obtained for the number of canonical \mathcal{GR}_4 trees, hence suggesting that a natural operad isomorphism exists between the two structures. We shall first check that the recursively labelled trees are indeed elements of an operad.

4.3.2. The sub-operad RW.

Proposition 4.4. *The elements of RW are the recursively labelled red and white trees.*

Proof – First, let us note that the composition \circ_x of two recursively labelled red and white trees T_1 and T_2 gives rise to a recursively labelled red and white tree T . Indeed, T is a labelled tree. Now, if the node that contains x on T_1 has as set of labels of descendants $[y, z]$, the corresponding node in T has as set of labels of descendants $[y, z + |T_2|]$. Now, since all labels greater than x in T_1 have been shifted by the size $|T_2|$ of T_2 , all nodes of T also have an interval as set of labels of their descendants.

Now, let us prove the converse, that is, that all recursively labelled red and white trees can be obtained as substitutions of smaller trees. The property is true for trees of size at most 2. Now, if a node z of a tree T of size k has more than two labels, T is easily written as a substitution of smaller trees on this node: indeed, T is obtained by substituting the tree with a root labelled $\{1, 2\}$ in the tree T' obtained from T by removing any of the consecutive integers labelling z and then renumbering all labels in order to obtain all numbers from 1 to $k - 1$.

Otherwise, consider a leaf l that is not an uncle/aunt. Let us consider cases depending on the parent p of l :

- If p has x as a label, then $T = T' \circ_y T''$ where T' is obtained from T by changing x into y and removing l , and T'' is the tree having as root x with one child l .

Otherwise, p is empty, and it is necessarily red because if l has some siblings then they are leaves and thus white.

- Now, if l has two siblings or more, then $T = T' \circ_y T''$ where T' is obtained from T by labelling l by y and removing one sibling of l , and T'' is a tree with a red root and two children: l and the missing sibling of l .
- Otherwise, l has only one sibling, p has itself a parent p' , which is white, either labelled or not. In both cases, T is obtained as $T = T' \circ_y T''$ where T' is obtained from T by changing p and its sub-tree by a new leaf labelled y and where T'' is the sub-tree of T of root p .

We conclude by induction on the size of the trees. ■

Theorem 4.5. *The operads RW and \mathcal{GR}_4 are isomorphic as operads.*

Proof – We already know that as sets, RW and \mathcal{GR}_4 are equinumerous. Since \mathcal{GR}_4 is the quotient of the free operad on four generators with eight relations, we only need to prove that the generators of \mathcal{GR}_4 satisfy the same relations. The decoding is the following:

$$(38) \quad \left[\begin{array}{c} \{1,2\} \\ \{1\} \\ \{2\} \\ \{1\} \\ \{2\} \\ \{1\} \end{array} \right] \iff [\circ, \prec, \succ, \odot].$$

The fact that all relations hold is immediate given the definition of the operad RW . For example, the first relation of Equation (23)

$$(39) \quad (x \succ y) \prec z = x \succ (y \prec z),$$

rewrites as

$$(40) \quad (a \prec z) \circ_a (x \succ y) = (x \succ a) \circ_a (y \prec z),$$

which rewrites in the red and white trees as

$$(41) \quad \begin{array}{c} \{a\} \\ | \\ \{z\} \end{array} \circ_a \begin{array}{c} \{y\} \\ | \\ \{x\} \end{array} = \begin{array}{c} \{a\} \\ | \\ \{x\} \end{array} \circ_a \begin{array}{c} \{y\} \\ | \\ \{z\} \end{array},$$

which is true since both expressions are equal to

$$(42) \quad \begin{array}{c} \{y\} \\ \swarrow \quad \searrow \\ \{x\} \quad \{z\} \end{array}$$

The trees corresponding to the eight relations are

$$(43) \quad \begin{array}{c} \{y\} \\ \swarrow \quad \searrow \\ \{x\} \quad \{z\} \end{array}, \quad \{xyz\}, \quad \begin{array}{c} \{yz\} \\ | \\ \{x\} \end{array}, \quad \begin{array}{c} \{xz\} \\ | \\ \{y\} \end{array}, \quad \begin{array}{c} \{xy\} \\ | \\ \{z\} \end{array}, \quad \begin{array}{c} \{\} \\ \swarrow \quad \downarrow \quad \searrow \\ \{x\} \quad \{y\} \quad \{z\} \end{array}, \quad \begin{array}{c} \{x\} \\ \swarrow \quad \searrow \\ \{y\} \quad \{z\} \end{array}, \quad \begin{array}{c} \{z\} \\ \swarrow \quad \searrow \\ \{x\} \quad \{y\} \end{array}.$$

■

4.4. **From red and white trees to \mathcal{FF}_4 .** Let us summarize what we have in terms of operads. We first have the operad \mathcal{GR}_4 that is sent surjectively to the operad \mathcal{FF}_4 since \mathcal{GR}_4 is the quotient of the free operad on four generators with eight relations and that \mathcal{FF}_4 has four generators and satisfies the eight relations. We also have that \mathcal{GR}_4 and RW are isomorphic operads on equinumerous sets. To conclude that \mathcal{FF}_4 is isomorphic to \mathcal{GR}_4 , it only remains to prove that there exists an injective morphism of operads Φ from RW to \mathcal{FF}_4 that makes the diagram below commutative.

$$\begin{array}{ccc} \mathcal{GR}_4 & \longrightarrow & \mathcal{FF}_4 \\ \cong \downarrow & \nearrow \Phi & \downarrow \\ \text{RW} & \xrightarrow{\Phi} & \mathcal{FF} \end{array}$$

Our injective morphism is a set morphism, that is, a bijection.

4.4.1. *An injection from RW^Σ to the fractions in \mathcal{FF} .* We define here a map from labelled red and white trees to formal fractions, that will be a bijection with its image.

The bijection is as follows. Consider a red and white tree T . For each node z , compute the set $S(z)$ of all values in the sub-tree of root z and then define $E(z)$ as either

$$(44) \quad \begin{cases} \frac{1}{|S(z)|} & \text{if } z \text{ is white,} \\ |S(z)| & \text{if } z \text{ is red and not the root,} \\ 1 & \text{if } z \text{ is red and the root.} \end{cases}$$

The fraction associated with T is then

$$(45) \quad \Phi(T) := \prod_{z \in \text{nodes}(T)} E(z).$$

For example, we have

$$\begin{array}{c} \{5\} \\ \swarrow \quad \searrow \\ \{1,2\} \quad \{\} \\ \swarrow \quad \searrow \quad \swarrow \quad \searrow \\ \{\} \quad \{8\} \quad \{\} \\ \swarrow \quad \searrow \quad \swarrow \quad \searrow \\ \{3\} \quad \{4\} \quad \{6\} \quad \{7\} \end{array} \quad \frac{[34][67]}{[3][4][1234][6][7][8][678][12345678]}$$

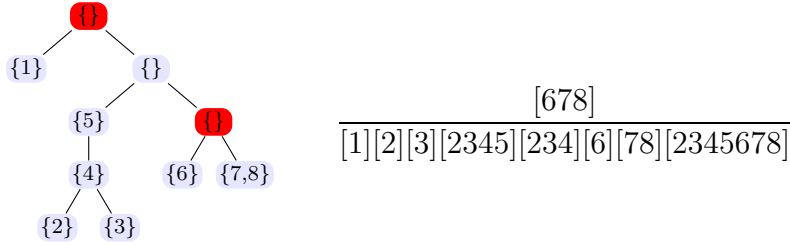

Lemma 4.6. Φ is an injective map from RW^Σ to \mathcal{FF} .

Proof. We prove that one easily rebuilds the tree from the fraction: let us show how to rebuild the root, the rest of the construction being done recursively. Let F be a fraction obtained by the previous process. Let S be the union of all values in the fraction.

Either $[S]$ belongs to the fraction or not. If not, the root is red, separate $[S]$ in the greatest possible number of sets (into the coarsest partition) so that any element of F is a subset of one of these sets. These are the children of the root. Iterate the process on each child separately.

If $[S]$ belongs to F , then it is on the denominator of F . Then the root is white and labelled by $[S]$ minus the union of all values of the fraction $F' = [S]F$. Note that the root might be empty. Then split F' as in the case of the red root and iterate. ■

4.4.2. *The main theorem.*

Theorem 4.7. *The three set-operads RW on red and white trees, \mathcal{FF}_4 on formal fractions and \mathcal{GR}_4 are isomorphic.*

Proof – We first show that the bijection Φ between RW and some formal fractions is compatible with the operad \circ_i operations, meaning that it is a morphism of operads from RW to \mathcal{FF} .

Let us check this for the various cases (W) , $(R1)$, $(R2)$ and $(R3)$ in the composition $T_1 \circ_x T_2$ of elements of RW. Let z be the vertex of T_1 containing x , which is necessarily non-empty and therefore white. Let f_1 and f_2 be the fractions associated to T_1 and T_2 by Φ . Let \hat{f}_1 be the fraction obtained from f_1 by replacing x by the indices of T_2 . Let S_2 be the set of indices of T_2 .

In the (W) case, the root of T_2 is not red and the vertex corresponding to z in $T_1 \circ_x T_2$ remains white. By the description of $(R2)$ and the definition of Φ , the fraction associated to $T_1 \circ_x T_2$ is the product of $f_2[S_2]$ (coming from vertices of T_2 except the white root) and \hat{f}_1 (coming from vertices of T_1).

The $(R1)$ case follows from the fact that the unit of the operad RW is mapped to the unit of the operad \mathcal{FF} .

In the $(R2)$ case, the root of T_2 is red, and the vertex corresponding to z in $T_1 \circ_x T_2$ remains white. By the description of $(R2)$ and the definition of Φ , the fraction associated to $T_1 \circ_x T_2$ is the product of \hat{f}_1 (from vertices coming from T_1), f_2 (from vertices coming from T_2 other than the root of T_2) and $[S_2]$ (coming from the red root of T_2 , which becomes a non-root red vertex).

In the (R3) case, the root of T_2 is red. By the description of (R2) and the definition of Φ , the fraction associated to $T_1 \circ_x T_2$ is the product of f_2 (from vertices coming from T_2 other than the root of T_2) and $\hat{f}_1[S_2]$ (from vertices coming from T_1 , except the vertex z which was white and is removed)

In all cases, the fraction obtained is the same as the fraction $f_1 \circ_x f_2$ which is $[S_2]\hat{f}_1 f_2$ by the composition rule (8) of \mathcal{FF} . This proves that Φ is a morphism of operads from RW to \mathcal{FF} .

One can check on the four generators of \mathcal{GR}_4 that the inclusion of \mathcal{GR}_4 in \mathcal{FF}_4 is the same as the composite of Φ and the isomorphism of \mathcal{GR}_4 and RW.

This also proves that the image of RW by the bijection Φ is the same as the image of the set-operad \mathcal{GR}_4 since all fractions can be obtained by applying the substitutions \circ_i to the generators. ■

Here are a \mathcal{GR}_4 tree, its corresponding red and white tree and its fraction.

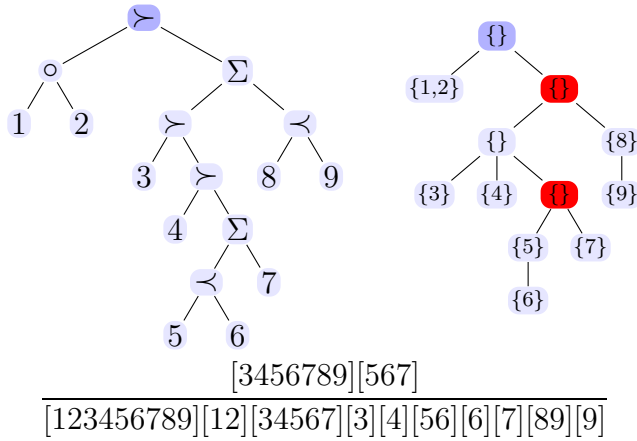

5. REMARKABLE SUB-OPERADS

As set-operads, there are many interesting and already known sub-operads of RW. On \mathcal{GR}_4 trees, they correspond to selecting some operations inside the four possible ones. We shall see some examples and describe how they can be seen in terms of trees in RW.

5.1. The operad RW_T . Let us consider the sub-set-operad RW_T of red and white trees generated by

$$(46) \quad \left\{ \begin{array}{c} \{1,2\} \\ \{1\} \quad \{2\} \\ \{2\} \quad \{1\} \end{array} \right\}.$$

We then have:

Theorem 5.1. *The set sub-operad RW_T of RW generated by the three previous trees has as elements the red and white trees with no empty nodes.*

Proof – Given the product rules of RW (see Subsection 4.2), one easily checks that all trees belonging to RW_T have no empty nodes.

Conversely, using the same technique as in the proof of Proposition 4.4, one checks that any tree with no empty nodes can be obtained as a composition of strictly smaller such trees. ■

So the cardinalities of this operad is Sequence A200757 of [29], whose first elements are

$$(47) \quad 1, 3, 13, 68, 395, 2450, 15892, 106489, 731379, 5121392, 36425796, 262425982, \dots$$

with ordinary generating series $F = F_{\text{RW}_T}$ satisfying

$$(48) \quad F = (x + F)/(1 - (x + F)) - F/(1 - F),$$

which is therefore algebraic.

Note 5.2. *For the corresponding unlabelled trees, we get the set of rooted trees with multiple dots, that correspond to Sequence A036249 of [29]. Their first numbers of elements are*

$$(49) \quad 1, 2, 5, 13, 37, 108, 332, 1042, 3360, 11019, 36722, 123875, 422449, 1453553, \dots$$

5.2. **The operad RW_D .** One can consider the subset RW_D of RW_T of the subset RW generated by

$$(50) \quad \left\{ \begin{array}{c} \{1\} \\ | \\ \{2\} \end{array}, \begin{array}{c} \{2\} \\ | \\ \{1\} \end{array} \right\}.$$

We then have:

Theorem 5.3. *The set sub-operad RW_D of RW_T generated by the two previous trees has as elements the red and white trees with no empty nodes and no multiple labels in their nodes. These trees are in immediate bijection with recursively labelled rooted trees.*

Proof – The proof is the same as in Theorem 5.1. ■

This set of trees corresponds to the set of trees that are in bijection with the \mathcal{GR}_4 trees only containing \prec and \succ in their internal nodes. The cardinalities of this operad is Sequence A006013 of [29], whose first elements are

$$(51) \quad 1, 2, 7, 30, 143, 728, 3876, 21318, 120175, 690690, 4032015, 23841480, \dots$$

with ordinary generating series $F = F_{\text{RW}_D}$ satisfying

$$(52) \quad F = x/(1 - F)^2,$$

which is therefore algebraic.

This corresponds to the set-operad based on non-crossing trees [17, 5].

5.3. **The operad RW_{DS} .** There is another trickier way to study the sub-set-operads of RW . Let us consider the sub-set-operad RW_{DS} of red and white trees generated by

$$(53) \quad \left\{ \begin{array}{c} \{2\} \\ | \\ \{1\} \end{array}, \begin{array}{c} \{1\} \\ | \\ \{2\} \end{array}, \begin{array}{c} \{0\} \\ / \quad \backslash \\ \{2\} \quad \{1\} \end{array} \right\}.$$

We then have:

Theorem 5.4. *The set sub-operad RW_{DS} of RW generated by the three previous trees has as elements the red and white trees with no multiple labels and that avoid the two following patterns: no labelled node can have a red child, and no white node can have two red children.*

Proof – Let us first show that the \circ_i are internal on this set. Let us consider the different cases appearing when computing $T = T_1 \circ_x T_2$, with T_1 and T_2 in RW_{DS} . If the root of T_2 is not red, T also belongs to RW_{DS} . If the root of T_2 is red, and if z is not a leaf, then z , being labelled by x , cannot have a red child. So T has now a white empty node (replacing z) with only one red child. So T also belongs to RW_{DS} .

If the root of T_2 is red and z is a leaf, then the parent of z (if z has no parent, $T = T_2$ and the statement is trivial) can be whatever node, it only gets white children, which does not fall in any forbidden pattern.

Now, given such a tree, one easily sees that it can be obtained as a composition of strictly smaller such trees. ■

As a species, $\mathcal{F} = \mathcal{F}_{\text{RW}_{\text{DS}}}$ is the solution of

$$\mathcal{F} = \mathcal{R} + \mathcal{W}$$

$$\mathcal{R} = \text{Set}_{\geq 2}(\mathcal{W})$$

$$\mathcal{W} = \mathcal{R} \cdot \text{Set}_{\geq 1}(\mathcal{W}) + \mathcal{Z} \cdot \text{Set}(\mathcal{W})$$

Here are the recursively labelled trees in RW of size 3:

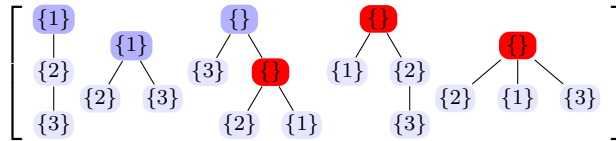

Here are those of size 4:

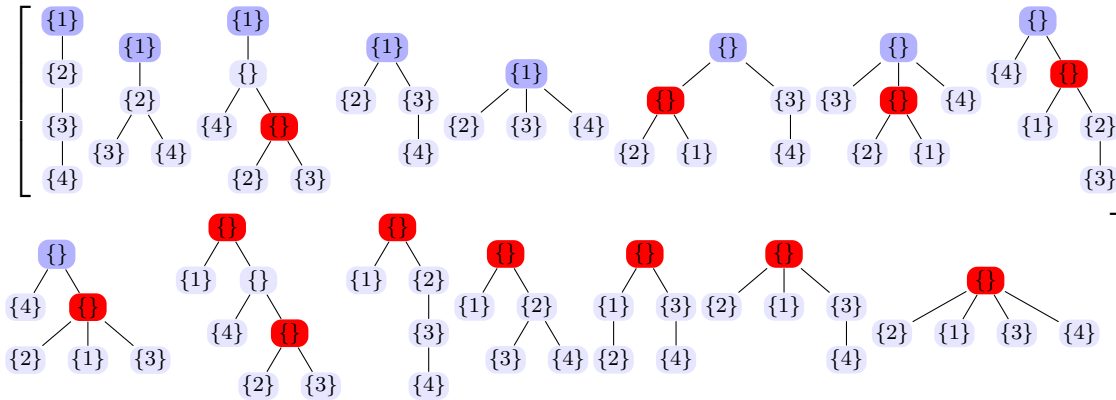

The trees are in bijection with the \mathcal{GR}_4 trees only containing \prec , \succ , and \odot in their internal nodes. So

Corollary 5.5. *The set-operad on RW_{DS} is isomorphic to the set-operad on the three tridendriform operations \prec , \odot , and \succ .*

The cardinalities of this operad is Sequence A121873 of [29], whose first elements are

$$(54) \quad 1, 3, 14, 80, 510, 3479, 24848, 183465, 1389090, 10726452, 84150858, \dots$$

with ordinary generating series $F = F_{\text{RW}_{\text{DS}}}$ satisfying

$$\begin{aligned} F &= R + W \\ R &= 1/(1 - W) - 1 - W \\ W &= R/(1 - W)^2 - R + x/(1 - W)^2, \end{aligned}$$

which is therefore algebraic.

This corresponds to the operad of noncrossing plants already defined by Chapoton [2].

This sequence also appears as Example (g) in [23].

6. SYMMETRIC OPERADS

All results presented above have analogs in the world of symmetric operads. Indeed, given either the \mathcal{GR}_4 trees, or the red and white trees, or the fractions, one can consider their pendant as symmetric operads.

6.1. The symmetric operad on red and white trees. In Section 4.2, an operad structure was defined on the set of red and white trees with arbitrary labeling. Relabeling by a permutation clearly defines an action of the symmetric groups. Those tree forms a species which is defined by Equation (30).

Theorem 6.1. *The set RW^Σ endowed with operations \circ_x and the natural symmetric groups actions has a symmetric set-operad structure. This operad will be also be denoted by RW^Σ .*

Proof. The definition of the composition clearly commutes with relabeling. ■

Let us investigate more closely the actions of the groups. The species equation allows to compute the characters of the representations which we prefer to encode as a symmetric function using Frobenius characteristic (see e.g. [24]). Using the notations from the later, Equation (30) translate directly on Frobenius characteristic into the following equation:

$$(55) \quad F = (E_1 \circ F - 1 - F) + (E_t - 1)(E_1 \circ F)$$

where $E_t = \sum_{i \geq 0} e_i t^i$ is the generating series of elementary symmetric functions, and \circ is the plethysm operation. The solution of this equation can be computed inductively. Here are the first few terms expanded on Schur functions:

$$s_1, s_{1,1} + 3s_2, 10s_3 + 2s_{1,1,1} + 10s_{2,1}, 6s_{1,1,1,1} + 40s_4 + 64s_{3,1} + 38s_{2,2} + 34s_{2,1,1}$$

We also need some information on the orbits:

Proposition 6.2. *Under the action of the symmetric groups on RW^Σ there exists at least one recursively labeled tree in each orbit.*

Proof. It is sufficient to prove that there exists a recursive labeling for each unlabeled red and white tree. This is clear as such a labeling can be obtained by a recursive depth-first walk of a tree labeling for example the dots in the roots before the dots in the sub-trees. ■

Corollary 6.3. *As a symmetric operad, RW^Σ is generated by the trees:*

$$(56) \quad G^\Sigma := \left\{ \begin{array}{c} \{1\} \\ | \\ \{2\} \end{array}, \begin{array}{c} \{1,2\} \end{array}, \begin{array}{c} \{1\} \\ / \quad \backslash \\ \{2\} \quad \{1\} \end{array} \right\}.$$

Proof. Note that the action of the transposition (12) on $e := \begin{array}{c} \{1\} \\ | \\ \{2\} \end{array}$ is $f := \begin{array}{c} \{2\} \\ | \\ \{1\} \end{array}$. Therefore it is not necessary to put the later in the generators. By Proposition 4.4, the set of elements obtained by composition from $G^\Sigma \cap \{f\}$, without using the action of the symmetric groups is exactly the set of recursively labeled trees. Therefore using the action we get at least the set of the orbit of the recursively labeled trees, that is all labeled trees. ■

The main goal of this section is to show that the symmetric operad RW^Σ is isomorphic to the symmetric sub-operad of formal fraction generated by the corresponding fraction.

6.1.1. *The symmetric operad on fractions.* In Section 4.4.1, we defined a map ϕ from red and white tree to formal fraction; See Equation (45). We showed that this map restricted to recursively labeled trees is an isomorphism of (non-symmetric) operads from RW to \mathcal{FF} . It is also an isomorphism of symmetric operads:

Theorem 6.4. *The map Φ is an isomorphism of symmetric operads from RW^Σ to the sub-operad of \mathcal{FF}^Σ generated by the fractions:*

$$(57) \quad F_{\succ} := \frac{1}{[1][12]}, \quad F_{\circ} := \frac{1}{[12]}, \quad F_{\circlearrowleft} := \frac{1}{[1][2]}.$$

Note: the action of the transposition (1,2) on F_{\succ} is $F_{\prec} := \frac{1}{[2][12]}$.

Proof. We already proved (Lemma 4.6) that as a set map Φ is injective from RW^Σ to \mathcal{FF} . From its definition it is also clear that Φ commutes with the action of the symmetric group. Now we know that on recursively labeled trees, Φ commute with compositions \circ_i (Theorem 4.7). Since there is a recursively labeled tree in every orbit, using the action we get that Φ commute with compositions \circ_i on all red and white trees. Therefore Φ is an injective symmetric operad morphism from RW^Σ to \mathcal{FF}^Σ . Let us consider its image $\Phi(\text{RW}^\Sigma)$. It is generated by $\{\Phi(g) \mid g \in G\}$, where G is any generating set of RW^Σ . The theorem is then obtained using the set \mathbf{G}^Σ of Equation (56). ■

6.2. The symmetric sub-operads. Let us consider a subset of the generators of RW and the symmetric and non symmetric operads generated by this subset. Using the same argument as in Proposition 6.2 and Corollary 6.3, one sees that the underlying set of the symmetric one is given by the orbits of the symmetric group on the underlying set of the non-symmetric one. This amounts to consider the set of the same red and white trees with no restrictions on the labels.

6.2.1. *The symmetric sub-operad $\text{RW}_{\mathbb{T}}^{\Sigma}$.* Let us consider the symmetric analog of $\text{RW}_{\mathbb{T}}$. When labelling red and white trees with no empty nodes with different integers from 1 to n without any other constraint, one gets Sequence A048802 of [29] whose first number of elements are

$$(58) \quad 1, 3, 16, 133, 1521, 22184, \dots$$

with exponential generating function $F = F_{\text{RW}_{\mathbb{T}}^{\Sigma}}$ satisfying

$$(59) \quad F = (\exp(x) - 1) \exp(F).$$

6.2.2. *The symmetric sub-operad $\text{RW}_{\mathbb{D}}^{\Sigma}$.* Let us consider the symmetric analog of $\text{RW}_{\mathbb{D}}$. When labelling red and white trees with no empty or multiple nodes with different integers from 1 to n without any other constraint, one gets Sequence A000169 of [29] whose value is n^{n-1} and first number of elements are

$$(60) \quad 1, 2, 9, 64, 625, 7776, 117649, 2097152, 43046721, 1000000000, 25937424601$$

with exponential generating function $F = F_{\text{RW}_{\mathbb{D}}^{\Sigma}}$ satisfying

$$(61) \quad F = x \exp(F).$$

This is isomorphic to the set-operad NAP^3 [18], because it is generated by one generator which satisfies the same relations as the generator of the NAP operad and the dimensions are the same.

6.2.3. *The symmetric sub-operad $\text{RW}_{\mathbb{D}\mathbb{S}}^{\Sigma}$.* Let us consider the symmetric analog of $\text{RW}_{\mathbb{D}\mathbb{S}}$. When labelling the corresponding red and white trees with different integers from 1 to n without any other constraint, one gets Sequence A048172 of [29] whose first terms are

$$(62) \quad 1, 3, 19, 195, 2791, 51303, 1152019, 30564075, 935494831, 32447734143, \dots$$

with exponential generating function $F = F_{\text{RW}_{\mathbb{D}\mathbb{S}}^{\Sigma}}$ satisfying

$$F = R + W,$$

$$R = \exp(W) - 1 - W,$$

$$W = R(\exp(W) - 1) + x \exp(W).$$

Recalling the constraints described in Theorem 5.4, one can obtain this system of equations as follows. Here R (resp. W) denotes the generating series of trees with a red root (resp with a white root). The second equation says that a red root has only white sons. The last equation says that a white root is either empty and has exactly one red son, or has a label and an arbitrary set of white sons.

³standing for Non-Associative Permutative

Note 6.5. *This operad is isomorphic to the operads of shrubs, which was defined in [3, 4] by the very same closure as this operad. The combinatorial objects called shrubs are directed graphs with levels in \mathbb{N} , where arrows go down by one level, satisfying some forbidden pattern conditions. This is rather different at first sight from red and white trees with the given constraints.*

Using the operad structure, once the components of arity 2 have been matched, one can easily define by induction a bijection between shrubs and red and white trees with the given constraints, that gives an isomorphism of operads between the operad of shrubs and $\text{RW}_{\text{DS}}^{\Sigma}$.

7. MORE GENERAL OPERADS ON MORE GENERATORS

Recall that there is a natural morphism from the dendriform operad to the tri-dendriform operad sending \succ to $\circ + \succ$ and \prec to itself (the other convention is also possible). It is therefore very natural to add the counterpart in Mould^1 of $\circ + \succ$ and $\circ + \prec$ to the generating set of \mathcal{FF}_4 . This leads to several interesting operads which do not live in formal fractions, but rather in a slightly more general operad of formal fractions with monomials, which is defined as a Hadamard product. In this section, we present the combinatorial properties of these operads, omitting most of the proofs as they are either direct consequences of the previous results or derived by very similar reasoning.

Recall that the generators of the tridendriform operad are realized as moulds by (15), (16), (17) and (18). With this convention the two new generators are realized as:

$$(63) \quad \circ + \succ \mapsto \frac{u_1}{(u_1 - 1)(u_1 u_2 - 1)}, \quad \circ + \prec \mapsto \frac{u_2}{(u_2 - 1)(u_1 u_2 - 1)},$$

We consider here the sub-operad generated by the four fractions together with these two new. To be able to deal with this operad using formal fractions we need to generalize them a little using an operad on monomials: let $\text{Mon}(n)$ be the set of monomials in u_1, \dots, u_n . The composition defined, for $F \in \text{Mon}(m)$ and $G \in \text{Mon}(n)$, by

$$(64) \quad F \circ_i G := F(u_1, \dots, x_{i-1}, P_{i,n}, u_{i+1}, \dots, u_{m+n-1}) G(u_i, \dots, u_{i+n-1})$$

where $P_{i,n} = u_i u_{i+1} \dots u_{i+n-1}$, endows Mon with a structure of a set-operad. Together with the action of the symmetric group, it becomes a symmetric set-operad denoted by Mon^{Σ} . This operad has already appeared in [21]. One denotes by $\mathcal{MFF} := \text{Mon} \times \mathcal{FF}$ the Hadamard product of these set-operads. Elements of $\mathcal{MFF}(n)$ are pairs $(m, f) \in \text{Mon}(n) \times \mathcal{FF}(n)$, the composition being defined componentwise. We denote such an element by putting the monomial in the numerator of the formal fraction. Then it is clear from the definition of the composition in Mould^1 (by Eq. (5)) that the morphism ϕ_1 from \mathcal{FF} to Mould^1 extends to \mathcal{MFF} :

Proposition 7.1. *The map $\phi_{\mathcal{M}} : (m, f) \mapsto m \phi_1(f)$ is an injective morphism of set-operads from \mathcal{MFF} to Mould^1 . It is also an injective morphism of symmetric set-operads with the symmetric version of those operads.*

7.1. **The 6-generator operad and more.** We now consider the sub-operad \mathcal{FF}_6 of \mathcal{MFF} , generated by the four generator of \mathcal{FF}_4 together with

$$(65) \quad F_{\gg} := \frac{u_1}{[1][12]}, \quad F_{\ll} := \frac{u_2}{[2][12]}.$$

The generators satisfies the following 16 relations:

$$(66) \quad \begin{array}{cccccccc} \begin{array}{c} \odot \\ \diagup \\ \odot \end{array} = \begin{array}{c} \odot \\ \diagdown \\ \odot \end{array} & \begin{array}{c} \circ \\ \diagup \\ \circ \end{array} = \begin{array}{c} \circ \\ \diagdown \\ \circ \end{array} & \begin{array}{c} \circ \\ \diagup \\ \curvearrowright \end{array} = \begin{array}{c} \circ \\ \diagdown \\ \curvearrowright \end{array} & \begin{array}{c} \circ \\ \diagup \\ \llcorner \end{array} = \begin{array}{c} \circ \\ \diagdown \\ \llcorner \end{array} & \begin{array}{c} \circ \\ \diagup \\ \gg \end{array} = \begin{array}{c} \circ \\ \diagdown \\ \gg \end{array} & \begin{array}{c} \circ \\ \diagup \\ \llcorner \end{array} = \begin{array}{c} \circ \\ \diagdown \\ \gg \end{array} & \begin{array}{c} \circ \\ \diagup \\ \gg \end{array} = \begin{array}{c} \circ \\ \diagdown \\ \llcorner \end{array} & \begin{array}{c} \circ \\ \diagup \\ \gg \end{array} = \begin{array}{c} \circ \\ \diagdown \\ \gg \end{array} \\ \begin{array}{c} \curvearrowright \\ \diagup \\ \curvearrowright \end{array} = \begin{array}{c} \curvearrowright \\ \diagdown \\ \odot \end{array} & \begin{array}{c} \llcorner \\ \diagup \\ \llcorner \end{array} = \begin{array}{c} \llcorner \\ \diagdown \\ \odot \end{array} & \begin{array}{c} \llcorner \\ \diagup \\ \odot \end{array} = \begin{array}{c} \llcorner \\ \diagdown \\ \curvearrowright \end{array} & \begin{array}{c} \llcorner \\ \diagup \\ \odot \end{array} = \begin{array}{c} \llcorner \\ \diagdown \\ \curvearrowright \end{array} & \begin{array}{c} \odot \\ \diagup \\ \curvearrowright \end{array} = \begin{array}{c} \odot \\ \diagdown \\ \llcorner \end{array} & \begin{array}{c} \odot \\ \diagup \\ \llcorner \end{array} = \begin{array}{c} \odot \\ \diagdown \\ \gg \end{array} & \begin{array}{c} \odot \\ \diagup \\ \gg \end{array} = \begin{array}{c} \odot \\ \diagdown \\ \llcorner \end{array} & \begin{array}{c} \odot \\ \diagup \\ \gg \end{array} = \begin{array}{c} \odot \\ \diagdown \\ \gg \end{array} \\ \begin{array}{c} \curvearrowright \\ \diagup \\ \circ \end{array} = \begin{array}{c} \circ \\ \diagdown \\ \curvearrowright \end{array} & \begin{array}{c} \circ \\ \diagup \\ \circ \end{array} = \begin{array}{c} \circ \\ \diagdown \\ \llcorner \end{array} & \begin{array}{c} \llcorner \\ \diagup \\ \circ \end{array} = \begin{array}{c} \llcorner \\ \diagdown \\ \llcorner \end{array} & \begin{array}{c} \llcorner \\ \diagup \\ \circ \end{array} = \begin{array}{c} \llcorner \\ \diagdown \\ \llcorner \end{array} & \begin{array}{c} \circ \\ \diagup \\ \curvearrowright \end{array} = \begin{array}{c} \circ \\ \diagdown \\ \circ \end{array} & \begin{array}{c} \circ \\ \diagup \\ \gg \end{array} = \begin{array}{c} \circ \\ \diagdown \\ \circ \end{array} & \begin{array}{c} \circ \\ \diagup \\ \gg \end{array} = \begin{array}{c} \circ \\ \diagdown \\ \llcorner \end{array} & \begin{array}{c} \circ \\ \diagup \\ \gg \end{array} = \begin{array}{c} \circ \\ \diagdown \\ \gg \end{array} \\ \begin{array}{c} \curvearrowright \\ \diagup \\ \curvearrowright \end{array} = \begin{array}{c} \curvearrowright \\ \diagdown \\ \curvearrowright \end{array} & \begin{array}{c} \llcorner \\ \diagup \\ \llcorner \end{array} = \begin{array}{c} \llcorner \\ \diagdown \\ \llcorner \end{array} & \begin{array}{c} \llcorner \\ \diagup \\ \llcorner \end{array} = \begin{array}{c} \llcorner \\ \diagdown \\ \llcorner \end{array} & \begin{array}{c} \llcorner \\ \diagup \\ \llcorner \end{array} = \begin{array}{c} \llcorner \\ \diagdown \\ \llcorner \end{array} & \begin{array}{c} \curvearrowright \\ \diagup \\ \curvearrowright \end{array} = \begin{array}{c} \curvearrowright \\ \diagdown \\ \llcorner \end{array} & \begin{array}{c} \curvearrowright \\ \diagup \\ \llcorner \end{array} = \begin{array}{c} \curvearrowright \\ \diagdown \\ \gg \end{array} & \begin{array}{c} \curvearrowright \\ \diagup \\ \gg \end{array} = \begin{array}{c} \curvearrowright \\ \diagdown \\ \llcorner \end{array} & \begin{array}{c} \curvearrowright \\ \diagup \\ \gg \end{array} = \begin{array}{c} \curvearrowright \\ \diagdown \\ \gg \end{array} \end{array}$$

and generates an operad whose cardinalities are

$$1, 6, 56, 640, 8158, 111258, 1588544, 23446248, 354855218, \dots$$

This can be computed by counting the canonical trees as in Section 3.2. The system of equations for generating series, analog to (25), writes

$$(67) \quad \begin{cases} f = l + L + m + r + R + s + 1, \\ l = x f (l + L + m + r + R + 1), \\ L = x f (l + L + m + r + R + 1), \\ r = x f (R + s + 1), \\ R = x f (l + s + 1), \\ m = x f (s + 1), \\ s = x f (l + L + m + r + R + 1). \end{cases}$$

where f, l, L, m, r, R and s denotes respectively the generating series of all canonical trees, all canonical trees having $\curvearrowright, \llcorner, \circ, \succ, \gg$ and \odot as their root.

Eliminating all the variables but f and x , and setting $F = x f$ gives the following algebraic equation for the generating series

$$(68) \quad F = x + 3x F + (3 + x) F^2 + (1 - x) F^3 - F^4,$$

which can be rewritten as

$$(69) \quad x = F \frac{1 - 3F - F^2 + F^3}{1 + 3F + F^2 - F^3}.$$

To show that there are no other relations, we need to use a generalized red and white trees operad. It is defined as the set of trees where one can put a dot on the edges between two white nodes. The associated fraction is the fraction associated to

non-dotted tree times the product on each label of the variable associated to it to the power the number of dotted edges on the path from the root. This clearly defines an injection $\phi_{\mathcal{M}}$ from dotted red and white trees to \mathcal{MFF} .

Here are two examples:

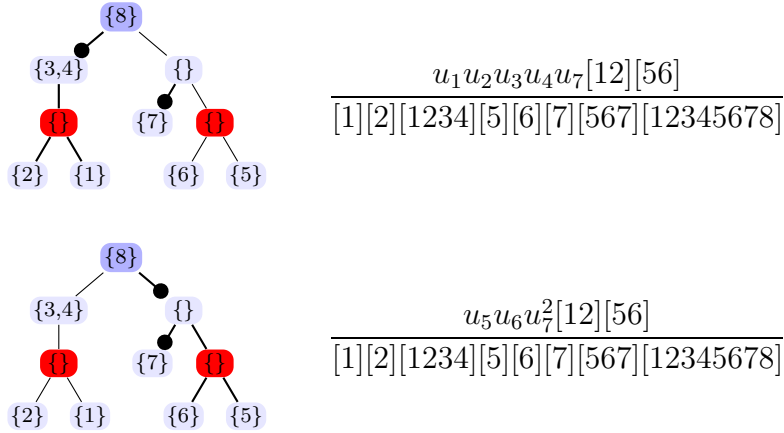

The extension of the rules for the operad composition is straightforward, except for rule (R3) which should be modified as follows: let us consider two trees T_1 and T_2 such that x is the only label of a leaf z . Suppose moreover that there is a dotted edge from z' to z . The composition $T_1 \circ_x T_2$ is then defined as the tree obtained by remove the leaf z and putting the children of the root of T_2 as new dotted children of z' . On can easily check that this defines an operad on dotted trees such that $\phi_{\mathcal{M}}$ is a morphism to \mathcal{MFF} . For example, the following equality

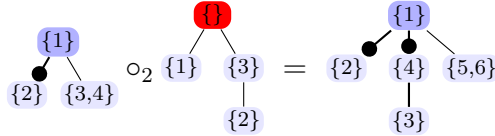

is mapped to the following formal fraction composition

$$\frac{u_2}{[1234][2][34]} \circ_2 \frac{1}{[1][23][2]} = \frac{u_2u_3u_4}{[123456][2][34][3][56]}$$

The number of those dotted trees can be obtained by counting the number of white-white edges in the undotted tree compositions. This can be done by refining Equation (36) using a variable t to record those edges. Then we can show that the generating series verifies the following equations:

$$(70) \quad F = -(t-1)F^4 - (t-1)F^3x - (t-3)F^2x - ((t-1)^2 - 2)F^3 + (2t-1)F^2 + 3Fx + x$$

$$(71) \quad x = F \frac{(t-1)F^3 + (t^2 - 2t - 1)F^2 - (2t-1)F + 1}{(-(t-1)F^3 - (t-3)F^2 + 3F + 1)}$$

Here are the first generating polynomials:

$$\begin{aligned}
 & 1 \\
 & 2t + 2 \\
 & 7t^2 + 11t + 6 \\
 (72) \quad & 30t^3 + 65t^2 + 59t + 22 \\
 & 143t^4 + 397t^3 + 492t^2 + 318t + 90 \\
 & 728t^5 + 2471t^4 + 3857t^3 + 3430t^2 + 1728t + 394
 \end{aligned}$$

One can check that substituting $t = 2$ in (70) gives back (68). This can be used to show the following theorem:

Theorem 7.2. *The set-operad \mathcal{FF}_6 , the operad presented by Equation (66) and the operad of recursively labelled dotted red and white trees are isomorphic.*

Substituting $t = 0$ in the preceding generating series gives the cardinalities of the operad of red and white trees with no white-white edges. It is isomorphic to the operad generated by $\{\circ, \odot\}$ that is the operad with two associative operations and no other relations. The cardinalities are known as large Schroeder number (Sloane's sequence A006318). The leading coefficient corresponds to the operad RW_D .

Finally these t -parametrized generating series suggests the existence of a family of operads RW_k indexed by any integer $k \in \mathbb{N}$ whose generating series of dimensions is given by the solution of Equation (70) with $t = k$. Such an operad can be defined as the extension of the red and white trees where instead of putting dots of one color on white-white edges one can put dots of k possible colors.

7.2. Symmetric counterparts. All the operads considered in the previous subsection have their symmetric counterparts. As a species, the t colored red and white trees are given by the following equation system:

$$\begin{aligned}
 (73) \quad & \mathcal{F} = \mathcal{W} + \mathcal{R} \\
 & \mathcal{R} = \text{Set}_{\geq 2}(\mathcal{W}) \\
 & \mathcal{W} = \text{Set}_{\geq 1}(\mathcal{Z}) \cdot \text{Set}(t\mathcal{W} + \mathcal{R}) + \mathcal{R} \cdot \text{Set}_{\geq 1}(t\mathcal{W}) + \text{Set}_{\geq 2}(\mathcal{R}) \cdot \text{Set}(t\mathcal{W})
 \end{aligned}$$

From the preceding system, one can of course extract equations for the exponential generating series $\mathcal{F}(x)$. Here are the result after eliminating \mathcal{R} and simplifying:

$$\begin{aligned}
 (74) \quad & \mathcal{F} = \exp(\mathcal{W}) - 1 \\
 & \mathcal{W} = \exp(x + t\mathcal{W} + \exp(\mathcal{W}) - \mathcal{W} - 1) + \mathcal{W} - \exp(t\mathcal{W}) - \exp(\mathcal{W}) + 1
 \end{aligned}$$

The coefficients in x count the number of arbitrary labeled red and white trees, with white-white edges colored with t possible color. Here are the first values:

$$\begin{aligned}
 & 1 \\
 & 2t + 2 \\
 & 9t^2 + 15t + 8 \\
 (75) \quad & 64t^3 + 156t^2 + 144t + 52 \\
 & 625t^4 + 2050t^3 + 2675t^2 + 1730t + 472 \\
 & 7776t^5 + 32430t^4 + 55000t^3 + 50310t^2 + 25108t + 5504
 \end{aligned}$$

Dotted trees appear when $t = 2$, giving the following cardinalities:

$$(76) \quad 1, 6, 74, 1476, 41032, 1464672, 63865328, 3290120832, 195537380704$$

Theorem 7.3. *The symmetric set-operad \mathcal{FF}_6^Σ and the symmetric operad of dotted red and white trees are isomorphic.*

As in the non symmetric case, the constant coefficients (Sloane's A006351) are the cardinalities of the operad of red and white trees with no white-white edges. It is isomorphic to the operad generated by $\{\circ, \odot\}$ that is the operad with two associative and commutative operations and no other relations. Indeed, this operad can be naturally encoded by series-parallel networks with n labeled edges. Recall that series-parallel networks are defined as a species by

$$\begin{aligned}
 \mathcal{N} &= \mathcal{Z} + \mathcal{S} + \mathcal{P} \\
 (77) \quad \mathcal{S} &= \text{Set}_2(\mathcal{Z} + \mathcal{P}) \\
 \mathcal{P} &= \text{Set}_2(\mathcal{Z} + \mathcal{S})
 \end{aligned}$$

of course as a species $\mathcal{S} = \mathcal{P}$. The bijection ϕ with red and white trees goes inductively as follows:

- The singleton \mathcal{Z} is the identity of the operad and corresponds to the tree consisting only of a leaf labeled 1;
- A series network with edges labeled by a, b, \dots and with parallel sub-networks A, B, \dots corresponds to a white node labeled by the set $\{a, b, c, \dots\}$ and with red sub-trees $\phi(A), \phi(B), \dots$
- A parallel network with edges labelled by a, b, \dots and with series sub-networks A, B, \dots corresponds to a red rooted sub-trees (of size ≥ 2) $\phi(A), \phi(B), \dots$, and leaves labeled by a, b, \dots

This bijection clearly commutes with the action of the symmetric groups by relabeling, showing that red and white trees and series-parallel network are isomorphic as species. One can then check that the morphism is actually a morphism of operads.

Finally, one can remark that, as in the non-symmetric case, the leading coefficient corresponds to the operad RW_D^Σ .

REFERENCES

- [1] F. BERGERON, G. LABELLE and P. LEROUX, *Combinatorial species and tree-like structures*, Cambridge University Press, 1998.

- [2] F. CHAPOTON. *The anticyclic operad of moulds*, *Internat. Math. Res. Notices*, 2007, no. 20, Art. ID rnm078.
- [3] F. CHAPOTON. *Une opérade anticyclique sur les arbustes*, *Ann. Math. Blaise Pascal* 17 (2010), no. 1, 17–45.
- [4] F. CHAPOTON. *A bijection between shrubs and series-parallel posets*, *20th Annual International Conference on Formal Power Series and Algebraic Combinatorics (FPSAC 2008)*, 227–234, *Discrete Math. Theor. Comput. Sci. Proc. Nancy*, 2008.
- [5] F. CHAPOTON, F. HIVERT, J.-C. NOVELLI and J.-Y. THIBON, *An operational calculus for the mould operad*, *Int. Math. Res. Not. IMRN* 2008, no. 9, Art. ID rnm018, 22 pp.
- [6] G. DUCHAMP, F. HIVERT, and J.-Y. THIBON, *Noncommutative symmetric functions VI: free quasi-symmetric functions and related algebras*, *Internat. J. Alg. Comput.* **12** (2002), 671–717.
- [7] V. DOTSENKO, A. KHOROSHKIN, *Gröbner bases for operads.*, *Duke Math. J.* 153 (2010), no. 2, 363–396.
- [8] J. ECALLE. *A tale of three structures: the arithmetics of multizetas, the analysis of singularities, the Lie algebra ARI, Differential equations and the Stokes phenomenon*, 89–146, *World Sci. Publishing*, River Edge, NJ, 2002.
- [9] J. ECALLE. *ARI/GARI, la dimorphie et l'arithmétique des multizêtas: un premier bilan*, *J. Théor. Nombres Bordeaux*, 15(2):411–478, 2003.
- [10] J. ECALLE. *Multizetas, perinomial numbers, arithmetical dimorphy, and ARI/GARI*, *Ann. Fac. Sci. Toulouse Math. (6)*, 13(4):683–708, 2004.
- [11] P. FLAJOLET and R. SEDGEWICK. *Analytic Combinatorics*, Cambridge University Press, 2009
- [12] F. HIVERT, J.-C. NOVELLI and J.-Y. THIBON. *The algebra of binary search trees*, *Theoret. Comput. Sci.* **339** (2005), 129–165.
- [13] F. HIVERT, J.-C. NOVELLI and J.-Y. THIBON, *Trees, functional equations, and combinatorial Hopf algebras*, *European J. Combin.* 29 (2008), no. 7, 1682–1695.
- [14] E. HOFFBECK, *A Poincaré-Birkhoff-Witt criterion for Koszul operads.*, *Manuscripta Math.* 131 (2010), no. 1-2, 87–110.
- [15] D.E. KNUTH, *The art of computer programming*, vol.3: Sorting and searching, Addison-Wesley, 1973.
- [16] D. KROB, B. LECLERC and J.-Y. THIBON, *Noncommutative symmetric functions II: Transformations of alphabets*, *Internat. J. Alg. Comput.* **7** (1997), 181–264.
- [17] P. LEROUX, *An algebraic framework of weighted directed graphs*, *Int. J. Math. Math. Sci.* **58** (2003), 3657–3678.
- [18] M. LIVERNET, *A rigidity theorem for pre-Lie algebras*, *J. Pure Appl. Algebra* 207 (2006), no. 1, 1–18.
- [19] J.-L. LODAY AND M.O. RONCO, *Hopf algebra of the planar binary trees*, *Adv. Math.* **139** (1998) n. 2, 293–309.
- [20] J.-L. LODAY and M. O. RONCO, *Triangular algebras and families of polytopes*, *Contemporary Mathematics* **346** (2004).
- [21] J.-L. LODAY, *On the operad of associative algebras with derivation*, *Georgian Math. J.* **17** (2010), 347–372.
- [22] J.-L. LODAY, *On the algebra of quasi-shuffles*, *Manuscripta Math.* **123** (2007), no. 1, 79–93.
- [23] J.-L. LODAY, *Inversion of integral series enumerating planar trees*, *Sém. Lothar. Combin.* **53**, Art. B53d, 16 pp.
- [24] I.G. MACDONALD, *Symmetric functions and Hall polynomials*, Oxford University Press, 1979.
- [25] F. MENOUS, J.-C. NOVELLI, and J.-Y. THIBON. *Mould calculus, polyhedral cones and characters of combinatorial Hopf algebras*, arXiv:1109.1634, 2011.
- [26] C. REUTENAUER, *Free Lie algebras*, Oxford, 1993
- [27] W. A. Stein et al. *Sage Mathematics Software (Version 3.3)*. The Sage Development Team, 2009. <http://www.sagemath.org>.
- [28] The Sage-Combinat community. *Sage-Combinat: enhancing Sage as a toolbox for computer exploration in algebraic combinatorics*, 2008. <http://combinat.sagemath.org>.

[29] N. J. A. SLOANE, *The On-Line Encyclopedia of Integer Sequences*,
<http://www.research.att.com/~njas/sequences/>

(Chapoton) INSTITUT CAMILLE JORDAN, UNIVERSITÉ CLAUDE BERNARD LYON 1, 69622
VILLEURBANNE CEDEX, FRANCE

(Hivert) LABORATOIRE DE RECHERCHE EN INFORMATIQUE, UNIVERSITÉ PARIS-SUD, 91405
ORSAY CEDEX, FRANCE

(Novelli) INSTITUT GASPARD MONGE, UNIVERSITÉ DE MARNE-LA-VALLÉE, 5 BOULEVARD
DESCARTES, CHAMPS-SUR-MARNE, 77454 MARNE-LA-VALLÉE CEDEX 2, FRANCE

E-mail address, Frédéric Chapoton: chapoton@math.univ-lyon1.fr

E-mail address, Florent Hivert: hivert@lri.fr

E-mail address, Jean-Christophe Novelli: novelli@univ-mlv.fr