

Details of an Automotive Sub-System: Saab Instrument Cluster Module

Ramin Etemaadi^a, Kenneth Lind^b, Rogardt Heldal^c, Michel R. V. Chaudron^{c, a}

^a Leiden Institute of Advanced Computer Science (LIACS),
Leiden University, Netherlands

^b Viktoria Institute, Gothenburg, Sweden

^c Joint Department of Computer Science and
Engineering of Chalmers and Gothenborg University,
Gothenburg, Sweden

* Emails:

etemaadi@liacs.nl

kenneth.lind@viktoria.se

heldal@chalmers.se

chaudron@chalmers.se / chaudron@liacs.nl

Abstract

The goal of this technical report is to give the details of a real world existing sub-system in the automotive industry. It is produced to be used for reproduction of the same experiment if other researchers are interested in. Hence, it would be possible to compare the results of our published studies with the results of similar tools. The data is collected for the purpose of applying metaheuristic optimization approaches. The case study based on these data shows that metaheuristic optimization approaches can find efficient solutions for multiple quality attributes while fulfilling given constraints.

The case study was conducted at Saab Automobile AB in order to evaluate the AQOSA framework in an industrial context. AQOSA (Automated Quality-driven Optimization of Software Architecture) is our architecture optimization framework that supports multiple quality attributes including response time, processor utilization, bus utilization, safety and cost.

To enable validation of the results we selected an existing realization for the Saab 9-5 Instrument Cluster Module ECU (Electronic Control Unit) and the surrounding sub-systems. The goal of the case study is to find a better solution than the current realization while fulfilling the requirements and constraints. The results of the case study and the details of AQOSA framework is reported in a paper from the authors in *Journal of Systems and Software, Special Issue on Quality Optimization of Software Architecture and Design Specifications*.

1 Overview

This report describes the details of Saab 9-5 Instrument Cluster Module ECU and the surrounding sub-systems. The purpose of the Instrument Cluster sub-system is to provide the driver with information that is required when driving the car. The information is processed by user functions based on sensor values, and presented on gauges or displays located in front of the driver. The user functions (and i/o devices) included in the study are shown in Table 1.

A user function like the ones in Table 1 can be complex due to regulations, safety properties, variation between different car models, or other quality constraints. In general, a user function consists of several requirements and quality constraints. A user function is specified and implemented using one or several software components. Figure 1 shows the component diagram of the Instrument Cluster sub-system. The diagram shows how the software components are connected to satisfy the user functions in Table 1. The purpose of Figure 1 is to illustrate the complexity of the case.

The user functions in Table 1 are typically triggered by two types of tasks:

- by events captured by their input devices (sporadic tasks),
- by an invocation from a scheduler within the sub-system (periodic tasks). These tasks were defined by describing changes in switch/sensor values.

The sporadic tasks are defined in Table 2 and the periodic tasks are defined in Table 3.

<i>User function</i>	<i>Description</i>
Vehicle Speed Indication	Shows the speed of the car on the speedometer gauge. The vehicle speed information is based on the wheel speed sensors, filtered and converted into the chosen metric (either km/h or miles/h).
Coolant Temperature Indication	Shows the temperature of the engine coolant on the coolant temperature gauge. The coolant temperature information is based on a temperature sensor, filtered and compensated to show the correct temperature.
Selected Gear Indication	Displays the current automatic gear position of the vehicle. (Possible gear positions are P, R, N, D, and L.) The information is based on position sensors in the Automatic Gearbox.
Engine Speed Indication	Shows the engine revolutions per minute information on the tachometer gauge. The engine speed information is based on the crankshaft sensor, and filtered before it is shown.
Odometer Indication	Shows the distance travelled by the car. The odometer is based on the wheel speed sensors, filtered and converted into distance in the chosen metric (either km or miles).
Ignition Switch Power Moding	The global system power mode in the car. The system power mode information is based on the ignition key switch, with the possible positions OFF, ACCESSORY, RUN, and CRANK. This information is transmitted to all parts of the system.
Outside Air Temperature Indication	Shows the outside temperature on the display. The outside temperature information is based on a temperature sensor, filtered and compensated to show the correct temperature.
Low Washer Indication	Notifies the driver when the windshield wiper fluid level is low. The notification is based on a fluid level switch.

Table 1: Description of user functions included in the case study.

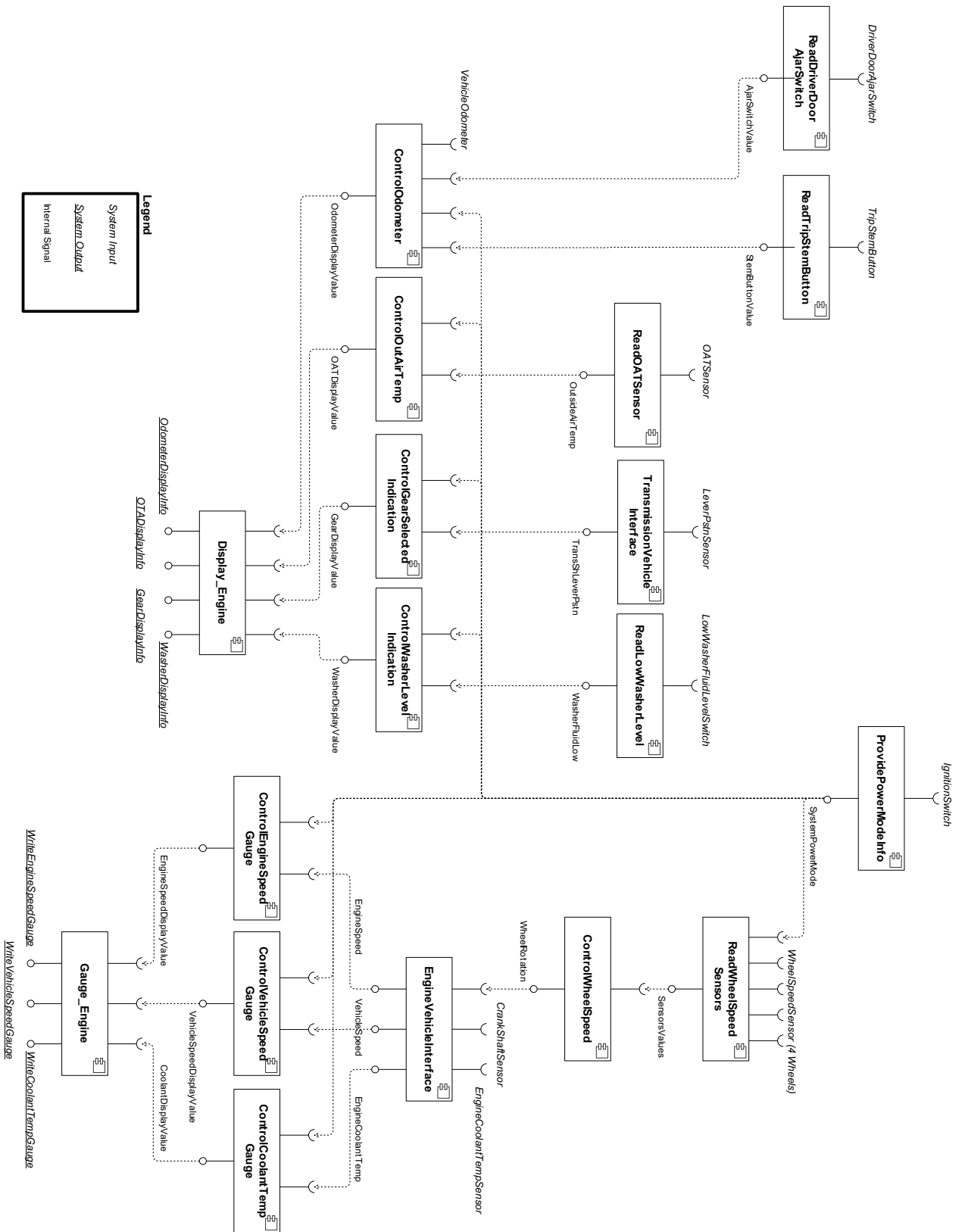

Figure 1: Component diagram of Instrument Cluster sub-system.

<i>Stimulus</i>	<i>System response</i>
<i>IgnitionSwitch</i> = 0 (OFF) \wedge <i>DoorAjarSwitch</i> : <i>False</i> \rightarrow <i>True</i>	Odometer shall be displayed within 500 ms
<i>IgnitionSwitch</i> = 0 (OFF) \wedge <i>TripStemButton</i> : <i>False</i> \rightarrow <i>True</i> <i>IgnitionSwitch</i> : 0 (OFF) \rightarrow 2 (RUN)	Odometer shall be displayed within 500 ms The Engine Speed pointer shall begin to move to the correct position within 150 ms
<i>IgnitionSwitch</i> : 0 (OFF) \rightarrow 2 (RUN)	The Vehicle Speed pointer shall begin to move to the correct position within 150 ms
<i>IgnitionSwitch</i> = 2 (RUN) \wedge <i>WasherFluidSensor</i> : <i>False</i> \rightarrow <i>True</i>	Low Washer Fluid Indicator shall be illuminated within 250 ms
<i>IgnitionSwitch</i> = 2 (RUN) \wedge <i>GearLeverPositionSwitch</i> : 1 (P) \rightarrow 4 (D)	Drive position shall be displayed within 100 ms

Table 2: Sporadic tasks included in the case study.

As an example of a stimulus and system response for a sporadic task we will look at the first task in Table 2. The Driver Door Ajar Switch detects that the Driver Door is opened while the vehicle is parked and the engine is OFF. Then the Odometer value shall be displayed within 500 ms. The other tasks in Table 2 are of similar kind.

A user function like the ones in Table 1 is typically implemented using one or several software components. We modeled the collaboration among these components using sequence diagrams as shown in Figure 2. The reason is that AQOSA needs scenarios for creating architecture solutions, and sequence diagrams are a good way of modeling scenarios.

The sequence diagrams needed to be enhanced with information required for AQOSA quality attributes evaluation process. The number of cycles for executing each operation is needed. This information is added next to the activation on the sequence diagram. For example, we can see in Figure 2 that the operation `CalculateOAT()` takes 2744 cycles to execute. The number of execution cycles for the `CalculateOAT()` operation was obtained by analyzing the source code

<i>Stimulus</i>	<i>System response</i>
<i>IgnitionSwitch</i> = 2 (RUN) \wedge <i>VehicleSpeedSensor</i> : 0 \rightarrow 100km/h	VehicleSpeed signal shall be transmitted periodically each 100 ms. VehicleSpeedDisplayValue shall be calculated periodically each 100 ms. The Vehicle Speed pointer shall begin to move to the correct position within 150 ms.
<i>IgnitionSwitch</i> = 2 (RUN) \wedge <i>CrankshaftSensor</i> : 0 \rightarrow 5000rpm	EngineSpeed signal shall be transmitted periodically each 100 ms. EngineSpeedDisplayValue shall be calculated periodically each 100 ms. The Engine Speed pointer shall begin to move to the correct position within 150 ms.
<i>IgnitionSwitch</i> = 2 (RUN) \wedge <i>OutsideTempSensor</i> : 0 \rightarrow 100%	The outside air temperature shall be calculated once every second. The outside air temperature shall be displayed within 100 ms.
<i>IgnitionSwitch</i> = 2 (RUN) \wedge <i>CoolantTempSensor</i> : 0 \rightarrow 100%	EngineCoolantTemp signal shall be transmitted periodically each 100 ms. CoolantDisplayValue shall be calculated periodically each 100 ms. The Coolant Temp pointer shall begin to move to the correct position within 150 ms.

Table 3: Periodic tasks included in the case study.

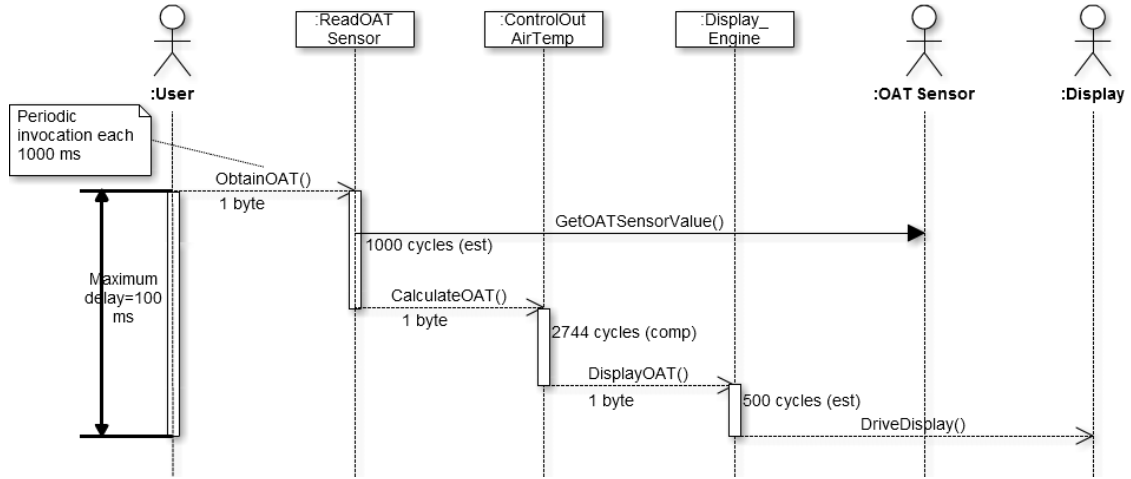

Figure 2: Sequence diagram of Outside Air Temperature calculation.

of the `ControlOutAirTemp` component with the SCoPE simulation framework [1]. Components for which we did not have access to the source code were analyzed manually by reading the requirement specification and comparing to similar components, to estimate the number of execution cycles.

AQOSA also require the number of bytes being sent. This information is added below the messages. We can see in Figure 2 that the message `CalculateOAT()` carry 1 byte. The number of bytes sent in a message was obtained by calculating the size of the data that is sent.

In addition to the information above, AQOSA also needed the timing constraints described in Table 2 and Table 3. This information was added to the sequence diagram in a standard way to the left of the sequence diagram and with the help of notes. On the left side in Figure 2, we can see that the maximum delay for the whole scenario should be less than 100 ms. The note added to the message `ObtainOAT()` constrains it to be invoked each 1000 ms.

2 Constraints

The user functions (see Table 1) and the timing constraints (see Table 2 and Table 3) are needed to obtain the required input to AQOSA, but there is one more important type of constraints for this domain. Deployment constraints state which hardware realizations are feasible from a domain perspective. The deployment constraints are stated in Table 4.

<i>Constraint</i>	<i>Description</i>
1	Wheel Speed Sensor shall always be connected to the Brake Module
2	Crankshaft Sensor and Engine Coolant Temp Sensor shall always be connected to the Engine Module
3	The Brake Module and the Engine Module shall always be connected to a HS CAN bus

Table 4: Deployment constraints included in the case study.

3 Sequence Diagrams

In the following, the sequence diagram for each user function of the system is depicted. It contains the deadline and the required number of cycles for each procedure.

3.1 Vehicle Speed Indication

Figure 3 shows the sequence diagram of Vehicle Speed Indication.

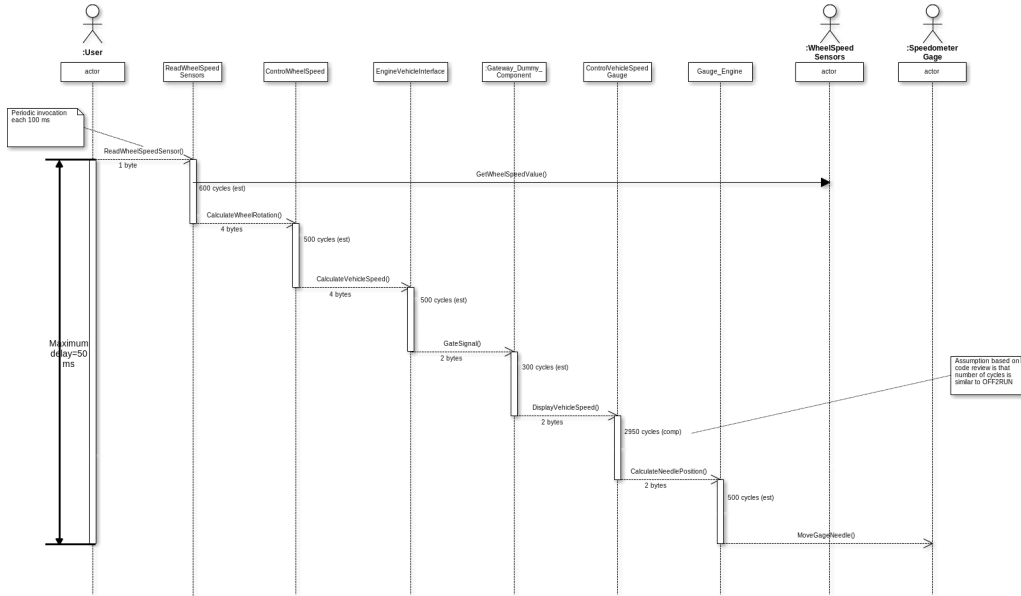

Figure 3: Vehicle Speed Indication.

3.2 Vehicle Speed On Start

Figure 4 shows the sequence diagram of Vehicle Speed On Start.

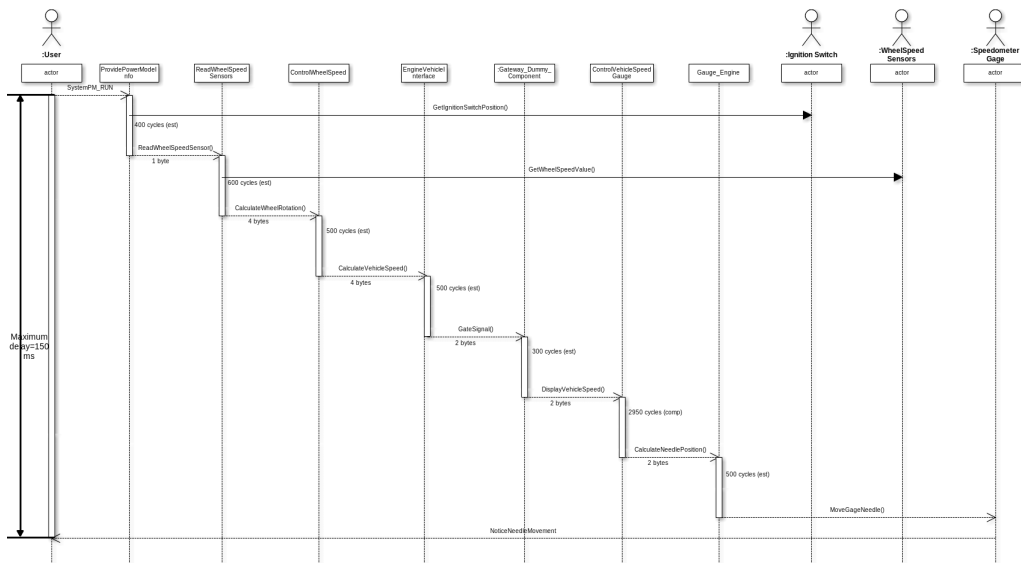

Figure 4: Vehicle Speed On Start.

3.3 Engine Speed Indication

Figure 5 shows the sequence diagram of Engine Speed Indication.

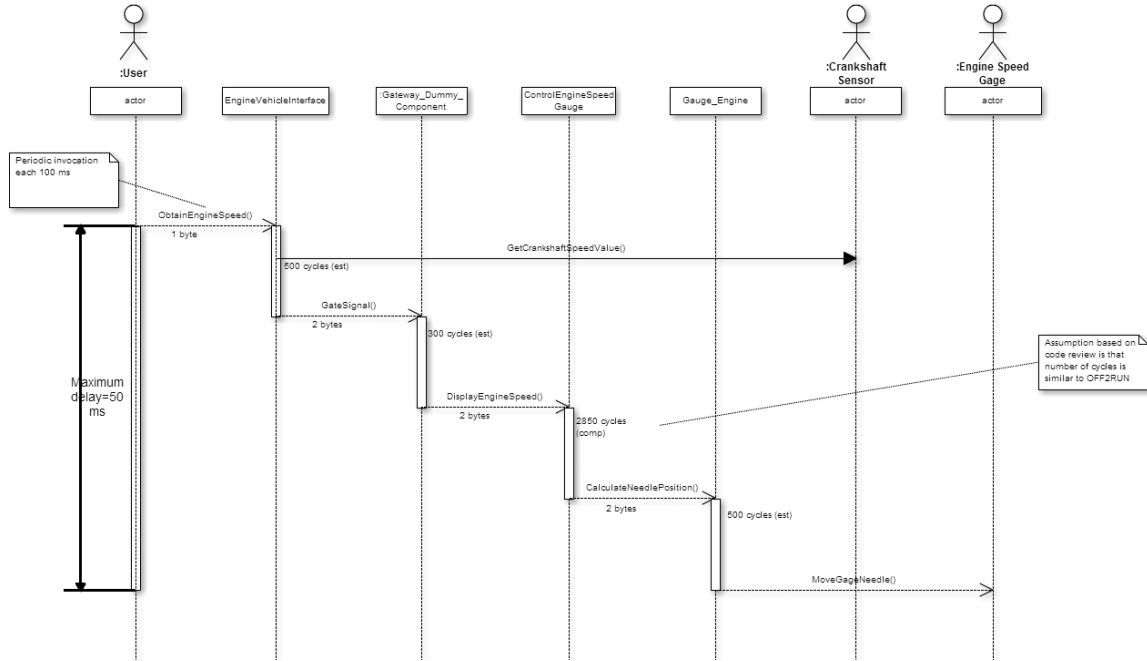

Figure 5: Engine Speed Indication.

3.4 Engine Speed On Start

Figure 6 shows the sequence diagram of Engine Speed On Start.

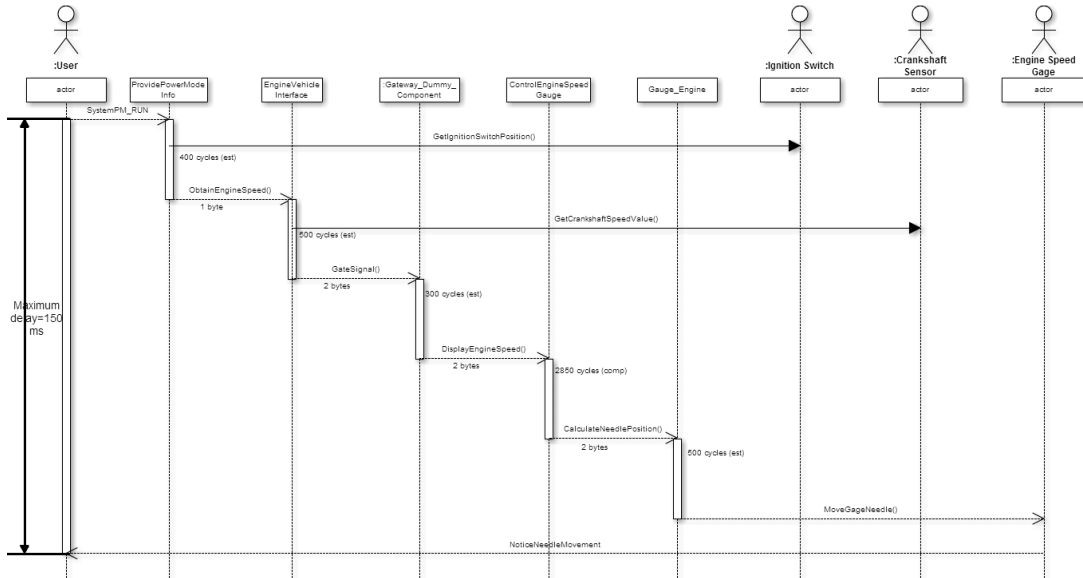

Figure 6: Engine Speed On Start.

3.5 Coolant Temperature Indication

Figure 7 shows the sequence diagram of Coolant Temperature Ind.

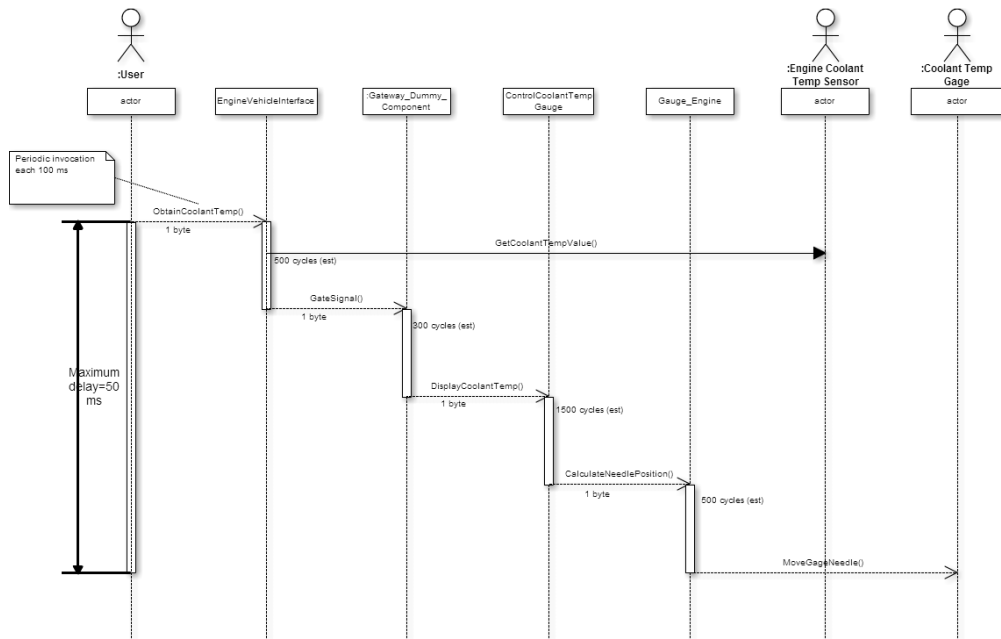

Figure 7: Coolant Temperature Indication.

3.6 Selected Gear Indication

Figure 8 shows the sequence diagram of Selected Gear Indication.

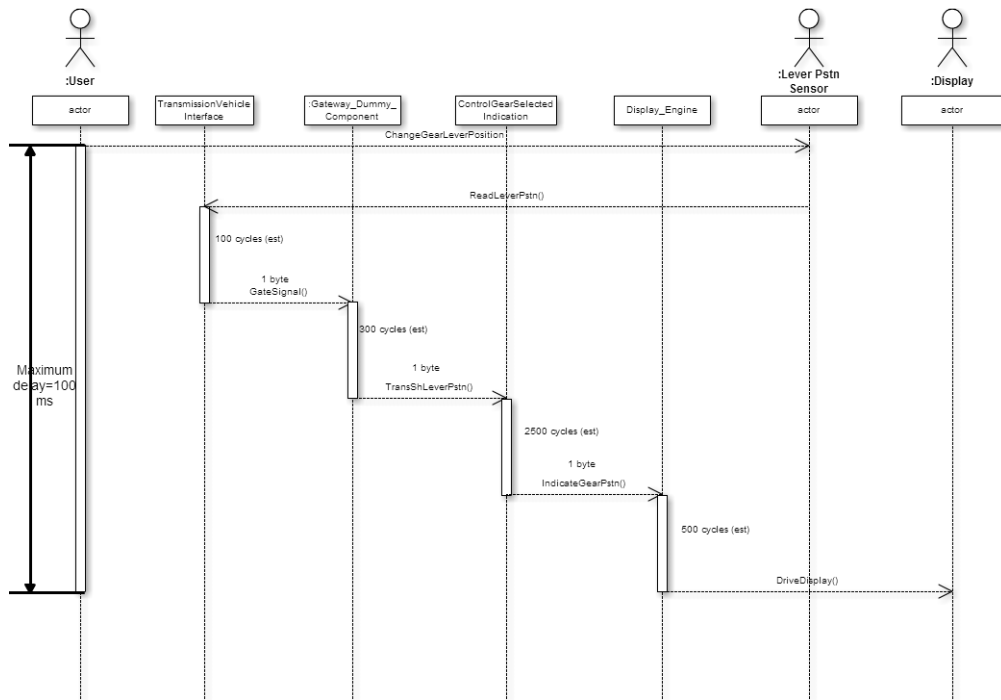

Figure 8: Selected Gear Indication.

3.7 Odometer Indication On Trip Stem Button Activation

Figure 9 shows the sequence diagram of Odometer Indication On Trip Stem Button Activation.

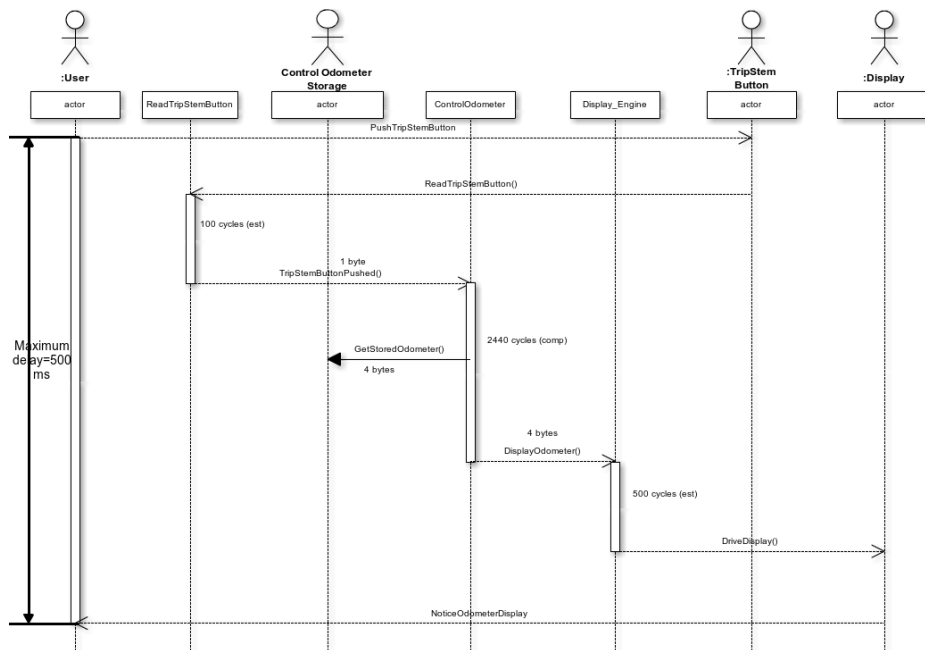

Figure 9: Odometer Indication On Trip Stem Button Activation.

3.8 Odometer Indication on Door Ajar Activation

Figure 10 shows the sequence diagram of Odometer Indication on Door Ajar Activation.

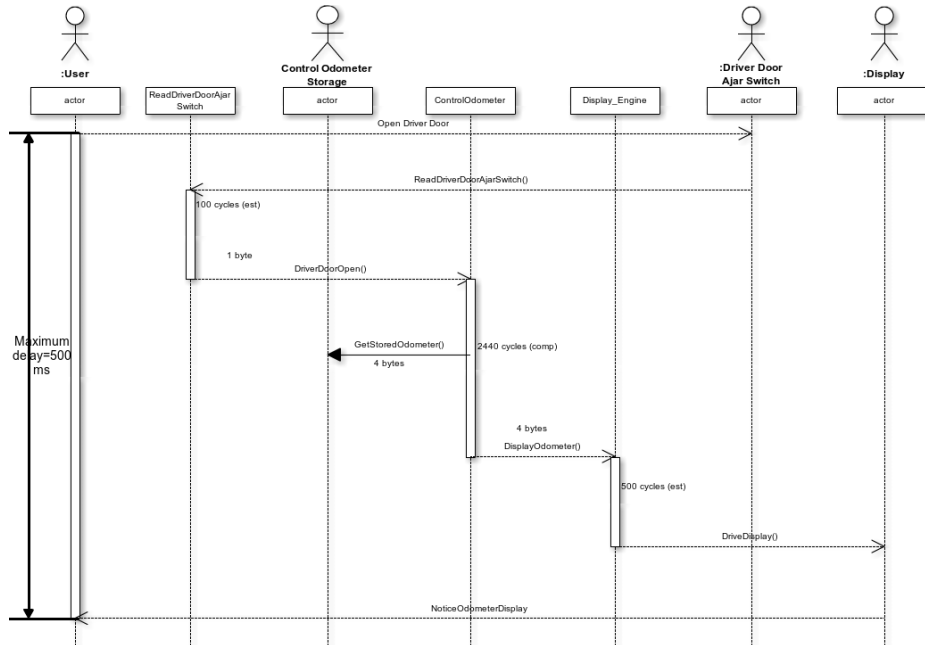

Figure 10: Odometer Indication on Door Ajar Activation.

3.9 Outside Air Temperature Indication

Figure 11 shows the sequence diagram of Outside Air Temperature Indication.

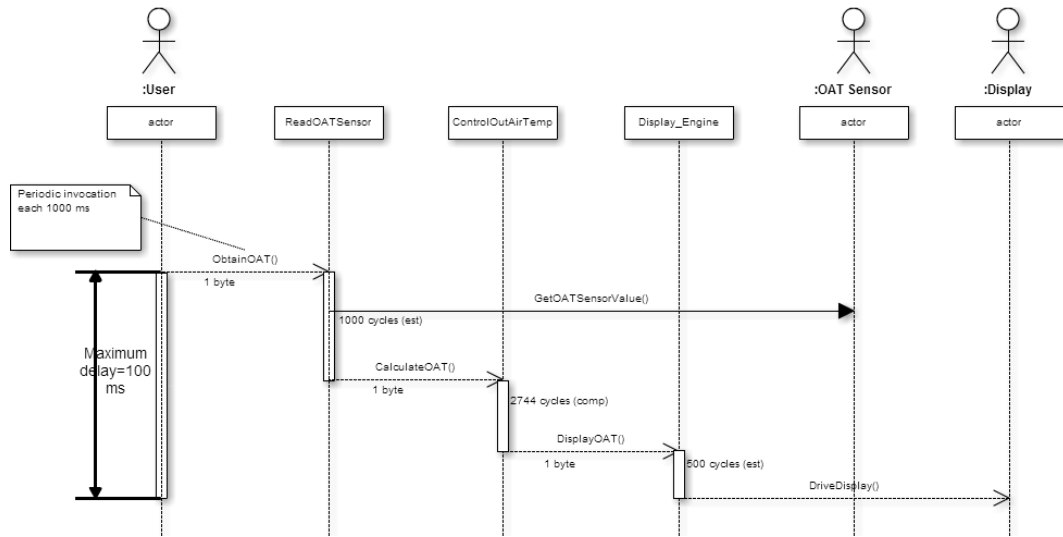

Figure 11: Outside Air Temperature Indication.

3.10 Low Washer Indication

Figure 12 shows the sequence diagram of Low Washer Indication.

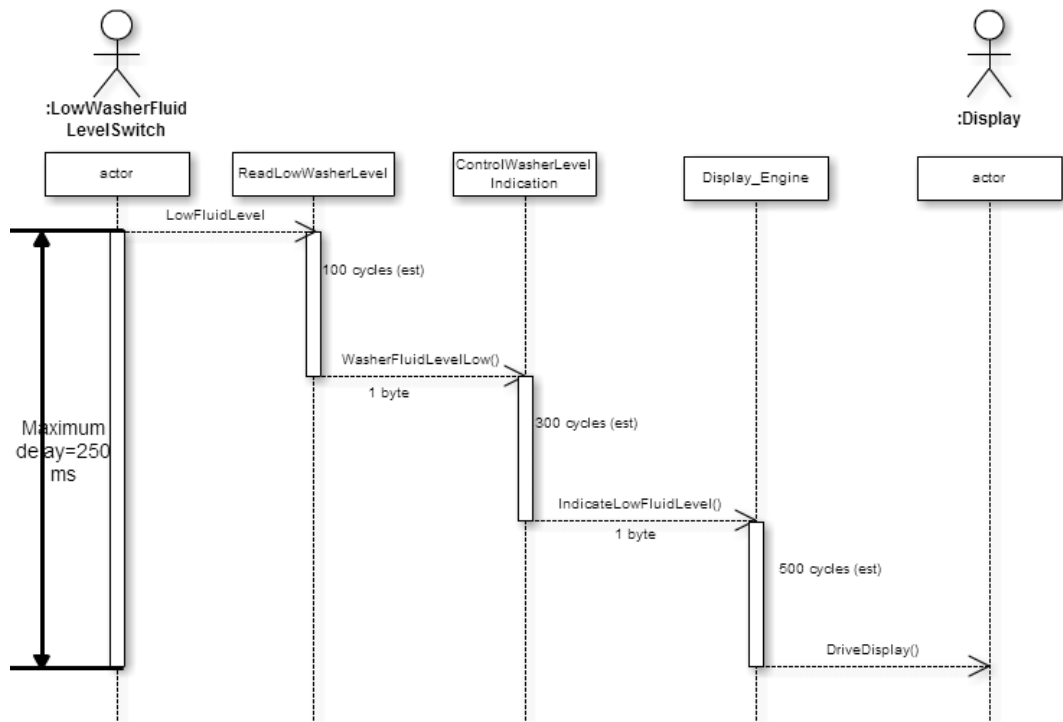

Figure 12: Low Washer Indication.

4 AQOSA IR Model

Listing 1 shows the source of AQOSA IR model for this case study which is encoded in Eclipse EMF model.

Listing 1: AQOSA EMF source code for Saab case study

```
1 <?xml version="1.0" encoding="UTF-8"?>
2 <aqosa.ir:AQOSAModel xmi:version="2.0" xmlns:xmi="http://www.omg.org/XMI" xmlns:xsi="
  http://www.w3.org/2001/XMLSchema-instance" xmlns:aqosa.ir="http://se.liacs.
  nl/aqosa/ir">
3 <assembly>
4 <component name="ReadWheelSpeedSensors">
5 <service name="ReadWheelSpeedSensors"/>
6 <inport name="ReadWheelSpeedSensors-in"/>
7 <outport name="ReadWheelSpeedSensors-out"/>
8 </component>
9 <component name="ControlWheelSpeed">
10 <service name="CalculateWheelRotation"/>
11 <inport name="ControlWheelSpeed-in"/>
12 <outport name="ControlWheelSpeed-out"/>
13 </component>
14 <component name="EngineVehicleInterface">
15 <service name="ObtainEngineSpeed"/>
16 <service name="ObtainVehicleSpeed"/>
17 <service name="ObtainCoolantTemp"/>
18 <inport name="EngineVehicleInterface-in_Engine"/>
19 <inport name="EngineVehicleInterface-in_Vehicle"/>
20 <inport name="EngineVehicleInterface-in_Coolant"/>
21 <outport name="EngineVehicleInterface-out_Engine"/>
22 <outport name="EngineVehicleInterface-out_Vehicle"/>
23 <outport name="EngineVehicleInterface-out_Coolant"/>
24 </component>
25 <component name="ProvidePowerModeInfo">
26 <service name="PowerModeInfo"/>
27 <outport name="PowerModeInfo-out"/>
28 </component>
29 <component name="ControlEngineSpeedGauge">
30 <service name="DisplayEngineSpeed"/>
31 <inport name="ControlEngineSpeedGauge-in"/>
32 <outport name="ControlEngineSpeedGauge-out"/>
33 </component>
34 <component name="ControlVehicleSpeedGauge">
35 <service name="DisplayVehicleSpeed"/>
36 <inport name="ControlVehicleSpeedGauge-in"/>
37 <outport name="ControlVehicleSpeedGauge-out"/>
38 </component>
39 <component name="Gauge_Engine">
40 <service name="CalculateNeedlePosition"/>
41 <inport name="Gauge_Engine-in"/>
42 </component>
43 <component name="TransmissionVehicleInterface">
44 <service name="ReadLeverPstn"/>
45 <outport name="TransmissionVehicleInterface-out"/>
46 </component>
47 <component name="ControlGearSelectedIndication">
48 <service name="GearDisplayValue"/>
49 <inport name="ControlGearSelectedIndication-in"/>
50 <outport name="ControlGearSelectedIndication-out"/>
51 </component>
52 <component name="Display_Engine">
53 <service name="IndicateGearPstn"/>
54 <service name="DisplayOAT"/>
55 <service name="DisplayOdometer"/>
```

```

56 <service name="IndicateLowWasher" />
57 <inport name="Display_Engine-in_Gear" />
58 <inport name="Display_Engine-in_OAT" />
59 <inport name="Display_Engine-in_Odometer" />
60 <inport name="Display_Engine-in_Washer" />
61 </component>
62 <component name="ReadOATSensor">
63 <service name="ObtaionOAT" />
64 <outport name="ReadOATSensor-out" />
65 </component>
66 <component name="ControlOutsideAirTemp">
67 <service name="CalculateOAT" />
68 <inport name="ControlOutsideAirTemp-in" />
69 <outport name="ControlOutsideAirTemp-out" />
70 </component>
71 <component name="ControlCoolantTempGauge">
72 <service name="DisplayCoolantTemp" />
73 <inport name="ControlCoolantTempGauge-in" />
74 <outport name="ControlCoolantTempGauge-out" />
75 </component>
76 <component name="ReadDriverDoorAjarSwitch">
77 <service name="ReadDriverDoorAjarSwitch" />
78 <outport name="ReadDriverDoorAjarSwitch-out" />
79 </component>
80 <component name="ControlOdometer">
81 <service name="OdometerValue" />
82 <inport name="ControlOdometer-in" />
83 <outport name="ControlOdometer-out" />
84 </component>
85 <component name="ReadTripStemButton">
86 <service name="ReadTripStemButton" />
87 <outport name="ReadTripStemButton-out" />
88 </component>
89 <component name="ReadLowWasherLevel">
90 <service name="ReadLowWasherLevel" />
91 <outport name="ReadLowWasherLevel-out" />
92 </component>
93 <component name="ControlWasherLevelIndication">
94 <service name="ControlWasherLevelIndication" />
95 <inport name="ControlWasherLevelIndication-in" />
96 <outport name="ControlWasherLevelIndication-out" />
97 </component>
98 <flow name="Ignition_to_EngineSpeed">
99 <action xsi:type="aqosa.ir:ComputeAction" service="//@assembly/@component.3
/ @service.0" />
100 <action xsi:type="aqosa.ir:CommunicateAction" source="//@assembly/@component.3
/ @outport.0" destination="//@assembly/@component.2/ @inport.0" />
101 <action xsi:type="aqosa.ir:ComputeAction" service="//@assembly/@component.2
/ @service.0" />
102 <action xsi:type="aqosa.ir:CommunicateAction" source="//@assembly/@component.2
/ @outport.0" destination="//@assembly/@component.4/ @inport.0" />
103 <action xsi:type="aqosa.ir:ComputeAction" service="//@assembly/@component.4
/ @service.0" />
104 <action xsi:type="aqosa.ir:CommunicateAction" source="//@assembly/@component.4
/ @outport.0" destination="//@assembly/@component.6/ @inport.0" />
105 <action xsi:type="aqosa.ir:ComputeAction" service="//@assembly/@component.6
/ @service.0" />
106 </flow>
107 <flow name="Ignition_to_VehicleSpeed">
108 <action xsi:type="aqosa.ir:ComputeAction" service="//@assembly/@component.3
/ @service.0" />
109 <action xsi:type="aqosa.ir:CommunicateAction" source="//@assembly/@component.3
/ @outport.0" destination="//@assembly/@component.0/ @inport.0" />
110 <action xsi:type="aqosa.ir:ComputeAction" service="//@assembly/@component.0

```

```

    /@service.0"/>
111 <action xsi:type="aqosa.ir:CommunicateAction" source="//@assembly/@component.0
    /@output.0" destination="//@assembly/@component.1/@inport.0"/>
112 <action xsi:type="aqosa.ir:ComputeAction" service="//@assembly/@component.1
    /@service.0"/>
113 <action xsi:type="aqosa.ir:CommunicateAction" source="//@assembly/@component.1
    /@output.0" destination="//@assembly/@component.2/@inport.1"/>
114 <action xsi:type="aqosa.ir:ComputeAction" service="//@assembly/@component.2
    /@service.1"/>
115 <action xsi:type="aqosa.ir:CommunicateAction" source="//@assembly/@component.2
    /@output.1" destination="//@assembly/@component.5/@inport.0"/>
116 <action xsi:type="aqosa.ir:ComputeAction" service="//@assembly/@component.5
    /@service.0"/>
117 <action xsi:type="aqosa.ir:CommunicateAction" source="//@assembly/@component.5
    /@output.0" destination="//@assembly/@component.6/@inport.0"/>
118 <action xsi:type="aqosa.ir:ComputeAction" service="//@assembly/@component.6
    /@service.0"/>
119 </flow>
120 <flow name="GearIndication">
121 <action xsi:type="aqosa.ir:ComputeAction" service="//@assembly/@component.7
    /@service.0"/>
122 <action xsi:type="aqosa.ir:CommunicateAction" source="//@assembly/@component.7
    /@output.0" destination="//@assembly/@component.8/@inport.0"/>
123 <action xsi:type="aqosa.ir:ComputeAction" service="//@assembly/@component.8
    /@service.0"/>
124 <action xsi:type="aqosa.ir:CommunicateAction" source="//@assembly/@component.8
    /@output.0" destination="//@assembly/@component.9/@inport.0"/>
125 <action xsi:type="aqosa.ir:ComputeAction" service="//@assembly/@component.9
    /@service.0"/>
126 </flow>
127 <flow name="VehicleSpeedIndication">
128 <action xsi:type="aqosa.ir:ComputeAction" service="//@assembly/@component.0
    /@service.0"/>
129 <action xsi:type="aqosa.ir:CommunicateAction" source="//@assembly/@component.0
    /@output.0" destination="//@assembly/@component.1/@inport.0"/>
130 <action xsi:type="aqosa.ir:ComputeAction" service="//@assembly/@component.1
    /@service.0"/>
131 <action xsi:type="aqosa.ir:CommunicateAction" source="//@assembly/@component.1
    /@output.0" destination="//@assembly/@component.2/@inport.1"/>
132 <action xsi:type="aqosa.ir:ComputeAction" service="//@assembly/@component.2
    /@service.1"/>
133 <action xsi:type="aqosa.ir:CommunicateAction" source="//@assembly/@component.2
    /@output.1" destination="//@assembly/@component.5/@inport.0"/>
134 <action xsi:type="aqosa.ir:ComputeAction" service="//@assembly/@component.5
    /@service.0"/>
135 <action xsi:type="aqosa.ir:CommunicateAction" source="//@assembly/@component.5
    /@output.0" destination="//@assembly/@component.6/@inport.0"/>
136 <action xsi:type="aqosa.ir:ComputeAction" service="//@assembly/@component.6
    /@service.0"/>
137 </flow>
138 <flow name="EngineSpeedIndication">
139 <action xsi:type="aqosa.ir:ComputeAction" service="//@assembly/@component.2
    /@service.0"/>
140 <action xsi:type="aqosa.ir:CommunicateAction" source="//@assembly/@component.2
    /@output.0" destination="//@assembly/@component.4/@inport.0"/>
141 <action xsi:type="aqosa.ir:ComputeAction" service="//@assembly/@component.4
    /@service.0"/>
142 <action xsi:type="aqosa.ir:CommunicateAction" source="//@assembly/@component.4
    /@output.0" destination="//@assembly/@component.6/@inport.0"/>
143 <action xsi:type="aqosa.ir:ComputeAction" service="//@assembly/@component.6
    /@service.0"/>
144 </flow>
145 <flow name="OATCalculation">
146 <action xsi:type="aqosa.ir:ComputeAction" service="//@assembly/@component.10

```

```

    /@service.0"/>
147 <action xsi:type="aqosa.ir:CommunicateAction" source="//@assembly/@component.10
    /@output.0" destination="//@assembly/@component.11/@inport.0"/>
148 <action xsi:type="aqosa.ir:ComputeAction" service="//@assembly/@component.11
    /@service.0"/>
149 <action xsi:type="aqosa.ir:CommunicateAction" source="//@assembly/@component.11
    /@output.0" destination="//@assembly/@component.9/@inport.1"/>
150 <action xsi:type="aqosa.ir:ComputeAction" service="//@assembly/@component.9
    /@service.1"/>
151 </flow>
152 <flow name="EngineCoolantTemp">
153 <action xsi:type="aqosa.ir:ComputeAction" service="//@assembly/@component.2
    /@service.2"/>
154 <action xsi:type="aqosa.ir:CommunicateAction" source="//@assembly/@component.2
    /@output.2" destination="//@assembly/@component.12/@inport.0"/>
155 <action xsi:type="aqosa.ir:ComputeAction" service="//@assembly/@component.12
    /@service.0"/>
156 <action xsi:type="aqosa.ir:CommunicateAction" source="//@assembly/@component.12
    /@output.0" destination="//@assembly/@component.6/@inport.0"/>
157 <action xsi:type="aqosa.ir:ComputeAction" service="//@assembly/@component.6
    /@service.0"/>
158 </flow>
159 <flow name="DriverDoor_to_Odometer">
160 <action xsi:type="aqosa.ir:ComputeAction" service="//@assembly/@component.13
    /@service.0"/>
161 <action xsi:type="aqosa.ir:CommunicateAction" source="//@assembly/@component.13
    /@output.0" destination="//@assembly/@component.14/@inport.0"/>
162 <action xsi:type="aqosa.ir:ComputeAction" service="//@assembly/@component.14
    /@service.0"/>
163 <action xsi:type="aqosa.ir:CommunicateAction" source="//@assembly/@component.14
    /@output.0" destination="//@assembly/@component.9/@inport.2"/>
164 <action xsi:type="aqosa.ir:ComputeAction" service="//@assembly/@component.9
    /@service.2"/>
165 </flow>
166 <flow name="StemButton_to_Odometer">
167 <action xsi:type="aqosa.ir:ComputeAction" service="//@assembly/@component.15
    /@service.0"/>
168 <action xsi:type="aqosa.ir:CommunicateAction" source="//@assembly/@component.15
    /@output.0" destination="//@assembly/@component.14/@inport.0"/>
169 <action xsi:type="aqosa.ir:ComputeAction" service="//@assembly/@component.14
    /@service.0"/>
170 <action xsi:type="aqosa.ir:CommunicateAction" source="//@assembly/@component.14
    /@output.0" destination="//@assembly/@component.9/@inport.2"/>
171 <action xsi:type="aqosa.ir:ComputeAction" service="//@assembly/@component.9
    /@service.2"/>
172 </flow>
173 <flow name="LowWasherIndication">
174 <action xsi:type="aqosa.ir:ComputeAction" service="//@assembly/@component.16
    /@service.0"/>
175 <action xsi:type="aqosa.ir:CommunicateAction" source="//@assembly/@component.16
    /@output.0" destination="//@assembly/@component.17/@inport.0"/>
176 <action xsi:type="aqosa.ir:ComputeAction" service="//@assembly/@component.17
    /@service.0"/>
177 <action xsi:type="aqosa.ir:CommunicateAction" source="//@assembly/@component.17
    /@output.0" destination="//@assembly/@component.9/@inport.3"/>
178 <action xsi:type="aqosa.ir:ComputeAction" service="//@assembly/@component.9
    /@service.3"/>
179 </flow>
180 </assembly>
181 <scenarios>
182 <flowset name="Average" completionTime="5000.0" missedPercentage="0.02">
183 <flowinstance instance="//@assembly/@flow.0" start="500.0" trigger="5000.0"
    deadline="150.0"/>
184 <flowinstance instance="//@assembly/@flow.1" start="500.0" trigger="5000.0"

```

```

185     deadline="150.0"/>
186 <flowinstance instance="//@assembly/@flow.2" start="500.0" trigger="5000.0"
    deadline="100.0"/>
187 <flowinstance instance="//@assembly/@flow.3" start="1000.0" trigger="100.0"
    deadline="50.0"/>
188 <flowinstance instance="//@assembly/@flow.4" start="1000.0" trigger="100.0"
    deadline="50.0"/>
189 <flowinstance instance="//@assembly/@flow.5" start="1000.0" trigger="1000.0"
    deadline="100.0"/>
190 <flowinstance instance="//@assembly/@flow.6" start="1000.0" trigger="100.0"
    deadline="50.0"/>
191 <flowinstance instance="//@assembly/@flow.7" start="500.0" trigger="5000.0"
    deadline="500.0"/>
192 <flowinstance instance="//@assembly/@flow.8" start="500.0" trigger="5000.0"
    deadline="500.0"/>
193 <flowinstance instance="//@assembly/@flow.9" start="500.0" trigger="5000.0"
    deadline="250.0"/>
194 </flowset>
195 </scenarios>
196 <repository>
197 <componentinstance id="ReadWheelSpeedSensors_Instance" compatible="
    //@assembly/@component.0" variancePercentage="0.05">
198 <service instance="//@assembly/@component.0/@service.0" cycles="600" networkUsage=
    "4000.0">
199 <provide connects="//@assembly/@component.0/@outport.0"/>
200 <depend>
201 <require external="//@repository/@externalport.4"/>
202 <require internal="//@assembly/@component.0/@inport.0"/>
203 </depend>
204 </service>
205 </componentinstance>
206 <componentinstance id="ControlWheelSpeed_Instance" compatible="
    //@assembly/@component.1" variancePercentage="0.05">
207 <service instance="//@assembly/@component.1/@service.0" cycles="500" networkUsage=
    "4000.0">
208 <provide connects="//@assembly/@component.1/@outport.0"/>
209 <depend>
210 <require internal="//@assembly/@component.1/@inport.0"/>
211 </depend>
212 </service>
213 </componentinstance>
214 <componentinstance id="EngineVehicleInterface_Instance" compatible="
    //@assembly/@component.2" variancePercentage="0.05">
215 <service instance="//@assembly/@component.2/@service.0" cycles="500" networkUsage=
    "2000.0">
216 <provide connects="//@assembly/@component.2/@outport.0"/>
217 <depend>
218 <require external="//@repository/@externalport.3"/>
219 <require internal="//@assembly/@component.2/@inport.0"/>
220 </depend>
221 </service>
222 <service instance="//@assembly/@component.2/@service.1" cycles="500" networkUsage=
    "2000.0">
223 <provide connects="//@assembly/@component.2/@outport.1"/>
224 <depend>
225 <require internal="//@assembly/@component.2/@inport.1"/>
226 </depend>
227 </service>
228 <service instance="//@assembly/@component.2/@service.2" cycles="500" networkUsage=
    "1000.0">
229 <provide connects="//@assembly/@component.2/@outport.2"/>
230 <depend>
231 <require internal="//@assembly/@component.2/@inport.2"/>
    </depend>

```



```

232     </service>
233 </componentinstance>
234 <componentinstance id="ProvidePowerModeInfo_Instance" compatible="
    //@assembly/@component.3" variancePercentage="0.05">
235     <service instance="//@assembly/@component.3/@service.0" cycles="400" networkUsage=
        "1000.0">
236         <provide connects="//@assembly/@component.3/@outport.0"/>
237         <depend>
238             <require external="//@repository/@externalport.2"/>
239         </depend>
240     </service>
241 </componentinstance>
242 <componentinstance id="ControlEngineSpeedGauge_Instance" compatible="
    //@assembly/@component.4" variancePercentage="0.05">
243     <service instance="//@assembly/@component.4/@service.0" cycles="2850" networkUsage
        ="2000.0">
244         <provide connects="//@assembly/@component.4/@outport.0"/>
245         <depend>
246             <require internal="//@assembly/@component.4/@inport.0"/>
247         </depend>
248     </service>
249 </componentinstance>
250 <componentinstance id="ControlVehicleSpeedGauge_Instance" compatible="
    //@assembly/@component.5" variancePercentage="0.05">
251     <service instance="//@assembly/@component.5/@service.0" cycles="2950" networkUsage
        ="2000.0">
252         <provide connects="//@assembly/@component.5/@outport.0"/>
253         <depend>
254             <require internal="//@assembly/@component.5/@inport.0"/>
255         </depend>
256     </service>
257 </componentinstance>
258 <componentinstance id="Gauge_Engine_Instance" compatible="//@assembly/@component.6"
    variancePercentage="0.05">
259     <service instance="//@assembly/@component.6/@service.0" cycles="500">
260         <depend>
261             <require internal="//@assembly/@component.6/@inport.0"/>
262         </depend>
263     </service>
264 </componentinstance>
265 <componentinstance id="TransmissionVehicleInterface_Instance" compatible="
    //@assembly/@component.7" variancePercentage="0.05">
266     <service instance="//@assembly/@component.7/@service.0" cycles="100" networkUsage=
        "1000.0">
267         <provide connects="//@assembly/@component.7/@outport.0"/>
268         <depend>
269             <require external="//@repository/@externalport.5"/>
270         </depend>
271     </service>
272 </componentinstance>
273 <componentinstance id="ControlGearSelectedIndication_Instance" compatible="
    //@assembly/@component.8" variancePercentage="0.05">
274     <service instance="//@assembly/@component.8/@service.0" cycles="2500" networkUsage
        ="1000.0">
275         <provide connects="//@assembly/@component.8/@outport.0"/>
276         <depend>
277             <require internal="//@assembly/@component.8/@inport.0"/>
278         </depend>
279     </service>
280 </componentinstance>
281 <componentinstance id="Display_Engine_Instance" cost="55.0" compatible="
    //@assembly/@component.9" variancePercentage="0.05">
282     <service instance="//@assembly/@component.9/@service.0" cycles="500" networkUsage=
        "1000.0">

```

```

283     <depend>
284         <require internal="//@assembly/@component.9/@inport.0"/>
285     </depend>
286 </service>
287 <service instance="//@assembly/@component.9/@service.1" cycles="500" networkUsage=
    "1000.0">
288     <depend>
289         <require internal="//@assembly/@component.9/@inport.1"/>
290     </depend>
291 </service>
292 <service instance="//@assembly/@component.9/@service.2" cycles="500" networkUsage=
    "1000.0">
293     <depend>
294         <require internal="//@assembly/@component.9/@inport.2"/>
295     </depend>
296 </service>
297 <service instance="//@assembly/@component.9/@service.3" cycles="500" networkUsage=
    "1000.0">
298     <depend>
299         <require internal="//@assembly/@component.9/@inport.3"/>
300     </depend>
301 </service>
302 </componentinstance>
303 <componentinstance id="ReadOATSensor_Instance" compatible="//@assembly/@component.10
    " variancePercentage="0.05">
304     <service instance="//@assembly/@component.10/@service.0" cycles="1000"
        networkUsage="1000.0">
305         <provide connects="//@assembly/@component.10/@outport.0"/>
306         <depend>
307             <require external="//@repository/@externalport.6"/>
308         </depend>
309     </service>
310 </componentinstance>
311 <componentinstance id="ControlOutsideAirTemp_Instance" compatible="//@assembly/@component.11" variancePercentage="0.05">
312     <service instance="//@assembly/@component.11/@service.0" cycles="2744"
        networkUsage="1000.0">
313         <provide connects="//@assembly/@component.11/@outport.0"/>
314         <depend>
315             <require internal="//@assembly/@component.11/@inport.0"/>
316         </depend>
317     </service>
318 </componentinstance>
319 <componentinstance id="ControlCoolantTempGauge_Instance" compatible="//@assembly/@component.12" variancePercentage="0.05">
320     <service instance="//@assembly/@component.12/@service.0" cycles="1500"
        networkUsage="1000.0">
321         <provide connects="//@assembly/@component.12/@outport.0"/>
322         <depend>
323             <require internal="//@assembly/@component.12/@inport.0"/>
324         </depend>
325     </service>
326 </componentinstance>
327 <componentinstance id="ReadDriverDoorAjarSwitch_Instance" cost="1.0" compatible="//@assembly/@component.13" variancePercentage="0.05">
328     <service instance="//@assembly/@component.13/@service.0" cycles="100" networkUsage
        ="1000.0">
329         <provide connects="//@assembly/@component.13/@outport.0"/>
330         <depend>
331             <require external="//@repository/@externalport.0"/>
332         </depend>
333     </service>
334 </componentinstance>
335 <componentinstance id="ControlOdometer_Instance" compatible="//@assembly/@component

```

```

336     .14" variancePercentage="0.05">
337     <service instance="//@assembly/@component.14/@service.0" cycles="2440"
338         networkUsage="4000.0">
339         <provide connects="//@assembly/@component.14/@outport.0"/>
340         <depend>
341             <require internal="//@assembly/@component.14/@inport.0"/>
342             <require external="//@repository/@externalport.7"/>
343         </depend>
344     </service>
345 </componentinstance>
346 <componentinstance id="ReadTripStemButton_Instance" compatible="
347     //@assembly/@component.15" variancePercentage="0.05">
348     <service instance="//@assembly/@component.15/@service.0" cycles="100" networkUsage
349         ="1000.0">
350         <provide connects="//@assembly/@component.15/@outport.0"/>
351         <depend>
352             <require external="//@repository/@externalport.1"/>
353         </depend>
354     </service>
355 </componentinstance>
356 <componentinstance id="ReadLowWasherLevel_Instance" compatible="
357     //@assembly/@component.16" variancePercentage="0.05">
358     <service instance="//@assembly/@component.16/@service.0" cycles="100" networkUsage
359         ="1000.0">
360         <provide connects="//@assembly/@component.16/@outport.0"/>
361         <depend>
362             <require external="//@repository/@externalport.8"/>
363         </depend>
364     </service>
365 </componentinstance>
366 <componentinstance id="ControlWasherLevelIndication_Instance" compatible="
367     //@assembly/@component.17" variancePercentage="0.05">
368     <service instance="//@assembly/@component.17/@service.0" cycles="300" networkUsage
369         ="1000.0">
370         <provide connects="//@assembly/@component.17/@outport.0"/>
371         <depend>
372             <require internal="//@assembly/@component.17/@inport.0"/>
373         </depend>
374     </service>
375 </componentinstance>
376 <processor id="MIPS-60" clock="600.0" cost="50.0" internalBusBandwidth="1000.0"
377     internalBusDelay="0.001" lowerFail="0.01" upperFail="0.02"/>
378 <processor id="MIPS-10" clock="100.0" cost="15.0" internalBusBandwidth="1000.0"
379     internalBusDelay="0.001" lowerFail="0.01" upperFail="0.02"/>
380 <processor id="MIPS-80" clock="800.0" cost="100.0" internalBusBandwidth="1000.0"
381     internalBusDelay="0.001" lowerFail="0.01" upperFail="0.02"/>
382 <processor id="MIPS-100" clock="1000.0" cost="120.0" internalBusBandwidth="1000.0"
383     internalBusDelay="0.001" lowerFail="0.01" upperFail="0.02"/>
384 <processor id="MIPS-40" clock="400.0" cost="50.0" internalBusBandwidth="1000.0"
385     internalBusDelay="0.001" lowerFail="0.01" upperFail="0.02"/>
386 <bus id="CAN-HS" bandwidth="500.0" delay="0.002" cost="1.0"/>
387 <bus id="CAN-MS" bandwidth="125.0" delay="0.008" cost="0.5"/>
388 <bus id="CAN-LS" bandwidth="33.3" delay="0.016" cost="0.25"/>
389 <bus id="LIN" bandwidth="10.0" delay="0.05" cost="0.1"/>
390 <externalport id="ajar-switch" lowerFail="0.01" upperFail="0.05"/>
391 <externalport id="stem-button" lowerFail="0.01" upperFail="0.05"/>
392 <externalport id="ignition-switch" lowerFail="0.01" upperFail="0.05"/>
393 <externalport id="crankshaft-sensor" lowerFail="0.01" upperFail="0.05"/>
394 <externalport id="wheel-sensor" lowerFail="0.01" upperFail="0.05"/>
395 <externalport id="gear-sensor" lowerFail="0.01" upperFail="0.05"/>
396 <externalport id="oat-sensor" lowerFail="0.01" upperFail="0.05"/>
397 <externalport id="odometer-storage" lowerFail="0.01" upperFail="0.05"/>
398 <externalport id="lowwasher-switch" lowerFail="0.01" upperFail="0.05"/>
399 </repository>

```

```
387 <objectives>
388   <settings noRun="1" noSampling="50" maxCost="10000.0">
389     <evaluations>ResponseTime</evaluations>
390     <evaluations>CPUUtilization</evaluations>
391     <evaluations>BusUtilization</evaluations>
392     <evaluations>Safety</evaluations>
393     <evaluations>Cost</evaluations>
394   </settings>
395 </objectives>
396 </aqosa.ir:AQOSAModel>
```

References

- [1] H. Posadas, F. Herrera, P. Sanchez, E. Villar, F. Blasco: *System-Level Performance Analysis in SystemC*. DATE, IEEE Computer Society, 2004, pp. 378–383.