

Dynamic environment coupling induce synchronized states in coupled time-delayed electronic circuits

R. Suresh¹, K. Srinivasan¹, D. V. Senthilkumar^{2,3}, K. Murali⁴, M. Lakshmanan¹, and J. Kurths^{3,5}

¹*Centre for Nonlinear Dynamics, School of Physics,
Bharathidasan University, Tiruchirapalli-620024, India*

²*Centre for Dynamics of Complex Systems, University of Potsdam, 14469 Potsdam, Germany*

³*Potsdam Institute for Climate Impact Research, 14473 Potsdam, Germany*

⁴*Department of Physics, Anna University, Chennai, India*

⁵*Institute of Physics, Humboldt University, 12489 Berlin, Germany*

(Dated: November 17, 2018)

We experimentally demonstrate the occurrence of various synchronized states in coupled piecewise linear time-delayed electronic circuits using dynamic environment coupling where the environment has its own intrinsic dynamics via feedback from the circuits. We carry out these experiments in two different coupling configurations, namely mutual and subsystem coupling configurations. Depending upon the coupling strength and the nature of feedback, we observe a transition from nonsynchronization to complete synchronization via phase synchronization and from nonsynchronization to inverse synchronization via inverse-phase synchronization between the circuits in hyperchaotic regime. Snapshots of the time evolution, phase projection plots and localized sets of the circuits as observed experimentally from the oscilloscope, along with supporting numerical simulations confirm the existence of different synchronized states. Further, the transition to different synchronized states can be verified from the changes in the largest Lyapunov exponents, Correlation of Probability of Recurrence and Correlation Coefficient as a function of the coupling strength. We present a detailed linear stability analysis and obtain conditions for different synchronized states.

PACS numbers: 05.45.Xt, 05.45.Pq

Synchronization is one of the collective phenomena most intensely studied in the chaotic dynamical systems. Considerable amount of research has been focused on small assemblies of low dimensional coupled chaotic systems and various types of synchronization have been demonstrated both numerically and experimentally. Recent studies on synchronization have also focused on higher-dimensional systems such as time-delay systems, which exhibit highly complicated hyperchaotic attractors with multiple positive Lyapunov exponents. Different kinds of synchronizations and their transitions have also been identified and reported in these systems with different coupling configurations using numerical simulations but only limited studies are available from experimental point of view. In this paper, we experimentally investigate and report the existence of various types of synchronizations and their transitions in time-delayed electronic circuits which are coupled through a common dynamic environment along with supporting numerical results. We demonstrate different synchronization transitions in two coupling configurations, namely mutual and subsystem coupling configurations. We have also presented a linear stability analysis to find the conditions for different synchronized states.

I. INTRODUCTION

Synchronization is a ubiquitous phenomenon often observed in coupled chaotic and hyperchaotic systems [1, 2]. Depending upon the strength and the nature of coupling, various types of synchronizations such as phase synchronization (PS), complete synchronization (CS), generalized synchronization, lag and anticipatory synchronizations, inverse phase synchronization (IPS) and inverse synchronization (IS) have been observed in coupled dynamical systems. All these types of synchronizations are achieved in ensembles of dynamical systems through some common coupling schemes, namely linear and nonlinear error feedback couplings [3, 4], coupling via dissimilar and/or time-delayed variables [5–7], inhibitory coupling [8], coupling via dynamical relaying [9], adaptive coupling [10] and also systems driven by a common noise [11] etc.

In many real world systems, synchronization can occur due to interaction through a common dynamic medium and hence the systems also evolve similar to their environment under the influence of the latter. Examples include synchronization of chemical and genetic oscillators [12–14], synchronized behavior with self pulsating periodic and chaotic oscillations produced by an ensemble of cold atoms interacting with a coherent electromagnetic field [15], and in synchronizations of cells, in coupled circadian oscillators due to common global neurotransmitter oscillation [16]. In all the cases, the coupling function has a dynamics modulated by the system dynamics. In this connection, Resmi et al [17] have recently shown and

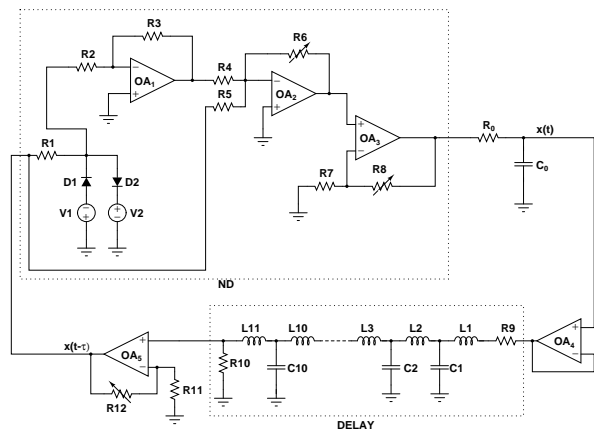

FIG. 1: Circuit diagram of a single time delayed feedback oscillator with a nonlinear device (ND) unit, a time-delay unit (DELAY) and a low pass first-order R_0C_0 filter.

verified numerically the existence of various types of synchronizations in low-dimensional chaotic systems which are coupled through a dynamic environment without intrinsic or coupling time-delay.

Time-delay systems are an important class of dynamical systems which occur in many real world systems and synchronizing such systems is having potential applications in diverse areas of science, engineering and technology [18–22] due to their hyperchaotic nature. During the past few years, researchers are interested in synchronizing such time-delay systems and mostly all known synchronizations and their transitions are identified and reported in two coupled time-delay systems using numerical simulations [2]. In contrast, only very few studies are available from an experimental point of view. Experimentally generating and synchronizing such hyperchaotic electronic signals (with multiple positive Lyapunov exponents) is very important where these signals may be used to hide secret messages in the area of secure communication and cryptography [23].

In this paper, we demonstrate experimentally the occurrence of various types of synchronizations and their transitions in indirectly coupled time-delayed electronic circuits with intrinsic time-delay using dynamic environment coupling. We carry out these studies in two different coupling configurations, namely mutual coupling configuration where both the circuits and environment are mutually sharing their feedback, and subsystem coupling configuration where both the circuits are sharing their feedback with the environment, while only one of the circuits is receiving feedback from the environment. Depending upon the coupling strength and the nature of feedback, we observe different types of synchronization transitions in the coupled circuits which include transition from nonsynchronization to CS via PS and from nonsynchronization to IS via IPS in both coupling configurations. Snapshots of time evolution, phase projection and localized sets of the circuits as observed from the

oscilloscope confirm the existence of different synchronized states experimentally along with corresponding numerical results. Further, the transition to different synchronized states can be numerically quantified from the changes in the largest Lyapunov Exponents (LEs), Correlation of Probability of Recurrence (CPR) and Correlation Coefficient (CC) of the coupled systems as a function of the coupling strength. We also present a detailed linear stability analysis and obtain synchronization conditions for different synchronized states in the present system.

The remaining paper is organized as follows: In Sec. II, we will describe briefly about the system employed to demonstrate different synchronized states and explain the circuit realization. In Sec. III we explain the mutual coupling configuration and present the experimental and numerical results to confirm various types of synchronizations along with the necessary linear stability analysis. In Sec. IV, we describe the subsystem coupling configuration and demonstrate the occurrence of different synchronization transitions and, finally, we summarize our results with conclusion in Sec. V.

II. DYNAMIC ENVIRONMENT COUPLING

A. System description

First we consider a single scalar delay differential equation given as

$$\dot{x} = -\alpha x(t) + \beta f(x(t - \tau)) \quad (1)$$

where the nonlinear function $f(x)$, is represented by a piecewise linear function

$$f(x) = AF^* - Bx. \quad (2)$$

Here

$$F^* = \begin{cases} -x^*, & x < -x^* \\ x, & -x^* \leq x \leq x^* \\ x^*, & x > x^*. \end{cases} \quad (3)$$

The system parameters are fixed as $\alpha = 1.0$, $\beta = 1.2$, time-delay $\tau = 6.0$, $A = 5.2$, $B = 3.5$ and $x^* = 0.7$ throughout the manuscript. For these chosen parameter values the single system (1) exhibits a hyperchaotic attractor with three positive LEs [24, 25].

B. Circuit realization

The design of the electronic circuit which describes the dynamics of Eq.(1) along with the threshold piecewise linear function $f(x)$ is given in Fig. 1. This circuit consists of a diode based nonlinear device (ND) with two amplification stages (OA_1 and OA_2), a time-delay unit (DELAY) and a low pass first order R_0C_0 filter. Here $\mu A741s$ are engaged as operational amplifiers. V_1 and

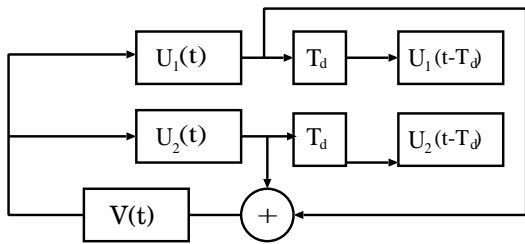

FIG. 2: Circuit block diagram of the coupled time delayed feedback oscillator for mutual coupling configuration (4).

V_2 are the constant voltage sources of all active devices ($\pm 12V$). Using these voltage values V_1 and V_2 , one can easily adjust the threshold values of the three segment piecewise function (Eq. (3)). By applying the Kirchhoff's laws to this circuit the state equation can be written as $R_0 C_0 \frac{dU(t)}{dt} = -U(t) + F[k_f(U(t - T_d))]$, where $U(t)$ is the voltage across the capacitor C_0 , $U(t - T_d)$ is the voltage across the delay unit, $T_d = n\sqrt{LC}$ is the time-delay, n is the number of LC filter units, and $F[k_f(U(t - T_d))]$ is the static characteristic of the ND unit.

To study the circuit equation, we transform it to the dimensionless equation (1) by defining the dimensionless variables and parameters as $x(t) = \frac{U(t)}{U_s}$, $t' = \frac{t}{R_0 C_0}$, $\tau = \frac{T_d}{R_0 C_0}$, $k_f = \beta$, and $t' \rightarrow t$. The circuit parameters are fixed as $R_1 = 1K\Omega$, $R_2 = R_3 = 10K\Omega$, $R_4 = 2K\Omega$, $R_5 = 3K\Omega$, $R_6 = 10.4K\Omega$ (trimmer-pot), $R_7 = 1K\Omega$, $R_8 = 5K\Omega$ (trimmer-pot), ($R_9 = R_{10} = 1K\Omega$, $R_{11} = 10K\Omega$, $R_{12} = 20K\Omega$ (trimmer-pot), $R_0 = 1.86K\Omega$, $C_0 = 100nF$, $L_i = 12mH$ ($i = 1, 2, \dots, 11$), $C_i = 470nF$ ($i = 1, 2, \dots, 10$), $n = 10$. $T_d = 0.751ms$, $R_0 C_0 = 0.268ms$, and so the time-delay $\tau \approx 2.8$ for the chosen circuit parameter values.

III. MUTUAL COUPLING CONFIGURATION

We now construct a circuit which consists of a system of two identical time-delayed sub circuits with threshold piecewise linear nonlinearity and are coupled indirectly through a common environment. Here both the circuits and environment are mutually sharing their feedback with each other and the state equation for the coupled circuit can be written as

$$R_0 C_0 \frac{dU_1(t)}{dt} = -\alpha' U_1(t) + f[k_f U_1(t - T_d)] + \varepsilon'_1 \beta'_1 V(t), \quad (4a)$$

$$R_0 C_0 \frac{dU_2(t)}{dt} = -\alpha' U_2(t) + f[k_f U_2(t - T_d)] + \varepsilon'_1 \beta'_2 V(t), \quad (4b)$$

$$R_0 C_0 \frac{dV(t)}{dt} = -k' V(t) - \frac{\varepsilon'_2}{2} [\beta'_1 U_1(t) + \beta'_2 U_2(t)] \quad (4c)$$

where $U_1(t)$ and $U_2(t)$ correspond to the output variables of each circuit and $V(t)$ is the output of the environment.

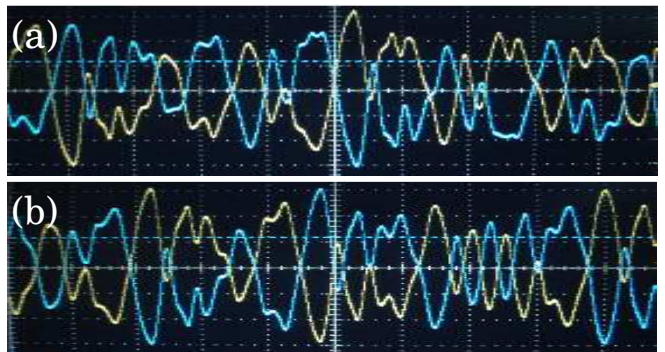

FIG. 3: (Color online) Snap shots of the time evolution of the coupled systems (yellow $U_1(t)$ and green $U_2(t)$) with mutual coupling configuration (4) obtained from the oscilloscope indicating the existence of (a) IPS and (b) IS in time-delayed electronic circuits. Vertical scale $2.0v/div$ and horizontal scale $2.0ms/div$.

tal equation. The schematic diagram for this coupled circuit is sketched in Fig. 2. By defining the normalized variables and parameters as above and $x_{1,2}(t) = \frac{U_{1,2}(t)}{U_s}$, $y(t) = \frac{V(t)}{V_s}$ one can obtain the equivalent dimensionless equation as follows:

$$\dot{x}_1(t) = -\alpha x_1(t) + \beta f[x_1(t - \tau)] + \varepsilon_1 \beta_1 y, \quad (5a)$$

$$\dot{x}_2(t) = -\alpha x_2(t) + \beta f[x_2(t - \tau)] + \varepsilon_1 \beta_2 y, \quad (5b)$$

$$\dot{y} = -ky - \frac{\varepsilon_2}{2} (\beta_1 x_1 + \beta_2 x_2), \quad (5c)$$

where, $\alpha' = \alpha$, $\beta'_{1,2} = \beta_{1,2}$, $\varepsilon'_{1,2} = \varepsilon_{1,2}$ and $k' = k$. Here the two systems $x_1(t)$ and $x_2(t)$ are not directly coupled to each other, instead they are coupled through a coupling function (y) which has a dynamics modulated by the system dynamics. ε_1 is the strength of the feedback to the systems and ε_2 is the strength of the feedback to the environment (coupling parameters). β_1 and β_2 are the nature of feedback from and to the environment, respectively. k is the damping parameter and we choose it as $k = 1$. In the absence of feedback from the systems to the environment, the strength of the environment decays exponentially fast as $k > 0$.

A. Experimental and numerical observations

We have experimentally observed different types of synchronization in the coupled electronic circuits which are also confirmed using numerical simulations. Depending upon the feedback strength β_1 and β_2 we observe two types of synchronization transitions in the coupled systems. When β_1 and β_2 are of the same sign, for example $(\beta_1, \beta_2) = (1, 1)$, we observe a transition from non-synchronization to IS via IPS and when β_1 and β_2 are of different sign, $(\beta_1, \beta_2) = (1, -1)$, then we observe a transition from non-synchronization to CS via PS as a function of the coupling strength.

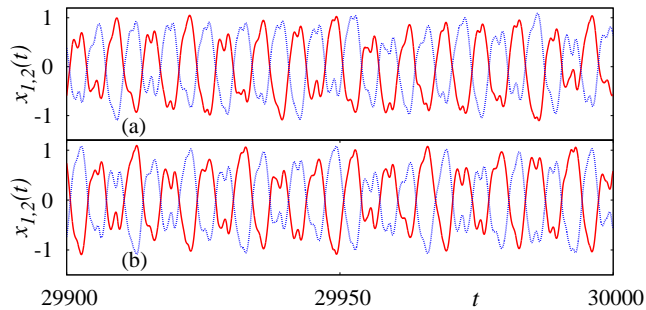

FIG. 4: (Color online) The numerically obtained time series for $(\beta_1, \beta_2) = (1, 1)$ in mutual coupling configuration (5). (a) IPS for $\varepsilon = 0.6$ and (b) IS occurs for $\varepsilon = 1.5$.

First, we consider the case of $(\beta_1, \beta_2) = (1, 1)$ and for simplicity we have chosen the value of the coupling strengths $\varepsilon_1 = \varepsilon_2 = \varepsilon$. In the absence of the coupling ($\varepsilon = 0$) both the circuits oscillate independently, and for sufficiently large value of the coupling strength the phase difference between the circuits is exactly π , that is the systems exhibit IPS. On increasing the coupling strength to further larger values, IS occurs between the circuits.

Snapshots of the wave forms of the circuits as seen in the oscilloscope are shown in Fig. 3. The existence of IPS between the circuits is depicted in Fig. 3(a) where the circuits are evolving with phase difference of π but still the amplitudes are uncorrelated. Figure. 3(b) shows the realization of IS between the systems where both phase and amplitude are correlated and occur exactly opposite to each other. If we numerically solve Eq. (5), we obtain IPS for $\varepsilon = 0.6$ which is depicted in Fig. 4 and this synchronization can also be confirmed both experimentally and numerically using the phase projection plots which are shown in Figs. 5(a) and 5(c), respectively. Further increase the coupling strength to $\varepsilon = 1.5$ the systems exhibit IS where the maxima of both systems occur exactly opposite to each other as depicted in Fig. 4(b). The corresponding experimental and numerical phase projection plots of the systems are given in Figs. 5(b) and 5(d), respectively.

Phase coherence of the systems is further qualitatively visualized both experimentally and numerically using the framework of localized sets [26]. The basic idea of this characterization is that the set of points obtained by sampling the time-series of the system 1 whenever the maximum occurs in system 2 is plotted along with the attractor of the system 1 and vice versa. If the coupled systems are said to be phase synchronized then the sets are localized on the attractor, otherwise they spread over the entire attractor implying asynchronization. This provides an easy and efficient way to detect phase synchronization even in non-phase-coherent attractors.

The experimental observation of the localized sets is shown in Fig. 6. In the absence of the coupling ($\varepsilon = 0$), the sets are distributed over the entire attractor which

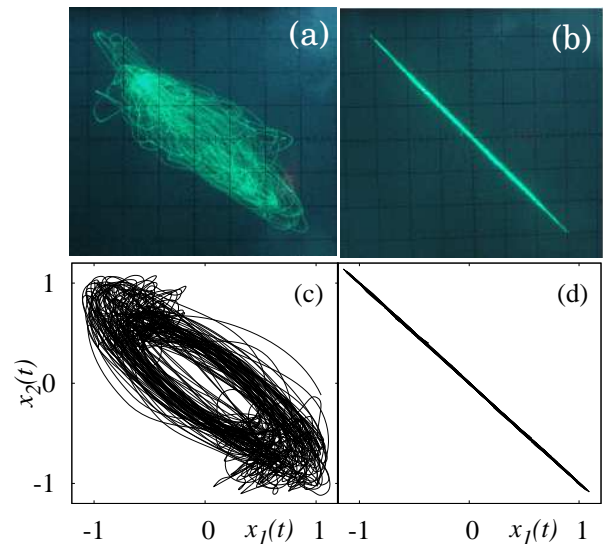

FIG. 5: (Color online) Experimental (vertical scale $2.0v/div$ and horizontal scale $2.0v/div$) and numerical observations of phase projections of the coupled systems for mutual coupling configuration. (a), (c) IPS occurs for $\varepsilon = 0.6$ and (b), (d) IS occurs for $\varepsilon = 1.5$.

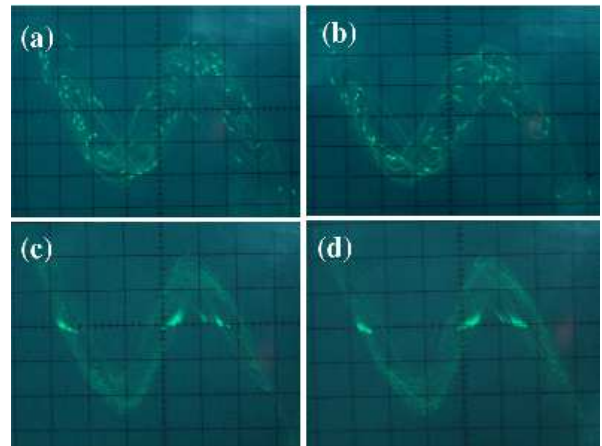

FIG. 6: (Color online) Experimental realization of the framework of localized sets. (a), (b) The sets are spread over the attractors indicating the absence of phase coherence in the absence of the coupling. (c), (d) For a sufficiently large value of coupling strength, the sets are localized on the attractors which indicates IPS for mutual coupling configuration. Vertical scale $2.0v/div$ and horizontal scale $0.5v/div$.

corresponds to the absence of phase coherence. Figures 6(a) and 6(b) show that the attractors of the two systems along with the sets for the case of nonphase synchronization. The corresponding numerically obtained figures are plotted in Figs. 7(a) and 7(b) for $\varepsilon = 0$. For sufficiently large value of the coupling strength, the sets are localized on their corresponding attractors which confirm a perfect phase locking of the systems [Figs. 6(c) and 6(d)]. The corresponding numerical figures are plotted in Figs. 7(c)

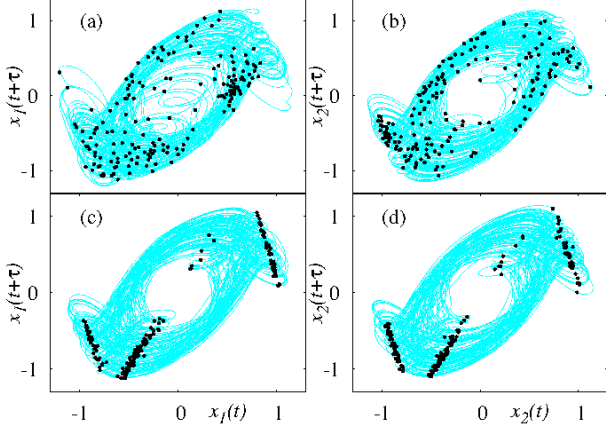

FIG. 7: (Color online) Numerically obtained corresponding figures for the localized sets. (a), (b) The sets are spread over the entire attractors in the absence of the coupling ($\varepsilon = 0$). (c), (d) For the value of $\varepsilon = 0.6$, the sets are localized on the attractors.

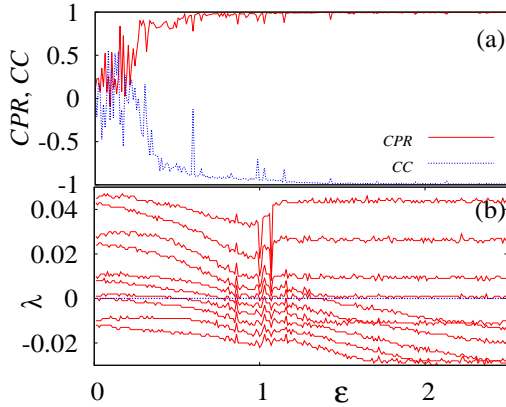

FIG. 8: (Color online) (a) CPR (continuous line), CC (dotted line) and (b) spectrum of maximal LEs for $(\beta_1, \beta_2) = (1, 1)$ in mutual coupling configuration as a function of coupling strength $\varepsilon \in (0, 2.5)$.

and 7(d) for the value of $\varepsilon = 0.6$.

Next, the transition from nonsynchronization to IS via IPS can be characterized by the changes in the spectrum of maximal LEs. Also the phase coherence is further quantified using the index CPR. Complete and inverse synchronizations can be quantified using the CC. these are given by the expressions,

$$CPR = \langle \bar{P}_1(t) \bar{P}_2(t) \rangle / \sigma_1 \sigma_2, \quad (6)$$

$$CC = \frac{\langle (x_1(t) - \langle x_1(t) \rangle)(x_2(t) - \langle x_2(t) \rangle) \rangle}{\sqrt{\langle (x_1(t) - \langle x_1(t) \rangle)^2 \rangle \langle (x_2(t) - \langle x_2(t) \rangle)^2 \rangle}} \quad (7)$$

where $\langle \rangle$ brackets indicate time average. Using Eq. (6), we calculate the index CPR. Here $\bar{P}_{1,2}$ means that

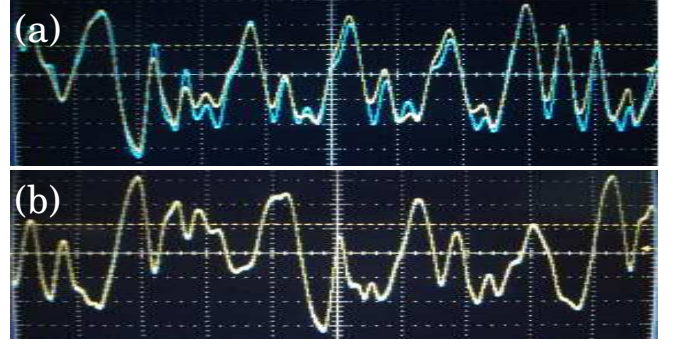

FIG. 9: (Color online) Snap shots of the time evolution of both coupled circuits (yellow $U_1(t)$ and green $U_2(t)$) indicating the existence of (a) PS and (b) IPS in coupled time-delayed electronic circuits for mutual coupling configuration with $(\beta_1, \beta_2) = (1, -1)$. Vertical scale $2.0v/div$ and horizontal scale $1.0ms/div$.

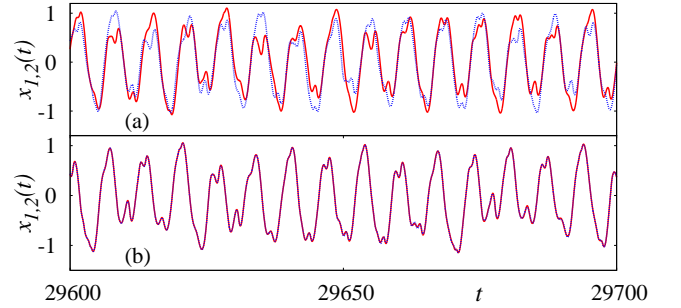

FIG. 10: (Color online) The time series of the coupled systems in mutual coupling configuration (5) for $(\beta_1, \beta_2) = (1, -1)$. (a) PS for $\varepsilon = 0.6$ and (b) CS for $\varepsilon = 1.5$.

the mean value has been subtracted, $\sigma_{1,2}$ are the standard deviations of P_1 and P_2 and $P(t)$ is a generalized autocorrelation function based on recurrence properties [27]. If the phase of the systems are perfectly locked, then the probability of recurrence is maximal at the time t and $CPR \approx 1$, otherwise the maxima do not occur simultaneously and hence one can expect a drift in both the probability of recurrence resulting in low values of CPR. Using Eq. (7), we calculate the CC to characterize the CS and IS between the systems. If both systems are in CS state then, $CC \approx 1$ and for IS state CC will be ≈ -1 .

In Fig. 8(a) we have plotted the numerically calculated CPR (continuous line), CC (dotted line) and in Fig. 8(b) we have plotted the ten largest LEs of the coupled systems as a function of the coupling strength $\varepsilon \in (0, 2.5)$. In the absence of the coupling ($\varepsilon = 0$), the index CPR and CC are near to zero which confirms that the systems are evolving without any synchronization with six positive LEs (three for each systems). If the coupling strength increases, the index CPR also starts to increase towards unit value and for $\varepsilon = 0.56$, CPR is oscillating near unity

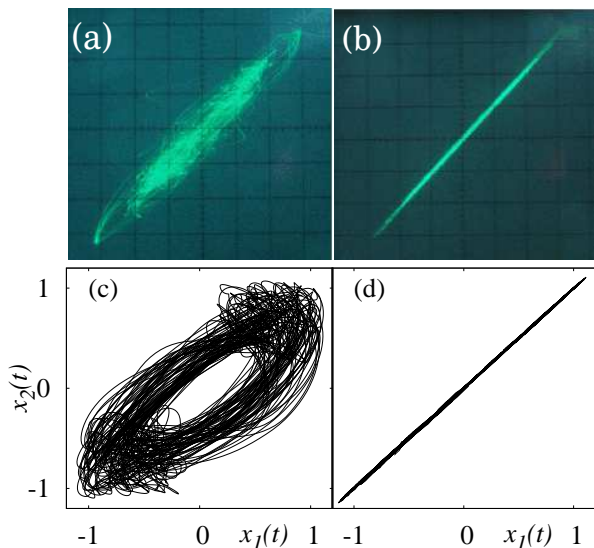

FIG. 11: (Color online) Experimental (vertical scale $2.0v/div$ and horizontal scale $2.0v/div$) and numerical phase projection plots of the coupled systems with mutual coupling configuration for $(\beta_1, \beta_2) = (1, -1)$. (a), (c) PS for $\varepsilon = 0.6$ and (b), (d) IS for $\varepsilon = 1.5$.

(CPR ≈ 0.97) whereas the value of CC becomes negative which indeed confirms the onset of IPS. Additional confirmation comes from the changes in the LEs, where the zeroth LE of the coupled system becomes negative at $\varepsilon = 0.56$ which indicates the existence of IPS. If we increase the coupling strength further, the CC of the coupled systems decreases and reaches the value ≈ -0.99 at $\varepsilon = 1.39$. At this value of ε , except for the three positive LEs, all the other positive LEs of the coupled systems become negative which indeed confirms the existence of IS in the coupled time-delay systems.

Next, we consider the case with $(\beta_1, \beta_2) = (1, -1)$ (different signs). Now we observe the transition from nonsynchronization to CS via PS as a function of the coupling strength. In this case, for lower values of coupling strength the individual circuits evolve independently, while for $\varepsilon = 0.56$ the circuits exhibit PS and for further larger value of ε ($\varepsilon = 1.39$) both systems attain a CS state.

The experimental snapshots and numerical plots of the time series of the coupled systems are depicted in Figs. 9(a) and 10(a), respectively, for $\varepsilon = 0.6$ indicating that the circuits are evolving with PS. This is also verified (both experimentally and numerically) using the phase projection plots [Figs. 11(a) and 11(c)], respectively. On further increase of the coupling strength to $\varepsilon = 1.5$, the circuits exhibit CS with each other which is depicted in Figs. 9(b) and 10(b) (both experimentally and numerically, respectively). The corresponding experimental and numerical phase projection plots of the systems are given in Figs. 11(b) and 11(d), respectively.

PS is further confirmed by the framework of localized

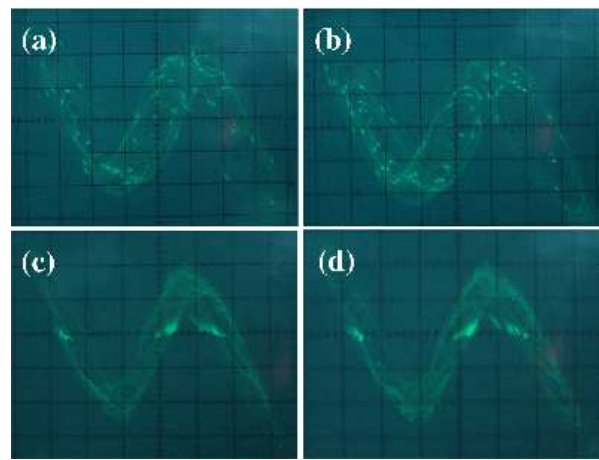

FIG. 12: (Color online) Experimental realization of the framework of localized sets in the case of $(\beta_1, \beta_2) = (1, -1)$ in mutual coupling configuration. (a), (b) The sets are spread over the attractors indicating the absence of phase coherence. (c), (d) The sets are localized on the attractors which indicates phase synchronization. Vertical scale $2.0v/div$ and horizontal scale $0.5v/div$.

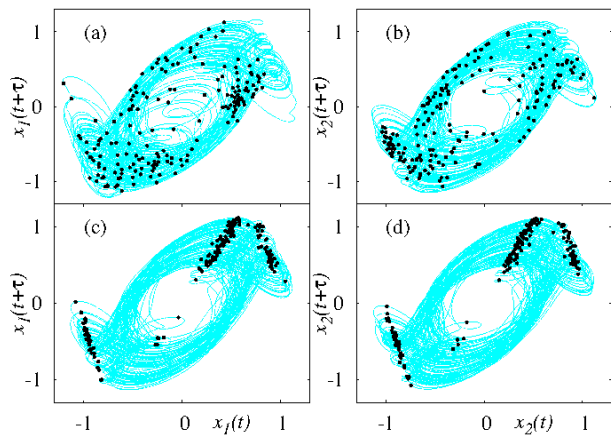

FIG. 13: (Color online) Numerically obtained equivalent figures for Fig. 12. (a), (b) The sets are spread over the entire attractors for $\varepsilon = 0$ and (c,d) the sets are localized on attractors which shows PS for $\varepsilon = 0.6$.

sets. The experimental observations of localized sets are presented in Fig. 12. The sets are distributed over entire attractors which confirm no synchronization in the absence of the coupling [Figs. 12(a) and 12(b)]. The corresponding numerical figures are shown in Figs. 13(a) and 13(b) for $\varepsilon = 0$. For sufficiently large value of coupling strength, the sets are localized on the attractors which confirm a perfect phase locking between the systems [Figs. 12(c) and 12(d)]. The equivalent numerical figures are given in Figs. 13(c) and 13(d) for the value of coupling strength $\varepsilon = 1.5$.

In Fig. 14(a) we have plotted the index CPR, CC and in Fig. 14 (b) we have plotted ten maximal LEs of the

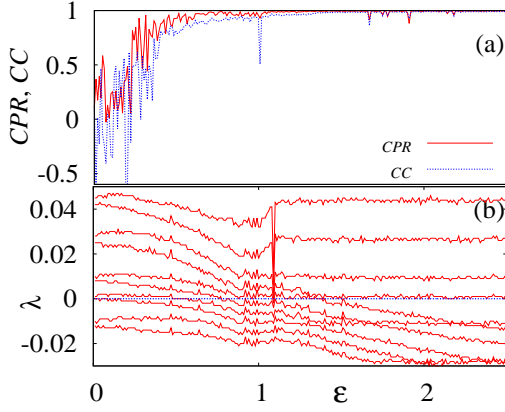

FIG. 14: (Color online) (a) CPR (continuous line), CC (dotted line) and (b) spectrum of maximal LEs for $(\beta_1, \beta_2) = (1, -1)$ in mutual coupling configuration as a function of coupling strength $\varepsilon \in (0, 2.5)$.

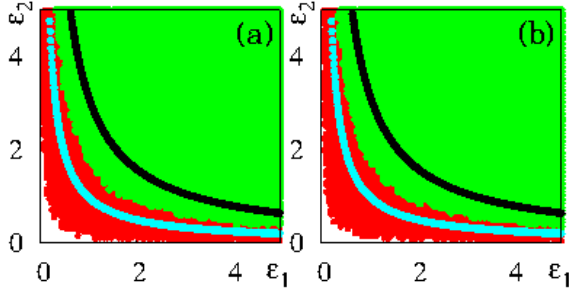

FIG. 15: (Color online) (a), (b) Two parameter diagrams in $(\varepsilon_1 - \varepsilon_2)$ plane shows various types of synchronization states in mutual coupling configuration for $(\beta_1, \beta_2) = (1, 1)$ and $(\beta_1, \beta_2) = (1, -1)$, respectively. In both figures, the white color indicates desynchronized state, red color represents IPS and PS regime and green color belongs to IS and CS regime. The black points indicate the analytically obtained stability condition of the outer regime of the piecewise linear function [Eq. (3)] and blue (light gray) points indicate the stability condition for the middle region of the piecewise linear function.

coupled systems as a function of the coupling strength $(\varepsilon \in (0, 2.5))$. In the absence of the coupling, the index CPR and $CC \approx 0$ confirming that the systems are independently oscillating without any synchronization. Once the coupling strength increases beyond 0.5 ($\varepsilon = 0.56$), the index CPR increases and reaches a value close to unity ($CPR \approx 0.97$) and CC becomes ≈ 0.8 , confirming the onset of PS but still the amplitudes are uncorrelated [Fig. 14(a)]. PS is also confirmed from the changes in the LEs where the zeroth LE of the coupled systems become negative at $\varepsilon > 0.5$ [Fig. 14(b)]. Further, for $\varepsilon = 1.39$, the CC of the systems reach the unit value (≈ 0.99) which is depicted in Fig. 14(a) and for this ε value, except for the

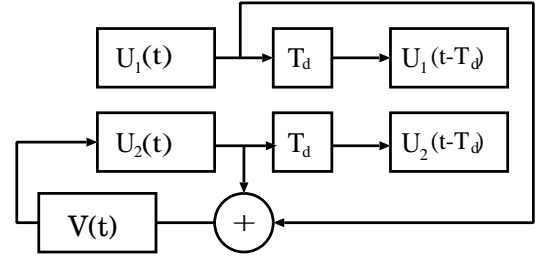

FIG. 16: Circuit block diagram of the coupled time delayed feedback oscillator for subsystem coupling configuration (16).

three positive LEs, all the other positive LEs of the coupled system become negative confirming the existence of CS [Fig. 14(b)].

To identify the global picture of the different synchronization transition regimes we have plotted the phase diagrams in the two parameter plane of coupling strengths $(\varepsilon_1, \varepsilon_2)$. We use the index CPR to mark the PS and IPS regimes. In addition, CS and IS regimes are marked using the CC between the systems. The phase diagrams in the $(\varepsilon_1 - \varepsilon_2)$ plane for coupled time-delay systems are shown in Fig. 15(a) and 15(b) for $(\beta_1, \beta_2) = (1, 1)$ and $(1, -1)$, respectively. In Figs. 15(a) and 15(b) the red color (dark gray) corresponds to IPS and PS regimes and the green color (light gray) regime indicates IS and CS states. Also the white color corresponds to desynchronized state.

B. Linear stability analysis

In this section, we give a detailed stability analysis for the synchronized states of the two dynamically coupled time-delay systems. To find the stability of the synchronization, we apply a infinitesimal perturbation to the system (5). Let ξ_1, ξ_2 and z represent the perturbations then Eq. (5) can be rewritten as

$$\dot{\xi}_1 = g'(x_1, x_{1\tau})\xi_1 + \varepsilon_1\beta_1z, \quad (8a)$$

$$\dot{\xi}_2 = g'(x_2, x_{2\tau})\xi_2 + \varepsilon_1\beta_2z, \quad (8b)$$

$$\dot{z} = -kz - \frac{\varepsilon_2}{2}[\beta_1\xi_1 + \beta_2\xi_2]. \quad (8c)$$

Here $g'(x, x_\tau)$ is the derivative of the Eq. (2) and for the two outer regime of Eq. (3) it can be written as $g'(x, x_\tau) = -(\alpha + \beta B)$ and for the middle region $g'(x, x_\tau) = -\alpha + \beta(A - B)$.

Equation (8) is difficult to solve with the present form and so, we consider the special case of complete synchronization state ($x_1 = x_2$). Now Eq. (8) can be simplified by defining

$$\xi_0 = \beta_1\xi_1 + \beta_2\xi_2. \quad (9)$$

So Eq. (8) becomes,

$$\dot{\xi}_0 = \lambda\xi_0 + \varepsilon_1(\beta_1^2 + \beta_2^2)\gamma z, \quad (10a)$$

$$\dot{z} = -kz - \frac{\varepsilon_2}{2}\gamma^T\xi_0. \quad (10b)$$

Here $\lambda = g'(x, x_\tau)$. The synchronized state is said to be stable if all the LEs obtained from Eq. (10) are negative. Eq. 10 can be further simplified by choosing $\beta_1^2 + \beta_2^2 = 2$ and eliminating z from it so that we get an equation

$$\ddot{\xi}_0 = (\lambda - k)\dot{\xi}_0 + (\lambda k - \varepsilon_1 \varepsilon_2)\xi_0. \quad (11)$$

Consider a solution of the form

$$\xi_0 = Ae^{mt}, \quad (12)$$

so that we get

$$m = \frac{(\lambda - k) \pm \sqrt{(\lambda - k)^2 - 4(\varepsilon_1 \varepsilon_2 - \lambda k)}}{2}. \quad (13)$$

The synchronized state is stable if $Re[m]$ is negative for both the solutions. This provides the following criteria for the stable synchronized state:

1. If $(\lambda - k)^2 < 4(\varepsilon_1 \varepsilon_2 - \lambda k)$, then m is complex and the stability condition is $k > \lambda$.
2. If $(\lambda - k)^2 > 4(\varepsilon_1 \varepsilon_2 - \lambda k)$, then m is real and the stability condition becomes $k > \lambda$ and $\varepsilon_1 \varepsilon_2 > \lambda k$. Here the transition to stable synchronization is given by the threshold values of parameters satisfying the condition

$$\varepsilon_1 > \frac{(\lambda + k)^2}{4\varepsilon_2}. \quad (14)$$

From Eq. (14) one can obtain the threshold value of the coupling strength for the synchronized states. For instance we choose $\lambda = -\alpha + \beta(A - B)$ corresponding to the middle regime ($|x| \leq x^*$) of Eq. (3) and $\lambda = -(\alpha + \beta B)$ corresponding to the outer regime ($|x| > x^*$) and the feedback $(\beta_1, \beta_2) = (1, 1)$ we obtain a transition from no synchronization to IS state which is plotted along with the numerically obtained synchronized region. The black points in Fig. 15(a) correspond to the condition for the stable synchronization state for the outer regime and the blue points indicate the stability condition of the middle regime of the piecewise linear function. This shows that the numerically obtained IS regime occurs in between the analytically obtained regime. Similar transition curves are also observed for transition from no synchronization to CS in the case of $(\beta_1, \beta_2) = (1, -1)$ [Fig. 15(b)].

IV. SUBSYSTEM COUPLING CONFIGURATION

Further, we have also considered a second form of coupling called subsystem coupling configuration, where both the circuits share their feedback with the environment, while only one of the circuits is receiving the feedback from the environment. The schematic circuit block diagram for this coupling configuration is sketched in

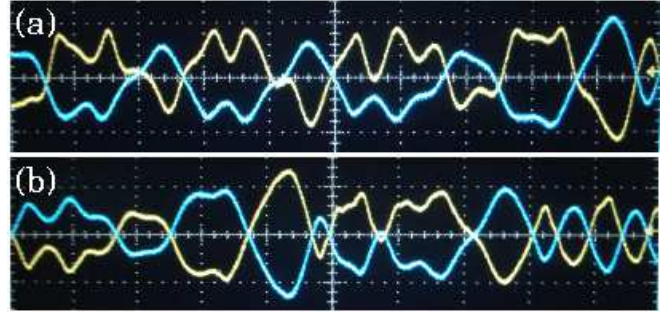

FIG. 17: (Color online) Snap shots of the time evolution of both coupled circuits (yellow $U_1(t)$ and green $U_2(t)$) indicating the existence of (a) IPS and (b) IS in coupled time-delayed electronic circuits for subsystem coupling configuration (15) with $(\beta_1, \beta_2) = (1, 1)$. Vertical scale $5.0v/div$ and horizontal scale $2.0ms/div$.

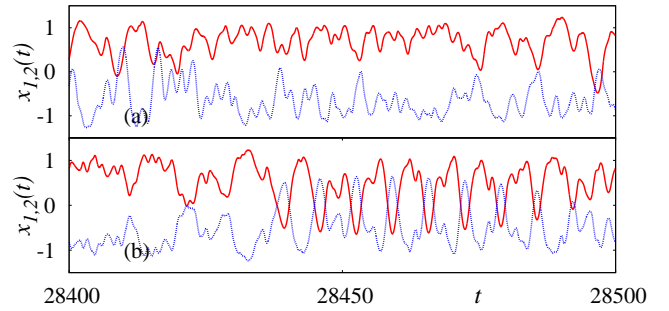

FIG. 18: (Color online) The time series of the coupled systems in subsystem coupling configuration (16) with $(\beta_1, \beta_2) = (1, 1)$. (a) IPS for $\varepsilon = 1.2$ and (b) IS for $\varepsilon = 2.0$.

Fig. 16 and the state equations can be given as follows:

$$R_0 C_0 \frac{dU_1(t)}{dt} = -\alpha' U_1(t) + f[k_f U_1(t - T_d)], \quad (15a)$$

$$R_0 C_0 \frac{dU_2(t)}{dt} = -\alpha' U_2(t) + f[k_f U_2(t - T_d)] + \varepsilon_1' \beta_2' V(t), \quad (15b)$$

$$R_0 C_0 \frac{dV(t)}{dt} = -k' V(t) - \frac{\varepsilon_2'}{2} [\beta_1' U_1(t) + \beta_2' U_2(t)], \quad (15c)$$

and the corresponding dimensionless equations for this configuration can be defined as

$$\dot{x}_1(t) = -\alpha x_1(t) + \beta f[x_1(t - \tau)], \quad (16a)$$

$$\dot{x}_2(t) = -\alpha x_2(t) + \beta f[x_2(t - \tau)] + \varepsilon_1 \beta_2 y, \quad (16b)$$

$$\dot{y} = -k y - \frac{\varepsilon_2}{2} (\beta_1 x_1 + \beta_2 x_2). \quad (16c)$$

Here the circuits of $U_1(t)$ and $U_2(t)$ ($x_1(t)$ and $x_2(t)$) are sharing their feedback with the environment but only the circuit of $U_2(t)$ is receiving feedback from the environment. The parameters are fixed as in the previous case. First we consider the case $(\beta_1, \beta_2) = (1, 1)$

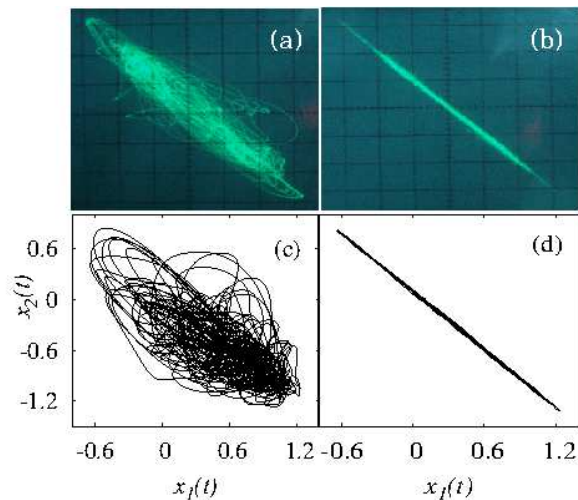

FIG. 19: (Color online) Experimental (vertical scale $2.0v/div$ and horizontal scale $2.0v/div$) and numerical observation of phase projection plots for the subsystem coupling configuration (16) with $(\beta_1, \beta_2) = (1, 1)$. (a), (c) IPS for $\varepsilon = 1.2$ and (b), (d) IS for $\varepsilon = 2.0$.

and we obtain the same kind of transition from IPS (for $\varepsilon > 1.0$) to IS (for $\varepsilon > 1.9$). The experimental and numerical snap shots of the time evolution of the coupled systems show IPS for the value of coupling strength $\varepsilon = 1.2$ which is evident from Figs. 17(a) and 18(a), respectively. This can also be confirmed both experimentally and numerically using the phase projection plots [Figs. 19(a) and 19(c)]. If we increase the coupling to further larger values, at $\varepsilon = 2.0$ both circuits attain IS as depicted in Figs. 17(b) and 18(b) (experimentally and numerically), respectively. The corresponding experimental and numerical phase projection plots are presented in Figs. 19(b) and 19(d), respectively.

The localized sets plots are again presented to confirm the existence of IPS. The experimentally obtained attractors along with the sets are shown in Figs. 20(a) and 20(b) where the sets are distributed over entire attractors in the absence of any coupling and the corresponding numerical figures are depicted in Figs. 21(a) and 21(b) for $\varepsilon = 0$. For sufficiently larger values of the coupling strength, one can observe that the sets are localized on the attractors confirming the perfect locking of the phase of the systems [Figs. 20(c) and 20(d)]. The equivalent numerical figures are plotted in Figs. 21(c) and 21(d) for $\varepsilon = 1.2$.

The transition from IPS to IS can again confirmed by plotting the index CPR, CC and the changes in the maximal LEs as a function of the coupling strength. In the absence of the coupling the systems are evolving without any synchronization (with six positive LEs) and so CPR and $CC \approx 0$. For $\varepsilon = 1.02$, the value of index CPR increases towards unity and reaches the value $CPR \approx 0.97$, whereas CC becomes negative which confirms

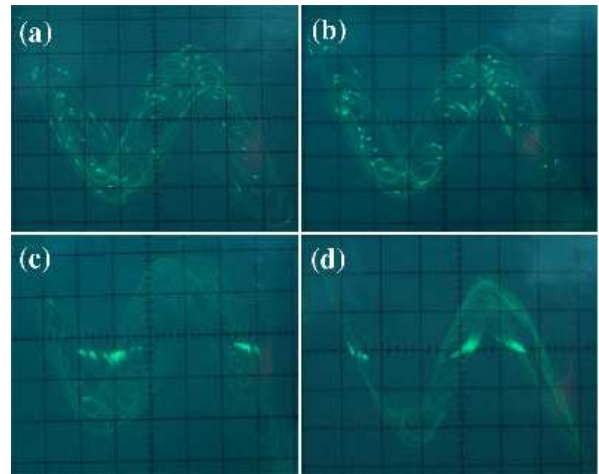

FIG. 20: (Color online) Experimental realization of the framework of localized sets in subsystem coupling configuration with $\beta_1, \beta_2 = (1, 1)$. (a), (b) The sets are spread over the attractors indicating the absence of phase coherence. (c), (d) The sets are localized on the attractors which indicates the occurrence of IPS. Vertical scale $2.0v/div$ and horizontal scale $0.5v/div$.

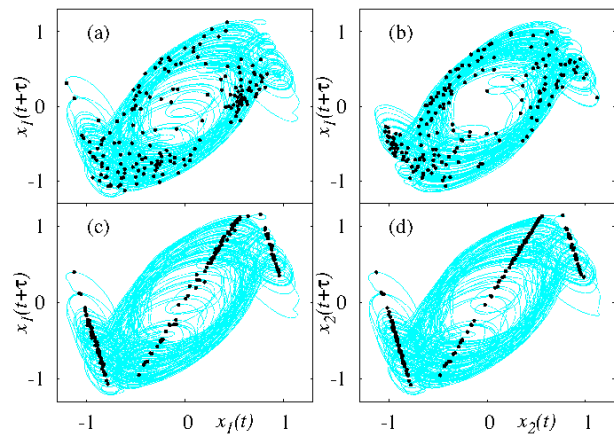

FIG. 21: (Color online) Numerically obtained equivalent figures for Fig. 20. (a), (b) The sets are spread over the entire attractors for $\varepsilon = 0$ and (c), (d) the sets are localized in one part of the attractor which shows IPS for $\varepsilon = 1.2$.

the onset of IPS state [Fig. 22(a)]. This transition is also confirmed from the changes in the LEs where the zeroth LE of the coupled system becomes negative for this value of ε indicating the existence of IPS which is evident from Fig. 22(b). On further increase of the coupling strength to $\varepsilon = 1.91$ the systems exhibit IS transition where the CC becomes ≈ -0.99 [Fig. 22(a)] and from Fig. 22(b), we notice that except for the three positive LEs, all the other positive LEs become negative confirming the existence of IS in the coupled time-delay system.

Finally, we consider the case $(\beta_1, \beta_2) = (1, -1)$. We obtain a transition from no synchronization to CS via

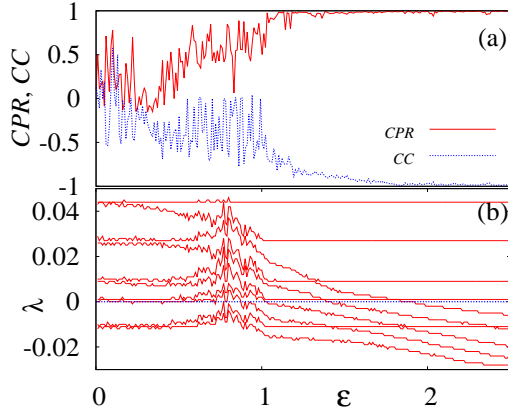

FIG. 22: (Color online) (a) CPR (continuous line), CC (dotted line) and (b) spectrum of maximal LEs for $(\beta_1, \beta_2) = (1, 1)$ in subsystem coupling configuration as a function of coupling strength $\varepsilon \in (0, 2.5)$.

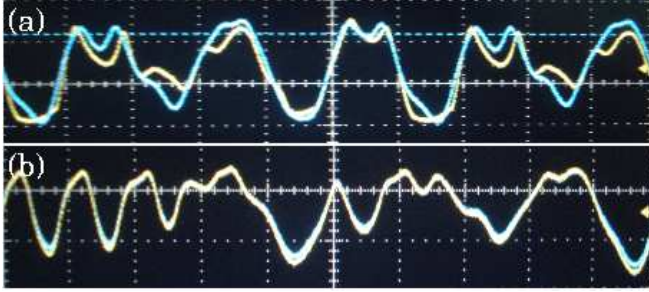

FIG. 23: (Color online) Snap shots of the time evolution of both coupled circuits (yellow $U_1(t)$ and green $U_2(t)$) indicating the existence of (a) PS and (b) CS in coupled time-delayed electronic circuits for subsystem coupling configuration (15). Vertical scale $5.0v/div$ and horizontal scale $1.0ms/div$.

PS in the coupled time-delayed electronic circuit. The experimental snap shots of the time evolution of both circuits are displayed in Fig. 23(a) indicating that the systems exhibit PS and the numerically obtained figure is depicted in Fig. 24(a) for $\varepsilon = 1.2$. The corresponding experimental and numerical phase projection plots are displayed in Figs. 25(a) and 25(c), respectively. CS is observed between the circuits for further larger value of the coupling strength and the experimental wave forms for suitable ε is shown in Fig. 23(b) exhibiting CS. Figure 24(b) shows the numerically obtained time traces of the two systems displaying CS and Figs. 25(b) and 25(d) show the corresponding phase projections (obtained by experimental and numerical simulations, respectively) of the systems for $\varepsilon = 2.0$.

PS between the circuits can be once again visualized by plotting the localized sets. Figure 26 shows the experimentally observed attractors along with the sets. In Figs. 26(a) and 26(b) the sets are distributed over the entire attractor for lower values of coupling strength due

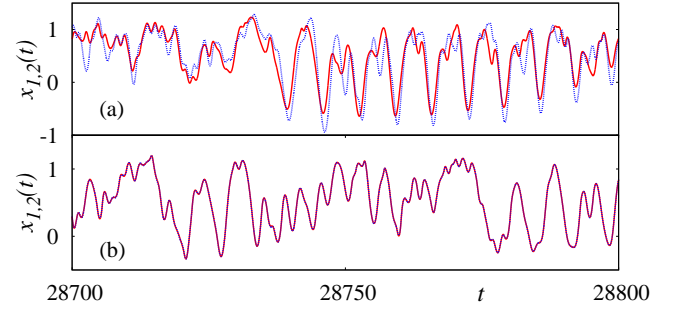

FIG. 24: (Color online) Numerically obtained time series of the coupled systems in subsystem coupling configuration (16) with $(\beta_1, \beta_2) = (1, -1)$. (a) PS for $\varepsilon = 1.2$ and (b) CS for $\varepsilon = 2.0$.

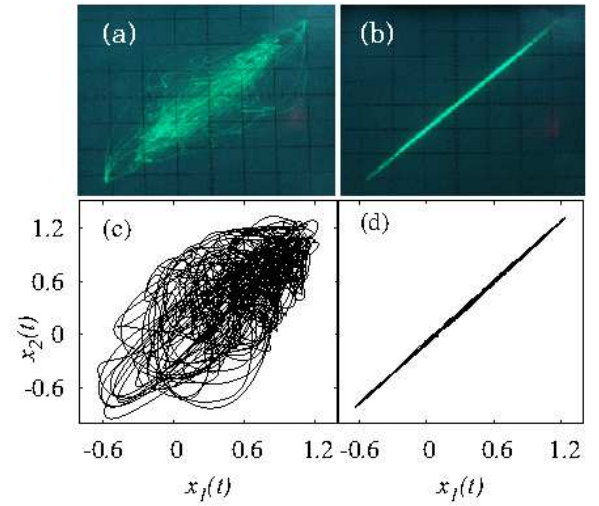

FIG. 25: (Color online) Experimental (vertical scale $2.0v/div$ and horizontal scale $2.0v/div$) and numerical phase projection plots of the coupled systems with subsystem coupling configuration (16) with $(\beta_1, \beta_2) = (1, -1)$. (a), (c) PS for $\varepsilon = 1.2$ and (b), (d) IS for $\varepsilon = 2.0$.

to the absence of PS. The corresponding numerically obtained figures are plotted in Figs. 27(a) and 27(b) for $\varepsilon = 0$. If we increase the coupling strength to a sufficiently large value, the sets are localized on the attractor as depicted in Figs. 26(c) and 26(d) confirming the phase locking of both the systems. The corresponding numerically obtained figures are plotted in Figs. 27(c) and 27(d) for the value of $\varepsilon = 1.2$.

In the absence of the coupling the systems are evolving freely without any synchronization with six positive LEs (three for each systems) and so CPR and $CC \approx 0$. Beyond $\varepsilon > 1.0$ ($\varepsilon = 1.02$), CPR becomes ≈ 0.97 which confirms the existence of PS which is depicted in Fig., 28(a). At this value of ε , the zeroth LE of the coupled system becomes negative which is shown in Fig. 28(b). If we increase the coupling strength further, the CC of the

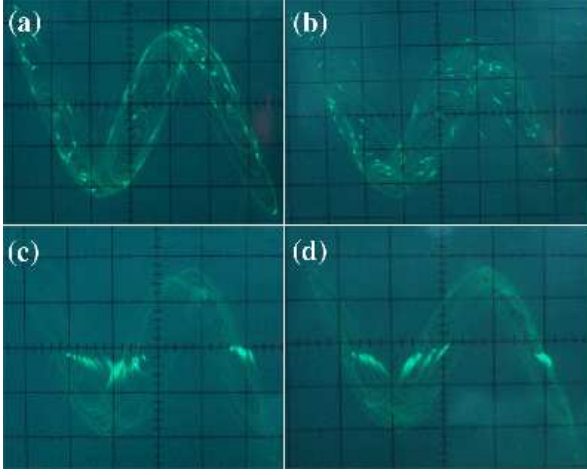

FIG. 26: (Color online) Experimental realization of the localized sets for the case of $(\beta_1, \beta_2) = (1, -1)$ in subsystem coupling configuration. (a), (b) The sets are spread over the attractors indicating the absence of phase coherence. (c), (d) The sets are localized on the attractors which indicates phase synchronization. Vertical scale $2.0v/div$ and horizontal scale $0.5v/div$.

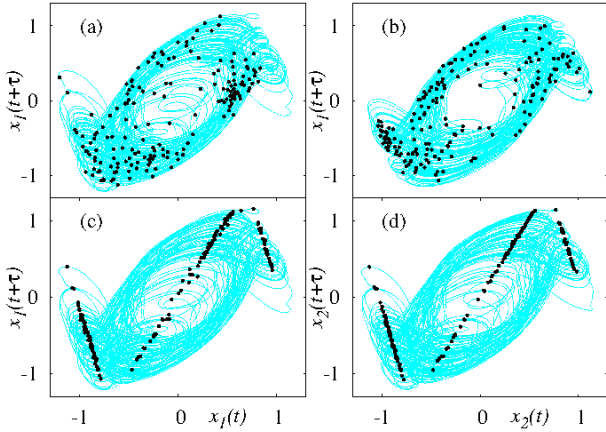

FIG. 27: (Color online) Numerically obtained equivalent localized sets figures for Fig. 26. (a), (b) The sets are spread over the entire attractors for $\varepsilon = 0$ and (c), (d) the sets are localized in one part of the attractor which confirms IPS for $\varepsilon = 1.2$.

systems increases and reaches the unit value at $\varepsilon = 1.91$ which is evident from Fig. 28(a) and for this value of coupling strength all the positive LEs (except three positive LEs) become negative confirming the existence of CS in the coupled time-delay systems [Fig. 18(b)].

The phase diagrams in the parameter plane of coupling strengths are plotted to identify the global picture of the regimes of different types of synchronization states. The phase diagrams in the $(\varepsilon_1 - \varepsilon_2)$ plane for coupled time-delay systems (Eq. 16) are shown in Fig. 29(a) and 29(b) for $(\beta_1, \beta_2) = (1, 1)$ and $(1, -1)$, respectively. In these

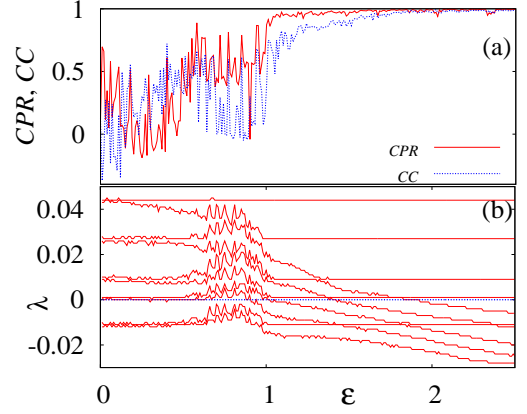

FIG. 28: (Color online) (a) CPR (continuous line), CC (dotted line) and (b) spectrum of maximal LEs for subsystem coupling configuration with $(\beta_1, \beta_2) = (1, -1)$ in subsystem coupling configuration as a function of coupling strength $\varepsilon \in (0, 2.5)$.

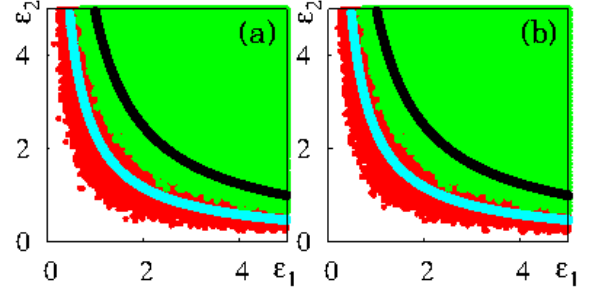

FIG. 29: (Color online) (a), (b) Two parameter diagrams in $(\varepsilon_1 - \varepsilon_2)$ plane shows various types of synchronization states in subsystem coupling configuration for $(\beta_1, \beta_2) = (1, 1)$ and $(\beta_1, \beta_2) = (1, -1)$, respectively. In both figures, the white color indicates desynchronized state, red color represents IPS and PS regime and green color belongs to IS and CS regime. The black points indicate the analytically obtained stability condition of the outer regime of the piecewise linear function (Eq. 3) and blue (light gray) points indicate the stability condition for the middle region of the piecewise linear function.

figures, red color (dark gray) corresponds to IPS and PS regime, respectively, and green color (light gray) indicate IS and CS states, respectively. Also the white color corresponds to desynchronized state.

We have also carried out a linear stability analysis for the above coupling configuration as in Sec. III B and it gives a condition for the stability of the synchronized states as $\varepsilon_1 > \frac{(\lambda+k)^2}{2\varepsilon_2}$. From this relation one can obtain the threshold value of the coupling strength for different synchronized states. For example, we choose λ values as in Sec. III and the feedback $(\beta_1, \beta_2) = (1, 1)$, we obtain a transition from no synchronization to IS state which is

plotted along with the numerically obtained synchronized region. The black points in Fig. 29(a) correspond to the outer regime of the piecewise linear function (3) and the blue points indicate the stability state of the middle regime. Similar to Fig.15, the numerically obtained synchronization regime occurs in between the analytically obtained regimes. Figure 29(b) shows the transition curves for the case of $(\beta_1, \beta_2) = (1, -1)$ which indicates the transition from no synchronization to CS in subsystem coupling configuration.

V. CONCLUSION

In this paper, we have experimentally demonstrated the occurrence of various types of synchronization in coupled piece-wise linear time-delayed electronic circuits with threshold nonlinear function where the circuits are coupled indirectly through a common dynamic environment. We have carried out these studies in two different coupling configurations, namely mutual and subsystem coupling configurations. In both configurations, depending upon the strength of the coupling and the nature of the feedback, we observe different types of synchronization transitions in the coupled circuits such as transition from IPS to IS and from PS to CS in hyperchaotic

regimes. Snapshots of the time evolution, phase projection and localized sets plots of the circuits observed from the oscilloscope confirm the various synchronization phenomenon experimentally. The corresponding numerical simulations are also presented in detail. Further, the transition to different synchronization states can be verified from the changes in the maximal LEs, index CPR and CC of the coupled systems as a function of the coupling strength. Also we have presented a detailed linear stability analysis to obtain synchronization conditions for different synchronized states.

Note: After the completion of this work, we have come across the recent arXiv paper by T. Banerjee and D. Biswas [28], which deals with a similar problem on synchronization in hyperchaotic time-delayed electronic oscillators coupled indirectly via a common environment using a *tanh* nonlinearity under bidirectional coupling, confirming the occurrence of in-phase and inverse-phase synchronization phenomena.

The work of R.S., K.S. and M.L. has been supported by the Department of Science and Technology (DST), Government of India sponsored IRHPA research project. M.L. has also been supported by a DST Ramanna project and a DAE Raja Ramanna Fellowship. D.V.S. and J.K. acknowledge the support from EU under project No. 240763 PHOCUS(FP7-ICT-2009-C).

-
- [1] A. S. Pikovsky, M. G. Rosenblum, and J. Kurths, *Synchronization - A Unified Approach to Nonlinear Science* (Cambridge University Press, Cambridge, 2001).
 - [2] M. Lakshmanan, and D. V. Senthilkumar, *Dynamics of Nonlinear Time-Delay Systems* (Springer-Verlag, Berlin, 2011).
 - [3] D. V. Senthilkumar, and M. Lakshmanan, Phys. Rev. E **76**, 066210 (2007).
 - [4] D. V. Senthilkumar, M. Lakshmanan, and J. Kurths, Phys. Rev. E **74**, 035205(R) (2006).
 - [5] R. Karnatak, R. Ramaswamy, and A. Prasad, Phys. Rev. E **76**, 035101(R) (2007).
 - [6] T. Murphy et. al, Phil. Trans. R. Soc. A **368**, 343 (2010).
 - [7] D. V. Senthilkumar, and M. Lakshmanan, Phys. Rev. E **71**, 016211 (2005).
 - [8] D. V. Senthilkumar, J. Kurths, and M. Lakshmanan, Chaos **19**, 023107 (2009).
 - [9] I. Fischer et. al, Phys. Rev. Lett. **76**, 123092 (2006).
 - [10] Q. Ren, and J. Zhao, Phys. Rev. E **76**, 016207 (2007).
 - [11] C. Zhou, and J. Kurths, Phys. Rev. Lett. **88**, 230602 (2002), Chaos **13**, 401 (2003) .
 - [12] R. Toth, A. F. Taylor, and M. R. Tinsley, J. Phys. Chem. B **110**, 10170 (2006).
 - [13] A. Kuznetsov, M. Kaerm, and N. Kopell, SIAM J. Appl. Math. **65**, 392 (2004).
 - [14] R. Wang, and L. Chen, J. Biol. Rhythms **20**, 257 (2005).
 - [15] J. Javaloyes, M. Perrin, and A. Politi, Phys. Rev. E **78**, 011108 (2008).
 - [16] D. Gonze, S. Bernard, C. Waltermann, A. Kramer, and H. Herzl, Biophys. J. **89**, 120 (2005).
 - [17] V. Resmi, G. Ambika, and R. E. Amritkar, Phys. Rev. E **81**, 046216 (2010).
 - [18] F. M. Atay, *Complex Time-Delay Systems: Theory and Applications* (Springer, Berlin, 2010).
 - [19] M. G. Resenblum, A. S. Pikovsky, and J. Kurths, Phys. Rev. Lett. **76**, 1804 (1996).
 - [20] A. V. Rangan, and D. Cai, Phys. Rev. Lett. **96**, 178101 (2006).
 - [21] S. Sinha, and S. Sinha, Phys. Rev. E **71**, 020902(R) (2005).
 - [22] X. Chen, and J. E. Cohen, J. Theor. Biol. **212**, 223 (2001).
 - [23] J. Peng, and X. F. Liao, J. Comput. Res. Dev. **40**, 263 (2003).
 - [24] K. Srinivasan, D. V. Senthilkumar, K. Murali, M. Lakshmanan, and J. Kurths, Chaos **21**, 023119 (2011).
 - [25] K. Srinivasan, I. Raja Mohamed, K. Murali, and M. Lakshmanan, Int. J. Bifurcation and Chaos **21**, 725 (2011).
 - [26] T. Pereira, M. S. Baptista, and J. Kurths, Phys. Rev. E **75**, 026216 (2007).
 - [27] N. Marwan, M. C. Romano, M. Thiel, and J. Kurths, Phys. Rep. **438**, 237 (2007).
 - [28] T. Banerjee, and D. Biswas, arXiv:1303.5339v1 [nlin.CD] (2013).

