

**Synthetic Biology in Leishmaniasis: Design,
simulation and validation of constructed
Genetic circuit**

Seat No.: 06

Dixita Limbachiya

OF

**G H Patel Post Graduate Department of
Computer Science and Technology (GDCST),
Sardar Patel University, V.V. Nagar**



Submitted to

SARDAR PATEL UNIVERSITY

**as a partial fulfillment of the degree of
Master of Science (Bioinformatics)**

JUNE 2012

**Synthetic Biology in Leishmaniasis: Design,
simulation and validation of constructed
Genetic circuit**

Project Report



Submitted to the
**G H Patel Post Graduate Department of
Computer Science and Technology (GDCST)**
Sardar Patel University, V. V. Nagar
In Partial Fulfillment of the award for the
Degree of Master of Science

By

Dixita Limbachiya
Under the guidance of
Dr. Shailza Singh
Scientist 'C'

National Centre for Cell Science Pune

June 2012

**Synthetic Biology in Leishmaniasis: Design,
simulation and validation of constructed
Genetic circuit**

Project Report



Submitted to the
National Centre for Cell Sciences

In Partial Fulfillment of the award for the
Degree of Master of Science

By
Dixita Limbachiya

Under the guidance of

Dr. Shailza Singh
Scientist 'C'
National Centre for Cell sciences Pune

June 2012

**G H PATEL POST GRADUATE DEPARTMENT OF
COMPUTER SCIENCE AND TECHNOLOGY
SARDAR PATEL UNIVERSITY
VALLABH VIDYANAGAR**

CERTIFICATE

This to certify that Ms. Dixita Limbachiya has worked on the project entitled "Synthetic Biology in Leishmaniasis: Design Simulation and Validation of constructed Genetic Circuit" towards the partial fulfillment of the degree of M. Sc. (Bioinformatics) during the final semester at National Centre for Cell Sciences Pune from 21-12-2011 to 39-5-2012.

Date of Submission:-2nd JUNE 2012

**Dr. Hetal J Panchal
Project Coordinator
Lecturer
GDCST**

**Dr. D. B. Choksi
Head of Department
Director and professor
GDCST**

Date: - 02/06/2012

UNDERTAKING

I, **Dixita Limbachiya**, student of the G.H. Patel Post Graduate Department of Computer Science and Technology, VallabhVidyanagar hereby undertake that the work presented in the dissertation project report entitled “**Synthetic Biology In Leishmaniasis:Design,Simulation and Validation Of Constructed Genetic Circuit**” comprises the results of independent and original work carried out by me under the supervision of **Dr.Shailza Singh** for the partial fulfillment of the award of the degree of M.Sc. Bioinformatics of the Sardar Patel University, VallabhVidyanagar.

I further declare that this work did not form a part of any other work published or unpublished.

Dixita Limbachiya

**G.H. Patel Post Graduate Department of
Computer Science and Technology,
VallabhVidyanagar, Gujarat.**

ACKNOWLEDGEMENT

The writing of this thesis has been one of the most significant academic challenges I have ever had to face. Without the support, patience and guidance of following people, this study would not have been completed. It is to them that I owe my deepest gratitude.

*I would like to sincerely thank my guide **Dr. Shailza Singh** for her guidance, understanding, patience, and most importantly, her friendly gesture during the dissertation period. Her mentorship was paramount in providing a well rounded experience to pursue my long-term career goals. She encouraged me not only to grow as a researcher but also as an independent thinker, not many post graduate students are given the opportunity to develop their own individuality and self-sufficiency by being allowed to work with such independence. Words are inadequate in the available lexicon to avouch the guidance given by her. Her dedication to research, meticulous planning, consecutive counsel and unreserved help served as a beacon light throughout the course of study, research work and completion of this manuscript. For everything you have done for me, madam I thank you.*

*I am grateful to my Head of the Department **Dr. Hetal Panchal** of **G.H. Patel Department of Computer science and Technology** for their cooperation throughout the study and for allowing me to pursue my dissertation program at NCCS.*

I would like to thank all the members of the Lab, especially Sonali Shinde, Vineetha Mandlik and Ashish Chaudhary for supporting me and encouraging me. They also provided for some much needed humor and entertainment in what could have otherwise been a somewhat stressful laboratory environment. I am thankful to my colleagues Radhika and Jyoti with whom I worked closely and made my journey of dissertation most memorable and enthusiastic. I am grateful to National Centre for Cell sciences for giving me opportunity to carry out my dissertation successfully.

Finally, and most importantly, I thank All Mighty for his blessing. It was under his watchful eyes that I gained so much drive and an ability to tackle challenges head on. I would like to thank my parents, brother and family members for their support, encouragement, patience and unwavering love which was always with me. I thank them for allowing me to be as ambitious as I wanted.

Dixita Limbachiya

CONTENTS

1. LIST OF FIGURES	I
2. LIST OF TABLES	II
3. ABBREVIATIONS	III
4. INTRODUCTION	1-3
5. REVIEW OF LITERATURE	4-30
6. METHODOLOGY	31-39
7. RESULTS AND DISCUSSION	40-66
8. CONCLUSION and FUTURE ASPECTS	66-67
9. REFERENCES	67-75
10. ABSTRACT	75-76
11. SUPPLEMENTARY FILES	76-115

LIST OF FIGURES

Figure no	Description	Page no
5.1	<i>Synergy between Systems and synthetic biology</i>	5
5.2	<i>Steps for construction of genetic circuit</i>	9
5.3	<i>Logic gates of Biochemical processes</i>	11
5.4	<i>Forms of Leishmania</i>	13
5.5	<i>Life cycle of Leishmania</i>	14
5.6	<i>Severity of lesions</i>	16
5.7	<i>Lipid rafts</i>	17
5.8	<i>Sphingolipid metabolism</i>	18
5.9	<i>Drugs for Cutaneous and visceral leishmaniasis</i>	19
5.10	<i>Genetic toggle switch</i>	20
5.11	<i>Repressilator</i>	21
5.12	<i>Schematic presentation of the genetic toggle switch made by Gardner et al.</i>	28
5.13	<i>The vector design of genetic toggle switch</i>	28
5.14	<i>Representation of the repressilator by Elowitz</i>	29
5.15	<i>The vector design of Repressilator</i>	29
6.1	<i>Schematic representation of workflow implemented in project</i>	32-33
7.1	<i>Orthology relation graph</i>	41
7.2	<i>Genetic circuit for IPCS</i>	42
7.3.a	<i>Degradation Rate graphs of IPCS_1</i>	44
7.3.b	<i>Degradation Rate graphs of IPCS_1</i>	44
7.4.a	<i>Degradation Rate graphs of LacI</i>	45
7.4.b	<i>Degradation Rate graphs of Tetr</i>	45
7.5.a	<i>Simulation results for IPCS_1 by change in the kc values of IPCS_1 (Kd=1)</i>	46
7.5.b	<i>Simulation results for IPCS_1 by change in the kc values of IPCS_1 (Kd=1.01)</i>	46

7.6.a	<i>Simulations results for circuit by change in the Kd values of IPCS_2 (Kd=1.01)</i>	47
7.6.b	<i>Simulations results for circuit by change in the Kd values of IPCS_2(Kd=1.02)</i>	47
7.7.a	<i>Logic gates for the genetic toggle switch</i>	48
7.7.b	<i>Logic gates for the repressilator</i>	48
7.8	<i>Conversion of a truth table into a digital circuit via the Karnaugh map method</i>	49
7.9	<i>Heat map plot of network link probabilities</i>	54
7.10	<i>Network uncertainty plot</i>	55
7.11	<i>Circadian clock network generated for IPCS_1 and IPCS_2</i>	56
7.12.a	<i>Indicator variable of Gibbs variable selection</i>	56
7.12.b	<i>Co-efficient of linear Regression</i>	56
7.12.c	<i>Precision of each regression</i>	56
7.12.d	<i>Intercept of each regression</i>	56
7.13	<i>Inferred network of the genetic circuit for IPCS (10s)</i>	57
7.14	<i>Inferred network of the genetic circuit for IPCS(100s)</i>	58
7.15	<i>Attractor plot for the initial attractor of the network.</i>	62
7.16	<i>Attractor plot of the two steady states</i>	63
7.17	<i>sequences of path to attractor</i>	64
7.18	<i>Robustness plot of the genetic circuit.</i>	65
7.19	<i>State graph of the transition of states</i>	66

LIST OF TABLES

Table no	Description	Page no
5.1	<i>Logic gates in biological systems</i>	11
5.2	<i>Type of leishmaniasis</i>	15
6.1	<i>Commands and description of GRENITS</i>	37
6.2	<i>Commands and description in BoolNet</i>	38
7.1	<i>Homologs of IPCS</i>	40
7.2	<i>Model summary of the genetic circuit</i>	43
7.3	<i>Truth Table for the genetic circuit</i>	48
7.4	<i>Karnaugh map of the truth table</i>	49
7.5	<i>Posterior probabilities for each network connection</i>	53
7.6	<i>Posterior probabilities for number of regulators</i>	53
7.7	<i>Binarized Time series data</i>	59

ABBREVIATIONS:

WHO	World health Organization
AMA	Amastigotes
PRO	Promastigote
GSL	Glycosphingolipids;
IPC	Inositol phosphorylceramide
LPG	Lipophosphoglycan
PL	Phospholipids
GIPL	Glycoinositolphospholipid.
SL	Sphingolipids
IPCS	Inositol Phosphoryl ceramide synthase
DAG	Diacylglycerol
PC	Phosphorylceramide
SM	Sphingomyelin
PI	Phosphoryl Inositol
MIPC	Mannose inositol Phosphoryl ceramide
DNA	Deoxyribonucleic acid
mRNA	Messenger ribonucleic acids
GRN	Gene Regulatory Network
ODE	Ordinary Differential Equation
SBML	Systems Biology Markup Language
COPASI	Complex Pathway Simulator
LacI	Lactose repressor
Tetr	Tetracycline repressor
GRENITS	Gene Regulatory Network using Time Series Data

BoolNet

Boolean Network

MCMC

Monte Carlo Markov Chain

URL

Uniform Resource Locator

In recent years, the disciplines of systems biology and synthetic biology have gained prominence as the embodiments of the future of biological science. For biological circuits, we need to produce quantitative predictions of cell behavior for a given genotype as consequence of the different molecular interactions. There is a great synergy between the fields of systems and synthetic biology such that methodologies from one can help make significant advances in the other. Recent systems biology paradigms such as computational systems analysis, methods for quantifying time-dependent gene expression and bioinformatics cataloging of cellular parts can help enable synthetic biology. Greatest advances in biology and biotechnology are arising at the intersection of the top-down systems approach and the bottom-up synthetic approach. Building circuits and studying their behavior in cells is a major goal of synthetic biology in order to evolve a deeper understanding of biological design principles from the bottom up. Collectively, these developments enable the precise control of cellular state for systems studies and the discovery of novel parts, control strategies, and interactions for the design of robust synthetic function (Isaacs, Dwyer, and Collins 2006).

Synthetic biology aims to design novel biological circuits for desired applications implemented through the assembly of biological parts including natural components of cells and artificial molecules that emulate biological behavior. Because of its parts-to-whole approach, synthetic biology has a significant engineering component(Heinemann and Panke 2006). It may appear that it should be possible to apply strategies such as standardization which ensures that components of a system are compatible and exchangeable toward constructing a synthetic biological circuit in a manner similar to constructing an electric or electronic circuit (Andrianantoandro et al., 2006). The attainment of this ideal goal is, however, impeded by the overwhelming complexity of biological systems with their myriad biomolecules and interconnections as well as sparse databases of gene function(Haseltine and Arnold 2007). Consequently it is challenging to convert design concepts to predicted results for which mathematical modeling serves as a bridge.

Mathematical modeling plays an important and often indispensable role in synthetic biology because it serves as a crucial link between the concept and realization of a biological circuit. Types of modeling frameworks such as deterministic and stochastic, the importance of parameter estimation and optimization in modeling plays an important role. Additionally mathematical

techniques used to analyze a model such as sensitivity analysis and bifurcation analysis is also dealt with, which enable the identification of the conditions that cause a synthetic circuit to behave in a desired manner. In the project, mathematical modeling is incorporated as a central component of synthetic circuit design in *Leishmania*. Both deterministic approaches and stochastic approaches are used.

Stochastic models are used to deduce the effects of noise within a synthetic network, potentially leading to the manipulation of the network itself in order to improve the signal-to-noise ratio within these networks. A stochastic approach regards changes over time as random-walk processes, with no set of differential equations defined, and takes into account inherent fluctuations that are not considered in the deterministic kinetic approach. Stochastic effects may be particularly significant in some biological systems with small molecular populations involved. Although this stochastic basis is more accurate in modeling, it is more difficult to solve mathematically. However, numerical simulations are possible using Monte Carlo principles. Simulations using stochastic considerations have been reported for biological systems involving genetic and enzymatic reactions between molecular populations that was relatively small, including synthetic oscillatory networks, transcriptional regulation and circadian rhythms. For large populations of molecular species, the predictions obtained from stochastic approaches match with deterministic ones. However, at smaller population sizes, stochastic effects become more dominant, in which case, deterministic approaches become insufficient. Unfortunately, for many biological networks, stochastic simulations are still computationally expensive due to the huge differences in timescales of biological interactions and population sizes. Various improvements, approximations, and hybrid approaches have been presented. In one such study, stochastic simulations were done on multi-scaled systems to study reactions occurring in three different regimes (slow, medium and fast) as well as coupled reactions.

The presented approach in this project showed substantial improvement over using the basic stochastic simulation approach when applied to the study of expression and activity of IPCS in *L.major*. The constructed genetic circuit was modeled and simulated using diverse set of algorithms. This assumption was shown to greatly simplify the stochastic model and to significantly reduce the computational complexity. Despite providing a more complete representation of biological networks, stochastic approaches still face the challenge of dealing

with several orders of magnitude in terms of scale and properties including binding affinities, specificities, and kinetic rates. Therefore, even statistics based theories have limitations. Although they provide insights into macroscopic properties of a network, they may have inaccurate predictions about specific interactions. These limitations can be addressed with new developments in integrative modeling.

Once the circuit is constructed, validation is performed in two stages. Observation of the qualitative behavior of the circuit can be very informative in models having multiple steady states and showing switch-like or oscillatory behaviors'. The qualitative behavior can be studied either over small parts of the parameter space by simply scanning over defined ranges of parameters and initial conditions or by doing global bifurcation analyses. Qualitative analysis gives hints as to which parameters offer the best success in achieving a desired behavior or whether a certain design can exhibit the wanted function at all. Identifying the most promising parameters to change, of course, depends not only on the mathematical analysis but also on the biological feasibility. While some characteristics such as promoter strength, transcript and protein stability are quite variable, enzymatic activities, for example, might be harder to tweak. Also as changes in the characteristics of biological components can at best be qualitative, it is important to find parameter ranges that show behavior robust to variations. In the repressilator for example, the qualitative analysis may lead to the identification of a few key properties important for obtaining stable oscillations—strong promoters with tight cooperative repression. Apart from helping to choose the right biological components, these criteria may help researchers to introduce tags into the repressor sequences. Model validity can also be checked by comparison of the results of simulation runs with quantitative experimental data such as time courses or steady-state concentrations and fluxes. These can sometimes be derived from the literature or retrieved from databases.

Based on the current approaches dealt, herein, we describe how different approaches of bioinformatics could enable novel synthetic biology applications in *Leishmania*.

Aims and Objectives

- To characterize dynamical properties of small gene networks displaying oscillations or bistability.

- To construct artificial genetic systems displaying oscillations and bistability through repressilator and the Toggle switch models.
- To investigate the various properties of built in genetic switch including the robustness to noise, signal amplifications and tuneable frequency which ultimately deals the synchronization ability of the constructed genetic switch/circuit.

Systems and Synthetic Biology

Cellular complexity stems from the interactions among thousands of different molecular species. Thanks to the emerging fields of systems and synthetic biology (Hasty *et al.*, 2002; Hayete *et al.*, 2007; Kaern *et al.*, 2003; Sprinzak and Elowitz, 2005), scientists are beginning to unravel these regulatory, signaling, and metabolic interactions and to understand their coordinated action. A system is a network of mutually dependent and thus interconnected components comprising a unified whole. Every system exhibits emergent behavior, a unique property possessed only by the whole system and not shared to any great degree by the individual components on its own. Fields of systems and synthetic biology are important for accelerating both our understanding of biological systems and our ability to quantitatively engineer cells. Synthetic biology is the engineering of biology: the synthesis of complex, biologically based (or inspired) systems which display functions that do not exist in nature. At the nexus of these two fields is a unique synergy that can help attain these goals. Thus, the next greatest advances in biology and biotechnology are arising at the intersection of the top-down systems approach and the bottom-up synthetic approaches. Collectively, these developments enable the precise control of cellular state for systems studies and the discovery of novel parts, control strategies, and interactions for the design of robust synthetic function. Combining these efforts can provide novel insights into cellular function and lead to robust, novel synthetic design (Lanza M *et al.*, 2012). Likewise, we can design orthogonal synthetic systems that have predictable behavior in a complex and noisy environment. However, our methods are inverted: the most sophisticated methods for understanding cellular complexity at the gene level utilize top-down systems approaches whereas the most promising avenue for creating novel macroscopic function relies on bottom-up synthetic design principles. These disciplines aims to develop Predictive, Preventive, Personalized, Participative (P4) medicine that has potential to transform medicine by decreasing morbidity and mortality.

Top-down systems biology

The advent of high-throughput biology has led to a rapid acceleration in obtaining systems-level information about living organisms including genomes, transcriptomes, proteomes,

metabolomes, epigenetic states, and transcription factor binding profiles. This global information, integrated with computational approaches for analysis and model-based prediction, has led to an enormous understanding of bio molecular networks in a field termed ‘systems biology’. Combining these global measurements lead to robust, high resolution information about the cellular responses and metabolism.

Bottom-up synthetic biology

Synthetic biology attempts the reverse bottom up approach in which the discrete bimolecular processes are organized into larger construct to generate complex behavior at cellular level. This engineering perspective may be applied at all levels of the hierarchy of biological structures – from individual molecules to whole cells, tissues and organisms. In essence, synthetic biology will enable the design of 'biological systems' in a rational and systematic way (Lunes, 2007). These constructs can be simple, such a promoter driving the expression of a single gene, or much more complex modules such as different promoters combination producing different behavior.

Systems biology aims to model and understand an entire organism by characterizing dynamic environment-dependent functional interrelationships between its constituent parts (for example, genes, RNAs, proteins and metabolites). Synthetic biology, however, uses well characterized

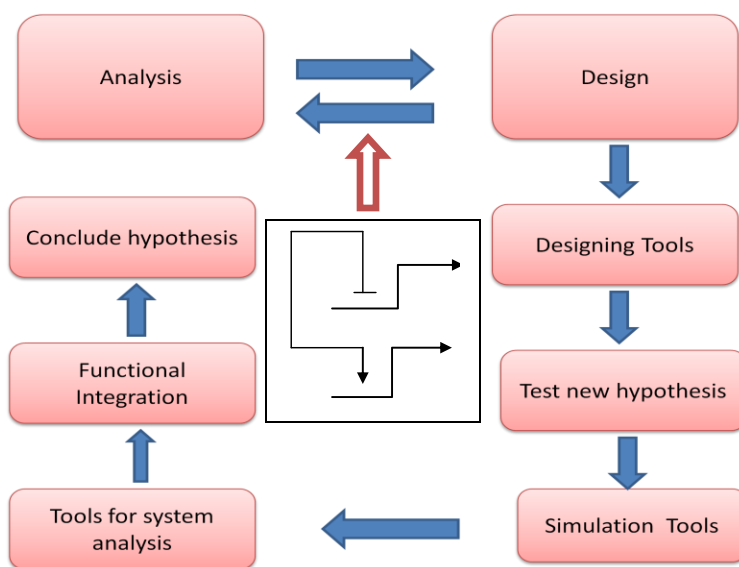

parts that are shaped by natural evolution to construct artificial systems that perform new tasks. These fields are on trajectories that are bound to cross paths and even merge as they begin to inform one another. We envision that systems biology will provide both the parts and wiring diagrams for entire cells to guide complex circuit design for synthetic biology approaches.

Fig (5.1) Synergy between System and synthetic biology

Bioinformatics for Synthetic and Systems biology

In the era of post-genomic research two new disciplines, Systems and Synthetic biology, act in a complementary way to shed light on the ever-increasing amount of data produced by tools and databases of bioinformatics. Bioinformatics cataloging of cellular parts can help in construction of synthetic modules. The ease of collecting genome-scale measurements available at Bioinformatics database and data repository has created a deluge of information that must be parsed in order to provide systems insight as well as utility for synthetic biology applications. Optimal design certainly requires these bioinformatics approaches to parse the rapid growth in available genome sequences. These fast, accurate, and efficient methods for predicting desired behavior from easily collected expression or genomic data is a major systems biology advancement that has direct implications for synthetic biology applications. In this regard, these approaches have been used to enable automated synthetic circuit design. It is clear that there is a great synergy between global cellular modeling efforts and synthetic circuit design. A final area of synergy between systems and synthetic biology lies in the efforts to expand and automate the process of parts identification. The rapid capacity to sequence new genomes has sparked interest in equally rapid annotation capacities. As a result, databases of prokaryotic (S. Gama-Castro *et al*, 2008) and eukaryotic (R. Gupta., 2011) motifs have been curated, enabling automatic annotation of promoters (Y.Y. Yamamoto, 2008.,R. Gupta., 2011) transcription factor binding sites (J. Zhu, M.Q. Zhang, 1999) and terminators for these organisms. In addition to providing a repository of natural biological parts for synthetic biology applications, these tools allow synthetic biologists to design novel regulatory elements by combining motifs in interesting ways (A. Mitra, A.K. Kesarwani, 2011) In turn, the increased understanding afforded by manipulating regulatory motifs in this fashion can serve to illuminate the complex systems biology underlying regulatory element performance. There are many software packages of bioinformatics for the analysis of the models generated by approaches of systems and synthetic biology. Bioconductor package uses the R statistical programming language, and is open source and open development, provides tools for the analysis and comprehension of high-throughput genomic data. It includes sequence analysis package, network analyses package using different reverse engineering methods like Bayesian and Boolean methods.

Synthetic Circuit

An important aim of synthetic biology is to uncover the design principles of natural biological systems through the rational design of gene and protein circuits (M Shankar *et al.*, 2009). The synthetic gene circuits discipline can be described succinctly as novel regulation of pre-existing or engineered cellular functions. Synthetic circuits generally consist of components optimized to function in their natural context, not in the context of the synthetic circuit. The emergence of synthetic gene circuits as an engineering goal has re-emphasized the importance of considering the continuous nature of gene regulation. “**Synthetic circuit**” describes a system that is designed to execute a useful function (a bistable state, oscillation, pulse etc) in a predictable and reliable manner. This highlights the process of engineering biological systems from genetic circuits to the control of cell–cell interactions, has contributed to our understanding of how endogenous systems are put together and function. Synthetic biological devices allow us to grasp intuitively the ranges of behavior generated by simple biological circuits, such as linear cascades and interlocking feedback loops, as well as to exert control over natural processes, such as gene expression and population dynamics (M Shankar *et al.*, 2009)

Design principles

Design principles helps in deciphering the quantitative laws that governs the behavior of biological systems. These principles will be able to design biological systems having desired properties by reconstructing and thus facilitates the better understanding of naturally occurring functions. Different laws are used for specific reactions e.g. **Hill-Hinze** equation is applied for the reactions for the formation of gene products.

Modules of Gene Components

- Its behavior must be predictable when it is integrated in the system.
- It must function more or less independently of the host organism.
- It must utilize few resources from host cell as much as possible to minimize the perturbations in the host.
- It should be portable and should function predictable in variety of host systems.

Hill-Hinze equation

Hill equation as kinetic law for gene product is:

$$V_{re2} = V_{max_re2} \cdot \frac{[R1]^{n/c_re2_B2}}{[R1]^{hic_re2_B2} + ksp_re2_s2^{hic_re2_s2}}$$

Since we had taken the transition from gene to protein as a “known transition omitted”, and ignored the RNA, the Hill equation is modified as per the reaction’s convenience and the equation was given as:

$$V_{max_re}$$

Where, V_{max} is maximum velocity attained.

According to Quasi steady state rule, $d/dt[mRNA] = 0$, i.e. for the intermediate compound. Moreover the concentration of the mRNA reaches steady state very quickly compared to protein concentration, thus we considered that [mRNA] concentration is always considered at steady state.

Construction of genetic circuit

The first step in assembling a biological circuit is to gather the component parts. Equations and computer simulations that model relationships between biological processes (e.g., gene activation, protein production, cell division, etc.) guide the design of synthetic systems by determining the vital parameters and parameter spaces in which the system will function as intended.

Steps for construction of genetic circuit are as follows:

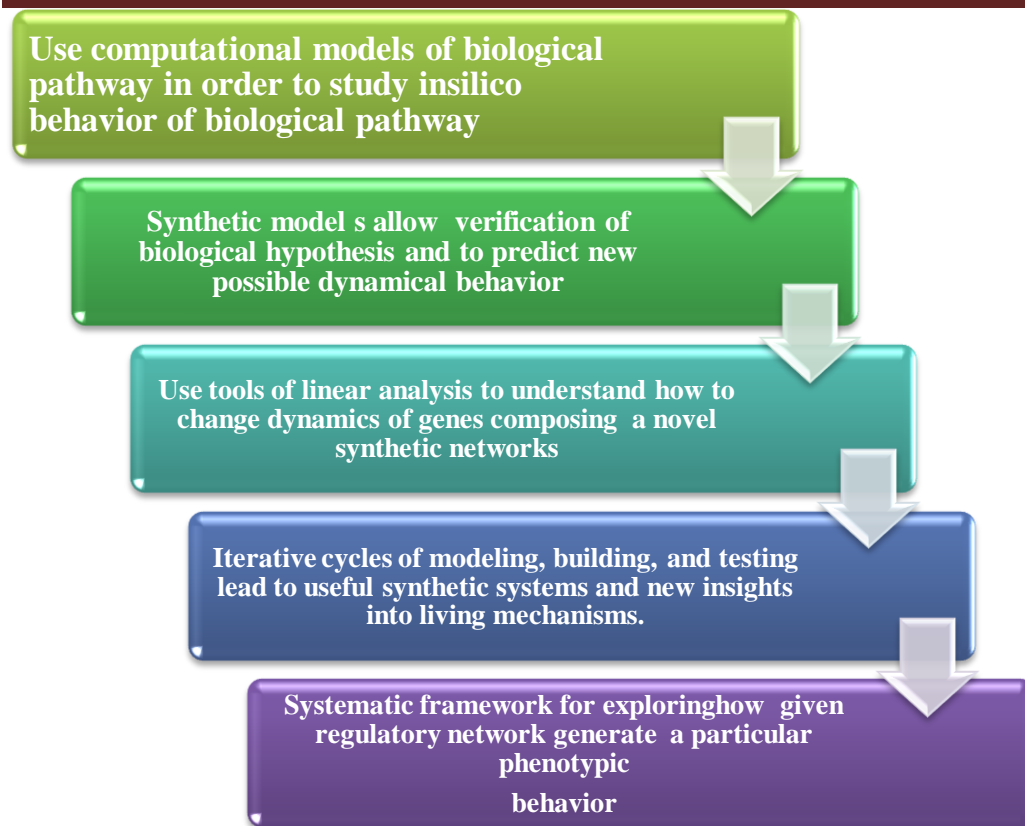

Fig 5.2 Steps for construction of genetic circuit

Synthetic biology approaches to the design of circuits

Parts

Parts are the individual components that make up gene expression machinery which are specific DNA sequences that code for gene promoters and upstream regulatory sites, ribosome binding sites, gene or protein coding regions, and mRNA translation termination sites. Sequences for RNA-only machinery, such as small interfering RNA and ribozyme coding sequences, are also used.

Devices

Assemblage of parts (promoters and genes) that carry out specific functions. There are several basic devices, including reporters, inverters and devices that carry out signaling and protein generation. Each device includes one or two promoter–ribosome binding site–gene terminator

constructs. Subsequently, these basic devices can be combined into 'composite devices' to achieve more complex behavior.

Systems

Systems are collections of specific devices that enable individual parts to be quantified. Generally, a subset of the composite devices is used to characterize the strength and efficiency of promoters under non-repressive conditions.

Chassis

The host cell in which the systems and devices described above are assembled and used. To date, these cells have been primarily from *Escherichia coli* strains, although a few devices and systems have been tested in yeast and mammalian cells. A more exotic chassis includes cell-free systems that use DNA transcription and mRNA translation chemistry derived from whole-cell extracts and encapsulated in artificial membranes.

Logic Circuits or Regulatory Modules

Electrical circuits are based upon mathematical models and so are genetic circuits, and many of the techniques in predicting outcomes of genetic circuits are directly derived from electric circuits. Electric circuits often contain modular parts such as switches and oscillators, which have strong resemblance to the two genetic circuits, a genetic toggle switch and the repressilator respectively. Logic gates are the basic building blocks in electronic circuits that perform logical operations (G Agarwal., 2007). These have input and output signals in the form of 0's and 1's; '0' signifies the absence of signal while '1' signifies its presence (Fig-2.12). Similar to the electronic logic gates, cellular components can serve as logic gates. A typical biological circuit consists of i) a coding region, ii) its promoter, iii) RNA polymerase and the iv) regulatory proteins with their v) DNA binding elements, and vi) small signaling molecules that interact with the regulatory proteins. Messenger RNA or their translation products can serve as input and output signals to the logic gates formed by genes with which these gene products interact. The concentration of the gene product determines the strength of the signal. High concentration indicates the presence of signal (=1) whereas low concentration indicates its absence (=0).

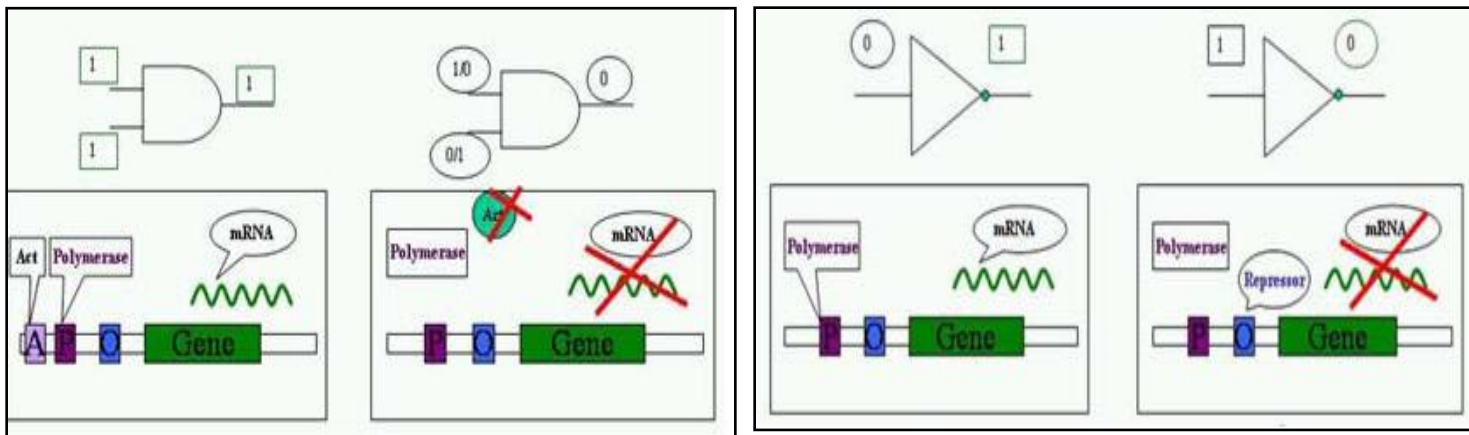

a.) NOT gate

b.) AND gate

Fig (5.3) Logic gates of Biochemical processes

Logic circuit	No of Input	No of Output	Logic	Application
NOT	1	0	Inverts the input signal	Determine intracellular state of the cell
NAND	2	1	If both input signal is present only then gives no output	Presence or absence of polymerase and repressor present gene is not transcribed
AND	2	1	If both input signal is present only then gives output	The activator and inducer together result in turning on a gene .It is used in cell to cell communication
Implies	2	1	If both input signal are present output signal is present, If one input signal present it behaves like NOT gate	When repressor and inducer are require for gene expression

Table 5.1 Logic gates in biological systems

Synthetic circuit in protozoan parasite

There are reports and evidences for the synthetic circuit in prokaryotes and eukaryotes like *E.coli* and yeast systems but to the best of my knowledge there are no reports in the literature suggesting the synthetic circuit construction for protozoan parasites. The project serves to the first attempt made to use synthetic biology approach for the construction of genetic circuit for the protozoan parasite *Leishmania*.

Leishmaniasis

Among all the emergent diseases, the ones caused by protozoan have great importance. Leishmaniasis is a disease caused by a parasite member of the *Leishmania* genus and presents high morbidity and mortality levels. The annual incidence of approximately two million new cases and around 350 million people that are living in endemic areas reveals the importance of this neglected disease (Campos *et al.*, 2004). Leishmaniasis, widespread parasitic disease caused by a heterogeneous group of protozoan parasite belonging to the genus *Leishmania*, spread by the bite of female sand fly of the genera: *Phlebotomus* (Old world) and *Lutzomyia* (New world). 20 species of *Leishmania* was found to be pathogenic for humans [WHO].

LEISHMANIA

This parasite was first time reported by W.B. Leishman and C. Donovan in 1903. Species of *Leishmania* are in **Old World** they are *L. tropica*, *L. aethiopica*, *L. major*, *L. infantum* and *L. donovani* and in new world **New World** are *L. mexicana*, *L. amazonensis*, *L. venezuelensis*, *L. pifanoi*.

MORPHOLOGY

Leishmania is a dimorphic protozoan parasite that resides as an extracellular flagellate-**Promastigotes** in the sand fly vector and as an obligate intracellular aflagellate-amastigotes within macrophages of vertebrate hosts (Liew and O'Donnell, 1993). The various species of *Leishmania* are not distinguishable from one another.

Amastigotes appear as round or oval bodies ranging from 2 - 3 μ m in diameter with a well-defined nucleus and kinetoplast, a rod shaped specialized mitochondrial structure that contains extra nuclear DNA. **Promastigote** form is spindle shaped, longer than amastigotes, measuring 10

- 20 μm in length with a central nucleus and anterior kinetoplast and a well-developed flagellum, which is used either for propulsion or for attachment. (<http://www.cvbd.org/en/sand-fly-borne-diseases/leishmaniosis/pathogens>)

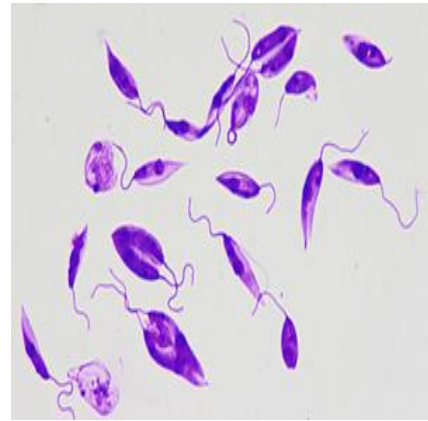
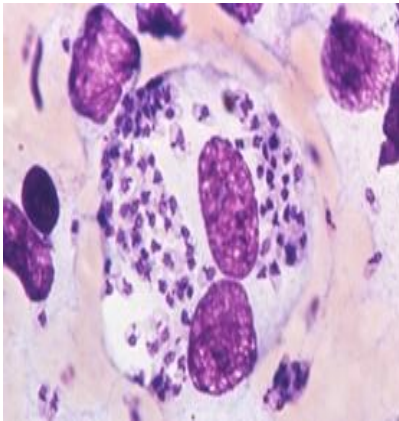

Fig 5.4: A) Amastigotes

B) Promastigotes

Picture Credit: Science photo library (Leishmaniasis)

Genome

Mapping and sequencing of the *L. major* genome allowed the definition of 36 discrete chromosomes composing the genome of this protozoan parasite. Different *Leishmania* species have 34 to 36 chromosomes, varying in size from 268 to 2,680 kb. The arrangement of genes in trypanosomes and *Leishmania* (and in other related parasites from the same order, Kinetoplastida) is reminiscent of that in bacterial operons, especially as protein coding regions are almost never interrupted by introns; the single exception so far is the gene encoding poly(A) polymerase (Mair *et al.*, 2000). So far nothing is known about the sequences involved in transcription initiation of protein-coding genes in the parasite *Leishmania*. Most genes in these organisms are transcribed polycistronically, and the mature mRNAs are generated from primary transcripts by *trans*-splicing (M Santiago *et al.*, 2003). Promoters for *rRNA*, *VSG*, and *PARP* genes, which are transcribed by RNA polymerase I (Pol I), have been characterized in trypanosomatids (Zomerdijk *et al.* 1991) and (Chung *et al.* 1993), as has the *SL* gene promoter, which is transcribed by Pol II. The nature of the polymerase II complex is still one of the major mysteries of kinetoplast molecular biology.

Leishmania Life cycle:

Leishmania procyclic promastigote differentiate in sandflies into infective, non-dividing metacyclic Promastigotes, which are located ready for transmission at the stomodeal valve (an invagination of the foregut into the midgut). During blood feeding, the sand fly regurgitates metacyclic promastigote, together with immunomodulatory parasite-derived proteophosphoglycans and various salivary components. The metacyclic promastigote are then phagocytized by one of several possible cell types that are found in the local environment. After establishing an intracellular residence, metacyclic promastigote transform into aflagellate amastigotes. Amastigotes undergo replication within host cells, which rupture when too many amastigotes are present, allowing reinfection of local phagocytes. The transmission cycle is

complete when infected phagocytes are taken up by another sand fly with the blood meal, and amastigotes then convert into Promastigotes in the sand fly midgut.

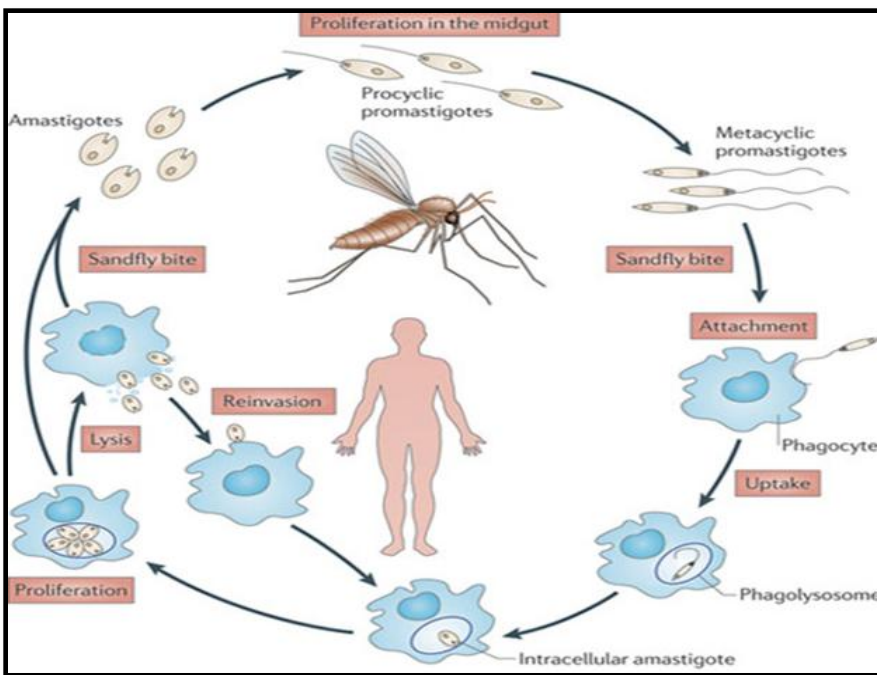

Fig (5.5) Life cycle of Leishmania

Picture credit: Kaye P, Scott P (2011). Leishmaniasis: complexity at the host–pathogen interface

TYPES OF LEISHMANIASIS

There are 3 forms of Leishmaniasis:

Types	Cutaneous	Mucocutaneous	Visceral
Pathogen	<i>L.major</i> <i>L.tropicana</i> and <i>L.aethiopica</i>	<i>L.braziliensis</i>	<i>L.donovani</i> , <i>L.infantum</i>
Location	India, Afghanistan, Brazil, Iran, Peru, Saudi Arabia and Syria	Bolivia, Brazil, Peru	Bangladesh, Brazil, India, Nepal and Sudan Semi deserts in Middle East, North India, Pakistan, North, Africa Central Asia
Symptom	<ul style="list-style-type: none"> ➤ Skin sores, which may become a skin ulcer wearing away (erosion) in the mouth, tongue, gums, lips, nose, and inner nose that heals very slowly ➤ The skin lesions take on a variety of plaques 	<ul style="list-style-type: none"> ➤ Perforation of the nasal septum, and enlargement of the nose or lips ➤ They erode underlying tissue and cartilage separating two nostrils. ➤ Prevent speech. ➤ If the larynx is involved, the voice changes as well. Ulcerated lesions may lead to scarring and tissue destruction that can be disfiguring 	<ul style="list-style-type: none"> ➤ Weight loss, which may be severe. ➤ Low blood counts (pancytopenia). ➤ Enlargement of the liver and spleen (hepatosplenomegaly). ➤ Fever, which is usually intermittent. ➤ High levels of immune globulin in the blood (hypergammaglobulinemia). ➤ The skin may turn dark, causing VL to be called "kala-zar," which means "black sickness." Some people who recover will have a persistent rash or pigment changes in the skin. The kidney is also affected, which may lead to renal failure. Other organs, including the bowel and the lung, may be affected.

Table 5.2 Type of leishmaniasis



Fig (5.6) Severity of lesions

Picture credit CGM Research Project Telemedicine

Picture credit: Human Leishmaniasis

Fig (5.6) Visceral Leishmaniasis

Picture credit Jorge et al, WHO (2012)

Lipid Metabolism

In *Leishmania*, lipid play important role in formation of micro domains which are major virulence factors for the parasite. Lipid metabolism includes sphingolipid metabolism, Lipopolysaccharide metabolism, Glycan metabolism etc. The plasma membranes of the divergent eukaryotic parasites, *Leishmania* and *Trypanosoma*, are highly specialized, with a thick coat of glycoconjugates and glycoproteins playing a central role in virulence. Unusually, the majority of these surface macro-molecules are attached to the plasma membrane via a glycosylphosphatidylinositol (GPI) anchor. In mammalian cells and yeast, many GPI-anchored molecules associate with sphingolipid and cholesterol-rich detergent-resistant membranes, known as lipid rafts (Figure 2.6). Lipid micro domains, including rafts and caveolae, have an important role in the organization of membrane proteins, in cell–cell contact and in numerous signaling processes. Lipid rafts in *Leishmania major* as being enriched in sphingolipid (inositol phosphosphingolipid) and sterol is very essential for the survival of the parasite.

Schematic representation of membrane rafts components in *L.major* .It shows association between sphingolipid and sterols in the outer and inner leaflets of the membrane bilayer results

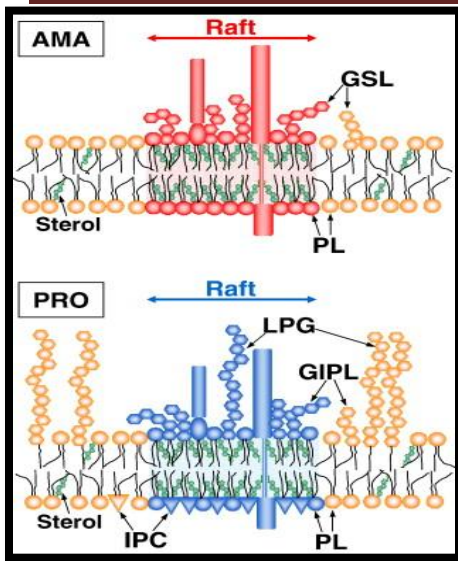

in the formation of a liquid-ordered raft phase (red and blue regions) that is structurally distinct from the surrounding liquid-disordered phase (orange region). Lipid rafts from amastigotes are mainly constituted by GSLs and sterols. In procyclic promastigote forms, IPC and sterols are the major lipid components of the rafts.

Fig (5.7) Lipid rafts *Picture credit:* Erika Suzuki, Ameria K. *et al.*, 2008)

Sphingolipid Metabolism

Sphingolipids (SLs) are ubiquitous membrane components in pathogenic protozoan. The surface of most protozoan parasites relies heavily upon lipid-anchored molecules, to form protective barriers and play critical functions required for infectivity. Sphingolipids (SLs) play important roles through their abundance and involvement in membrane micro domain formation, as well as serving as the lipid anchor for many of these molecules. Interactions of parasite sphingolipid metabolism with that of the host may potentially contribute to parasite survival and/or host defense (W Paul Denny., 2001). The basic structure of a sphingolipid consists of a long-chain sphingoid base backbone (distinguishing it from glycerolipids which have a glycerol backbone) linked to a fatty acid via an amide bond with the 2-amino group and to a polar head group at the C-1 position via an ester bond. Trypanosomatids such as *Trypanosoma* and *Leishmania spp.* synthesize large amounts of unglycosylated inositol phosphorylceramide (IPC), a lipid found widely among fungi and plants but absent in mammals (Figure 2.7 *Image Credit:* Lena J. Heung (2006). After the synthesis of dihydroceramide, the pathway can be generally divided into mammalian- and fungal/plant-specific branches. Synthesis of IPC occurs by the transfer of inositol phosphate from PI to the C-1 hydroxyl group of ceramide or phytoceramide. This reaction is catalyzed by IPC synthase, which is localized to the **Golgi of yeasts.**



IPC is present together with other SLs and sterols in organized lipid rafts but it is never found attached to any GPI-anchored protein or GIPL. As IPCs is parasite specific and has no functional equivalent in mammals, it can serve as putative drug target for leishmaniasis

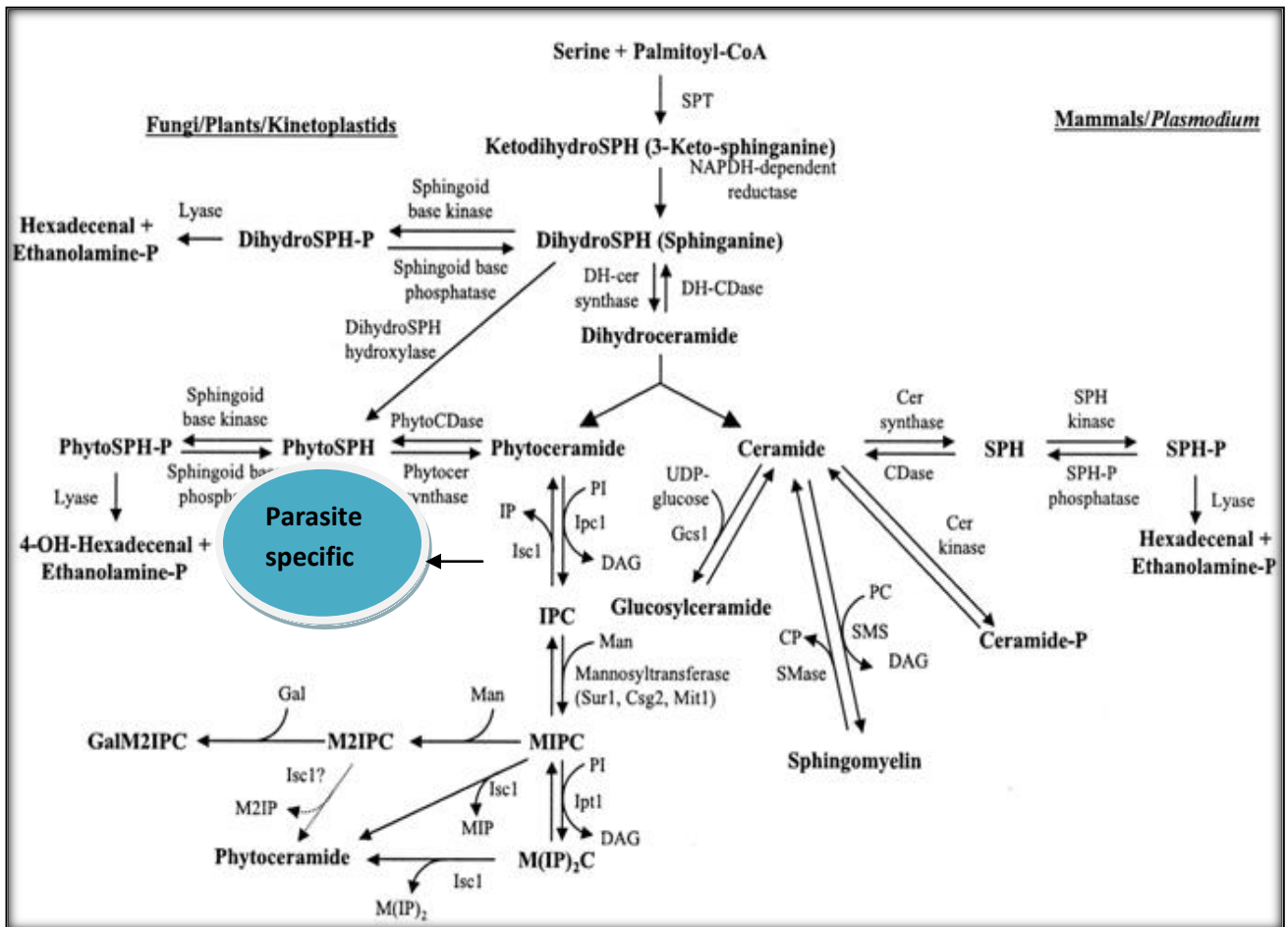

Fig 5.8 Sphingolipid metabolism

Existing Drugs:

Medicines called antimony-containing compounds are the main drugs used to treat leishmaniasis. There are several drugs available for the treatment of leishmaniasis, but many of the newer

medications are not yet available in all endemic areas. Drug resistance is a concern in regions using monotherapies for treatment (Lucio H., *et al*, 2012)

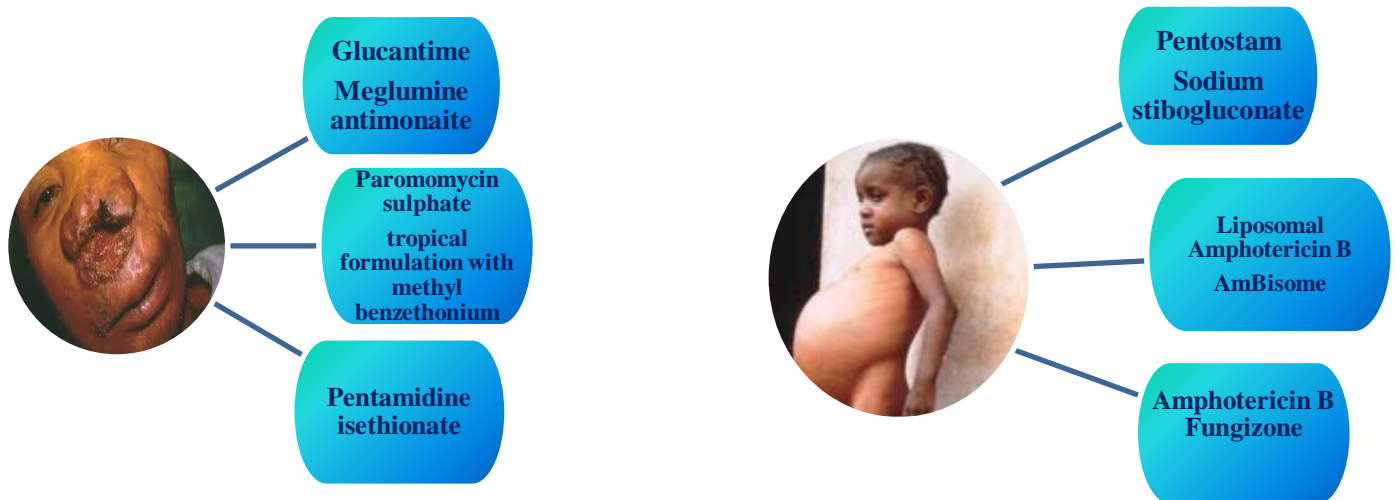

Fig (5.9) Drugs for Cutaneous and visceral leishmaniasis

Limitations of available Drugs:

- Due to side effects such as high cardiotoxicity pancreatitis and nephrotoxicity patients should be hospitalized and monitored, as treatment may need to be suspended.
- Lack of efficacy
- Requirement for hospitalization and/or cost.
- Due to drug resistance
- Improper and inaccurate dosage of the drugs
- Several changes in the physiological parameters in the parasites.

Nevertheless, the lack of adequacy for administration in the field, toxicity and resistance issues of the current therapies highlights the need of new drugs for Leishmaniasis. To overcome the limitations of conventional drug discovery and delivery systems, new approaches must be followed using fascinating science like system and synthetic biology.

Genetic toggle switch

Switch is important part of DNA that makes how and when to use the gene. E.g. Fruit fly sparks in the wings can be switched **in and** off. Switching of gene is controlled by gene regulatory

network proteins. Genetic toggle switch—a **synthetic, bistable gene-regulatory network** (S. Gardner *et al.*, 2000) is composed of two repressors and two constitutive repressible promoters (figure 2.8). Each promoter is inhibited by the repressor that is transcribed by the opposing promoter. When each gene encodes a transcriptional repressor of the other and each repressor is blocked by a chemical input, the system can be switched between two stable states (i.e., “gene 1 on, gene 2 off” vs. “gene 1 off, gene 2 on”).

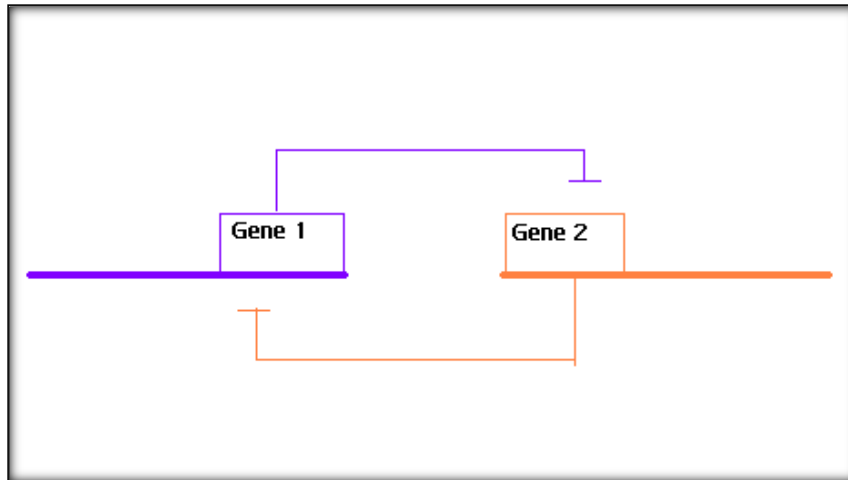

Fig (5.10): Schematic representation of Genetic toggle switch

Bistability

Bistability is a dynamic feature of a particular gene to preferentially toggle between two steady-states. Bistability arises within range of biological systems from lambda phage bacterial switch to signal transduction pathways. The state of gene switches plays pivotal roles in cell fate decision. The expression level of a gene switch does not change gradually but rather has two distinct steady-states: HIGH or LOW, ON or OFF, ALL or NONE. The ability of switches to convert a graded signal into a binary response ensures that a cell responds in a decisive manner or unambiguously commit to a specific program. There are generally two means of achieving bistability in a network: a positive feedback loop or mutual repression (i.e., double negative feedback). Bistable behavior of gene switches have been reported to play pivotal roles in many important aspects of cell physiology, including cell fate decisions cell cycle control cellular

responses to environmental stimulation. Changes in regulatory mechanism may result in genetic switching in the bistable system.

Steady states

Attractors or steady states are cycles of states and are assumed to be associated with the stable states of cell function (F. Li, T. Long *et al*, 2003). The states in which the network resides most of the time, attractors in models of gene-regulatory networks are expected to be linked to phenotypes (S. A. Kauman *et al.*, 1993). Hence attractors represent long term behavior of genes or protein in regulatory network.

Bifurcations

The number and stability of the steady states may change as the value of some control parameter changes value. The critical value at which the qualitative change of the steady states occurs is called a *bifurcation point*. The saddle-node bifurcations are the bifurcations where by changing the control parameter two steady states, one stable and one unstable, will coalesce and disappear. Different bifurcation methods give different steady states but saddle point is most appropriate for the bistable genetic switches as it gives two states.

Repressilator

Three transcriptional repressor systems can be used to build an oscillating network. The repressilator consists of three genes connected in a feedback loop, such that each gene represses the next gene in the loop and is repressed by the previous gene (Fig 5.11). In addition, green fluorescent protein is used as a reporter so that the behavior of the network can be observed using fluorescence microscopy (M Elowitz *et al.*, 2009).

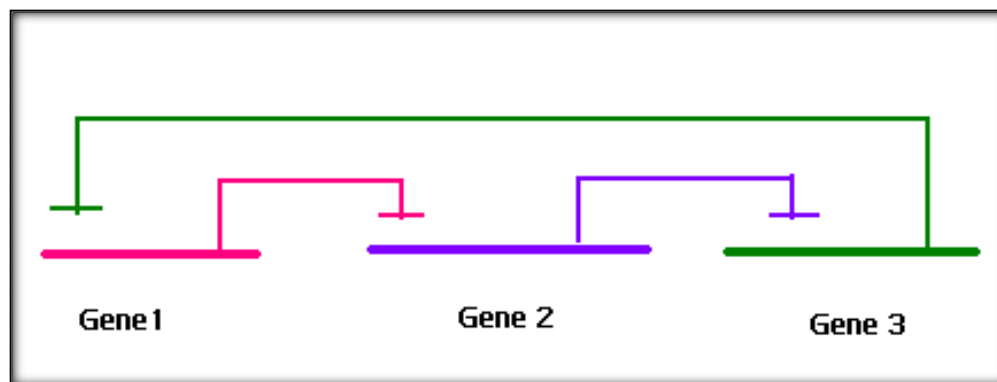

Fig (5.11) Gene 1 represses Gene2, Gene 2 represses Gene 3 and Gene 3 represses Gene 1 in cyclic manner

Toggle switch coupled with Repressilator

Coupling is obtained by common variable between two circuits. There are two types of coupling where in former type the expression of one gene of toggle switch is under control of one protein of the repressilator. In later type expression of one gene of repressilator is controlled by toggle switch, these are present at multi stages of Gene regulatory network supposedly at hierarchial one. Former type is present at Bistable stages of Gene Regulatory Network (GRN). In nutshell model should be able to connect toggle switch and oscillator in such way that transition from one steady state to another steady state of toggle switch via the coupling induce oscillation in repressilator. The design of the repressilator was guided by two simple mathematical models, one continuous and deterministic and the other discrete and stochastic.

Stochastic Simulation

Modeling approach for genetic circuit includes common approaches like Logical, continuous and stochastic modeling (G Karlebach., 2008) .Stochastic models are also called single-molecule level models as they take the fluctuating concentrations of single molecules into account when describing a circuit. The stochastic models are built up much like the ODEs but instead of a reaction rate they make use of a reaction probability. The system can then be run with a stochastic simulator, like Dizzy (S Ramsey., 2005), using algorithms made for stochastic simulation of coupled chemical reactions like the Gillespie Direct (Gillespie D., 1997) or Gibson-Bruck algorithms (M Gibson *et al.*, 2000).Deterministic approach can used for analyzing bistability in terms of kinetic parameters but it can describe only average behavior of system based on large fluctuations of system behavior in different cells. Moreover it cannot realize experimental results with different genetic switching in different cells under same condition. For the biological systems when detailed information of biochemical reaction is not available, stochastic approach is boon for the system to study which is in our case. The circuits may be highly affected by stochastic mechanisms and the determinism produced by the continuous models may not be sufficiently descriptive. Stochastic analysis gives narrower bistable area than deterministic approach. Stochastic fluctuations push the system towards the other stable steady state (S Hagen Johansen 2011).

There are three types of stochastic simulations:

- ❖ Stochastic exact (Master Equation) where reactions are represented by variables like protein concentration or gene product.
- ❖ Stochastic (tau-leap): Solves master equation based on controllable dimensionless error parameters. (Poisson distribution per unit time)
- ❖ Hybrid: Combines stochastic simulation algorithm of Gibson –Bruck with different algorithm for numerical integration of ODEs

From the above mentioned methods tau-leap type of stochastic simulation is most applicable for genetic circuit because it links to biochemical reaction system to Euler method which is useful to describe the reconstruct DNA sequence from its fragments .It gives more quantitative description of stochastic dynamics of biological system.

Stochasticity in genetic switches

Gene expression is exposed to stochasticity caused by fluctuations in transcription and translation, despite constant environmental conditions giving rise to diversity and differentiation of cell types (M Kærn *et al.*, 2005). Stochasticity in gene expression of genetic circuits can potentially predict transition among two states of genetic circuits. Gene expression is vulnerable to fluctuations that are caused by noise in the system. The total noise in a cellular environment can be divided in the noise arising from the gene expression itself, intrinsic noise, and that of the fluctuations in all the other components of a cell, extrinsic noise, like transcription factors and RNA polymerase abundance. In stochastic model intrinsic noise can switch the system from intermediate to steady state. Extrinsic noise can affect key regulatory processes. Also one can investigate switching behavior by the measurement of noise. The cellular processes have to be robust in order to cope up with the noise .Moreover this approach gives an appropriate technique for introducing noise into models to study robustness of genetic circuits.

Robustness of synthetic circuit

Robustness is a property that allows a system to maintain its functions despite external and internal perturbations. Robustness is a feature often observed when studying biological systems.

Observable phenomena that characterize such robustness are adaptability, insensitivity to parameter changes and resistance to structural damages. Adaptive biological systems have the ability to change mode in a changing environment but still maintain the same phenotype. When designing and studying biological systems these properties will be able to ensure or explain the robustness of the system (H Kitano., 2004). In genetic regulatory network robustness of steady state can be defined as probability of a steady state reverting back to itself when the expression of one or more nodes is perturbed from its original expression value. It is imperative that robustness of cellular steady state is reflected by robustness of attractors under stochastic simulation of gene regulatory network. Hence biologically motivated stochastic models for quantifying the robustness properties of genetic circuits is essential to compare multiple network configuration for same biological synthetic model.

Statistical Inference of genetic Circuit

Mathematical and computational modeling of genetic regulatory networks promises to uncover the fundamental principles governing biological systems in an integrative and holistic manner. It also paves the way toward the development of systematic approaches for effective therapeutic intervention in disease. The difference between inference and design of synthetic circuits is that in design we try to reconstruct the system from data that we observe; we seek to construct the system that produces the data we would like to observe i.e. desired behavior. Hence after construction of circuit and its simulation, it is mandatory to check for the circuit performance. If it performs well, it is applicable but if not then check for sensitivity and robustness analysis. When desired robust solution is obtained after perturbations and optimization, we can implement the design in wetlab. Need for the inference of gene regulatory network due to protein expression when needed in spite of infrequent and stochastic gene expression may be due to following reasons:

- It may be due to population transcriptional co operation; means every protein population does not mean to form gene product.
- Check points to assure that cascaded events are adequately synchronized.

- Widespread redundancy in the genes and in regulatory pathways even in normal condition (normal fluctuations) in protein production can be large which is related to regulatory threshold which controls the expression of downstream genes.
- Consequences in wide variation from cell to cell in switching time for controlling protein to activate gene it controls.
- Without a coordinative mechanism, time variation will cause errors synchronization of cellular functions.
- The mechanism to provide coordination can be provided by regulatory check points with conditions provided.
- Regulatory circuits design and molecular details that determine the kinetic parameters must be under selection pressure.
- Redundancy in the circuit efforts the resilience in gene circuit performs with respect to gene mutation and regulation failure caused by erratic protein production.
- Mutation in one or more of gene in regulatory network can increase probability of failure of networks that accounts for robustness of circuit.

. There are various approaches for the inference of gene regulatory networks. Bayesian method, Boolean method and ODE (ordinary differential Equation) method. To perform the network inference, network can be created by using Natural language rules or one can import the constructed model in SBML (Systems Biology Markup Language). Network inference can be made by time series data generated after the simulation of circuit. For Qualitative inference Boolean method is used and Quantitative inference Bayesian method is used.

Quantative and Qualitative synthetic network

Successful completion of the various genome projects has led to the realization that effective models for predicting cellular behavior must take into account the network interactions that dynamically mediate gene regulation. Since behavior arising from these complex interactions is difficult to predict without quantitative models and qualitative models, there is a need for

experimentally validated computational modeling approaches that can be used to understand the complexities of gene regulation

Bayesian method

In the formalism of Bayesian Networks, the structure of a genetic circuit system is modeled by a directed acyclic graph $G = (V, E)$. The vertices $I \in V, I = (1, \dots, n)$, represent genes regulation levels and correspond to random variables X_i . In network node are genes and edges are condition dependency regulators in circuit. In Bayesian method relationship between genes in biological system can be studied. Probabilistic framework captures the stochastic nature of biological system. It provides insight into uncertainty in circuit. Posterior probability distribution is quantity derived from Monte Carlo simulation in Bayesian method. Posterior probability distribution over possible design parameter values that can be analyzed for parameter sensitivity and robustness provide credible limits as design parameters. It encodes ability of each design to achieve desired behavior. This method includes network probability matrix, network uncertainty and no of regulators in the circuit. Synthetic gene regulatory network is constructed in *Arabidopsis Thaliana* (Locke, J.C *et al.*,2006) Bayesian network method was used to construct transcription regulatory network by selecting five regulatory genes and their time series data from ODE model. Significant regulators in the network were identified. Regulatory genes identified from Bayesian network on basis of conditional probability distribution were experimentally validated against stress and external perturbation of environment. Network analyses were performed by GRENITS package of R.

GRENITS

GRENITS is Gene Regulatory Network Inference using Time series .The package offers four network inference statistical models using Dynamic Bayesian Networks and Gibbs Variable Selection: a linear interaction model, two linear interaction models.

Boolean method

A Boolean network $G(V, F)$ is defined by a set of nodes (genes) and a list of Boolean functions where $V = \{x_1, \dots, x_n\}$ are set of genes and $F = (f_1, \dots, f_n)$. Each represents the state (expression) of gene, where represents the fact that gene is expressed (active) and means it is not expressed (inactive).The list of Boolean functions represents the rules of regulatory interactions between

genes (S Ilya *et al.*, 2002). This method includes conversion of the model of circuit to Boolean network (BN), network analyses and perturbation experiments by generating random networks. It includes Synchronous network where the assumption is that all genes are updated at same time and asynchronous network where genes are updated at different point of time. Methods to analyze the Boolean network includes find the attractors and the transition between the attractor. Also check the robustness of gene regulatory network to noise and mismeasurements. Several genetic networks have been successfully modeled and analyzed using BNs, such as the mammalian cell cycle (Faure *et al.*, 2006), or the yeast cell cycle (Li *et al.*, 2004).

BoolNet

Existing software tools in this field often specialize on certain aspects of BN research, or do not support all three types of networks (e.g. Albert *et al.*, 2008; Klamt *et al.*, 2007; Wuensche, 2009). The R package *BoolNet* provides methods for all major uses of synchronous, asynchronous and probabilistic BNs and includes novel functions for attractor search, robustness analysis and binarisation. Boolean network for the yeast cell cycle and mammalian system was done using BoolNet.

International and national status

The first synthetic gene circuits were engineered in bacteria, and more recently have been established in yeast and mammalian systems (Travis S Bayer., 2005; Hasty *et al.* 2002; Kaern *et al.* 2003; Sprinzak and Elowitz 2005). The first toggle switch and repressilator are explained below.

Genetic toggle switch:

Construction of a genetic toggle switches—a synthetic, bistable gene-regulatory network—in *Escherichia coli* and provide a simple theory that predicts the conditions necessary for bistability. The toggle is constructed from any two repressible promoters arranged in a mutually inhibitory network. It is flipped between stable states using transient chemical or thermal induction and exhibits a nearly ideal switching threshold. In the experiment the LacI-repressor was used as Repressor 2, repressing the promoter *P_{trc-2}* being inducible by IPTG working as Inducer 2. Promoter 2 encodes either a heat inducible cI repressor or anhydrotetracycline (aTc) inducible tetR repressor that will repress Promoter 1. If there is expression from Promoter 2 (the *P_{trc-2}* promoter) there will be expression of a reporter protein, in this case in the form of the *GFPmut3* gene. The vector design used by Gardner *et al.* is shown in **Figure 2.16**. By using the

construct design in *E. coli* strain JM2.300, they created a genetic circuit with two separate stable expression states (bistable) in which could be switched between by adding an inducer (chemical or physical) to the medium.

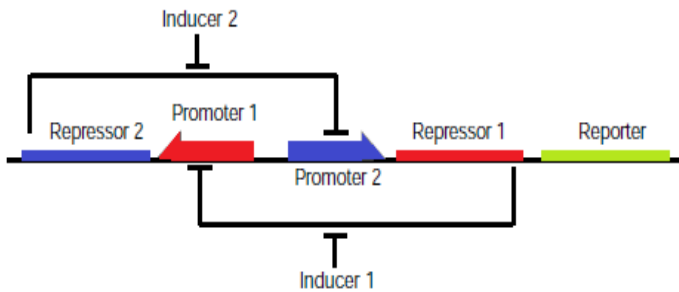
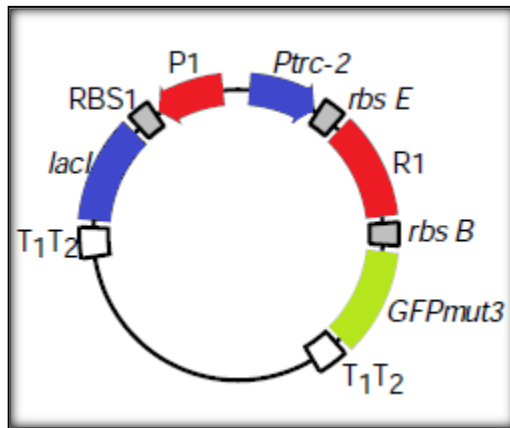

Fig (5.12) a.) Schematic presentation of the genetic toggle switch made by Gardner *et al.* Promoter 1 is repressed by the Inducer 1 inducible Repressor 1. Promoter 2 is repressed by the Inducer 2 inducible Repressor



b.)

The vector design applied for demonstration of a genetic toggle switch

Image Courtesy: Timothy S. Gardner., 1999

Repressilator

The repressilator was constructed by Elowitz and Leibler as a synthetic oscillatory network of transcriptional regulators, a biological oscillator. Here it was used three repressors acting in sequence on each other. If it is being transcribed from the *PLtet01* promoter in the beginning there will be produced λ cI repressor and reporter protein. The cI repressor will repress the λ PR promoter, and therefore there will be no lacI repressor produced and the RNA polymerase will transcribe from the *PLlac01* promoter, and the tetR repressor will be produced. This repressor will repress both *PLtet01* promoters stopping the production of the reporter protein and the λ cI repressor. This will leave open the λ PR promoter and there will be produced lacI repressors. This will stop the production of the tetR repressor, and thereby end the transcription from the

PLtet01 promoters again producing the reporter protein. . This cyclic fashion of repression gives the circuit an oscillating behavior. The two plasmids illustrated in **Figure 2.17** were contained by a culture of *E. coli* strain MC4100 to produce the oscillating behavior.

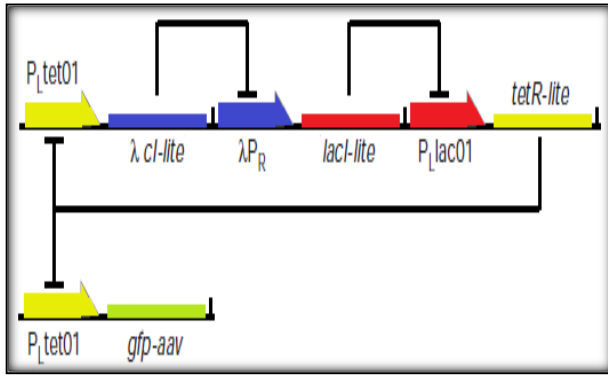

a.) Representation of the repressilator. One of the two *PLtet01* promoters encodes the *cI-lite* gene. The *cI-lite* repressor can repress the *PR* promoter which encodes the *lacI-lite* gene. The *lacI-lite* repressor can repress the *PLlac01* promoter which encodes the *tetR-lite* gene. The *tetR-lite* repressor can repress both the *PLtet01* promoters and thereby the expression of the reporter gene *gfp-aav*.

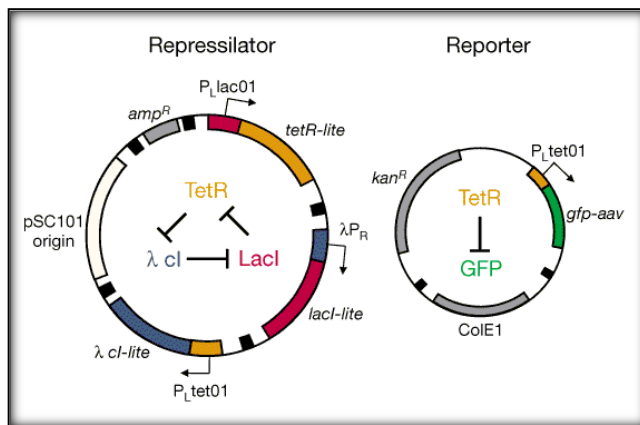

Figure 5.13

Picture credit: Elowitz M.B. and Leibler S., 2000.

b.) The vector design applied for the creation of the oscillating repressilator and reporter construct

In Eukaryotes, yeast a bistable positive feedback loop expressed in yeast in which a tetracycline-dependent activator turns on its own expression (Becskei *et al.* 2001) .In this system, cells initially in an “off” state could be flipped onto an “on” state in the presence of tetracycline. In response to a graded increase in tetracycline, a bimodal distribution of cells is created that are either in the on or off state.

Using the same general design concepts as described in the bacterial toggle switch, Kramer and colleagues (Kramer *et al.* 2004; Kramer and Fussenegger 2005) designed a mammalian (CHO

Review of Literature

cell)-based hysteretic toggle switch using streptogramin and macrolide-dependent transcription factors, each fused to a KRAB repression domain. The system switches between two steady states in response to the specific inducers.

To the best of my knowledge and literature survey so far done there is no evidence for the construction of toggle switch or repressilator for the protozoan parasite.

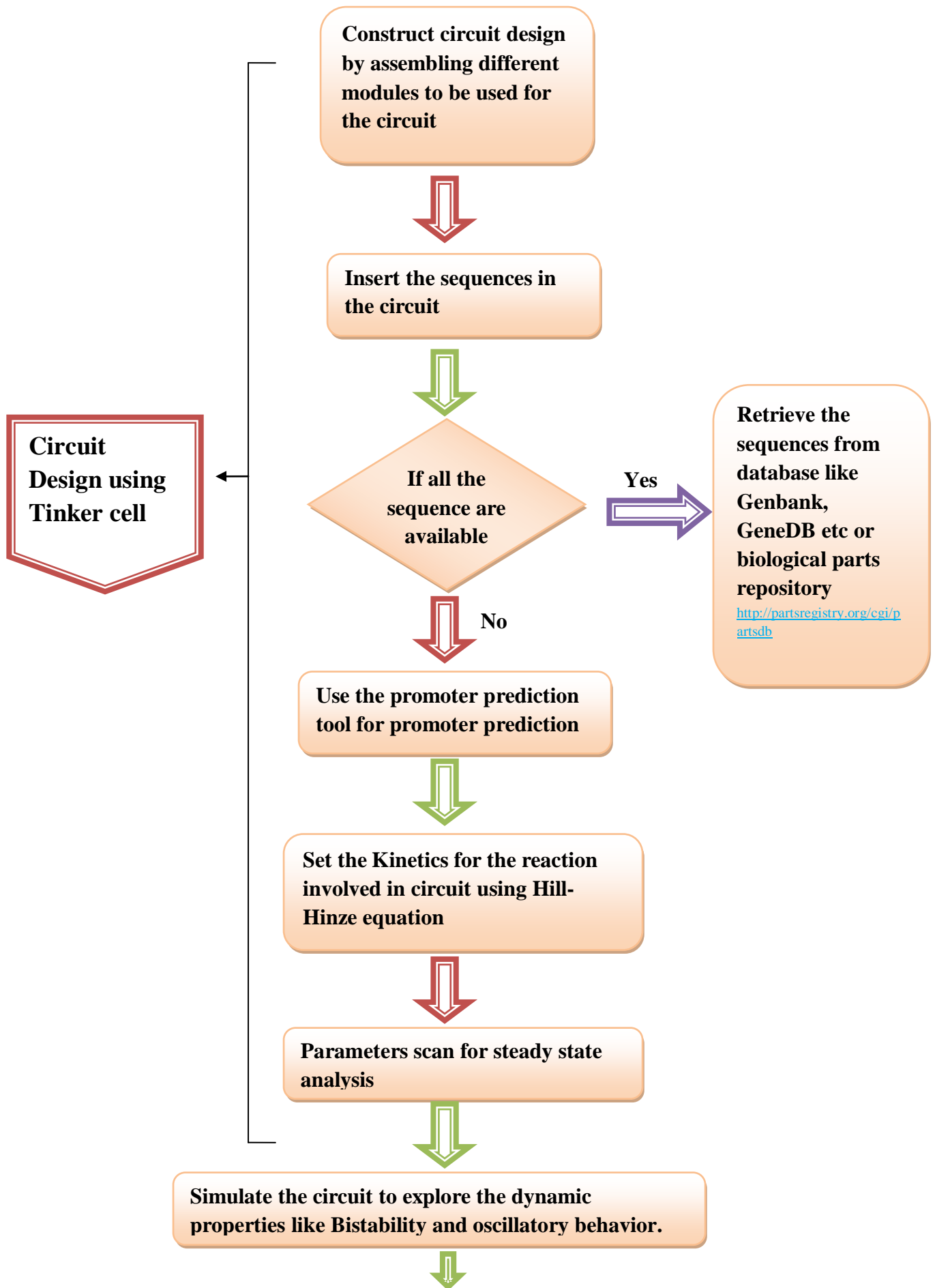

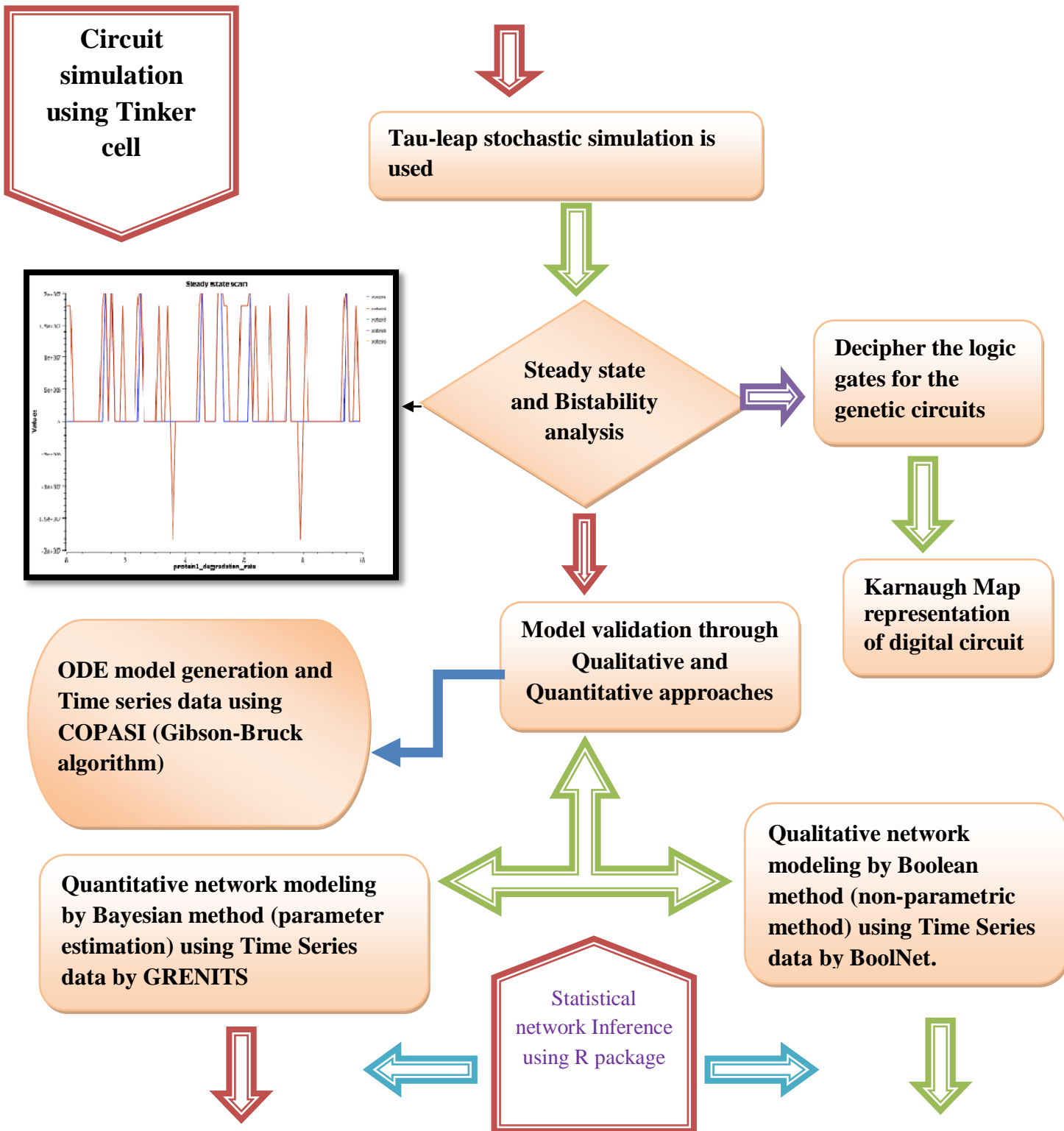

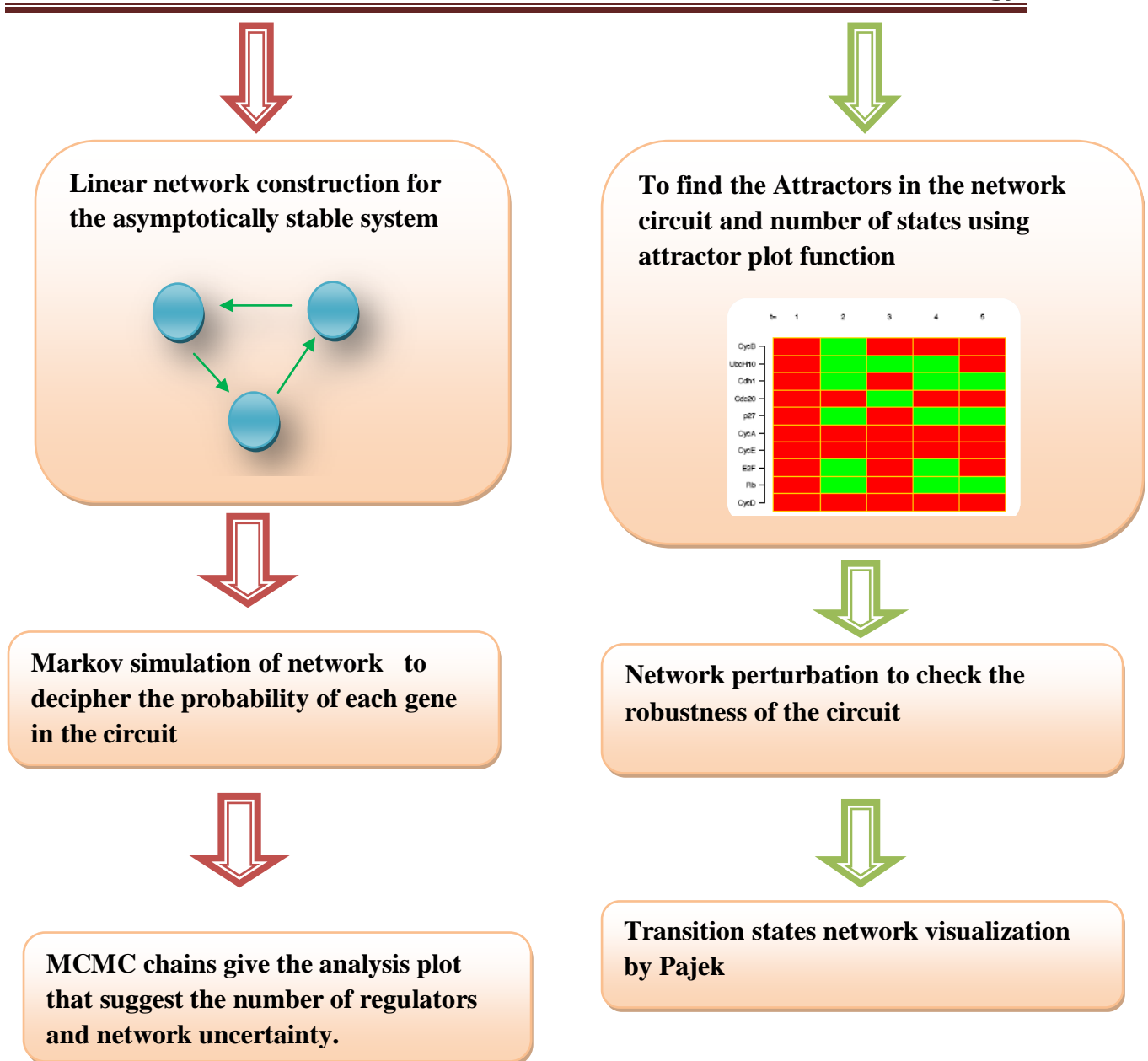

Fig 6.1 Schematic Representation of the workflow implemented in project

Implementation of the circuit design using Tinker cell

Tinker Cell is a visual modeling tool that supports a hierarchy of biological parts. Each part in this hierarchy consists of a set of attributes that define the part, such as sequence or rate constants (Chandran D *et al.*, 2009). Using a computer aided design (CAD) application, it is possible to construct models using available biological "parts" and directly generate the DNA sequence that represents the model, thus increasing the efficiency of design and construction of synthetic networks. Each part in the model can store a large amount of information associated with the part, such as database IDs, annotation, ontology, parameters, equations,

sequence, and information required by experimentalists, such as plasmid information or restriction sites found within the part. Parts can be loaded along with all their known information from databases, although this feature depends on the growth of the databases themselves. Tinker Cell has extensive support for constructing gene regulatory networks by connecting parts such as promoters, ribosomal binding sites (RBS), and other genetic components listed in the parts catalog. When parts are connected together, Tinker Cell will automatically derive rate equations for transcription and translation by looking at the transcription factors bound to operator sites. Tinker cell consist of three windows: Tools window, main menu bar and parts and connection window. It includes workspace where circuit is designed.

Circuit design: From the parts and connection window, select parts that are to be inserted in circuit. Select repressible promoter part, coding region for each genes. On basis of the connection of the modules, reactions are set. For genetic circuit transcription repression reaction is assigned for the mutual repression between the two genes included in the toggle switch. Similarly design the repressilator with three genes connected in cyclic manner and assigns the transcription repression reaction. Coupling between toggle switch and repressilator is done by insertion of the transcription repression reaction between the first gene of the toggle switch and first gene of the repressilator in such a way that gene of the repressilator controls the gene of the toggle switch.

Insertion the sequence: To construct the switch for IPCS (Inositol phosphoryl ceramide synthase), sequences homologous to the *L.major* was retrieved by BLAST search.

BLAST: Basic Local Alignment search tool, BLAST finds regions of similarity between biological sequences. BLASTP programs search protein databases using a protein query. BLAST (<http://blast.ncbi.nlm.nih.gov/BlastP>) requires a query sequence to search for similarity sequences against the target databases or a sequence database containing multiple such sequences. Input sequences are in FASTA format or Genbank format.

Sources of the sequences are:

GeneDB: GeneDB (<http://www.genedb.org>) is a genome database for prokaryotic and eukaryotic pathogens and closely related organisms. The resource provides a portal to genome sequence and annotation data, which is primarily generated by the Pathogen Genomics group at the Wellcome Trust Sanger Institute. It combines data from completed and

ongoing genome projects with curated annotation, which is readily accessible from a web based resource. GeneDB now holds the genome sequences of 9 apicomplexans, 3 of them human pathogens; 12 kinetoplastid protozoans, 7 of them human pathogens; 3 parasitic helminths, all human pathogens; and 16 bacterial species, 13 of them either human pathogens or opportunistic human pathogens

UniProt: UniProt is a comprehensive, high quality and freely accessible database of protein sequence and functional information, many of which are derived from the genome sequencing projects. It contains a large amount of information about the biological functions of proteins derived from the research literature (<http://www.uniprot.org>)

Registry of standard Biological parts: The Registry is a continuously growing collection of genetic parts that can be mixed and matched to build synthetic biology devices and systems developed in 2003 at MIT; the Registry is part of the Synthetic Biology community's efforts to make biology easier to engineer (<http://partsregistry.org/cgi/partsdb/Statistics.cgi>).

OrthoMCL: OrthoMCL is a genome-scale algorithm for grouping orthologous protein sequences. It provides not only groups shared by two or more species/genomes, but also groups representing species-specific gene expansion families. So it serves as an important utility for automated eukaryotic genome annotation. OrthoMCL starts with reciprocal best hits within each genome as potential in-paralog/recent paralog pairs and reciprocal best hits across any two genomes as potential orthologous pairs. Related proteins are interlinked in a similarity graph.

Selected sequences are inserted in the modules using Text Attributes. DNA sequence viewer used to see the sequences inserted in the modules. Set the target promoter regions for the transcription repression by text attributes.

Set Parameters: Set the parameters for all the modules and reaction rates like protein degradation, promoter strength, transcription rate, dissociation constants and hill's coefficient by using parameter attributes or model summary window.

Steady state: For parameter scan, use steady state analysis by steady state program.

Simulation: Stochastic simulation for the genetic circuit is done by tau-leap stochastic simulation using stochastic program.

Logic Circuit design

Decipher the logic gates to be implemented for the circuit. Conversion of the truth table into circuit scheme via Karnaugh map, which is better representation of truth table, was done.

ODE model

In ODE model the concentration of gene products variables like protein and gene regulation system are represented by Differential Equation.

COPASI

The name COPASI stands for Complex Pathway Simulator. COPASI is an open-source software application for creating and solving mathematical models of biological processes such as metabolic networks, cell-signaling pathways, regulatory networks, infectious diseases, and many others. It includes methods for simulation and analysis of biochemical reaction. It includes methods like ODE solver that converts the reaction into ordinary differential equations. It includes methods like simulation of reaction networks, the computation of steady states and their stability, stoichiometric network analysis, e.g. computing elementary modes (Schuster *et al.*, 1999), sensitivity analysis ,metabolic control analysis; Fell (1996); Heinrich and Shuster, 1997), optimization and parameter estimation. Input for the COPASI was the input file exported from the Tinker cell circuit model in SBML format.

SBML format: *Systems Biology Markup Language* is a machine-readable format for describing qualitative and quantitative models of biological systems (The SBML web page: <http://sbml.org/index.psp>). SBML provides a standard biochemical network model of representation and it promotes inter-operability between tools. SBML is based on XML, Extensible Markup Language, which is a standard language for describing markups languages.

It is a free and open standard with widespread software support and a community of users and developers. SBML can represent many different classes of biological phenomena, including metabolic networks, cell signaling pathways, regulatory networks, infectious diseases, and many others. Time series data for the circuit was developed by using time course method for the stochastic simulation.

Model validation

R software

R is a free software environment for statistical computing and graphics. R provides a wide variety of statistical (linear and nonlinear modeling, classical statistical tests, time-series analysis, classification, clustering.) and graphical techniques, and is highly extensible. R is available as Free Software under the terms of the Free Software Foundation's GNU General Public License in source code form. R can be extended (easily) via packages.

Bioconductor package

Bioconductor is a free, open source and open development software project for the analysis and comprehension of genomic data. Bioconductor is based primarily on the statistical R programming language. It includes packages for the sequence analysis, microarray data analysis, sequence annotation, SNP (single nucleotide polymorphism) analysis, high throughput Assays. GRENITS and BoolNet are packages of Bioconductor.

GRENITS:

GRENITS is Gene regulatory network inference using time series data. Network inference using ODE time series data was done using GRENITS. It gives the probability of the genes included in the circuit. Probability suggests the regulators of the circuit. It also gives the network uncertainty.

Steps followed in GRENITS are:

Commands	Description
data	• Input Time series data
LinearNet	• Construct Linear network of the circuit and generates the Markov chains that gives the posterior probability
analyse	• Analyse the output of network, produces analyses plot and convergence plot.
prob.mat	• Generate the network probability matrix
inferred.net	• generate inferred network from the regulatory circuit

BoolNet

BoolNet is an R package that provides tools for assembling, analyzing and visualizing synchronous and asynchronous Boolean networks as well as probabilistic Boolean networks. In a biological context, genes can be modeled as Boolean variables (active/expressed or inactive/not expressed), and the transition functions model the dependencies among these genes. In the synchronous model, the assumption is that all genes are updated at the same time. This simplification facilitates the analysis of the networks. For synchronous and asynchronous Boolean networks, the most important tool is the identification of attractors. Attractors are cycles of states and are assumed to be associated with the stable states of cell function. Another possibility of identifying relevant states is the included Markov chain simulation. This method is particularly suited for probabilistic networks and calculates the probability that a state is reached after a certain number of iterations. To test the robustness of structural properties of the networks to noise and mismeasurements, the software also includes extensive support for perturbing networks. Time series data of the circuit is input for the BoolNet. Network constructed in BoolNet can be exported to Latex document and Pajek which is analysis and visualization tool for network.

Steps followed in BoolNet:

Commands	Description
data	•Input Time series data
binarizeTimeSeries	•Converts the real values data sets to binary data as required by the network reconstruction algorithm.
reconstructNetwork	•Generates probability boolean network and transition functions
getAttractors	•Gives the attractors in the circuit. It includes both type of attractors ; asynchronous and synchronous.
tt	•Gives the transition table
plotAttractors	•plots the attractor plot that gives no of states to reach steady state.
sim	•generate markov simulation to predict the steady state
perturbedNet	•The generation of perturbed copies of a network is a way to test the robustness of structural properties of the networks to noise and mismeasurements.
testNetworkProperties	•plot the robustness plot
toPajek	•export network to Pajek

Pajek

Pajek is a program for analyzing large networks. Pajek is freeware software and can be downloaded from the URL <http://vlado.fmf.uni-lj.si/pub/networks/pajek/>. **Pajek** (Slovene word for Spider) is a program, for Windows (32 bit), for analysis of large networks.

Genetic Circuit

Genetic circuit for IPCS was constructed using the software Tinker cell. Genetic circuit consists of genetic toggle switch coupled with repressilator. Toggle switch has two mutually repressing genes that encode the repressor for the opposite gene. Repressilator includes three genes that code the repressor of next gene in cyclic manner. For the construction of genetic circuit of IPCS, bidirectional reaction has to be considered. For this reason, homologs of IPCS were identified using blastp analysis.

Homologous for IPCS are:

UniProt ID	GeneDB	Gene symbol	Gene name	Identity (%)	e-value
Q38E53	Tb09.211.1030	SLS1	IPC synthase	43	1e-08
Q38E56	Tb09.211.1000	SLS4	EPC synthase/ SM synthase	44	4e-80
Q38E54	Tb09.211.1020	SLS2	EPC synthase	43	2e-67
Q38E55	Tb09.211.1010	SLS3	SM synthase	45	3e-82

Table 7.1 Homologs of IPCS

TbSLS1 and TbSLS4 which code for IPC synthase and SM synthase respectively in *T.brucei* were considered for the construction of the genetic toggle switch based on the homology obtained.

Functional relationship between *L.major* IPCS and *T.brucei* IPCS (SLS1) is shown by the Ortholog relationship between them. Orthologs were searched by OrthoMCL database.

Fig 7.1 Functional relationship between *L.major* and other species was reflected by the graph of ortholog relationship given below.

Results and Discussion

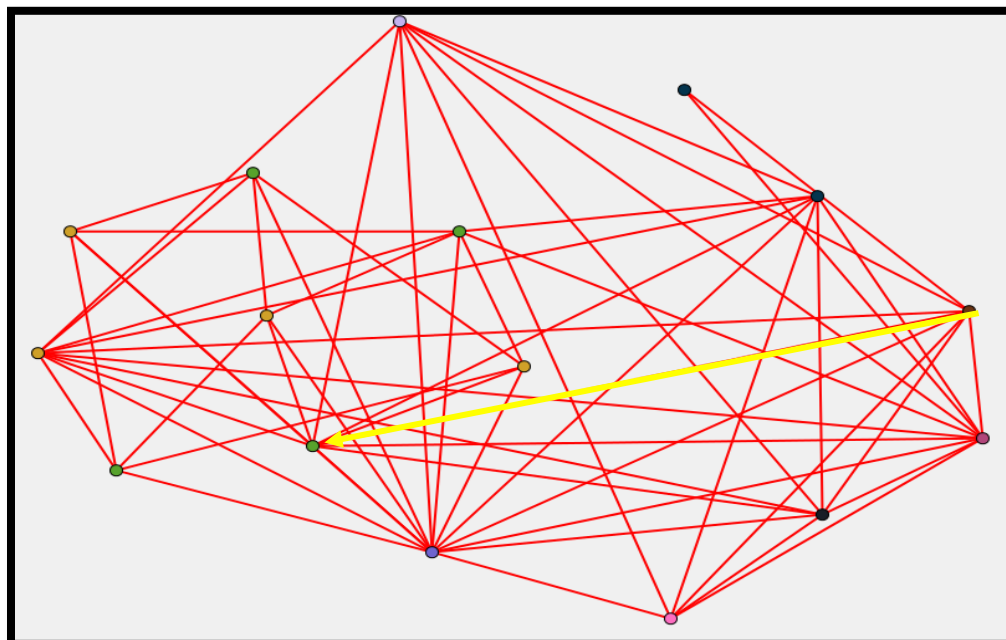

TAXON LEGEND		
● tcru	● tbrg	● tbru
● lmaj	● tviv	● linf
● lmex	● tcon	● lbra

Arrow highlighted shows the 94 % orthology relationship between IPCS of *T.brucei* and *L.major*.

Design of the genetic circuit constructed for IPCS was referred from the genetic toggle switch of *E.coli* and repressilator of *E.coli* designed by Gardner and Elowitz respectively. Genetic modules used in construction of genetic circuit are

NAME	Accession-ID
Protein1:IPC5_1(inositol phosphoryl ceramide synthase 1)	Q38E53
Protein2:IPC5_2(inositol phosphoryl ceramide synthase 2)	Q38E56
Protein3:Lactose-repressor	P03023
Protein4:Tetracycline repressor protein	P04483
Protein5:LAMBDA Repressor protein	P03034
rp1:Repressible promoter of IPC5_1	predicted
rp2:Repressible promoter of IPC5_2	predicted
rp3:Repressible promoter of LacR	BBa_R0010
rp4:Repressible promoter of TetR	BBa_R0040
rp5:Repressible promoter of cl	BBa_R0051
tr:Transcription repression	
pp:protein product	
IPC5_1:coding gene for IPC5_1	SLS1_TRYB2
IPC5_2:coding gene for IPC5_2	SLS4_TRYB2
lacI:coding gene for Lactose repressor	BBa_C0012
Tetr;coding gene for Tetracycline repressor	BBa_C0040
lamdar:coding gene for lamda repressor	BBa_C0051

TbSLS1 and TbSLS4 were considered as IPCS_1 and IPCS_2 in circuit.

Genetic circuit model for IPCS:

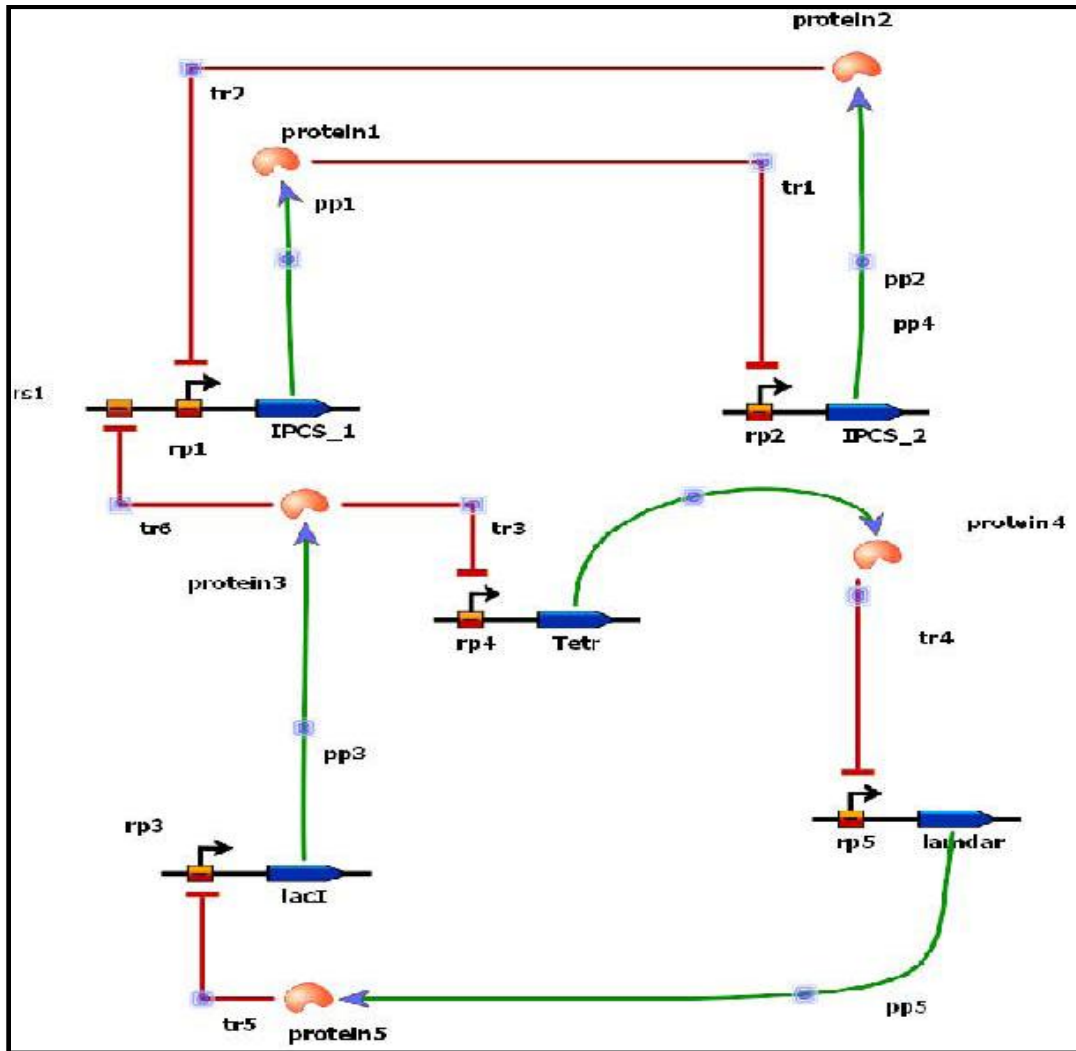

Fig 7.2 Genetic circuit for IPCS

Model Summary

Genetic toggle switch consists of IPCS_1 and IPCS_2. Repressilator consists of Lactose repressor (LacI), Tetracycline repressor (Tetr), and Lambda repressor (Phage lambda). In the circuit, IPCS_1 encodes for the repressor for the opposite gene IPCS_2 and IPCS_2 represses IPCS_1. In the circuit, it is considered that IPCS_1 and IPCS_2 mutually repress each other that reflects the bistable behavior of the genetic switch for the IPCS. The repressilator genes act in a cyclic manner where LacI represses Tetr, Tetr represses LambdaR, and LambdaR in turn represses LacI; the repressilator tends to

Results and Discussion

produces oscillatory behavior. Coupling between genetic toggle switch and repressilator is developed by LacI and IPCS_1 where LacI regulates the IPCS_1 and represses it.

Parameters considered for the construction of circuit are summarized in table below. Default parameters are initially assigned to the genetic modules on basis of connectivity of the genetic circuit. Initially the Kd values for the genes were set to 1 and hill's coefficient value was set to 2. Parameter scan was done for the steady state analysis and the parameters values considered for the model are summarized in the table below.

Module no	Promoter strength	Kd	H(Hill/coefficient)	Degradation rate
IPCS_1	5.054	2.99	4.89	0.1835
IPCS_2	5	1.9	3.116	0.087
LacI	11.73	1.9	1.126	0.1867
Tetr	5	1.38	1.387	0.124
LamdaR	5	2.029	1.54	0.125

Table 7.2 Model summary of the genetic circuit

Kd =Dissociation constant

Translation rates and transcription rates are set to 1 for all the genetic modules as the steady state analysis is reflected by degradation rates of the proteins. Kinetics applied to the genetic circuit was by Hill-Hinze's equation for gene product. Kinetics generated for the genetic modules are:

$$\text{IPCS}_1 = \text{rp1.strength} * (\text{rs1} * \text{rp1})$$

$$\text{IPCS}_2 = \text{rp2.strength} * \text{rp2}$$

$$\text{LacI} = \text{rp3.strength} * \text{rp3}$$

$$\text{Tetr} = \text{rp4.strength} * \text{rp4}$$

$$\text{LamdaR} = \text{rp5.strength} * \text{rp5}$$

$$\text{rp1} = 1.0 / ((1 + ((\text{IPCS2protein} / \text{tr2.Kd})^{\text{tr2.h}})))$$

$$\text{rp2} = 1.0 / ((1 + ((\text{IPCS1protein} / \text{tr1.Kd})^{\text{tr1.h}})))$$

$$\text{rp3} = 1.0 / ((1 + ((\text{LamdaRepressor} / \text{tr5.Kd})^{\text{tr5.h}})))$$

$$rp4 = 1.0 / ((1 + ((lactoserepressor/tr3.Kd)^{tr3.h})))$$

$$rp5 = 1.0 / ((1 + ((TetrRepressor/tr4.Kd)^{tr4.h})))$$

Steady state Analysis

Steady state scan analysis for the degradation rates of all the proteins was carried out.

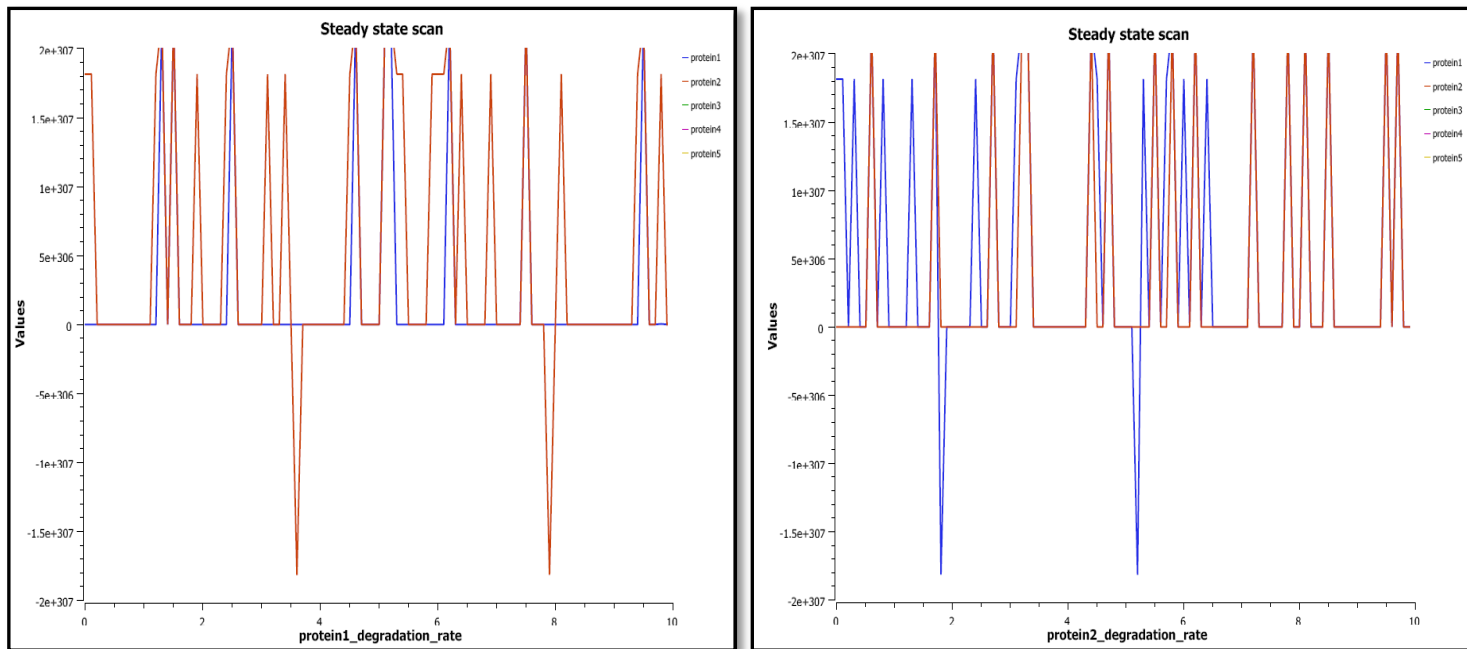

Fig 7.3 Degradation Rates graphs

a.)IPCS_1 degradation graph

b.)IPCS_2 degradation graph

Legends of the graphs

- IPCS_1: — (blue line) x= time points (in seconds)
- IPCS_2: — (red line) y= values of degradation rate
- LacI : — (green line)
- Tetr : — (magenta line)
- LamdaR: — (yellow line)

Above are degradation graphs for IPCS_1 and IPCS_2 proteins. In figure 3.3 (a), it shows the bistability behavior of the genetic circuit. When the degradation of IPCS_1 protein decreases, there is a rise in the expression of the opposite toggle gene IPCS_2. There are two points of time where there is a peak fall in the IPCS_2, where there is switching of the states. This desired graph was obtained at 0.18 degradation rate of IPCS_1. Fig 3.3(b) shows degradation rate of IPCS_2. When there is an increase in the level of IPCS_2 at a particular interval of time, there is

Results and Discussion

decrease in the level of IPCS_1. Two points of time in graph shows there is peak fall in the degradation of the IPCS_1 which shows that IPCS_2 represses the IPCS_1 where the flipping of the switch occurs. The desired behavior was obtained at 0.08 degradation rate of IPCS_2.

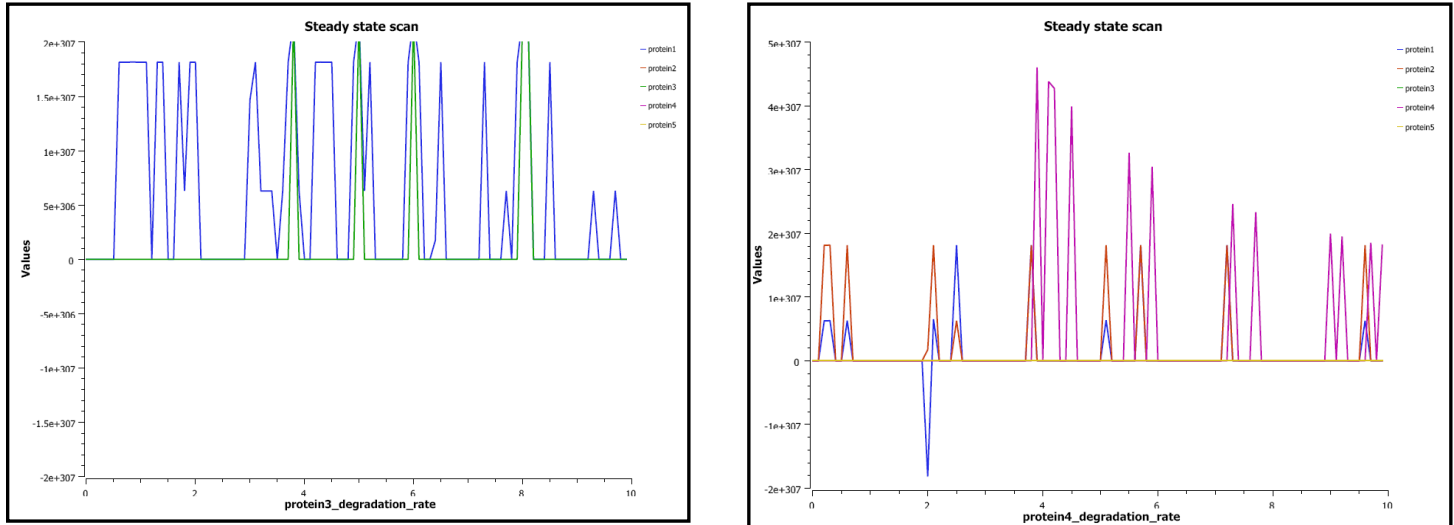

Fig 7.4 Degradation Rate graphs

a.)LacI degradation graph

LacI: — (green) IPCS_1 — (blue)

b.)Tetr degradation graph

Tetr — (purple) LamdaR — (orange)

In figure 3.4 degradation graphs for the LacI ,which shows the coupling behavior between IPCS_1 and LacI. Intially there is no increase in the level of the LacI because of there is no coupling between LacI and IPCS_1 which results in the increase in the level of IPCS_1. At time interval of 4 ,there in increase in the level of LacI and drop in the level of the IPCS_1. This change in the regulation of IPCS_1 with respect to LacI shows the coupling between genetic toggle switch and repressilator. Fig 3.4 (b) is degradation graph for the Tetr ,there is less oscillation between LamdaR and Tetr but it shows the repression of LamdaR. Remaining results for the change in degradation of proteins are attached in supplementary file.

Simulation results

Simulation of the genetic circuit was performed using tau-leap stochastic simulation. Simulation was performed for 100 time points. Simulation of genetic circuit was done at different concentration. Results of fluctuations in the protein level with respect to change in dissociation constant (K_d) were obtained as follows :

case 1 :change in the K_d values of IPCS_1

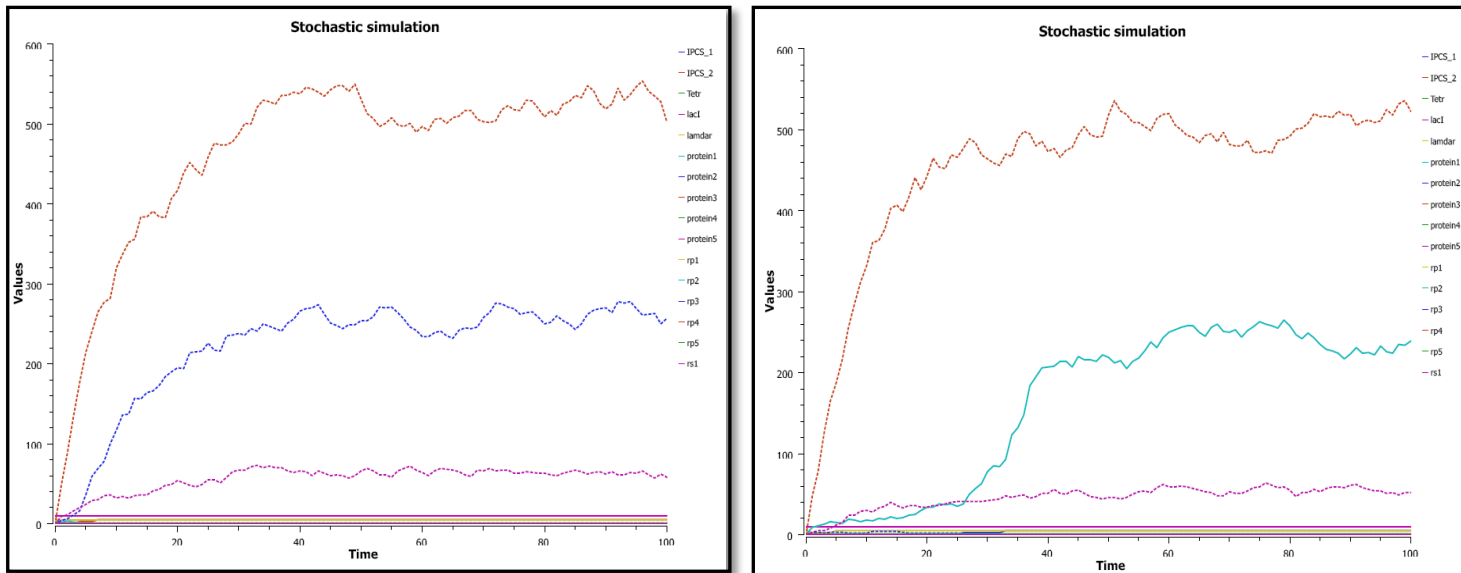

Legends IPCS_1 : — IPCS_2 — LacI — Tetr — LamdaR —

a.) $K_d=1$

b.) $K_d=1.01$

Fig 7.5 Simulation results for IPCS_1 by change in the K_d values of IPCS_1

In Fig 3.5 ,there is change in the proteins level with respect to change in the K_d values,when $K_d=1$,level of IPCS_1 is increased but when the value of K_d is rose to 1.01,there is switch in the level of IPCS_2 because of the dissociation between IPCS_1 and regulatory binding site is increased, this leads the circuit to toggle and level of IPCS_2 is raised. Similar fluctuations in protein level is observed when K_d values at regular intervals are changed .The remaining results for the change in K_d values are attached in supplementary file.

Results and Discussion

Case 2: Simulation for the change in kd values of IPCS_2 were also performed that results in to the fluctuation of levels of IPCS_1

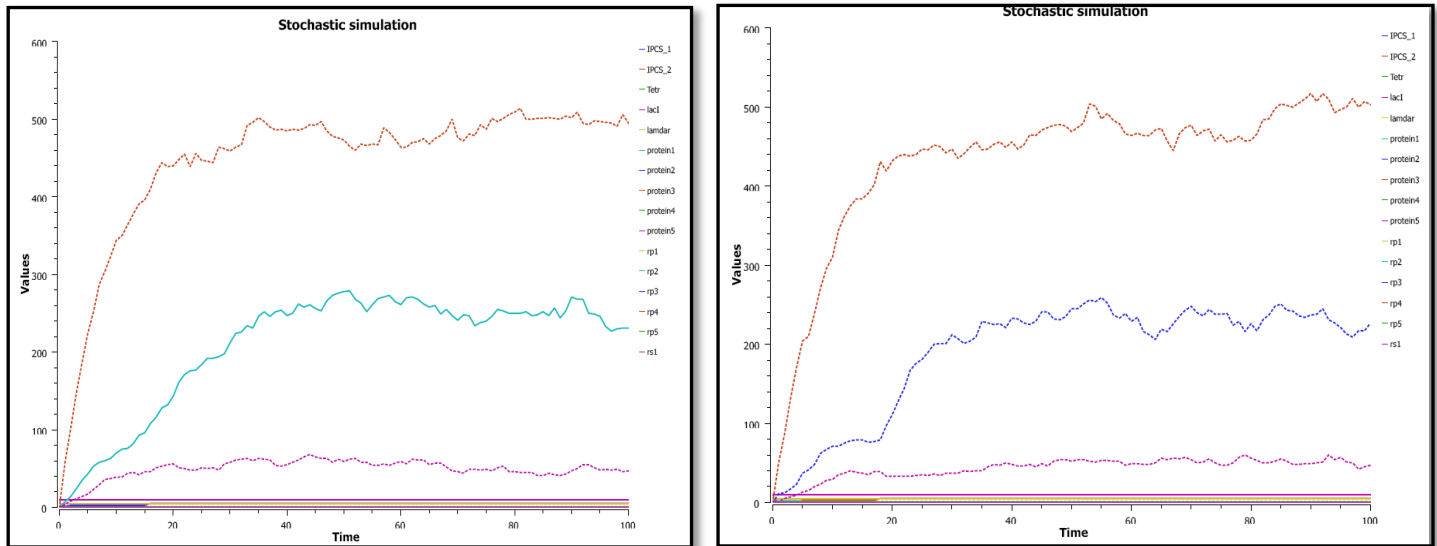

Fig 7.6 Simulations results for circuit by change in the Kd values of IPCS_2

a.) $K_d=1.01$

b.) $K_d=1.02$

In Fig 3.6 , when $K_d=1.01$,level of IPCS_2 is increased but when the value of K_d is rose to 1.01,there switch in the level of IPCS_1 because of the dissociation between IPCS_2 and repressor is increase this leads the circuit to flip and level of IPCS_1 is raised. Similar perturbations in levels of IPCS_1 and IPCS_2 is observed when changes in the K_d at regular intervals are done.The remaining results for the change in K_d values are attached in supporting file. Above results shows the bistable behavior between IPCS_1 and IPCS_2 of the genetic circuit and coupling between IPCS_1 of toggle switch **snd** LacI of the repressilator is also shown.

Digital circuit representation of the Synthetic Genetic circuit

Digital circuits gives insight into the logic gates implemented in the circuit design for the functioning of the circuit. The circuit consists of two genes coding for two repressors. The two repressors mutually repress each other such that a high concentration of one protein inhibits the transcription of the other gene. Any signal that causes the breakdown of the existing repressor protein molecules or increases the transcription of the other repressor protein would cause the flip. A Toggle Switch has two IMPLIES gates connected in such a way that the output of one

Results and Discussion

represses the other. Two IMPLIES gates mutually connected with each other where the output signal of one IMPLIES gate is input signal for the opposite IMPLIES gate.

The repressilator is constructed by integrating an odd number of NOT gates in a circular fashion such that the output of the last gate is the input of the first one. Three NOT gates connected in cyclic manner in which the output signal of first gate is the input signal for the second gate, output signal for the second gate is input signal for the third gate. Output signal for the last gate is input signal for the first gate. It is mandatory to consider the odd numbers of NOT gate in the repressilator because if there are even number of gates then the output generated from the last gate will be high. However, if the number is odd, the output from the last inverter gate will be low and when fed to the first gate generates a high output from the last inverter. Hence the last output signal oscillates between low and high alternately.

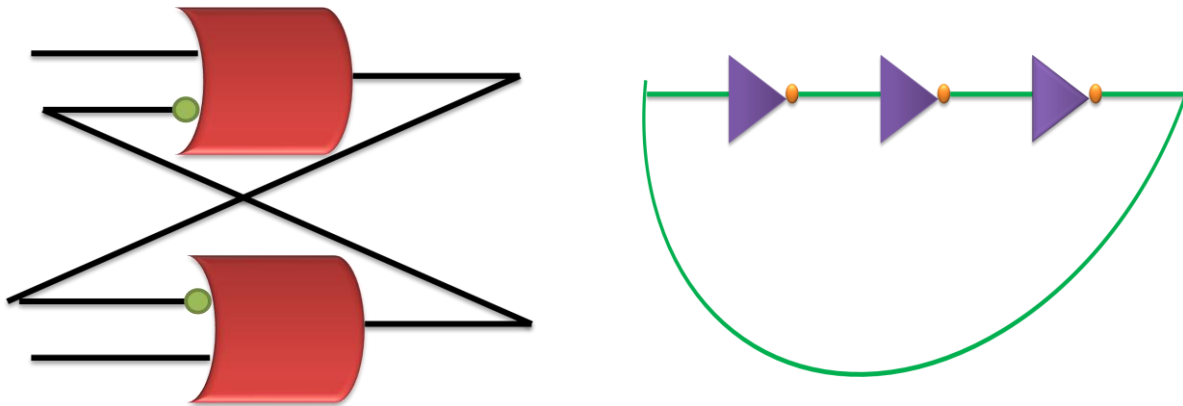

Fig 7.3 a.) Logic gates for the genetic toggle switch b.) Logic gates for the repressilator

Logic of the genetic circuit is represented by the truth table. Truth table of logic gates for the genetic circuit of IPCS is represented below.

Input(A)	Input (B)	Input (C)	output
0	0	0	1
0	0	1	0
0	1	0	1
0	1	1	0
1	0	0	0
1	0	1	0
1	1	0	0
1	1	1	0

Results and Discussion

Table 7.3 Truth Table for the genetic circuit. Input A and B are the input signal of genetic toggle switch and C is the input signal of the repressilator.

Karnaugh map is simplified representation of truth table. It gives more insight to study the logic of digital circuit. Coordinates used in the Karnaugh map should map the values in the truth table.

C	AB			
	00	01	11	10
0	1	1	1	0
1	0	0	0	0

Table 7.4 Karnaugh map of the truth table of the genetic circuit constructed

The values of **C** are written on the rows of the Karnaugh map, whereas the values of **A** and **B** lie on its columns. The Karnaugh map method permits to derive both the Sum of product (SOP) and POS (Product of sum) form of the Boolean expression associated with any truth table.

$$\text{SOP} = (\overline{A} * C) + (A * \overline{B}) \quad \text{POS} = \overline{A} * (\overline{B} + C)$$

Karnaugh map help to construct digital circuit. Circuit scheme gives the logic design for how the input signals affect the output of the circuit.

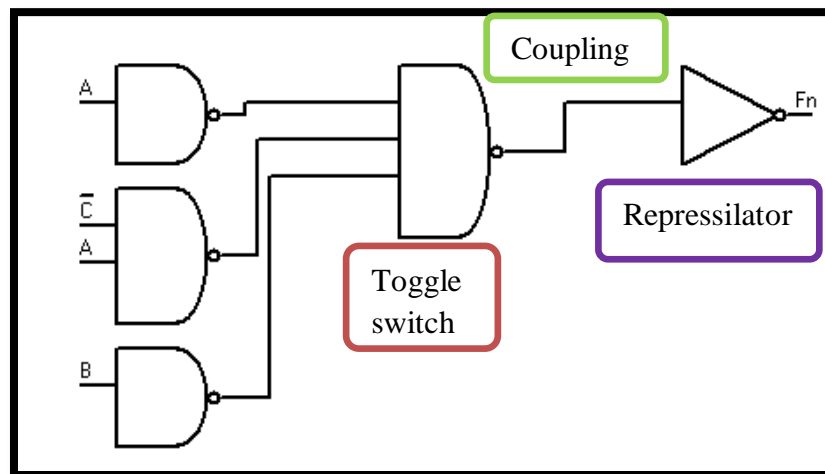

Fig 7.8 Conversion of a truth table into a digital circuit via the Karnaugh map method.

Digital circuit implements the logic gates deciphered for the genetic circuit. Digital circuit shows the logic gate for the toggle switch and repressilator.

Genetic circuit model validation

Model validation was done by using Qualitative and Quantitative approaches. For this ODE model was generated for the genetic circuit. ODE model is mathematical representation of the circuit in form of differential equations. ODE model gives more insight into regulatory mechanism for the genetic circuit. ODE model derived for the genetic circuit constructed are as follows:

For IPCS_1

$$\begin{aligned} & \frac{d([IPCS1protein].V_{DefaultCompartment})}{d t} \\ = & +V_{DefaultCompartment} \cdot \left(\frac{pp1_translation_rate.rp1_strength.[IPCS_1]}{V_{DefaultCompartment}} \right) \\ & -V_{DefaultCompartment} \cdot \left(\frac{IPCS1protein_degradation_rate.[IPCS1protein]}{V_{DefaultCompartment}} \right) \end{aligned}$$

For IPCS_2

$$\begin{aligned} & \frac{d([IPCS2protein].V_{DefaultCompartment})}{d t} \\ = & +V_{DefaultCompartment} \cdot \left(\frac{pp2_translation_rate.rp2_strength.[IPCS_2]}{V_{DefaultCompartment}} \right) \\ & -V_{DefaultCompartment} \cdot \left(\frac{IPCS2protein_degradation_rate.[IPCS2protein]}{V_{DefaultCompartment}} \right) \end{aligned}$$

For LacI

$$\begin{aligned} & \frac{d([lactoserepressor].V_{DefaultCompartment})}{d t} \\ = & +V_{DefaultCompartment} \cdot \left(\frac{pp3_translation_rate.rp3_strength.[lacI]}{V_{DefaultCompartment}} \right) \\ & -V_{DefaultCompartment} \cdot \left(\frac{lactoserepressor_degradation_rate.[lactoserepressor]}{V_{DefaultCompartment}} \right) \end{aligned}$$

For Tetr

$$\begin{aligned} & \frac{d([Tetrepressor] \cdot V_{DefaultCompartment})}{d t} \\ & = +V_{DefaultCompartment} \cdot \left(\frac{pp4_translation_rate \cdot 1 \cdot [Tetr]}{V_{DefaultCompartment}} \right) \\ & -V_{DefaultCompartment} \cdot \left(\frac{Tetrepressor_degradation_rate \cdot [Tetrepressor]}{V_{DefaultCompartment}} \right) \end{aligned}$$

For LamdaR

$$\begin{aligned} & \frac{d([lamdarepressor] \cdot V_{DefaultCompartment})}{d t} \\ & = +V_{DefaultCompartment} \cdot \left(\frac{pp5_translation_rate \cdot 1 \cdot [lamdar]}{V_{DefaultCompartment}} \right) \\ & -V_{DefaultCompartment} \cdot \left(\frac{lamdarepressor_degradation_rate \cdot [lamdarepressor]}{V_{DefaultCompartment}} \right) \end{aligned}$$

Equation 3.1 for protein concentration

$$[IPCS_1] = rp1_strength \cdot [rp1]$$

$$[IPCS_2] = rp2_strength \cdot [rp2]$$

$$[Tetr] = rp4_strength \cdot [rp4]$$

$$[LacI] = rp3_strength \cdot [rp3]$$

$$[LamdaR] = rp5_strength \cdot [rp5]$$

Equation 3.2

$$[rp1] = \frac{1}{1 + \left(\frac{[IPCS2protein]}{tr2_Kd} \right)^{tr2_h}}$$

$$[rp2] = \frac{1}{1 + \left(\frac{[IPCS1protein]}{tr1_Kd} \right)^{tr1_h}}$$

$$[rp3] = \frac{1}{1 + \left(\frac{[lamdarepressor]}{tr5_Kd} \right)^{tr5_h}}$$

$$\begin{aligned}
 [\text{rp4}] &= \frac{1}{1 + \left(\frac{[\text{lactoserepressor}]}{\text{tr3_Kd}} \right)^{\text{tr3_h}}} \\
 [\text{rp5}] &= \frac{1}{1 + \left(\frac{[\text{Tetrepressor}]}{\text{tr4_Kd}} \right)^{\text{tr4_h}}} \\
 [\text{rs1}] &= \frac{1}{1 + \left(\frac{[\text{repressor}]}{\text{tr6_Kd}} \right)^{\text{tr6_h}}}
 \end{aligned}$$

Equation 3.3 Transcription rate

ODE model has the expression for the concentration of the protein in form of variables. Reactions in which proteins are synthesized is represented by positive sign (+) and reactions in which proteins are degraded are represented by negative sign (-) i.e. Translation rate reaction is indicated by + sign in which the proteins are synthesized and degradation reactions is represented by – sign in which proteins are degraded. Promoter strength is also represented by equation for the coding regions that includes the promoter strength associated with each coding region. The transcription rates reaction which includes Kd values and hills coefficient.

Network Inference

Gene regulatory network was constructed for the genetic circuit using Bioconductor packages. Model was simulated using COPASI. Time series data was generated and used for qualitative and quantitative network modeling. Circuit model is asymptotically stable hence Linear network construction was followed. Quantitative network modeling performed by GRENITS gave the probability of each regulator in the regulatory network circuit. Posterior probability was derived by using Monte Carlo Markov Simulation (MCMC). MCMC simulation was run by using default parameters. Simulation generated two markov chains that resulted into link probability of the network generated. Results includes probability matrix for each gene in the regulatory network. Analysis plot and convergence plot was generated for the network circuit. The Convergence plots contain plots associated to the adequate convergence of the Markov chains. This is crucial for further analysis as, if convergence has not been reached, the results are not trustworthy. Analysis plot contains the link probability of each regulator with other in the circuit. Network inference was made for 10 and 100 time series .Inferred network showed the regulatory mechanism in the circuit.

Results and Discussion

From	To	Probability
IPCS_1	IPCS_1	0
IPCS_1	IPCS_2	1
IPCS_1	Tetr	0
IPCS_1	lacI	0
IPCS_1	LamdaR	0
lacI	IPCS_1	1
lacI	Tetr	0
lacI	lacI	0
lacI	LamdaR	1
LamdaR	IPCS_1	1
LamdaR	IPCS_2	0

Table 7.5 Posterior probabilities for each network connection

Above probability matrix has the probability 1 for IPCS_1 and IPCS_2 gives the regulatory mechanism between them. Matrix where probability is 1 shows the regulation between the respective regulators. Probability 0 indicates that there is no regulation between those regulators of genetic circuit.

	1 Regulators	2 Regulators	3Regulators	4Regulators	5 Regulators
IPCS_1	0	1	1	0	0
IPCS_2	1	0	0	0	0
Tetr	1	0	0	0	0
LacI	1	0	0	0	0
LamdaR	0	1	0	0	0

Table 7.6 Posterior probabilities for number of regulators for each gene.1 shows the regulation between the regulators and 0 indicates no regulation

Results and Discussion

Analysis plot of the genetic circuit shows the link probability which gives insight in to switching behavior between toggle switch and coupling between the LacI repressilator and IPCS_1 of genetic toggle switch as designed in the circuit model.

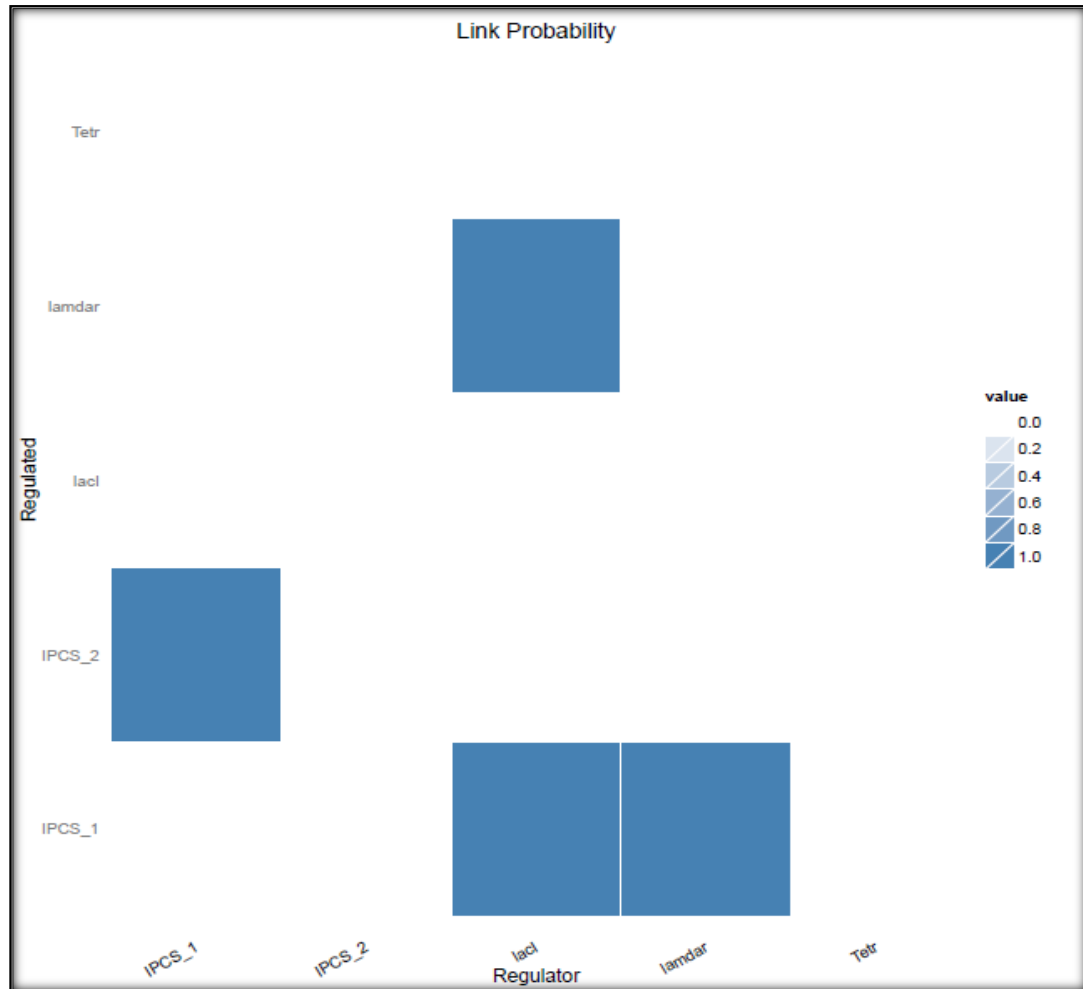

Fig 7.9 Heat map plot of network link probabilities

Analysis plot showed the probability of 1 (blue color) between IPCS_1 and IPCS_2. Coupling between LacI and IPCS_1 is deciphered by the link probability 1 between them.

Results and Discussion

Network uncertainty was given by marginal network uncertainty plot. Network uncertainty gave the idea about top regulators in the network. Plot (figure 3.10) reveals that IPCS_1, IPCS_2 and LacI to be top regulators of the genetic circuit constructed for IPCS

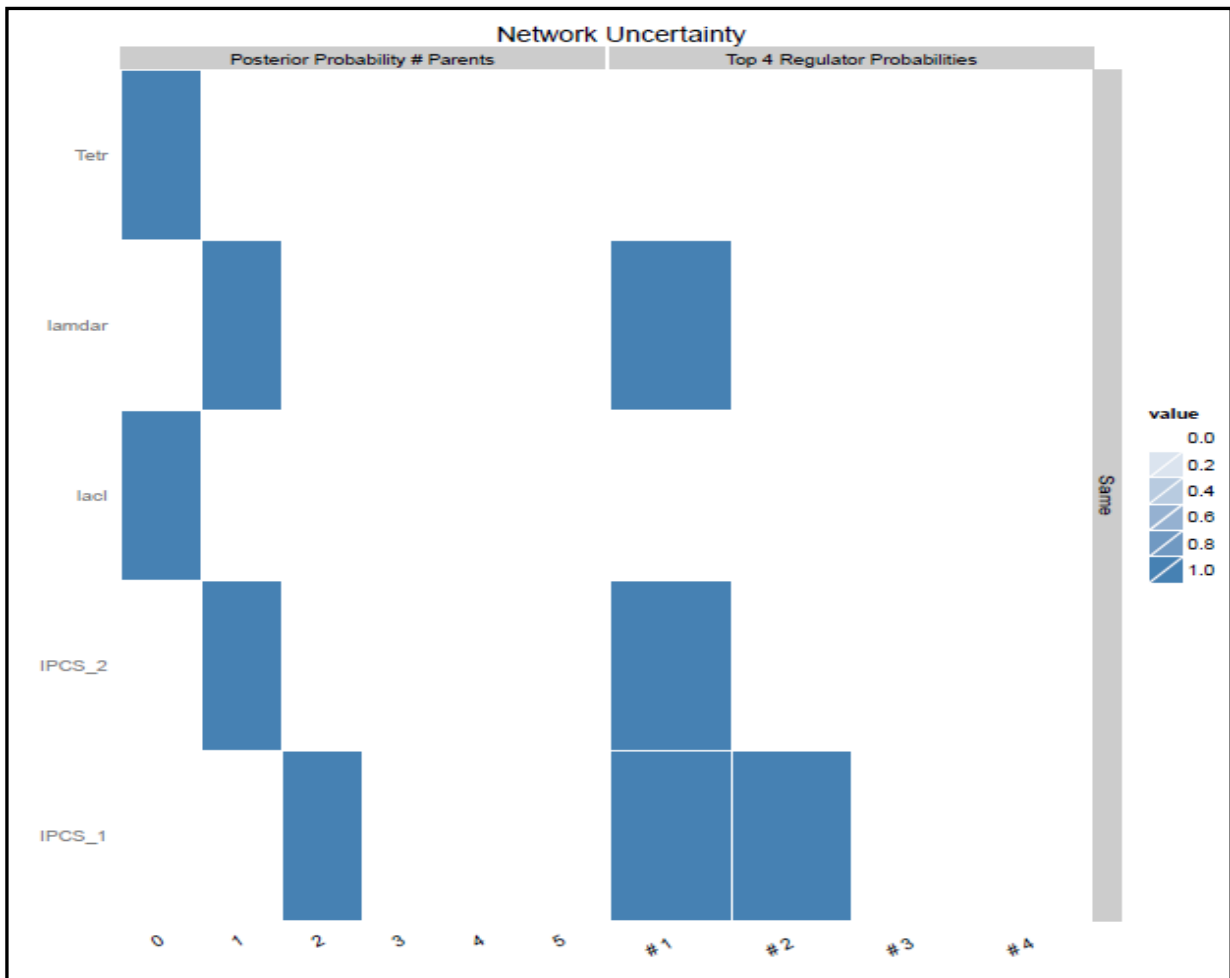

Fig 7.10 Network uncertainty plot

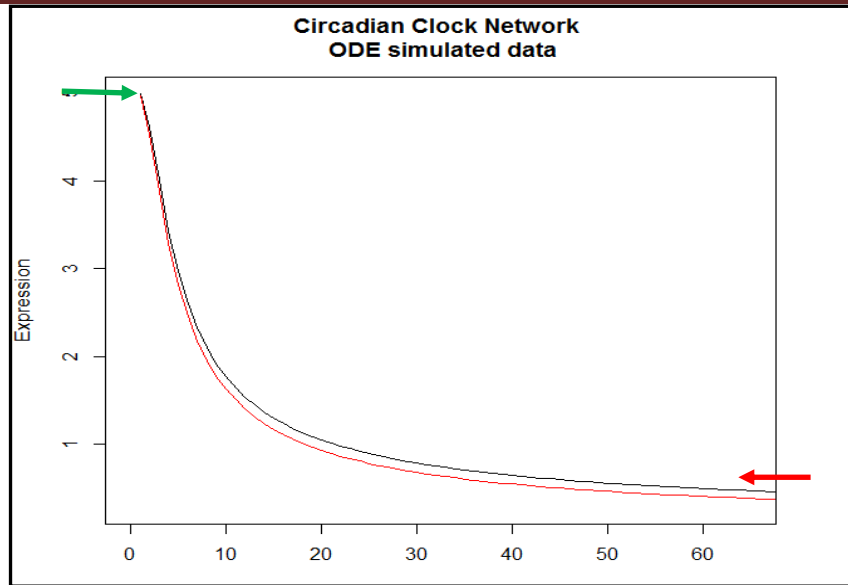

Fig7.11 Circadian clock network generated for IPCS_1 and IPCS_2 suggest the ON and OFF state of both genes. Top right arrow is ON state and bottom left arrow indicates OFF state.

Convergence plots

Basic convergence plots are constructed. The posterior means of each variable are compared.

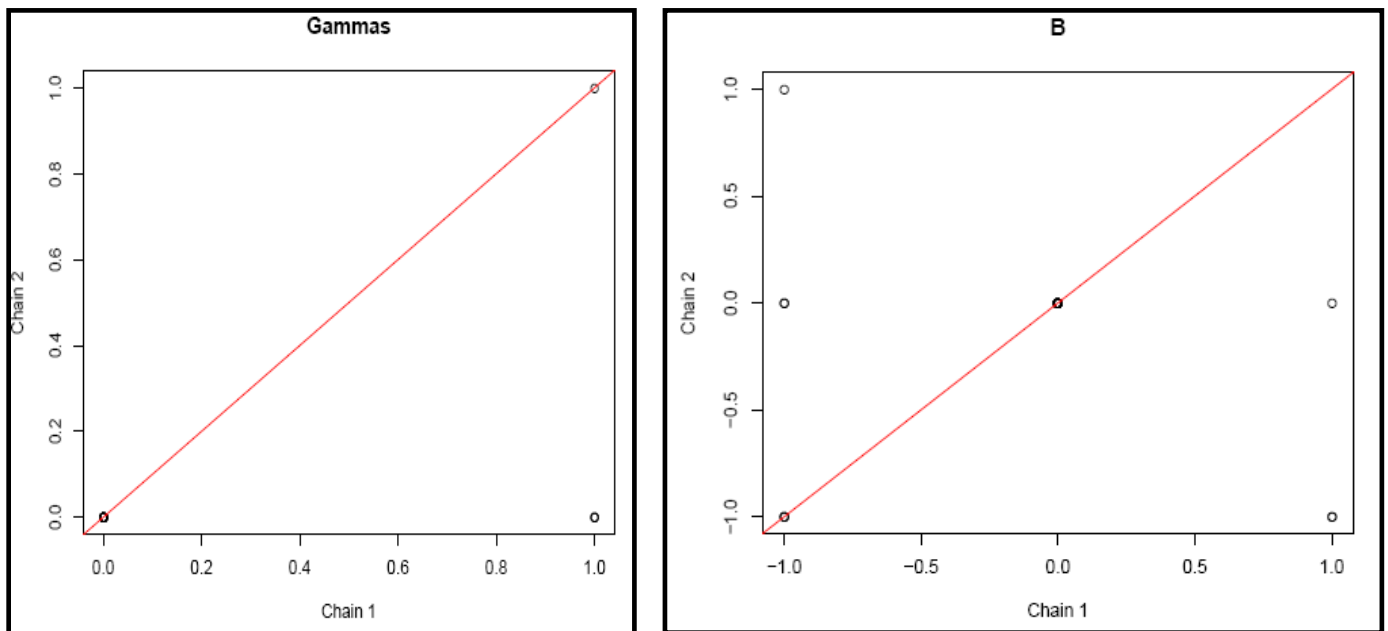
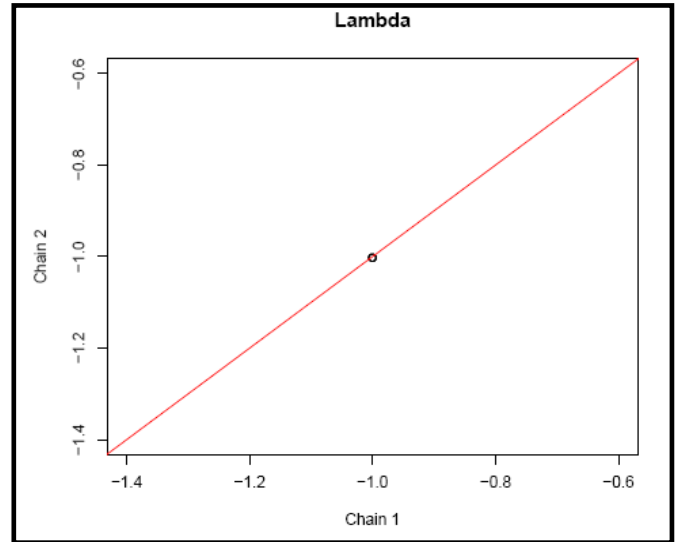
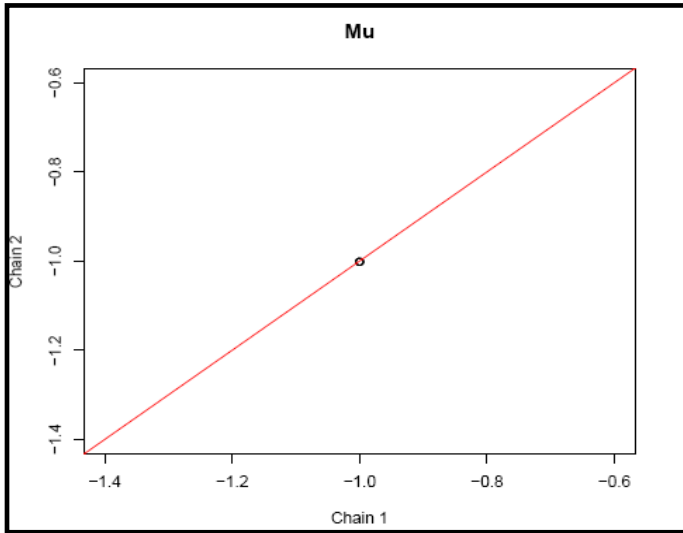

Fig 7.12

- a.) Indicator variable of Gibbs variable selection b.) Co-efficient of linear Regression

Results and Discussion



c.) Precision of each regression

d.) Intercept of each regression

Gamma, B, Lamda, Mu are the variables of the Markov chains generated.

Inferred Network

Network inferred for the genetic circuit constructed for IPCS displays the regulation between each genetic modules used for the construction of the genetic circuit.

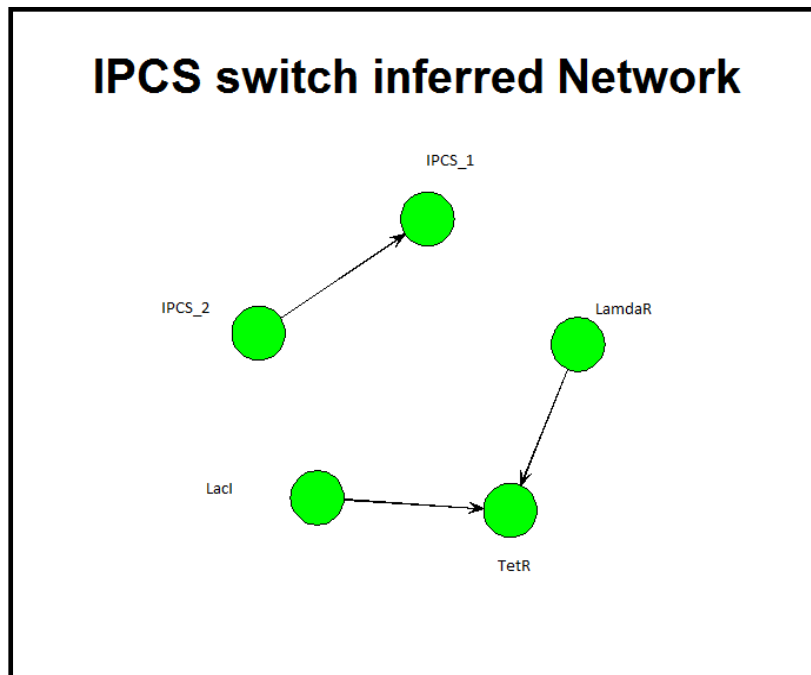

Fig 7.13 Inferred network of the genetic circuit for IPCS

Results and Discussion

In Fig 3.12, inferred network display the regulation between IPCS_1 and IPCS_2 which suggest the switching behavior of the toggle switch. Network inference was made at 10 seconds .As there is no regulation between LacI and IPCS_1 it shows no coupling between genetic toggle switch and repressilator which results into repression of IPCS_2 by IPCS_1 (regulation indicated by edge in the network) Lack of coupling, IPCS_1 is ON and IPCS_2 is OFF.

In Fig 3.13 As there is regulation between LacI and IPCS_1 it shows coupling between genetic toggle switch and repressilator which results into repression of IPCS_1 by LacI. Network inference was made at 100 seconds. Coupling between IPCS_1 and LacI leads to IPCS_1 in OFF state and IPCS_2 in ON state.

Probability derived justifies the design of the circuit that has achieved the design objective in addition to associated parameters that has accounted for the designability of the genetic circuit designed.

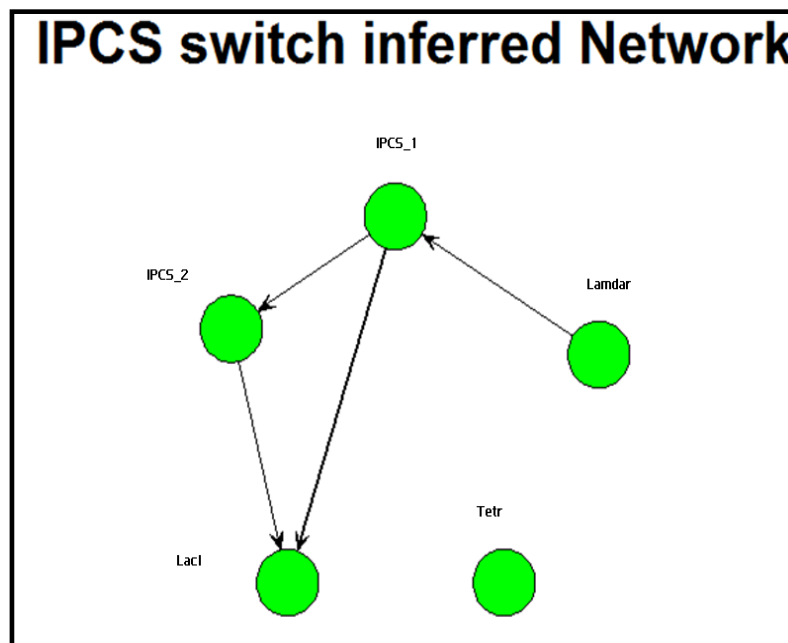

Fig 7.14 Inferred network of the genetic circuit for IPCS

Qualitative network modeling

To test the robustness of the circuit and identification of the number of attractors that circuit exhibit, qualitative Boolean network modeling for genetic circuit is done. After obtaining the

Results and Discussion

steady state of the network, network was perturbed to check the robustness of the circuit. Boolean network for the circuit was constructed using time series. For the construction of Boolean network, binarisation of the time series data was performed.

	x1	x2	x3	x4	x5	x6	x7	x8	x9	x10	x11
Ipcs_1	1	1	1	0	0	0	0	0	0	0	0
Ipcs_2	1	1	1	0	0	0	0	0	0	0	0
Tetr	1	1	1	1	0	0	0	0	0	0	0
LacI	1	0	0	0	0	0	0	0	0	0	0
LamdaR	1	0	0	0	0	0	0	0	0	0	0

Table 7.5 Binarized Time series data

Boolean Network

Boolean network was constructed from the time series data by Best fit algorithm for the construction of the network. Boolean network consist of number of genes involved in network circuit and number of states. Number of states present in Boolean network is given by the equation

$$2^n \quad \text{where } n = \text{no of genes in the network circuit.}$$

Genetic circuit constructed for IPCS has 5 genes, so number states in the network was 32. Boolean network also includes the transition of one state to other.

Results and Discussion

```

Boolean network with 5 genes

Involved genes:

Gene 1 Gene 2 Gene 3 Gene 4 Gene 5

Transition functions:

Gene 1 = <f (Gene 3, Gene 2, Gene 4, Gene 1, Gene 5){11101101101111011111001111110000}>
Gene 2 = <f (Gene 3, Gene 4, Gene 5, Gene 2, Gene 1){00100001000010110100101000101011}>
Gene 3 = <f (Gene 5, Gene 3, Gene 1, Gene 2, Gene 4){10101110001010011000001111000110}>
Gene 4 = <f (Gene 4, Gene 2, Gene 3, Gene 5, Gene 1){11101010011101110011100010000111}>
Gene 5 = <f (Gene 3, Gene 1, Gene 5, Gene 2, Gene 4){00010011000101111110000001111011}>
    
```

Above is the Boolean network of the genetic circuit for IPCS. It has transition function which shows the transition of the genes of the circuit. There are 32 states presented by 1 and 0 that specifies the active and inactive respectively that gives the state of each gene during the transition from one state to another. After transitions of states network circuit attains steady states (attractors). Genetic circuit has two attractors that specifies the bistability of the circuit constructed. The two steady state obtained represent the ON and OFF state for each gene in the circuit. 0 specify the OFF state and 1 specify the ON state.

Attractor 2 is a simple attractor consisting of 2 state(s) and has a basin of 30 state(s):

```

|--<----|
V      |
00111  |
|      |
01111  |
|      |
V      |
    
```

Results and Discussion

|-->----|

Genes are encoded in the following order: Gene 1 Gene 2 Gene 3 Gene 4 Gene 5

Transition of different states to obtain the steady state is represented by the transition table of the states. It also includes the probability for each transition of the state.

State	Next state	Probability
00000 =>	01010	1
00001 =>	10011	1
00010 =>	00111	1
00011 =>	11111	1
00100 =>	11010	1
00101 =>	00011	1
00110 =>	10111	1
00111 =>	01111	1
10101 =>	00011	1
10110 =>	00010	1
10111 =>	01010	1
11000 =>	10111	1
11001 =>	11011	1
11010 =>	11000	1
11011 =>	10000	1
11100 =>	00111	1
11101 =>	01011	1
11110 =>	01010	1

Transition table for the genetic circuit .In the last state the 0 represent the OFF state for IPCS_1 and ON state for IPCS_2 and ON and OFF state for the other genes respectively. This reveals the switching of genetic toggle switch of circuit where IPCS_1 was repressed by IPCS_2 that

Results and Discussion

exhibits OFF and ON state respectively. Attractors of the circuit are represented by the attractor plot which includes ON and OFF state for each gene in the network.

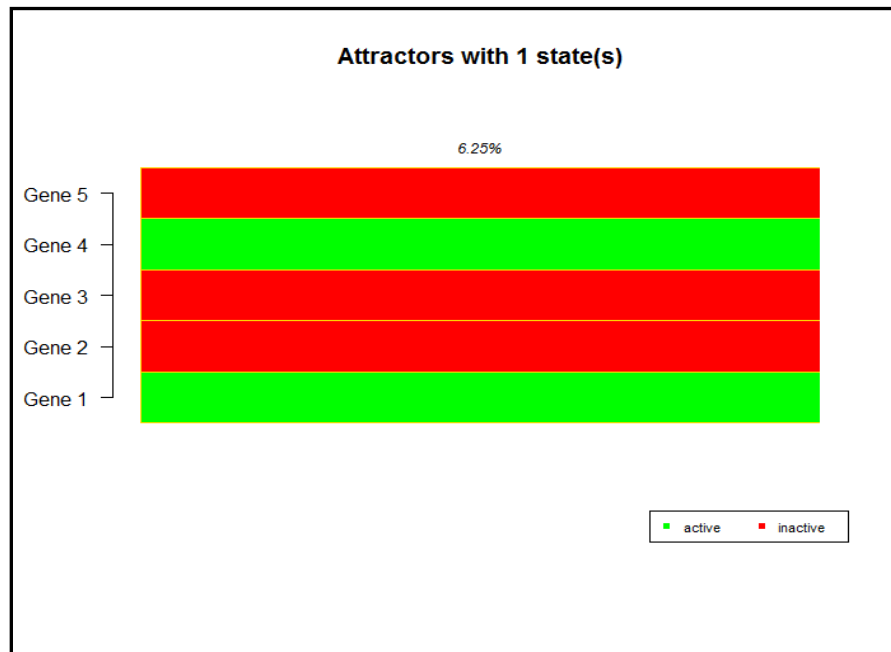

Fig 7.15 Attractor plot for the initial attractor of the network.

Legends

Gene1 - IPCS_1

Gene2 - IPCS_2

Gene3 – LacI

Gene4 – Tetr

Gene5 - LamdaR

In initial state, IPCS_1 is ON i.e. active state and IPCS_2 is OFF i.e. inactive state. LacI is OFF so there is no coupling and that results in the repression of IPCs_2 by IPCS_1. After the transition of the state's two steady states were obtained represented by the attractor plot that justifies the dynamic behavior of the circuit to act as bistable genetic switch.

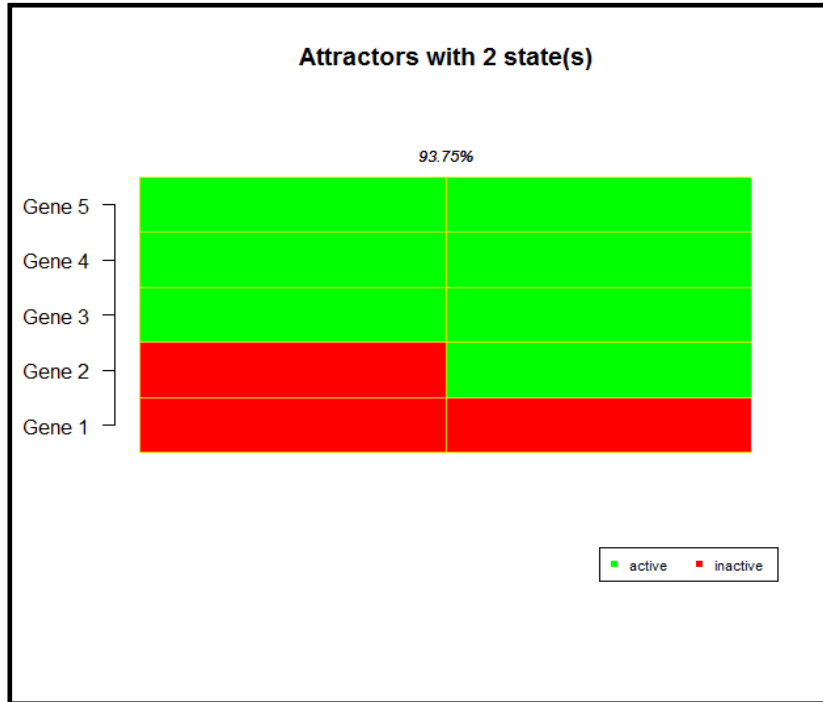

Fig 7.16 Attraction plot of the two steady states

Attraction plot displays the two steady states of the genetic circuit. The percentage to attain the steady states of the circuit is 93.75 % which reflects the robustness of the attractors. Attraction plot represent the OFF state of IPCS_1 and ON state of IPCS_2 which depicts the switching behavior of the circuit as IPCS_2 represses IPCS_1 which was not in the initial state as mentioned in above figure 3.14. Both the attraction plot represents how the circuit toggles between two states where the one represses the other mutually. This is in line with the hypothesis laid with the constructed genetic circuit for IPCS. Visualization of a sequence of states can be represented by the path of attractors plot. The columns of the table represent consecutive states of the time series. The last state is the steady-state attractor of the network. This gives the inactive and active state of each gene at different time series points. Figure 3.16 represent the active and inactive state of each gene that leads to attractor.



Fig 7.17 sequences of path to attractor

Robustness

Perturbation experiments of the network circuit were performed to test the robustness of structural properties of the networks to noise and mismeasurements. The percentage of robustness the biological network was higher than most of the percentages of the random network, this suggests that the biological network circuit constructed exhibits a higher robustness. Figure 3.17 represent the robustness plot for the genetic circuit. The percentage obtained were greater than 50 % which confirms the robustness of the genetic circuit constructed. Network for the genetic circuit was exported to Pajek for the visualization of the transition states in the network. Figure 3.18 represents the transition of different states. Different layout for the network visualization is available at Pajek. Network state graph was visualized using by Kamada-Kawai layout.

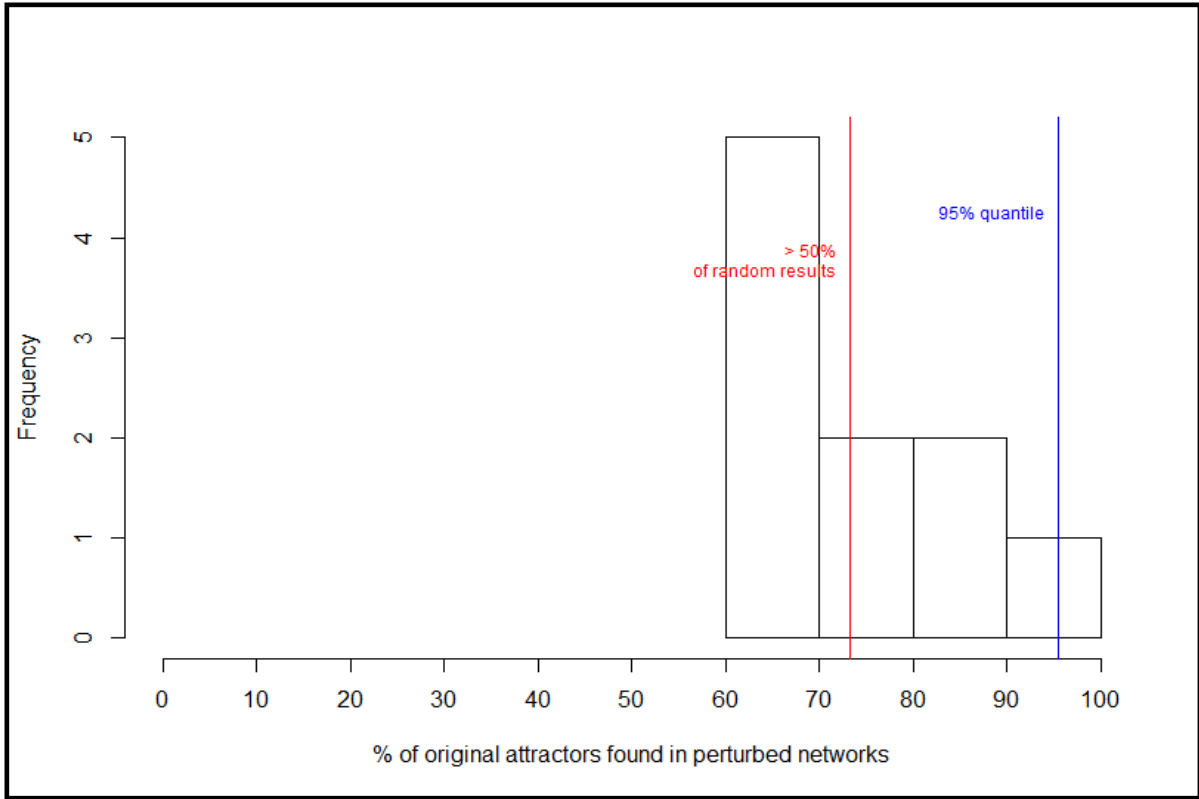

Fig 7.18: Robustness plot of the genetic circuit.

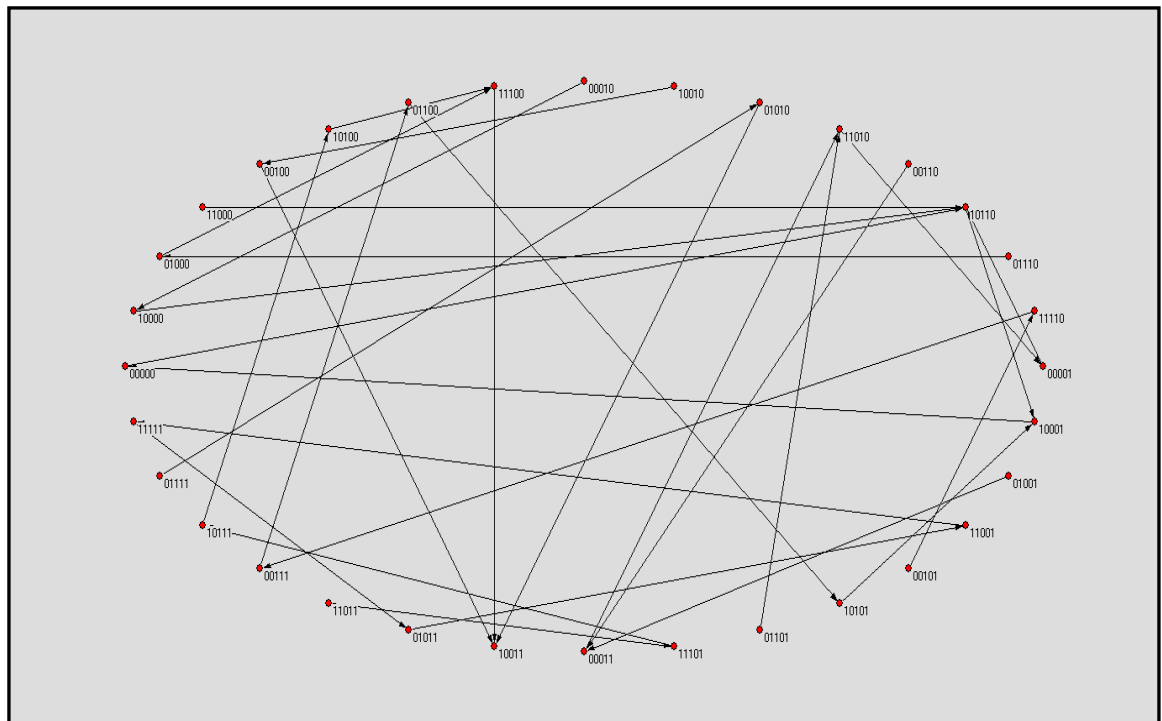

Fig 7.19 State graph of the transition of states

Results and Discussion

Robustness of the circuit and the attractors obtained for the genetic circuit justify the design of the circuit for the IPCS of *L.major*. Genetic circuit designed for the IPCS was subjected to simulation and validated by both qualitative and quantitative approaches. Results revealed the bistability of the genetic circuit and also the hypothesis laid down while designing the genetic circuit was validated.

The recent dramatic increase in the number of studies bridging synthetic and systems biology is driven by the desire to quantitatively engineer and understand biological systems. The precision resulting from this synergy eliminates much of the uncertainty and failure associated with biological design. This allows for more meaningful conclusions to be drawn from experimental studies. The development of models that capture ever-increasing biological complexity will continue to inspire and guide predictive design of living systems at all scales. Moreover, the ability to precisely perturb these systems will further enable high-resolution insight into biological networks. Such advances hold great promise for deciphering the mechanisms underlying development and disease which facilitates the development of versatile, robust, and useful organisms for industrial biotechnology. Systems approaches may aid in the creation of synthetic circuits which was the underlying aim of the current thesis and synthetic constructs may help uncover novel underlying biological control strategies. This may help the design and implementation of new parts such as synthetic probes and parts that can allow for controlled gene expression. The approaches also facilitate how these synthetic devices can create precise perturbations that can be effectively used to probe the cellular function. Collectively, these prospective advances help mitigate the great complexity and uncertainty currently impeding the study and design of synthetic circuits. Collectively, these prospective advances help mitigate the great complexity and uncertainty currently impeding the study and design of synthetic circuits embedded in cellular systems.

References

1. Agarwal G: Towards Logical Designs In Biology (2007) *Resonance Molecular Biophysics University*
2. Albert I *et al.* Boolean network simulations for life scientists.(2008) *Biological Medicine. 3*
3. Becskei A, Seraphim B and Luis Serrano Positive feedback in eukaryotic gene networks: cell differentiation by graded to binary response Conversion. (2001) *The EMBO Journal* **20**, pp :2528 – 2535
4. Cantone I, Marucci L, Francesco Iorio, Maria Aurelia Ricci,1 Vincenzo Belcastro,1 Mukesh Bansal A Yeast Synthetic Network for In Vivo Assessment of Reverse-Engineering and Modeling Approaches,2009 *cell*
5. Carrera J, Carrera G, Alfonso Jaramillo and Santiago F Elena Reverse-engineering the *Arabidopsis thaliana* transcriptional network under changing environmental conditions (2009)*Genome Biology* **10**
6. Chandran D, Frank T Bergmann and Sauro H Tinker Cell: modular CAD tool for synthetic biology *Journal of Biological Engineering* 2009, **3**
7. Chris B, Daniel S, Xia S and Michael P Bayesian design of synthetic biological systems (2006)
8. Chris P. Barnes S,Xia S, and Michael P. H. Stump Bayesian design of synthetic biological systems (2011) *Biophysics and Computational Biology, Statistics* **108**
9. Christine E. Clayton New Embo Member’s Review Life without transcriptional control? From fly to man and back again (2002), *The EMBO Journal* **8**
10. Christoph M, Martin H, Hans K Algorithms and methods of the BoolNet R package (2012)
11. Christoph Müssel, Martin Hopfensitz, Dao Zhou, Hans Kestler Generation, reconstruction, simulation and analysis of synchronous, asynchronous, and probabilistic Boolean networks (2012)
12. D Gonze Coupling oscillations and switches in genetic networks (2010) *Biosystem* **99**
13. Delbruck M. Statistical fluctuations in autocatalytic reactions. (1940) *J Chem Phys* ; **8**: pp 120–124.

14. Denny Paul, Hosam Shams-Eldin, Helen. P. Price Deborah F. Smith and Ralph T. Schwarz the protozoan inositol phosphorylceramide synthase: a novel drug target which defines a new class of sphingolipid synthase *Journal of Biological chemistry* (2007) **281** pp: 28200–28209.
15. Denny Paul, Mark C Field, Deborah F Smith (2001) GPI-anchored proteins and glycoconjugates segregate into lipidrafts in Kinetoplastida *Science direct FEBS letter* **491**
16. Drisdelle R *Leishmania Parasite Life Cycle Microbiology suite* (2007)
17. Drubin D, J Jeffrey C. Way and Pamela A. Silver Designing biological system (2009) *Gene and Development* **21**
18. E, Gregory E, James S. Schwaber and Francis J. Doyle Importance of Input Perturbations and Stochastic Gene Expression in the Reverse Engineering of Genetic Regulatory Networks: Insights From an Identifiability Analysis of an In Silico Network *Genome Res.* **13**: pp: 2396-2405
19. E. Andrianantoandro, S. Basu, D. K. Karig, and R. Weiss, “Synthetic biology: new engineering rules for an emerging discipline,” *Molecular Systems Biology*, vol. **2**, Article ID 2006.0028, 2006.
20. E. L. Haseltine and F. H. Arnold, “Synthetic gene circuits: design with directed evolution,” *Annual Review of Biophysics and Bio molecular Structure*, vol. **36**, pp. 1–19, 2007.
21. Eberhard O. Voit,* Fernando Alvarez-Vasquez and Yusuf A. Hannun Computational Analysis of Sphingolipid Pathway Systems(2010) *Springer Science*
22. Edward R. Morrissey GRENITS: Gene Regulatory Network Inference Using Time Series (2011) *Systems Biology Doctoral Training Centre*
23. Elizabeth P, Isaac L and Kevin T Computational Modeling Approaches for Studying of Synthetic Biological Networks (2008) *Current Bioinformatics* **3**
24. Elmo A, Viviane C, Cardoso F *et al Leishmania amazonensis*: Heme stimulates (Na⁺ + K⁺)ATPase activity via phosphatidylinositol-specific phospholipase C/protein kinase C-like (PI-PLC/PKC) signaling pathways (2009) *Experimental Parasitology* **124**
25. Elowitz M, Leibler S A Synthetic Oscillatory Network of Transcriptional Regulators (2009) *Nature*. **403**, pp-335-8.

26. Elowitz M, Leibler S, A synthetic oscillatory network of transcription regulators (2000), *Nature*, **403**, pp. 335–338
27. Elowitz M.B, Levine A.J., Siggia E.D and P.S Swain: Stochastic gene expression in a single cell (2002). *Science*, **297**: pp1183–86.
28. Elowitz M.B. and Leibler S. A synthetic oscillatory network of transcriptional Regulators. *Nature*, **403**:335–38, 2000.
29. Ernesto A, Subhayu B, David K, Ron W Synthetic biology: new engineering rules for an emerging discipline (2006) *molecular systems biology*
30. Ernesto Andrianantoandro, Subhayu Basu, David K Karig^{1,3} and Ron Weiss Synthetic biology: new engineering rules for an emerging discipline (2006) *Department of Electrical Engineering*
31. F. J. Isaacs, D. J. Dwyer, and J. J. Collins, “RNA synthetic biology,” *Nature Biotechnology*, vol. **24**, no. 5, pp. 545–554, 2006.
32. Farren J. Isaacs, Jeff Hasty, Charles R. Cantor, and J. J. Collins Prediction and measurement of an autoregulatory genetic module (2003) *PNAS* **100**
33. Faure A, Naldi A, Chaouiya C, D. Thieffry (2006), Dynamical analysis of a generic Boolean model for the control of the mammalian cell cycle. *Bioinformatics* **22**: pp-124–e131.
34. Fernando Alvarez-Vasquez, Kellie J. Sims, L. Ashley Cowart, Yasuo Okamoto, Eberhard O. Voit and Yusuf A. Hannun Simulation and validation of modelled sphingolipid metabolism in *Saccharomyces cerevisiae* *Nature* **433**, pp:425-430
35. Gama-Castro S., V. Jimenez-Jacinto, M. Peralta-Gil, A. Santos-Zavaleta, *et al* (2008) RegulonDB (version 6.0): gene regulation model of *Escherichia coli* K-12 beyond transcription, active (experimental) annotated promoters and Textpresso navigation *Nucleic Acids Res*, **36** pp. D120–D124
36. Garg A, Xenarios I, Mendoza L, and Micheli G. Synchronous versus asynchronous modeling of gene regulatory networks. (2008) *Bioinformatics*, **24**(17) pp:1917-1925,
37. Gibson M and Bruck I Efficient exact stochastic simulation of chemical systems with many species and many channels (2000) *Journal of Physical Chemistry*, **104** pp: 1876–1889.

38. Gillespie D T. A general method for numerically simulating the stochastic time evolution of coupled chemical reactions (1976). *Journal Computational Physics*, **22** pp: 403–34.
39. Gupta R., Bhattacharyya A., F.J. Agosto-Perez, P. Wickramasinghe, R.V. Davuluri.(2011) MPromDb an integrated resource for annotation and visualization of mammalian gene promoters and ChIP-seq experimental data *Nucleic Acids Res* **39** pp. D92–D97
40. H Kitano, Biological robustness (2004). *Nature Reviews Genetics*, **5** pp: 826–37.
41. H Kitano, Computational systems biology (2002). *Nature*, **420**: pp 206–10.
42. H Kitano, Systems biology: A brief overview. (2002) *.Science*, **295** pp: 1662–64.
43. Hakomori S Structure and function of sphingoglycolipids in transmembrane signalling and cell–cell interactions (1993) *Biochem. Soc. Trans.*, 21, pp. 583–595
44. Hideki Kobayashi, Mads Kærn, Michihiro Araki, Kristy Chung, Timothy S. Gardner, Charles R. Cantor, and James J. Collins Programmable cells: Interfacing natural and engineered gene networks(2004) *PNAS* **101**
45. Hoops S, Sven Sahle.,Ralph Gauges .,Christine Lee, Jurgen Pahle, Natalia Simus, Mudita Singhal, Liang Xu, Pedro Mendes,Ursula Kummer (2006) COPASI—a COMplex PATHway Simulator *Bioinformatics* **22**
46. Imad H Computational Simulation of Gene Regulatory Networks Implementing an Extendable Synchronous Single-Input Delay Flip-Flop and State Machine (2011)
47. Ines Hamdi, and Mohamed Ben Ahmed The Knowledge Representation of the Genetic Regulatory Networks Based on Ontology (2009) *World Academy of Science, Engineering and Technology*
48. J Zhu, Zhang M.Q. (1999) SCPD: a promoter database of the yeast *Saccharomyces cerevisiae* *Bioinformatics* **15** pp. 607–611
49. James D. Bangs, and Stephen M. Beverley Kai Zhang, (2011) Sphingolipid in parasitic protozoa *Adv Exp Med Biol.* 688. pp 238–248
50. Jeff Hasty, Farren I, Milos D, David M, and James C Designer gene networks: Towards fundamental cellular control (2000) *Molecular, metabolic, and genetic control* **11**
51. Joseph J. Allaire, Rstudio Inc, The R Project for Statistical Computing.htm (2011) *The R Foundation for Statistical Computing*

52. Kærn M, T Elston, William J and Collins J. Stochasticity in gene expression: from theories to phenotypes (2005). *Nature Reviews Genetics*, **6** pp: 451–64.
53. Karlebach G and Shamir R .Modeling and analysis of gene regulatory networks. *Nature Reviews Molecular Cell Biology*, **9**:770–80, 2008.
54. Kauman S. The Origins of Order: Self-Organization and Selection in Evolution.(1993) *Oxford University Press*.
55. Kaye P and Scott P, Leishmaniasis: complexity at the host–pathogen interface (2011) *Nature Reviews Microbiology* **9**, pp: 604-615
56. Kaye P., Scott P (2011).Leishmaniasis: complexity at the host–pathogen interface *Nature Reviews Microbiology* **9**.
57. Klamt S, *et al* Structural and functional analysis of cellular networks with cellNetAnalyzer (2007). *BMC Systems Biology* **3**
58. Koide T, Wyming L, and Baliga N The role of predictive modeling in rationally re-engineering biological systems (2009) *Nat Rev Microbiol* **7**
59. Koide T,W Lee Pang and Baliga N. The role of predictive modeling in rationally re-engineering biological systems (2009) *Nat Rev Microbiol.* **7** pp: 297–305.
60. Lahdesmaki *et al.* On learning gene regulatory networks under the Boolean network model (2003) *.Machine Learning.* **52** pp: 147-167.
61. Lanza M. Crook C. Alper S (2012) Innovation at the intersection of synthetic and systems biology *Current Opinion in Biotechnology*
62. Lena J. Heung, Chiara Luberto and Maurizio Del Poeta, Role of Sphingolipids in Microbial Pathogenesis (2006) *Infection and Immunity* **74**
63. Locke, J.C.W., Kozma-Bognar, L., Gould, P.D., Feher, B., Kevei, E., Nagy, F., Turner, M.S., Hall, A. and Millar, A.J. (2006) Experimental validation of a predicted feedback loop in the multi-oscillator clock of *Arabidopsis thaliana*. *Molecular Systems Biology*
64. Locke, J.C.W., Kozma-Bognar, L., Gould, P.D., Feher, B., Kevei, E., Nagy, F., Turner, M.S., Hall, A and Millar, A.J. (2006) Experimental validation of a predicted feedback loop in the multi-oscillator clock of *Arabidopsis thaliana*. *Molecular Systems Biology*
65. Long T, Q Ouyang and C. Tang. (2004) .The yeast cell-cycle network is robustly designed. *PNAS*, **101**: pp4781-4786, 2004.

66. Luca C Simulation and Analysis of Chemical Reactions using Stochastic Differential Equations (2007)
67. Lucio H. Freitas-Junior, Eric Chatelain, Helena Andrade Kim Jair L. Siqueira-N (2012). Leishmaniasis treatment: What do we have, what do we need and how to deliver it? *International Journal for Parasitology: Drugs and Drug Resistance* **2**,
68. M. Heinemann and S. Panke, “Synthetic biology—putting engineering into biology,” *Bioinformatics*, vol. **22**, no. 22, pp. 2790–2799, 2006.
69. Mair H Shi, H Li, A Djikeng, H O Aviles, J R Bishop, F H Falcone, C Gavrilescu, J L Montgomery, M I Santori, L S Stern, Z Wang, E Ullu, and C Tschudi, A new twist in trypanosome RNA metabolism: cis-splicing of pre-mRNA.(2000)*G RNA* **6**
70. Mario A M, Jorg S Computational design tools for synthetic biology (2009) *Current Opinion in Biotechnology* **20**
71. Mario A. Marchisio, Jorg Stelling Automatic Design of Digital Synthetic Gene Circuits (2011) *Computational Biology* **7**
72. Mitra A., Kesarwani A.K. D. Pal, V. Nagaraja WebGeSTer DB – a transcription terminator database (2011) *Nucleic Acids Res*, **39**, pp. D129–D135
73. Morrissey R, Juarez M.A, Denby, K.J. and Burroughs N J. On reverse engineering of gene interaction networks using time course data with repeated measurements. 2010 *Bioinformatics* **421**
74. Morrissey, E.R., Juarez, M.A., Denby, K.J. and Burroughs, N.J. 2011 Inferring the time-invariant
75. Mussel C, Hopfensitz M and Hans A. Kestler BoolNet—an R package for generation, reconstruction and analysis of Boolean networks
76. Nam-phuong D. Nguyen Design and analysis of genetic circuits (2000) *The University of Utah*
77. Nam-Phuong D. Nguyen, Nathan Barker, Hiroyuki Kuwahara, Curtis Madsen, Chris J. Myers Synthesis of Genetic Circuits from Graphical Specifications
78. Needham C Learning gene regulatory networks in Arabidopsis Thaliana author: University of Leeds (2007)
79. Ongabaugh W *et al.* Computational representation of developmental genetic regulatory networks. *Developmental biology*; **283** pp: 1-16.



80. P.W. Denny, D. Goulding, M.A. Ferguson, D.F. Smith Sphingolipid-free *Leishmania* are defective in membrane trafficking, differentiation and infectivity (2004), *Mol. Microbiol.*, 52 pp. 313–327
81. P.W. Denny, D.F. Smith Rafts and sphingolipid biosynthesis in the kinetoplastid parasitic protozoa *Mol. Microbiol.*, 53 (2004), pp. 725–733
82. Peters, W. & Killick-Kendrick (1987). **The Leishmaniases in Biology and Medicine**, London:Academic Press, 2
83. Portales-Casamar E., S. Thongjuea, A.T. Kwon, D. Arenillas, X.B. Zhao, E. Valen *et al* JASPAR 2010: the greatly expanded open-access database of transcription factor binding profiles (2010) *Nucleic Acids Res* 38 pp. D105–D110
84. Ralton J, Mullin K, McConville M Intracellular trafficking of glycosylphosphatidylinositol (GPI)-anchored proteins and free GPIs in *Leishmania mexicana* (2002), *Biochem. J.*, 363 pp. 365–375
85. S Hagen Johansen Modeling and Analysis of a Synthetic Bistable Genetic Switch (2011) *Department of Biotechnology Master thesis pp: 12-15*
86. S Ramsey, D Orrell and Bolouri H. (2002) Dizzy: stochastic simulation of large-scale genetic regulatory networks. *Journal of Bioinformatics and Computational Biology*, 3 pp: 415–36.
87. S. Ramsey, D. Orrell, and H. Boulouri. Dizzy: Stochastic simulation of large-scale genetic regulatory networks (2005). *Journal of Bioinformatics and Computational Biology*, 3(2):415–436
88. -Calvillo: Shaofeng Yan, Dan Nguyen, Mark Fox, Kenneth Stuart, Peter J Myler Transcription of *Leishmania major* Friedlin Chromosome 1 Initiates in Both Directions within a Single Region(2003)., *Molecular cell* 11 pp: 1291–1299
89. Shankar M, O Alexander van Synthetic biology: understanding biological design from synthetic circuits (2009) *Nature Reviews Genetics* 10, pp- 859-871
90. Shmulevich I, Edward R. Dougherty, and Wei Zhang From Boolean to Probabilistic Boolean Networks as Models of Genetic Regulatory Networks (2002) *PROCEEDINGS OF THE IEEE* 90

91. Simons K, Toomre D Lipidrafts and signal transduction (2001), *Nat. Rev., Mol. Cell Biol.*, 1 pp. 31–39
92. Singh B, Costello C, Beach D, Holz G Characterization of glycosyl phosphatidylinositol lipids of parasitic protozoans: *Leishmania mexicana mexicana* promastigotes, *Trypanosoma cruzi* Peru epimastigotes and *Tritrichomonas foetus* (1990) *Indian J Biochem Biophys* **27**.
93. Stephen E, John G An introduction to R for dynamic models in biology (2011)
94. Suzuki E, Ameria K. Tanaka, Marcos S. Toledo, B. Levery, Anita H. Straus, Helio K. Takahashi, Trypanosomatid and fungal glycolipids and sphingolipids as infectivity factors and potential targets for development of new therapeutic strategies (2008), *Biochimica et Biophysica Acta (BBA) - General Subjects* 1780 pp: 362–369
95. Takahashi H, Straus A Glyco(sphingo)lipid antigens of *Leishmania*. Possible biological role (1997) *Mem. Inst.* 92, pp. 46–48
96. Timothy S. Gardner Reverse-engineering transcription control networks (2006) *Physics of Life Reviews* **2**, Issue 1, pp: 65–88
97. Timothy S. Gardner, Charles R. Cantor & James J. Collins .Construction of a genetic toggle switch in *Escherichia coli* (2000) *Nature* 403, pp-339-342
98. Travis S Bayer & Christina D Smolke Programmable ligand-controlled riboregulators of eukaryotic gene expression (2005) *Nature Biotechnology* 23, 337 - 343
99. V Lila Koumandou, Senthil Kumar A Natesan, Tatiana Sergeenko and Mark C Field The trypanosome transcriptome is remodelled during differentiation but displays limited responsiveness within life stages (2000) *BMC Genomics* **9**
100. V. Batagelj, A. Mrvar: Pajek - Analysis and Visualization of Large Networks. (2003) *Graph Drawing Software. Springer.* pp. 77-103
101. Werner Sandmann and Christian Maier On The Statistical Accuracy Of Stochastic Simulation Algorithms Implemented In Dizzy *University of Bamberg*
102. Wickstead B, Klaus E and Keith Gull Repetitive Elements in Genomes of Parasitic Protozoan (2003) *Microbiol. Mol. Biol. Rev* **67**
103. www.karnaugh.html (2011) Composed by David Belton

- 104.** Yamamoto Y.Y., Obokata J. (2008) ppdb: a plant promoter database *Nucleic Acids Res* 36 pp. D977–D981
- 105.** Yoneyama K, Tanaka, T Silveira, H Takahashi, A Straus Characterization of *Leishmania braziliensis* membrane microdomains, and their role in macrophage infectivity (2006), *J. Lipid Res.*, 47 pp. 2171–2178

In order to understand the functioning of organisms on the molecular level, we need to know which genes are expressed, when and where in the organism, and to which extent. The regulation of gene expression is achieved through genetic regulatory systems structured by networks of interactions between DNA, RNA, proteins, and small molecules. As most genetic regulatory networks of interest involve many components connected through interlocking positive and negative feedback loops, an intuitive understanding of their dynamics is hard to obtain. Building circuits and studying their behavior in cells is a major goal of synthetic biology in order to evolve a deeper understanding of biological design principles from the bottom up. Collectively, these developments enable the precise control of cellular state for systems studies and the discovery of novel parts, control strategies, and interactions for the design of robust synthetic function. As a consequence, formal methods and computer tools for the modeling and simulation of genetic regulatory networks (genetic circuits) will be indispensable. There are reports and evidences for the synthetic circuit in prokaryotes and eukaryotes like *E.coli* and yeast systems but to the best of my knowledge there are no reports in the literature suggesting the synthetic circuit construction for protozoan parasites. The project serves to the first attempt made to use synthetic biology approach for the construction of genetic circuit for the protozoan parasite *Leishmania*. *Leishmania* is protozoan parasite responsible for the diseases Leishmaniasis. In spite of many therapeutic approaches exist for this diseases, there is no cure for the diseases. Severity of these lesions are widely distributed all over the world especially non tropical regions of the world. This project reviews formalisms that have been employed in mathematical biology and bioinformatics, synthetic biology to describe genetic regulatory systems, in particular a directed graphs, Bayesian networks, In addition, it discusses how these formalisms have been used in the simulation of the behavior of actual regulatory systems. This project aims to construct the genetic circuit for IPCS in *L.major*, simulation and validation. Genetic circuit was constructed using Tinker cell. Genetic circuit was simulated by using Tauleap stochastic simulation simulation was followed by circuit validation using qualitative and quantitative analysis methods. Qualitative was done by using Boolean method and quantitative was done by using Bayesian method with the aid of ODE of the constructed genetic circuit for IPCS. Qualitative analysis gives hints as to which parameters offer the best success in achieving a desired behavior or whether a certain design can exhibit the wanted function at all. Genetic circuit constructed for IPCS was converted into digital circuit by using Karnaugh map representation of the truth table

for the logic circuit deciphered for the constructed genetic circuit. Genetic circuit constructed and validated may be used as research tool for the protozoan parasite. Genetic circuit for IPCS can be used as therapeutic tool for the Leishmaniasis.

Supplementary file

Genetic circuit constructed for the IPCS of *L.major*. SBML format of the circuit constructed using Tinker cell.

```
<?xml version="1.0" encoding="UTF-8"?>
<sbml xmlns="http://www.sbml.org/sbml/level2" level="2" version="1">
  <model id="repressiblepromotermodel_TIC" name="repressiblepromotermodel.TIC">
    <listOfCompartments>
      <compartment id="DefaultCompartment" name="DefaultCompartment" size="1"
constant="true"/>
    </listOfCompartments>
    <listOfSpecies>
      <species id="IPCS1protein" name="IPCS1protein" compartment="DefaultCompartment"
initialConcentration="0.05" hasOnlySubstanceUnits="false" boundaryCondition="false"
constant="false"/>
      <species id="IPCS2protein" name="IPCS2protein" compartment="DefaultCompartment"
initialConcentration="0.05" hasOnlySubstanceUnits="false" boundaryCondition="false"
constant="false"/>
      <species id="IPCS_1" name="IPCS_1" compartment="DefaultCompartment"
initialConcentration="10" hasOnlySubstanceUnits="false" boundaryCondition="true"
constant="false"/>
      <species id="IPCS_2" name="IPCS_2" compartment="DefaultCompartment"
initialConcentration="10" hasOnlySubstanceUnits="false" boundaryCondition="true"
constant="false"/>
      <species id="TetrRepressor" name="TetrRepressor"
compartment="DefaultCompartment" initialConcentration="0.1"
hasOnlySubstanceUnits="false" boundaryCondition="false" constant="false"/>
      <species id="Tetrgene" name="Tetrgene" compartment="DefaultCompartment"
initialConcentration="10" hasOnlySubstanceUnits="false" boundaryCondition="true"
constant="false"/>
      <species id="lacI" name="lacI" compartment="DefaultCompartment"
initialConcentration="10" hasOnlySubstanceUnits="false" boundaryCondition="false"
constant="false"/>
```

```
<species id="lactoserepressor" name="lactoserepressor"
compartment="DefaultCompartment" initialConcentration="0.05"
hasOnlySubstanceUnits="false" boundaryCondition="false" constant="false"/>
```

```
<species id="lamdar" name="lamdar" compartment="DefaultCompartment"
initialConcentration="10" hasOnlySubstanceUnits="false" boundaryCondition="true"
constant="false"/>
```

```
<species id="lamdarepressor" name="lamdarepressor"
compartment="DefaultCompartment" initialConcentration="0.05"
hasOnlySubstanceUnits="false" boundaryCondition="false" constant="false"/>
```

```
<species id="rp1" name="rp1" compartment="DefaultCompartment"
initialConcentration="10" hasOnlySubstanceUnits="false" boundaryCondition="true"
constant="false"/>
```

```
<species id="rp2" name="rp2" compartment="DefaultCompartment"
initialConcentration="10" hasOnlySubstanceUnits="false" boundaryCondition="true"
constant="false"/>
```

```
<species id="rp3" name="rp3" compartment="DefaultCompartment"
initialConcentration="10" hasOnlySubstanceUnits="false" boundaryCondition="true"
constant="false"/>
```

```
<species id="rp4" name="rp4" compartment="DefaultCompartment"
initialConcentration="10" hasOnlySubstanceUnits="false" boundaryCondition="true"
constant="false"/>
```

```
<species id="rp5" name="rp5" compartment="DefaultCompartment"
initialConcentration="10" hasOnlySubstanceUnits="false" boundaryCondition="true"
constant="false"/>
```

```
<species id="rs1" name="rs1" compartment="DefaultCompartment"
initialConcentration="10" hasOnlySubstanceUnits="false" boundaryCondition="true"
constant="false"/>
```

```
</listOfSpecies>
```

```
<listOfParameters>
```

```
<parameter id="rp1_strength" name="rp1_strength" value="5" constant="true"/>
```

```
<parameter id="rp2_strength" name="rp2_strength" value="5" constant="true"/>
```

```
<parameter id="rp3_strength" name="rp3_strength" value="5" constant="true"/>
```

```
<parameter id="rp4_strength" name="rp4_strength" value="5" constant="true"/>
```

```
<parameter id="rp5_strength" name="rp5_strength" value="5" constant="true"/>
```

```
<parameter id="TetrRepressor_degradation_rate"
name="TetrRepressor_degradation_rate" value="0.5" constant="true"/>
```

```
<parameter id="IPCS1protein_degradation_rate" name="IPCS1protein_degradation_rate"
value="0.1" constant="true"/>
```

```
<parameter id="tr1_Kd" name="tr1_Kd" value="1" constant="true"/>
```

```
<parameter id="tr1_h" name="tr1_h" value="2" constant="true"/>
```

```
<parameter id="tr2_Kd" name="tr2_Kd" value="1" constant="true"/>
```

```
<parameter id="tr2_h" name="tr2_h" value="2" constant="true"/>
```

```
<parameter id="tr3_Kd" name="tr3_Kd" value="1" constant="true"/>
```

```
<parameter id="tr3_h" name="tr3_h" value="2" constant="true"/>
```

```
<parameter id="tr4_Kd" name="tr4_Kd" value="1" constant="true"/>
```

```
<parameter id="tr4_h" name="tr4_h" value="2" constant="true"/>
```

```
<parameter id="tr5_Kd" name="tr5_Kd" value="1" constant="true"/>
```

```
<parameter id="tr5_h" name="tr5_h" value="2" constant="true"/>
```

```
<parameter id="tr6_Kd" name="tr6_Kd" value="1" constant="true"/>
```

```
<parameter id="tr6_h" name="tr6_h" value="2" constant="true"/>
```

```
<parameter id="pp1_translation_rate" name="pp1_translation_rate" value="1"
constant="true"/>
```

```
<parameter id="pp2_translation_rate" name="pp2_translation_rate" value="1"
constant="true"/>
```

```
<parameter id="pp3_translation_rate" name="pp3_translation_rate" value="1"
constant="true"/>
```

```
<parameter id="pp4_translation_rate" name="pp4_translation_rate" value="1"
constant="true"/>
```

```
<parameter id="pp5_translation_rate" name="pp5_translation_rate" value="1"
constant="true"/>
```

```
<parameter id="IPCS2protein_degradation_rate" name="IPCS2protein_degradation_rate"
value="0.1" constant="true"/>
```

```
<parameter id="lamdarepressor_degradation_rate"
name="lamdarepressor_degradation_rate" value="0.1" constant="true"/>
```

```
<parameter id="lactoserepressor_degradation_rate"
name="lactoserepressor_degradation_rate" value="0.1" constant="true"/>
```

```
</listOfParameters>
```

```
<listOfRules>
```

```
<assignmentRule variable="rp1">
```

```
<math xmlns="http://www.w3.org/1998/Math/MathML">
```

```
<apply>
```

```
<divide/>
```

```
<cn> 1 </cn>
```

```
<apply>
```

```
<plus/>
```

```
<cn type="integer"> 1 </cn>
```

```
<apply>
```

```
<power/>
```

```
<apply>
```

```
<divide/>
```

```
<ci> IPCS2protein </ci>
```

```
<ci> tr2_Kd </ci>
```

```
</apply>
```

```
<ci> tr2_h </ci>
```

```
</apply>
```

```
</apply>
```

```
</apply>
```

```
</math>
```

```
</assignmentRule>
```

```
<assignmentRule variable="rp2">
```

```
<math xmlns="http://www.w3.org/1998/Math/MathML">
```

```
<apply>
  <divide/>
  <cn> 1 </cn>
</apply>
<plus/>
<cn type="integer"> 1 </cn>
</apply>
<power/>
<apply>
  <divide/>
  <ci> IPCS1protein </ci>
  <ci> tr1_Kd </ci>
</apply>
<ci> tr1_h </ci>
</apply>
</apply>
</apply>
</math>
</assignmentRule>
<assignmentRule variable="rp3">
  <math xmlns="http://www.w3.org/1998/Math/MathML">
    <apply>
      <divide/>
      <cn> 1 </cn>
    </apply>
    <plus/>
    <cn type="integer"> 1 </cn>
```

```
<apply>
  <power/>
  <apply>
    <divide/>
    <ci> lamdarepressor </ci>
    <ci> tr5_Kd </ci>
  </apply>
  <ci> tr5_h </ci>
</apply>
</apply>
</apply>
</math>
</assignmentRule>
<assignmentRule variable="rp4">
  <math xmlns="http://www.w3.org/1998/Math/MathML">
    <apply>
      <divide/>
      <cn> 1 </cn>
      <apply>
        <plus/>
        <cn type="integer"> 1 </cn>
      </apply>
      <power/>
      <apply>
        <divide/>
        <ci> lactoserepressor </ci>
        <ci> tr3_Kd </ci>
```

```
</apply>
<ci> tr3_h </ci>
</apply>
</apply>
</apply>
</math>
</assignmentRule>
<assignmentRule variable="rp5">
<math xmlns="http://www.w3.org/1998/Math/MathML">
<apply>
<divide/>
<cn> 1 </cn>
<apply>
<plus/>
<cn type="integer"> 1 </cn>
<apply>
<power/>
<apply>
<divide/>
<ci> TetrRepressor </ci>
<ci> tr4_Kd </ci>
</apply>
<ci> tr4_h </ci>
</apply>
</apply>
</apply>
</math>
```

```
</assignmentRule>
<assignmentRule variable="Tetrgene">
  <math xmlns="http://www.w3.org/1998/Math/MathML">
    <apply>
      <times/>
      <ci> rp4_strength </ci>
      <ci> rp4 </ci>
    </apply>
  </math>
</assignmentRule>
<assignmentRule variable="rs1">
  <math xmlns="http://www.w3.org/1998/Math/MathML">
    <apply>
      <divide/>
      <cn> 1 </cn>
      <apply>
        <plus/>
        <cn type="integer"> 1 </cn>
        <apply>
          <power/>
          <apply>
            <divide/>
            <ci> lactoserepressor </ci>
            <ci> tr6_Kd </ci>
          </apply>
          <ci> tr6_h </ci>
        </apply>
      </apply>
    </apply>
  </math>
```

```
</apply>
</apply>
</math>
</assignmentRule>
<assignmentRule variable="IPCS_1">
  <math xmlns="http://www.w3.org/1998/Math/MathML">
    <apply>
      <times/>
      <ci> rp1_strength </ci>
      <ci> rp1 </ci>
    </apply>
  </math>
</assignmentRule>
<assignmentRule variable="IPCS_2">
  <math xmlns="http://www.w3.org/1998/Math/MathML">
    <apply>
      <times/>
      <ci> rp2_strength </ci>
      <ci> rp2 </ci>
    </apply>
  </math>
</assignmentRule>
<assignmentRule variable="lamdar">
  <math xmlns="http://www.w3.org/1998/Math/MathML">
    <apply>
      <times/>
      <ci> rp5_strength </ci>
```

```
<ci> rp5 </ci>
</apply>
</math>
</assignmentRule>
</listOfRules>
<listOfReactions>
<reaction id="pp1_v1" name="pp1_v1" reversible="false" fast="false">
<listOfProducts>
<speciesReference species="IPCS1protein" stoichiometry="1"/>
</listOfProducts>
<listOfModifiers>
<modifierSpeciesReference species="IPCS_1"/>
</listOfModifiers>
<kineticLaw>
<math xmlns="http://www.w3.org/1998/Math/MathML">
<apply>
<times/>
<ci> pp1_translation_rate </ci>
<ci> rp1_strength </ci>
<ci> IPCS_1 </ci>
</apply>
</math>
</kineticLaw>
</reaction>
<reaction id="pp1_v2" name="pp1_v2" reversible="false" fast="false">
<listOfReactants>
<speciesReference species="IPCS1protein" stoichiometry="1"/>
```

```
</listOfReactants>
<kineticLaw>
  <math xmlns="http://www.w3.org/1998/Math/MathML">
    <apply>
      <times/>
      <ci> IPCS1protein_degradation_rate </ci>
      <ci> IPCS1protein </ci>
    </apply>
  </math>
</kineticLaw>
</reaction>
<reaction id="pp2_v1" name="pp2_v1" reversible="false" fast="false">
  <listOfProducts>
    <speciesReference species="IPCS2protein" stoichiometry="1"/>
  </listOfProducts>
  <listOfModifiers>
    <modifierSpeciesReference species="IPCS_2"/>
  </listOfModifiers>
  <kineticLaw>
    <math xmlns="http://www.w3.org/1998/Math/MathML">
      <apply>
        <times/>
        <ci> pp2_translation_rate </ci>
        <ci> rp2_strength </ci>
        <ci> IPCS_2 </ci>
      </apply>
    </math>
```

```
</kineticLaw>
</reaction>
<reaction id="pp2_v2" name="pp2_v2" reversible="false" fast="false">
  <listOfReactants>
    <speciesReference species="IPCS2protein" stoichiometry="1"/>
  </listOfReactants>
  <kineticLaw>
    <math xmlns="http://www.w3.org/1998/Math/MathML">
      <apply>
        <times/>
        <ci> IPCS2protein_degradation_rate </ci>
        <ci> IPCS2protein </ci>
      </apply>
    </math>
  </kineticLaw>
</reaction>
<reaction id="pp3_v1" name="pp3_v1" reversible="false" fast="false">
  <listOfProducts>
    <speciesReference species="lactoserepressor" stoichiometry="1"/>
  </listOfProducts>
  <listOfModifiers>
    <modifierSpeciesReference species="lacI"/>
  </listOfModifiers>
  <kineticLaw>
    <math xmlns="http://www.w3.org/1998/Math/MathML">
      <apply>
        <times/>
```



```
<ci> pp3_translation_rate </ci>
<ci> rp3_strength </ci>
<ci> lacI </ci>
</apply>
</math>
</kineticLaw>
</reaction>
<reaction id="pp3_v2" name="pp3_v2" reversible="false" fast="false">
<listOfReactants>
<speciesReference species="lactoserepressor" stoichiometry="1"/>
</listOfReactants>
<kineticLaw>
<math xmlns="http://www.w3.org/1998/Math/MathML">
<apply>
<times/>
<ci> lactoserepressor_degradation_rate </ci>
<ci> lactoserepressor </ci>
</apply>
</math>
</kineticLaw>
</reaction>
<reaction id="pp4_v1" name="pp4_v1" reversible="false" fast="false">
<listOfProducts>
<speciesReference species="TetrRepressor" stoichiometry="1"/>
</listOfProducts>
<listOfModifiers>
<modifierSpeciesReference species="Tetrgene"/>
```

```
</listOfModifiers>
<kineticLaw>
  <math xmlns="http://www.w3.org/1998/Math/MathML">
    <apply>
      <times/>
      <ci> pp4_translation_rate </ci>
      <cn> 1 </cn>
      <ci> TetrGene </ci>
    </apply>
  </math>
</kineticLaw>
</reaction>
<reaction id="pp4_v2" name="pp4_v2" reversible="false" fast="false">
  <listOfReactants>
    <speciesReference species="TetrRepressor" stoichiometry="1"/>
  </listOfReactants>
  <kineticLaw>
    <math xmlns="http://www.w3.org/1998/Math/MathML">
      <apply>
        <times/>
        <ci> TetrRepressor_degradation_rate </ci>
        <ci> TetrRepressor </ci>
      </apply>
    </math>
  </kineticLaw>
</reaction>
<reaction id="pp5_v1" name="pp5_v1" reversible="false" fast="false">
```

```
<listOfProducts>
  <speciesReference species="lamdarepressor" stoichiometry="1"/>
</listOfProducts>
<listOfModifiers>
  <modifierSpeciesReference species="lamdar"/>
</listOfModifiers>
<kineticLaw>
  <math xmlns="http://www.w3.org/1998/Math/MathML">
    <apply>
      <times/>
      <ci> pp5_translation_rate </ci>
      <cn> 1 </cn>
      <ci> lamdar </ci>
    </apply>
  </math>
</kineticLaw>
</reaction>
<reaction id="pp5_v2" name="pp5_v2" reversible="false" fast="false">
  <listOfReactants>
    <speciesReference species="lamdarepressor" stoichiometry="1"/>
  </listOfReactants>
  <kineticLaw>
    <math xmlns="http://www.w3.org/1998/Math/MathML">
      <apply>
        <times/>
        <ci> lamdarepressor_degradation_rate </ci>
        <ci> lamdarepressor </ci>
      </apply>
    </math>
  </kineticLaw>
</reaction>
```

```

</apply>
</math>
</kineticLaw>
</reaction>
</listOfReactions>
</model>
</sbml>

```

Steady state graphs

Steady state graphs for the degradation rates at different concentration

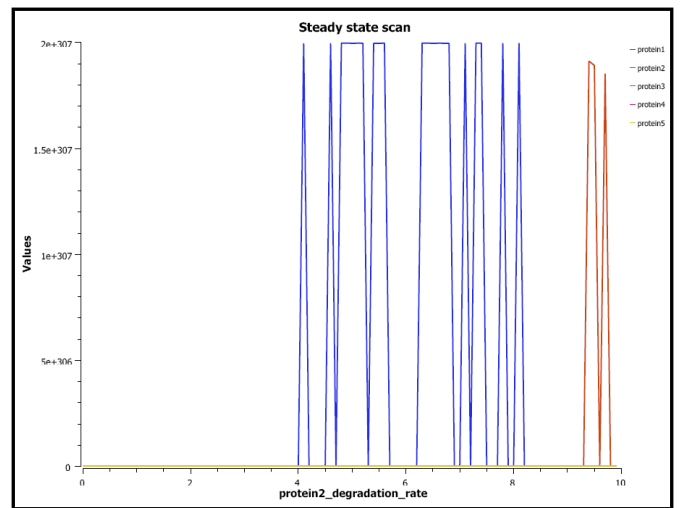
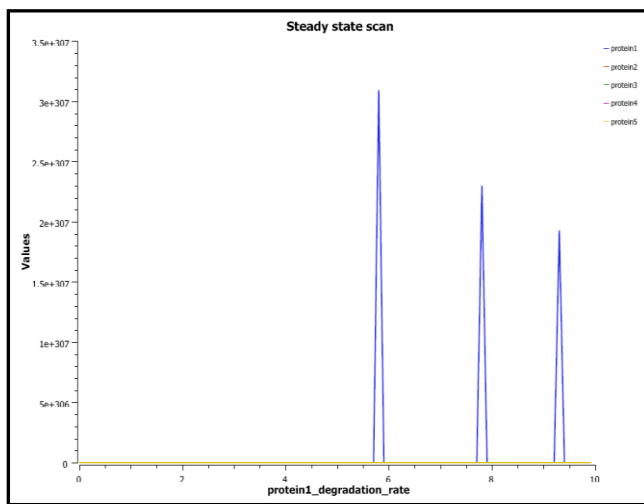
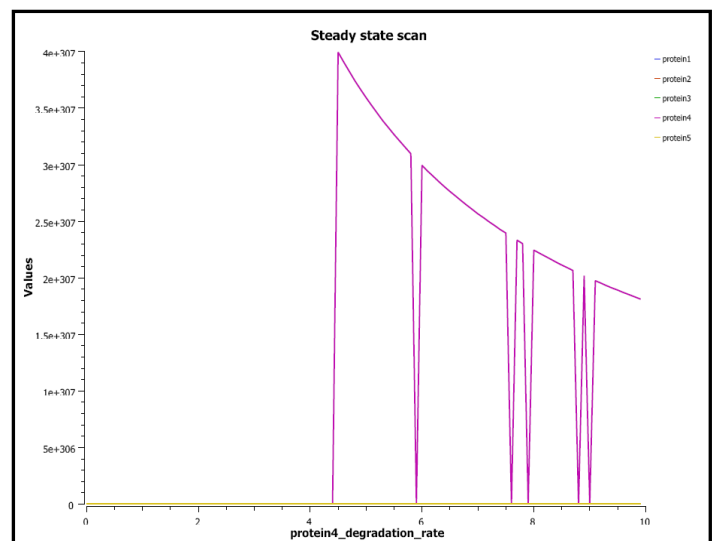
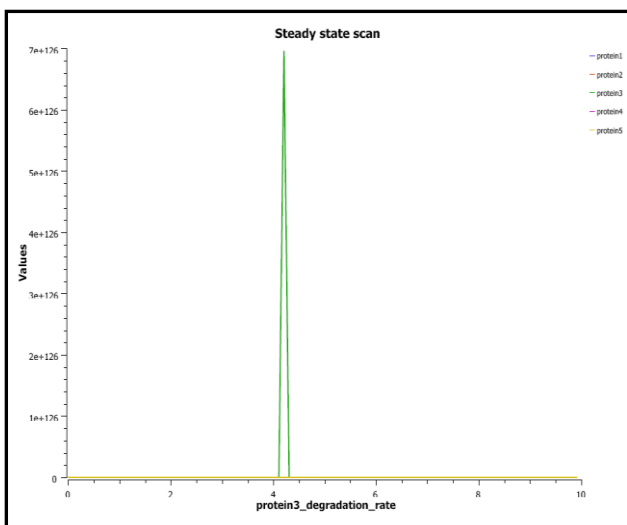

Fig 11.1 a.). Degradation of IPCS_1

b.) Degradation of IPCS_2



C.) degradation graph of LacI

d.) degradation graph of Tetr

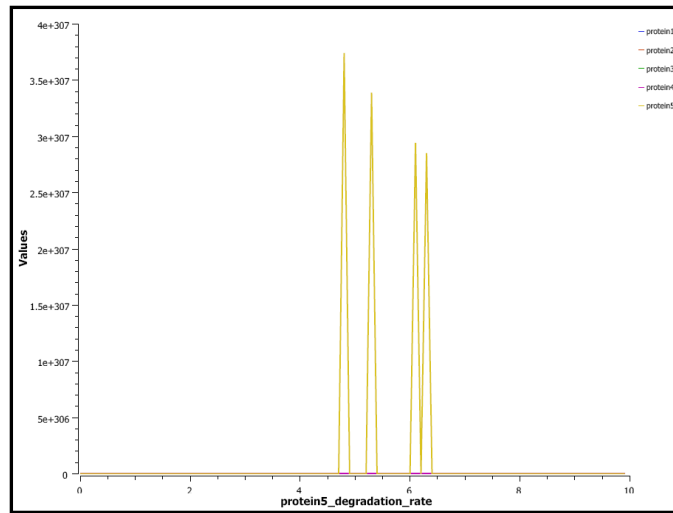

e.) degradation graph of Lamdar

Simulation results of circuit by change in Kd values of IPCS_1 (Case 1 results)

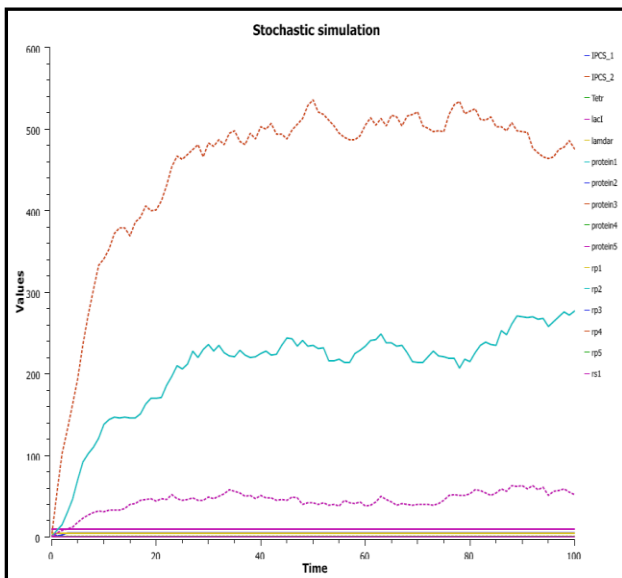
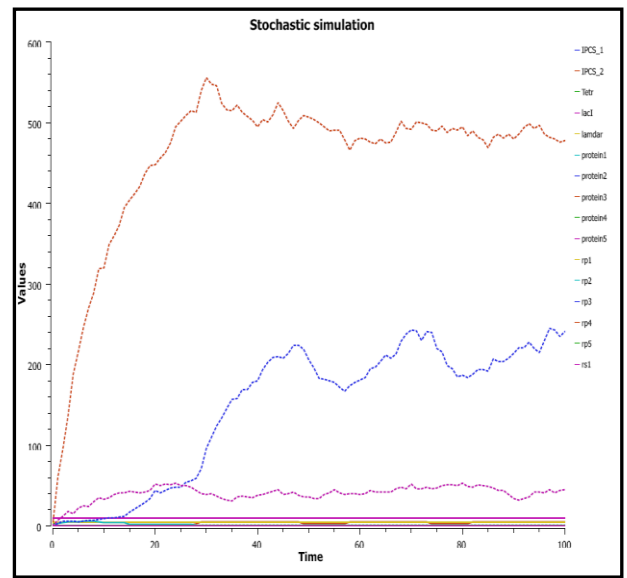
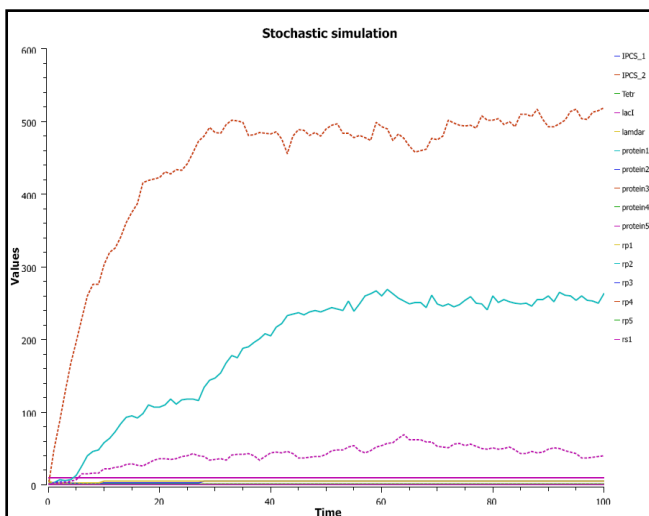

Fig 11.2 : a.)Kd =1.02



b.) Kd =1.03



c.) Kd =1.04

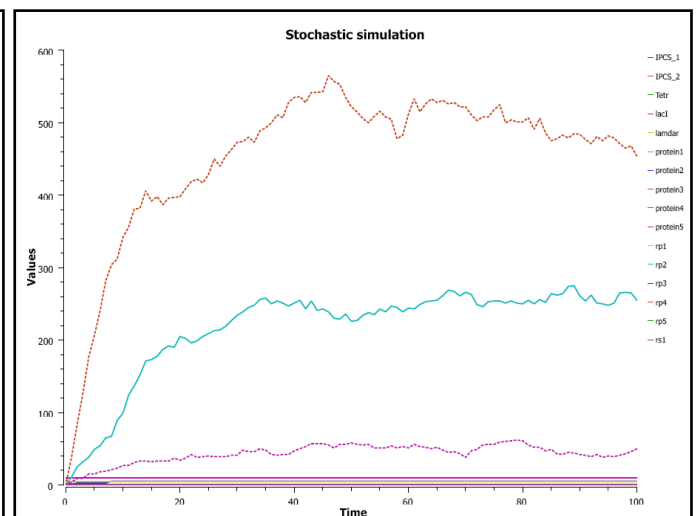

d.) Kd=1.05

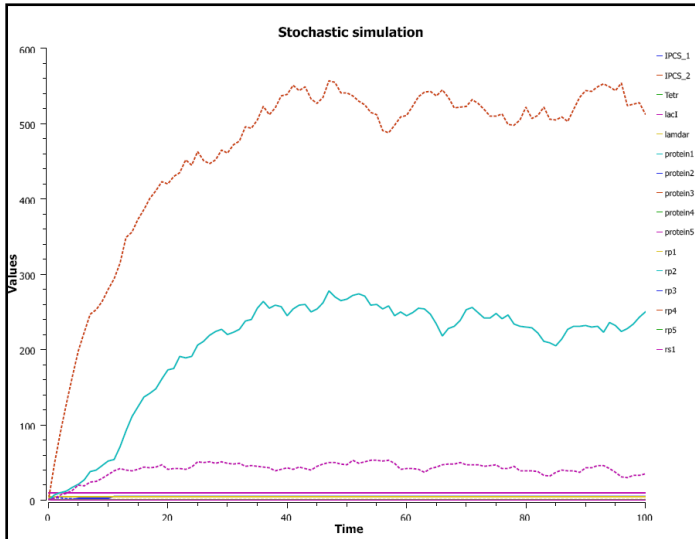

e.) $K_d = 1.06$

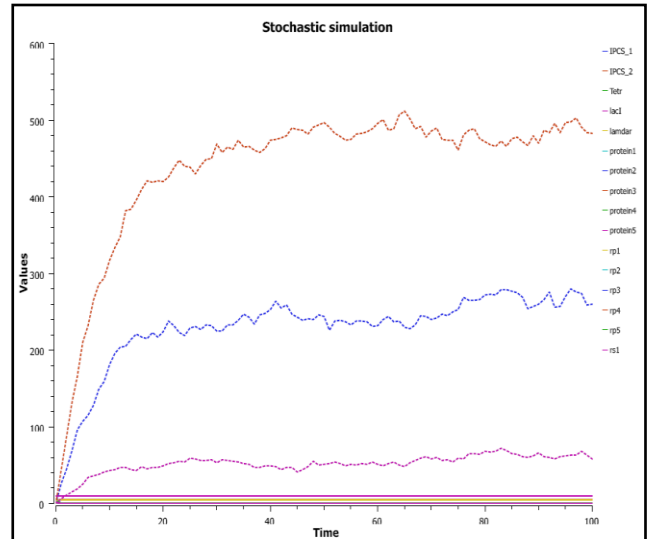

f.) $K_d = 1.07$

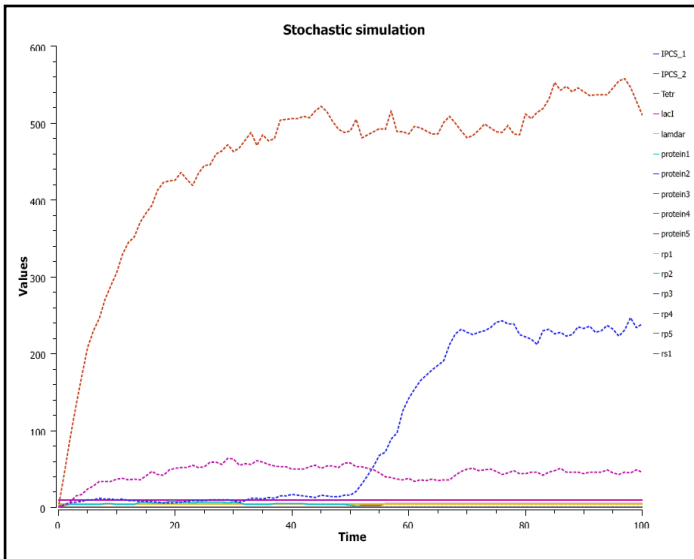

g.) $K_d = 1.08$

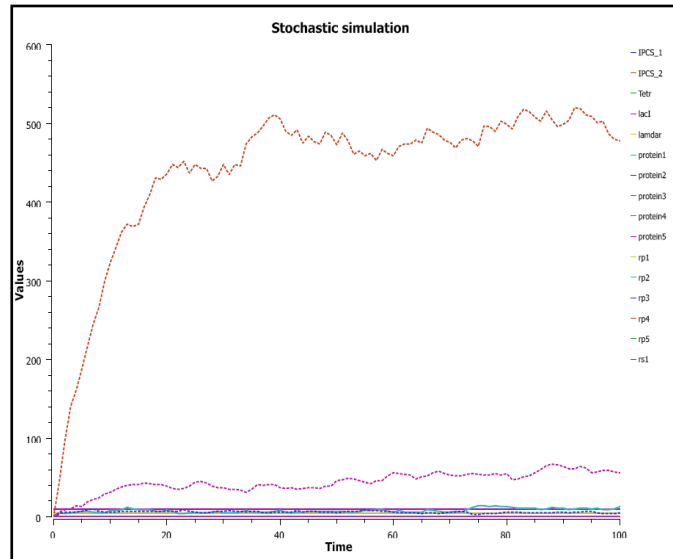

h.) $K_d = 1.09$

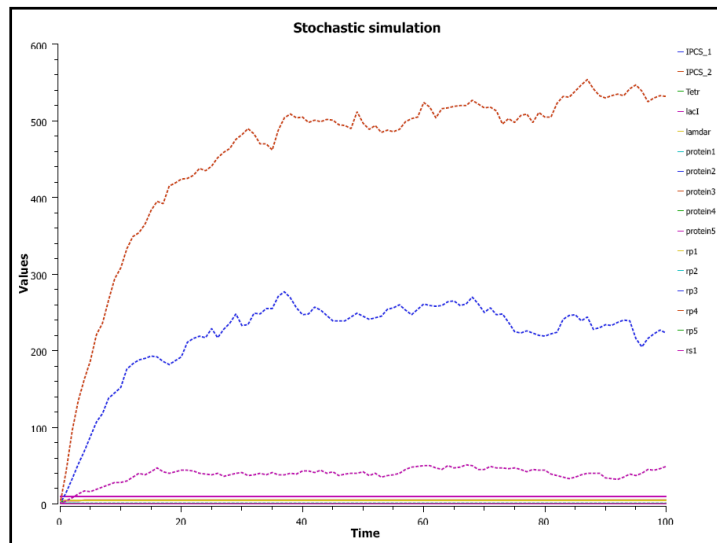

i.) $K_d = 2$

Simulation results of circuit by change in Kd values of IPCS_2 (Case 2 results)

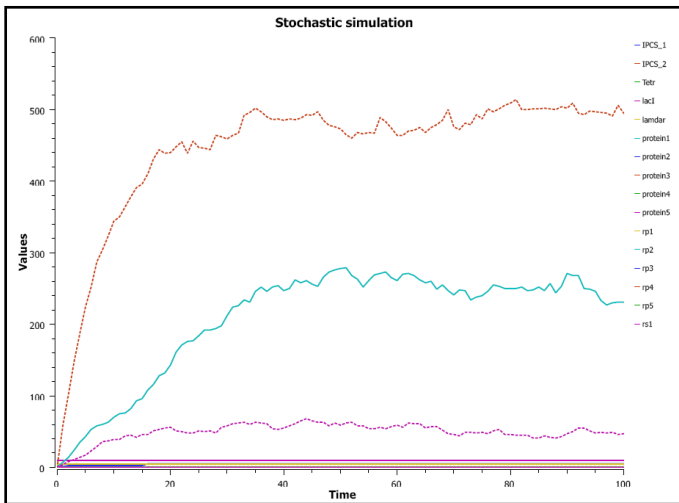
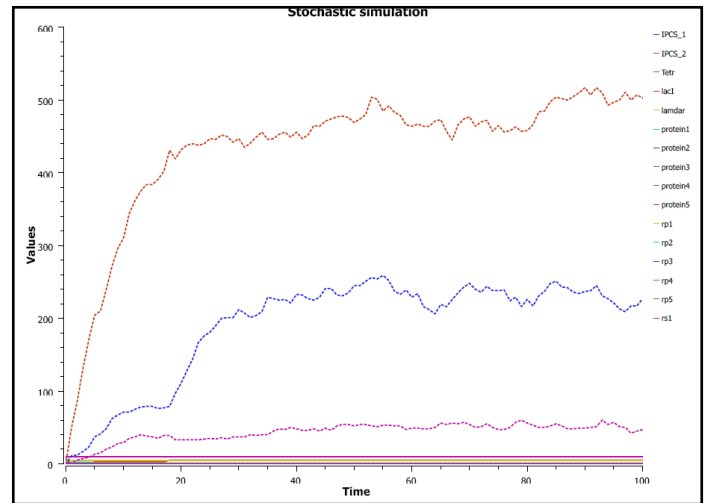
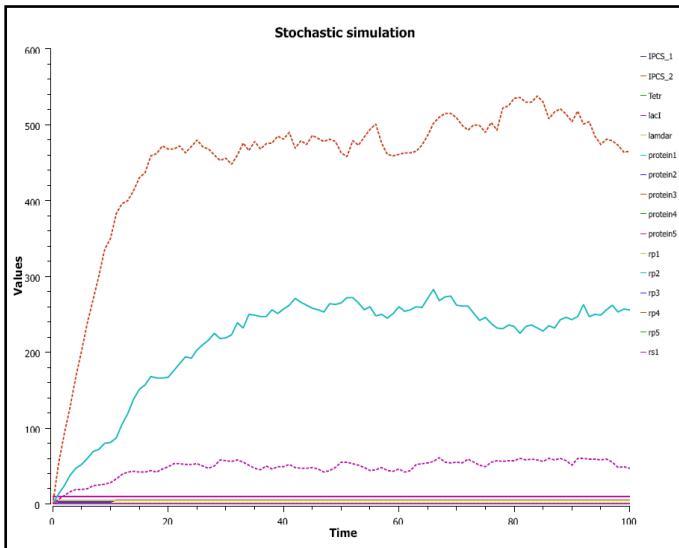

Fig 11.3 a.) Kd=1.01



b.) Kd=1.02



c.) Kd=1.03

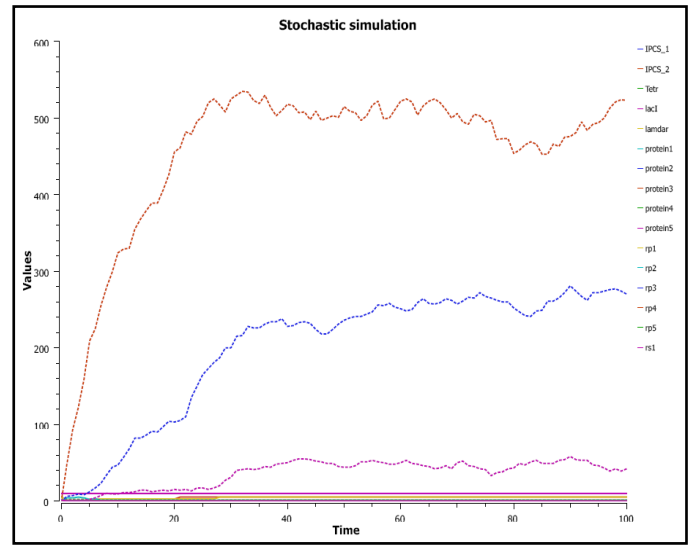

d.) Kd=1.04

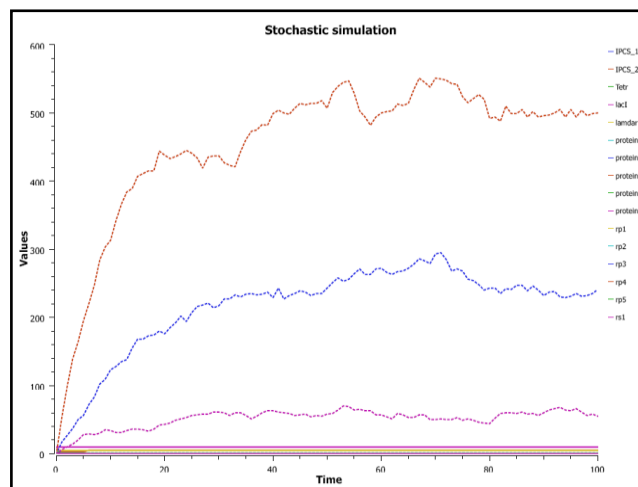

e.) Kd = 1.05

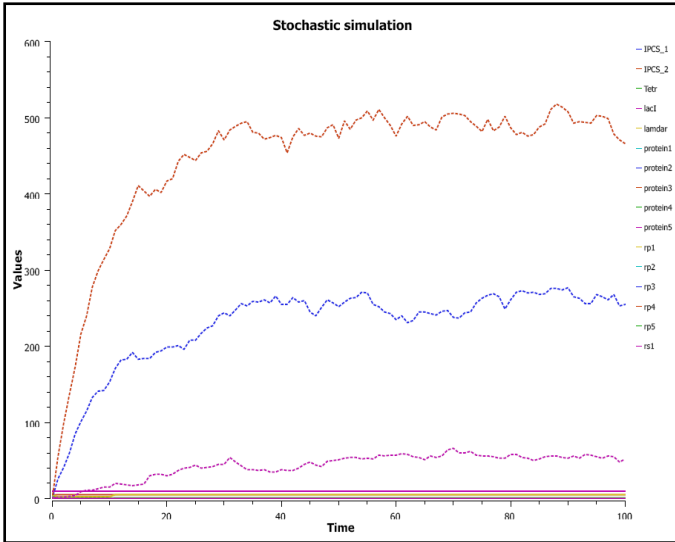

f.) $K_d = 1.06$

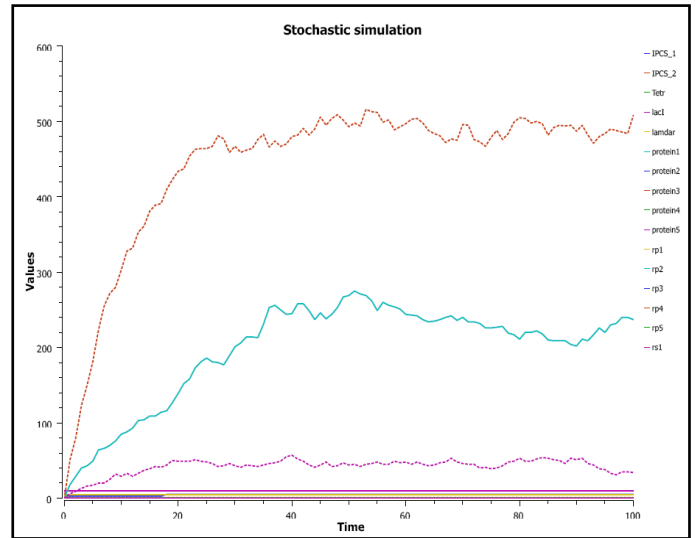

g.) $K_d = 1.07$

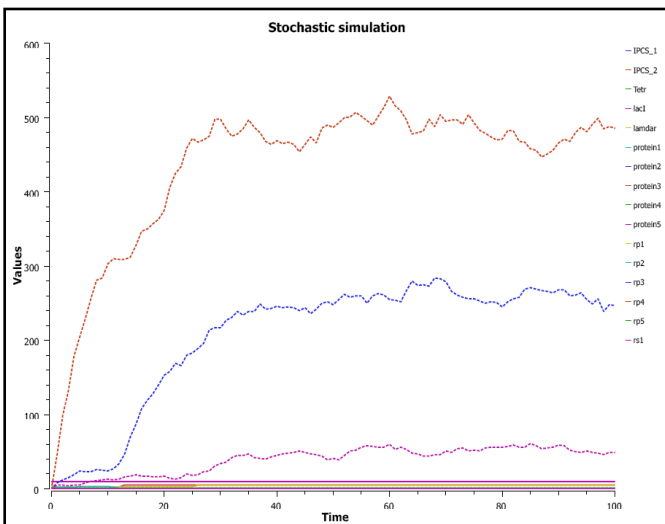

h.) $K_d = 1.08$

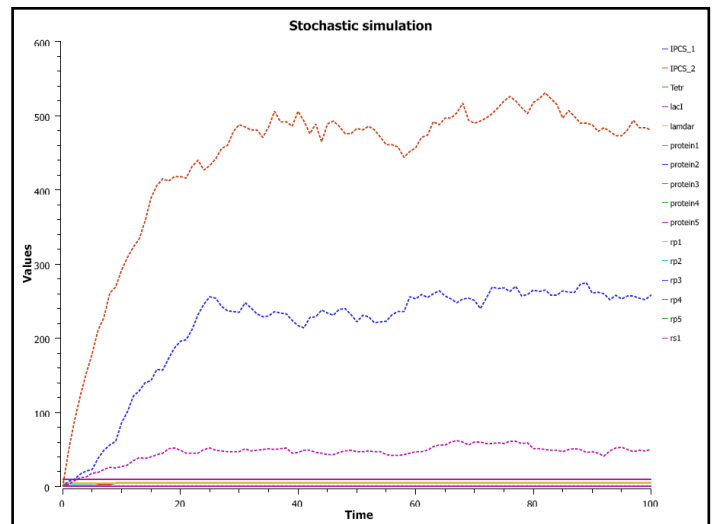

i.) $K_d = 1.09$

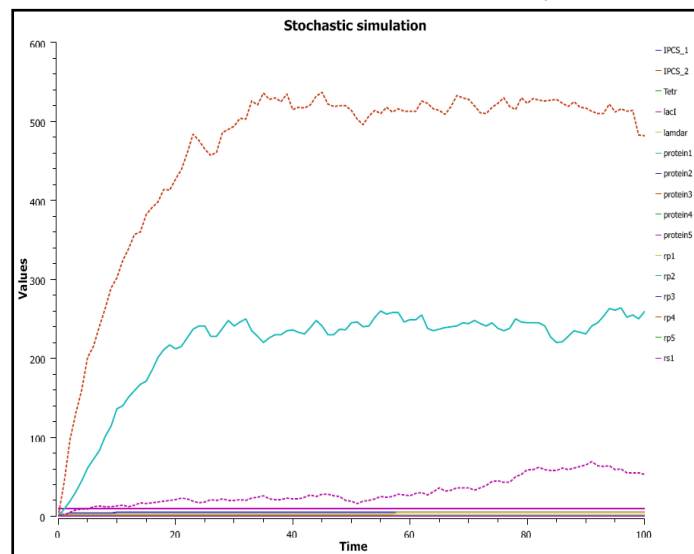

j.) $K_d = 2$

Time series data

#	Time	IPCS1protein	IPCS2protein	IPCS_1	IPCS_2							
		Tetr	Tetrepresor	lacI	lactoserepressor	lamdar						
		lamdarepressor	rp1	rp2	rp3	rp4	rp5	rs1				
		Compartments[DefaultCompartment]				Values[rp1_strength]						
		Values[rp2_strength]			Values[rp3_strength]			Values[rp4_strength]				
		Values[rp5_strength]			Values[IPCS1protein_degradation_rate]							
		Values[tr1_Kd]		Values[tr1_h]		Values[tr2_Kd]		Values[tr2_h]				
		Values[tr3_Kd]		Values[tr3_h]		Values[tr4_Kd]		Values[tr4_h]				
		Values[tr5_Kd]		Values[tr5_h]		Values[tr6_Kd]		Values[tr6_h]				
		Values[pp1_translation_rate]			Values[pp2_translation_rate]							
		Values[pp3_translation_rate]			Values[Tetrepresor_degradation_rate]							
		Values[pp4_translation_rate]			Values[pp5_translation_rate]							
		Values[IPCS2protein_degradation_rate]										
		Values[lamdarepressor_degradation_rate]										
		Values[lactoserepressor_degradation_rate]										
0	0.08	0.05	4.98753	4.9682	4.98753	0.05	10	0.05				
	4.98753	0.05	0.997506	0.993641	0.997506	0.997506	0.997506	0.997506				
	0.997506	0.997506	1	5	5	5	5	5	0.1	1		
	2	1	2	1	2	1	2	1	2	1	2	1
	1	1	0.1	1	1	0.1	0.1	0.1				
0.01	0.32167	0.289042	4.61448	4.53115	3.83974	0.0952181						
	10	0.5497	4.95507	0.0996474	0.922897	0.906231						
	0.990168	0.767949	0.991015	0.767949	1	5	5	5				
	5	5	0.1	1	2	1	2	1	2	1	2	1
	2	1	2	1	1	1	0.1	1	1	0.1	0.1	0.1
0.02	0.536912	0.499087	4.00292	3.88116	2.38073	0.125819						
	10	1.0489	4.92208	0.148903	0.800585	0.776232						
	0.978309	0.476147	0.984416	0.476147	1	5	5	5				
	5	5	0.1	1	2	1	2	1	2	1	2	1
	2	1	2	1	1	1	0.1	1	1	0.1	0.1	0.1
0.03	0.721631	0.67724	3.42782	3.28785	1.47272	0.144517						
	10	1.5476	4.89771	0.197821	0.685563	0.65757						
	0.962341	0.294544	0.979542	0.294544	1	5	5	5				
	5	5	0.1	1	2	1	2	1	2	1	2	1
	2	1	2	1	1	1	0.1	1	1	0.1	0.1	0.1
0.04	0.880164	0.828611	2.96455	2.8174	0.96426	0.156311						
	10	2.04581	4.88075	0.246486	0.59291	0.563479						
	0.942724	0.192852	0.97615	0.192852	1	5	5	5				
	5	5	0.1	1	2	1	2	1	2	1	2	1
	2	1	2	1	1	1	0.1	1	1	0.1	0.1	0.1
0.05	1.01805	0.959139	2.60424	2.45527	0.669393	0.164193						
	10	2.54351	4.86874	0.29496	0.520848	0.491054						
	0.919962	0.133879	0.973748	0.133879	1	5	5	5				
	5	5	0.1	1	2	1	2	1	2	1	2	1
	2	1	2	1	1	1	0.1	1	1	0.1	0.1	0.1
0.06	1.13987	1.07358	2.3228	2.17457	0.487997	0.169744						
	10	3.04072	4.85997	0.343282	0.46456	0.434915						
	0.89458	0.0975993	0.971994	0.0975993	1	5	5	5				
	5	5	0.1	1	2	1	2	1	2	1	2	1
	2	1	2	1	1	1	0.1	1	1	0.1	0.1	0.1
0.07	1.24902	1.17544	2.09938	1.95308	0.370003	0.173823						
	10	3.53743	4.85336	0.39148	0.419877	0.390616						
	0.86711	0.0740006	0.970672	0.0740006	1	5	5	5				

	5	5	0.1	1	2	1	2	1	2	1	2	1
	2	1	2	1	1	1	0.1	1	1	0.1	0.1	0.1
0.08	1.34802		1.26726		1.91869		1.77483		0.289515		0.176921	
	10	4.03364		4.84825		0.439571		0.383738		0.354967		
	0.838067		0.0579029		0.969649		0.0579029		1	5	5	5
	5	5	0.1	1	2	1	2	1	2	1	2	1
	2	1	2	1	1	1	0.1	1	1	0.1	0.1	0.1
0.09	1.43873		1.35092		1.76992		1.6287		0.232395		0.179337	
	10	4.52936		4.8442		0.487569		0.353984		0.325739		
	0.807935		0.0464789		0.968841		0.0464789		1	5	5	5
	5	5	0.1	1	2	1	2	1	2	1	2	1
	2	1	2	1	1	1	0.1	1	1	0.1	0.1	0.1
0.1	1.52254		1.42783		1.64544		1.50687		0.190502		0.18126	
	10	5.02459		4.84095		0.535483		0.329088		0.301374		
	0.777157		0.0381004		0.96819		0.0381004		1	5	5	5
	5	5	0.1	1	2	1	2	1	2	1	2	1
	2	1	2	1	1	1	0.1	1	1	0.1	0.1	0.1
0.11	1.60054		1.49907		1.53979		1.40381		0.158918		0.182818	
	10	5.51931		4.83829		0.583319		0.307958		0.280762		
	0.746123		0.0317835		0.967658		0.0317835		1	5	5	5
	5	5	0.1	1	2	1	2	1	2	1	2	1
	2	1	2	1	1	1	0.1	1	1	0.1	0.1	0.1
0.12	1.67357		1.56546		1.44899		1.3155		0.134543		0.184097	
	10	6.01355		4.8361		0.631083		0.289799		0.2631		
	0.715171		0.0269087		0.967219		0.0269087		1	5	5	5
	5	5	0.1	1	2	1	2	1	2	1	2	1
	2	1	2	1	1	1	0.1	1	1	0.1	0.1	0.1
0.13	1.74229		1.62768		1.37011		1.23898		0.115354		0.185158	
	10	6.50729		4.83426		0.67878		0.274021		0.247795		
	0.684583		0.0230708		0.966853		0.0230708		1	5	5	5
	5	5	0.1	1	2	1	2	1	2	1	2	1
	2	1	2	1	1	1	0.1	1	1	0.1	0.1	0.1
0.14	1.80726		1.68626		1.3009		1.17201		0.0999851		0.186047	
	10	7.00053		4.83272		0.726412		0.26018		0.234402		
	0.65459		0.019997		0.966545		0.019997		1	5	5	5
	5	5	0.1	1	2	1	2	1	2	1	2	1
	2	1	2	1	1	1	0.1	1	1	0.1	0.1	0.1
0.15	1.8689		1.74164		1.23967		1.11289		0.0874901		0.186795	
	10	7.49329		4.83142		0.773982		0.247935		0.222578		
	0.625372		0.017498		0.966284		0.017498		1	5	5	5
	5	5	0.1	1	2	1	2	1	2	1	2	1
	2	1	2	1	1	1	0.1	1	1	0.1	0.1	0.1
0.16	1.9276		1.79418		1.18509		1.0603		0.0771975		0.18743	
	10	7.98555		4.83031		0.821493		0.237018		0.212061		
	0.597068		0.0154395		0.966062		0.0154395		1	5	5	5
	5	5	0.1	1	2	1	2	1	2	1	2	1
	2	1	2	1	1	1	0.1	1	1	0.1	0.1	0.1
0.17	1.98365		1.84418		1.13611		1.0132		0.0686202		0.18797	
	10	8.47731		4.82937		0.868946		0.227222		0.20264		
	0.569779		0.013724		0.965873		0.013724		1	5	5	5
	5	5	0.1	1	2	1	2	1	2	1	2	1

	2	1	2	1	1	1	0.1	1	1	0.1	0.1	0.1
0.18	2.03732		1.89189		1.09188		0.970746		0.0613982		0.188431	
	10	8.96859		4.82856		0.916343		0.218377		0.194149		
	0.543571		0.0122796		0.965711		0.0122796		1	5	5	5
	5	5	0.1	1	2	1	2	1	2	1	2	1
	2	1	2	1	1	1	0.1	1	1	0.1	0.1	0.1
0.19	2.08883		1.93753		1.05174		0.932275		0.0552609		0.188825	
	10	9.45938		4.82786		0.963685		0.210347		0.186455		
	0.518487		0.0110522		0.965573		0.0110522		1	5	5	5
	5	5	0.1	1	2	1	2	1	2	1	2	1
	2	1	2	1	1	1	0.1	1	1	0.1	0.1	0.1
0.2	2.13838		1.9813		1.01512		0.897238		0.050002		0.189161	
	10	9.94967		4.82727		1.01097		0.203023		0.179448		
	0.494543		0.0100004		0.965454		0.0100004		1	5	5	5
	5	5	0.1	1	2	1	2	1	2	1	2	1
	2	1	2	1	1	1	0.1	1	1	0.1	0.1	0.1
0.21	2.18612		2.02335		0.981561		0.865184		0.0454617		0.189449	
	10	10.4395		4.82676		1.05821		0.196312		0.173037		
	0.471741		0.00909234		0.965353		0.00909234		1	5	5	5
	5	5	0.1	1	2	1	2	1	2	1	2	1
	2	1	2	1	1	1	0.1	1	1	0.1	0.1	0.1
0.22	2.23221		2.06381		0.950691		0.835737		0.0415149		0.189694	
	10	10.9288		4.82633		1.10539		0.190138		0.167147		
	0.450067		0.00830299		0.965266		0.00830299		1	5	5	5
	5	5	0.1	1	2	1	2	1	2	1	2	1
	2	1	2	1	1	1	0.1	1	1	0.1	0.1	0.1
0.23	2.27676		2.10283		0.922187		0.808584		0.0380627		0.189901	
	10	11.4176		4.82596		1.15252		0.184437		0.161717		
	0.429495		0.00761255		0.965193		0.00761255		1	5	5	5
	5	5	0.1	1	2	1	2	1	2	1	2	1
	2	1	2	1	1	1	0.1	1	1	0.1	0.1	0.1
0.24	2.31991		2.1405		0.895777		0.783458		0.0350258		0.190077	
	10	11.906		4.82565		1.19961		0.179155		0.156692		
	0.409995		0.00700516		0.965131		0.00700516		1	5	5	5
	5	5	0.1	1	2	1	2	1	2	1	2	1
	2	1	2	1	1	1	0.1	1	1	0.1	0.1	0.1
0.25	2.36173		2.17693		0.871231		0.760135		0.0323402		0.190223	
	10	12.3938		4.82539		1.24664		0.174246		0.152027		
	0.391526		0.00646803		0.965079		0.00646803		1	5	5	5
	5	5	0.1	1	2	1	2	1	2	1	2	1
	2	1	2	1	1	1	0.1	1	1	0.1	0.1	0.1
0.26	2.40233		2.21219		0.848353		0.738421		0.0299536		0.190344	
	10	12.8812		4.82518		1.29362		0.169671		0.147684		
	0.374048		0.00599073		0.965036		0.00599073		1	5	5	5
	5	5	0.1	1	2	1	2	1	2	1	2	1
	2	1	2	1	1	1	0.1	1	1	0.1	0.1	0.1
0.27	2.44179		2.24637		0.82697		0.71815		0.0278234		0.190442	
	10	13.368		4.82501		1.34056		0.165394		0.14363		
	0.357515		0.00556469		0.965001		0.00556469		1	5	5	5
	5	5	0.1	1	2	1	2	1	2	1	2	1

	2	1	2	1	1	1	0.1	1	1	0.1	0.1	0.1
0.28	2.48017		2.27953		0.806937		0.699179		0.0259141		0.19052	
	10	13.8544	4.82487		1.38744		0.161387		0.139836			
	0.341881		0.00518281		0.964973		0.00518281	1	5	5	5	
	5	5	0.1	1	2	1	2	1	2	1	2	1
	2	1	2	1	1	1	0.1	1	1	0.1	0.1	0.1
0.29	2.51754		2.31175		0.788125		0.681383		0.024196		0.19058	
	10	14.3403	4.82476		1.43428		0.157625		0.136277			
	0.327102		0.00483921		0.964952		0.00483921	1	5	5	5	
	5	5	0.1	1	2	1	2	1	2	1	2	1
	2	1	2	1	1	1	0.1	1	1	0.1	0.1	0.1
0.3	2.55397		2.34306		0.770422		0.664651		0.0226446		0.190624	
	10	14.8258	4.82468		1.48107		0.154084		0.13293			
	0.31313		0.00452892		0.964937		0.00452892	1	5	5	5	
	5	5	0.1	1	2	1	2	1	2	1	2	1
	2	1	2	1	1	1	0.1	1	1	0.1	0.1	0.1
0.31	2.58949		2.37354		0.753728		0.648889		0.0212389		0.190652	
	10	15.3107	4.82463		1.52781		0.150746		0.129778			
	0.299922		0.00424778		0.964927		0.00424778	1	5	5	5	
	5	5	0.1	1	2	1	2	1	2	1	2	1
	2	1	2	1	1	1	0.1	1	1	0.1	0.1	0.1
0.32	2.62417		2.40322		0.737956		0.634011		0.0199612		0.190667	
	10	15.7951	4.82461		1.5745		0.147591		0.126802			
	0.287434		0.00399223		0.964921		0.00399223	1	5	5	5	
	5	5	0.1	1	2	1	2	1	2	1	2	1
	2	1	2	1	1	1	0.1	1	1	0.1	0.1	0.1
0.33	2.65805		2.43215		0.723029		0.619943		0.0187964		0.19067	
	10	16.2791	4.8246		1.62115		0.144606		0.123989			
	0.275624		0.00375927		0.96492		0.00375927	1	5	5	5	
	5	5	0.1	1	2	1	2	1	2	1	2	1
	2	1	2	1	1	1	0.1	1	1	0.1	0.1	0.1
0.34	2.69117		2.46036		0.708879		0.606618		0.0177315		0.190662	
	10	16.7626	4.82461		1.66775		0.141776		0.121324			
	0.264452		0.0035463		0.964923		0.0035463	1	5	5	5	
	5	5	0.1	1	2	1	2	1	2	1	2	1
	2	1	2	1	1	1	0.1	1	1	0.1	0.1	0.1
0.35	2.72357		2.4879		0.695444		0.593976		0.0167555		0.190644	
	10	17.2456	4.82465		1.71431		0.139089		0.118795			
	0.253881		0.0033511		0.964929		0.0033511	1	5	5	5	
	5	5	0.1	1	2	1	2	1	2	1	2	1
	2	1	2	1	1	1	0.1	1	1	0.1	0.1	0.1
0.36	2.75528		2.5148		0.682668		0.581965		0.0158587		0.190616	
	10	17.7281	4.8247		1.76082		0.136534		0.116393			
	0.243874		0.00317173		0.964939		0.00317173	1	5	5	5	
	5	5	0.1	1	2	1	2	1	2	1	2	1
	2	1	2	1	1	1	0.1	1	1	0.1	0.1	0.1
0.37	2.78634		2.54108		0.670504		0.570536		0.0150327		0.19058	
	10	18.2101	4.82476		1.80728		0.134101		0.114107			
	0.234397		0.00300654		0.964952		0.00300654	1	5	5	5	
	5	5	0.1	1	2	1	2	1	2	1	2	1

	2	1	2	1	1	1	0.1	1	1	0.1	0.1	0.1
0.38	2.81677		2.56678		0.658905		0.559648		0.0142703		0.190536	
	10	18.6917		4.82484		1.8537		0.131781		0.11193		
	0.225418		0.00285406		0.964968		0.00285406		1	5	5	5
	5	5	0.1	1	2	1	2	1	2	1	2	1
	2	1	2	1	1	1	0.1	1	1	0.1	0.1	0.1
0.39	2.8466		2.59192		0.647833		0.54926		0.0135651		0.190485	
	10	19.1727		4.82493		1.90007		0.129567		0.109852		
	0.216907		0.00271301		0.964986		0.00271301		1	5	5	5
	5	5	0.1	1	2	1	2	1	2	1	2	1
	2	1	2	1	1	1	0.1	1	1	0.1	0.1	0.1
0.4	2.87587		2.61653		0.63725		0.539338		0.0129115		0.190427	
	10	19.6533		4.82503		1.9464		0.12745		0.107868		
	0.208835		0.00258229		0.965007		0.00258229		1	5	5	5
	5	5	0.1	1	2	1	2	1	2	1	2	1
	2	1	2	1	1	1	0.1	1	1	0.1	0.1	0.1
0.41	2.90459		2.64063		0.627124		0.529851		0.0123045		0.190362	
	10	20.1334		4.82515		1.99268		0.125425		0.10597		
	0.201176		0.0024609		0.965029		0.0024609		1	5	5	5
	5	5	0.1	1	2	1	2	1	2	1	2	1
	2	1	2	1	1	1	0.1	1	1	0.1	0.1	0.1
0.42	2.93278		2.66424		0.617424		0.520769		0.0117399		0.190292	
	10	20.6131		4.82527		2.03892		0.123485		0.104154		
	0.193905		0.00234798		0.965054		0.00234798		1	5	5	5
	5	5	0.1	1	2	1	2	1	2	1	2	1
	2	1	2	1	1	1	0.1	1	1	0.1	0.1	0.1
0.43	2.96047		2.68738		0.608123		0.512065		0.0112138		0.190217	
	10	21.0922		4.82541		2.08511		0.121625		0.102413		
	0.186997		0.00224275		0.965081		0.00224275		1	5	5	5
	5	5	0.1	1	2	1	2	1	2	1	2	1
	2	1	2	1	1	1	0.1	1	1	0.1	0.1	0.1
0.44	2.98768		2.71008		0.599197		0.503717		0.0107227		0.190136	
	10	21.5709		4.82555		2.13125		0.119839		0.100743		
	0.180432		0.00214453		0.96511		0.00214453		1	5	5	5
	5	5	0.1	1	2	1	2	1	2	1	2	1
	2	1	2	1	1	1	0.1	1	1	0.1	0.1	0.1
0.45	3.01442		2.73234		0.590621		0.495701		0.0102635		0.190051	
	10	22.0491		4.8257		2.17736		0.118124		0.0991402		
	0.174189		0.00205271		0.96514		0.00205271		1	5	5	5
	5	5	0.1	1	2	1	2	1	2	1	2	1
	2	1	2	1	1	1	0.1	1	1	0.1	0.1	0.1
0.46	3.04072		2.75419		0.582375		0.487998		0.0098337		0.189961	
	10	22.5268		4.82586		2.22341		0.116475		0.0975995		
	0.168249		0.00196674		0.965171		0.00196674		1	5	5	5
	5	5	0.1	1	2	1	2	1	2	1	2	1
	2	1	2	1	1	1	0.1	1	1	0.1	0.1	0.1
0.47	3.06658		2.77563		0.574439		0.480588		0.00943068		0.189868	
	10	23.004		4.82602		2.26943		0.114888		0.0961177		
	0.162594		0.00188614		0.965205		0.00188614		1	5	5	5
	5	5	0.1	1	2	1	2	1	2	1	2	1

	2	1	2	1	1	1	0.1	1	1	0.1	0.1	0.1
0.48	3.09203		2.7967		0.566796		0.473456		0.00905229		0.18977	
	10	23.4808		4.8262		2.31539		0.113359		0.0946911		
	0.157207		0.00181046		0.965239		0.00181046	1	5	5	5	
	5	5	0.1	1	2	1	2	1	2	1	2	1
	2	1	2	1	1	1	0.1	1	1	0.1	0.1	0.1
0.49	3.11708		2.81739		0.559429		0.466584		0.00869656		0.189669	
	10	23.957		4.82637		2.36132		0.111886		0.0933167		
	0.152072		0.00173931		0.965275		0.00173931	1	5	5	5	
	5	5	0.1	1	2	1	2	1	2	1	2	1
	2	1	2	1	1	1	0.1	1	1	0.1	0.1	0.1
0.5	3.14174		2.83773		0.552322		0.459958		0.00836171		0.189565	
	10	24.4328		4.82656		2.4072		0.110464		0.0919916		
	0.147175		0.00167234		0.965312		0.00167234	1	5	5	5	
	5	5	0.1	1	2	1	2	1	2	1	2	1
	2	1	2	1	1	1	0.1	1	1	0.1	0.1	0.1
0.51	3.16603		2.85771		0.545463		0.453565		0.00804612		0.189457	
	10	24.9082		4.82675		2.45304		0.109093		0.0907131		
	0.142503		0.00160922		0.96535		0.00160922	1	5	5	5	
	5	5	0.1	1	2	1	2	1	2	1	2	1
	2	1	2	1	1	1	0.1	1	1	0.1	0.1	0.1
0.52	3.18996		2.87737		0.538836		0.447393		0.00774835		0.189347	
	10	25.383		4.82694		2.49883		0.107767		0.0894786		
	0.138043		0.00154967		0.965389		0.00154967	1	5	5	5	
	5	5	0.1	1	2	1	2	1	2	1	2	1
	2	1	2	1	1	1	0.1	1	1	0.1	0.1	0.1
0.53	3.21354		2.8967		0.532431		0.441429		0.00746708		0.189234	
	10	25.8574		4.82714		2.54458		0.106486		0.0882858		
	0.133782		0.00149342		0.965429		0.00149342	1	5	5	5	
	5	5	0.1	1	2	1	2	1	2	1	2	1
	2	1	2	1	1	1	0.1	1	1	0.1	0.1	0.1
0.54	3.23678		2.91572		0.526236		0.435663		0.0072011		0.189118	
	10	26.3313		4.82735		2.59028		0.105247		0.0871327		
	0.129709		0.00144022		0.965469		0.00144022	1	5	5	5	
	5	5	0.1	1	2	1	2	1	2	1	2	1
	2	1	2	1	1	1	0.1	1	1	0.1	0.1	0.1
0.55	3.25969		2.93444		0.52024		0.430085		0.00694932		0.189 10	
	26.8048		4.82756		2.63594		0.104048		0.086017		0.125815	
	0.00138986		0.965511		0.00138986		1	5	5	5	5	
	0.1	1	2	1	2	1	2	1	2	1	2	1
	2	1	1	1	0.1	1	1	0.1	0.1	0.1		
0.56	3.28229		2.95287		0.514434		0.424685		0.00671075		0.188879	
	10	27.2777		4.82777		2.68156		0.102887		0.0849371		
	0.122089		0.00134215		0.965554		0.00134215	1	5	5	5	
	5	5	0.1	1	2	1	2	1	2	1	2	1
	2	1	2	1	1	1	0.1	1	1	0.1	0.1	0.1
0.57	3.30458		2.97101		0.508809		0.419455		0.00648447		0.188756	
	10	27.7502		4.82798		2.72714		0.101762		0.0838911		
	0.118522		0.00129689		0.965597		0.00129689	1	5	5	5	
	5	5	0.1	1	2	1	2	1	2	1	2	1
	2	1	2	1	1	1	0.1	1	1	0.1	0.1	0.1

0.58	3.32656	2.98887	0.503355	0.414387	0.00626965	0.188631						
	10	28.2222	4.8282	2.77267	0.100671	0.0828773						
	0.115106	0.00125393	0.965641	0.00125393	1	5	5	5				
	5	5	0.1	1	2	1	2	1	2	1	2	1
	2	1	2	1	1	1	0.1	1	1	0.1	0.1	0.1
0.59	3.34826	3.00647	0.498064	0.409472	0.00606552	0.188504						
	10	28.6938	4.82843	2.81815	0.0996129	0.0818944						
	0.111832	0.0012131	0.965685	0.0012131	1	5	5	5				
	5	5	0.1	1	2	1	2	1	2	1	2	1
	2	1	2	1	1	1	0.1	1	1	0.1	0.1	0.1
0.6	3.36968	3.02381	0.492931	0.404704	0.00587139	0.188376						
	10	29.1648	4.82865	2.8636	0.0985861	0.0809407						
	0.108693	0.00117428	0.965731	0.00117428	1	5	5	5				
	5	5	0.1	1	2	1	2	1	2	1	2	1
	2	1	2	1	1	1	0.1	1	1	0.1	0.1	0.1
0.61	3.39082	3.04089	0.487946	0.400075	0.00568661	0.188245						
	10	29.6354	4.82888	2.909	0.0975891	0.0800151	0.105683					
	0.00113732	0.965777	0.00113732	1	5	5	5	5				
	0.1	1	2	1	2	1	2	1	2	1	2	1
	2	1	1	1	0.1	1	1	0.1	0.1	0.1	0.1	
0.62	3.41169	3.05774	0.483103	0.395581	0.00551059	0.188113						
	10	30.1056	4.82911	2.95436	0.0966207	0.0791162						
	0.102794	0.00110212	0.965823	0.00110212	1	5	5	5				
	5	5	0.1	1	2	1	2	1	2	1	2	1
	2	1	2	1	1	1	0.1	1	1	0.1	0.1	0.1
0.63	3.43231	3.07434	0.478397	0.391214	0.00534277	0.187979						
	10	30.5752	4.82935	2.99967	0.0956795	0.0782428						
	0.10002	0.00106855	0.96587	0.00106855	1	5	5	5				
	5	5	0.1	1	2	1	2	1	2	1	2	1
	2	1	2	1	1	1	0.1	1	1	0.1	0.1	0.1
0.64	3.45267	3.09071	0.473822	0.386969	0.00518266	0.187844						
	10	31.0444	4.82959	3.04495	0.0947643	0.0773939						
	0.0973549	0.00103653	0.965917	0.00103653	1	5	5	5				
	5	5	0.1	1	2	1	2	1	2	1	2	1
	2	1	2	1	1	1	0.1	1	1	0.1	0.1	0.1
0.65	3.47279	3.10686	0.469371	0.382841	0.00502979	0.187707						
	10	31.5131	4.82983	3.09018	0.0938741	0.0765683						
	0.094794	0.00100596	0.965965	0.00100596	1	5	5	5				
	5	5	0.1	1	2	1	2	1	2	1	2	1
	2	1	2	1	1	1	0.1	1	1	0.1	0.1	0.1
0.66	3.49266	3.12278	0.465039	0.378825	0.00488373	0.187569						
	10	31.9814	4.83007	3.13536	0.0930079	0.0757651						
	0.0923319	0.000976745	0.966014	0.000976745	1	5	5	5				
	5	5	0.1	1	2	1	2	1	2	1	2	1
	2	1	2	1	1	1	0.1	1	1	0.1	0.1	0.1
0.67	3.51231	3.1385	0.460823	0.374917	0.00474407	0.18743						
	10	32.4492	4.83031	3.18051	0.0921646	0.0749834						
	0.0899635	0.000948813	0.966062	0.000948813	1	5	5	5				
	5	5	0.1	1	2	1	2	1	2	1	2	1
	2	1	2	1	1	1	0.1	1	1	0.1	0.1	0.1
0.68	3.53172	3.154	0.456716	0.371111	0.00461044	0.187289	10					
	32.9165	4.83056	3.22561	0.0913433	0.0742222	0.0876843						

	0.000922089	0.966112	0.000922089	1	5	5	5	5	5	5	5
	0.1	1	2	1	2	1	2	1	2	1	2
	2	1	1	1	0.1	1	1	0.1	0.1	0.1	
0.69	3.55092	3.1693	0.452715	0.367404	0.00448251	0.187147					
	10	33.3833	4.83081	3.27067	0.0905431	0.0734808					
	0.0854901	0.000896502	0.966161	0.000896502	1	5	5	5			
	5	5	0.1	1	2	1	2	1	2	1	2
	2	1	2	1	1	1	0.1	1	1	0.1	0.1
0.7	3.56989	3.1844	0.448816	0.363792	0.00435995	0.187004					
	10	33.8497	4.83106	3.31568	0.0897632	0.0727583					
	0.0833767	0.000871989	0.966211	0.000871989	1	5	5	5			
	5	5	0.1	1	2	1	2	1	2	1	2
	2	1	2	1	1	1	0.1	1	1	0.1	0.1
0.71	3.58866	3.19931	0.445014	0.36027	0.00424246	0.18686					
	10	34.3156	4.83131	3.36066	0.0890028	0.072054					
	0.0813404	0.000848491	0.966261	0.000848491	1	5	5	5			
	5	5	0.1	1	2	1	2	1	2	1	2
	2	1	2	1	1	1	0.1	1	1	0.1	0.1
0.72	3.60722	3.21403	0.441306	0.356836	0.00412976	0.186715					
	10	34.7811	4.83156	3.40559	0.0882612	0.0713673					
	0.0793775	0.000825952	0.966312	0.000825952	1	5	5	5			
	5	5	0.1	1	2	1	2	1	2	1	2
	2	1	2	1	1	1	0.1	1	1	0.1	0.1
0.73	3.62558	3.22857	0.437688	0.353487	0.0040216	0.18657					
	10	35.2461	4.83181	3.45048	0.0875376	0.0706973					
	0.0774846	0.000804321	0.966363	0.000804321	1	5	5	5			
	5	5	0.1	1	2	1	2	1	2	1	2
	2	1	2	1	1	1	0.1	1	1	0.1	0.1
0.74	3.64374	3.24293	0.434157	0.350218	0.00391774	0.186423					
	10	35.7106	4.83207	3.49532	0.0868314	0.0700436					
	0.0756585	0.000783548	0.966414	0.000783548	1	5	5	5			
	5	5	0.1	1	2	1	2	1	2	1	2
	2	1	2	1	1	1	0.1	1	1	0.1	0.1
0.75	3.66171	3.25711	0.43071	0.347027	0.00381795	0.186275					
	10	36.1746	4.83233	3.54013	0.086142	0.0694054					
	0.0738962	0.000763589	0.966465	0.000763589	1	5	5	5			
	5	5	0.1	1	2	1	2	1	2	1	2
	2	1	2	1	1	1	0.1	1	1	0.1	0.1
0.76	3.67949	3.27112	0.427343	0.343912	0.00372201	0.186127					
	10	36.6382	4.83258	3.58489	0.0854687	0.0687823					
	0.0721947	0.000744402	0.966517	0.000744402	1	5	5	5			
	5	5	0.1	1	2	1	2	1	2	1	2
	2	1	2	1	1	1	0.1	1	1	0.1	0.1
0.77	3.69708	3.28496	0.424054	0.340868	0.00362973	0.185977					
	10	37.1014	4.83284	3.62961	0.0848109	0.0681737					
	0.0705514	0.000725947	0.966569	0.000725947	1	5	5	5			
	5	5	0.1	1	2	1	2	1	2	1	2
	2	1	2	1	1	1	0.1	1	1	0.1	0.1
0.78	3.7145	3.29863	0.420841	0.337895	0.00354093	0.185827					
	10	37.564	4.8331	3.67429	0.0841681	0.067579					
	0.0689637	0.000708187	0.966621	0.000708187	1	5	5	5			
	5	5	0.1	1	2	1	2	1	2	1	2

	2	1	2	1	1	1	0.1	1	1	0.1	0.1	0.1
0.79	3.73174		3.31215		0.417699		0.334989		0.00345544		0.185676	
	10	38.0262		4.83337		3.71892		0.0835399		0.0669977		
	0.0674291		0.000691087		0.966673		0.000691087	1	5	5	5	
	5	5	0.1	1	2	1	2	1	2	1	2	1
	2	1	2	1	1	1	0.1	1	1	0.1	0.1	0.1
0.8	3.74881		3.32551		0.414628		0.332148		0.00337308		0.185525	
	10	38.488		4.83363		3.76352		0.0829256		0.0664295		
	0.0659454		0.000674616		0.966726		0.000674616	1	5	5	5	
	5	5	0.1	1	2	1	2	1	2	1	2	1
	2	1	2	1	1	1	0.1	1	1	0.1	0.1	0.1
0.81	3.76571		3.33871		0.411624		0.329369		0.00329371		0.185373	
	10	38.9493		4.83389		3.80807		0.0823248		0.0658738		
	0.0645104		0.000658742		0.966778		0.000658742	1	5	5	5	
	5	5	0.1	1	2	1	2	1	2	1	2	1
	2	1	2	1	1	1	0.1	1	1	0.1	0.1	0.1
0.82	3.78244		3.35177		0.408685		0.326651		0.00321718		0.18522	
	10	39.4101		4.83416		3.85258		0.081737		0.0653303		
	0.0631219		0.000643437		0.966831		0.000643437	1	5	5	5	
	5	5	0.1	1	2	1	2	1	2	1	2	1
	2	1	2	1	1	1	0.1	1	1	0.1	0.1	0.1
0.83	3.79901		3.36468		0.40581		0.323992		0.00314336		0.185067	
	10	39.8704		4.83442		3.89705		0.0811619		0.0647984		
	0.0617781		0.000628673		0.966884		0.000628673	1	5	5	5	
	5	5	0.1	1	2	1	2	1	2	1	2	1
	2	1	2	1	1	1	0.1	1	1	0.1	0.1	0.1
0.84	3.81542		3.37744		0.402995		0.321389		0.00307213		0.184913	
	10	40.3303		4.83469		3.94147		0.080599		0.0642779		
	0.060477		0.000614426		0.966938		0.000614426	1	5	5	5	
	5	5	0.1	1	2	1	2	1	2	1	2	1
	2	1	2	1	1	1	0.1	1	1	0.1	0.1	0.1
0.85	3.83168		3.39006		0.40024		0.318842		0.00300335		0.184758	
	10	40.7898		4.83496		3.98586		0.0800479		0.0637683		
	0.059217		0.00060067		0.966991		0.00060067	1	5	5	5	
	5	5	0.1	1	2	1	2	1	2	1	2	1
	2	1	2	1	1	1	0.1	1	1	0.1	0.1	0.1
0.86	3.84778		3.40254		0.397541		0.316347		0.00293693		0.184603	
	10	41.2488		4.83522		4.0302		0.0795082		0.0632693		
	0.0579962		0.000587385		0.967045		0.000587385	1	5	5	5	
	5	5	0.1	1	2	1	2	1	2	1	2	1
	2	1	2	1	1	1	0.1	1	1	0.1	0.1	0.1
0.87	3.86374		3.41489		0.394898		0.313903		0.00287274		0.184448	
	10	41.7073		4.83549		4.0745		0.0789797		0.0627806		
	0.0568132		0.000574548		0.967098		0.000574548	1	5	5	5	
	5	5	0.1	1	2	1	2	1	2	1	2	1
	2	1	2	1	1	1	0.1	1	1	0.1	0.1	0.1
0.88	3.87955		3.42711		0.392309		0.311509		0.0028107		0.184292	
	10	42.1653		4.83576		4.11876		0.0784618		0.0623019		
	0.0556663		0.00056214		0.967152		0.00056214	1	5	5	5	
	5	5	0.1	1	2	1	2	1	2	1	2	1

	2	1	2	1	1	1	0.1	1	1	0.1	0.1	0.1
0.89	3.89521		3.43919		0.389772		0.309163		0.0027507		0.184136	
	10	42.623		4.83603		4.16298		0.0779543		0.0618327		
	0.0545542		0.000550141		0.967206		0.000550141	1	5	5	5	
	5	5	0.1	1	2	1	2	1	2	1	2	1
	2	1	2	1	1	1	0.1	1	1	0.1	0.1	0.1
0.9	3.91073		3.45115		0.387285		0.306864		0.00269267		0.183979	
	10	43.0801		4.8363		4.20716		0.0774569		0.0613729		
	0.0534755		0.000538533		0.96726		0.000538533	1	5	5	5	
	5	5	0.1	1	2	1	2	1	2	1	2	1
	2	1	2	1	1	1	0.1	1	1	0.1	0.1	0.1
0.91	3.92612		3.46297		0.384846		0.30461		0.0026365		0.183821	
	10	43.5368		4.83657		4.25129		0.0769693		0.0609221		
	0.0524288		0.0005273		0.967314		0.0005273	1	5	5	5	
	5	5	0.1	1	2	1	2	1	2	1	2	1
	2	1	2	1	1	1	0.1	1	1	0.1	0.1	0.1
0.92	3.94137		3.47468		0.382456		0.3024		0.00258213		0.183664	
	10	43.993		4.83684		4.29538		0.0764912		0.06048		
	0.051413		0.000516426		0.967368		0.000516426	1	5	5	5	
	5	5	0.1	1	2	1	2	1	2	1	2	1
	2	1	2	1	1	1	0.1	1	1	0.1	0.1	0.1
0.93	3.95648		3.48627		0.380111		0.300233		0.00252947		0.183506	
	10	44.4488		4.83711		4.33944		0.0760222		0.0600465		
	0.0504268		0.000505895		0.967423		0.000505895	1	5	5	5	
	5	5	0.1	1	2	1	2	1	2	1	2	1
	2	1	2	1	1	1	0.1	1	1	0.1	0.1	0.1
0.94	3.97147		3.49773		0.377811		0.298106		0.00247846		0.183347	
	10	44.9041		4.83739		4.38345		0.0755622		0.0596212		
	0.0494692		0.000495692		0.967477		0.000495692	1	5	5	5	
	5	5	0.1	1	2	1	2	1	2	1	2	1
	2	1	2	1	1	1	0.1	1	1	0.1	0.1	0.1
0.95	3.98632		3.50908		0.375554		0.29602		0.00242903		0.183189	
	10	45.359		4.83766		4.42742		0.0751109		0.059204		
	0.0485389		0.000485805		0.967531		0.000485805	1	5	5	5	
	5	5	0.1	1	2	1	2	1	2	1	2	1
	2	1	2	1	1	1	0.1	1	1	0.1	0.1	0.1
0.96	4.00105		3.52032		0.37334		0.293972		0.0023811		0.18303	
	10	45.8134		4.83793		4.47135		0.0746679		0.0587945		
	0.0476351		0.00047622		0.967586		0.00047622	1	5	5	5	
	5	5	0.1	1	2	1	2	1	2	1	2	1
	2	1	2	1	1	1	0.1	1	1	0.1	0.1	0.1
0.97	4.01565		3.53144		0.371166		0.291963		0.00233463		0.18287	
	10	46.2674		4.8382		4.51523		0.0742332		0.0583925		
	0.0467567		0.000466925		0.967641		0.000466925	1	5	5	5	
	5	5	0.1	1	2	1	2	1	2	1	2	1
	2	1	2	1	1	1	0.1	1	1	0.1	0.1	0.1
0.98	4.03014		3.54245		0.369032		0.28999		0.00228954		0.182711	
	10	46.7209		4.83848		4.55908		0.0738064		0.0579979		
	0.0459027		0.000457909		0.967695		0.000457909	1	5	5	5	
	5	5	0.1	1	2	1	2	1	2	1	2	1

	2	1	2	1	1	1	0.1	1	1	0.1	0.1	0.1
0.99	4.0445		3.55335		0.366937		0.288052		0.0022458		0.182551	
	10	47.1739		4.83875		4.60288		0.0733874		0.0576104		
	0.0450724		0.00044916		0.96775		0.00044916		1	5	5	5
	5	5	0.1	1	2	1	2	1	2	1	2	1
	2	1	2	1	1	1	0.1	1	1	0.1	0.1	0.1
1	4.05874		3.56415		0.364879		0.28615		0.00220334		0.18239	
	10	47.6265		4.83902		4.64665		0.0729759		0.0572299		
	0.0442647		0.000440667		0.967805		0.000440667		1	5	5	5
	5	5	0.1	1	2	1	2	1	2	1	2	1
	2	1	2	1	1	1	0.1	1	1	0.1	0.1	0.1

GRENITS commands

Input file for GRENITS

	v1	v2	v3	v4	v5	v6	v7	v8	v9	v10	v11	v12
	v13	v14	v15	v16	v17	v18	v19	v20	v21	v22	v23	v24
	v25	v26	v27	v28	v29	v30	v31	v32	v33	v34	v35	v36
	v37	v38	v39	v40	v41	v42	v43	v44	v45	v46	v47	v48
	v49	v50	v51	v52	v53	v54	v55	v56	v57	v58	v59	v60
	v61	v62	v63	v64	v65	v66	v67	v68	v69	v70	v71	v72
	v73	v74	v75	v76	v77	v78	v79	v80	v81	v82	v83	v84
	v85	v86	v87	v88	v89	v90	v91	v92	v93	v94	v95	v96
	v97	v98	v99	v100	v101							
IPCS_1	4.98753		4.61448		4.00292		3.42782		2.96455			
	2.60424		2.3228		2.09938		1.91869		1.76992		1.64544	
	1.53979		1.44899		1.37011		1.3009		1.23967		1.18509	
	1.13611		1.09188		1.05174		1.01512		0.981561		0.950691	
	0.922187		0.895777		0.871231		0.848353		0.82697		0.806937	
	0.788125		0.770422		0.753728		0.737956		0.723029		0.708879	
	0.695444		0.682668		0.670504		0.658905		0.647833		0.63725	
	0.627124		0.617424		0.608123		0.599197		0.590621		0.582375	
	0.574439		0.566796		0.559429		0.552322		0.545463		0.538836	
	0.532431		0.526236		0.52024		0.514434		0.508809		0.503355	
	0.498064		0.492931		0.487946		0.483103		0.478397		0.473822	
	0.469371		0.465039		0.460823		0.456716		0.452715		0.448816	
	0.445014		0.441306		0.437688		0.434157		0.43071		0.427343	
	0.424054		0.420841		0.417699		0.414628		0.411624		0.408685	
	0.40581		0.402995		0.40024		0.397541		0.394898		0.392309	
	0.389772		0.387285		0.384846		0.382456		0.380111		0.377811	
	0.375554		0.37334		0.371166		0.369032		0.366937		0.364879	
IPCS_2	4.9682		4.53115		3.88116		3.28785		2.8174			
	2.45527		2.17457		1.95308		1.77483		1.6287		1.50687	
	1.40381		1.3155		1.23898		1.17201		1.11289		1.0603	
	1.0132		0.970746		0.932275		0.897238		0.865184		0.835737	
	0.808584		0.783458		0.760135		0.738421		0.71815		0.699179	
	0.681383		0.664651		0.648889		0.634011		0.619943		0.606618	
	0.593976		0.581965		0.570536		0.559648		0.54926		0.539338	
	0.529851		0.520769		0.512065		0.503717		0.495701		0.487998	
	0.480588		0.473456		0.466584		0.459958		0.453565		0.447393	
	0.441429		0.435663		0.430085		0.424685		0.419455		0.414387	
	0.409472		0.404704		0.400075		0.395581		0.391214		0.386969	
	0.382841		0.378825		0.374917		0.371111		0.367404		0.363792	
	0.36027		0.356836		0.353487		0.350218		0.347027		0.343912	
	0.340868		0.337895		0.334989		0.332148		0.329369		0.326651	
	0.323992		0.321389		0.318842		0.316347		0.313903		0.311509	

	0.309163	0.306864	0.30461	0.3024	0.300233	0.298106
	0.29602	0.293972	0.291963	0.28999	0.288052	0.28615
Tetr	4.98753	3.83974	2.38073	1.47272	0.96426	0.669393
	0.487997	0.370003	0.289515	0.232395	0.190502	0.158918
	0.134543	0.115354	0.0999851	0.0874901	0.0771975	0.0686202
	0.0613982	0.0552609	0.050002	0.0454617	0.0415149	0.0380627
	0.0350258	0.0323402	0.0299536	0.0278234	0.0259141	0.024196
	0.0226446	0.0212389	0.0199612	0.0187964	0.0177315	0.0167555
	0.0158587	0.0150327	0.0142703	0.0135651	0.0129115	0.0123045
	0.0117399	0.0112138	0.0107227	0.0102635	0.0098337	
	0.00943068	0.00905229	0.00869656	0.00836171	0.00804612	
	0.00774835	0.00746708	0.0072011	0.00694932	0.00671075	
	0.00648447	0.00626965	0.00606552	0.00587139	0.00568661	
	0.00551059	0.00534277	0.00518266	0.00502979	0.00488373	
	0.00474407	0.00461044	0.00448251	0.00435995	0.00424246	
	0.00412976	0.0040216	0.00391774	0.00381795	0.00372201	
	0.00362973	0.00354093	0.00345544	0.00337308	0.00329371	
	0.00321718	0.00314336	0.00307213	0.00300335	0.00293693	
	0.00287274	0.0028107	0.0027507	0.00269267	0.0026365	
	0.00258213	0.00252947	0.00247846	0.00242903	0.0023811	
	0.00233463	0.00228954	0.0022458	0.00220334		
lacI	10	10	10	10	10	10
	10	10	10	10	10	10
	10	10	10	10	10	10
	10	10	10	10	10	10
	10	10	10	10	10	10
	10	10	10	10	10	10
	10	10	10	10	10	10
	10	10	10	10	10	10
	10	10	10	10	10	10
lamdar	4.98753	4.95507	4.92208	4.89771	4.88075	
	4.86874	4.85997	4.85336	4.84825	4.8442	4.84095
	4.83829	4.8361	4.83426	4.83272	4.83142	4.83031
	4.82937	4.82856	4.82786	4.82727	4.82676	4.82633
	4.82596	4.82565	4.82539	4.82518	4.82501	4.82487
	4.82476	4.82468	4.82463	4.82461	4.8246	4.82461
	4.82465	4.8247	4.82476	4.82484	4.82493	4.82503
	4.82515	4.82527	4.82541	4.82555	4.8257	4.82586
	4.82602	4.8262	4.82637	4.82656	4.82675	4.82694
	4.82714	4.82735	4.82756	4.82777	4.82798	4.8282
	4.82843	4.82865	4.82888	4.82911	4.82935	4.82959
	4.82983	4.83007	4.83031	4.83056	4.83081	4.83106
	4.83131	4.83156	4.83181	4.83207	4.83233	4.83258
	4.83284	4.8331	4.83337	4.83363	4.83389	4.83416
	4.83442	4.83469	4.83496	4.83522	4.83549	4.83576
	4.83603	4.8363	4.83657	4.83684	4.83711	4.83739
	4.83766	4.83793	4.8382	4.83848	4.83875	4.83902

Commands

```
>library(GRENITS)
```

```
> data(SWITCH_ODE)
```

```
>dim(SWITCH_ODE)
```

```
>output.folder <- paste(tempdir(), "/Example_LinearNetswitch2", sep="")
```

```
> prob.file <- paste(output.folder, "/NetworkProbability_Matrix.txt", sep = "")
```

```
> LinearNet(output.folder, SWITCH_ODE)
```

```

Started MCMC chain 1 =====
MCMC chain 1 finished!
Started MCMC chain 2 =====
MCMC chain 2 finished!
> analyse.output(output.folder)
> prob.file <- paste(output.folder, "/NetworkProbability_Matrix.txt", sep = "")
> prob.mat <- read.table(prob.file)
> print(prob.mat)
> data(ipcs_ode)
> plot.ts( t(ipcs_ode), plot.type = "single", col = 1:5, xlim = c(0,65), main = "Circadian Clock Network \n
ODE simulated data", xlab = "Time (s)", ylab = "Expression")
> legend("topright", rownames(ipcs_ode), lty = 1, col = 1:5)
> library(network)
> inferred.net <- 1*(prob.mat > 0.0)
> print(inferred.net)
> inferred.net <- network(inferred.net)
> par(mfrow = c(1,2), cex = 1.76, cex.lab = 1.3, cex.main = 1.4)
> prob.vec <- sort(as.vector(as.matrix(prob.mat)), T)
> prob.vec <- prob.vec[4:0 - length(prob.vec)]
> plot(x = prob.vec, y = 1:length(prob.vec), xlim = c(0,1), main = "connection included vs Threshold", xlab =
"probability threshold", ylab = "connection included")
> lines(c(0.1,0.1), c(0,30), col = "red", lty = 2, lwd = 2)
> plot(inferred.net, label = network.vertex.names(inferred.net), main = "IPCS switch inferred
Network", mode = "circle", vertex.cex = 7, arrowhead.cex = 2, vertex.col = "green")

MCMC default parameter

"x"

"" "LinearNet"

"samples" "1e+05"

"burn.in" "10000"

```

"thin" "10"

"c" "0.5"

"d" "0.5"

"sigma.s" "2"

"a" "2"

"b" "0.01"

"sigma.mu" "2"

BoolNet commands

```
> bin<-binarizeTimeSeries(ipcs_1,method="edgeDetector")
```

```
> print(bin)
```

\$binarizedMeasurements

X1 X2 X3 X4 X5 X6 X7 X8 X9 X10 X11

ipcs_1 1 1 1 0 0 0 0 0 0 0 0

ipcs_2 1 1 1 0 0 0 0 0 0 0 0

tetr 1 1 1 0 0 0 0 0 0 0 0

laci 0 0 0 0 0 0 0 0 0 0 0

lamdar 1 0 0 0 0 0 0 0 0 0 0

\$thresholds

ipcs_1 ipcs_2 tetr laci lamdar

-0.0533765 -0.1122500 -1.4730250 NA 0.6914085

```
> reconstructed<-
```

```
reconstructNetwork(bin$binarizedMeasurements,method="bestfit",maxK=4)
```

```
> print(reconstructed)
```

Probabilistic Boolean network with 5 genes

Involved genes:

ipcs_1 ipcs_2 tetr lacI lamdar

Transition functions:

Alternative transition functions for gene ipcs_1:

$ipcs_1 = \langle f(lamdar)\{01\} \rangle$ (probability: 0.25, error: 1)

$ipcs_1 = \langle f(tetr)\{01\} \rangle$ (probability: 0.25, error: 1)

$ipcs_1 = \langle f(ipcs_2)\{01\} \rangle$ (probability: 0.25, error: 1)

$ipcs_1 = \langle f(ipcs_1)\{01\} \rangle$ (probability: 0.25, error: 1)

Alternative transition functions for gene ipcs_2:

$ipcs_2 = \langle f(lamdar)\{01\} \rangle$ (probability: 0.25, error: 1)

$ipcs_2 = \langle f(tetr)\{01\} \rangle$ (probability: 0.25, error: 1)

$ipcs_2 = \langle f(ipcs_2)\{01\} \rangle$ (probability: 0.25, error: 1)

$ipcs_2 = \langle f(ipcs_1)\{01\} \rangle$ (probability: 0.25, error: 1)

Alternative transition functions for gene tetr:

$tetr = \langle f(lamdar)\{01\} \rangle$ (probability: 0.25, error: 1)

$tetr = \langle f(tetr)\{01\} \rangle$ (probability: 0.25, error: 1)

$tetr = \langle f(ipcs_2)\{01\} \rangle$ (probability: 0.25, error: 1)

$tetr = \langle f(ipcs_1)\{01\} \rangle$ (probability: 0.25, error: 1)

Alternative transition functions for gene lacI:

$lacI = 0$ (probability: 1, error: 0)

Alternative transition functions for gene lamdar:

$lamdar = 0$ (probability: 1, error: 0)

Knocked-out and over-expressed genes:

laci = 0

lamdar = 0

> example_PBN<-reconstructed

> print(example_PBN)

Probabilistic Boolean network with 5 genes

Involved genes:

ipcs_1 ipcs_2 tetr laci lamdar

Transition functions:

Alternative transition functions for gene ipcs_1:

ipcs_1 = <f(lamdar){01}> (probability: 0.25, error: 1)

ipcs_1 = <f(tetr){01}> (probability: 0.25, error: 1)

ipcs_1 = <f(ipcs_2){01}> (probability: 0.25, error: 1)

ipcs_1 = <f(ipcs_1){01}> (probability: 0.25, error: 1)

Alternative transition functions for gene ipcs_2:

ipcs_2 = <f(lamdar){01}> (probability: 0.25, error: 1)

ipcs_2 = <f(tetr){01}> (probability: 0.25, error: 1)

ipcs_2 = <f(ipcs_2){01}> (probability: 0.25, error: 1)

ipcs_2 = <f(ipcs_1){01}> (probability: 0.25, error: 1)

Alternative transition functions for gene tetr:

tetr = <f(lamdar){01}> (probability: 0.25, error: 1)

tetr = <f(tetr){01}> (probability: 0.25, error: 1)

tetr = <f(ipcs_2){01}> (probability: 0.25, error: 1)

tetr = <f(ipcs_1){01}> (probability: 0.25, error: 1)

Alternative transition functions for gene laci:

laci = 0 (probability: 1, error: 0)

Alternative transition functions for gene lamdar:

lamdar = 0 (probability: 1, error: 0)

Knocked-out and over-expressed genes:

laci = 0

lamdar = 0

```
> net<-chooseNetwork(example_PBN,rep(1,length(example_PBN$genes)))
```

```
> attr<-getAttractors(net)
```

```
> attr
```

Attractor 1 is a simple attractor consisting of 1 state(s) and has a basin of 12 state(s):

```
|--<----|
```

```
V    |
```

```
10011 |
```

```
|    |
```

```
V    |
```

```
|-->----|
```

Genes are encoded in the following order: Gene 1 Gene 2 Gene 3 Gene 4 Gene 5

Attractor 2 is a simple attractor consisting of 3 state(s) and has a basin of 17 state(s):

```

|--<----|
V      |
00000  |
|      |
10110  |
|      |
10001  |
|      |
V      |
|-->----|

> plotAttractors(attr,subset=1)

$`1`
$`2`
NULL

> plotAttractors(attr,subset=2)

$`1`
NULL
$`2`

```

Genes are encoded in the following order: Gene 1 Gene 2 Gene 3 Gene 4 Gene 5

```

> par(mfrow=c(2,length(attractors$attractors)))
> tt <-getTransitionTable(attr)
> net <-generateRandomNKNetwork(n=5,k=5)

```

```
> print(net)
```

Boolean network with 5 genes

Involved genes:

Gene 1 Gene 2 Gene 3 Gene 4 Gene 5

Transition functions:

```
Gene 1 = <f(Gene 3, Gene 4, Gene 5, Gene 1, Gene
2){01100000011111100010101000010111}>
```

```
Gene 2 = <f(Gene 3, Gene 4, Gene 2, Gene 5, Gene
1){01001010011100011110011000011110}>
```

```
Gene 3 = <f(Gene 2, Gene 5, Gene 3, Gene 4, Gene
1){00101100101100101101111100101011}>
```

```
Gene 4 = <f(Gene 4, Gene 2, Gene 5, Gene 3, Gene
1){0001100001011011111101000001001}>
```

```
Gene 5 = <f(Gene 1, Gene 4, Gene 3, Gene 2, Gene
5){10000011101101010011100001111011}>
```

```
>path <-getPathToAttractor(net,rep(0,5))
```

```
> path
```

```
> toPajek(attr,file="net.net")
```

```
> toPajek(attr,file="net.net",includeLabels=TRUE)
```

Network file format

This section provides a full language description for the network `_le` format of BoolNet. The language is described in Extended Backus-Naur Form (EBNF).

```
Rule = GeneName Separator Boolean Expression [Separator Probability];
```

```
Boolean Expression = GeneName
```

```
    | "!" Boolean Expression
```

```
    | "(" Boolean Expression ")"
```

```
    | Boolean Expression " & " Boolean Expression
```

```
    | Boolean Expression " | " Boolean Expression;
```

GeneName =? A gene name from the list of involved genes?

Separator = ",";

Probability =? A floating-point number?