

Global dynamics of the buffered chemostat for a general class of response functions

A. Rapaport^{1,*}, I. Haidar² and J. Harmand^{3,*}

¹ MISTEA, UMR 729 INRA-SupAgro, Montpellier, France

² LSS-Supelec, Gif-sur-Yvette, France

³ LBE, INRA, Narbonne, France

* MODEMIC, INRIA Sophia-Antipolis Méditerranée, France

July 5, 2018

Abstract

We study how a particular spatial structure with a buffer impacts the number of equilibria and their stability in the chemostat model. We show that the occurrence of a buffer can allow a species to persist or on the opposite to go extinct, depending on the characteristics of the buffer. For non-monotonic response functions, we characterize the buffered configurations that make the chemostat dynamics globally asymptotically stable, while this is not possible with single, serial or parallel vessels of the same total volume and input flow. These results are illustrated with the Haldane kinetic function.

Key-words. chemostat, interconnection, multi-stability, global asymptotic stability.

AMS subject classifications. 92D25, 34D23, 93A30, 90B05.

1 Introduction

The chemostat was introduced in the fifties as an experimental device to study the microbial growth on a limiting resource [35, 38]. It is also often used as a mean to reproduce situations where (limiting) nutrients are fed to micro-organisms, typically in a liquid medium, in natural ecosystems [19, 6] or anthropized environments [27]. More generally, the chemostat is largely used as a scientific investigation tool in microbial ecology [24, 51].

The mathematical model of the chemostat has been extensively studied (see e.g. [46]) and used as a reference model in microbiology [39], microbial ecology [11] or biotechnological industries such as the wastewater treatment [8]. More generally, the chemostat serves to describe resource-consumer relations, where the resource is supplied at a constant rate. However, in many applications, the assumption of perfectly stirred chemostats is, in general, too restrictive. In the eighties, the gradostat, as an experimental device composed of a set of chemostats of identical volume interconnected in series, was introduced to represent spatial gradient [31], in a marine environment [21] or to model rhizosphere [13]. It motivated several mathematical studies [49, 23, 10, 43, 54, 45, 20, 47, 14]. Similarly, an interest for series of bioreactors appeared in biochemical industry, with tanks of different volumes to be minimized [32, 22, 5, 18, 9]. In ecology, island models have been proposed since the late sixties [33] to study the effects of heterogeneous environments with more general patterns than serial ones. Several studies of prey-predator in patchy environments have been conducted since then [26, 1]. Comparatively, relatively few studies have considered non-serial interconnections for resource-consumer models or chemostats [44]. In natural reservoirs such as in undergrounds or ground-waters, a spatial structure with interconnections between several volumes is often considered, each of them being approximated as perfectly mixed tank. Those interconnections can be parallel, series or built up in more

complex networks. To our knowledge, the influence of the topology of a network of chemostats on the overall dynamics has been sparsely investigated in the literature. However, the simple consideration of two interconnected habitats can lead to non-intuitive behaviors [48, 36, 41, 25] and influence significantly the overall performances [37, 16]. Recently, literature in ecology has raised the relevance of “source-sink” models for describing plants/nutrients interactions, and predicting ecosystems performances [29, 15, 30]. Those models are mathematically close to general gradostat models, but with a significant difference concerning the resources compartments, for which the input rate mechanisms (due to atmospheric depositions or rock alterations) are assumed to be independent of the nutrient leaching (and not modeled as a transport term as in hydrology or in chemostat-like models).

It is also well-known since the seventies that microbial growth can be inhibited by large concentrations of nutrient. Such inhibition can be modeled by non-monotonic response functions [2, 4] and lead to initial-condition dependent washout [3, 52, 28]. Non-monotonic response functions occur in predator-prey models, for instance, when the predation decreases due to the ability of the prey to better defend when their population get larger. This non-monotonic functional response could also lead to bi-stability and possible extinction of the predator [12, 53].

Several control strategies of the input flow were proposed in the literature to globally stabilize the chemostat [7, 17, 40, 42] but the ability of a spatial structure to passively stabilize such dynamics has not been yet studied (in [44] a general structure of networks of chemostats is considered but with monotonic growth rates, while in [50] non-monotonic functions are considered but for the serial gradostat only).

The present work considers a particular interconnection of two chemostats of different volumes, one being a buffer tank. To our knowledge, this spatial structure, that is neither serial nor parallel, has not yet been considered in the literature. This structure is analogous to refuges in patchy environments [1], but here both consumer and resource are present in each vessel. We prove that it is possible with such a configuration to obtain repulsive washout equilibrium, while any serial, parallel or single tank structures with the same total volume exhibits multi-stability. This result brings new insights into the role of spatial patterns in the stability of bio-conversion processes in natural environments, where buffers can occur such as in soil ecosystems. It has also potential implications for the design of robust industrial bio-processes.

The paper is organized as follows. Section 2 presents the hypotheses and the buffered configuration, comparing with serial and parallel interconnections. Section 3 studies the multiplicity of equilibria and their stability for such configurations, considering a general class of response functions (monotonic as well as non-monotonic). Section 4 discusses the biological and ecological implications of the results of Section 3 in terms of persistence of microbial species in a non-homogeneous environment, along with some industrial perspectives. Numerical simulations illustrate the results on an Haldane function in Section 5. All the proofs are postponed to the Appendix.

2 General considerations

We consider the chemostat model with a single strain growing on a single limiting nutrient. The system is fed with nutrient of concentration S_{in} with flow rate Q . The total volume V is assumed to be constant (i.e. input and output flow rates are supposed to be identical). When the concentrations of nutrient (or substrate) and biomass, denoted respectively S and X , are homogeneous, as it is the case in perfectly mixed tanks, the system can be modeled by the well-known differential equations:

$$\begin{aligned}\dot{S} &= -\frac{\mu(S)}{Y}X + \frac{Q}{V}(S_{in} - S), \\ \dot{X} &= \mu(S)X - \frac{Q}{V}X,\end{aligned}\tag{1}$$

where $\mu(\cdot)$ is the uptake function and Y the yield coefficient of the transformation of nutrient into biomass. Without any loss of generality, we take $Y = 1$ (at the price of changing X in YX). For convenience, we define the dilution rate

$$D = \frac{Q}{V}.$$

We consider quite general uptake functions, that fulfill the following properties.

Assumptions A1.

- i The function $\mu(\cdot)$ is analytic and such that $\mu(0) = 0$, $\mu(S) > 0$ for any $S > 0$.
- ii The function $\mu(\cdot)$ is either increasing, or there exists $\hat{S} > 0$ such that $\mu(\cdot)$ is increasing on $(0, \hat{S})$ and decreasing on $(\hat{S}, +\infty)$.

The usual uptake functions, such as the Monod function [35]

$$\mu(S) = \frac{\mu_{\max} S}{K_s + S}, \quad (2)$$

or the Haldane one [2]

$$\mu(S) = \frac{\bar{\mu} S}{K + S + S^2/K_I}, \quad (3)$$

fulfill these hypotheses. Classically, we consider the set

$$\Lambda(D) = \{S > 0 \mid \mu(S) > D\} \quad (4)$$

that plays an important role in the determination of the equilibria of the system. Under Assumptions A1, the set $\Lambda(D)$ is either empty or an open interval that we denote

$$\Lambda(D) = (\lambda_-(D), \lambda_+(D)),$$

where $\lambda_+(D)$ can be equal to $+\infty$.

We recall from the theory of the chemostat model (see for instance [46]) that under Assumptions A1 there are three kinds of phase portrait of the dynamics (1), depending on the parameter S_{in} .

Proposition 1. *Assume that Hypotheses A1 are fulfilled.*

- Case 1: $\Lambda(D) = \emptyset$ or $\lambda_-(D) \geq S_{in}$. The washout equilibrium $E_0 = (S_{in}, 0)$ is the unique non negative equilibrium of system (1). Furthermore it is globally attracting.
- Case 2: $S_{in} > \lambda_+(D)$. The system (1) has three non-negative equilibria $E_-(D) = (\lambda_-(D), S_{in} - \lambda_-(D))$, $E_+(D) = (\lambda_+(D), S_{in} - \lambda_+(D))$ and $E_0 = (S_{in}, 0)$. Only $E_-(D)$ and E_0 are attracting, and the dynamics is bi-stable.
- Case 3: $S_{in} \in \Lambda(D)$. The system (1) has two non negative equilibria $E_-(D) = (\lambda_-(D), S_{in} - \lambda_-(D))$ and $E_0 = (S_{in}, 0)$. $E_-(D)$ is globally attracting on the positive quadrant.

Notice that in case 2, the qualitative behavior of the growth can change radically depending on the initial condition.

The question we investigate in this paper is related to the assumption that the vessel is perfectly mixed, and to the role that a spatial structure could have on the stability of the dynamics. Consider the case for which the washout equilibrium is attracting in the chemostat model (cases 1 and 2 of Proposition 1). Furthermore, consider spatial configurations with the same input flow and residence time than the perfectly mixed case, i.e. with the same total volume V and input flow Q . Then, one has the following property.

Lemma 1. *Assume that Hypotheses A1 are fulfilled and let Q and V be such that $S_{in} \notin \Lambda(D)$. Then the washout is an attracting equilibrium in at least one vessel of any interconnection in series or in parallel of n tanks of volume V_i such that $\sum_{i=1}^n V_i = V$, assuming that each of them is perfectly mixed.*

This Lemma shows that when a bacterial species cannot persist in a chemostat, from any or a subset of initial conditions, this property persists in at least one vessel of any serial or parallel interconnection of chemostats with the same total volume. In the present work, we study a different kind of spatial configuration with an asymmetry created by two interconnected volumes, one of them serving as a buffer (see Figure 1). We call these spatial configurations a “buffered chemostat”, to be compared with the “single chemostat”. V_1

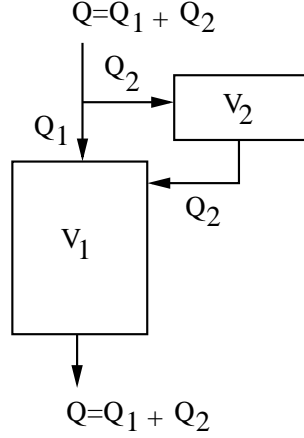

Figure 1: The buffered chemostat.

and V_2 are respectively the volumes of the main tank and the buffer, and Q_1 and Q_2 denote the input flow rates of each tank, with $Q = Q_1 + Q_2$. We assume that each vessel is perfectly mixed. Straightforwardly, the dynamical equations of the buffered chemostat are

$$\begin{aligned}
 \dot{S}_1 &= -\mu(S_1)X_1 + \frac{Q_1 S_{in} + Q_2 S_2 - QS_1}{V_1}, \\
 \dot{X}_1 &= \mu(S_1)X_1 + \frac{Q_2 X_2 - QX_1}{V_1}, \\
 \dot{S}_2 &= -\mu(S_2)X_2 + \frac{Q_2 S_{in} - Q_2 S_2}{V_2}, \\
 \dot{X}_2 &= \mu(S_2)X_2 - \frac{Q_2 X_2}{V_2}.
 \end{aligned} \tag{5}$$

Notice that the limiting case $V_1 = 0$ consists in a by-pass of the volume V_2 with a flow Q_1 .

In the next Section, we study the equilibria of this model, their multiplicity and their stability.

3 Analysis of the dynamics of the buffered chemostat

Given a volume V and an input flow rate Q , we describe the set of all possible buffered configurations with $Q = Q_1 + Q_2$ and $V = V_1 + V_2$ by two parameters $r \in (0, 1)$ and $\alpha > 0$ defined as follows

$$r = \frac{V_1}{V}, \quad \alpha = \frac{Q_2}{(1-r)Q}.$$

This choice of parameterization is more convenient than the original one because it decouples more easily the role of the two parameters, as it is shown by equations (6) below.

Dynamics (5) can then be written in the following way

$$\begin{aligned}
\dot{S}_1 &= -\mu(S_1)X_1 + D\frac{\alpha(1-r)(S_2 - S_1) + (1 - \alpha(1-r))(S_{in} - S_1)}{r}, \\
\dot{X}_1 &= \mu(S_1)X_1 + D\frac{\alpha(1-r)(X_2 - X_1) - (1 - \alpha(1-r))X_1}{r}, \\
\dot{S}_2 &= -\mu(S_2)X_2 + D\alpha(S_{in} - S_2), \\
\dot{X}_2 &= \mu(S_2)X_2 - D\alpha X_2.
\end{aligned} \tag{6}$$

At equilibrium, one should have $\dot{S}_2 + \dot{X}_2 = \alpha D(S_{in} - S_2 - X_2) = 0$ that is $S_2 + X_2 = S_{in}$. Then, one should have $\dot{S}_1 + \dot{X}_1 = D(S_{in} - S_1 - X_1)/r = 0$ that is $S_1 + X_1 = S_{in}$. Thus, equilibria $(S_1^*, X_1^*, S_2^*, X_2^*)$ of dynamics (6) can be written as solutions of the following equations:

$$1 + \frac{1-r}{r} \left(1 - \alpha \frac{S_{in} - S_2^*}{S_{in} - S_1^*}\right) = \frac{\mu(S_1^*)}{D} \text{ or } \{S_1^* = S_{in} \text{ when } S_2^* = S_{in}\}, \tag{7}$$

$$X_1^* = S_{in} - S_1^*, \tag{8}$$

$$\alpha = \frac{\mu(S_2^*)}{D} \text{ or } S_2^* = S_{in}, \tag{9}$$

$$X_2^* = S_{in} - S_2^*. \tag{10}$$

Due to the cascade structure of model (5), the study of the dynamics of the second reactor can be done independently of the first one. Depending of the value of α , the three cases given in Proposition 1 for the single chemostat are possible in the second tank. This implies the following two possibilities for the equilibria of the first sub-system.

1. When $(S_2(\cdot), X_2(\cdot))$ converges to the washout equilibrium (cases 1 and 2), the (S_1, X_1) dynamics is asymptotically equivalent to a single chemostat model with dilution rate D/r , and Proposition 1 applies.
2. When $(S_2(\cdot), X_2(\cdot))$ converges towards a positive equilibrium $(S_2^*(\alpha), S_{in} - S_2^*(\alpha))$ (cases 2 and 3), we consider the family of hyperbola $H_{\alpha,r}$ that are the graphs of the functions

$$\phi_{\alpha,r}(s) = 1 + \frac{1-r}{r} \left(1 - \alpha \frac{S_{in} - S_2^*(\alpha)}{S_{in} - s}\right) \tag{11}$$

parameterized by α and $r \in (0, 1)$. From equations (7) and (8), a positive equilibrium (S_1^*, X_1^*) of (6) satisfies

$$\phi_{\alpha,r}(S_1^*) = \mu(S_1^*)/D \tag{12}$$

or equivalently S_1^* is the abscissa of an intersection of the graph of $\mu(\cdot)/D$ with the hyperbola $H_{\alpha,r}$. Then, from equation (8), to each solution S_1^* corresponds a unique $X_1^* = S_{in} - S_1^*$. Notice that the washout is not an equilibrium for the first tank.

In the following, we consider only non-trivial cases for which the second tank admits a positive equilibrium, assuming the hypotheses:

Assumptions A2. Under Assumptions A1, D and α are positive numbers such that $\Lambda(\alpha D) \neq \emptyset$ and $\lambda_-(\alpha D) < S_{in}$.

Similar to the single chemostat that considers the set $\Lambda(D)$ given in (4), we define the set

$$\Gamma_{\alpha,r}(D) = \{S \in (0, S_{in}) \mid \mu(S) > D\phi_{\alpha,r}(S)\}. \tag{13}$$

We shall also consider the subset of configurations for which system (6) admits an unique positive equilibrium, denoted by

$$\bar{R}_\alpha(D) = \{r \in (0, 1) \mid \exists! s \in (0, S_{in}) \text{ s.t. } D\phi_{\alpha,r}(s) = \mu(s)\} . \quad (14)$$

We state now our main results.

Theorem 1. *Assume that Hypotheses A1 and A2 are fulfilled. The set $\Gamma_{\alpha,r}(D)$ is non-empty, and for almost any $r \in (0, 1)$ one has the following properties, except from a subset of initial conditions of zero Lebesgue measure.*

- i. When the initial condition of the (S_2, X_2) sub-system belongs to the attraction basin of $(S_{in}, 0)$, the solution (S_1, X_1) of system (6) converges exponentially to the rest point $(\lambda_-(D/r), S_{in} - \lambda_-(D/r))$ when $\lambda_-(D/r) < S_{in}$, or to the washout equilibrium when $\mu(S_{in}) < D/r$.*
- ii. When the initial condition of the (S_2, X_2) sub-system does not belong to the attraction basin of $(S_{in}, 0)$, the trajectory of the system (6) converges exponentially to a positive equilibrium $(S_1^*, S_{in} - S_1^*, \lambda_-(\alpha D), S_{in} - \lambda_-(\alpha D))$ where S_1^* is the left endpoint of a connected component of $\Gamma_{\alpha,r}(D)$.*

Moreover, the set $\bar{R}_\alpha(D)$ is non-empty.

Let give some observations on these results.

- In contrast to the single chemostat, for which the set $\Lambda(D)$ could be empty, the set $\Gamma_{\alpha,r}(D)$ is non-empty. This means that dynamics (6) always admits a positive equilibrium, even when the washout is the only equilibrium of the single chemostat, contrary to serial or parallel chemostats (cf Lemma 1).
- When the initial condition of the (S_2, X_2) sub-system belongs to the attraction basin of $(S_{in}, 0)$ (that could be reduced to a singleton), it is a not a surprise that the asymptotic behavior of the sub-system (S_1, X_1) is the same as for a single chemostat with a dilution rate equal to D/r (cf point i.). Otherwise, the whole state converges to a positive equilibrium, with a possible multiplicity of equilibria (cf point ii.). Here, a remarkable feature is the existence of buffered configurations (α, r) that possess an unique globally asymptotically stable equilibrium (when $\alpha D < \mu(S_{in})$ and $r \in \bar{R}_\alpha(D)$), in contrast to the single chemostat or any serial or parallel configurations for which a bi-stability occur when the functional response is non-monotonic.

To help grasp the geometric condition (12) that is the key for the characterization of the equilibria, we introduce the number

$$\underline{S}(\alpha) = \alpha S_2^*(\alpha) + (1 - \alpha)S_{in} , \quad (15)$$

that fulfills the remarkable property

$$\phi_{\alpha,r}(\underline{S}(\alpha)) = 1, \quad \forall r \in (0, 1) .$$

We first explicit the condition (12) on the specific case of the Haldane function (3):

$$D(S_{in} - s - \alpha(1 - r)(S_{in} - S_2^*(\alpha))(K + s + s^2/K_I) = r\bar{\mu}s(S_{in} - s) . \quad (16)$$

S_1^* is then a root of a polynomial P of degree 3. So there exist at most three solutions of $\phi_{\alpha,r}(s) = \mu(s)/D$. For small values of r , we remark that $\phi_{\alpha,r}(0)$ is very large and $\phi_{\alpha,r}$ has a high slope. On the contrary, for r near to 1, $\phi_{\alpha,r}(0)$ is closed to 1 and $\phi_{\alpha,r}$ has a light slope. Intuitively, we expect to have only one root for small values of r and three for large values of r . For \bar{r} such that there exists a solution S_1^* of $\phi_{\alpha,\bar{r}}(s) = \mu(s)/D$ and $\phi'_{\alpha,\bar{r}}(s) = \mu'(s)$, one has $P(S_1^*) = 0$ and $P'(S_1^*) = 0$, that is S_1^* is a double root of P (and there exists at most one such double root because P is of degree 3). At such S_1^* , the hyperbola $H_{\alpha,\bar{r}}$ is tangent to the graph of $\mu(\cdot)$. Intuitively, this corresponds to the limiting case for the parameter r in between cases for which there is one or three roots (see Figures 2 and 3 where tangent hyperbola are drawn in thick line).

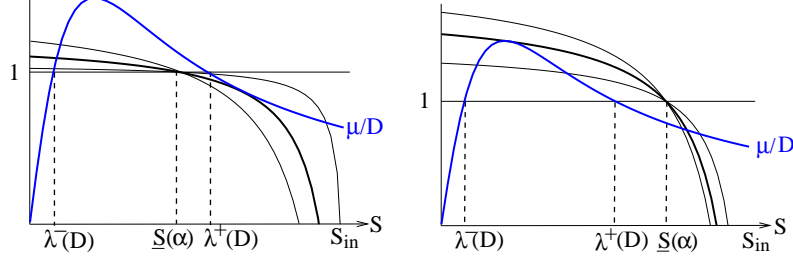

Figure 2: Subset of functions $\phi_{\alpha,r}(\cdot)$ when $\underline{S}(\alpha) < \lambda_+(D)$ (on the left) and $\underline{S}(\alpha) > \lambda_+(D)$ (on the right), illustrated with an Haldane function (when $\lambda_+(D) < S_{in}$) [parameters: $\bar{\mu} = 12$, $K = 1$, $K_I = 0.1$, $S_{in} = 2$, $D = 1.1$, $\alpha = 0.64$ (left) / 0.36 (right)].

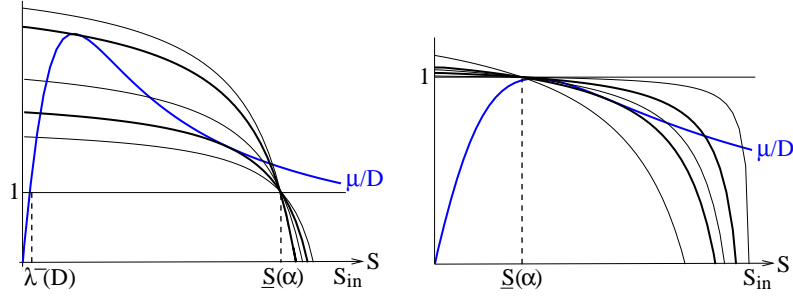

Figure 3: Subset of functions $\phi_{\alpha,r}(\cdot)$ illustrated with an Haldane function when $\lambda_-(D) < S_{in} < \lambda_+(D)$ (on the left) and when $\Lambda(D) = \emptyset$ (on the right) [parameters: $\bar{\mu} = 12$, $K = 1$, $K_I = 0.1$, $S_{in} = 2$ (left) / 1 (right), $D = 0.5$ (left) / 1.65 (right), $\alpha = 0.2$ (left) / 0.9 (right)].

To formalize these observations for more general growth functions $\mu(\cdot)$ that fulfill Assumptions A1, we consider the set of s at which the hyperbola $H_{\alpha,r}$ is tangent to the graph of the function $\mu(\cdot)/D$ and is locally on one side (that amounts to have 0 as a local extremum of the function $\phi_{\alpha,r}(\cdot) - \mu(\cdot)/D$ at s):

$$\mathcal{S}_{\alpha,r}(D) = \left\{ s \in (0, S_{in}) \text{ s.t. } \min \left\{ n \in \mathbb{N} \mid D \frac{d^n \phi_{\alpha,r}}{ds^n}(s) \neq \frac{d^n \mu}{ds^n}(s) \right\} \text{ is even and larger than } 1 \right\} \quad (17)$$

along with the set

$$R_\alpha(D) = \{r \in (0, 1) \text{ s.t. } \mathcal{S}_{\alpha,r}(D) \neq \emptyset\} . \quad (18)$$

One can distinguish two cases:

1. *The single chemostat has only one attracting equilibrium.* Tangencies of the graphs of $\phi_{\alpha,r}$ and μ could occur for certain values of r (see Figure 3 as an illustration), leading to non-empty set $R_\alpha(D)$ and multi-equilibria. Another remarkable feature is that the buffer could create a multiplicity of equilibria.
2. *The single chemostat presents a bi-stability.* The function μ is necessarily non-monotonic on $(0, S_{in})$ and a tangency of the graphs of $\phi_{\alpha,r}$ and μ always occurs for a certain r with an abscissa that is located
 - either at the right of λ_+ when $\underline{S}(\alpha) < \lambda_+(D)$ (see the right picture of Figure 2),
 - either at the left of λ_+ when $\underline{S}(\alpha) > \lambda_+(D)$ (see the left picture of Figure 2).

In the Appendix, more properties on the sets $R_\alpha(D)$ and the multiplicity of equilibria are given in the Proposition 2.

Remark 1. Under the conditions of Theorem 1, consider the number

$$\bar{r}_D(\alpha) = \sup \bar{R}_\alpha(D) \quad (19)$$

that guarantees that for any (r, α) with $r < \bar{r}_D(\alpha)$, the buffered chemostat model admits a unique (globally asymptotically stable) positive equilibrium.

The map $(\alpha, r) \mapsto S_1^*(\alpha, r)$, where $S_1^*(\alpha, r)$ is the unique solution of (12) on $(0, S_{in})$, is clearly continuous and one can then consider the limiting map:

$$\bar{S}_1^*(\alpha) = \lim_{r < \bar{r}_D(\alpha), r \rightarrow \bar{r}_D(\alpha)} S_1^*(\alpha, r) .$$

When $\lambda_+(D) < S_{in}$, one has $\bar{S}_1^*(\alpha) \leq \lambda_+(D)$ (resp. $\bar{S}_1^*(\alpha) \geq \lambda_+(D)$) when $\underline{S}(\alpha) < \lambda_+(D)$ (resp. $\underline{S}(\alpha) > \lambda_+(D)$). Consider, if it exists, a value of α , denoted by $\underline{\alpha}$, that is such that $\underline{S}(\underline{\alpha}) = \lambda_+(D)$. Although one has $\phi_{\underline{\alpha}, r}(\lambda_+(D)) = \mu(\lambda_+(D))/D$ for any r , there is no reason to have

$$\lim_{\alpha < \underline{\alpha}, \alpha \rightarrow \underline{\alpha}} \bar{S}_1^*(\alpha) = \lambda_+(D) \quad \text{or} \quad \lim_{\alpha > \underline{\alpha}, \alpha \rightarrow \underline{\alpha}} \bar{S}_1^*(\alpha) = \lambda_+(D) .$$

Consequently, the map $\alpha \mapsto \bar{r}_D(\alpha)$ might be discontinuous at such point $\underline{\alpha}$. In Section 5, the non-continuity of the map $\alpha \mapsto \bar{r}_D(\alpha)$ is illustrated on the Haldane function.

4 Discussion and comparison with the single chemostat

In this Section, we discuss the applications of Theorem 1 in terms of ecological and biotechnological implications for different buffered configurations.

4.1 From an ecological point of view

To better grasp the difference brought by a buffered spatialization compared to a perfectly-mixed environment, we distinguish two main cases depending on the washout if it is an attracting equilibrium or not in the single chemostat.

4.1.1 Washout is attracting in a single chemostat

Such situation corresponds to Cases 1 or 2 of Proposition 1 :

- either the washout is the only equilibrium (and is necessarily attracting). This happens when the dilution rate D is too high or the input concentration S_{in} too low, that is when one has $D > \mu(S)$ for any $S \in [0, S_{in}]$,
- either the growth function $\mu(\cdot)$ is non-monotonic on $(0, S_{in})$ with an non-empty set $\Lambda(D)$ such that $\lambda_+(D) < S_{in}$. The system admits then two attracting equilibria: a positive one and the washout.

For both cases, Theorem 1 shows that there exist buffered configurations (α, r) (with $S_{in} \in (\alpha D)$ and $r \in \bar{R}_\alpha(D)$) such that the overall dynamics has an unique globally stable positive equilibrium. Recall, from Lemma 1, that any species cannot persist in both tanks with a serial or parallel configuration of the same total volume, differently to the buffered interconnection. This property demonstrates that a simple (but particular) spatial structure such as the buffered one can explain the persistence of a species in an environment that is unfavorable if it was homogeneous.

Furthermore, Theorem 1 shows that in absence of initial biomass in the main tank, a species seeded in the buffer can invade and persist in the main tank. We conclude that a buffer can play the role of a refuge.

4.1.2 Single chemostat has a unique positive equilibrium

We are in the conditions of Case 3 of Proposition 1. Let us distinguish monotonic and non-monotonic response functions.

- When $\mu(\cdot)$ is monotonic on the interval $(0, S_{in})$, any buffered configuration admits a unique positive equilibrium (function $\alpha_{\alpha,r}(\cdot)$ being decreasing, there exists a unique intersection of the graphs of $\mu(\cdot)/D$ and $\alpha_{\alpha,r}(\cdot)$), that is globally asymptotically stable. In terms of species survival and stability, there is no difference with the single chemostat.
- When $\mu(\cdot)$ is non-monotonic on the interval $(0, S_{in})$, one can consider values $\alpha > 1$ such that $\lambda_+(\alpha D) < S_{in}$. Then, the washout equilibrium is attracting in the buffer vessel. For initial conditions in its attraction basin, the main tank behaves asymptotically as a single chemostat with a supply rate (or dilution rate) equal to D/r . For r small enough one can have $S_{in} \notin \Lambda(D/r)$ or even $\Lambda(D/r) = \emptyset$. In those cases, the washout becomes an attracting equilibrium of the overall dynamics.

When the parameter α is such that the buffer has a unique positive equilibrium, Theorem 1 shows that it is possible to have multiple equilibria. For instance, the set $\Gamma_{\alpha,r}(D)$ can have two connected components (as illustrated on Figure 3). In this case, the system has three positive equilibria: the two endpoints of the first connected component and the left endpoint of the second one. According to Theorem 1, the first and third equilibria are attracting while the second is not. Thus species persist in both tanks but the particular spatial structure can lead to several regimes of conversion at steady state, differently to a perfectly mixed vessel of the same total volume. Here, the buffer is playing the opposite role of a refuge: it highlights the fragility of a species to persist.

Finally, we have shown that the buffered configuration can have positive or negative effects on the stability of an ecosystem, depending on the characteristics of the buffer (size and flow rate). It can globally stabilize a dynamics that is bi-stable in a perfectly mixed environment and avoid then the washout of the biomass. At the opposite, a buffer can create a multi-stability or even leads to a complete washout, while the dynamics has a positive globally asymptotically stable equilibrium in perfectly mixed conditions.

4.2 From a biotechnological point of view

A typical field of biotechnological applications is the waste-water treatment with micro-organisms. For such industries, a usual objective is to reduce the output concentration of substrate that is pumped out from the main tank. Typically, a species that is selected to be efficient for low nutrient concentrations could present a growth inhibition for large concentrations (its growth rate being thus non-monotonic). Usually, the input concentration S_{in} is imposed by the industrial discharge and cannot be changed, but the flow rate Q can be manipulated. During the initial stage of continuous stirred bioreactors (that are supposed to be perfectly mixed), the biomass concentration is most often low (and the substrate concentration large). This means that there exists a risk that the initial state belongs to the attraction basin of the washout equilibrium if one immediately applies the nominal flow rate Q . Such situation could also occurs during nominal functioning, under the temporary presence of a toxic material that could rapidly deplete part of the microbial population, and leave the substrate concentration higher than expected. Those situations are well known from the practitioners: the process needs to be monitoring with the help of an automatic control that makes the flow rate Q decreasing in case of deviation toward the washout. But such a solution requires an upstream storage capacity when reducing the nominal flow rate, that could be costly. Keeping a constant input flow rate is thus preferable. An alternative is to oversize the volume of the tank so that there is no longer bi-stability and no need for a controller. Compared to these two solutions, a design with a main tank and a buffer (that guarantees a unique positive and globally asymptotically stable equilibrium) presents several advantages:

- it does not require to oversize the main tank,

- it does not require any upstream storage and the implementation of a controller,
- it allows to seed the initial biomass in the buffer tank only.

Notice that a by-pass of a single chemostat is also a way to reduce the effective flow rate and to avoid a washout. It happens to be a particular case of the buffered configuration with $V_1 = 0$.

Nevertheless, there is a price to pay to obtain the global stability over the single bi-stable tank configuration:

- i. if the buffered configuration has the same total volume than the single chemostat, then the output concentration at steady state S_1^* would be higher than $\lambda_-(D)$, meaning that the buffered configuration would be less efficient than the single chemostat at its (locally asymptotically) stable positive equilibrium.
- ii. to obtain the same nominal output $\lambda_-(D)$ with a buffered configuration, one needs to have a larger total volume.

However, considering a single chemostat of volume V that presents a bi-stability (that is when $\Lambda(D) \neq \emptyset$ and $\lambda_+(D) < S_{in}$), one can compare the minimal volume increment required to obtain a single positive globally asymptotically stable equilibrium by one of the following scenarios:

Scenario 1: enlarging the volume of the single chemostat by ΔV .

Scenario 2: adding a buffer of volume V_2 .

For the first strategy, this amounts to have a new dilution rate equal to $D/(1 + \frac{\Delta V}{V})$. Then, the condition to be in Case 3 of Proposition 1 is to have

$$S_{in} \in \Lambda\left(\frac{D}{1 + \frac{\Delta V}{V}}\right),$$

or equivalently

$$\frac{\Delta V}{V} > \left(\frac{\Delta V}{V}\right)_{\inf} = \frac{D}{\mu(S_{in})} - 1. \quad (20)$$

For the second strategy, one has to choose first the dilution rate $D_2 = Q_2/V_2$ of the buffer (with $Q_2 < Q$). For any positive number $D_2 < \mu(S_{in})$, there exists a unique positive equilibrium $(S_2^*(D_2), S_{in} - S_2^*(D_2))$ in the buffer, where

$$S_2^*(D_2) = \lambda_-(D_2) < \bar{s} = \lambda_-(\mu(S_{in})).$$

The Proposition 3, given in the Appendix, provides an explicit lower bound on the volume V_2 to ensure a unique globally exponentially stable positive equilibrium from any initial condition with $S_2(0) > 0$. Furthermore, this bound is necessarily such that

$$\left(\frac{V_2}{V}\right)_{\inf} < \left(\frac{\Delta V}{V}\right)_{\inf}.$$

The benefit of Scenario 2 over Scenario 1 in terms of volume increment will be numerically demonstrated in Section 5.

5 A numerical illustration

In this section, we illustrate numerically the stabilizing effect of a buffer. We consider the case of the single chemostat model that presents a bi-stability (see the discussion in 4.1.1), with a non-monotonic uptake function given by the Haldane expression (3). One can easily check that for this function the set $\Lambda(D)$ defined in (4) is non-empty exactly when the condition

$$\bar{\mu}/D > 1 + 2\sqrt{\frac{K}{K_I}}$$

is fulfilled. Then, $\lambda_-(D)$, $\lambda_+(D)$ are given by the following expressions:

$$\lambda_{\pm}(D) = \frac{K_I(\bar{\mu}/D - 1) \pm \sqrt{K_I^2(\bar{\mu}/D - 1)^2 - 4KK_I}}{2}.$$

Bi-stability occurs when the condition $S_{in} > \lambda_+(D)$ is fulfilled (case 2 of Proposition 1).

Recall from Section 3, that for the Haldane function, the solutions of the equation (12) are roots of a polynomial of order 3 with at most three solutions of (16). There is at most one double root, which implies that the set $\mathcal{S}_{r,\alpha}(D)$ possesses at most one element. Proposition 2 (case II), given in the Appendix, helps to characterize the set $\bar{R}_{\alpha}(D)$ depending on the subsets $R_{\alpha}^-(D)$, $R_{\alpha}^+(D)$ that are defined in this Proposition:

- the set $R_{\alpha}^+(D)$ is a singleton, because there are at most three equilibria,
- $R_{\alpha}^-(D) \cap R_{\alpha}^+(D) = \emptyset$ because $\mathcal{S}_{r,\alpha}(D)$ possesses at most one element,
- when $R_{\alpha}^-(D)$ is non-empty, one has $\max R_{\alpha}^-(D) < \min R_{\alpha}^+(D)$: for any $r \in (\min R_{\alpha}^-(D), \max R_{\alpha}^-(D))$, equation (12) has at least three solutions on an interval I , and for $r \in (\min R_{\alpha}^+(D), 1)$ at least two on another interval J , where I and J are disjoint. If $\max R_{\alpha}^-(D) \geq \min R_{\alpha}^+(D)$, there would exist at least five solutions of equation (12) on $(0, S_{in})$.

We study now the set of “stable” buffered configurations \mathcal{C}_D as the set of pairs (α, r) such that the buffered chemostat model admits a unique positive equilibrium. The upper boundary of \mathcal{C}_D is thus given by the curve

$$\alpha \in (0, \mu(S_{in})/D] \mapsto \bar{r}_D(\alpha)$$

where $\bar{r}_D(\alpha)$ is the single element of the set $R_{\alpha}^+(D)$. Notice that the limiting case $\alpha D = \mu(S_{in})$ can have also global stability (see Lemma 2 in the Appendix). The number $\bar{r}_D(\alpha)$ can then be determined numerically as the unique minimizer of the function

$$F_{\alpha}(r, s) = (\mu(s)/D - \phi_{\alpha,r}(s))^2 + (\mu'(s)/D - \phi'_{\alpha,r}(s))^2$$

on $(0, 1) \times \{s \in (\lambda^-(D), S_{in}) \text{ s.t. } (s - \lambda^+(D))(\lambda^+(D) - \underline{S}(\alpha)) \geq 0\}$ that is, for the Haldane function:

$$F_{\alpha}(r, s) = \left(\frac{(\bar{\mu}/D)s}{K + s + s^2/K_I} - \frac{1}{r} + \alpha \frac{1 - r}{r} \frac{S_{in} - \lambda_-(\alpha D)}{S_{in} - s} \right)^2 + \left(\frac{\bar{\mu}/D(K - s^2/K_I)}{(K + s + s^2/K_I)^2} + \alpha \frac{1 - r}{r} \frac{S_{in} - \lambda_-(\alpha D)}{(S_{in} - s)^2} \right)^2$$

where $\underline{S}(\alpha)$ is defined in (15). For the parameters given in Table 1, we have computed numerically the domains \mathcal{C}_D for different values of S_{in} , depicted on Figure 4. One can see that the map $\alpha \mapsto \bar{r}_D(\alpha)$ is

$\bar{\mu}$	D	K	K_I	$\lambda_-(D)$	$\lambda_+(D)$
12	1	1	0.8	$\simeq 0.103$	$\simeq 0.777$

Table 1: Parameters of the Haldane function and the corresponding values of $\lambda_-(D)$, $\lambda_+(D)$.

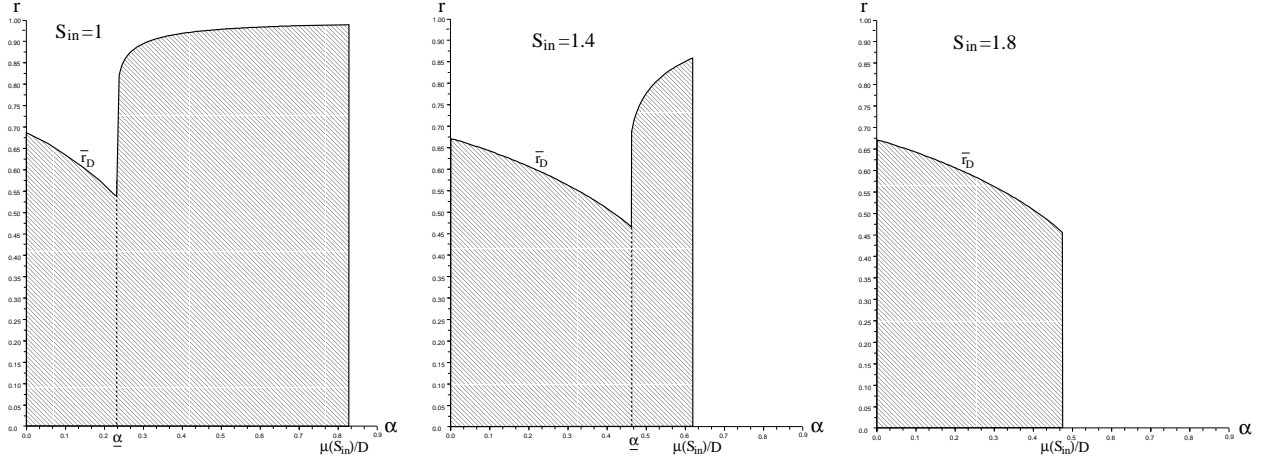

Figure 4: Domain \mathcal{C}_D of stable configurations for different values of S_{in} .

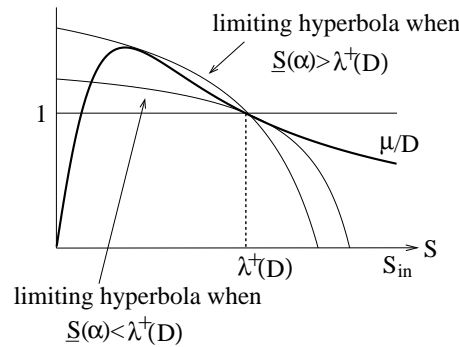

Figure 5: The limiting hyperbolas $H_{\alpha, \bar{r}(\alpha)}$ about $\alpha = \underline{\alpha}$ (for $S_{in} = 1.4$).

discontinuous at $\alpha = \underline{\alpha}$, where $\underline{\alpha}$ is such that $\underline{S}(\alpha) = \lambda_+(D)$ (when it exists), as mentioned in Remark 1. On Figure 5 one can see that the two limiting hyperbolas $H_{\alpha, \bar{r}(\alpha)}$ about $\underline{\alpha}$ are different in a such a case. So, this study reveals the role of the input concentration S_{in} on the shape of the domain \mathcal{C}_D .

Finally, we have compared the two scenarios discussed in 4.2 for improving the stability of the single chemostat, by enlarging its volume or adding a buffer, given respectively by formulas (20) and (32). For the parameters given in Table 1, the numerical comparison is reported on Figure 6 as a function of the input concentration S_{in} .

As expected, the buffered chemostat requires less volume augmentation, but one can also discover that this advantage becomes more significant as the input concentration S_{in} is higher. Finally, this study demonstrates on a concrete example the flexibility of the buffered chemostat in the choice of possible configurations, with two parameters to be tuned (instead of one for the single chemostat).

6 Conclusion

The present analysis illustrates how the addition of a buffer to chemostat alters the multiplicity and stability of their equilibria. This property has several impacts on theoretical ecology as well as for bio-industrial

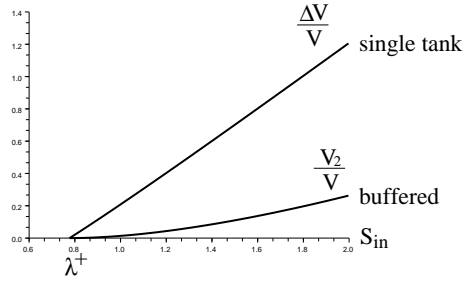

Figure 6: Comparison of the minimal increase of volume required to obtain the global stability (as function of the input concentration).

applications.

- From an ecological viewpoint, a spatial pattern with a buffer can explain why a species can persist in an environment that is unfavorable if it was perfectly mixed. On the opposite, the emergence of a buffer with particular characteristics can destabilize a regime that is stable under perfectly mixed conditions, and could lead to the extinction of the species. Nevertheless, such a case occurs only for “fragile” species with non-monotonic response function.
- For industrial applications, such as waste-water purification or pharmaceutical production, a buffered configuration of two tanks, instead of one or serial or parallel interconnections, present several advantages when there is an inhibition in the growth rate. It provides an easy and robust way to prevent the washout of the biomass in the process, without requiring upstream storage or real-time controller.

The numerical study has also revealed other interesting characteristics of the buffered chemostat. First, the size of the “buffer” or the additional tank that provide such properties could be relatively small. Secondly, the shape of the set of buffered configurations that provide a unique (globally asymptotically stable) positive equilibrium depends on the density of the supplied resource, with a threshold that makes this shape non smooth.

Finally, those results provide new insights on the role of spatial structures in resource/consumer models for natural ecosystems, and new potential strategies for the design of industrial bioprocesses. Of course, more complex interconnections could be considered, with for instance an additional output from the buffer. However, the main contribution of the present work is to show that a simple configuration with only two parameters can change radically the overall dynamic behavior. The buffered chemostat appears to be the simplest pattern that can provide global stability, while any serial or parallel configurations cannot do.

Our study considered a single strain. According to the Competitive Exclusion Principle, it is not (generically) possible to have more than one species persisting in the buffer tank, but this does not prevent to have coexistence with another species in the main tank, which is not possible with a single chemostat. Consequently, it might be relevant to study the dynamics of the buffered chemostat with different persistent species in the buffer and in the main tank.

Acknowledgments

The authors are grateful to INRA and INRIA supports within the French VITELBIO (VIRtual TELluric BIOreactors) research program. The authors thank also Prof. Denis Dochain, CESAME, Univ. Louvain-la-Neuve, for fruitful discussions. The authors would also like to thank the anonymous referees for their relevant suggestions for improvements of our initial work.

Appendix

Proof of Lemma 1.

In the serial connection, the dynamics of the first tank of volume V_1 is given by equations (1) where V is replaced by $V_1 \leq V$. Its dilution rate is then equal to Q/V_1 , that is greater than Q/V and consequently one has $S_{in} \notin \Lambda(Q/V_1)$. According to Proposition 1, only Cases 1 or 2 can occur in the first tank.

In the parallel connection, the dynamics of each tank of volume V_i and flow rate Q_i is given by equations (1) where V and Q are replaced by V_i and Q_i . Denote $r_i = V_i/V$ and $\alpha_i = Q_i/Q$, and notice that one has $\sum_i r_i = \sum_i \alpha_i = 1$. Then, the dilution rate D_i in the tank i is equal to $\alpha_i/r_i D$. According to Proposition 1, a necessary condition for having the washout equilibrium repulsive in each tank is to have $D_i < D$ for any i , that is $\alpha_i < r_i$, which contradicts $\sum_i r_i = \sum_i \alpha_i = 1$. \square

Before giving the proof of Theorem 1, we present in the next proposition a series of results concerning the multiplicity of equilibria and the characterization of the sets $\overline{R}_\alpha(D)$ defined in (14).

Proposition 2. *Assume that Hypotheses A1 are fulfilled. Fix $D > 0$ and take a positive number α such that $\Lambda(\alpha D) \neq \emptyset$ and $\lambda_-(\alpha D) < S_{in}$. Let $S_2^*(\alpha) \in (0, S_{in})$ be such that $\mu(S_2^*(\alpha)) = \alpha D$. Then, for any $r \in (0, 1)$ there exists an equilibrium $(S_1^*, S_{in} - S_1^*, S_2^*(\alpha), S_{in} - S_2^*(\alpha))$ of (6), with*

$$S_1^* \in \begin{cases} (\underline{S}(\alpha), S_{in}) & \text{when } \Lambda(D) = \emptyset \text{ or } \underline{S}(\alpha) \notin \Lambda(D), \\ [\lambda_-(D), \underline{S}(\alpha)] & \text{when } \underline{S}(\alpha) \in \Lambda(D). \end{cases} \quad (21)$$

Furthermore, the set $R_\alpha(D)$ defined in (18) is not reduced to a singleton when it is non-empty. We distinguish two different cases:

Case I: $\Lambda(D) = \emptyset$ or $\lambda_-(D) \geq S_{in}$ or $\lambda_+(D) \geq S_{in}$. One has

$$\overline{R}_\alpha(D) = \begin{cases} (0, 1) & \text{when } R_\alpha(D) = \emptyset, \\ (0, 1) \setminus [\min R_\alpha(D), \max R_\alpha(D)] & \text{when } R_\alpha(D) \neq \emptyset. \end{cases}$$

For $r \notin \overline{R}_\alpha(D)$, there exist at least three equilibria with $S_1^* \in (\underline{S}(\alpha), S_{in})$ when $\Lambda(D) = \emptyset$ or $S_1^* \in (\lambda_-(D), \underline{S}(\alpha))$ when $\Lambda(D) \neq \emptyset$.

Case II: $\lambda_+(D) < S_{in}$. We consider the partition of the set $R_\alpha(D)$:

$$R_\alpha^-(D) = \{r \in (0, 1) \mid \exists s \in \mathcal{S}_{\alpha,r}(D) \text{ with } (s - \underline{S}(\alpha))(\lambda_+(D) - \underline{S}(\alpha)) < 0\}, \quad (22)$$

$$R_\alpha^+(D) = \{r \in (0, 1) \mid \exists s \in \mathcal{S}_{\alpha,r}(D) \text{ with } (s - \lambda_+(D))(\lambda_+(D) - \underline{S}(\alpha)) \geq 0\}. \quad (23)$$

Then, the set $R^+(\alpha)$ is non-empty, and the set $R^-(\alpha)$ is not reduced to a singleton when it is non-empty. One has

$$\overline{R}_\alpha(D) = \begin{cases} (0, \min R^+(\alpha)) & \text{when } R^-(\alpha) = \emptyset, \\ (0, \min R^+(\alpha)) \cap (0, 1) \setminus [\min R^-(\alpha), \max R^-(\alpha)] & \text{when } R^-(\alpha) \neq \emptyset. \end{cases}$$

For any $r \in (\min R^+(\alpha), 1)$, there exist at least two equilibria such that $(\underline{S}(\alpha) - S_1^*)(\lambda_+(D) - \underline{S}(\alpha)) \geq 0$, and at least four for r in a subset of $(\min R^+(\alpha), 1)$ when $R^+(\alpha)$ is not reduced to a singleton.

When $R^-(\alpha)$ is non-empty, for any $r \in (\min R^-(\alpha), \max R^-(\alpha))$, there exist at least three equilibria such that $(\underline{S}(\alpha) - S_1^*)(\lambda_+(D) - \underline{S}(\alpha)) < 0$.

Remark. In Case II, the tangency of the graphs of $\phi_{\alpha,r}$ and μ occurs for a certain r with an abscissa that is located

- either at the right of λ_+ when $\underline{S}(\alpha) < \lambda_+(D)$,
- either at the left of λ_+ when $\underline{S}(\alpha) > \lambda_+(D)$.

These cases correspond to the subset $R_\alpha^+(D)$ while the subset $R_\alpha^-(D)$ corresponds to other tangencies that could occur (but that do not necessarily exist) on either side of $\underline{S}(\alpha)$.

Proof of Proposition 2.

Fix D and α such that $\Lambda(\alpha D) \neq \emptyset$ and $\lambda_-(\alpha D) < S_{in}$. For simplicity, we denote by S_2^* and \underline{S} the values of $S_2^*(\alpha)$ and $\underline{S}(\alpha)$, with S_2^* such that $\mu(S_2^*) = \alpha D$. For each $r \in (0, 1)$, we define the function

$$f_r(s) = D\phi_{\alpha,r}(s) - \mu(s) .$$

A non-negative equilibrium for the first tank has then to satisfy $f_r(S_1^*) = 0$.

One can easily check that $\phi_{\alpha,r}(\underline{S}) = 1$ whatever the value of $r \in (0, 1)$. The function $\phi_{\alpha,r}(\cdot)$ being decreasing, one has $\phi_{\alpha,r}(s) > 1$ for $s < \underline{S}$ and $\phi_{\alpha,r}(s) < 1$ for $s > \underline{S}$. For convenience, we shall also consider the function

$$\gamma(s) = \frac{\underline{S} - s}{\underline{S} - S_{in} + (S_{in} - s)\mu(s)/D} \quad (24)$$

that is defined on the set of $s \in (0, S_{in})$ such that $(S_{in} - s)\mu(s) \neq S_{in} - \underline{S}$. On this set, one can easily check that the following equivalence is fulfilled

$$f_r(s) = 0 \iff \gamma(s) = r .$$

From (24), one can also write

$$\gamma(s) = \frac{(\phi_{\alpha,r}(s) - 1)\frac{r}{1-r}}{(\phi_{\alpha,r}(s) - 1)\frac{r}{1-r} - 1 + \mu(s)/D}$$

and deduce the property

$$\gamma'(s) = 0 \iff \phi'_{\alpha,r}(s)(\mu(s)/D - 1) = (\phi_{\alpha,r}(s) - 1)\mu'(s)/D . \quad (25)$$

Recursively, one obtains for every integer n

$$\left\{ \frac{d^p \gamma}{ds^p}(s) = 0, p = 1 \dots n \right\} \iff \left\{ D \frac{d^p \phi_{\alpha,r}}{ds^p}(s)(\mu(s) - D) = (D\phi_{\alpha,r}(s) - D) \frac{d^p \mu}{ds^p}(s), p = 1 \dots n \right\} .$$

Consequently, the set $\mathcal{S}_{\alpha,r}$ defined in (17) can be characterized as

$$\mathcal{S}_{\alpha,r} = \left\{ s \in (\lambda_-, S_{in}) \text{ s.t. } \gamma(s) = r \text{ and } \min \left\{ n \in \mathbb{N}^* \mid \frac{d^n \gamma}{ds^n}(s) \neq 0 \right\} \text{ is even} \right\}$$

or equivalently

$$\mathcal{S}_{\alpha,r} = \{ s \in (0, S_{in}) \text{ s.t. } \gamma(s) = r \text{ is a local extremum} \} . \quad (26)$$

We distinguish several cases depending on the position of \underline{S} with respect to the set $\Lambda(D)$. In the following, we simply denote Λ , λ_\pm and R_α for $\Lambda(D)$, $\lambda_\pm(D)$ and $R_\alpha(D)$ respectively.

Case I.

When $\Lambda = \emptyset$ or $\lambda_- \geq S_{in}$, the function f_r is strictly positive on the interval $[0, \underline{S}]$. On the interval $J = (\underline{S}, S_{in})$, the function $\gamma(\cdot)$ is well defined with $\gamma(J) = (0, 1)$, $\gamma(\underline{S}) = 0$ and $\gamma(S_{in}) = 1$. Consequently, there exists at least one solution of $f_r(s) = 0$, that necessarily belongs to the interval J . If $R_\alpha = \emptyset$, $\gamma(\cdot)$ is increasing and there exists a unique solution of $\gamma(S_1^*) = r$ whatever is r . Notice that when the function $\mu(\cdot)$ is increasing on $[0, S_{in}]$ (which is necessarily the case when $\lambda_- \geq S_{in}$), one has necessarily $R_\alpha = \emptyset$, because

the function f_r is decreasing. Otherwise, property (26) implies that γ admits local extrema, and $\min R_\alpha$ and $\max R_\alpha$ are respectively the smallest local minimum and largest local maximum of the function γ on the interval J . Consequently, the set R_α cannot be reduced to a singleton. Then, uniqueness of S_1^* is achieved exactly for r that does not belong to $[\min R_\alpha, \max R_\alpha]$. For any $r \in (\min R_\alpha, \max R_\alpha)$, there are at least three solutions, that all belong to J , by the Mean Value Theorem.

When $\lambda_- < S_{in} \leq \lambda_+$, we distinguish two sub-cases:

$\underline{S} \leq \lambda_-$: the function f_r is strictly positive on $[0, \underline{S}]$ and strictly negative on (λ_-, S_{in}) . Furthermore, f_r is decreasing on $[\underline{S}, \lambda_-]$. So there exists a unique root S_1^* of f_r that necessarily belongs to $[\underline{S}, \lambda_-]$ (and the set R_α is empty).

$\underline{S} > \lambda_-$: the function f_r is strictly positive on $[0, \lambda_-]$ and strictly negative on $[\underline{S}, S_{in})$. On the interval $I = (\lambda_-, \underline{S})$, the function $\gamma(\cdot)$ is well defined and $\gamma(I) = (0, 1)$ with $\gamma(\lambda_-) = 1$ and $\gamma(\underline{S}) = 0$. If R_α is empty, then $\gamma(\cdot)$ is decreasing on I , and for any $r \in (0, 1)$ there exists a unique S_1^* such that $\gamma(S_1^*) = r$. If R_α is non-empty, property (26) implies that γ admits local extrema, and $\min R_\alpha$ and $\max R_\alpha$ are respectively the smallest local minimum and largest local maximum of the function γ on the interval I . Then, uniqueness of S_1^* on J is achieved exactly for r that does not belong to $[\min R_\alpha, \max R_\alpha]$. For any $r \in (\min R_\alpha, \max R_\alpha)$, there are at least three solutions, that all belong to the interval I , by the Mean Value Theorem.

Case II.

Notice that in this case ($\lambda_+ < S_{in}$) the function μ is non-monotonic. We consider three sub-cases depending on the relative position of \underline{S} with respect to λ_+ .

Sub-case 1: $\underline{S} < \lambda_+$. As for Case I, we distinguish:

$\underline{S} \leq \lambda_-$: one has $f_r(\underline{S}) \geq 0$ and $f_r(S) < 0$ for any $S \in \Lambda$. $f_r(\cdot)$ being decreasing on $[0, \lambda_-]$, one deduces that there exists exactly one solution S_1^* of $f_r(S) = 0$ on the interval $[0, \lambda_+]$, whatever is r . Furthermore, this solution has to belong to $[\underline{S}, \lambda_-]$. The functions $\phi_r(\cdot)$ and $\mu(\cdot)$ being respectively decreasing and increasing on this interval, one has necessarily $\gamma'(S_1^*) \neq 0$ and then $R_\alpha^- = \emptyset$.

$\underline{S} > \lambda_-$: one has $f_r(S) > 0$ for any $S \in [0, \lambda_-]$, and $f_r(S) < 0$ for any $S \in [\underline{S}, \lambda_+]$. On the interval $I = (\lambda_-, \underline{S})$, the function $\gamma(\cdot)$ is well defined and $\gamma(I) = (0, 1)$ with $\gamma(\lambda_-) = 1$ and $\gamma(\underline{S}) = 0$. If R_α^- is empty, then $\gamma(\cdot)$ is decreasing on I , and for any $r \in (0, 1)$ there exists a unique $S_1^* \in I$ such that $\gamma(S_1^*) = r$. If R_α^- is non-empty, property (26) implies that γ admits local extrema. Similarly to Case I, we obtain by the Mean Value Theorem that there exists exactly one solution S_1^* of $\gamma(s) = r$ on the interval $[0, \lambda_+]$ for any $r \notin [\min R_\alpha^-, \min R_\alpha^-]$, and there are at least three solutions for $r \in (\min R_\alpha^-, \min R_\alpha^-)$.

Differently to Case I, we have also to consider the interval $K = (\lambda_+, S_{in})$ where the function $\gamma(\cdot)$ is well defined and positive with $\gamma(\lambda_+) = 1$ and $\lim_{s \rightarrow S_{in}} \gamma(s) = 1$. We define

$$r^+ = \min\{\gamma(s) \mid s \in K\}$$

that belongs to $(0, 1)$. Then r^+ belongs to R_α^+ , and for any $r < r^+$ there is no solution of $\gamma(s) = r$ on K . Thus r^+ is the minimal element of R_α^+ . By the Mean Value Theorem there are at least two solutions of $\gamma(s) = r$ on K when $r > r^+$. When R_α^+ is not reduced to a singleton, the function γ has at least on local maximum r_M and one local minimum r_m , in addition to r^+ . By the Mean Value Theorem, there are at least four solutions of $\gamma(s) = r$ on K for $r \in (r_m, r_M)$.

Finally, we have shown that the set R_α^+ is non-empty, and that the uniqueness of the solution of $\gamma(S_1^*) = r$ occurs exactly for values of r that do not belong to the set $[\min R_\alpha^-, \max R_\alpha^-] \cup [\min R_\alpha^+, 1]$.

Sub-case 2: $\underline{S} = \lambda_+$. One has $f_r(\underline{S}) = 0$ for any r , so there exists a positive equilibrium with $S_1^* = \underline{S}$.

$f_r(S) > 0$ for any $S \in [0, \lambda_-]$ and the function $\gamma(\cdot)$ is well defined on $I \cup J = (\lambda_-, \underline{S}) \cup (\underline{S}, S_{in})$ with $\gamma(I \cup J) = (0, 1)$, $\gamma(\lambda_-) = 1$ and $\lim_{s \rightarrow S_{in}} \gamma(s) = 1$. Using the L'Hôpital's rule, we show that the function $\gamma(\cdot)$ can be continuously extended at \underline{S} :

$$\lim_{s \rightarrow \underline{S}} \gamma(s) = \lim_{s \rightarrow \underline{S}} \frac{-1}{-\mu(s)/D + (S_{in} - s)\mu'(s)/D} = \frac{1}{1 - (S_{in} - \underline{S})\mu'(\underline{S})/D}.$$

Note that $\mu'(\underline{S}) < 0$ so that $\gamma(\underline{S})$ belongs to $(0, 1)$, and we pose

$$\bar{r} = \min\{\gamma(s) \mid s \in (\lambda_-, S_{in})\}.$$

Then, for $r < \bar{r}$, there is no solution of $\gamma(s) = r$ on (λ_-, S_{in}) , and \underline{S} is the only solution of $f_r(s) = 0$ on $(0, S_{in})$. On the contrary, for $r > \bar{r}$, there are at least two solutions of $\gamma(s) = r$ on (λ_-, S_{in}) and the dynamics has at least two positive equilibria.

Similarly, the function $\gamma(\cdot)$ is C^1 on (λ_-, S_{in}) because it is differentiable at \underline{S} :

$$\gamma'(\underline{S}) = D \frac{(S_{in} - \underline{S})\mu''(\underline{S}) - 2\mu'(\underline{S})}{[D - (S_{in} - \underline{S})\mu'(\underline{S})]^2}$$

(and recursively as many time differentiable as the function $\mu(\cdot)$ is, minus one). Then \bar{r} is the minimal element of the set R_α^+ , and the set R_α^- is empty by definition. As previously, when R_α^+ is not reduced to a singleton, $\gamma(s) = r$ has at least four solutions for r in a subset of $(\min R_\alpha^+, 1)$.

Sub-case 3: $\underline{S} > \lambda_+$. We proceed similarly as in sub-case 1. Note first that there is no solution of $f_r(s) = 0$ on the intervals $(0, \lambda_-)$ and $(\lambda_+, \underline{S})$ whatever is r .

On the set Λ , $\gamma(\cdot)$ is well defined with $\gamma(\Lambda) \subset (0, 1)$, $\gamma(\lambda_-) = 1$ and $\gamma(\lambda_+) = 1$ and we define

$$r^+ = \min\{\gamma(s) \mid s \in \Lambda\}$$

that belongs to $(0, 1)$. One has necessarily $r^+ = \min R_\alpha^+$, and there is no solution of $\gamma(S_1^*) = r$ exactly when $r < r^+$. For $r > r^+$, there exist at least two solutions by the Mean Value Theorem, and four for a subset of $(r^+, 1)$ when R_α^+ is not reduced to a singleton.

On the interval $J = (\underline{S}, S_{in})$, the function $\gamma(\cdot)$ is well defined with $\gamma(J) = (0, 1)$, $\gamma(\underline{S}) = 0$ and $\gamma(S_{in}) = 1$. There exists at least one solution of $f_r(s) = 0$ on this interval. If $R_\alpha^- = \emptyset$, $\gamma(\cdot)$ is increasing and there exists a unique solution of $\gamma(S_1^*) = r$ on J whatever is r . Otherwise, $\min R_\alpha^-$ and $\max R_\alpha^-$ are the smallest local minimum and largest local maximum of the function γ on the interval J , respectively. Then, uniqueness of S_1^* on J is achieved exactly for r that does not belong to $[\min R_\alpha^-, \max R_\alpha^-]$, and for $r \in (\min R_\alpha^-, \max R_\alpha^-)$, there are at least three solutions by the Mean Value Theorem. \square

For the proof of Theorem 1, we recall below a result about asymptotically autonomous dynamics.

Theorem 2. *Let Φ be an asymptotically autonomous semi-flow with limit semi-flow Θ , and let the orbit $\mathcal{O}_\Phi(\tau, \xi)$ have compact closure. Then the ω -limit set $\omega_\Phi(\tau, \xi)$ is non-empty, compact, connected, invariant and chain-recurrent by the semi-flow Θ and attracts $\Phi(t, \tau, \xi)$ when $t \rightarrow \infty$.*

Proof. See [34, Theorem 1.8]. \square

We shall also need to treat a limiting case of the single chemostat that is not covered by Proposition 1, when one has exactly $\mu(S_{in}) = \alpha D$ for the buffer tank with $\mu(\cdot)$ non-monotonic, that is provided by the following Lemma.

Lemma 2. For any $\alpha > 0$ such that $\alpha D \leq \mu(S_{in})$ and non-negative initial condition with $X_2(0) > 0$, the solution $S_2(t)$ and $X_2(t)$ of (6) is non negative for any $t > 0$ and one has

$$\lim_{t \rightarrow +\infty} (S_2(t), X_2(t)) = (\lambda_-(\alpha D), S_{in} - \lambda_-(\alpha D)) .$$

Proof. From equations (6) one can write the properties

$$\begin{aligned} S_2 = 0 &\implies \dot{S}_2 > 0 , \\ X_2 = 0 &\implies \dot{X}_2 = 0 , \end{aligned}$$

and deduces that the variables $S_2(t)$ and $X_2(t)$ remain non negative for any positive time. Considering the variable $Z_2 = S_2 + X_2 - S_{in}$ whose dynamics is $\dot{Z}_2 = -\alpha D Z_2$, we conclude that $S_2(t)$ and $X_2(t)$ are bounded and satisfy

$$\lim_{t \rightarrow +\infty} S_2(t) + X_2(t) = S_{in} .$$

The dynamics of the variable S_2 can thus be written as an non autonomous scalar equation:

$$\dot{S}_2 = (\alpha D - \mu(S_2))(S_{in} - S_2) - \mu(S_2)Z_2(t)$$

that is asymptotically autonomous. The study of this asymptotic dynamics is straightforward: any trajectory that converges forwardly to the domain $[0, S_{in}]$ has to converge to S_{in} or to a zero S_2^* of $S_2 \mapsto \alpha D - \mu(S_2)$ on the interval $(0, S_{in})$. Then, the application of Theorem 2 allows to conclude that forward trajectories of the (S_2, X_2) sub-system converge asymptotically either to the positive steady state $(S_2^*, S_{in} - S_2^*)$ or to the “washout” equilibrium $(S_{in}, 0)$.

For α such that $\alpha D < \mu(S_{in})$, there is only one such zero, that is equal to $\lambda_-(\alpha D)$ (and necessarily lower than S_{in}). We are in conditions of Case 3 of Proposition 1: $S_{in} \in \Lambda(\alpha D)$, and the convergence to the positive equilibrium is proved.

For the limiting case $\alpha D = \mu(S_{in})$, either $\lambda_-(\alpha D) = S_{in}$ when $\mu(\cdot)$ is monotonic on the interval $[0, S_{in}]$ (then the washout is the only equilibrium), or $\lambda_-(\alpha D) < S_{in}$ when $\mu(\cdot)$ is non-monotonic. In this last situation, none of the cases of Proposition 1 are fulfilled. We show that for any initial condition such that $X_2(0) > 0$, the forward trajectory cannot converge to the washout equilibrium. From equations (6) one can write

$$X_2(t) = X_2(0) e^{\int_0^t (\mu(S_2(\tau)) - \alpha D) d\tau} .$$

If $X_2(\cdot)$ tends to 0, then one should have

$$\int_T^{+\infty} (\mu(S_2(\tau)) - \alpha D) d\tau = -\infty \tag{27}$$

for any finite positive T . Using Taylor-Lagrange Theorem, there exists a continuous function $\theta(\cdot)$ in $(0, 1)$ such that

$$\mu(S_2(\tau)) = \mu(S_{in}) + \mu'(\tilde{S}_2(\tau))(S_2(\tau) - S_{in}) \text{ with } \tilde{S}_2(\tau) = S_{in} + \theta(\tau)(S_{in} - S_2(\tau)) .$$

One can then write

$$\begin{aligned} \int_T^{+\infty} (\mu(S_2(\tau)) - \alpha D) d\tau &= \int_T^{+\infty} (\mu(S_{in}) - \alpha D) d\tau - \int_T^{+\infty} \mu'(\tilde{S}_2(\tau)) X_2(\tau) d\tau + \int_T^{+\infty} \mu'(\tilde{S}_2(\tau)) Z_2(\tau) d\tau \\ &= - \int_T^{+\infty} \mu'(\tilde{S}_2(\tau)) X_2(\tau) d\tau - \frac{1}{\alpha D} \int_T^{+\infty} \mu'(\tilde{S}_2(\tau)) \dot{Z}_2(\tau) d\tau . \end{aligned}$$

Note that $S_2(\cdot)$ tends to S_{in} when $X_2(\cdot)$ tends to 0. So there exists $T > 0$ such that $\tilde{S}_2(\tau) > \hat{S}$ for any $\tau > T$, and accordingly to Assumptions A1, there exist positive numbers a, b such that $-\mu'(\tilde{S}_2(\tau)) \in [a, b]$ for any $\tau > T$. The following inequality is obtained

$$\int_T^{+\infty} (\mu(S_2(\tau)) - \alpha D) d\tau \geq a \int_T^{+\infty} X_2(\tau) d\tau - \frac{b}{\alpha D} |Z_2(T)|$$

leading to a contradiction with (27). □

Proof of Theorem 1.

Let us consider the vector

$$Z = \begin{bmatrix} X_1 + S_1 - S_{in} \\ X_2 + S_2 - S_{in} \end{bmatrix}$$

whose dynamics is linear:

$$\dot{Z} = D \underbrace{\begin{pmatrix} -\frac{1}{r} & \frac{\alpha(1-r)}{r} \\ 0 & -\alpha \end{pmatrix}}_A Z .$$

The matrix A is clearly Hurwitz and consequently Z converges exponentially towards 0 in forward time. Furthermore, variables S_2 and X_2 being non negative, one has also from (6) the following properties

$$\begin{aligned} S_1 = 0 &\implies \dot{S}_1 \geq 0 , \\ X_1 = 0 &\implies \dot{X}_1 \geq 0 , \end{aligned}$$

and deduces that variables S_1 and X_1 stay also non negative in forward time. The definition of Z allows us to conclude that variables S_1, X_1, S_2, X_2 are bounded.

From equations (6), the dynamics of the variable S_1 can be written as an non-autonomous scalar equation:

$$\dot{S}_1 = \left(-\mu(S_1) + D \frac{1 - \alpha(1-r)}{r} \right) (S_{in} - S_1) + D \frac{\alpha(1-r)}{r} (S_2(t) - S_1) - \mu(S_1) Z_1(t) . \quad (28)$$

When the initial condition of sub-system (S_2, X_2) belongs to the attraction basin of the washout, the dynamics (28) is asymptotically autonomous with the limiting equation

$$\dot{S}_1 = (-\mu(S_1) + D/r)(S_{in} - S_1) . \quad (29)$$

From Theorem 2, we deduce that S_1 converges to S_1^* , one of the zeros of the function

$$f(s) = (-\mu(s) + D/r)(S_{in} - s)$$

on the interval $[0, S_{in}]$, that are $S_{in}, \lambda_-(D/r)$ (if $\lambda_-(D/r) < S_{in}$) and $\lambda_+(D/r)$ (if $\lambda_+(D/r) < S_{in}$). The Jacobian matrix of the whole dynamics (6) at steady state $(S_1^*, S_{in} - S_1^*, S_{in}, 0)$ in (Z, S_1, S_2) coordinates is

$$\left(\begin{array}{cc|cc} & & & \\ & A & & 0 \\ \hline & & & \\ -\mu(S_1^*) & 0 & f'(S_1^*) & D \frac{\alpha(1-r)}{r} \\ 0 & -\mu(S_{in}) & 0 & \mu(S_{in}) - \alpha D \end{array} \right) .$$

When the attraction basin of the washout of the (S_2, X_2) subsystem is not reduced to a singleton, one has necessarily $\mu(S_{in}) < \alpha D$ (see Lemma 2). Furthermore, one has $f'(S_{in}) = \mu(S_{in}) - D/r$ and $f'(S_1^*) = -\mu'(S_1^*)(S_{in} - S_1^*)$ when $S_1^* < S_{in}$. So, apart two possible particular values of r that are such that $r = D/\mu(S_{in})$ or $\lambda_-(D/r) = \lambda_+(D/r) < S_{in}$, $f'(S_1^*)$ is non-zero and the equilibrium is thus hyperbolic. Finally, we conclude about the possible asymptotic behaviors of the whole dynamics as follows.

- the washout equilibrium is attracting when $\mu(S_{in}) < D/r$. When $\mu(S_{in}) > D/r$, this equilibrium is a saddle (with a stable manifold of dimension one). Accordingly to the Theorem of the Stable Manifold, the trajectory solution cannot converges to such an equilibrium, excepted from a measure-zero subset of initial conditions.
- when $\lambda_-(D/r) < S_{in}$, the equilibrium with $S_1^* = \lambda_-(D/r)$ is always attracting.
- when $\lambda_+(D/r) < S_{in}$, the equilibrium with $S_1^* = \lambda_+(D/r)$ is a saddle (with a stable manifold of dimension one). Accordingly to the Theorem of the Stable Manifold, the trajectory solution cannot converges to such an equilibrium, excepted from a measure-zero subset of initial conditions.

This finishes to prove the point i. of the Theorem.

When the initial condition of sub-system (S_2, X_2) does not belong to the attraction basin of the washout, Proposition 1 ensures that $S_2(t)$ converges towards a positive S_2^* that is equal to $\lambda_-(\alpha D)$ or $\lambda_+(\alpha D)$. Then, equation (28) can be equivalently written as:

$$\dot{S}_1 = (D\phi_{\alpha,r}(S_1) - \mu(S_1))(S_{in} - S_1) + D\frac{\alpha(1-r)}{r}(S_2(t) - S_2^*) - \mu(S_1)Z_1(t). \quad (30)$$

So the dynamics (30) is asymptotically autonomous with the limiting equation

$$\dot{S}_1 = (D\phi_{\alpha,r}(S_1) - \mu(S_1))(S_{in} - S_1). \quad (31)$$

From Theorem 2, we conclude that forward trajectories of the (S_1, X_1) sub-system converge asymptotically either to a stationary point $(S_1^*, S_{in} - S_1^*)$ where S_1^* is a zero of the function

$$f_r(s) = D\phi_{\alpha,r}(s) - \mu(s)$$

on the interval $(0, S_{in})$, either to the washout point $(S_{in}, 0)$. We show that this last case is not possible. From equations (6), one has

$$X_1 = 0 \implies \dot{X}_1 = D\frac{\alpha(1-r)}{r}X_2$$

and as $X_2(t)$ converges to a positive value, we deduce that $X_1(t)$ cannot converges towards 0.

The functions f_r being analytic for any r , the roots S_1^* are isolated. As for the proof of Proposition 2 we consider the function

$$\gamma(s) = \frac{\underline{S} - s}{\underline{S} - S_{in} + (S_{in} - s)\mu(s)/D}$$

that is analytic on its domain of definition and such that

$$f_r(s) = 0 \iff \gamma(s) = r.$$

This shows that, excepted for some isolated values of r in $(0, 1)$, the zero of f_r are such that $f_r'(S_1^*) \neq 0$.

Let us now write the Jacobian matrix J^* of dynamics (6) at steady state $E^* = (S_1^*, S_{in} - S_1^*, S_2^*, S_{in} - S_2^*)$ in (Z, S_1, S_2) coordinates:

$$J^* = \left(\begin{array}{cc|cc} & & & \\ & \mathbf{A} & & \mathbf{0} \\ \hline & & & \\ -\mu(S_1^*) & 0 & f_r'(S_1^*)(S_{in} - S_1^*) & D\frac{\alpha(1-r)}{r} \\ 0 & -\mu(S_2^*) & 0 & -\mu'(S_2^*)(S_{in} - S_2^*) \end{array} \right).$$

Considering the following facts:

- i. A is Hurwitz,
- ii. $\Lambda(\alpha D) \neq \emptyset$ implies that S_2^* is not equal to \hat{S} . So one has $\mu'(S_2^*) \neq 0$ (cf Assumptions A1),
- iii. $f_r'(S_1^*) \neq 0$ for almost any r ,

we conclude that any equilibrium E^* is hyperbolic (for almost any r) and is

- a saddle point when $\mu'(S_2^*) > 0$ or $f_r'(S_1^*) > 0$,
- an exponentially stable critical point otherwise.

Furthermore, the left endpoints of the connected components of the set $\Gamma_{\alpha,r}(D)$ are exactly the roots of f_r with $f_r(S_1^*) < 0$. Finally, from the Stable Manifold Theorem we conclude that, excepted from the stable manifolds of the saddle equilibria, the trajectory converges to an equilibrium that is such that $S_2^* = \lambda_-(\alpha D)$ and $f_r(S_1^*) < 0$. This ends the proof of point ii. \square

Proposition 3. *Assume that the hypotheses A1 are fulfilled with $\Lambda(D) \neq \emptyset$ and $\lambda_+(D) < S_{in}$. There exist buffered configurations with an additional tank of volume V_2 that possesses a unique globally exponentially stable positive equilibrium from any initial condition with $S_2(0) > 0$, exactly when V_2 fulfills the condition*

$$\frac{V_2}{V} > \left(\frac{V_2}{V}\right)_{\inf} = \frac{\max_{s \in (\lambda_+(D), S_{in})} \varphi(s)}{\max_{s \in [0, \bar{s}]} \psi(s)}, \quad (32)$$

where the functions $\varphi(\cdot)$ and $\psi(\cdot)$ are defined as follows:

$$\varphi(s) = (S_{in} - s)(D - \mu(s)), \quad \psi(s) = \mu(s)(S_{in} - s), \quad (33)$$

and \bar{s} is the number

$$\bar{s} = \lim_{\alpha \rightarrow \mu(S_{in})} S_2^*(\alpha). \quad (34)$$

The dilution rate $D_2 \in (0, \mu(S_{in}))$ has then to satisfy the condition

$$\max_{s \in (\lambda_+(D), S_{in})} \varphi(s) < D_2 \frac{V_2}{V} (S_{in} - S_2^*(D_2)) < S_{in}.$$

Furthermore, one has

$$\left(\frac{V_2}{V}\right)_{\inf} < \left(\frac{\Delta V}{V}\right)_{\inf}. \quad (35)$$

Proof of Proposition 3. One can straightforwardly check on equations (5) that a positive equilibrium in the first tank has to fulfill

$$\varphi(S_1^*) = D_2 \frac{V_2}{V} (S_{in} - S_2^*(D_2)). \quad (36)$$

Let us examine some properties of the function φ on the interval $(0, S_{in})$:

- . φ is negative exactly on the interval $\Lambda(D)$,
- . φ' is negative on $(0, \lambda_-(D))$ with $\varphi(0) = S_{in}$ and $\varphi(\lambda_-(D)) = 0$,
- . $\varphi(\lambda_+(D)) = \varphi(S_{in}) = 0$ and φ reaches its maximum m^+ on the sub-interval $(\lambda_+(D), S_{in})$, that is strictly less than $S_{in} = \varphi(0)$,

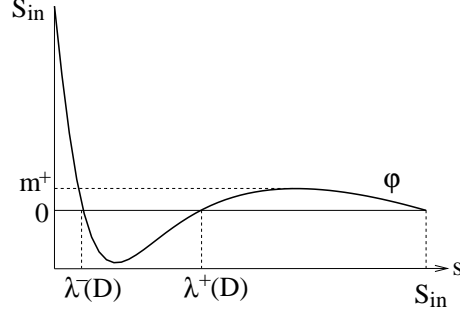

Figure 7: Illustration of the graph of the function φ

from which we deduce that there exists a unique solution of $\varphi(s) = c$ on the whole interval $(0, S_{in})$ exactly when $c \in (m^+, S_{in})$ (see Figure (7) as an illustration). The configurations for which there exists a unique $S_1^* \in (0, S_{in})$ solution of the equation (36) are exactly those that fulfill the condition $D_2 \frac{V_2}{V} (S_{in} - S_2^*(D_2)) \in (m^+, S_{in})$, or equivalently

$$\frac{m^+}{D_2(S_{in} - S_2^*(D_2))} < \frac{V_2}{V} < \frac{S_{in}}{D_2(S_{in} - S_2^*(D_2))}$$

with $D_2 \in (0, \mu(S_{in}))$. Then, Theorem 1 with $\alpha = D_2/D$ and $r = 1/(1 + \frac{V_2}{V})$ guarantees that the unique positive equilibrium $(S_1^*, S_{in} - S_1^*, S_2^*(D), S_{in} - S_2^*(D))$ is globally exponentially stable on the domain $\mathbb{R}_+^2 \times \mathbb{R}_+ \times \mathbb{R}_+$.

Among all such configurations, the infimum of V_2/V can be approached arbitrarily close when D_2 is maximizing the function

$$D_2 \mapsto \alpha(S_{in} - S_2^*(D_2))$$

on $[0, \mu(S_{in})]$, that exactly amounts to maximize the function $\psi(\cdot)$ on the interval $[0, \bar{s}]$.

Finally, let s^* be a minimizer of φ on $(\lambda_+(D), S_{in})$. One has $\mu(s^*) > \mu(S_{in}) = \mu(\bar{s})$ and can write

$$\left(\frac{V_2}{V}\right)_{\inf} \leq \frac{\varphi(s^*)}{\psi(\bar{s})} < \frac{(S_{in} - s^*)(D - \mu(S_{in}))}{\mu(S_{in})(S_{in} - \bar{s})} = \frac{S_{in} - s^*}{S_{in} - \bar{s}} \left(\frac{\Delta V}{V}\right)_{\inf}$$

which leads to the inequality (35). □

References

- [1] P. AMARASEKARE AND R. NISBET, *Spatial heterogeneity, sourcesink dynamics, and the local coexistence of competing species*, The American Naturalist, 158(6) (2001), 572–584.
- [2] J.F. ANDREWS, *A mathematical model for the continuous culture of microorganisms utilizing inhibitory substrates*, Biotech. Bioengrg., 10 (1968), 707–723.
- [3] G. J. BUTLER AND G. S. K. WOLKOWICZ, *A mathematical model of the chemostat with a general class of functions describing nutrient uptake*, SIAM J. Appl. Math. 45 (1985), 138–151.
- [4] A. BUSH AND A. COOK *The effect of time delay and growth rate inhibition in the bacterial treatment of wastewater* J. Theor Biol. 63(2) (1976), 385–395.
- [5] C. DE GOOIJER, W. BAKKER, H. BEEFTINK AND J. TRAMPER, *Bioreactors in series: An overview of design procedures and practical applications*, Enzyme and Microbial Technology, 18 (1996), 202–219.

- [6] E. DI MATTIA, S. GREGO AND I. CACCIARI, *Eco-physiological characterization of soil bacterial populations in different states of growth* Microb. Ecol. 43(1) (2002), 34–43.
- [7] D. DOCHAIN AND G. BASTIN *Adaptive identification and control algorithms for non linear bacterial growth systems*. Automatica, 20(5) (1984), 621–634.
- [8] D. DOCHAIN AND P. VANROLLEGHEM, *Dynamical Modelling and Estimation in Wastewater treatment Processes*, IWA Publishing, U.K. (2001).
- [9] A. DRAMÉ, J. HARMAND, A. RAPAPORT AND C. LOBRY, *Multiple steady state profiles in interconnected biological systems*, Mathematical and Computer Modelling of Dynamical Systems, 12 (2006), 379–393.
- [10] H. EL-OWAIDY AND O. EL-LEITHY, *Theoretical studies on extinction in the gradostat* Mathematical Biosciences, 101(1) (1990), 1–26.
- [11] A. FREDRICKSON AND G. STEPHANOPOULOS, *Microbial Competition* Science, 213 (1981), 972–979.
- [12] H. FREEDMAN AND G. WOLKOWICZ, *Predator-prey systems with group defence: The paradox of enrichment revisited*. Bulletin of Mathematical Biology, 48(5/6) (1986) 493–508.
- [13] C. FRITZSCHE, K. HUCKFELDT AND E.-G. NIEMANN, *Ecophysiology of associative nitrogen fixation in a rhizosphere model in pure and mixed culture*, FEMS Microbiology Ecology, 8(4) (2011), 279–290.
- [14] A. GAKI, AL. THEODOROU, D. VAYENAS AND S. PAVLOU, *Complex dynamics of microbial competition in the gradostat*, Journal of Biotechnology, 139(1) (2009) pp 38–46.
- [15] D. GRAVEL, F. GUICHARD, M. LOREAU AND N. MOUQUET, *Source and sink dynamics in metaecosystems*. Ecology, 91 (2010), 2172–2184.
- [16] I. HAIDAR, A. RAPAPORT AND F. GÉRARD, *Effects of spatial structure and diffusion on the performances of the chemostat*, Mathematical Biosciences and Engineering, 8(4) (2011), 953–971.
- [17] J. HARMAND, A. RAPAPORT AND F. MAZENC, *Output tracking of continuous bioreactors through recirculation and by-pass*, Automatica, 42(7) (2006) 1025–1032.
- [18] J. HARMAND, A. RAPAPORT AND A. TROFINO, *Optimal design of two interconnected bioreactors—some new results*, American Institute of Chemical Engineering Journal, 49 (1999), 1433–1450.
- [19] A. HASLER AND W. JOHNSON, *The in situ chemostat – a self-contained continuous culturing and water sampling system*. Limnol. Oceanogr. 79 (1954), 326–331.
- [20] J. HOFBAUER AND W. SO, *Competition in the gradostat: the global stability problem* Original Research Nonlinear Analysis: Theory, Methods & Applications, 22(8) (1994), 1017–1031.
- [21] Y. HIGASHI, N. YTOW, H. SAIDA AND H. SEKI, *In situ gradostat for the study of natural phytoplankton community with an experimental nutrient gradient* Environmental Pollution, 99 (1998), 395–404.
- [22] G. HILL AND C. ROBINSON, *Minimum tank volumes for CFST bioreactors in series*, The Canadian Journal of Chemical Engineering, 67 (1989), 818–824.
- [23] W. JAEGER, J.-H. SO, B. TANG AND P. WALTMAN, *Competition in the gradostat*, J. Math. Biol. 25 (1987), 23–42.
- [24] H. JANNASH AND R. MATELES, *Experimental bacterial ecology studies in continuous culture*, Advanced in Microbial Physiology 11 (1974), 165–212.

- [25] P. LENAS, N. THOMOPOULOS, D. VAYENAS AND S. PAVLOU, *Oscillations of two competing microbial populations in configurations of two interconnected chemostats*, *Mathematical Biosciences*, 148(1) (1998), 43–63.
- [26] S. LEVIN, *Dispersion and population interactions*, *The American Naturalist*, 108(960) (1974), 207–228.
- [27] J. LA RIVIÈRE, *Microbial ecology of liquid waste*, *Advances in Microbial Ecology*, 1 (1977), 215–259.
- [28] B. LI, *Global asymptotic behavior of the chemostat: General response functions and differential removal rates*, *SIAM J. Appl. Math.* 59 (1998), 411–22.
- [29] M. LOREAU, *From Populations to Ecosystems: Theoretical Foundations for a New Ecological Synthesis*. Princeton University Press, Princeton (2010).
- [30] M. LOREAU, T. DAUFRESNE, A. GONZALEZ, D. GRAVEL, F. GUICHARD, S.J. LEROUX, N. LOEUILLE, F. MASSOL AND N. MOUQUET. *Unifying sources and sinks in ecology and Earth sciences*. *Biological Review* 88 (2013), 365–79.
- [31] R. LOVITT AND J. WIMPENNY, *The gradostat: A bidirectional compound chemostat and its applications in microbial research*, *Journal of General Microbiology*, 127 (1981), 261–268.
- [32] K. LUYBEN AND J. TRAMPER, *Optimal design for continuously stirred tank reactors in series using Michaelis-Menten kinetics*, *Biotechnology and Bioengineering*, 24 (1982), 1217–1220.
- [33] R. MACARTHUR AND E. WILSON, *The Theory of Island Biogeography*, Princeton University Press (1967).
- [34] M. MISCHAIKOW, H. SMITH AND H. THIEME, *Asymptotically autonomous semiflows: chain recurrence and Lyapunov functions*, *Transactions of the American Mathematical Society*, 347(5) (1995), 1669–1685.
- [35] J. MONOD, *La technique de la culture continue: Théorie et applications*, *Annales de l’Institut Pasteur*, 79 (1950), 390–410.
- [36] S. NAKAOKA AND Y. TAKEUCHI, *Competition in chemostat-type equations with two habitats*, *Mathematical Bioscience*, 201 (2006), 157–171.
- [37] M. NELSON AND H. SIDHU, *Evaluating the performance of a cascade of two bioreactors*, *Chemical Engineering Science*, 61 (2006), 3159–3166.
- [38] A. NOVICK AND L. SZILARD, *Description of the chemostat*, *Science*, 112 (1950), 715–716.
- [39] J. PIRT, *Principles of Microbe and Cell Cultivation*, Blackwell Scientific Publications (1975).
- [40] A. RAPAPORT AND J. HARMAND, *Biological control of the chemostat with non-monotonic response and different removal rates*, *Mathematical Biosciences and Engineering*, 5(3) (2008), 539–547.
- [41] A. RAPAPORT, J. HARMAND AND F. MAZENC, *Coexistence in the design of a series of two chemostats*, *Nonlinear Analysis, Real World Applications*, 9 (2008), 1052–1067.
- [42] A. SCHAUM, J. ALVAREZ AND T. LOPEZ-ARENAS, *Saturated PI control of continuous bioreactors with Haldane kinetics* *Chem. Eng. Science*, 68 (2012), 520–529.
- [43] H. SMITH AND B. TANG, *Competition in the gradostat: the role of the communication rate*, *J. Math. Biol.* 27(2) (1989), 139–165.
- [44] H. SMITH, B. TANG AND P. WALTMAN, *Competition in an n-vessel gradostat*, *SIAM J. Appl. Math.* 51 (1991), 1451–1471.

- [45] H. SMITH AND P. WALTMAN, H.L. Smith, P. Waltman, *The gradostat: a model of competition along a nutrient gradient*, J. Microb. Ecol. 22 (1991), 207–226.
- [46] H. SMITH AND P. WALTMAN, *The theory of chemostat, dynamics of microbial competition*, Cambridge Studies in Mathematical Biology, Cambridge University Press (1995).
- [47] H. SMITH AND P. WALTMAN, *Competition in the periodic gradostat*, Nonlinear Analysis: Real World Applications, 1(1) (2000), 177–188.
- [48] G. STEPHANOPOULOS AND A. FREDRICKSON, *Effect of inhomogeneities on the coexistence of competing microbial populations*, Biotechnology and Bioengineering, 21 (1979), 1491–1498.
- [49] B. TANG, *Mathematical investigations of growth of microorganisms in the gradostat*, J. Math. Biol. 23 (1986), 319–339.
- [50] B. TANG, *Competition models in the gradostat with general nutrient uptake functions*, Rocky Mountain J. Math. 24(1) (1994), 335–349.
- [51] H. VELDCAMP, *Ecological studies with the chemostat*, Advances in Microbial Ecology, 1 (1977), 59–95.
- [52] G. WOLKOWICZ AND Z. LU, *Global dynamics of a mathematical model of competition in the chemostat: general response functions and differential death rates*, SIAM J. Appl. Math. 52 (1992), 222–233.
- [53] D. XIAO AND S. RUAN, *Global analysis in a predator-prey system with nonmonotonic functional response*. SIAM Journal on Applied Mathematics, 61(4) (2001), 11445–72.
- [54] A. ZAGHROUT, *Asymptotic behavior of solutions of competition in gradostat with two limiting complementary substrates* Applied Mathematics and Computation, 49 (1) (1992), 19–37.

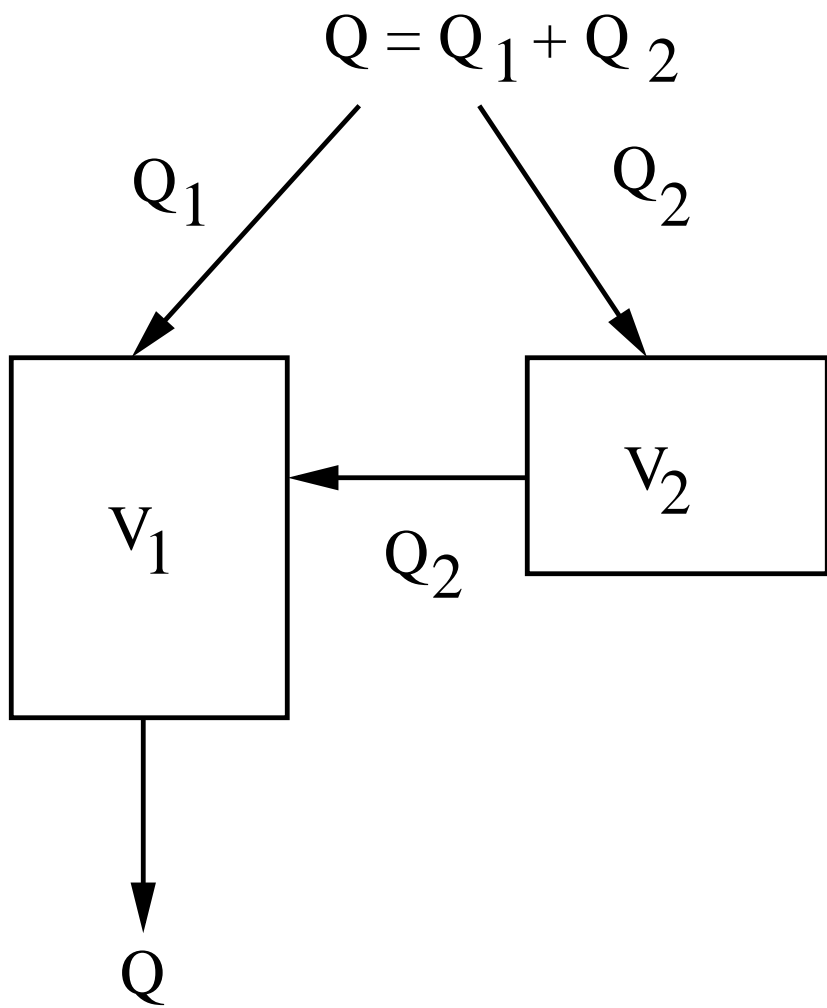

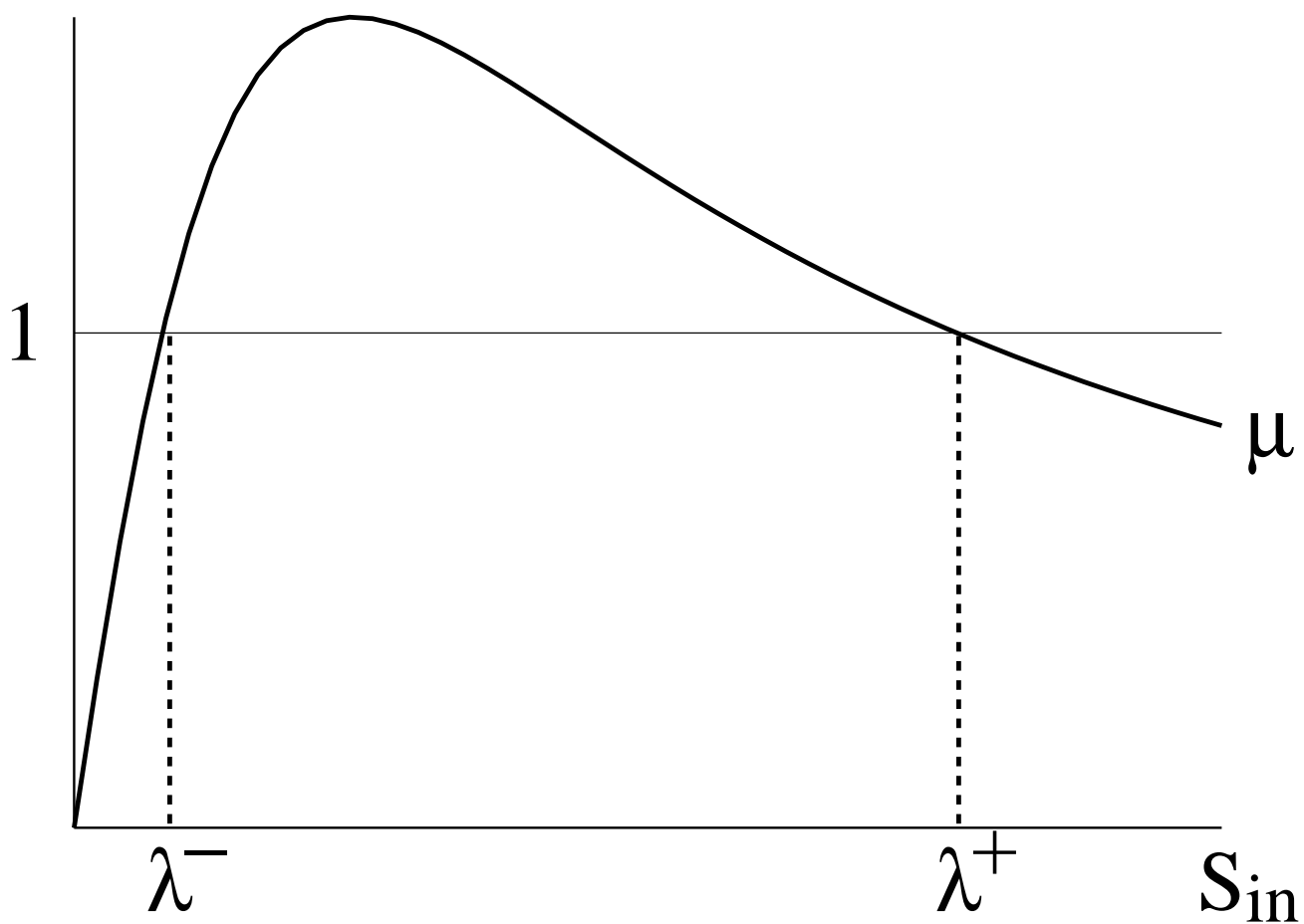

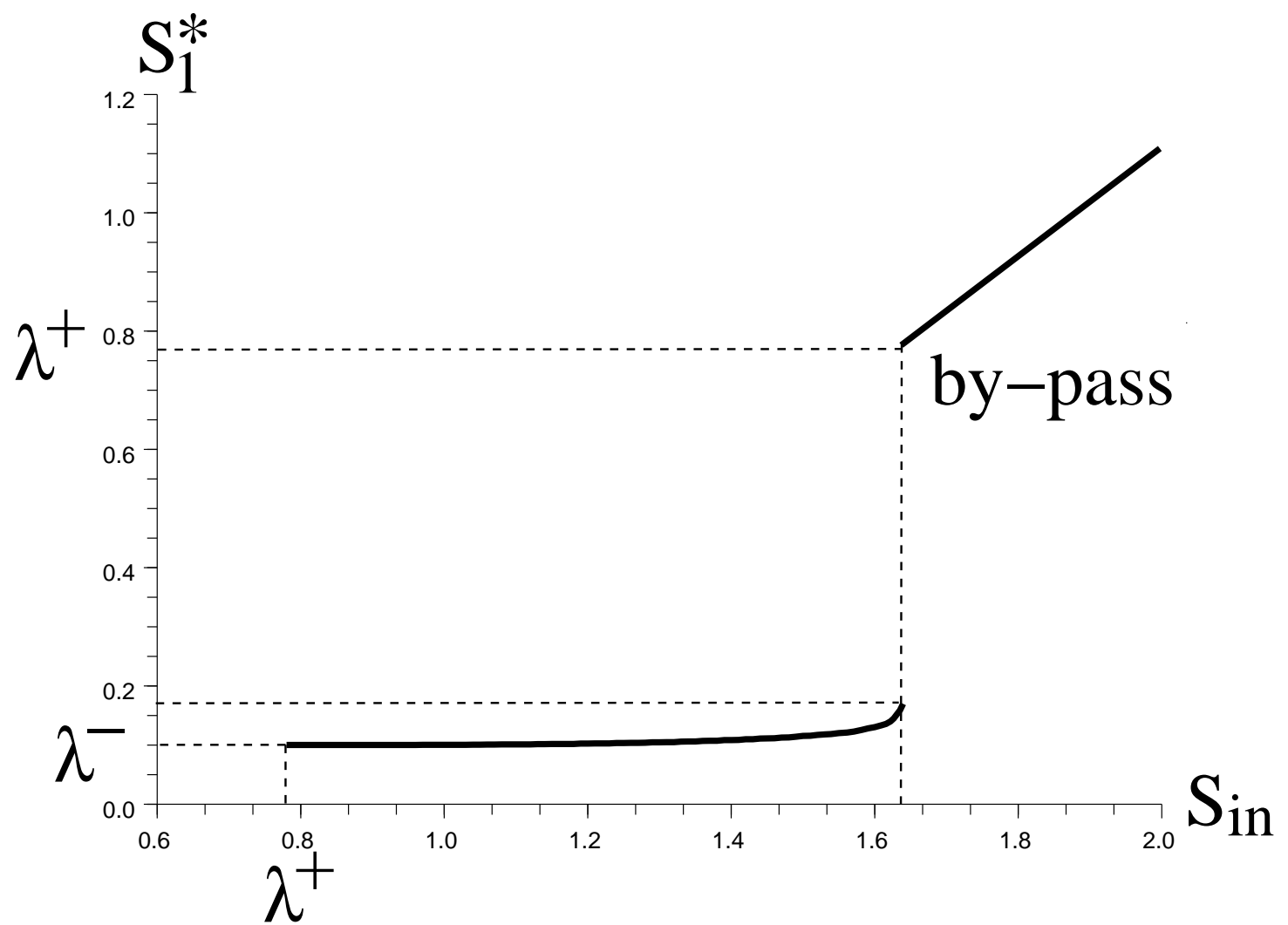

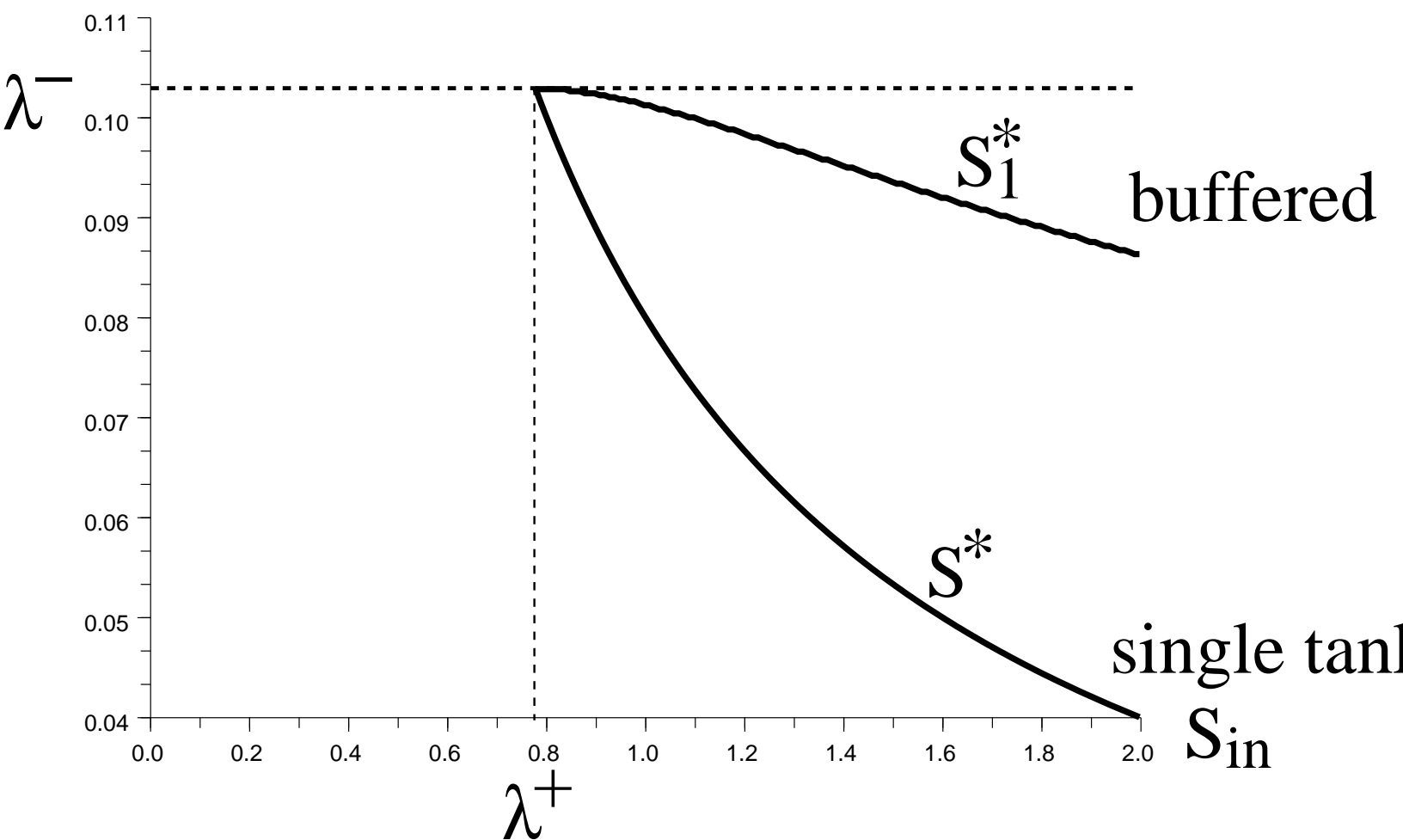

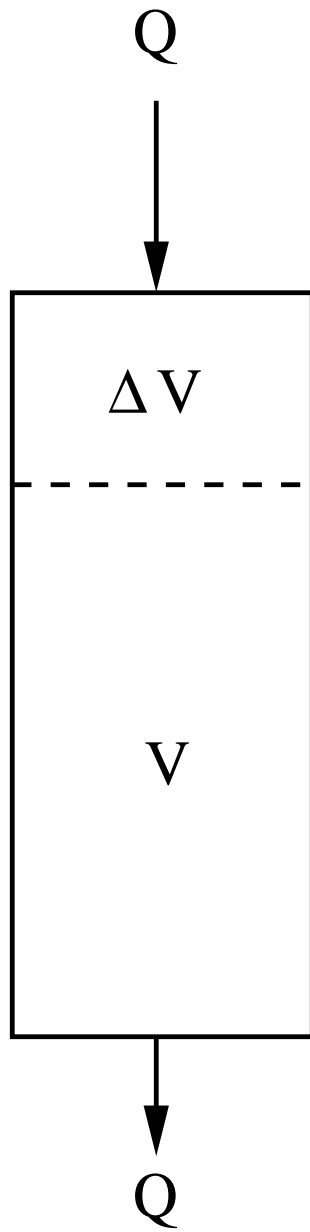
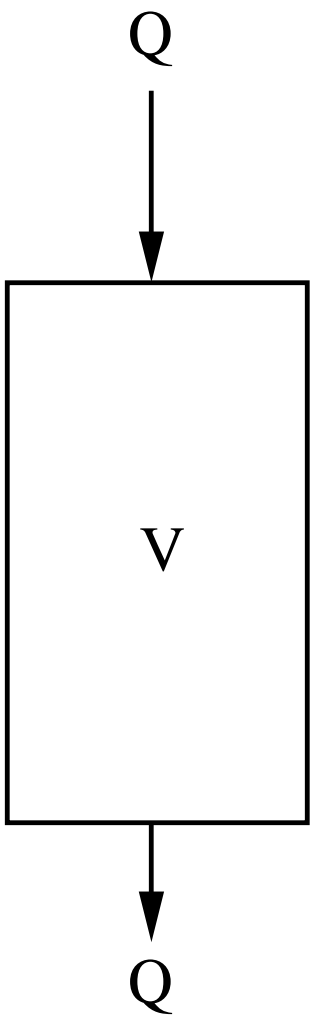

OR



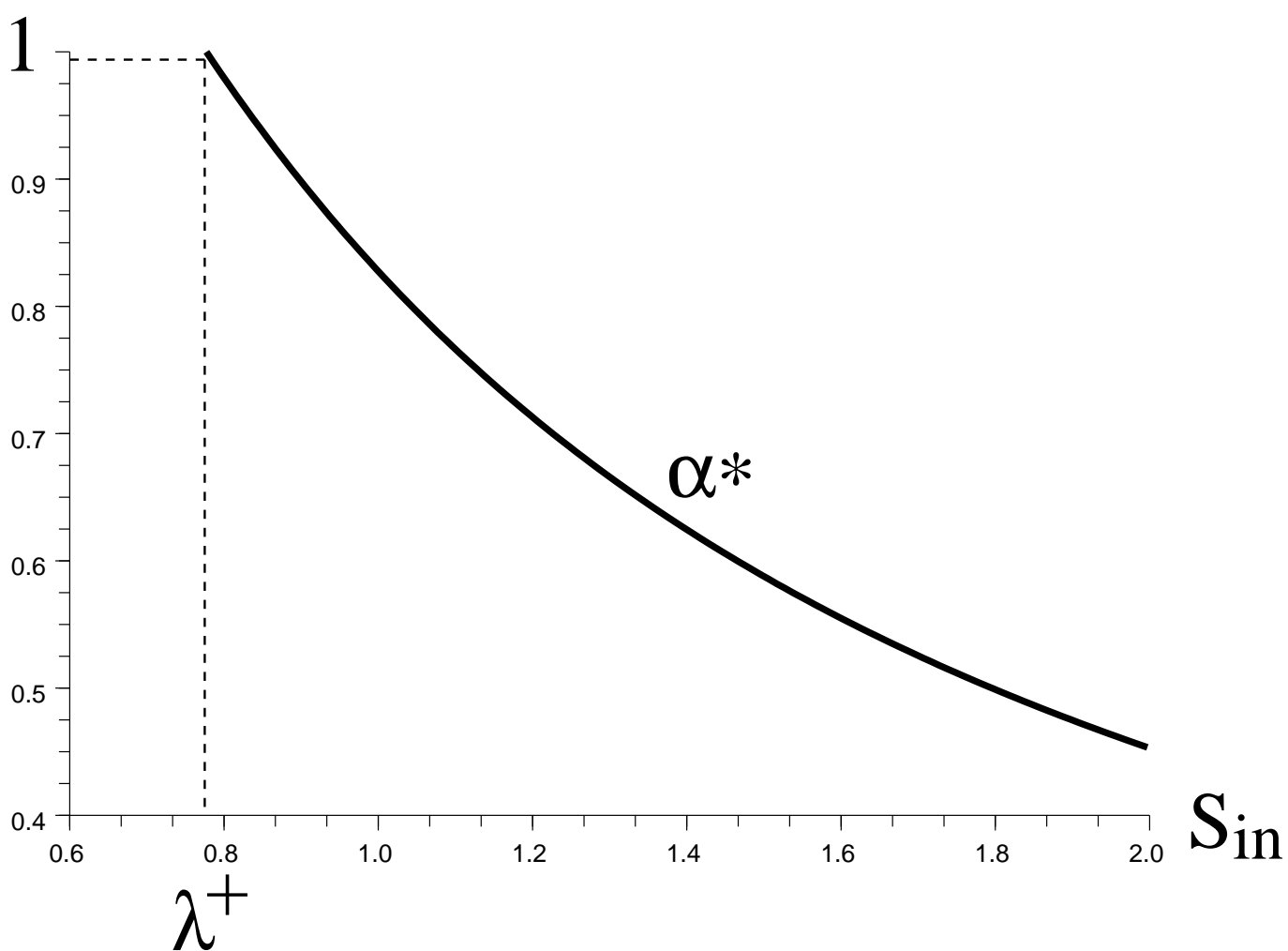

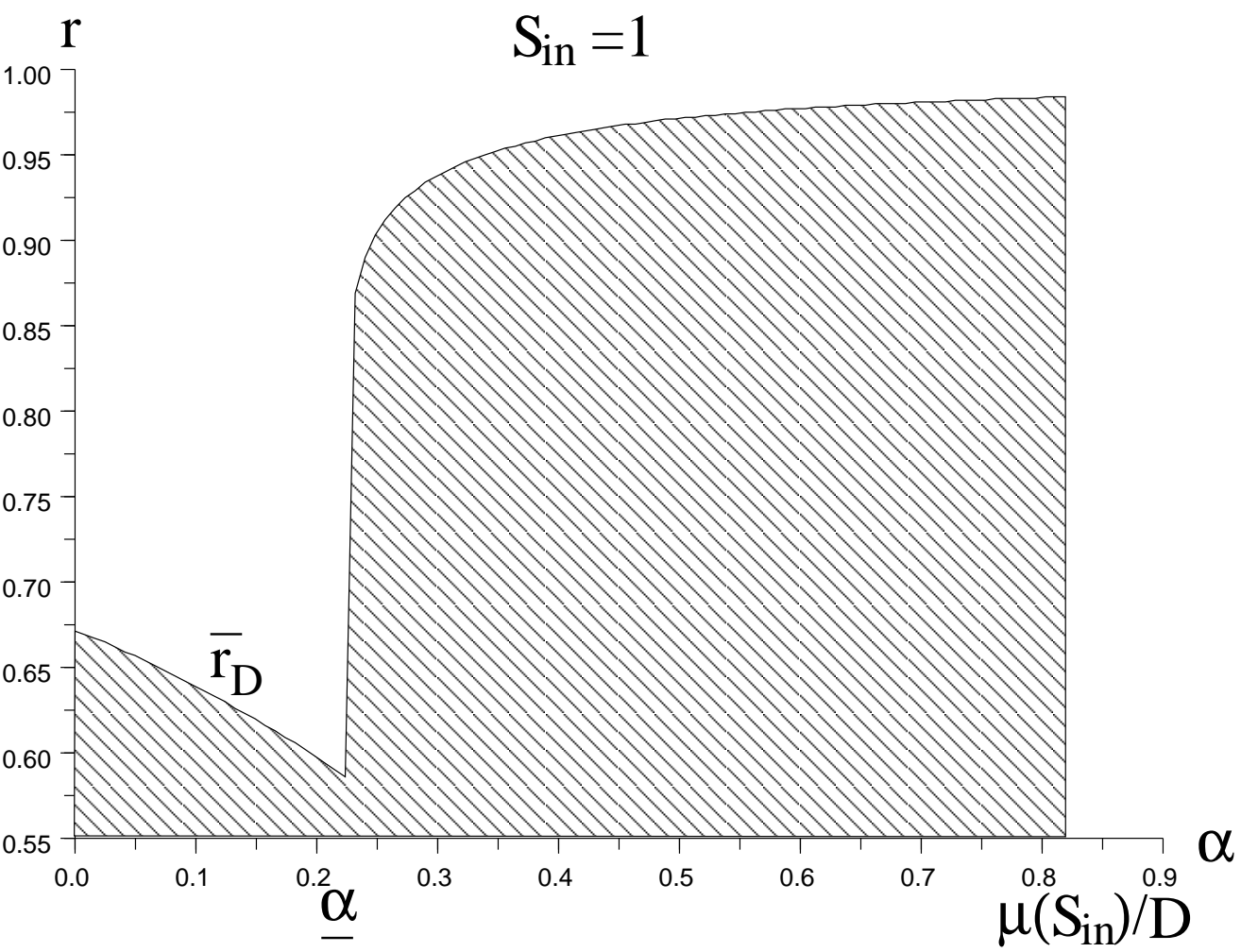

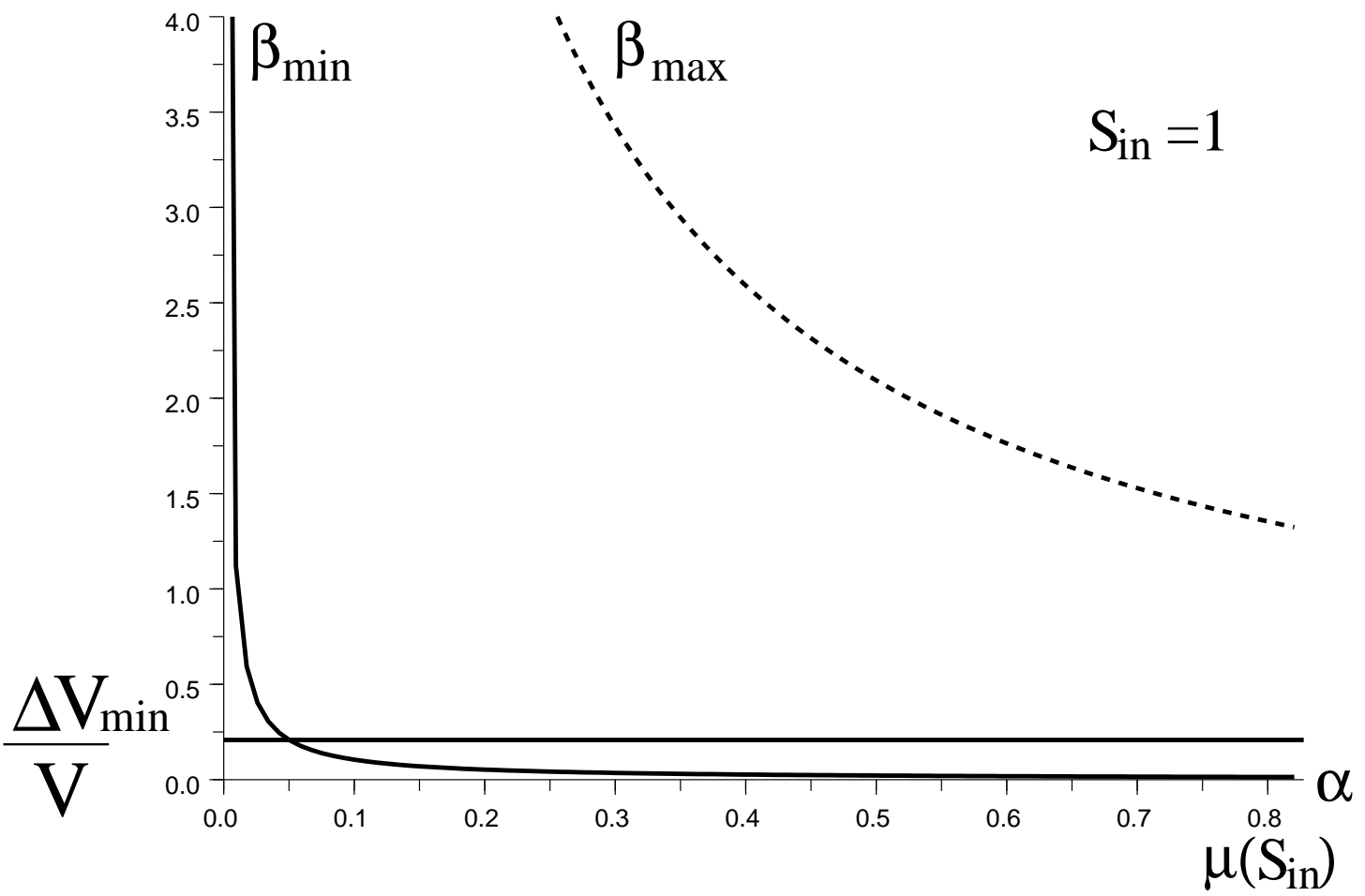

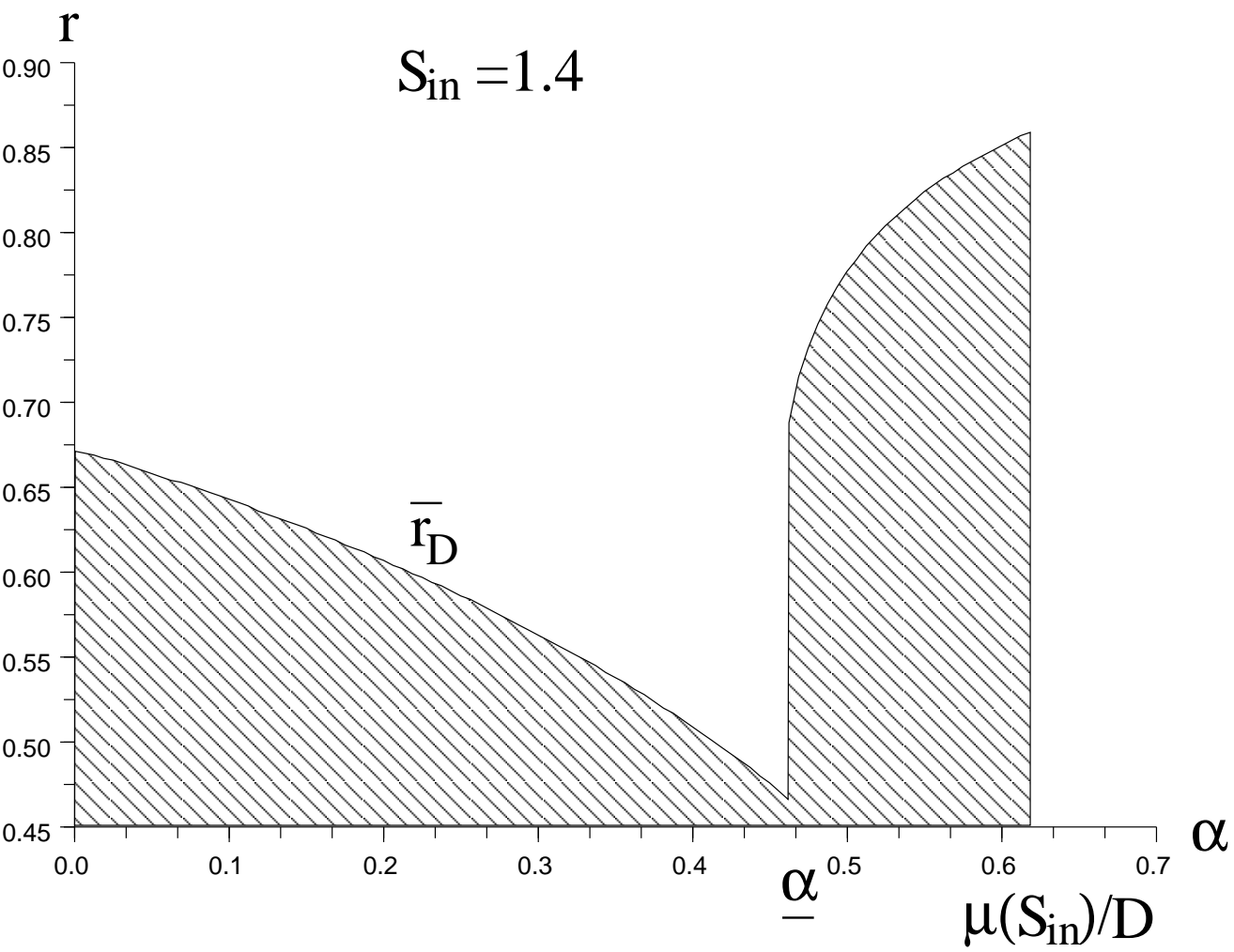

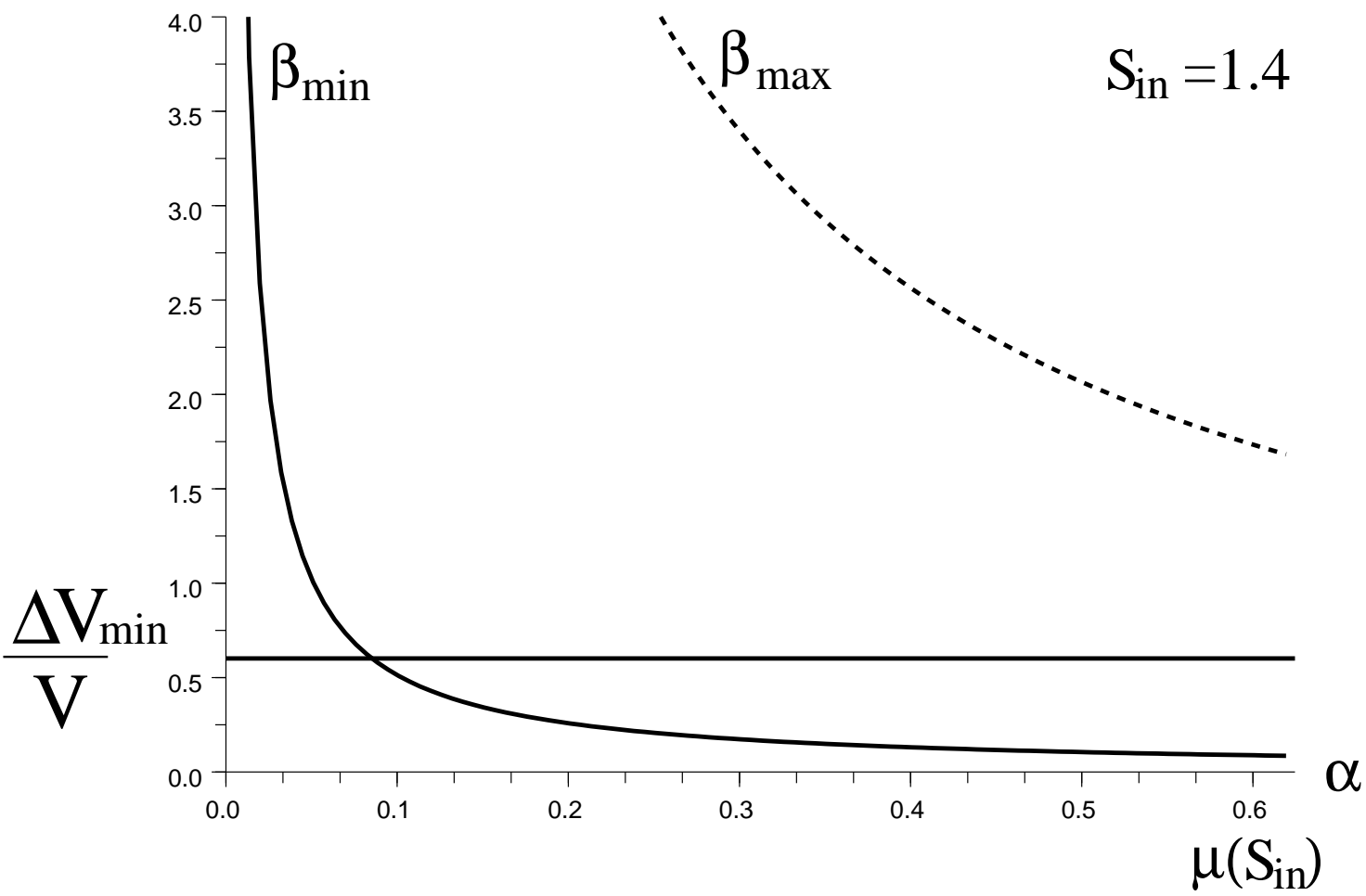

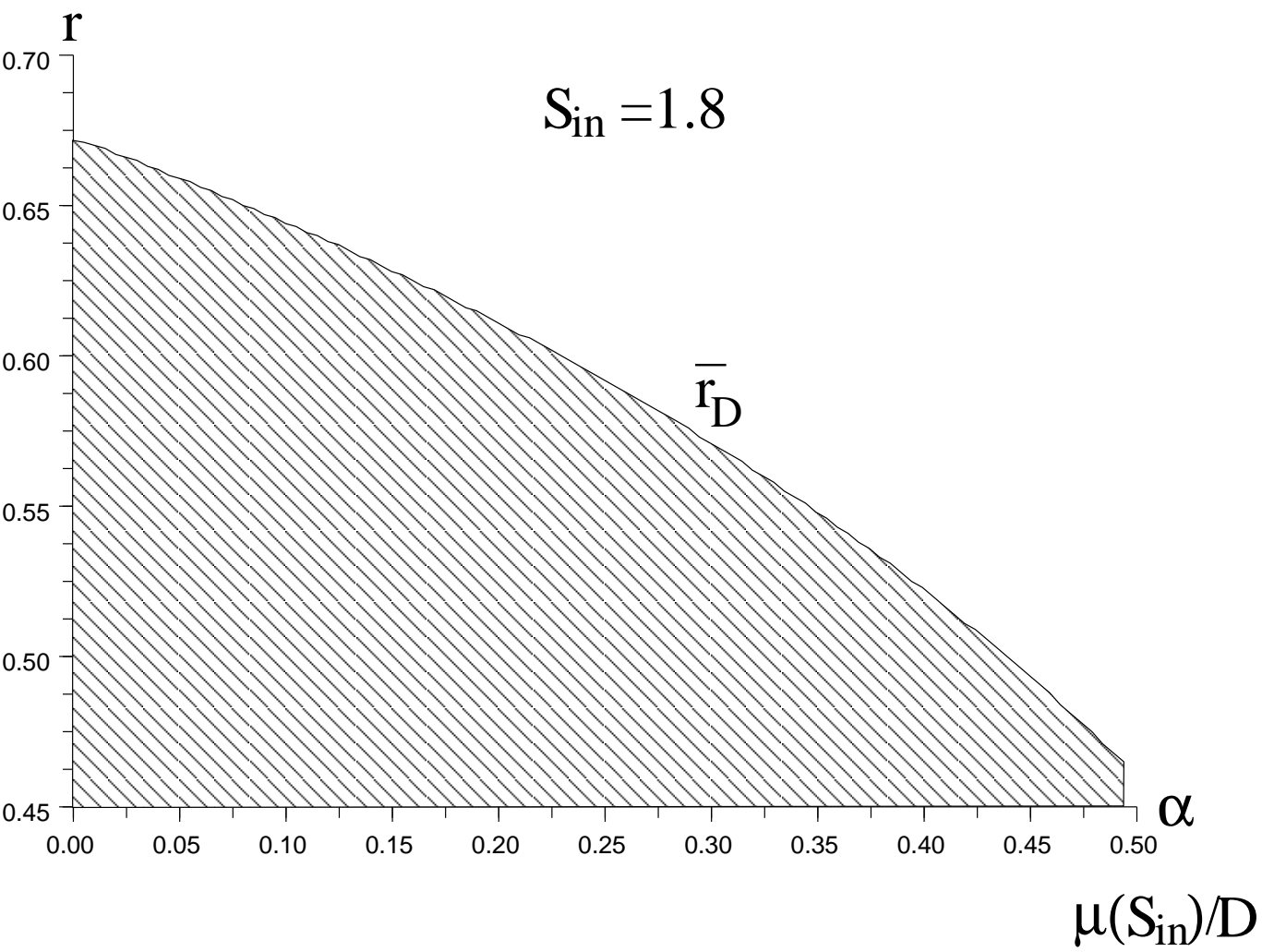

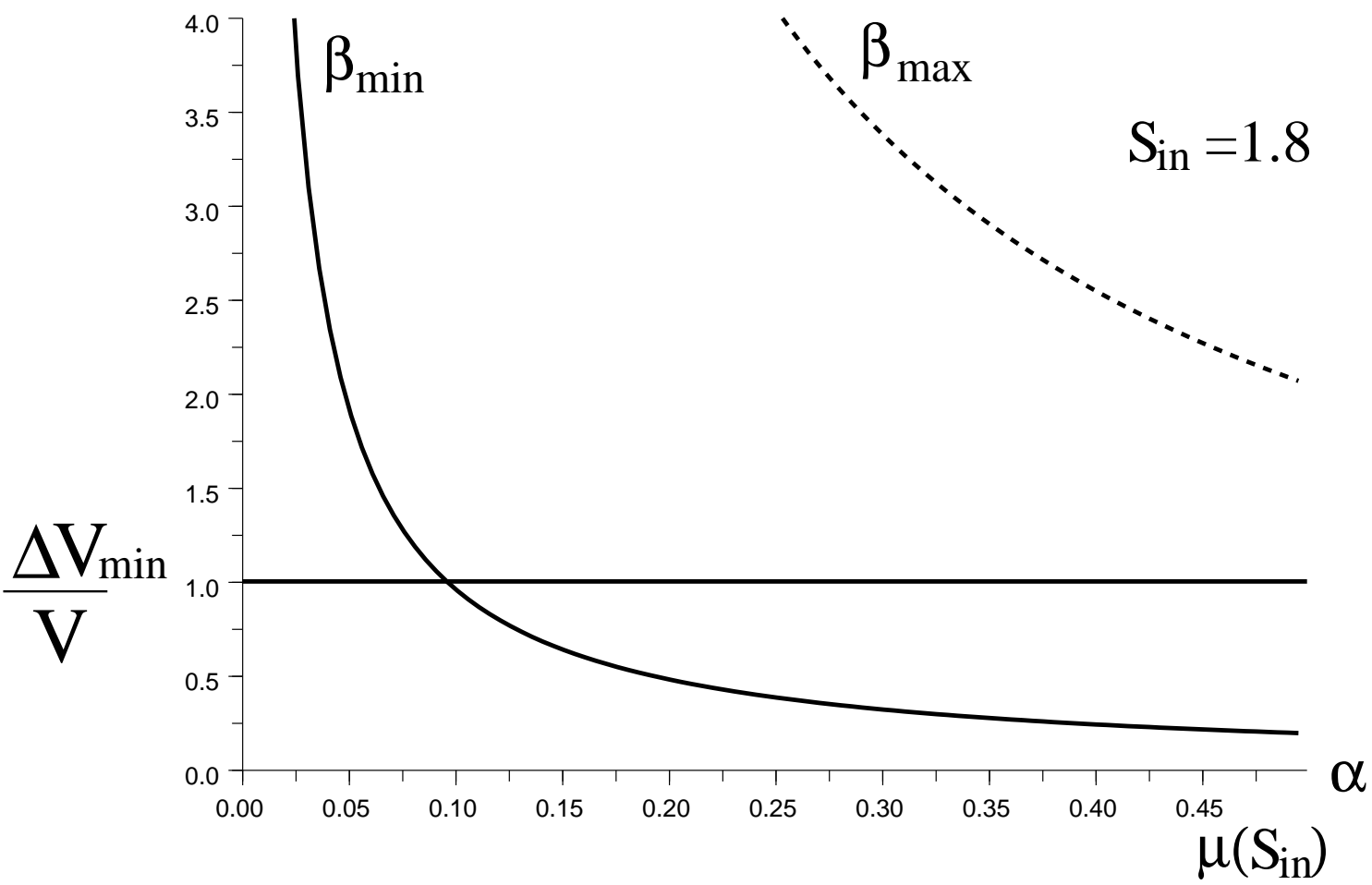

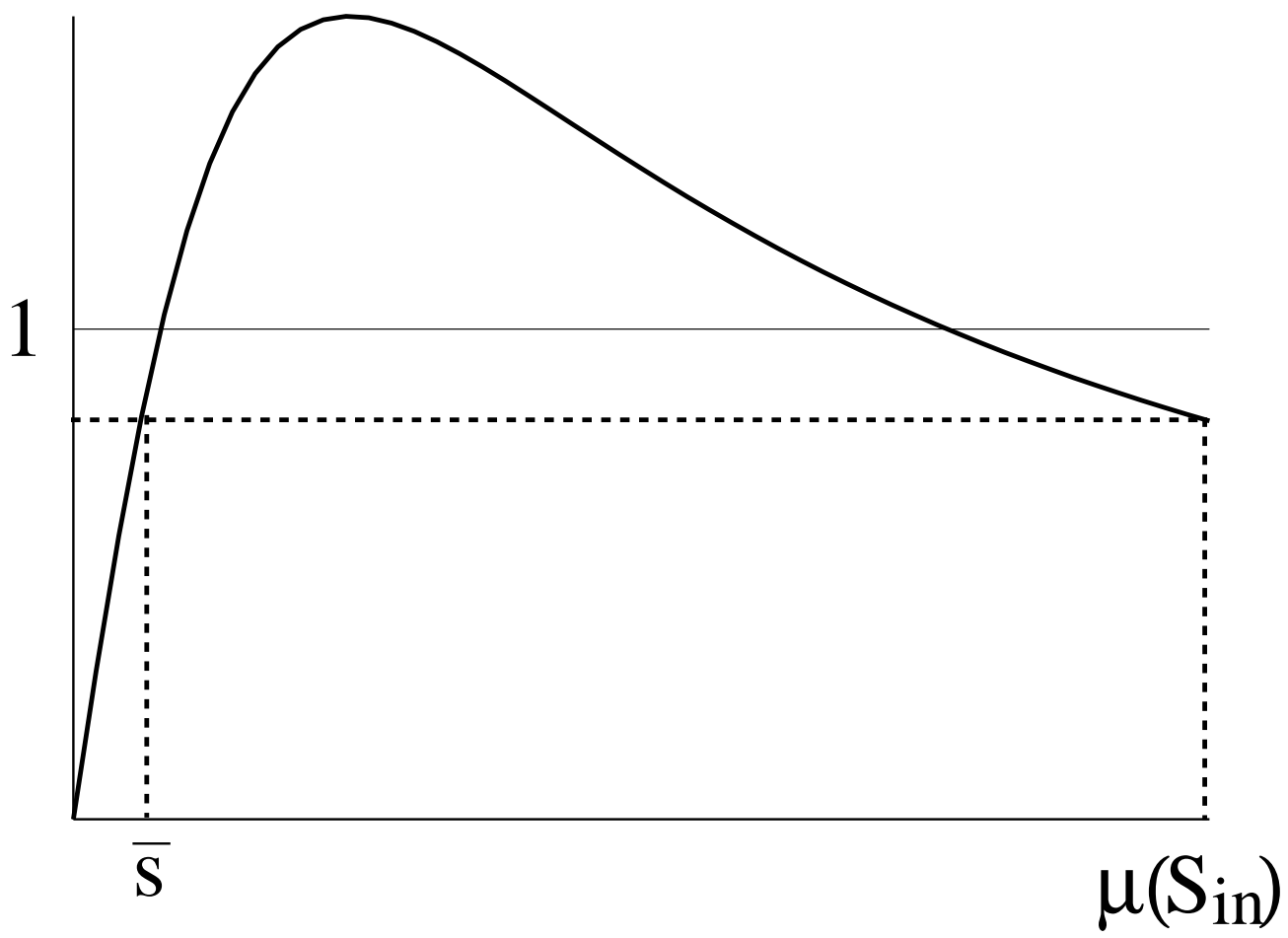

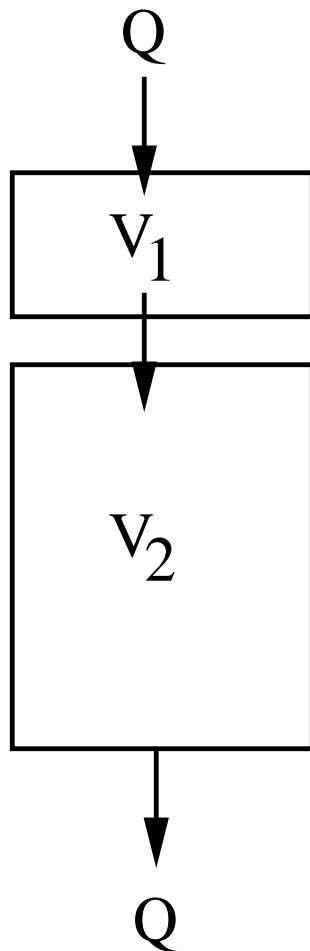
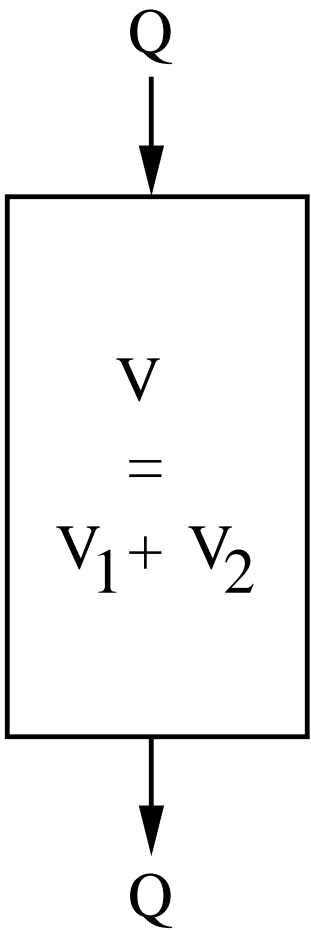

OR

