

Title Page

Comparative Analysis of Tandem Repeats from Hundreds of Species Reveals Unique Insights into Centromere Evolution

Daniël P. Melters*^{1,2}, Keith R. Bradnam*¹, Hugh A. Young³, Natalie Telis^{1,2}, Michael R. May⁴, J. Graham Ruby⁵, Robert Sebra⁶, Paul Peluso⁶, John Eid⁶, David Rank⁶, José Fernando Garcia⁷, Joseph L. DeRisi^{5,8}, Timothy Smith¹⁰, Christian Tobias³, Jeffrey Ross-Ibarra^{#9}, Ian F. Korf^{#1} and Simon W.-L. Chan^{2,8}

* contributed equally

corresponding author

1. Department of Molecular and Cell Biology and Genome Center, University of California, Davis, Davis, CA

2. Department of Plant Biology, University of California, Davis, Davis, CA

3. USDA-ARS, Western Regional Research Center, Albany, CA

4. Department of Evolution and Ecology, University of California, Davis, Davis, CA

5. Department of Biochemistry and Biophysics, University of California, San Francisco, San Francisco, CA

6. Pacific Biosciences, Menlo Park, CA

7. Department of Animal Production and Health, Universidade Estadual Paulista, IAEA Collaborating Centre in Animal Genomics and Bioinformatics, Aracatuba, SP 16050-680, Brazil

8. Howard Hughes Medical Institute

9. Department of Plant Sciences and Genome Center, University of California, Davis, Davis, CA

10. USDA-ARS, U.S. Meat Animal Research Center, Clay Center, NE

Corresponding author contact information:

Ian F. Korf
Department of Molecular and Cell Biology and The Genome Center
UC Davis
1 Shields Ave.
Davis, CA 95616
USA
ifkorf@ucdavis.edu
(530) 754 4989

Running title:

Comparative analysis of tandem repeats and centromere evolution

Keywords:

Centromere, tandem repeats, satellite DNA, comparative genomics, eukaryotes, evolution

Abstract

Centromeres are essential for chromosome segregation, yet their DNA sequences evolve rapidly. In most animals and plants that have been studied, centromeres contain megabase-scale arrays of tandem repeats. Despite their importance, very little is known about the degree to which centromere tandem repeats share common properties between different species across different phyla. We used bioinformatic methods to identify high-copy tandem repeats from 282 species using publicly available genomic sequence and our own data. The assumption that the most abundant tandem repeat is the centromere DNA was true for most species whose centromeres have been previously characterized, suggesting this is a general property of genomes. Our methods are compatible with all current sequencing technologies. Long Pacific Biosciences sequence reads allowed us to find tandem repeat monomers up to 1,419 bp. High-copy centromere tandem repeats were found in almost all animal and plant genomes, but repeat monomers were highly variable in sequence composition and in length. Furthermore, phylogenetic analysis of sequence homology showed little evidence of sequence conservation beyond ~50 million years of divergence. We find that despite an overall lack of sequence conservation, centromere tandem repeats from diverse species showed similar modes of evolution, including the appearance of higher order repeat structures in which several polymorphic monomers make up a larger repeating unit. While centromere position in most eukaryotes is epigenetically determined, our results indicate that tandem repeats are highly prevalent at centromeres of both animals and plants. This suggests a functional role for such repeats, perhaps in promoting concerted evolution of centromere DNA across chromosomes.

Introduction

Faithful chromosomal segregation in mitosis and meiosis requires that chromosomes attach to spindle microtubules in a regulated manner via the kinetochore protein complex. As the site of kinetochore assembly, the centromere is the genetic locus that facilitates accurate inheritance. Deletion of the centromere or mutation of critical kinetochore proteins results in chromosome loss [1, 2]. Proteins and DNA sequences involved in most essential cellular functions are characterized by their high degree of conservation. Given their conserved function, the observed rapid evolution of kinetochore proteins [3] and lack of homology of centromere repeats thus poses somewhat of a paradox [4].

Centromeres differ greatly in their sequence organization among species. In the budding yeast *Saccharomyces cerevisiae* a 125-bp sequence is sufficient to confer centromere function, and essential kinetochore proteins bind to this “point centromere” in a sequence-dependent manner [5]. Point centromeres are a derived evolutionary characteristic, as ascomycete fungi more distantly related to *S. cerevisiae* have much longer centromere DNAs and do not rely on specific sequences to recruit kinetochore proteins [5, 6]. In the limited set of plant and animal species that have been previously analyzed, centromere DNAs consist of megabase-sized arrays of simple tandem repeats (or satellite DNA), sometimes interspersed with long terminal repeat transposons [7-9]. Some taxa exhibit higher order repeat structures (HORs), in which multiple polymorphic monomers make up a larger repeating unit [10, 11]. When centromeric tandem repeat sequences of different species are compared, sequence similarity appears limited to short evolutionary distances [4, 5]. In fact, specific DNA sequences are probably dispensable for centromere function in most eukaryotes, as kinetochore proteins in diverse organisms can assemble on non-centromeric sequences [2, 12-16]. In humans, these “neocentromeres” have been found through karyotype analysis and can arise at many different loci [17]. In some animals and plants, individual chromosomes — or even the entire chromosome complement — may lack high-copy tandem repeat arrays [2, 13, 15, 16] and in rare cases centromere repeat sequences differ between chromosomes [18, 19]. The epigenetic nature of centromere location may be explained by the fact that kinetochores assemble on nucleosomes containing a centromere-specific histone H3 variant, CENH3 (CENP-A in human). Extreme cases of kinetochore protein assembly on diverse sequences are seen in polycentric [18] and holocentric chromosomes [20]. The former has a single very large primary constriction that contains three-to-five CENH3 foci [18], whereas the latter has CENH3-bound sequences and microtubule attachment sites along the entire length of mitotic chromosomes [21]. Despite their dispensable nature, the presence of tandem repeats at the centromere locus of most animals and plants suggests that they serve a function.

Many questions about centromere repeat evolution remain unanswered. How prevalent are high-copy tandem repeat arrays at the centromeres of different animal and plant species? Studies of centromere DNA in animals and plants have so far focused on single organisms or on small clades [5, 22] and few review articles have been dedicated to a broad survey of tandem repeats [23]. No conserved motif has been found for centromere DNA except in small clades (for

example, the CENP-B box found in mammalian centromeres [24]). Are there shared properties among centromeric tandem repeats from diverse animals and plants? In *Saccharomyces cerevisiae* and closely related yeast species, short centromere DNA sequences evolve three times faster than other intergenic regions of its genome [25, 26]. How rapidly do centromere tandem repeats evolve and which molecular processes govern their evolution? We performed a survey of tandem repeats in a large and phylogenetically diverse set of animal and plant species in order to address these questions.

Conventional methods used to identify centromeric tandem repeats, particularly CENH3 chromatin immunoprecipitation, are labor intensive and thus difficult to do on a large scale. In this paper, we identified and quantified the most abundant tandem repeats from 282 animal and plant species using a newly developed bioinformatic pipeline. Our method can utilize shotgun whole genome sequence (WGS) data from various sequencing platforms with varying read lengths, including Sanger, Illumina, 454, and Pacific Biosciences. Candidate centromere repeat sequences were characterized by a seemingly unbiased nature. Repeat monomers varied widely in length, GC composition and genomic abundance. Despite great differences in sequence composition, centromere DNAs appeared to evolve by expansion and shrinkage of arrays of related repeat variants (the “library” hypothesis [27]). Using Pacific Biosciences (PacBio) single molecule real-time sequencing to span many contiguous monomers, we characterized the mixing of repeat variants within a single array and the presence of higher-order repeating units. Our data greatly broaden the phylogenetic sampling of centromere DNA, putting evolutionary conclusions about this fast evolving chromosome region on a firmer footing.

Results

A bioinformatic pipeline to identify candidate centromere tandem repeats.

Centromere DNAs in most animals and plants share two distinctive properties: the presence of tandem repeats, and their extremely high repeat abundance (often >10,000 copies per chromosome). Therefore, we hypothesized that the most abundant tandem repeat in a given genome would be the prime candidate for the centromere repeat (our method is not designed to find centromere-specific retrotransposons or chromosome-specific repeat sequences). To find such sequences *de novo* from whole genome shotgun (WGS) sequence data, we developed a bioinformatic pipeline that identifies tandem repeats from a variety of sequencing technologies with different read lengths (see Methods) (Fig. 1A). For example, the 171 bp human centromere repeats [11] were identified from Sanger reads, the ~1,400 bp Bovidae repeats [28-30] were identified from PacBio reads (Supplementary Fig. S5), and the 728 bp monkeyflower (*Mimulus guttatus*) repeats [31] were identified from assemblies of Illumina reads. In each case, the most abundant tandem repeat unit was considered to be the candidate centromere DNA.

Validating the bioinformatic pipeline by identifying known centromere tandem repeats

To validate candidate centromere tandem repeats, we compared our results to sequences described in the literature (Supplementary Table S2). Centromere DNAs have been characterized by restriction enzyme-based methods (e.g. laddering on ethidium bromide-stained gels) combined with fluorescence in situ hybridization (FISH), and by chromatin immunoprecipitation (ChIP) with antibodies raised against a kinetochore protein (typically the centromere-specific histone CENH3). Overall, centromere DNA sequences have been described from 43 of the 282 species in this study. In 38 out of 43 cases, we identified a similar repeat to that reported in the literature (Supplementary Table S2). In the case of opossum (*Monodelphis domestica*) and elephant (*Loxodonta africana*), centromere repeat monomers are believed to be very long (528 and 936 bp respectively) [32] and therefore cannot be found using Sanger reads. We lacked suitable Illumina or 454 data to allow assembly of long tandem repeats from these species, and did not have PacBio data to find long repeats directly. Potato and pea are unusual in that centromere repeats differ across chromosomes [18, 19], with some potato chromosomes lacking tandem centromere repeats entirely [19]. These repeats are too diverse and too long to be identified by our pipeline (upper limit of 2 kbp). Other discrepancies between our candidate centromere repeats and published sequences may be explained by the fact that many previous studies used experimental methods that did not quantify all tandem repeats in the genome (see Supplementary Table S2 for a per species explanation).

In limited cases, an assembled reference genome can assist in identifying a bona fide centromere tandem repeat. As expected for a true centromere DNA sequence, the 1,419 bp repeat from cattle is generally clustered into one large array on all 30 chromosomes in the UMD3.0 genome assembly [33]. These putative centromere arrays contain hundreds of repeat copies (notably, secondary arrays elsewhere in this genome assembly contain only 5–10 copies of the monomer).

CENH3 ChIP followed by sequencing is the most definitive method to confirm that a given sequence underlies the functional kinetochore. Only 13 species out of the 43 had CENH3 ChIP-seq data, and our method correctly identified the published centromere tandem repeat in 10 out of 13 of these cases. The three exceptions were opossum, elephant, and potato where we lacked appropriate sequencing reads to find long tandem repeats (opossum and elephant) or the tandem repeats were too diverse (potato). In summary, our bioinformatic pipeline identified the correct centromere tandem repeat in the large majority of cases where experimental data was available.

In two cases, the most abundant tandem repeat was not the known centromere DNA sequence. In the sequenced maize strain B73 (*Zea mays*) [34], heterochromatic “knobs” contain highly abundant tandem repeats that outnumber the centromere tandem repeat CentC [35]. Knob number, size, repeat abundance and distribution can differ depending on the particular maize variety analyzed, as repeat abundance is variable between isolates [36, 37]. A 178 bp tandem repeat is present at the centromere of the Tammar wallaby (*Macropus eugenii*), but this sequence was only the third most abundant tandem repeat in our analysis [38]. By mammalian standards, Tammar wallaby centromeres are unusually small (~450 kbp per chromosome), and tandem repeats make up a minority of this chromosome region because it is also populated by a centromere-specific retroelement [38].

Candidate centromere tandem repeats from many uncharacterized animal and plant species

To detect candidate centromere repeats, we analyzed a total of 282 species, comprising 78 plants and 204 animals spanning 16 phyla (Fig. 2, Supplementary Table S1). Sanger, Illumina, and 454 sequences were obtained from public databases, and we also performed our own PacBio sequencing. The WGS data included 171 species from Sanger sequencing, 132 from Illumina, 13 from 454, and 9 from PacBio (Fig. 1C). For the 37 species which had both Sanger and assembled Illumina data, both data types yielded the same candidate centromere repeat in the majority of cases (28 out of 37) (Fig. 1C). In most cases where analysis of unassembled Sanger reads revealed a different repeat to Illumina data, individual Sanger reads were too short to find the long repeat monomers (see Supplementary Table S4 for a per species explanation).

Many species whose centromere DNAs had not been previously characterized showed a single tandem repeat whose abundance was much greater than all other tandem repeats in the genome. For example, the American pika (*Ochotona princeps*), *Hydra* (*Hydra magnipapillata*), and Colorado Blue Columbine (*Aquilegia caerulea*) had candidate centromere DNAs of 341 bp, 183 bp, and 329 bp respectively (Fig. 1C).

The most accurate measurements of centromere tandem repeat array size in animals and plants are generally in the range of ~500 kbp to several Mbp [10, 38-40]. Although estimated repeat abundance is subject to several experimental biases, we calculated the average amount of repeat per chromosome, and most organisms in our survey were estimated to contain hundreds of kbp (Supplementary Table S1). Since our analysis was based on WGS data, it is not possible to detect chromosome-to-chromosome variation [2, 15, 16].

How rapidly do centromere DNA sequences evolve?

An all-vs-all BLAST search of our consensus repeats revealed that sequence conservation was limited to only very closely related species. We found 26 groups of species that showed sequence similarity between centromere tandem repeats (Fig. 2, Supplement Fig. S1). Notable groupings of species with substantial sequence similarity included the primates (Supplement Fig. S2), cichlids (Fig. 6A-B) and grasses (Fig. 6C-D).

The well-studied nature of human centromeres, and the availability of many closely related species, make primates an excellent clade to illustrate the evolution of centromere DNAs [11, 41, 42]. Candidate centromeric tandem repeats in primates showed similarity between monkeys and apes (Fig. 3A, Fig. 4A), but these candidate centromere DNAs were unrelated to those in more basal primates (tarsiers and prosimians). We inspected lower abundance tandem repeat sequences from the Tandem Repeats Finder (TRF) output, and no tandem repeat in tarsiers or prosimians was found to have sequence similarity to the primate candidate centromeric tandem

repeat. These results reinforce recent findings showing that the aye-aye (*Daubentonia madagascariensis*) has centromere repeats with no similarity to monkeys and apes [42].

Cichlid fish are another clade in which we identified both conservation and rapid divergence of centromere repeats. Lake Malawi cichlids and the Nile tilapia (*Oreochromis niloticus*) had candidate centromere DNAs that shared 78% sequence similarity, although tilapia diverged from other cichlids 45 MYA. The Princess cichlid *Neolamprologus brichardi* (from Lake Tanganyika) had a candidate centromere repeat with no sequence similarity to either the Lake Malawi cichlids or Nile tilapia, though *Neolamprologus* diverged from Lake Malawi cichlids only 30 MYA. Similar patterns of both conservation and rapid change can be seen in the grasses (Fig. 6C-D). A maize-like centromere repeat can be found in *Panicum*, *Setaria*, and even in a species as distant as rice (*Oryza*), which diverged from maize ~41 MYA. In contrast, sorghum-maize (9 MYA) and *Hordeum-Aegilops* (14 MYA) comparisons show little to no sequence similarity.

To evaluate the rate of sequence evolution across the entirety of our sampled taxa, we assessed the conservation of sequence identity across the phylogeny using a node-averaged comparative analysis (Fig. 3A). We fit a model of exponential decay with divergence, finding that on average sequence identity falls rapidly to background levels (i.e. random 25% identity) after ~50 MYA.

Candidate centromere tandem repeats from 282 animals and plants display no readily apparent conserved characteristics

If centromere DNAs are fast evolving, do their repeat monomers at least possess other conserved properties? As our survey is the broadest phylogenetic analysis of tandem repeats to date, we asked if candidate centromere DNAs from 282 species shared common characteristics. Our analyses showed that this was not the case.

First, centromere tandem repeat monomer length is not conserved. As CENH3 is essential for kinetochore nucleation, it has been hypothesized that centromere repeat monomers may tend to be about the size of one nucleosomal DNA [9, 43], as is seen with human (171 bp), *Arabidopsis thaliana* (178 bp), and maize (156 bp) centromere DNAs. This is clearly not a universal rule, as some centromere tandem repeat monomers are much shorter and longer than nucleosomal sizes (e.g. soybean at 92 bp [44, 45] and cattle at 1,419 bp [30]) (Fig. 4A). Plant species tended to have repeat sequences with lengths of approximately 180 bp, whereas we found a broader length distribution in animals. Modest trends in our data, however, may reflect sampling bias in the species for which WGS data was available in public archives rather than biologically meaningful preferences in centromere tandem repeat length.

Second, GC content of centromere tandem repeats is not conserved. Based on limited analysis of animal centromere repeats, it was suggested that centromeric DNA is AT-rich [4]. Our analysis of 282 species revealed that centromeric DNA can be very GC-rich (Fig. 4B), although a slight preference for AT-rich tandem repeats was observed in animals. Plant species do not appear to have a preference for AT- or GC-rich centromere tandem repeats.

Third, the abundance of centromere tandem repeats varies widely (Fig. 4C). We calculated repeat abundance by finding the proportion of reads that matched the repeat monomer (using a set of randomly sampled reads, see Methods and Supplemental Methods). Tandem repeat abundance can be compared between species, but is subject to variability introduced by different library construction protocols at particular sequencing centers, and by biases in the way different sequencing technologies capture high-copy repeats. We compared repeat abundance of 40 species for which there was sequence data from multiple sequencing technologies. On average, sequences derived from Illumina sequencing had higher estimated repeat abundances compared to Sanger, 454 or PacBio data. For most species we estimated that at least 0.5% of the genome was comprised of the candidate centromeric tandem repeat, but the overall percentage was highly variable (Fig. 2, Fig. 4C).

Simple nonphylogenetic correlations found no relation between repeat length, GC content, and genomic fraction of candidate centromere tandem repeats (Supplementary Fig. S3). Similarly, we did not find a correlation between these factors and genome size, genome-wide GC content or chromosome number.

To explicitly test for conservation of sequence characteristics at a finer phylogenetic resolution, we searched for signals in phylogenetic trees that represented the grass and primate clades (Fig. 3B). Both clades are of a similar age (40–45 MYA for the most divergent species) and show substantial sequence similarity among taxa. We calculated Blomberg's K statistic [46], a measure of phylogenetic conservation, for various tandem repeat characteristics. The K statistic indicates the amount of phylogenetic signal in the data. Values of K greater than one suggest that related taxa resemble each other more than would be expected given a null model in which the trait evolves along the tree according to Brownian motion. Values of K less than one are observed when related taxa are less similar than expected under the null model. Although repeat monomer length, GC content, and genome fraction all had values of $K < 1$ in the grasses, none were statistically significant. In contrast, values for all three characteristics were significantly different from the null model in primates, with GC content and repeat monomer length showing $K > 1$ and repeat abundance $K < 1$. These data suggest that individual clades likely differ in terms of their tendency for closely related species to have centromere repeats that share conserved sequence characteristics.

Which species lack candidate high-copy tandem repeats at their centromeres?

Which animal and plant genomes lack high-copy centromere tandem repeats? The nematode *Caenorhabditis elegans* is a useful negative control for measuring tandem repeat abundance (see red dashed line in the genomic fraction column of Fig. 2), because it has holocentric chromosomes and has been reported to lack centromere tandem repeat arrays in its genome [21]. In total 41 species had a lower abundance of tandem repeats than in *C. elegans*, and these could be assumed to lack high-copy centromere tandem repeats. Nine of these species are known to be holocentric [47] and are not expected to have large tandem arrays. Fungi such as *Saccharomyces*

cerevisiae, *Candida albicans*, and *Schizosaccharomyces pombe* have small genomes and do not contain high-copy tandem repeat arrays at their centromeres [5]. Many of the other genomes that exhibited low tandem repeat abundance also had small genomes including 7 species of basal plants (green algae, moss, and liverwort) and 11 animals. A few species exhibited low tandem repeat abundance despite possessing large genomes (hedgehog (*Erinaceus europaeus*), tenrec (*Echinops telfairi*), seal (*Leptonychotes weddellii*) and dolphin (*Tursiops truncatus*). This may be due to these species having large repeat units that could not be identified in the available Sanger reads. While a definitive answer is not possible yet, it appears that species lacking large tandem arrays tend to have holocentric centromeres or small genomes.

Higher order repeat structure and evolution of novel repeat monomers.

Primate centromeres contain higher order repeat (HOR) structures [11, 48], in which multiple repeat monomers with specific polymorphisms form a unit that itself is repeated (Fig. 5A). HOR structure was easiest to observe in Sanger data, which combines relatively long reads with high sequence accuracy. We used the output from Tandem Repeats Finder (TRF) [49] to identify higher order repeat structures among Sanger sequences from the NCBI trace archive. TRF reports both the repeat monomer, as well as repeating units carrying multimers of the monomer that may represent HOR structure. TRF-defined repeats that occupied approximately the same coordinates within a single read were compared to identify whether longer repeats were dimers of the basic monomer. In true HOR structures, the percentage identity between adjacent multimers should be much higher than between individual monomers (TRF should also report higher scores for the repeats with the longer monomer). Therefore, we filtered TRF output to detect these multimers that had both a higher percentage identity and a higher TRF score compared to the monomeric repeat that spanned the same coordinates.

Clear cases of HOR structure were identified in 76 of the 171 species with Sanger data. Phylogenetic trees constructed with individual monomers extracted from a single read showed that the “A” monomers and “B” monomers from a dimeric “AB” structure that clustered separately (Fig. 5B-C), confirming that the AB structure indeed represented a HOR unit. HOR structure has been previously described in primates, but our analysis shows that it is widespread across both plant and animal kingdoms. The capability to detect HOR units is limited by Sanger read length, so shorter repeat monomers were more likely to display HOR structures. We rarely identified HOR structures that had three or more copies of a repeat monomer, because such structures require at least six monomers to be found in a single Sanger read.

Can HOR structure result in evolution of a new centromere tandem repeat? The centromere repeat monomer has only been reported for one New World Monkey and its length (343 bp) is essentially double the size of human alpha satellite [50]. We extended this analysis to three New World Monkeys and fifteen Old World Monkeys and apes (Fig. 5D, Supplementary Fig. 2). All Old World Monkeys and apes had a 171 bp candidate centromeric tandem repeat, whereas New World Monkeys had a 343 bp candidate centromeric tandem repeat. If the 343 bp repeat is split into two equal halves and aligned to the 171 bp repeat, both halves align, but each has specific

polymorphisms and indels (Fig. 5D, Supplementary Fig. S1). These data suggest that in the New World Monkey clade, a doubled version or dimer of the ancestral 171 bp repeat became the dominant centromeric tandem repeat. Such patterns of evolution are likely to be general, as they depend only on acquisition of polymorphism and a particular pattern of recombination within a repeat array [51].

Where HOR structure is present, it means that our calculated values for the abundance of candidate centromere repeats are most likely underestimates. A notable example of this occurs in the gorilla genome (*Gorilla gorilla gorilla*). We correctly identify the 171 bp centromere repeat as the most abundant repeat and this accounts for approximately 1.3% of the genome. However, we also identify a separate, but related, 340 bp repeat which represents a doubled version of the 171 bp repeat. This second repeat accounts for a further 1.2% of the genome, showing that dimeric HOR structure may be especially common among gorilla centromere repeats.

Coexistence of related repeats support the “library” hypothesis

The “library” hypothesis aims to explain how centromere DNA evolves so rapidly [27]. This hypothesis assumes that variants of centromere tandem repeats co-exist within the same tandem arrays. Over time, the abundance of particular variants stochastically changes through both expansion and shrinkage [52, 53], resulting in replacement of the most abundant variant with a different variant. Centromere repeat variants could arise by point mutation, deletion, insertion or by mixing of different parental sequences during allopolyploid formation (in all cases, a process such as gene conversion would be required to transfer variants between chromosomes) [54]. Are there cases in our data set that support the “library” hypothesis? Specifically, do repeat variants differ and are there cases where such a repeat was able to colonize a genome and replace the original monomer?

Several Lake Malawi cichlids contained a 237 bp candidate centromeric tandem repeat, whereas the closely related Nile tilapia contained a shorter repeat of 206 bp (Fig. 6A-B). However, the Nile tilapia did contain a less abundant, 237 bp repeat that was similar to the Lake Malawi cichlid repeat (Supplementary Fig. S4). This suggests that the centromere tandem repeat in the common ancestor of Lake Malawi cichlids and Nile tilapia was replaced by a related sequence (having either an insertion or deletion of 29 bp) in one of the two modern clades.

More support for the “library” hypothesis was seen in the grasses (family *Poaceae*); this was the largest plant clade in our dataset that exhibited sequence similarity among most of its members. The modal length of repeat monomers in grasses was 156 bp, but deletions and insertions were found in several species (an 80 bp conserved motif between rice and maize was previously noted within this sequence [40]). Eight of the fifteen grass species had candidate centromere repeats that displayed no similarity to the common 156 bp sequence (Fig. 6C-D). We then searched our data for less abundant tandem repeats related to the dominant repeat monomer. Sanger sequence data for four grass species revealed distinct centromere tandem repeat variants. Maize and foxtail millet (*Setaria italica*) only contained one variant each (variants A and D respectively),

witchgrass (*Panicum capillare*) had two variants (B and C) and the switchgrass genome contained three variants (A, B, and C). Variant B itself consists of two distinct repeats, one of 175 bp (variant B1) and another of 166 bp (variant B2). B2 differs from B1 by the deletion of 9 bp, but these two subvariants are otherwise very similar in sequence, so we consider them as one variant (variant B). The existence of related repeat variants in switchgrass and witchgrass is similar to our observations in Lake Malawi cichlids and Nile tilapia, and both these cases further support the “library” hypothesis [27].

Next we asked if switchgrass repeat variants occupied the same tandem repeat arrays by using computationally derived repeat monomers as probes in fluorescent in situ hybridization (FISH) experiments. FISH analysis confirmed that these repeat variants were found at centromeres (Fig. 7). Variants not found in a given genome did not stain chromosomes from that species, showing that our hybridization conditions were specific. The variant A probe only hybridized strongly to one switchgrass chromosome. Variant B in switchgrass was comprised of two repeats (B1 = 175 bp and B2 = 166 bp) and FISH experiments revealed that all switchgrass chromosomes showed hybridization to variants B1, B2 and C, but with differing hybridization intensities (Fig. 8A-B). These data indicate that specific chromosomes harbor different amounts of particular repeat variants, again suggesting that repeat arrays can grow and shrink over evolutionary time.

Pacific Biosciences sequencing reveals that switchgrass repeat arrays are homogeneous and contain long higher order repeat structures.

Centromere repeat variants in switchgrass were found on the same chromosomes using FISH (Fig. 8A-B), but the resolution of these experiments could not distinguish large homogeneous arrays of two variants (in close proximity) from arrays that showed more significant mixing of repeat variants. Theoretical simulations predict that an array of polymorphic repeats can become rapidly homogenized by unequal crossing over [51]. Conversely, gene conversion can introduce novel variants into the middle of a repeat array. To determine the degree to which variants were mixed in a given array, we used the PacBio sequencing platform, which yields much longer reads (up to 16.5 kbp) than other sequencing technologies (Fig. 8C) [55]. As PacBio sequencing has a very high indel rate, we focused on repeat variants that differ by indels of at least 9 bp. Switchgrass genomic DNA was sequenced on four runs of the PacBio RS system using the C2 chemistry and a ~10 kbp insert library (see methods for details). All switchgrass chromosomes stained positive for both variant B1 and B2 FISH probes and both repeat variants were present in the PacBio sequence data. However, individual PacBio sequencing reads never contained a mixture of the two variants. This shows that centromere repeat arrays in switchgrass are composed of long homogeneous arrays variants, but that these arrays are mixed together on the same chromosome.

Another benefit of PacBio sequence reads is their ability to detect HOR structure that extends beyond the dimer and trimer structures typically visible in shorter Sanger reads (Fig. 5). We found a novel pattern of HOR structure in switchgrass centromeres using PacBio sequencing: large repeating units that contain deleted versions of a canonical centromere repeat (Fig. 8D). A

2,491 bp read contained a higher order repeat comprised of 4 B1-type monomers followed by a truncated variant approximately half the size of the B1 repeat. The B1 repeat is 175 bp long, and the HOR repeat is 792 bp, too long to be detected by Sanger sequencing. Similarly, a 7,032 bp PacBio read contained a 1,131 bp HOR repeat made of 6 B1-type monomers and a truncated B1 repeat of 53 bp. In this case, the HOR repeat itself is longer than almost all Sanger sequence reads. This application shows that long reads have the benefit of directly revealing long repeat structures that could previously only be seen through painstaking and indirect assembly strategies or by chromosome-specific cytogenetic methods [11, 42, 48, 56].

Discussion

The ready availability of whole genome shotgun sequence from a wide variety of eukaryote genomes makes comparative genomics an appealing way to study rapidly-evolving tandem repeat sequences, such as those commonly associated with centromeres. Animals and plants are evolutionarily distant, so previous studies showing the presence of high-copy centromere tandem repeats in these organisms raised the question of whether this was indeed a general property. Recently, bioinformatic methods for identifying centromere tandem repeats have been described, and applied to several previously uncharacterized mammals [32, 57, 58] and plants [59]. We have performed the largest survey of animal and plant tandem repeats to date, encompassing every species with sufficient whole genome shotgun sequence in the NCBI trace archive and DDBJ sequence read archive. The bioinformatic methods we used are amenable to every available DNA sequencing technology, making our study expandable as future DNA sequences are generated. In species with previously reported centromere repeats, the most abundant tandem repeat identified in our analysis matched the published sequence in almost every case. The presence of highly abundant tandem repeats in the large majority of species that we analyzed suggests that tandem repeats likely underlie the functional centromere in most animals and plants. Candidate centromere tandem repeats did not share conserved properties such as monomer length, GC content, or common sequence motifs. We found that higher-order tandem repeat structures were prevalent across a broad phylogenetic distribution, as was the evolution of repeats by mutation and indel acquisition. This confirms theoretical predictions that the tandem repeat nature of centromere DNA in animals and in plants can facilitate the rapid evolution of these sequences [51].

As centromeres can form on non-centromeric DNA sequences in both animals and plants, the function of tandem repeats at centromeres is enigmatic [12, 13, 17, 60]. Our finding that centromere tandem repeats are common reinforces the argument that they have a functional, albeit subtle role, although careful experiments may be required to detect this *in vivo*. Further evidence for this comes from both evolutionary and functional experiments. Neocentromeres formed during evolution eventually acquire tandem repeats [61], and neocentromeres lacking tandem repeats are subtly defective in one human cell culture assay [62]. It is possible that centromere specification will be a balance between epigenetic and genetic factors in most plants and animals, although it is clear that epigenetic memory provided by the centromere-specific histone CENH3 is the most important factor.

High-copy tandem repeats have a propensity to form heterochromatin [63], but it is unlikely that this property alone explains their presence at centromeres. Transposons in pericentromeric regions are also highly heterochromatic, and there is little in the chromatin landscape of large repeat-rich genomes such as maize that distinguishes centromeres from similarly gene-poor regions. Transposons inserted into the tandem repeat arrays of cereals and other plant genomes have not been shown to have a function in centromere biology, although they are bound by CENH3 [45, 64, 65] and centromere-specific transposons localize exclusively to the centromeres of close relatives [66]. Most interestingly, the tandem repeats within the CENH3-binding domain of the centromere have significantly different chromatin modifications from typical heterochromatin [67]. In *A. thaliana* and maize, tandem repeats at the functional centromere have been observed to have lower DNA methylation than those at the edge of the repeat array [68]. Extended chromatin fiber microscopy has shown that centromeres in *Drosophila melanogaster* and humans contain some modifications typical of euchromatin (e.g. lack of H3K9 di- or trimethylation), in addition to those associated with gene silencing (hypoacetylation of H3 and H4) [67]. Tethering a transcriptional silencer to a human artificial chromosome or altering its acetylation/methylation balance can lead to centromere inactivation [69, 70]. Lastly, it is possible that non-coding RNAs may have a role in centromere function, and transcription of such molecules may not be compatible with heterochromatic marks [38, 71-73].

If specific DNA sequences play a role at centromeres, and heterochromatin is not needed for kinetochore function, why do so many animal and plant centromeres contain high-copy tandem repeats? The lack of conserved properties among these sequences suggests that it is the tandem nature of the repeats that in itself is useful. Nucleosome phasing may be beneficial for centromeres, and the sequence preferences of histones should lead to phasing on any tandem repeat even if this is a subtle property. Although one study failed to detect nucleosome phasing (translational positioning) at the maize centromere tandem repeats, periodicity based on AA/TT dimers (rotational positioning) within CentC repeats, which suggests that CentC repeats could contribute to a highly stable nucleosome arrangement in centromeres [74]. Nucleosome phasing over the entire centromere should be dominated by nucleosomes containing conventional histone H3, as CENH3 nucleosomes bind to only a small fraction of the tandem repeat array. In a phasing model, the acquisition and accumulation of tandem repeat arrays would be fostered by the chromatin arrangement of centromeres. The phenomenon of centromere reactivation, in which a centromere first loses kinetochore-nucleating activity, then regains it, could suggest that tandem repeats encourage centromeric chromatin states. Notably, centromere reactivation has been observed in both maize [75, 76] and possibly in humans [77].

Rapid evolution itself may explain the fact that centromere DNA in so many animals and plants is comprised of tandem repeats. A prevailing model to explain fast evolution of centromere DNA sequences and CENH3 is that asymmetric meiosis during oogenesis encourages centromeric drive [4, 78]. In this model, competition of centromeres for preferential segregation into the single meiotic cell that survives to become the egg can drive rapid sequence evolution. Eventually, centromere DNA and CENH3 differences could introduce reproductive barriers,

causing speciation. CENH3 binding domains in animal and plant chromosomes cover many kbps of DNA. How is it possible that these large stretches of DNA could co-evolve with a histone H3 variant? Similarly, how do centromere DNA sequences on different chromosomes co-evolve? In a tandem repeat array, CENH3 is necessarily binding to the same sequences throughout the centromere, and all chromosomes in the cell typically share versions of the same repeat monomer [79]. In addition, tandem repeats foster rapid evolution, and this property may be favored by meiotic drive [4, 51]. A mutation that arises in any copy of a tandem repeat can be amplified and spread throughout the array by unequal crossing over [51] or by replication fork collapse [80]. Repeat variants can move between different chromosomes in the cell via gene conversion, or possibly through the mobilization of retrotransposons inserted into tandem repeat arrays [81, 82]. As we have shown, the centromere tandem repeat array can be a “library” of sequence variants that show expansion and shrinkage [52, 53], creating opportunities for new variants to colonize a chromosome, likely via concerted evolution or molecular drive [83]. Centromeres with sequence differences would be immediately exposed to selection in organisms with asymmetric female meiosis. Thus, the ability of tandem repeats to facilitate concerted evolution may explain their prevalence at animal and plant centromeres. Yeast species with symmetrical meiosis lack high copy tandem repeats at centromeres [5]. Similarly, the centromere-specific histone does not show positive selection in *Tetrahymena* species with symmetrical meiosis [84]. In the future, it will be interesting to test whether tandem repeats are found at centromeres of diverse eukaryotes that lack asymmetric meiosis.

Methods

Obtaining sequence data from online archives

Only whole genome shotgun (WGS) or whole chromosome shotgun (WCS) data were used in our analysis. Sanger DNA sequences (FASTA and corresponding ancillary files) were downloaded from the NCBI Trace Archive (<http://www.ncbi.nlm.nih.gov/Traces/home/>). For each of the 170 species with WGS or WCS Sanger data, we downloaded up to 5 randomly selected FASTA files (up to 500,000 sequences/file). Illumina and 454 data were downloaded from the DDBJ Sequence Read Archive (<http://trace.ddbj.nig.ac.jp/DRASearch/>). As of April 1, 2012, 146 species had WGS Illumina or 454 data. For these species, two random FASTQ files were downloaded (one per direction, on average 2Gb/file). For 37 species both Sanger and Illumina data were obtained. A complete list of species, and associated sequence data, that were used in our study can be found in Supplementary Table S1.

Bioinformatics pipeline for Sanger and Pacific Biosciences data

WGS or WCS data were processed using a Perl-based bioinformatics pipeline. First, Sanger sequences were clipped for quality and/or vector contamination. Subsequently, sequences that had >5% Ns were removed, as were any sequences shorter than 100 bp (Sanger) or 1,000 bp (PacBio). Low complexity sequences were then masked using the DUST filter. The remaining

sequences were analyzed by Tandem Repeats Finder (TRF) (<http://tandem.bu.edu/trf/trf.html>) [49] to identify tandem repeats. We assumed that candidate centromeric tandem repeat arrays should be continuous and occupy the majority — if not all — of any individual read. We therefore excluded repeats that accounted for <80% of the entire read. TRF sometimes predicted multiple tandem repeats occupying the same span within a read (with different repeat monomer lengths). In these situations we only retained the shortest repeat for further analysis. Very short repeats, with monomer lengths <50 bp, were also excluded from further analysis.

After producing a set of tandem repeats for each species of interest (using the consensus repeat sequence from TRF), we then used WU-BLASTN [Gish] with parameters $M=1$ $N=-1$ $Q=3$ $R=3$ $W=10$ (with post-processing from various Perl scripts) to produce a set of ‘global’ and ‘local’ clusters of repeats in each species (see Supplemental Methods for full details). Global clusters contained repeats with very similar sequences that also had near-identical lengths. This clustering step used just a sample of the total number of tandem repeats produced by TRF and we identified the source reads of all of the sample repeats. This allowed us to identify what fraction of the input sample reads were represented by each global or local cluster. Repeats in the top clusters are presumed to be the candidate centromeric repeat.

Bioinformatics pipeline for Illumina and 454 data

Illumina and 454 reads are often too short to contain at least two copies of a tandem repeat. Therefore, these shorter reads have to be assembled to create contigs that contain at least two copies of a tandem repeat (even if such contigs are not biologically real). To assemble contigs containing tandem repeats, repeat monomers must be polymorphic (a property shared by all centromere tandem repeats described so far [4]). Some short read assemblers do not work well with sequences containing polymorphisms. To assemble polymorphic centromere tandem repeats, we used the short read assembler PRICE (Paired-Read Iterative Contig Extension) (<http://derisilab.ucsf.edu/software/price/index.html>). For most of the Illumina and 454 data we used PRICE beta version 0.6. This version could only handle paired-end Illumina and 454 data. The later PRICE beta version 0.13 and subsequent versions also allowed for use of single end Illumina and 454 data. For each species, we used 200,000 randomly selected reads which were assembled on 20,000 seed sequences (see PRICE manual) with at least 85% sequence similarity. The contigs were analyzed for the presence of tandem repeats by TRF, allowing for a tandem repeat monomer of 2,000 bp (upper limit of TRF). To determine genomic fraction, 1,000,000 short reads were aligned to the obtained tandem repeat monomers (see Supplementary Methods for more details).

Data analysis of centromere tandem repeats

To compare candidate centromeres from all species to each other, we performed a BLASTN [86] search. We used WU-BLAST version 2.0 with parameters $M=1$ $N=-1$ $Q=2$ $R=2$ $W=8$. Since tandem repeat boundaries are arbitrary, it is possible for related repeats to align in a staggered fashion and align over only a fraction of their true length. We therefore aligned a file of repeats

to a file of duplicated repeats. Since BLAST produces local alignments and we were interested in overall similarity, we calculated a global percent identity by adding additional alignment length assuming a 25% match rate in unaligned regions.

To assess the rate at which sequence similarity decays on phylogenetic timescales, we performed node-averaged phylogenetically independent contrasts [87, 88]. In order to account for shared history in comparisons of sequence similarity, this method calculates the average sequence similarity between each pair of taxa spanning a node to generate a single value for each node in the tree. Since the taxa of interest span a wide range of eukaryotes and our analyses are relatively insensitive to branch length estimates, we used a tree based on the NCBI taxonomy [89] and repeated our analyses on ten random resolutions of the tree in order to accommodate unresolved relationships. As most unresolved nodes were shallow, these random resolutions had little effect on the quantitative results of the analyses performed (data not shown). All phylogenetic analyses were conducted using the R package APE [90]. We then performed regression analysis in order to determine the relationship between node age (as determined with TimeTree, [91]) and node-averaged sequence similarity. We used the R package bbmle2 to fit the simple exponential model $H \sim \alpha t^\lambda$, where H is the node-averaged homology and t is node age, and α is the intercept.

To determine the conservation of several repeat characteristics on a finer scale, we performed phylogenetic comparative analysis using the R packages GEIGER (<http://cran.r-project.org/web/packages/geiger/index.html>) [92] and picante [93, 94]. We estimated Blomberg's K measure of phylogenetic conservation for repeat length, GC content, and repeat abundance using chronograms estimated for primates (<http://10ktrees.fas.harvard.edu/index.html>) and grasses [95].

Pacific Biosciences single molecule real time sequencing

Switchgrass (tetraploid *Panicum virgatum* AP13) DNA was isolated using a modified protocol for Chen and Ronald [96] (Supplementary methods). Library preparation and sequencing was performed according to manufacturer's instructions (Pacific Biosciences, Menlo Park, CA). In short, 3-10 μg of genomic DNA was isolated and fragmented to 7-10 kbp fragments using HydroShear for 15 minutes (switchgrass), or Covaris G-tube (cattle, yak, water buffalo). The first of five Ampure XP bead purifications was performed (0.45X Ampure beads added to DNA dissolved in 200 μL EB, vortexed for 10 minutes at 2,000 rpm, followed by two washes with 70% alcohol and finally diluted in EB) After each Ampure XP purification step a quality control was performed comprised of DNA concentration determination by nanodrop and fragment size distribution by bioanalyzer. Next, the DNA fragments were repaired using DNA Damage Repair solution (1X DNA Damage Repeat Buffer, 1X NAD⁺, 1 mM ATP high, 0.1 mM dNTP, and 1X DNA Damage Repeat Mix with a final volume of 85.3 μL) with a volume of 21.1 μL and incubated at 37°C for 20 minutes. DNA ends were repaired next by adding 1X End Repeat Mix to the solution, which was incubated at 25°C for 5 minutes, followed by the second Ampure XP purification step. Next, 0.75 μM of Blunt Adapter was added to the DNA, followed by 1X template Prep Buffer, 0.05 mM ATP low and 0.75 U/ μL T4 ligase to ligate (final volume of 47.5

μL) the bell adapters to the DNA fragments. This solution was incubated at 25°C for 30 minutes, followed by a 65°C 10 minute heat-shock. The exonuclease treatment to remove unligated DNA fragments consists of 1.81 U/μL Exo III and 0.18 U/μL Exo IV (final volume of 3.8 μL) which is incubated at 37°C for 1 hour. Next, three Ampure XP purifications steps were performed. Finally, the bell primer is annealed to the PacBio bell with inserted DNA fragment (80°C for 2 minute 30 followed by decreasing the temperature by 0.1°/s to 25°C). This complex was loaded into PacBio RS SMRT cells, which were loaded onto the machine for either 2 x 30, 2 x 45, 1 x 75, or 1 x 90 minute runs. Four cells each were used for *Zea mays*, *Zea luxurians*, *Panicum virgatum*, *Bos taurus taurus*, *Bos taurus indicus*, *Bos grunniens*, *Bison bison* and *Bubalus bubalis*, while two cells were sufficient for *Panicum capillare*.

Fluorescence in situ hybridization (FISH)

Mitotic chromosome spreads were generated following a protocol by Zhang and Friebe [97] with a few modifications (Supplementary methods). Plasmid vectors containing a single copy of each repeat variant (A, B1, B2, C, or D) were synthesized by Bio Basic Inc. (Ontario, Canada) and used as probes for FISH analyses. Probe hybridization signals were detected using anti-digoxigenin (dig) conjugated FITC (green), anti-dig conjugated Rhodamine (red), or Streptavidin conjugated Rhodamine (red) antibodies (Roche Applied Sciences). Chromosomes were counter-stained with 4',6-diamidino-2-phenylindole (DAPI). Digital images were recorded using an Olympus BX51 epifluorescence microscope (Olympus Corporation, Center Valley, PA) (Supplementary methods for more details).

Data Access

Pacific Biosciences sequences for *Panicum capillare* and *Panicum virgatum* were deposited in the NCBI SRA under accession number SRA052051. A list of GenBank and Sequence Read Archive accession numbers for all sequences used in this study are provided in the supplementary material. A spreadsheet containing all of the tandem repeat information for each species in this study, along with copies of all Perl scripts used are available to download online (<http://korflab.ucdavis.edu/Datasets/>).

Acknowledgments

This work would not have been possible without the guidance, vision, and boundless enthusiasm of Simon Chan who sadly passed away on August 28th, 2012 at the age of 38.

We thank René Godtel for technical assistance with bovid DNA sequencing, the International Nellore Genome Sequencing Consortium for prepublication access to sequence data, Michael Heaton for access to DNA samples of bison, yak, and water buffalo, Lauren Sagara and Henriette

O'Geen for technical assistance with Pacific Biosciences sequencing, and Felicia Tsang, Alan Raetz and Alex Han for technical assistance with bioinformatic analysis.

The U.S. Department of Agriculture, Agricultural Research Service, is an equal opportunity/affirmative action employer and all agency services are available without discrimination. Mention of commercial products and organizations in this manuscript is solely to provide specific information. It does not constitute endorsement by USDA-ARS over other products and organizations not mentioned.

This work was supported by a Joint USDA/DOE Office of Science Feedstock genomics grant DE-AI02-09ER64829 (to C.T.), and by National Science Foundation grants IOS-0922703 to J.R.-I. and IOS-1026094 to S.C. D.M. was supported by training grant T32-GM008799 from NIH-NIGMS. Its contents are solely the responsibility of the authors and do not necessarily represent the official views of the NIGMS or NIH.

J.D. is an investigator of the Howard Hughes Medical Institute. S.C. is a Howard Hughes Medical Institute and Gordon and Betty Moore Foundation investigator.

Author Contributions

D.M., K.B., N.T., J.R.-I., I.K. and S.C. designed experiments and interpreted bioinformatic results.

D.M., K.B., N.T., M.M. and I.K. performed bioinformatic analyses.

H.Y. performed FISH experiments.

G.R. and J.D. provided the PRICE short read assembler.

D.M., R.S., P.P., J.E. and D.R. performed PacBio sequencing.

J.G. contributed genome sequence data for Nellore.

T.S. contributed genome sequence data for cattle, bison, yak and water buffalo.

D.M., K.B., J.R.-I., I.K. and S.C. wrote the paper, with substantial assistance from H.Y., T.S. and C.T.

Figure Legends.

Figure 1. A bioinformatic pipeline to identify candidate centromere DNAs based on their tandem repeat nature and abundance.

A. Random shotgun sequences from a variety of platforms can be used to identify the most common tandem repeat monomer. Sanger and PacBio reads are usually long enough to contain multiple copies of a tandem repeat. Illumina and 454 reads are generally too short, and must be assembled to create longer sequences. Tandem repeat monomers were identified by Tandem Repeats Finder (TRF).

B. Identification of known centromere tandem repeats from three species. The human centromere repeat is 171 bp in length. The 728 bp monkeyflower centromere repeat is too long to be found in Sanger reads, but a PRICE assembly of Illumina reads reveals the known repeat. The 1,419 bp cattle centromere repeat and a less abundant 680 bp tandem repeat were directly identified from PacBio reads. Note that the graph for monkeyflower has no background of low abundance tandem repeats because these were not assembled by PRICE.

C. Three examples of *de novo* identification of centromere tandem repeats. Sanger WGS reads from the American pika, Hydra, and Colorado Blue Columbine revealed 253 bp, 183 bp, and 329 bp repeat monomers, respectively.

Figure 2. Centromere tandem repeat details from diverse animal and plant genomes.

The phylogenetic relationships between 282 species (204 Animalia and 78 Plantae) are shown. For each species, the figure shows tandem repeat length, GC content, and genomic fraction (log 2 scale) for the (candidate) centromere repeat monomer. Taxonomic relationships were derived from the NCBI taxonomy website. Approximately one third of the species (84 out of 282) could be clustered into 26 groups (light red bars) that exhibited sequence similarity of the tandem repeat monomer within each group. No sequence similarity was found outside these groups, or between them. The most distantly related species within a group diverged about 50 million years ago.

Figure 3. Centromere tandem repeat monomers are conserved only between closely related species.

A. Percent identity between candidate centromere repeat sequences plotted against estimated divergence time. We averaged percentage identity between comparisons to generate a single value for each node in the phylogenetic tree (Figure 2). To accommodate unresolved relationships, we repeated the analysis on random resolutions of the tree. One such analysis is shown (quantitative results were very similar between analyses).

B. For primates and grasses, the phylogenetic signal was tested using Blomberg's K analysis for three different parameters: repeat monomer length, repeat monomer GC content and genomic abundance. In primates both repeat length and GC content were more conserved than expected ($K > 1$), whereas genomic abundance was less conserved than expected by a model of Brownian evolution ($K < 1$). Though $K < 1$ for all three traits in the grasses, none were significantly different from 1. P values are shown in brackets.

Figure 4. Centromere tandem repeats lack conserved sequence properties.

No strong bias was observed in distribution of centromere repeat monomer length (A), GC content (B), or genomic fraction (C).

Figure 5. Higher order repeat structures are prevalent in diverse animals and plants.

A. Graphical representation of higher order repeat structure compared to simple monomer repeats. In the higher order repeat, two variants A and B form a single dimer repeat that is repeated in tandem. When plotting repeat monomer length by GC content by genomic fraction, two distinct peaks are seen for *Sorghum bicolor*. The second peak (2) is exactly double the length of the first peak (1).

B. Sequence alignment of repeat units from a single *Sorghum bicolor* Sanger read that exhibits a higher order repeat structure consisting of an AB dimer. The arrows point to SNPs unique for either the A or B repeat of the dimer.

C. Neighbor joining analysis showing grouping of A and B repeats from sequence alignment in B. Bootstrap numbers are shown.

D. Higher order repeat structures can lead to novel centromere repeats. In New World Monkeys, the two halves of the 343 bp monomer are weakly related to each other and to the 171 bp repeat in Old World Monkeys and Apes.

Figure 6. Evolution by indel acquisition and coexistence of repeat variants support the “library” hypothesis.

A. Candidate centromere repeat sequences of eight cichlids were analyzed for interspecies sequence similarity. The Princess cichlid *Neolamprologus brichardi* lacked centromere repeat similarity with its sister clade of Lake Malawi cichlids (shown in orange, and also including Nile tilapia).

B. Sequence alignment of candidate centromere repeats shows that Nile tilapia (*Oreochromis niloticus*) has a deletion relative to other cichlid species.

C. Candidate centromere repeat sequences of fifteen grass species were analyzed for interspecies sequence similarity. We found two groups of species with centromere repeat sequences that were similar. The closely related *Sorghum* and *Miscanthus* species have similar 137 bp repeats (blue bars). The clade shown by red bars contains *Oryza sativa* (rice), which is relatively distant from the other species that have similar centromere tandem repeats (red bars). Although the centromere repeats of *Oryza brachyantha* and *Brachypodium distachyon* have repeat monomer length similar to the orange-highlighted group, no sequence similarity was found between them. Interestingly, no sequence similarity was found between the closely related *Zea* species and *Sorghum* species or between *Oryza* species and *Brachypodium*, *Aegilops*, or *Hordeum*.

D. Sequence alignment of candidate centromere repeats from 8 grass species. Switchgrass (*Panicum virgatum*) is distinguished by the presence of a short insertion relative to the other species.

Figure 7. Chromosomal localization of repeat variants in grasses is consistent with repeat abundance measured by our bioinformatic pipeline.

Chromosomal localization of the different grass repeat variants (maize variant A, switchgrass variants B1 and B2, witchgrass variant C, and foxtail millet variant D) was determined by FISH on metaphase chromosomes of maize (*Zea mays*), switchgrass (*Panicum virgatum*), witchgrass (*Panicum capillare*), and foxtail millet (*Setaria italica*). Switchgrass variants B1 and B2 differ by a 9 bp deletion, whereas both variants differ from maize, witchgrass and foxtail millet by a 20 bp insertion. Maize and foxtail millet chromosomes hybridized only to variants A and D respectively. Only one switchgrass chromosome hybridized to variant A (arrow), but variants B1, B2 and C labeled most chromosomes (arrowheads indicate chromosomes that showed weaker hybridization to variant C). Witchgrass chromosomes were most consistently labeled by variant C, but showed chromosome-specific hybridization to variants B1 and B2, consistent with their lower abundance in the genome.

Figure 8. Pacific Biosciences sequencing shows homogeneity of repeat arrays and detects long higher order repeat structures.

A. Switchgrass variant B1 hybridized to all switchgrass chromosomes, whereas witchgrass variant C hybridized to all but three switchgrass chromosomes. The three chromosomes that only showed hybridization of variant B1 (arrows) were stained green (see merged).

B. Although both switchgrass variants B1 and B2 co-hybridize to all switchgrass chromosomes, the hybridization signal showed a chromosome specific pattern. The arrows highlight chromosomes with stronger hybridization signal for one sub-variant over the other.

C. The strength of PacBio sequencing is the extreme length of a small fraction of the reads. In the AP13 switchgrass PacBio sequencing run, the longest inserted sequence was almost 12 kbp in length, although the mean of all the PacBio reads was about 2 kbp. Sanger reads are shorter, but have a more consistent length, whereas both Illumina and 454 reads are very short and very homogeneous in length (longest reads in our study only shown).

D. Although no repeat variant mixing was detected in the PacBio reads, several high order repeat structures were found in longer PacBio reads. These HOR structures consisted of a mixture of complete and truncated repeats. Two switchgrass variant B1 centromere reads with higher order structure and one switchgrass variant B2 centromere repeat are shown. The 1131 bp HOR structure consisted of six repeat monomers and a truncated repeat (about 1/3 the size of 175 bp repeat). In total five-and-half copies of the 1131 bp repeat were found within the 7 kbp read. One variant B2-containing read is shown, containing three copies of a 886 bp HOR structure (comprised of six 166 bp repeats).

1. Stoler S, Keith KC, Curnick KE, Fitzgerald-Hayes M: **A mutation in CSE4, an essential gene encoding a novel chromatin-associated protein in yeast, causes chromosome nondisjunction and cell cycle arrest at mitosis.** *Genes Dev* 1995, **9**:573-586.
2. Shang WH, Hori T, Toyoda A, Kato J, Pependorf K, Sakakibara Y, Fujiyama A, Fukagawa T: **Chickens possess centromeres with both extended tandem repeats and short non-tandem-repetitive sequences.** *Genome Res* 2010, **20**:1219-1228.
3. Talbert PB, Bryson TD, Henikoff S: **Adaptive evolution of centromere proteins in plants and animals.** *J Biol* 2004, **3**:18.
4. Henikoff S, Ahmad K, Malik HS: **The centromere paradox: stable inheritance with rapidly evolving DNA.** *Science* 2001, **293**:1098-1102.
5. Meraldi P, McAinsh AD, Rheinbay E, Sorger PK: **Phylogenetic and structural analysis of centromeric DNA and kinetochore proteins.** *Genome Biol* 2006, **7**:R23.
6. McAinsh AD, Tytell JD, Sorger PK: **Structure, function, and regulation of budding yeast kinetochores.** *Annu Rev Cell Dev Biol* 2003, **19**:519-539.
7. Birchler JA, Gao Z, Han F: **A tale of two centromeres--diversity of structure but conservation of function in plants and animals.** *Funct Integr Genomics* 2009, **9**:7-13.
8. Wang G, Zhang X, Jin W: **An overview of plant centromeres.** *J Genet Genomics* 2009, **36**:529-537.
9. Willard HF: **Centromeres of mammalian chromosomes.** *Trends Genet* 1990, **6**:410-416.
10. Waye JS, Durfy SJ, Pinkel D, Kenwrick S, Patterson M, Davies KE, Willard HF: **Chromosome-specific alpha satellite DNA from human chromosome 1: hierarchical structure and genomic organization of a polymorphic domain spanning several hundred kilobase pairs of centromeric DNA.** *Genomics* 1987, **1**:43-51.
11. Rudd MK, Wray GA, Willard HF: **The evolutionary dynamics of alpha-satellite.** *Genome Res* 2006, **16**:88-96.
12. Amor DJ, Choo KH: **Neocentromeres: role in human disease, evolution, and centromere study.** *Am J Hum Genet* 2002, **71**:695-714.
13. Nasuda S, Hudakova S, Schubert I, Houben A, Endo TR: **Stable barley chromosomes without centromeric repeats.** *Proc Natl Acad Sci U S A* 2005, **102**:9842-9847.
14. Lam AL, Boivin CD, Bonney CF, Rudd MK, Sullivan BA: **Human centromeric chromatin is a dynamic chromosomal domain that can spread over noncentromeric DNA.** *Proc Natl Acad Sci U S A* 2006, **103**:4186-4191.
15. Wade CM, Giulotto E, Sigurdsson S, Zoli M, Gnerre S, Imsland F, Lear TL, Adelson DL, Bailey E, Bellone RR, Blocker H, Distl O, Edgar RC, Garber M, Leeb T, Mauceli E, MacLeod JN, Penedo MC, Raison JM, Sharpe T, Vogel J, Andersson L, Antczak DF, Biagi T, Binns MM, Chowdhary BP, Coleman SJ, Della Valle G, Fryc S, Guerin G, Hasegawa T, Hill EW, Jurka J, Kiiialainen A, Lindgren G, Liu J, Magnani E, Mickelson JR, Murray J, Nergadze SG, Onofrio R, Pedroni S, Piras MF, Raudsepp T, Rocchi M, Roed KH, Ryder OA, Searle S, Skow L, Swinburne JE, Syvanen AC, Tozaki T, Valberg SJ, Vaudin M, White JR, Zody MC, Lander ES, Lindblad-Toh K: **Genome sequence, comparative analysis, and population genetics of the domestic horse.** *Science* 2009, **326**:865-867.

16. Locke DP, Hillier LW, Warren WC, Worley KC, Nazareth LV, Muzny DM, Yang SP, Wang Z, Chinwalla AT, Minx P, Mitreva M, Cook L, Delehaunty KD, Fronick C, Schmidt H, Fulton LA, Fulton RS, Nelson JO, Magrini V, Pohl C, Graves TA, Markovic C, Cree A, Dinh HH, Hume J, Kovar CL, Fowler GR, Lunter G, Meader S, Heger A, Ponting CP, Marques-Bonet T, Alkan C, Chen L, Cheng Z, Kidd JM, Eichler EE, White S, Searle S, Vilella AJ, Chen Y, Flicek P, Ma J, Raney B, Suh B, Burhans R, Herrero J, Haussler D, Faria R, Fernando O, Darré F, Farré D, Gazave E, Oliva M, Navarro A, Roberto R, Capozzi O, Archidiacono N, Della Valle G, Purgato S, Rocchi M, Konkel MK, Walker JA, Ullmer B, Batzer MA, Smit AF, Hubley R, Casola C, Schrider DR, Hahn MW, Quesada V, Puente XS, Ordoñez GR, López-Otín C, Vinar T, Brejova B, Ratan A, Harris RS, Miller W, Kosiol C, Lawson HA, Taliwal V, Martins AL, Siepel A, Roychoudhury A, Ma X, Degenhardt J, Bustamante CD, Gutenkunst RN, Mailund T, Dutheil JY, Hobolth A, Schierup MH, Ryder OA, Yoshinaga Y, de Jong PJ, Weinstock GM, Rogers J, Mardis ER, Gibbs RA, Wilson RK: **Comparative and demographic analysis of orang-utan genomes.** *Nature* 2011, **469**:529-533.
17. Marshall OJ, Chueh AC, Wong LH, Choo KH: **Neocentromeres: new insights into centromere structure, disease development, and karyotype evolution.** *Am J Hum Genet* 2008, **82**:261-282.
18. Neumann P, Navrátilová A, Schroeder-Reiter E, Koblížková A, Steinbauerová V, Chocholová E, Novák P, Wanner G, Macas J: **Stretching the rules: monocentric chromosomes with multiple centromere domains.** *PLoS Genet* 2012, **8**:e1002777.
19. Gong Z, Wu Y, Koblížková A, Torres GA, Wang K, Iovene M, Neumann P, Zhang W, Novák P, Buell CR, Macas J, Jiang J: **Repeatless and Repeat-Based Centromeres in Potato: Implications for Centromere Evolution.** *Plant Cell* 2012, .
20. Dernburg AF: **Here, there, and everywhere: kinetochore function on holocentric chromosomes.** *J Cell Biol* 2001, **153**:F33-F38.
21. Gassmann R, Rechtsteiner A, Yuen KW, Muroyama A, Egelhofer T, Gaydos L, Barron F, Maddox P, Essex A, Monen J, Ercan S, Lieb JD, Oegema K, Strome S, Desai A: **An inverse relationship to germline transcription defines centromeric chromatin in *C. elegans*.** *Nature* 2012, .
22. Elder JF, Turner BJ: **Concerted evolution at the population level: pupfish HindIII satellite DNA sequences.** *Proc Natl Acad Sci U S A* 1994, **91**:994-998.
23. Palomeque T, Lorite P: **Satellite DNA in insects: a review.** *Heredity (Edinb)* 2008, **100**:564-573.
24. Masumoto H, Nakano M, Ohzeki J: **The role of CENP-B and alpha-satellite DNA: de novo assembly and epigenetic maintenance of human centromeres.** *Chromosome Res* 2004, **12**:543-556.
25. Bensasson D, Zarowiecki M, Burt A, Koufopanou V: **Rapid evolution of yeast centromeres in the absence of drive.** *Genetics* 2008, **178**:2161-2167.
26. Bensasson D: **Evidence for a high mutation rate at rapidly evolving yeast centromeres.** *BMC Evol Biol* 2011, **11**:211.
27. Plohl M, Luchetti A, Mestrovic N, Mantovani B: **Satellite DNAs between selfishness and functionality: structure, genomics and evolution of tandem repeats in centromeric (hetero)chromatin.** *Gene* 2008, **409**:72-82.

28. Gaillard C, Doly J, Cortadas J, Bernardi G: **The primary structure of bovine satellite 1.715.** *Nucleic Acids Res* 1981, **9**:6069-6082.
29. Płucienniczak A, Skowroński J, Jaworski J: **Nucleotide sequence of bovine 1.715 satellite DNA and its relation to other bovine satellite sequences.** *J Mol Biol* 1982, **158**:293-304.
30. Taparowsky EJ, Gerbi SA: **Structure of 1.71 lb gm/cm(3) bovine satellite DNA: evolutionary relationship to satellite I.** *Nucleic Acids Res* 1982, **10**:5503-5515.
31. Fishman L, Saunders A: **Centromere-associated female meiotic drive entails male fitness costs in monkeyflowers.** *Science* 2008, **322**:1559-1562.
32. Alkan C, Cardone MF, Catacchio CR, Antonacci F, O'Brien SJ, Ryder OA, Purgato S, Zoli M, Della Valle G, Eichler EE, Ventura M: **Genome-wide characterization of centromeric satellites from multiple mammalian genomes.** *Genome Res* 2011, **21**:137-145.
33. Zimin AV, Delcher AL, Florea L, Kelley DR, Schatz MC, Puiu D, Hanrahan F, Pertea G, Van Tassell CP, Sonstegard TS, Marçais G, Roberts M, Subramanian P, Yorke JA, Salzberg SL: **A whole-genome assembly of the domestic cow, *Bos taurus*.** *Genome Biol* 2009, **10**:R42.
34. Schnable PS, Ware D, Fulton RS, Stein JC, Wei F, Pasternak S, Liang C, Zhang J, Fulton L, Graves TA, Minx P, Reily AD, Courtney L, Kruchowski SS, Tomlinson C, Strong C, Delehaunty K, Fronick C, Courtney B, Rock SM, Belter E, Du F, Kim K, Abbott RM, Cotton M, Levy A, Marchetto P, Ochoa K, Jackson SM, Gillam B, Chen W, Yan L, Higginbotham J, Cardenas M, Waligorski J, Applebaum E, Phelps L, Falcone J, Kanchi K, Thane T, Scimone A, Thane N, Henke J, Wang T, Ruppert J, Shah N, Rotter K, Hodges J, Ingenthron E, Cordes M, Kohlberg S, Sgro J, Delgado B, Mead K, Chinwalla A, Leonard S, Crouse K, Collura K, Kudrna D, Currie J, He R, Angelova A, Rajasekar S, Mueller T, Lomeli R, Scara G, Ko A, Delaney K, Wissotski M, Lopez G, Campos D, Braidotti M, Ashley E, Golser W, Kim H, Lee S, Lin J, Dujmic Z, Kim W, Talag J, Zuccolo A, Fan C, Sebastian A, Kramer M, Spiegel L, Nascimento L, Zutavern T, Miller B, Ambroise C, Muller S, Spooner W, Narechania A, Ren L, Wei S, Kumari S, Faga B, Levy MJ, McMahan L, Van Buren P, Vaughn MW, Ying K, Yeh CT, Emrich SJ, Jia Y, Kalyanaraman A, Hsia AP, Barbazuk WB, Baucom RS, Brutnell TP, Carpita NC, Chaparro C, Chia JM, Deragon JM, Estill JC, Fu Y, Jeddelloh JA, Han Y, Lee H, Li P, Lisch DR, Liu S, Liu Z, Nagel DH, McCann MC, SanMiguel P, Myers AM, Nettleton D, Nguyen J, Penning BW, Ponnala L, Schneider KL, Schwartz DC, Sharma A, Soderlund C, Springer NM, Sun Q, Wang H, Waterman M, Westerman R, Wolfgruber TK, Yang L, Yu Y, Zhang L, Zhou S, Zhu Q, Bennetzen JL, Dawe RK, Jiang J, Jiang N, Presting GG, Wessler SR, Aluru S, Martienssen RA, Clifton SW, McCombie WR, Wing RA, Wilson RK: **The B73 maize genome: complexity, diversity, and dynamics.** *Science* 2009, **326**:1112-1115.
35. Ananiev EV, Phillips RL, Rines HW: **Complex structure of knobs and centromeric regions in maize chromosomes.** *Tsitol Genet* 2000, **34**:11-15.
36. Dawe RK, Bennetzen JL, Hake S: **Maize Centromeres and Knobs (neocentromeres) Handbook of Maize.** In Springer New York; 2009:239-250.
37. Chia JM, Song C, Bradbury P, Costich D, de Leon N, Doebley JC, Elshire RJ, Gaunt BS, Geller L, Glaubitz JC, Gore M, Guill KE, Holland J, Hufford MB, Lai J, Liu X, Lu Y, McCombie R, Nelson R, Poland J, Prasanna BM, Pyhäjärvi T, Rong T, Shekhon RS, Sun Q, Tenailon M, Tian F, Wang J, Xu X, Zhang Z, Kaeppler S, Ross-Ibarra J, McMullen M, Buckler

- ES, Zhang G, Xu Y, Ware D: **Capturing extant variation from a genome in flux: maize HapMap II.** *Nat Genet* :in press.
38. Carone DM, Longo MS, Ferreri GC, Hall L, Harris M, Shook N, Bulazel KV, Carone BR, Obergfell C, O'Neill MJ, O'Neill RJ: **A new class of retroviral and satellite encoded small RNAs emanates from mammalian centromeres.** *Chromosoma* 2009, **118**:113-125.
39. Hosouchi T, Kumekawa N, Tsuruoka H, Kotani H: **Physical map-based sizes of the centromeric regions of Arabidopsis thaliana chromosomes 1, 2, and 3.** *DNA Res* 2002, **9**:117-121.
40. Lee HR, Zhang W, Langdon T, Jin W, Yan H, Cheng Z, Jiang J: **Chromatin immunoprecipitation cloning reveals rapid evolutionary patterns of centromeric DNA in Oryza species.** *Proc Natl Acad Sci U S A* 2005, **102**:11793-11798.
41. Horvath JE, Willard HF: **Primate comparative genomics: lemur biology and evolution.** *Trends Genet* 2007, **23**:173-182.
42. Lee HR, Hayden KE, Willard HF: **Organization and molecular evolution of CENP-A--associated satellite DNA families in a basal primate genome.** *Genome Biol Evol* 2011, **3**:1136-1149.
43. Shelby RD, Vafa O, Sullivan KF: **Assembly of CENP-A into centromeric chromatin requires a cooperative array of nucleosomal DNA contact sites.** *J Cell Biol* 1997, **136**:501-513.
44. Gill N, Findley S, Walling JG, Hans C, Ma J, Doyle J, Stacey G, Jackson SA: **Molecular and chromosomal evidence for allopolyploidy in soybean.** *Plant Physiol* 2009, **151**:1167-1174.
45. Tek AL, Kashihara K, Murata M, Nagaki K: **Functional centromeres in soybean include two distinct tandem repeats and a retrotransposon.** *Chromosome Res* 2010, **18**:337-347.
46. Blomberg SP, Garland T, Ives AR: **Testing for phylogenetic signal in comparative data: behavioral traits are more labile.** *Evolution* 2003, **57**:717-745.
47. Melters DP, Paliulis L, Korf IF, Chan SW: **Holocentric Chromosomes: Convergent Evolution, Meiotic Adaptations and Genomic Analysis.** *Chromosome Research* 2012, .
48. Warburton PE, Wayne JS, Willard HF: **Nonrandom localization of recombination events in human alpha satellite repeat unit variants: implications for higher-order structural characteristics within centromeric heterochromatin.** *Mol Cell Biol* 1993, **13**:6520-6529.
49. Benson G: **Tandem repeats finder: a program to analyze DNA sequences.** *Nucleic Acids Res* 1999, **27**:573-580.
50. Cellamare A, Catacchio CR, Alkan C, Giannuzzi G, Antonacci F, Cardone MF, Della Valle G, Malig M, Rocchi M, Eichler EE, Ventura M: **New insights into centromere organization and evolution from the white-cheeked gibbon and marmoset.** *Mol Biol Evol* 2009, **26**:1889-1900.
51. Smith GP: **Evolution of repeated DNA sequences by unequal crossover.** *Science* 1976, **191**:528-535.
52. Ma J, Jackson SA: **Retrotransposon accumulation and satellite amplification mediated by segmental duplication facilitate centromere expansion in rice.** *Genome Res* 2006, **16**:251-259.
53. Ma J, Bennetzen JL: **Recombination, rearrangement, reshuffling, and divergence in a centromeric region of rice.** *Proc Natl Acad Sci U S A* 2006, **103**:383-388.

54. Hemleben V, Kovarik A, Torres-Ruiz RA, Volkov RA, Beridze T: **Plant highly repeated satellite DNA: molecular evolution, distribution and use for identification of hybrids.** *Systematics and Biodiversity* 2007, **5**:277-289.
55. Schadt EE, Turner S, Kasarskis A: **A window into third-generation sequencing.** *Hum Mol Genet* 2010, **19**:R227-R240.
56. Warburton PE, Haaf T, Gosden J, Lawson D, Willard HF: **Characterization of a chromosome-specific chimpanzee alpha satellite subset: evolutionary relationship to subsets on human chromosomes.** *Genomics* 1996, **33**:220-228.
57. Swaminathan K, Varala K, Hudson M: **Global repeat discovery and estimation of genomic copy number in a large, complex genome using a high-throughput 454 sequence survey.** *BMC Genomics* 2007, **8**:132.
58. Hayden K, Willard H: **Composition and organization of active centromere sequences in complex genomes.** *BMC Genomics* 2012, **13**:324.
59. Navajas-Pérez R, Paterson AH: **Patterns of tandem repetition in plant whole genome assemblies.** *Mol Genet Genomics* 2009, **281**:579-590.
60. Nagaki K, Cheng Z, Ouyang S, Talbert PB, Kim M, Jones KM, Henikoff S, Buell CR, Jiang J: **Sequencing of a rice centromere uncovers active genes.** *Nat Genet* 2004, **36**:138-145.
61. Ventura M, Antonacci F, Cardone MF, Stanyon R, D'Addabbo P, Cellamare A, Sprague LJ, Eichler EE, Archidiacono N, Rocchi M: **Evolutionary formation of new centromeres in macaque.** *Science* 2007, **316**:243-246.
62. Bassett EA, Wood S, Salimian KJ, Ajith S, Foltz DR, Black BE: **Epigenetic centromere specification directs aurora B accumulation but is insufficient to efficiently correct mitotic errors.** *J Cell Biol* 2010, **190**:177-185.
63. Pikaard C, Pontes O: **Heterochromatin: condense or excise.** *Nat Cell Biol* 2007, **9**:19-20.
64. Zhong CX, Marshall JB, Topp C, Mroczek R, Kato A, Nagaki K, Birchler JA, Jiang J, Dawe RK: **Centromeric retroelements and satellites interact with maize kinetochore protein CENH3.** *Plant Cell* 2002, **14**:2825-2836.
65. Houben A, Schroeder-Reiter E, Nagaki K, Nasuda S, Wanner G, Murata M, Endo TR: **CENH3 interacts with the centromeric retrotransposon cereba and GC-rich satellites and locates to centromeric substructures in barley.** *Chromosoma* 2007, **116**:275-283.
66. Tsukahara S, Kawabe A, Kobayashi A, Ito T, Aizu T, Shin-I T, Toyoda A, Fujiyama A, Tarutani Y, Kakutani T: **Centromere-targeted de novo integrations of an LTR retrotransposon of Arabidopsis lyrata.** *Genes Dev* 2012, **26**:705-713.
67. Sullivan BA, Karpen GH: **Centromeric chromatin exhibits a histone modification pattern that is distinct from both euchromatin and heterochromatin.** *Nat Struct Mol Biol* 2004, **11**:1076-1083.
68. Zhang W, Lee H-R, Koo D-H, Jiang J: **Epigenetic Modification of Centromeric Chromatin: Hypomethylation of DNA Sequences in the CENH3-Associated Chromatin in Arabidopsis thaliana and Maize.** *The Plant Cell Online* 2008, **20**:25-34.
69. Nakano M, Cardinale S, Noskov VN, Gassmann R, Vagnarelli P, Kandels-Lewis S, Larionov V, Earnshaw WC, Masumoto H: **Inactivation of a human kinetochore by specific targeting of chromatin modifiers.** *Dev Cell* 2008, **14**:507-522.

70. Ohzeki JI, Bergmann JH, Kouprina N, Noskov VN, Nakano M, Kimura H, Earnshaw WC, Larionov V, Masumoto H: **Breaking the HAC Barrier: Histone H3K9 acetyl/methyl balance regulates CENP-A assembly.** *EMBO J* 2012, .
71. Topp CN, Zhong CX, Dawe RK: **Centromere-encoded RNAs are integral components of the maize kinetochore.** *Proc Natl Acad Sci U S A* 2004, **101**:15986-15991.
72. O'Neill RJ, Carone DM: **The role of ncRNA in centromeres: a lesson from marsupials.** *Prog Mol Subcell Biol* 2009, **48**:77-101.
73. Du Y, Topp CN, Dawe RK: **DNA binding of centromere protein C (CENPC) is stabilized by single-stranded RNA.** *PLoS Genet* 2010, **6**:e1000835.
74. Gent JI, Schneider KL, Topp CN, Rodriguez C, Presting GG, Dawe RK: **Distinct influences of tandem repeats and retrotransposons on CENH3 nucleosome positioning.** *Epigenetics Chromatin* 2011, **4**:3.
75. Han F, Gao Z, Birchler JA: **Reactivation of an inactive centromere reveals epigenetic and structural components for centromere specification in maize.** *Plant Cell* 2009, **21**:1929-1939.
76. Sato H, Masuda F, Takayama Y, Takahashi K, Saitoh S: **Epigenetic inactivation and subsequent heterochromatinization of a centromere stabilize dicentric chromosomes.** *Curr Biol* 2012, **22**:658-667.
77. Mackinnon RN, Campbell LJ: **The role of dicentric chromosome formation and secondary centromere deletion in the evolution of myeloid malignancy.** *Genet Res Int* 2011, **2011**:643628.
78. Malik HS, Henikoff S: **Major evolutionary transitions in centromere complexity.** *Cell* 2009, **138**:1067-1082.
79. Kawabe A, Charlesworth D: **Patterns of DNA variation among three centromere satellite families in *Arabidopsis halleri* and *A. lyrata*.** *J Mol Evol* 2007, **64**:237-247.
80. Houseley J, Tollervey D: **Repeat expansion in the budding yeast ribosomal DNA can occur independently of the canonical homologous recombination machinery.** *Nucleic Acids Res* 2011, **39**:8778-8791.
81. Shi J, Wolf SE, Burke JM, Presting GG, Ross-Ibarra J, Dawe RK: **Widespread gene conversion in centromere cores.** *PLoS Biol* 2010, **8**:e1000327.
82. Birchler JA, Presting GG: **Retrotransposon insertion targeting: a mechanism for homogenization of centromere sequences on nonhomologous chromosomes.** *Genes Dev* 2012, **26**:638-640.
83. Dover G: **Molecular drive: a cohesive mode of species evolution.** *Nature* 1982, **299**:111-117.
84. Elde NC, Roach KC, Yao MC, Malik HS: **Absence of positive selection on centromeric histones in *Tetrahymena* suggests unsuppressed centromere: drive in lineages lacking male meiosis.** *J Mol Evol* 2011, **72**:510-520.
- [NO STYLE for: Gish].
86. Altschul SF, Gish W, Miller W, Myers EW, Lipman DJ: **Basic local alignment search tool.** *J Mol Biol* 1990, **215**:403-410.
87. Coyne JA, Orr HA: **Patterns of speciation in *Drosophila*.** *Evolution* 1989, :362-381.
88. Fitzpatrick BM: **Molecular correlates of reproductive isolation.** *Evolution* 2002, **56**:191-198.

89. Sayers EW, Barrett T, Benson DA, Bolton E, Bryant SH, Canese K, Chetvernin V, Church DM, Dicuccio M, Federhen S, Feolo M, Fingerman IM, Geer LY, Helmberg W, Kapustin Y, Krasnov S, Landsman D, Lipman DJ, Lu Z, Madden TL, Madej T, Maglott DR, Marchler-Bauer A, Miller V, Karsch-Mizrachi I, Ostell J, Panchenko A, Phan L, Pruitt KD, Schuler GD, Sequeira E, Sherry ST, Shumway M, Sirotkin K, Slotta D, Souvorov A, Starchenko G, Tatusova TA, Wagner L, Wang Y, Wilbur WJ, Yaschenko E, Ye J: **Database resources of the National Center for Biotechnology Information.** *Nucleic Acids Res* 2012, **40**:D13-D25.
90. Paradis E, Claude J, Strimmer K: **APE: Analyses of Phylogenetics and Evolution in R language.** *Bioinformatics* 2004, **20**:289-290.
91. Hedges SB, Dudley J, Kumar S: **TimeTree: a public knowledge-base of divergence times among organisms.** *Bioinformatics* 2006, **22**:2971-2972.
92. Harmon LJ, Weir JT, Brock CD, Glor RE, Challenger W: **GEIGER: investigating evolutionary radiations.** *Bioinformatics* 2008, **24**:129-131.
93. Kembel SW, Cowan PD, Helmus MR, Cornwell WK, Morlon H, Ackerly DD, Blomberg SP, Webb CO: **Picante: R tools for integrating phylogenies and ecology.** *Bioinformatics* 2010, **26**:1463-1464.
94. Popescu AA, Huber KT, Paradis E: **ape 3.0: new tools for distance based phylogenetics and evolutionary analysis in R.** *Bioinformatics* 2012, .
95. Bouchenak-Khelladi Y, Verboom GA, Savolainen V, Hodkinson TR: **Biogeography of the grasses (Poaceae): a phylogenetic approach to reveal evolutionary history in geographical space and geological time.** *Botanical Journal of the Linnean Society* 2010, **162**:543-557.
96. Chen D-, Ronald PC: **A Rapid DNA Minipreparation Method Suitable for AFLP and Other PCR Applications.** *Plant Molecular Biology Reporter* 1999, **17**:53-57.
97. Zhang W, Friebe B, Gill BS, Jiang J: **Centromere inactivation and epigenetic modifications of a plant chromosome with three functional centromeres.** *Chromosoma* 2010, **119**:553-563.

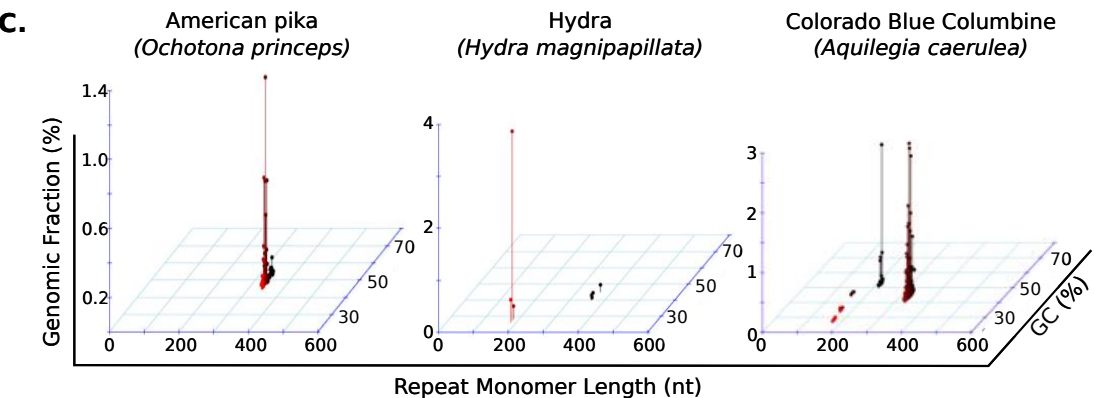
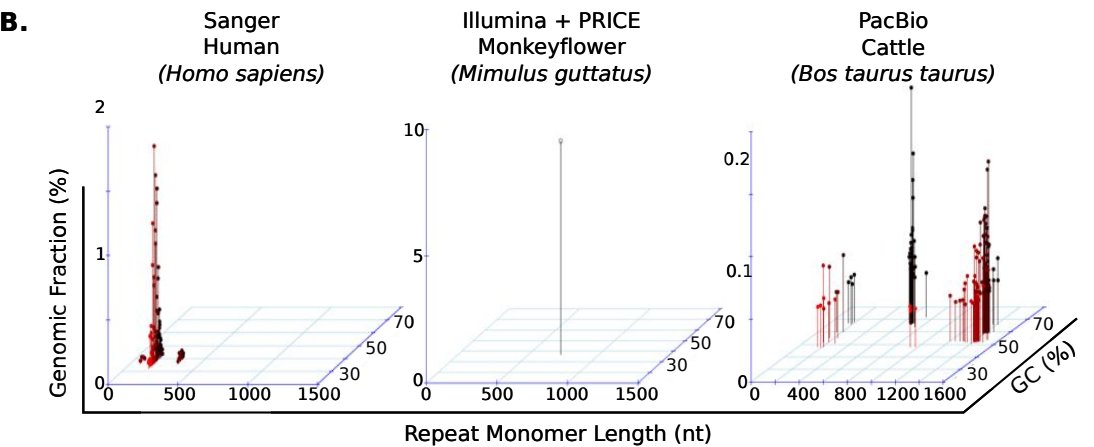
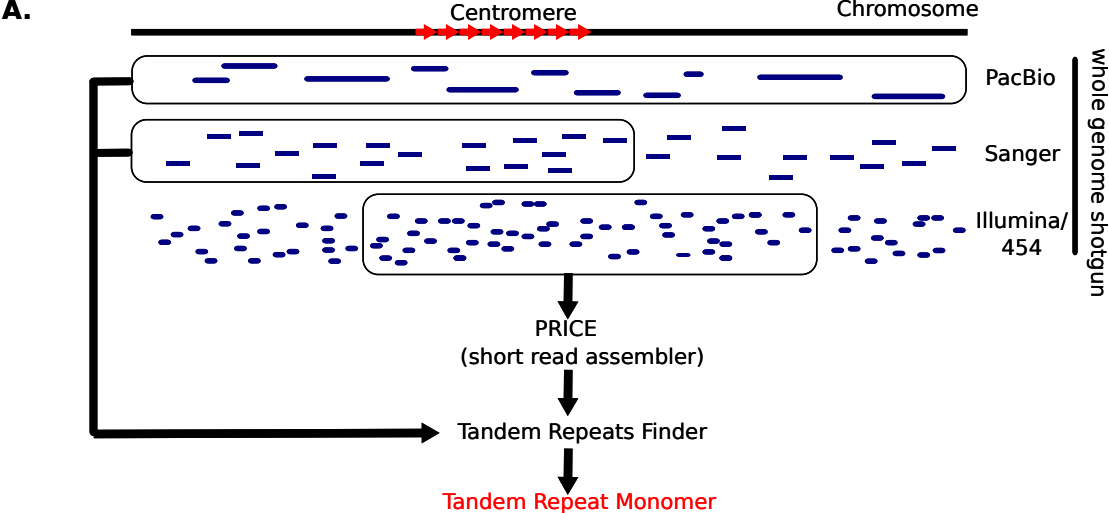

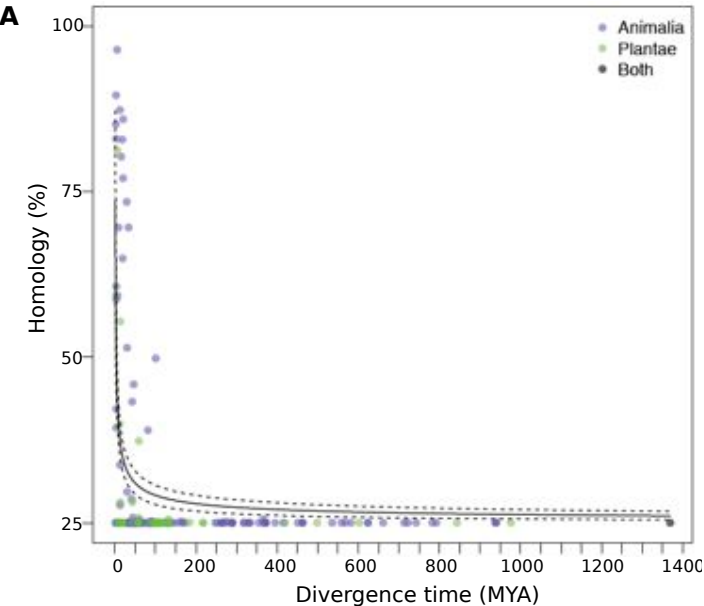

B

Blomberg's K	Monomer length	GC content	Genomic fraction
Primates	1.852265 ($p = 0.001$)	1.615503 ($p = 0.001$)	0.7551643 ($p = 0.004$)
Grasses	0.414999 ($p = 0.427$)	0.6775028 ($p = 0.158$)	0.361093 ($p = 0.645$)

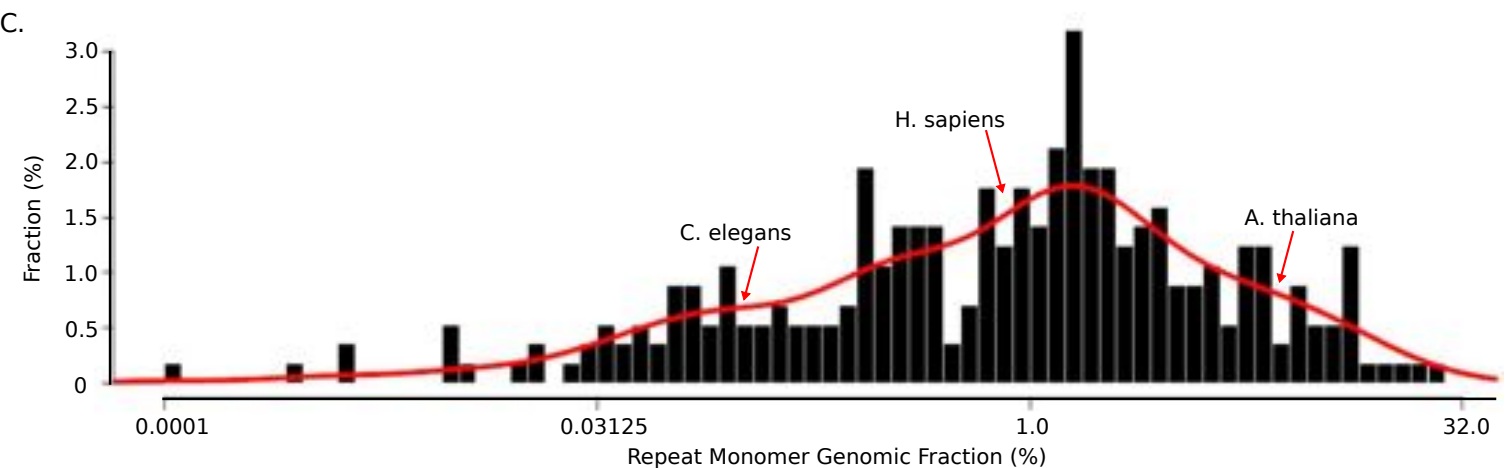
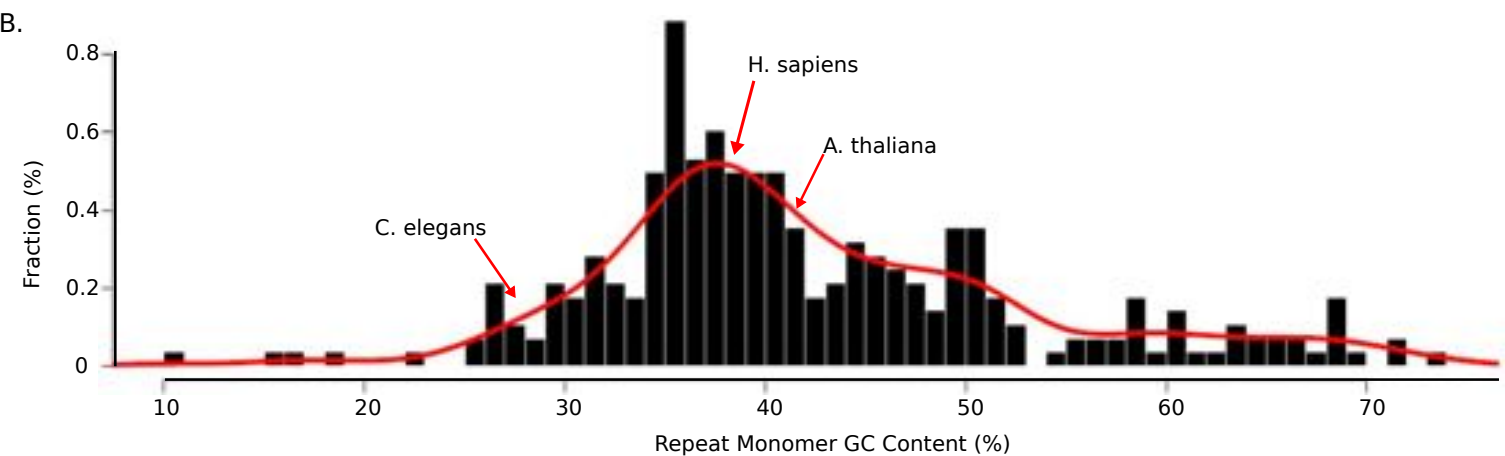
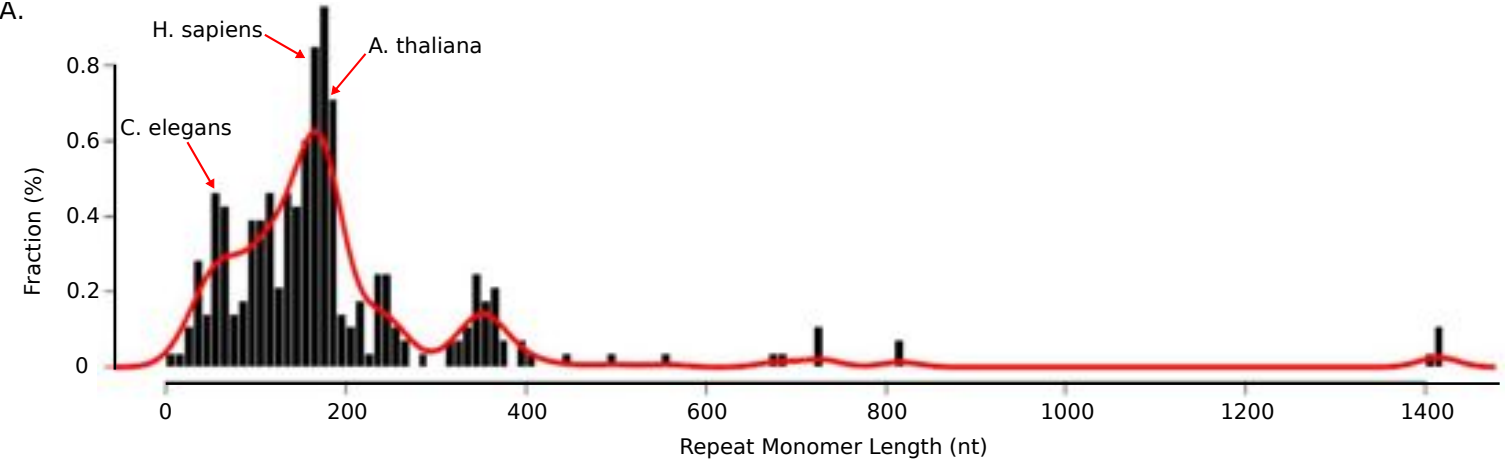

A.

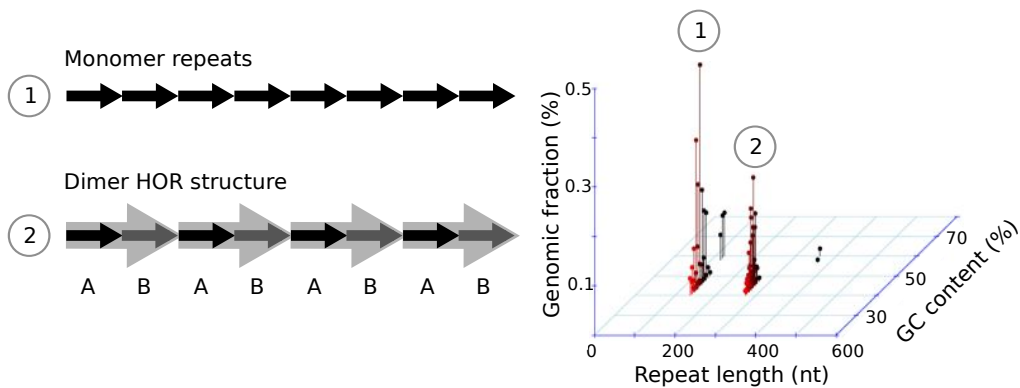

B.

Sorghum bicolor dimer HOR

```

A1 ACCNTAGGAGTTACAAATAGTGC-CGTCCAAAATGGTT-TCTTACACTAT 47
B1 ATCT-AGGAG-TCCATTGGGTG-CGTCCAAAATGATT-TCTAAGCATAT 45
A2 ACC---GAAGTACCACACAGGTG-CCTCAAAATGGTT-TCTTAGACTAT 44
B2 ATTA-AGGAGTTCACCTCTGGTG-CATCCAAAGTTGATT-TCCAAGCATAT 46
A3 ACCT-AGGAGTACCACACAGGTG-CCTCAAAATGGTT-TCTTAGACTTT 46
B3 ATCA-AGGAGTTCTATCGAGTA-TGTCCAAAATTAATT-TCTAAGCATAT 46
A4 ACCT-AGGAGTACCATCGGGTG-CGTCCAAAATGGTT-TCTTAGCCTAT 46
B4 -TCT-AGGAGTTCCTCGTGTG-CGTCCAGATT-GTCTTCCAAAGGCTT 45
A5 GCCT-AGGAGTGCACACGGGTGGCGTCCCGAACAGTCGCTCGA--TCAT 46

      ↓      ↓      ↓      ↓      ↓      ↓      ↓      ↓
A1 GGTGCA--TT-TGGTGTAAACTG-TGCACCTATCTTGA-ACT-ACAAC 90
B1 GGTATG--TT-CCTTGCAAAATCA-TGCACCTATCTTGC-ATC-AAGATT 88
A2 GGTGCA--TT-AGGCGCAAAACA-TGCACATATCTTGC-ACC-GAAACT 87
B2 GGTATG--TT-CCATGCAAAACCG-TGCACCTATCTTGC-ATC-AAGATT 89
A3 GGTGCA--TT-AGGCGCAAAACCG-TGCACCTATCTTGC-ACC-GAAACT 89
B3 GGTACG--TT-CCATGCAAGCCA-TGGGCTATGTTGGCCATC-AAGATT 90
A4 GCTGCA--TT-ATGTGCAAAACCT-TGCACCTATCTTGC-ACCTGAAACT 90
B4 GGGGCTGGTCCCTTGCCGATCG-TGCCTCAGCTGGCTCC-GGGATT 92
A5 GGGGCT--TT-TGGTGC-AATCGGTGCTTT---TTTGGC-C-GGGA-GT 79

      ↓      ↓      ↓      ↓      ↓      ↓      ↓      ↓
A1 TACAATGTCTACAACACGGACCGAAGCAAGATTCOCATATGRCACAGTTC- 138
B1 AGCACTATCTCCAAAACCGATCCAAACCGAGCTTCCCTTTGAGCCCTCTTC- 136
A2 AACACCGTTCCTAAATAGACCAAAAGCGGAGATTCACATATACACATGTC- 135
B2 AGCACTATCTCTAAACAGACCTAACCCGAGCCCTCCACTTGAGCCCTTC- 137
A3 AATACTGTCTCTAAGAACACCAAAAGCGAGATTCACATATGACACACGTC- 137
B3 AGCACTATCTCCAAATAGACCAAAACCGAGCTTTCACCTGAGCCCTTT- 137
A4 AACACTGTCTCCAAACAGACTGAAGCAAGATTTTCGATGACACACGTTTC 139
B4 GGTGCTTCTCCACCCGATCGAACCAGAGCTCCCNITTTAGCCTTT--- 139
A5 TCAT-GTTTCCGAT--GGTCGAG-GTGATTCTCTTTT-ACCCTTC--- 126
    
```

C.

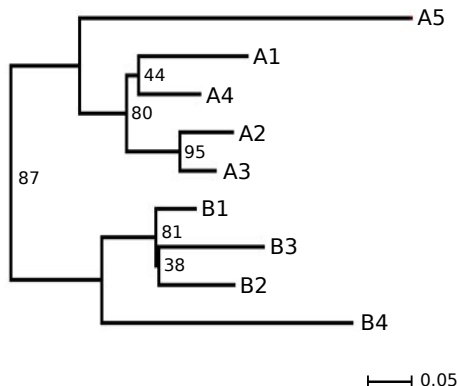

D.

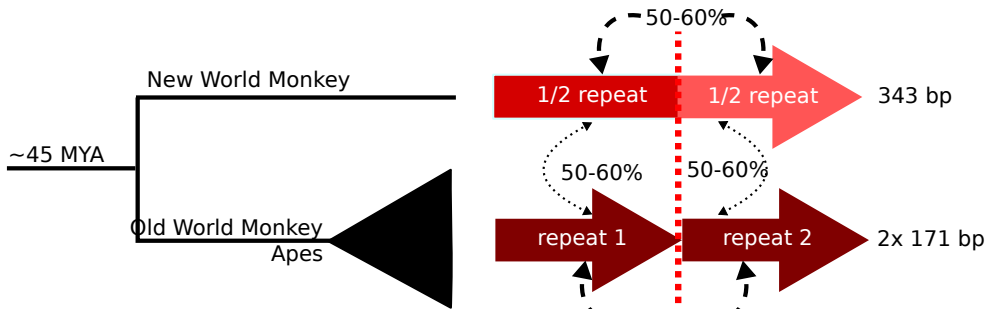

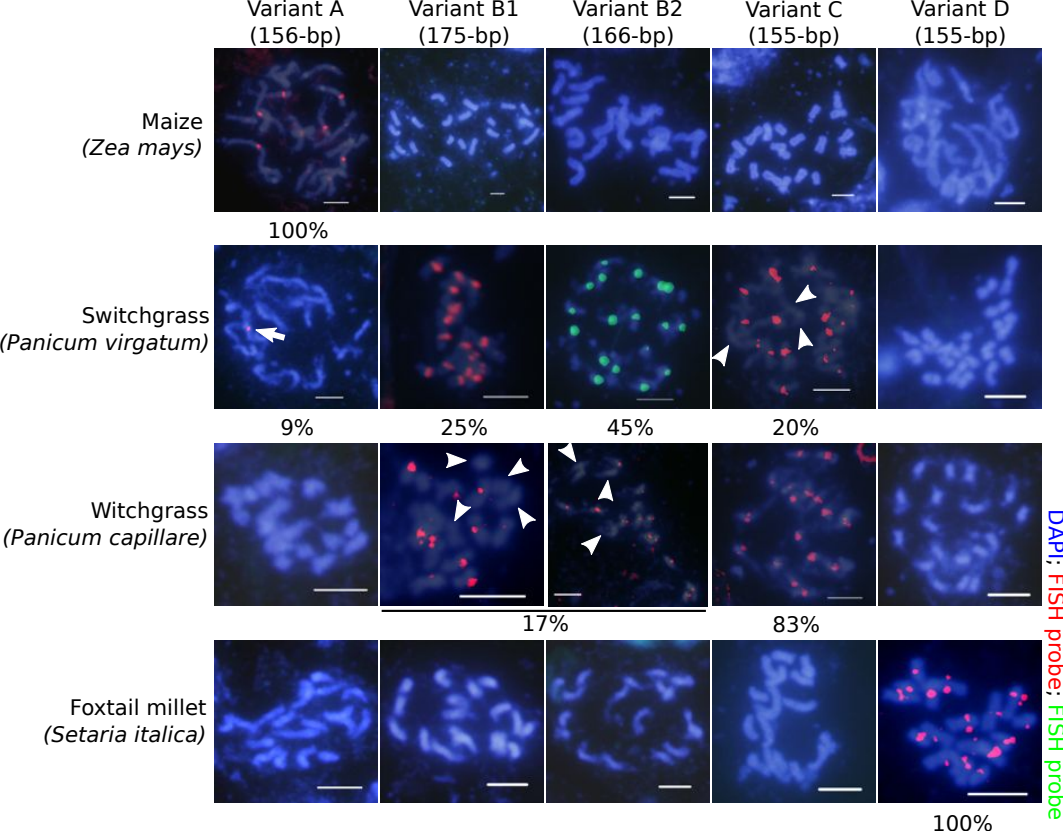

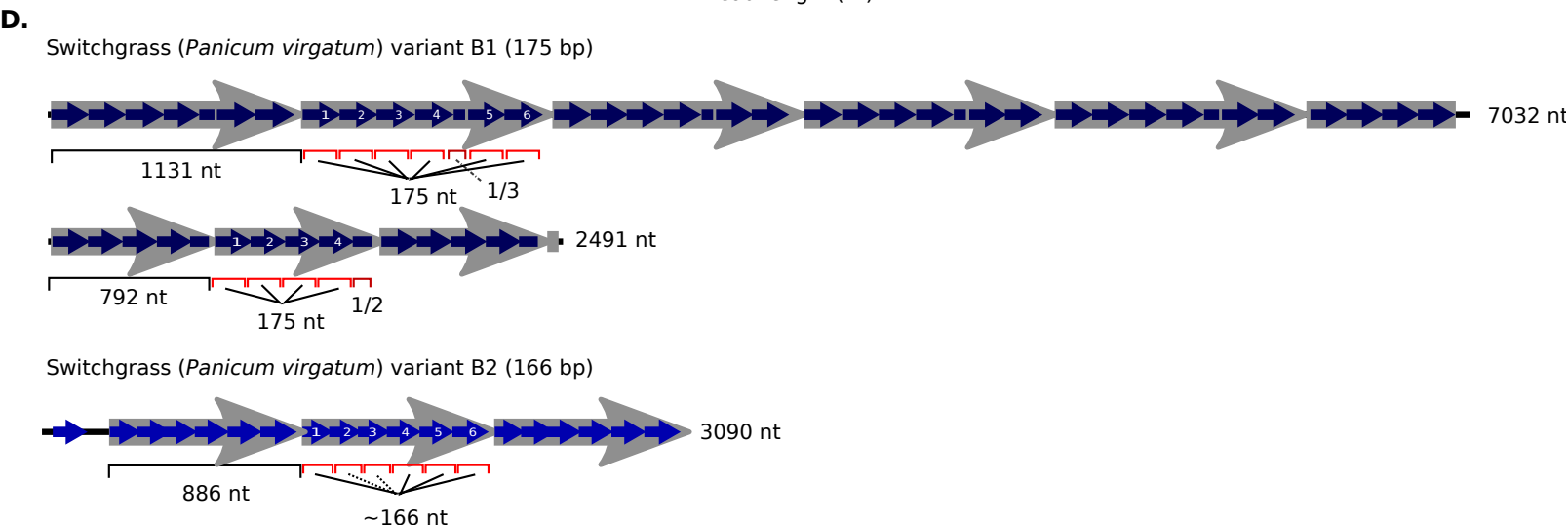
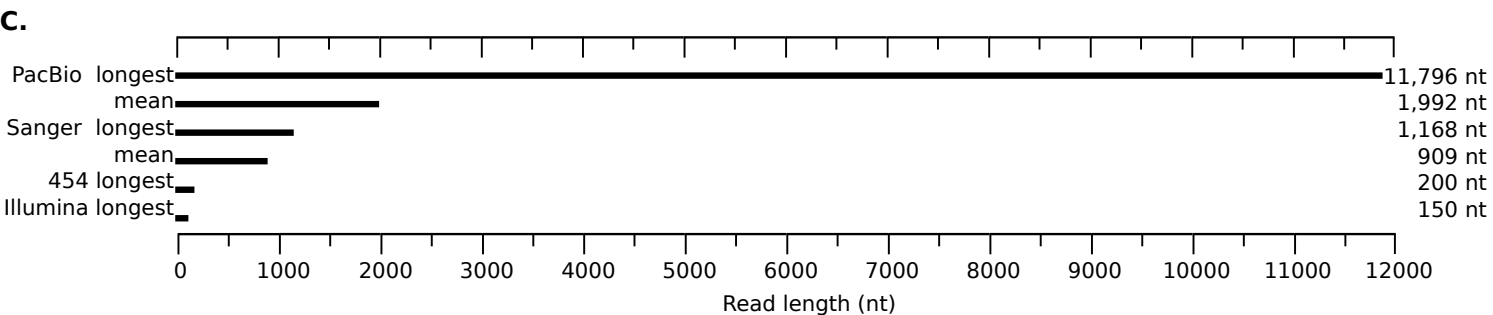
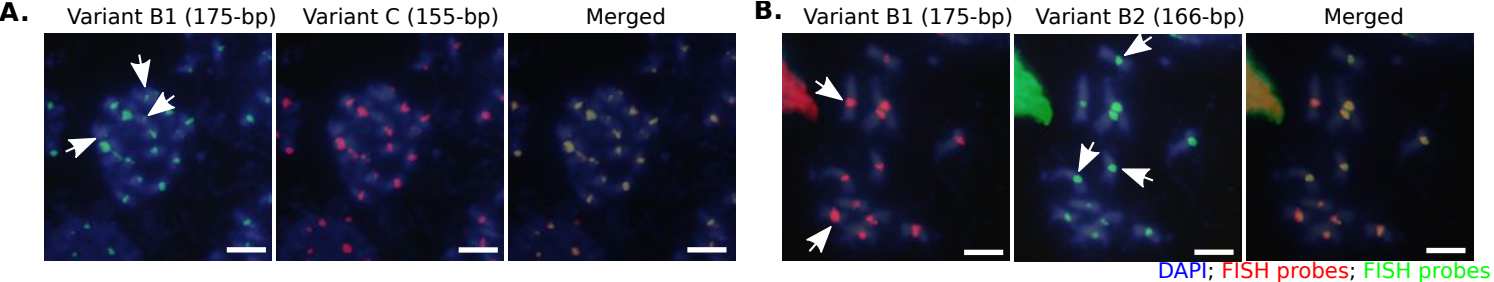

Supplemental Methods

Patterns of Centromere Tandem Repeat Evolution in 282 Animal and Plant Genomes

Daniël P. Melters*^{1,2}, Keith R. Bradnam*¹, Hugh A. Young³, Natalie Telis^{1,2}, Michael R. May⁴, J. Graham Ruby⁵, Robert Sebra⁶, Paul Peluso⁶, John Eid⁶, David Rank⁶, José Fernando Garcia⁷, Joseph L. DeRisi^{5,8}, Timothy Smith¹⁰, Christian Tobias³, Jeffrey Ross-Ibarra⁹, Ian F. Korf^{#1} and Simon W.-L. Chan^{#2,8}

Notes:

1. All (candidate) centromere repeat monomer sequences can be found at the end of this document.
2. All Perl scripts can be downloaded from the Korf Lab website:
http://korflab.ucdavis.edu/Datasets/Centromere_data
3. Accession numbers for sequences used in this paper can be found in Supplementary Table S1.

Bioinformatics pipeline for tandem repeat clustering

In this Methods section we will use results for gorilla (*Gorilla gorilla*) as an example of how each step works.

Trace Archive Data files

For Sanger reads, we downloaded up to five randomly chosen Trace Archive sequence files along with their supporting ancillary files for each species from the NCBI Trace Archive (<http://www.ncbi.nlm.nih.gov/Traces>). E.g.

fasta.gorilla_gorilla.002
fasta.gorilla_gorilla.004
fasta.gorilla_gorilla.007
fasta.gorilla_gorilla.011
fasta.gorilla_gorilla.017
anc.gorilla_gorilla.002
anc.gorilla_gorilla.004
anc.gorilla_gorilla.007
anc.gorilla_gorilla.011
anc.gorilla_gorilla.017

If for any species, fewer than five sequence files were available, we used all available sequences. Each file typically contains 500,000 sequences.

***Gorilla gorilla* input: 2.5 million sequences**

We then filtered these sequences as follows (using information in the ancillary files for steps 1–3):

- 1) Ignored any sequence which wasn't flagged as either Whole Genome Shotgun (WGS) or Whole Chromosome Shotgun (WCS)
- 2) Clipped sequences for quality and/or vector contamination
- 3) Ignored sequences with clipping information that referred to coordinates longer than the actual sequence
- 4) After clipping, removed any sequence which contains >5% Ns
- 5) After clipping, removed any sequence which was <100 nt
- 6) Ran DUST filter on resulting sequences
- 7) Removed sequences that contained >5% Ns after DUSTing

Resulting number of sequences in *Gorilla gorilla* after filtering: ~2.3 million

Tandem Repeats Finder (TRF) parameters

A command-line version of TRF (version 4.04) was run using the following parameters:

Match = 1
Mismatch = 1
Indel = 2
Probability of match = 80
Probability of indel = 5
Min score = 200
Max period = 750

From the output of TRF, we we only kept tandem repeats that contained a minimum of 2 repeats (TRF will identify tandems from less than 2 complete repeats), and which had a minimum length of 50 bp. The processed TRF output consists of a FASTA file containing the *consensus* repeat sequences that TRF produces.

Number of tandem repeats in *Gorilla gorilla* after running TRF: 69,041

Clustering of tandem repeats

Clustering similar tandem repeats was a CPU intensive step and not practical for those species in which we had identified tens of thousands of different tandem repeats. At this point we chose to select a random sample of sequence reads for each species, and then find all of the corresponding tandem repeats that we had already identified in those reads. For this step we chose up to 200,000 reads from each species (fewer if tandem repeats were more common in that species).

Number of reads randomly selected in *Gorilla gorilla*: 100,000
Number of tandem repeats present in those reads: 3,489

We chose to sample reads first, in order to record their lengths for a calculation that occurred in a later step. At this stage we also tracked how many repeat units were present in each tandem repeat that occurred in the selected reads, along with the total length of the tandem repeat array.

We then took the monomer units from the sampled tandem repeats and made tandem versions of them. Next, we used WU-BLASTN to search each monomer repeat sequence against a database of all the tandem-ized version of those repeats (WU-BLAST settings: M=1, N=-1, R=3, Q=3, W=10). We only retained matches that had at least 75% identity.

Number of BLAST HSPs in *Gorilla gorilla*: 12,509,094

At this point we processed the BLAST output in two ways. In ‘global’ mode, we only retained BLAST matches between repeats if the match spanned the majority of the monomer repeat length. In ‘local’ mode, we did not require this restriction and so partial matches of a repeat monomer to a tandem repeat could occur.

For both global and local mode, we then found the tandem repeat that had the highest ‘tandem repeat mass’. This was calculated as follows:

- 1) Count how many matches each repeat has to all other repeats (excluding self-matches)
- 2) For each match, multiply the length of the matching repeat by its copy number in the read where it was originally detected
- 3) Sum these multiplied lengths to produce ‘tandem repeat mass’

All repeats that matched the individual repeat with the highest mass were then removed from the analysis (along with the high mass repeat) and the process was repeated. Each iteration of this process defines a cluster of related repeats. In local mode, clusters grow bigger in size and ‘swallow up’ more of the repeats that match only partially.

For each cluster we can record:

- 1) Number of sequences
- 2) GC% of sequences
- 3) Length of representative cluster member
- 4) Mean pairwise identity between sequences in cluster
- 5) Cluster ‘depth’ – total number of matches to top hit in cluster, including matches to the matches
- 6) Cluster ‘mass’ – the summed tandem repeat mass of all sequences in cluster
- 7) Genomic fraction – the tandem repeat mass as a fraction of the total length of the sample sequences

We typically focus our analysis on just the top global and top local cluster, and these typically account for the majority of the total amount of tandem repeat mass. Exceptions

occur when there is higher order repeat structure. E.g. the results below for *Gorilla gorilla* show that — in global mode — the top cluster finds the known centromere repeat (length 171 bp) and this accounts for ~13% of the sample reads (inferred to be representative of the genome as a whole). However, the second cluster finds a similar number of sequences which are double the length of the top cluster, and which are presumed to represent the same sequence as the centromere repeat, but in a tandemized version. In contrast, the top local cluster contains a mix of both 171 bp and 340 bp sequences and therefore accounts for a higher genomic fraction (25%).

Example cluster output for *Gorilla gorilla*

Summary for *Gorilla gorilla* tandem repeat analysis
 100000 reads, 3489 tandem repeats, 71072791 bp, 0.4232 GC

Repeats (global mode) - using mass threshold %0.1

Cluster	n	id#	length	gc	mean	stdev	depth	mass	frac
0	1230	50980	171	38	87.10	6.00	5399	920589	0.012953
1	1057	61930	340	39	90.06	5.17	2437	827458	0.011642
2	745	72354	70	54	99.16	1.25	7716	540129	0.007600
3	22	33954	171	39	87.29	5.44	100	17016	0.000239
4	20	47128	171	38	85.17	4.26	87	14891	0.000210
5	16	14196	342	34	79.77	4.19	37	12680	0.000178
6	14	6017	76	50	93.72	3.08	123	9322	0.000131
7	12	27715	349	53	85.31	3.27	25	9073	0.000128
8	16	33244	96	37	94.10	3.76	91	8813	0.000124
9	12	58454	64	37	96.93	2.44	130	8316	0.000117
10	11	36485	279	53	88.40	4.60	29	8226	0.000116
11	8	728	341	36	79.59	3.54	17	6125	0.000086
12	9	56545	209	52	93.46	2.28	28	5996	0.000084
13	9	35159	98	69	97.96	1.32	54	5299	0.000075
14	7	32585	168	58	89.05	5.39	25	4352	0.000061
15	5	70673	84	38	89.00	3.08	44	3779	0.000053
16	5	14582	170	37	88.28	7.16	21	3663	0.000052
17	8	62437	161	40	84.42	4.82	22	3569	0.000050
18	5	45011	298	51	80.19	3.19	11	3532	0.000050
19	6	28593	140	54	95.37	2.31	24	3443	0.000048
20	8	33970	125	35	85.75	3.69	21	2763	0.000039
21	5	49512	175	79	85.47	5.73	13	2421	0.000034

WARNING: Top clusters are similar in size. Cluster #1 has a tandem repeat mass within 50% of cluster #0

NOTE: 193 clusters are not reported due to having a tandem repeat mass less than %0.1 of cluster #0, or the cluster contained less than 5 sequences

Repeats (local mode) - using mass threshold %0.1

Cluster	n	id#	length	gc	depth	mass	frac
0	2339	17934	171	36	8026	1787776	0.025154
1	787	15282	348	50	7849	569187	0.008009
2	54	33244	96	37	298	31018	0.000436
3	24	62336	151	46	157	16369	0.000230
4	22	17637	200	58	118	14271	0.000201
5	18	47128	171	38	68	13270	0.000187
6	23	32502	127	78	79	11472	0.000161
7	17	45011	298	51	48	11028	0.000155
8	14	19227	339	39	48	10418	0.000147
9	15	35159	98	69	76	8880	0.000125
10	7	36688	63	42	47	4469	0.000063
11	5	70673	84	38	44	3779	0.000053
12	5	31667	84	67	21	3451	0.000049
13	6	21535	161	69	37	3283	0.000046
14	5	72797	71	60	30	2335	0.000033

NOTE: 107 clusters are not reported due to having a tandem repeat mass less than %0.1 of cluster #0,
or the cluster contained less than 5 sequences

Graphing of results

We produced XYZ graphs to further study the sequences within the top clusters (X-axis = repeat length, Y-axis = repeat GC content, Z-axis = genomic fraction). Multiple peaks with different length, but the same GC percentage would be separated by steps less than 50 bp. These peaks would represent various multimers of shorter repeat than the cutoff of 50 bp. In these instances, TRF and the subsequent steps were re-run but with a minimum repeat length of 20 bp. This was done for ~40 species.

Sequence Read Archive files

For Illumina and 454 reads, we downloaded either *.lite.sra or *.fastq.bz2 files for species from the DDBJ Sequence Read Archive (<http://trace.ddbj.nig.ac.jp/DRAsearch/>), e.g.

Species	: <i>Gorilla gorilla gorilla</i>
Submission	: ERA013840
Study	: ERP000004
Experiment	: ERX007929
Run	: ERR019516
File	: ERR019516.lite.sra (2.1 Gb)
Unpacked files	: ERR019516_1.fastq and ERR019516_2.fastq

For each FASTQ file two were made: one with 1.000.000 randomly selected reads and one with 100.000 randomly selected reads. This means that per assembly run either 2.000.000 or 200.000 reads were used.

The read length for Illumina data ranged from 36 to 152 bp, whereas for 454 data the read length ranged around 200 bp.

Because Illumina and 454 reads are often too short to contain at least two copies of a tandem repeat, an assembly step was necessary to find tandem repeats.

PRICE parameters

The command-line used for PRICE (version 0.6) was:

```
-fpp Gorilla_gorilla_100k_1.fastq Gorilla_gorilla_100k_2.fastq 475 90 (input files)
-nc 25 (number of cycles)
-mpi 85
-MPI 95
-tpi 85
-TPI 95
-logf Gorilla_gorilla_run1 (log file)
-o Gorilla_gorilla_run1.fasta (output file)
-picf 20000 Gorilla_gorilla_1M_1.fastq 500 2 25 (seed file)
```

For a detailed manual go the PRICE website (<http://derisilab.ucsf.edu/software/price/index.html>) or on the command-line type “PriceTI -h”

Per cycle a FASTA file was created containing the assembled contigs. These FASTA files were fed into the TRF pipeline as described earlier for Sanger reads.

Tandem Repeats Finder (TRF) parameters

A command-line version of TRF (version 4.04) was run using the following parameters:

Match = 1
Mismatch = 1
Indel = 2
Probability of match = 80
Probability of indel = 5
Min score = 200
Max period = 2000

The only difference between the TRF parameters for Sanger data vs Illumina or 454 data is that the maximum tandem repeat length is not 700 bp but 2000 bp, the upperlimit of TRF (Benson, 1999).

Genomic fraction determination of PRICE derived tandem repeats

Tandem repeats derived from PRICE contigs were doubled in length. 2,000,000 reads (both 1,000,000 files were used) were aligned to the doubled tandem repeat monomers with WU-BLASTn. Only the top hits (hspmax = 1) was used for determining the genomic fraction. The minimum BLAST score was dependent on the length of the reads. The number of reads that significantly aligned to the tandem repeat were counted and the fraction of these reads over all the reads determined the genomic fraction. The average of each file was used as the genomic fraction for that specific tandem repeat. The most abundant tandem repeat was predicted to be the candidate centromere tandem repeat.

Pacific Biosciences data

PacBio reads were processed the same way as Sanger reads, as described earlier, with the exception that the maximum tandem repeat length was set to 2000 (Max period = 2000). Please note, that only the insert sequence was used for analysis, not the complete PacBio read. Because two loops are ligated to a double stranded DNA fragment, the polymerase can read multiple times over the same DNA molecule. For determining tandem repeat structures, only a single pass over the dsDNA molecule will suffice.

For the grasses (*Panicum virgatum*, *Panicum capillare*, *Zea mays*, and *Zea luxurians*) the sequences longer than 1,000 bp were used. For the bovine species (*Bos taurus taurus*,

Bos taurus indicus, *Bos grunniens*, *Bison bison*, *Bubalus bubalis*) sequences longer than 3,000 bp were used. This was to guarantee that the genomic fraction would not be diluted with sequences which would be too short to contain at least two copies of the described centromere repeat sequences (see Supplementary Table S2).

Supplementary Table S5 - Number of PacBio reads per species.

Species	>1 kbp	>2 kbp	>5 kbp	>10 kbp
<i>Panicum virgatum</i>	27702	15699	2124	3
<i>Panicum capillare</i>	14624	6596	216	0
<i>Zea mays</i>	137989	43145	6829	175
<i>Zea luxurians</i>	87448	25063	2031	51
<i>Bos taurus taurus</i> (Hereford)	nd	59294	16319	593
<i>Bos taurus indicus</i> (Nellore)	120588	54463	7408	35
<i>Bos grunniens</i>	nd	74043	9014	263
<i>Bison bison</i>	nd	107023	29945	1093
<i>Bubalus bubalis</i>	nd	158768	16941	501

Plant material and growth conditions

Seeds from the inbred line B73 of *Zea mays* were provided by the Hake lab (PGEC, Albany, CA). *Panicum capillare* seeds were obtained from Tom Juenger (UT Austin, TX). Foxtail millet (*Setaria italica*) seeds were obtained from the National Genetic Resources Program (NGRP, Beltsville, MD), whereas dihaploid switchgrass plants (*Panicum virgatum*) were already available (Young et al., 2010; Young et al., 2011). Seeds from all species were germinated in appropriate soil and plants were maintained in the greenhouse at 21-28°C, under supplemental light (16:8 photoperiod), watered as needed, and fertilized weekly with general purpose 20-20-20 fertilizer.

Switchgrass (*Panicum virgatum*) DNA isolation

Switchgrass (*Panicum virgatum* AP13 (tetraploid)) genomic DNA was isolated using a modified protocol from Chen and Ronald (Chen and Ronald, 1999). In summary, fresh leaf tissue was ground thoroughly in liquid nitrogen and the powdered tissue was added to 4.0 mL of extraction buffer (1.42 M NaCl, 100 nM Tris-Cl (pH 8.0), 2% (w/v)

polyvinylpyrrolidone (PVP-40), 20 nM EDTA and 2% (w/v) CTAB), 5 mM ascorbic acid, 4 nM diethyldithiocarbamic acid (DIECA), and 0.2 mg/mL RNase (DNase free). Next, the solution was incubated at 65°C for 15 minutes, after which 3.0 mL of chloroform/isoamyl alcohol (24:1 ratio) was added. This was centrifuged at 3,500 rpm for 10 minutes at room temperature. The aqueous phase was transferred to a new 15 mL tube and 0.7 volumes of isopropanol was added, followed by 30 minutes of centrifugation at 3,500 rpm at room temperature. The supernatant was removed and the pellet was washed with 5 mL of cold 70% ethanol for 30 minutes on ice. All ethanol was removed and the pellet was airdried overnight. The next day the pellet was resuspended in 100 µL TE buffer and stored at 4°C overnight. The sample was centrifuged for 10 minutes at 3,500 rpm at room temperature and the supernatant containing DNA was transferred to an eppendorf tube.

Fluorescence in situ hybridization (FISH) experiments

Mitotic chromosome spreads were generated following a protocol by Zhang and Friebe (Zhang and Friebe, 2009; Zhang et al., 2010) with a few modifications. Actively growing root tips were excised from greenhouse grown plants, pretreated in ice cold water for 18-24 h, and then fixed in 3:1 ratio of 95% ethanol and glacial acetic acid at 4°C, overnight. Root material was either used immediately for slide preparation or stored in fixative at -20°C for up to several months. For slide preparation, the root tips (0.5-1.0 cm) were washed twice for 5 min each in 0.01M citrate buffer and digested in an enzyme mixture of 50 mg/ml Onozuka R-10 cellulase and 30 mg/ml Macerozyme (Phytotechnology Labs, Shawnee Mission, KS) at 37°C. Digestion times varied from 30 min to 2.5 h, depending on the thickness and degree of lignification in the root tip. Softened root tips were then washed for 5 min in 0.01M citrate buffer and transferred to a slide. Forceps and a scalpel were used to carefully excise the white tissue just behind the root cap containing actively dividing mitotic cells. All other root tissues were removed and the remaining cells were macerated in a few drops of 1% acetocarmine stain. A coverslip was placed over the stained tissue and even pressure was applied to generate mitotic chromosome spreads. Slides were viewed under phase-contrast microscopy to identify spreads optimal for use in FISH analysis.

Plasmid vectors containing a single copy of each repeat sequence were synthesized by Bio Basic Inc. (Ontario, Canada) and used as probes for FISH analyses. Plasmid vectors were labeled with either digoxigenin-11-dUTP or biotin-16-dUTP using a nick translation protocol, in accordance with manufacturer instructions (Nick Translation Kit; Roche Applied Sciences, Indianapolis, IN). Hybridization and post-hybridization wash procedures were performed as previously described (Jenkins and Hasterok, 2007). Probe hybridization signals were detected using anti-digoxigenin (dig) conjugated FITC (green), anti-dig conjugated Rhodamine (red), or Streptavidin conjugated Rhodamine (red) antibodies (Roche Applied Sciences). Dual probe labeling of chromosomes was

conducted using non-competing dig and biotin antibodies to allow for simultaneous red and green imaging. Chromosomes were counter-stained with 4',6-diamidino-2-phenylindole (DAPI).

Digital images were recorded using an Olympus BX51 epifluorescence microscope (Olympus Corporation, Center Valley, PA) with a DP70 CCD (charge coupled device) camera and suitable monochrome filter sets (Chroma Technology, Rockingham, VT). Images were processed using GIMP 2.6 (GNU Image Manipulation Program) for Linux. Analysis of FISH data was conducted by overlaying a probe signal image on top of the corresponding DAPI stain image. Adjustments were made to the transparency of the top (FISH signal) layer to demonstrate signal and chromosome alignment.

Repeat variant sequences:

Variant A (*Zea mays*):

5'-

CTTTAGGTCCAAAACATGTTTGGGGTGATTTTCGCGCAATTTTCGTTGCCGC
ACGTCACCCATTCCGAAAACGGGTATCGGGGTGCATACAAAGCACGAGTTTT
TGCCACCGGAACAATTTCTTCGTTTTTCGCAACGAACATGCCCAATCCACTA-
3'

Variant B1 (*Panicum virgatum*):

5'-

TTCGTTGCGAAAAATTCCGATGCGACTTCATGGCACGAACTTTTGCATTAAT
TGCACCAGTTCAGCCATTTTGCACCGAGTTTCTGAAGTAACGAAACGATGC
CAAATGCACCCAAACACTACGAAACGCACCAAAACATGAGTTTAGGGTCCAA
TGGGGTGGATCGGGTGCG-3'

Variant B2 (*Panicum virgatum*):

5'-TTCGTTGCGAAAAATTCCGACGCGACTTCGTGGCACGAACTTTTGCCTAG
TTCGGCCCGTTTTGCACCGAGTTTCGTAAGGCAACCAACGGTCCCGAATGC
ACCAAATAGTACAAAACGCACCAAAACGTCAGTTTAGGGTCCAATGGGGTG
GATCGGGTGCG-3'

Variant C (*Panicum capillare*):

5'-

TTCGTTGCGAAAAATTCCGACGCAACTTCGTTTACGCAACTTGTGCGTTAAT
GGCACCAGTTCGGCCCGTTTTGCACCGACTTTCGTGCAGTAACGAAACGGTC
CGAAACGCCCAAAAACATGAGTTTTGGGTCCAATGGAGTGGATCGGGTGCG-
3'

Variant D (*Setaria italica*):

5'-TTCGTTGCGAAAAATCCACCCGAGTTTCGCTACCCGGAAATAGTGCATTC

GGGTGCCGAAATGCACCCGTTTTGCATCATTTCGTGCCGGAACCGAATGCC
CAAAAACACTCCCAAACATGTTCTAGTGTATATTTAGGAAGATTGCATGCG-3'

All (candidate) centromere repeat monomers for the 282 species in this study:

>Cynocephalus_volans
CATTCTGCTGCTTCTCCCTTAGAGTTAACTAGCTTCTGAAAGCTCAACCTCCGGGGAG
TCTGTTTTGGCAGAGATATAGAACACACTATTCCAAGACTGTTGGAAGGCCTTTGCAGTGT
CATTTCGCATCTAATTTCCCAAACCAAACCTGCTTGCAGCTCTAACTCCCTTCTAACTACC
ACTTCTTCGGTTCAGTGAGATATGCTGGATTCTAAACGGAGAAGCTTCTCTGACGCTTTT
TCACAGAGATTTTGAACTGAAATCTCCCATGCCGTTTCCACCATAGGCAGCAATGGGCT
TCCCATAGAACTTGCCAACCTGAATTCCTACAGGCTACATGTGAGAGGCA
>acropora_millepora
TACTTTTTGCAACATTTTTCTAAAAATTGGGTCAAACCCCTAGTGCACGGTACTTTGCAC
AAAAAGTTGCTTATCTCGAGGAGATCGACAAGTTTTGGTGGTTTTTTCAGCAAATGCC
>acropora_palmata
TGGTGA AAAACCCAAAACGTGTCGATCTCCTCGAAATAAGCAACTTTTTGTGCAAAGT
ACCGTGCCTAGGGTTTTGACCAATTTTGGAGCAAATGTTGCAAAAAGTATGGCATT
>acyrthosiphon_pisum
AAACGTACACAAAACCTTAGAGTAGATTAAACCCCTATCTTTTGGTAAGAAAATTATGAAA
AAATATTAAGTATTGGAGAAACGGGACGGGATTCCACCGCCACAGGTGCTGAAATATAGT
CCAAATTGTAGACGGGACGAGCTGTAGTTAATTCAAAAATGAACTAAGACTTATG
>aedes_aegypti
TTTTGGCAGAGTGAATTGACAAATCCAGCACACGGAAAGTTAGCTGGGATCCAGACGAAG
CGATTGATGCTAAGAAATCGAAAATCCGTTGATATTTACTCAACTTTTTAGGAAATCTAC
GGATTTTTATAATTTCAATTGGATTTTCAAGCATGGGTCCCACTAAAAGTTGGAGGCTAAG
G
>ancylostoma_caninum
TATCGATTTATCGATTTTATTGATTTTTTCGCTATTTTTGCTCAGGGGTCGGTGGGGACAT
GTCTACTGGGGTTTCTCAATACGCTGAACACGAATATGGCAACCGCTTCGCACGAAAA
>anolis_carolinensis
GACCCGCCGGGCTTGAAAATGATGAAATTTCCAGAAAAAGTGACCTCTGCCAAATCTG
AAAACTTGCCAAATTTTCATTTTTCT
>anopheles_gambiae
CTATTTGAATGGCCTTGAAATTTGATGTTGAATTTTGTGCCATCTATTATCGTTGTTAC
GGCCATGTTTCATCAAATGAAGCCATCTTGCA
>anopheles_gambiae_M
AAATTC AACATCAAATTTCAAGGCCATTCAAATAGTGCAAGATGGCTTCATTTGGATGAA
ACATGGCCGTAACAACGATAATAGATGGCAACA
>anopheles_gambiae_S
ATGGCCGTAACAACGATAATAGATGGCAACAAAATTC AACATCAAATTTCAAGGCCATTC
AAATAGTGCAAGATGGCTTCATTTGGATGAAAC
>apis_mellifera
CGCTATGGTCGTCCAAAAGAAGTGAAAATTTAGAAATCTTTAAAATAGTGCATTATTA
CGGCTGTATCTCCGAAGATAAGAGAAAAAATACGATTTCCGCAGCTCGTTGCAAGCGGG
AAAGATTGCTCTTTGACCTCATGTTTGGTTGGGTTCTGGACGACAAGCGGTTTATA
>aplysia_californica
ACAAGCATTACGCGAGACAGAATGCAAACCTAGCATTCAAGCAAGAAAGAATGCAAACGA
GCATTCAAACAAGACAGAATGAAAGCATGCATTCAAGCAAGACAGAATCCAAGCAAGTAC
TGAAGACGGAGAGAATGCAAATATGCATTTAAAATAATCCGAATGCAA
>aquilegia_coerulea
CTCGGTTTTTCGGTCCGAACTTGAAAATGGAGAACTCACTTGTTTTTGGACTCTAAAACCT
CAAGATCGACAAGACTTAGCCGGGACGTTTTAAAGGCCAATACAGAACATTTGCACCATTG
GAACGGGATTTTGTCCGGACATTCGGCTTGGTATGTACTCGATTTTTTGTCCGAACTTAT

GAGTGGACGAAACACACATGTTTTTCGCATGGAAAACGATACACCTAAAAGACTAGCCACT
CCATTACTTAACACGGGGCGTTCTAAGGGGAAAAACAACGTTCCGTCCGTAAAAACGTGA
TTTATGAACGTCCGTTCCGGTCGGCATTTA
>arabidopsis_lyrata
CGGGATCCGGTTGCGGCTCTAGTTCTTATACCCAATCATAAACACGAGATCTAGTCATAT
TTGACTCCAAAAACACTAACCAAGCTTCTTATTGCTTCTCAAATCTTTGTGGGTGTGGCC
GAAGTCCTATGAGTTTTTCGGTTTTGGAGCTTCTAAACGGAAAAACACTACTTTAGCTTT
>ascaris_lumbricoides
ATTGAATGGTCACCAGATCATTGGTGAGTTACGACTCATGATGATTATTCTATATCACTA
AGTTAAT
>ateles_geoffroyi
ACCCTTTCTGTGCAGAGATGCAAAACTGTCATTTCCAGCCAAATCCAGGCACGTCAGAAA
AAGCAGTAATAGTGCGTCTAAAACACAGAAGAAACGCATCATTCAAACGCTCTGCTGTG
TGTTTCGTTTTCAACTAAGGGAGCTGAAGCGGAGTTTTATTCCAGCGAGTTAGCAACACGTTT
CTTCTAGGAAGTGCCTTTGGATTTTTCCAGAGCGAAAGGGAGCATTGCTGTACAGAGGAA
TATCTCGCTCTAAAACAAAACGGAGCAATCTAACTGAATGCTTGTCAATGTGTGCATTC
AACTTACAGAGTTAACTCGTGTGTGTTTTGCAGCAGTTTAGAA
>biomphalaria_glabrata
CAGCTACTTCCTTGACAATATCCCAGAAGTTATCTTGTGCTCGGCACCTTCTGCCAACGA
GAAGGGGAAGGGCTACTC
>brachypodium_distachyon
GGATTTCGCTAGGCATGGTCCCTCACTAGGACGGACAATTCGGGGCAAATCGGAGTCGGTGC
TAAACTTTGATCCGGAACGTGTCCATTTGAGGTCCTAGGATGAGCACACCAAACAAAGCT
ACTCATCGAAGCGAAACAAGACTAGACCACCTTGTAC
>branchiostoma_floridae
ACCAAGCTTGCCAGGCCGGAACCTGAAGCCTAAGCTACAATCGCGTTATTAAGTCACCCT
CCTACCCGGTGACGTGACAGGCGGTGTTTTAGAAAAAGCAGCTAGCGGTTGCGCCTAAAC
AGGGTCGGTATACTCAAGAATATCTCGAGAAGGAAGTATCCCAACATTTTTCGGTTTTCA
TCTTTCCATTCCTTGCTAAGGAACCTTTCCAACCAT
>brassica_oleracea
TCTCCACTACTTTATGTATCCAAATACAGCTTCTTACATCGCGATTTCATCCTGGTTTTGAT
CAGAATGACGAGGAAGTTGTCATATTCCCAAACAGGAAAACCTGGGATCACCTGATTTGAA
AGTGGGATAACTTCTTACCTAACTCCTATGAGATTTATTCAACTTCTGCTGAT
>brugia_malayi
TTCATTAACCTACATACATTTCTCTACAGATATAACAATATCACTAGAAGACATTTTGATT
AA
>caenorhabditis_briggsae
AATTTATCACATACGAGTTTTGTGAAAAGGCAGAACAAAGCTTTAAAACAATGATAT
TATTATGGCTAATATTTTACAAAAGAATTTGTGTGAATTGGCTCATTAGAAAAAAGTTG
GAAGCCAAAATCTCGATTTTAGGGCTCAAAAACCGATTTTTTCG
>caenorhabditis_japonica
CGTTCAATTTTCAAAACACTAAGGCTCGGCCAATTTTTGATGAAAATTGCTCGTTTTTGG
ATCAAAATGAAGCTTTCAACCTGATTAATCTGATTATGGTTCGATTGCGCATTCCAATC
GTGTTGTATCATCAAAACACAAGTCTGTATTACCCGAAGTGTCTGAGTCTCTTCAAATAG
AACTGTGTTGG
>caenorhabditis_remanei
CCTTGAAAGCACAGTCTTGGAAGTTCTCATATAGACTTTTTGTGAAACTTCAAGCGTGTGC
GGCCTTGTTCAGTTTGAACGTTATTGGCTGAAAATTGGCACAGTAGTAGACAATCCATTG
CCAATTCGAATGCACTTTACTGTTTTAGATATCTCATCCAGAAAAAAGTTAGAGACAA
TACA
>callithrix_jacchus
AGAGTGGAGCACGTTCCCTTCTAGGAGCTGCGTTTTGCTATTCCAGCGTGAATGGGAGTAA
ACGCTGTATTGAGAAATATCTGCTTCTAGAACCAAAACGCAGCTACCTAACAGAACGGTC
TTCAATGTGTGCATTTCAACTTACAGAGTTAACTGATATGCGTTTTGCAGGAGTTTGTAAA
CCCTTTCTGTGAAGCAGCGGAAAACGCATTTTTCCAGCCAAATCCAAGCATTTTCAGAAAT
AGCTGTAAATCTCCGTCTAAAACACAAAACGAACGTATCCTTCAAACGCTCTCCTGTGC
GTTTCGCTTAACTAAGGGAGTTGAATCCGCGTTTTAGATTTCAG

>callorhinchus_milii
CCGGTGGCTCAATACCGTCACTGCAGCCGCTATAATGAAGCGCAGCAACAGCGCCGCCCCG
GTGGCTCAATACCGTCACTGCAGCCGCTATAGTGAAGCGCAGCAACAGCGCCGCCCCGGTG
GCTCAATACCGTCACTGCAGCCGCTATAACGTAGCGCTGAGCAACAGCGCCGCCCCGGTGG
CTCAATACCGTCAGTGCAGCCGCTATGTTGAAGCGCAGCAACAGCGCCGCGCCGCTGGCTC
AATACAGTCACGGCAGACGCGATAGTGAAGCGCAGCAACAGCGCCGT
>canis_latrans
TGGATACTTGGTCCACATCTGGGCCTCACTGGAACCTACGTGACTCTGGTCCATCTCTGGG
CCTCACCTGACTGGTGGTCTGGTCCCCACCTGGGCATCACTTGGACCTGGTGGTGGTCTG
GTCCTACCTGGGCCTCACCTGGACCTGGTGGTCTGGTCCCAACTGGGCCTCACCTGGA
CCTGGTGAATCTGCTCCCACCTGGGCCTCACCTGGAACCTTGTGACTGGTTCCCACCCGGA
CCTCACTGGACCTGGTGAATCTGGTCCCACATGGGCTCATAGGACC
>capitella_sp
TATTGAATACCTAGAGAATCGATTCTGTGAGCTTATTTTCATTTCGAACAGAACCATCTGAA
GCAATTCGTCTTGACTTCAATGCATTACAGAATCAATTCTGTTGAACTATAAGATCCACT
ACAGAATCAATTCTGTGAGCT
>capsella_rubella
ACAATGAATTTGATTGATTACAAGTGCTAGAGATGCATGAAGAATGTTTAAAAGTGAGAA
GAAAGACTTGTGATATTTGGTCCCAAATGGGATAAGAACCCAAAACCATTGCTTTGAGG
CAGTGAATGGCTTGTATAAGTTATTTTGGGTTAGAATATGTTATAAT
>cavia_porcellus
TTTCACCACACATGCACATTGTAAAATACATGAAAGAATTCACACTGGAGAGAAACCCTA
TGTATGTAAGCAATGTGGGAAAGC
>chlamydomonas_reinhardtii
AATGCAGACTCGAGCAGGGAGCCATGTTGCCAGCCCTCACAGTGCCTTCAGTGCCCTG
ACGCCTGGACAAGGCGGGTGGGGTCCCTGCCGCCAGCCATCACCAAACACCCACCTGG
CACAACCACCTTGTGCACTGTTGTTTCACATTTTCATATGTGCATGTTGCCTGACCTAT
TTGC
>choloepus_hoffmanni
CTGGGCTGAAAAACAACCTTTTTTGAAGCAGTCACTTGGAACTCTGTGAAAGCAGTATGT
TACACAGTTTTTGAAAACTAAGTTGAATACAGCTTTTCATTCACTTCTATGTGTTTTCC
>ciona_intestinalis
GTGTAACGACCTAGGATGGTTCGGGTCGGCAATCGGTGACCTCCGACCGAGCGACTTC
GATCACGACCTCGGGGATCTGGCTCCGCGGCAAGGGGCACCTCGGCACCCCGCGGAGAGC
TCGGGAAGCCCGCGCAATTGTACAACGGCCGGAGGCGGACAGCTTCCACCACAACGAAG
CATACGTCCGGCCGACGTTTTTCGCTCA
>ciona_savignyi
CTTTAAAACGCTAAAGGAACGTGGTACTAGGTTCGGTCTACGACCTTAGCGTGGCAGCAGC
TCGCCCCAAGTTCGTCGCCGACGAGAAAACGAAACTCGCGCGCGCCGGGAGAAAATTGGA
ACGCGAAAATTAGGGGGGTAGATCCGCGCGCGCGCCGAAACGGCCCCCTTTGCCGACGTGC
CATCG
>citrus_clementina
TCCGTGTGCCAAAAATAGGCCGCGGGCAAAGCCGCGCCCAAAAATAACCGCCCGAAGGCC
GGGGCGCCAAGTTCGTCCAGCGGAAAAAGGCCACAAAACGGGTGGGCTATAGCCTTGGG
GGGTGGGGCTGGCCAACCTTCGTCCGCGGACTCGGAATGCCGCGAGACTTTGCGAGGGGC
C
>citrus_sinensis
GGGCGCGGCTGTGCCCTGGCCTATTTTTGGCACACGGAGGCCCGCCGCAAAGTCTGGGG
CCATTCCGAGTCCGGCGGACGAACTTCGCCCACGCCCCCACCAGGCTATAGCCACCC
GATTTTTGGCCATTTTTCCGCTGGCGAGTCTTGGCGCCCCGACCTTCGGGCGCTCATT
T
>culux_pipiens
TACATTTAATTGAGATCCGGCTTCAAAAAAGTACATAAATATCACTTAAGTGGTCATAAC
TCGAGACAGGGTTGCCAGATCTTCAATGTTGTGGACTTGTGGAAAGGTCTTTTGATTAC
CTAACTAACGATGGGTCCGATGATGGATCCGGACATCATTTACA
>cynocephalus_variegatus
CTCCCTGGAGGTTTCAGCTTCTGCAAGCCACTTTAACTTTAAGAAATGAGAGAGCAGAATA

TGCTTCTCACATCTAGCATGCAGGAATTCAGGTTTGCAGTTCTATGTGAAAGCCCATTG
AAGCCTATGGGGGAAACGGCTTCTGAGACTTCTGTTTTCAAATCTCTGTCAAAAAGCATC
AGAGAAGCTTCCCCGCTTAGAATCCAGCATAACTCACTGAACCGAAGATGTGGCAGTTAC
AAGAGAAGTTGAGCTAAGAGAAGTTTGTCTGAAATTAGAAGCAAAATCACACTGCAA
ACGGCATTCAAGCAGGCTTGAAAAGTGTGGTGCATATCTCTGCCAAAAACA
>danio_rerio
TAAAACGATCCAGCCATAAAATGCATCATTCTTTTTTGTGTTTAGACAACAATTCATGCAC
TGTTAAACATGTTAAAGCAAGTTGCAAGTGAAAATCTATGTCTCTGACTGAGTTTGCATT
ACTGTGATTTGACCTCTCTGCTGGCTGAGATAAGCTCATTTTCAACGTCCAATTCAGAAA
GTGA
>daphnia_pulex
TTCAAATCCATTGAAGTTGTGTTCACTTCTGGAAGATCTCTATCAACCCTTATTTCTAT
TTCTTGCCATCATGGATGTCTTAAGAGATTGATTGATTTTAAAGACTTTAAATAGTGTA
TTGGACATCGAATTAACATATCGTGGAACAAGAAATCTGTTTAAACTTGTAAGATTTC
ATATCGTCAT
>dasyopus_novemcinctus
AGGAAAGGAGATAGCTGCAAAATCTCTGCACACAATGCTTAGTTCTCAGAAGTAAATCAT
ATGTGCCATGTTGTTTCAATTTAGGTTTTAAAGAGTTAGGTGCTATACCCTCGGTTATGCTT
TCCTGTATAGGAAATGCTAGTTCTGGAGATACGAATGTTAGCACAAAACTGA
>dictyocaulus_viviparus
TTGGCATCGAGAAATGTTTCGCATAAATCAACATTACTAGATACCAAAATTTCAAATTTTG
CGCTTCGACCACTCTTGATCGTATTACTCATGGATGAATTTAGCAGATTTCTACAGCGGT
TTTCGGCATTGTCAGTAGGAATATGGAGATCCACCA
>dipodomys_ordii
CCAGCCTCACAGAGCCCTGTCCAAGCCAGCACCACCTGGACCGGCCTGGG
>drosophila_ananassae
ATCGCTAATTTAGCGATAAAAAACGGCTAGAAAATCATCACTGTTAGCGCGTAAAACCGCT
AGAAAATC
>drosophila_erecta
ATTTAGTTAATAAATGTGTTTCATGTTTGTGTTTGCACGAAAAGTGGTTTCATGTGGTG
CGCAGATAAAACAATCTACATCCAGAAAAGAAAATATAAACTCTAAACTCTAGACCAAG
TCATCGGTAATTTGTAATTAATAAACTGGTGCACATAGTGTTCAAAAATAATTTCCCACTTG
TTATGGCTTATATTTTATTATACGTTCCCTCTAACAGCCTATAAAGTAGTGGACAGGAAG
TTCCGTGA
>drosophila_grimshawi
AGAAATTCTAACTTCTGACAATTATTGGCGAAGATACATCCGTTTGAATTTGGAAACAGA
AACTTAAAACGTCAATTTCTCGAAATGACTTCGAGACTACATATTTTTCAGCTTTTGATGC
AGAGTCAAAATATATAAAAAGGGCTTCATAATGTTGAA
>drosophila_mojavensis
AATAGTCCTGTTATTGCCTGTTATACATAGAAAAAAGTCAATTTTCTGATCTTTTACCGC
ATTTTCAGGGGATAATAATGTAAATATTTCAAATGTTGGCCCATTGAAAATCTGAATAC
GTCAATGGATGGGACTCTCAAAGACGCTTCCAACGAAGTAAGTCGTAATGAAATCGGCC
AGA
>drosophila_persimilis
ATGTATACTGAACCACCGCACCTATATAGCACCCACGCTCCAGGAAATGTGGCAGGATCG
CACATCTTGGGCATAAGCACCAATATGGCACTATAGCCCCAAAAAAGTGGAACTCCGCAA
CTATATGGCACCTGCATTATATAGAACCCTTCCCTATCCAGCACTGGC
>drosophila_pseudoobscura
AATACGTCTCTCCGCTGGCGGAAAACCTTATCTCCGGTGGCGGAAAATTTATATCCCCTGC
CGGAAAACCTTATCTCCGCTGACGA
>drosophila_sechellia
TTTGTGCAAAATTTTTGGATTTTTTCGATTTTAGATACCAGGCGATGATAATCAGTAGCGG
GTGTCTACTGAAAACCAACTAATCGTTGGTACCTTCTGGAATTTGTTTCGCCTGGTAA
TTTTAAACCGAAAATCTCTCAATTTGCAACAAAATGCGTATT
>drosophila_simulans
CCTACAAAATGCGCATTTTTGTGCAAAATTTTTGGATCTTTTCGATTTTAGATACCAGGCG
ATGATAATCAGTAGCGGGTGTCTACAGAAAACCACTTATCGTTGGTACCTTCTGGAATT

CTTGTTTCGCCTGGTAGTTTTAAACCGAAAAATCTCTCAATTTGG
>drosophila_virilis
ATATCTTGACCAAACCTCGGCATTTATTAGTTTTACTATACTCCTCATATATATGCAAAAT
CCTATTAAGATCGGACCCTATATCATATAGCTGCCATAGGAACGATCGGTGCGAAAATTA
AGTTTTTGTATGAAAAACATTTTTGTTTTTCAAG
>drosophila_willistoni
CAGCCGCCATTTTGTAGTCTTCTACCCGCCATTTTGTAGTCTTTTAGCCGCCATCTTTAATA
TAGAAGCCATACGAGCTGCTAGAACCATTCTA
>drosophila_yakuba
AGTATATACATGATGCTTGTAAATAATCCCAACTTGTCTGGTTATTTTTCTTTATATG
TACTCTTACTGCCCAATAAAGTGTAAATGGCCTCTATAAACGTTGATGCAGGC
GATGGGGATTTCAGGAGCTGCGCGGGTGTAAAATCTGCATTTCAGGACGCCGTGAACCAGGA
CCAAACCAAGCCAGGTTAGTAGTGAATGAACTATATTTTTTAAAACTATATGTGTTTCA
TGAATAATACACAATTAAGTCCATCGACATTTAATATTAATAAAAACTGAATTACTGTCA
GCTTACACCAATATGACATGTCAACTGATTCGCCGAAAATATACACAGTCAAAACAAGTT
AAGTTTGGCCACGTAATTGTTAATGATTGTTTGA
>dunaliella_salina
CAGTGCACACCCTCCAGGAAATGTGCAGGTGCACCTTGGTGAAGGAAAAGGCTCTAGCAA
CACAATACTCAGTTCCAAAATGCCACCAGCAGCATTCTGAAGTTCTGAGTACTATAGTA
TTCAGCTACAAAAGACAGCATGAGAACTGCTGTGTCTCTGGAAAGATATTCAGTCTCT
GTT
>echinops_telfairi
CCTGCAAGCCAGGCAAGGGACTTCCGGGCAGGCTGGGGAAGCGAGGCTTTGCCTGGCGTC
TC
>equus_caballus
TTGCTTCCAGCTCTTTGGGAAGCTAAGAAACAACCTCGCTCTGCACAGTGTCTTTACAGCC
TACCGGGAACATCTCTTACAAAGGCCTGTGAAACGCAGTTTCTTTGCAGGCCTGATCTGG
CTGAAGTAGAATCTCTGCTCTGCGTGTGCTACATTGCCCTAGAGCTGAAAGGCACAACGT
GCAGGCTTCTTTCCAAAGGGCGAGATGGGCCCCAAAGCATC
>erianceus_europaeus
CTCTCTCAGCACAGGCACAGCACCCAGGGAGCCCATGGAGGGTGGGCAGGGCTGTGGGG
TCTCTC
>eucalyptus_grandis
CGGATTTAATATTTTTGGAGATCCCGATACCTTGAAAGTGGGCTGAAATCAAGAAACGGAG
ACTCGGCACAAAAAATTCCTTGTGTTCCATTAATAAATTCCTTTTTCGGTATTTTCACTAT
AGACCCCGGCAGGCGGAAACGGCATGGATAAGTGGGCTCCAAAAGCTTTATTTTCGAT
>felis_catus
GCGGGCACTGGGTTCACTGGAGGCTGCAGTGCC
>felis_silvestris
GCACTGGGTTCACTGGAGGCTGCAGTGCCCGG
>gasterosteus_aculeatus
TGACACGGTACAGTGGTGTAGTGGTTAGCACTCTCGCCTCCCAGACAGATGCCTCGGGTT
CAACTCCACCCAGTGGTGCCTCTGTGTTAGGTGGTGTAGGCTAAGCCTGCATGGGATTCA
CTCCATACTTGTAAAAGTAATGGAACAATTTTTTAAAACTTCGCATCTGAAAAGAATCCC
CAAATATTTTGAAAAAGTCATGAAATCTATCTTTAGTCATATGAAGGGGGACGCCGGT
GAGAAAACGTACTTTTGAATAAAAAATCTGAATATTTTCTGAATTGGAGTCATAAGACATT
CTAATGGCAGCAGT
>globodera_pallida
ATGCGTGAGACCAATATGAAGAAAGTTATGGCGCTCGGCTTGCATGGATTTGGTAGGGTG
CACCTTAATTTGTTGGGGCACTTTAAATTCATAATATTCCATCATATTATATACCGTTTCG
ATTCCTGCCAACAGCTGAGCACGTATATCTAAACGCTGG
>glossina_morsitans
AAATTTTCAGAAAATTTGGTTTTTACGGCTCTCAGAACCACACGTACAGACATGATAAATT
CGCACAATGTGCTGCAAATAGCGTTTTTGGCAACCACAGCAAGCTATTAGAATGCTAACTA
TTGCTTTTTTATGAAGAAAAGCAA
>glycine_max
TCACTCGGATGTCCGATTTCAGGCGCATAATATATCGAGACGCTCGAAATTGAACAACGGA

AGCTCTCGAGAAATTCAAATGATCATAACTTT
>gossypium_raimondii
TTAGGGAGATAAGATCTACAATCTTCAACCTACTCCACTGCTGCTCAGGGAGATAGGACT
GGTGGCTTAAATCTGCTTCTACTATCTCGGGAAGATAAGATTCGCCGTCTTCGATCTGC
TCCACTACTGC
>haemonchus_contortus
TGGACCTAGAGCGTTCAAATTTGGTAAGAGTACAGGAGACAGGATGGAAACACTCATGGT
TGGTGGCAGGACCGGACTCCGCCACAAGGGGCGGGGTTTGTGCAGAAAATCATAGCTGC
AGTTCCCG
>heliconius_melpomene
TTGAAACTGGTGTGATCGTTCGGGCTCCGAGGGGCTTCAAGGTGGTATACAACCCGCG
GGAATGCGCGGAAGGTGCGGGCGGTAAGTGGCGAAAACCGATTTTTTTCAGTTTTCCCG
CTCGGATTCAG
>helobdella_robusta
GTCATACTAAACAGCTACAGAAACGACAGCTCAAACCTACTGAAACCACTGGTCCAATGAC
GACGCAAGAAACGACTGTGAGGCTCCAAGTAAAAATTATTTAATCGAAACGTGTCTGC
CAACAAATTGATTTGATTTTTCACACCTGACAACATTGTTTCGTTTTAATCGTATTTTCAGC
TACTGCTTCTCCACCTACTGAAGCTCCGACAACCTGTTACAACCAAGGAAATCGAAACATC
AAGTCCAGTGTCAACGACAGAAACAGAGACAACAGTTGTTCCCTCCAAGTCAGCTTAATTA
GAACTATTAATAAATCTTAATTGATTAATATAGCTTCAACTCAGTAAAACATATTTA
AATTTATTTGACC
>heterorhabditis_bacteriophora
CCTATGTCGGTAATGGATGCACTGTAGGTGCTGCAGTGAGACTCCCTATGCGAGATAAGA
TCATATCGATAGAGAATTTGATGACGATCATTCTGACATATCTAGAATCTCTGTACGATG
AGTAGATCAAAGTTATGCCCGAAAAACACGTTTTAACGCATTTTTGCA
>homo_sapiens
AATATCTTACATAAAAACTAGACAGAAGCATTCTGAGAACTTCTTTGTGATGTGTGCA
TTCAACTCACAGAGTTGAACCTTTCTTTTGATTGAGCAGTTTTGAAACACTCTTTTTGTA
GAATCTGCATGTGGATATTTGGAGCGCTTTGAGGCCTATGGTGGAAAAGGA
>hydra_magnipapillata
CCTGAGTGAATCAAAGGAACCTAAGTTTTTTTACGACAAAAACACTTTTTCTATATAATAAC
TTATCTAAAATTAATAAATAAGACAATTGCGTCAAAAAACAGGTTTCCACTGCTTTCTT
TTGGAATCTTTTGATATCTTTTTTATGATTATGTTGGTTTGTAAAGAATAAGGTCAAAT
AAA
>hylobates_concolor
ACAGAAGCATTCTGAGAACTTCTTTGTGATGTGTGCATTTCATCTCACAGAGTTGAACCT
TTCTTTTGATTGAGCAGTTTATAAACACTCTTTTTGTAGGATCTGCAAGTGGATAATTGG
AGCACTTTAGGGCCTATAGTGGAAAAGGAAATATCTTACATAAAAACTAG
>ixodes_scapularis
ACGGTGAACGAATAAAACGGCGCCGAACGTCTCTCGTCAGGCCGTGCTCGCTCCAATAAT
TCGTTTTACCGAGGCAATAGCCGAGATCGCGGTC
>labeotropheus_fuelleborni
CATAATGAAAACCTATACTTTGTTTCAGGCGAGTTTCCCATTCAAATGCATGTAACAGTG
AGAAACGCATTGTCTTGGCGAAATAAAGCGTTTTTGAACAACCTTCATATAAATCGCTGTA
ACTTTTGATAGAAGACTCAGAAACACATGTTTATGGCTTTATCTTATAGAACTCAATATC
CCGTGCTGGGCAAACAGGTTTTGCAGCCGTTTGGAGCTAAGATTTTTAAATATTCA
>lama_glama
CGTTCATCCAGCACAAAGGAAAGGGTTGCAGGAGAAACACTGACTCTGGTTTCTCAGACT
GTTTCCTAGTGCCGTTTTGAAGTGCCTGCCGTTTTTCACTGTAAAACCGAGTTGGAGCTTG
TACCTCCCCATATATATGAATGGAGTGGAGTTTGAACACTGAAAAGAACTTTGTGTTCC
TTCAAGCTATGTGAAGGACGGCTTTCACACACACTTATCTCTCAGAACTGAGCATGTGGA
GAGACGTT
>latimeria_chalumnae
CAGCAATTTTTCAGCACCCCTTTTTGGGGGGCATCCGGATCAGAAATTTAAAAAGCGCTG
ACT
>lemus_catta
CTTTCTAAGTGAATGTAAGCGTTCCTATATATGACTCTCGCACTTCATCCAAACTAGA

GTTTAGCAGGCCTACAAACCACCACCCCATAGTTG
>lottia_gigantea
GCAGACTGCCGACCCACCCTCTAACTAAAATGGCCACAACACTACTCCAATTTTGACGCTA
GGGGAATAATTTTTGTTGCAAACGAGAGTTTAAACATGTTCCCTATCTATTTTCAGCCGAAA
GCAGAAATTCGGAATTTTTGAAACGTTTCGAGAAAATCGACTTTGAAGTGTAACCCAATTT
TCAAGAGGAAAATCGCGTATTTTTGGTTAGGGAAAAATTGAAACCAAAGTGCTGTAACA
AGCAGAGTTTTCAAGATAGGAACCTGAAATTCGAAACACAACAACCTTCCAATAGGGGTGT
ACCTTCAGTGCAAATTTCAACTTTACAGCTCTGATACCCTTTGAACGACAGCCTGTCAAA
GTTTTGGTCTTCACCCTTAACATACAATGCAAAAAGACGCTATAG
>loxodonta_africana
TCGGAAGGAAGGCCTGGTGACTGTACCCAGAGGTACC
>macaca_mulatta
TCCTTTGGCACCATAGCCCTCAAAGGGATCCCAAATATCACTTCGCCGATTCCACAAGAA
CTGGCTAGCGAAAGGCTCCTTGAAAGAAAGATGTAACCTCTGTGAGATGAATTCACAGAAC
ACAAAGAAGTTTCTCAGAAAGCTTCTTTCTCTTTTTTATCGGAGGATATT
>macropus_eugenii
TAAAAGCCTTTCCACACTGACTACATTCATAAGGTTTTCTCTCCAGTGTGGATTCTCTGAT
GTTCACTAAGACTGGACCTGTCTC
>manis_pentadactyla
GCTTCAAATAGTATCCCTCACCTTGCATTGGTGGCTCCATCAGAGATTACTGATGTAAA
TTCATTTGCAGCATTTCTGAAAATTCAAAACATATATGATCAGACTCCAGAGACTTCAG
AGAGTTACACTTTTT
>marcantia_polumorpha
TCACGCATTTTGGAGTTGGGACGCCGAAGTTCACGGATTTCTCAAGTTTTCGAGTTGGAGT
TTTCGAGAGTTGGGGTCGAGATCGTTTTCTTGAGAGATTGTTTTCTTCGCGTCTGAGTGTC
CACGGAAGCTGAAAATTTGCAGGGGCGTGGACTTGGGTAGCGCGCTCCAGCCTGCAAAAT
T
>melanochromis_auratus
AGTTGTACAAAAATGCTTTATTTTCGCCAAGACAGTGCCTTTCTCACTGTTACATGCATTT
GAATGGGAAACTCGCCCGAGACAAAGTATAGGTTTTTATTATGTGAATAATTTTAAAATC
TTAGCTCAAACGGCTGCAAAACCTGTTTCGCCAGCACGGGGATATTGAGTTCTATAAGAT
AAAGCCATGAACATGTCTGTCTGAGTCTACTATCAAAAGTTACAGCGATTTATATGA
>meloidogyne_incognita
GCCTGGGGGAAACCTATTGCCTGAACCCAACCACACTTGGTCAATTGCACCTTTGGTCTAC
TTTGCCTGAGGCAATTTTTAATCGGATCGTCACGCACTCTAAACCATGAATGCCAGGTGA
AATTTGATT
>metriaclima_zebra
CACATAATGAAAACCTATACTTTGTCTCGGGCGAGTTCCTCCATTCAAATGCATGTAACAG
TGAGAAACGCATTGTCTTGGCGAAAGAAAGCGTTTTTGTACAACCTTCATATAAATAGCTG
TAACTTTTGATAGAAGACTCAGATACACATGTTTATGGCTTTATCTTATAAAACTCAAGA
TCTCCGTGCTGGGAAAACAGGTTTTGCAGCCGTTTGGCTAAGATTTTAAAATTATT
>microcebus_murinus
CGGGCAGGCAGGGCGCAGTGCAGGATCTGGCTGTGTCCACTCACCCACGGCAGA
>micromonas_pusilla
GGTGGCCGCCACCCGCGGCATCGTCGCAAGTCCACTCGTCCCACGGAGCGTCGTTTCGCGC
GCGCCCACTGCAGCACCTCCA
>micromonas_sp
CACGGGAACCACAGCGGCCGTTTTCAATCTGCGCCCCGTCGACGATGACGATCACCGGCTC
GACTCGACTCTGCTCGACCCGTGCGAGGTGTCGATGCGTTCGGGCGTGCCGTGCGGGTTCG
GATGAGCGTACGAAGTGCATTTCCAACGGTTGAATCGACACCAAGCTAGCACGGACCAC
ATGAACCCTCAACATAACCCTC
>monodelphis_domestica
AGCTTACTGTACACCAGAGAATTCATACTGGAGAGAAACCTTATGAATGTAATGAATGTG
GGAAGGCCTTTACCTGAGGTCAC
>myotis_lucifugus
CAGCTTTCTACATCTAATCTCGGTGATTGAACAAGGCCATAAAGATAGCACGGCTCTATT
TACATCTATTTCAAGTGTCTTACACGTTTTCTAATCATTTCCCTGACTTATTGCGTATT

TTAAGAGTTTTACCAAATTAGACAGTTTTCTTAGAAGTATATACATGAATCTTCAGGAT
TTAAACAGTTTTATTCAAAAAAGCCAGCCAAGTCAGCCTCACTTGTAATATAAACAGT
ATTCTCTATTTAAAGGCTTTATGCACAAATTCTGAGCTCTTTAAACTGCAATTCTTAAT
GTTTGAAAGCACATTCTTCGAAAAAGACCAAGTAAAGTAGCCAGAATTATAAACATTAT
CAGTATTCTCATCACTTCA
>nasonia_giraulti
CGCTTTGGTTTTAGATTTTATACTCGCTTCGCTCGCCTTCCTTCGATGTGCCGAGGTGTT
TTTTAAATAAATTATTGAGCTCGGGGAGCGTGGTGTAGTTGGGTTTAAAG
>nasonia_longicornis
TGGGTTTAAAGCGCTTTGGTTTTAGATTTTATACTCGCTTCGCTCGCCTTCCTTCGATGTG
CCGAGGTGTTGATTAAATAAATTATTGAGCTCGGGGAGCGTGGTGTAGT
>nasonia_vitripennis
CACATCGGAGGAAGCGGAGCAAAGCGAGTATAAATCAAAAACCAAAGCGCTTAAACCCAA
CTACACCAGCTCCCCGAGCTCAATAATTTATTTAAACAACACCTCGG
>nematostella_vectensis
GGGCTGTAGGCATTTCCTTTTTGTATCGAAGTACTCACAGGACTGTTATATAATAGATA
GATCTTAAACAGTTCTATCGTCTACGGCCATACCACTTAGAAAGCACCGGTTCTCGTCCG
ATCACCGAAGTTAAGCTCAGTAGGGCGCGTAAGTACTTGGATGGGTGACCGCCTGGGAA
TACCGT
>nomascus_leucogenys
ATCTGCAAGTGGACATTTGGAGCGCTTTGAGGCCTATGGTGAAAAAGGAAATATCTTCAA
ATAAAAACACTACACAGAAGCATTCTGTGAAACTTCTTTCTAATCTGTGCATTTCATCTAACA
GAGTTGAACCTTTCTTTTACTGAGCAGTTTTGAAACACTCTTTTTGTAGA
>ochotona_princeps
AGTGTGAAAACACTGAGTTTCCCTTGAGAGCTGCTTGGAAAGCCTGATGGTGTGTGAAGTTAGT
GAGCCAAATGGAGTTGTTCTCCCACAAGAACCACTCGACTGATTCTTCTTCAATATGCCC
TTCACCAACATGCAGTGTTCCTTGACAGAAATAGCTCTCACACCAAAATTTGCGTCTAG
AGCCTTTGCATTGAGGGCTATCTGAAAACGGCTTTGGCGCTGAAGTTGTATGTAATGCG
GAGTCAGAGGCATGTGAAACCCGCATGTGGAGCATTGGTGTGTGTGCGATGCTCACCAAG
CTTCATTCCAGTACAAGGCCTCAAAGGGCATTAAAGCATAG
>oesophagostomum_dentatum
TTTTACTCGAAAACGCAGTTAAATGCATGCATACACTTGTAAAAACCTCATG
>onchocerca_volvulus
AATTTTTCTTGCACCGTCGGCCTTAAACTCTTTATCATCATCATCACTACTAGAAGTGC
TGTCAGATGAACTTTAGATACTCTGCTTGCAGAAACCGCATTTTTTAAATTAGCATTG
GCGTAGCTGGAACCGTTTTTTTCGGG
>oreochromis_niloticus
AATGTGTTTTCAGGCGAGAAACGCCTGTCTCGCCGAAATAAGGCGATTTTACCAAGTCC
ATAAAGACAGCTGTAACTTTTGATAGGAGACTCGGACACACATATTTTCAAGGCTTGGCCTT
ATAGAATTCAGCATTTCCATGCTGGGGAAATAGTTTTTGCCTGTTTGGAGCTAAGATTT
TCAGTTATTGACTAAATGAAAACCAT
>ornithorhynchus_anatinus
CAGTTTGGGCCCCCAGCCTTTGCCTTCCAGGTTTGGCCCCGAACCCTTTTCATTC
>oryctolagus_cuniculus
GAATATCCAGAAAACACAAACACACAGAGGCTGTAGCAAGATCTGGGATTGAGATAGC
TACAAATACCAGATAGTTTTGTTTTTCCATCCAGGAGTATCTGGACAAATGTTGTGGATT
TCAGGTGAAATTTAACCATAAATCACCGTGAAAGTGGTTTTGGAGAAAAGCACAAATCTTCC
TGTTTCGGCAAATGTATCCAATGTCTGTTTACAGAAAGAAATATCATGTTTTCTCAGGTT
TCTGAAGCTCTCTTCTAGAAAACCTCGAATGTGTGGAGTAGTTGACTCCAGGTGGAAACA
ATTAGCGTTTGGCAGCAGAAAACAAAAGGGTCCTGCTAAAATGCATTCAAACCTTAA
GTCCATAGA
>oryzias_latipes
AACTGCAAATGAGAACTTTAACTTTTGGGTGCATTTTTTGTCTAAAAAATCATTGTGTCAG
TCAAAAGTGCCAAAAGTGTCAAAAAGCGTTTTGGCTCTCAGTATGACTGTTTTGAATTT
TCAACTTACAATGTGACAAAAAATAACACTTTTTTTG
>ostreococcus_lucimarinus
CTGCGAACGCAGCGCTCGCGCTCAGACTCGAGATCGGACACGGCAGCGGACTGCGACGC

GTCAACCTCGGGCACCTGAGAAAGCACGCGCTCGAGCTCCGACTGCAGCGCGTTCGCGCTC
AGACTCAAGTGCCGCCTTGGACTCGTCGAGCTCAGAACGCACGCGCTCGATGTCCTCCTC
GCGCTCGCGAAGCTGGGACTCAAGATCCGCGCGCACAGACGCCAACTCAGAGTCGCGAGC
GGACGAAAGGTCGGCGAG
>ostreococcus_sp
ACGAACGACGCCGGCGACGACGCGTCTGGCGCCGACACGCAGTGGCATCCCATCATGTGC
GCGCGAACAAGCACGTGCAGAGCCACGCGTGGCGTGGCGTGTCTGCCGGGACG
>otolemus_garnettii
CAGGCACCCCTGAGGGCAATTAGGAATCCAATTAGAAACACCTGTGGCCAATTAAGAGAA
AG
>pan_paniscus
CAAGTGGACATTTGGAGCGCTTTGAGGCCTACTTTGAAAAAGGAAATATCTTCACATAAA
AACTACACAGAAGCATTCTCAGAAACTTCTTTGTGATGTGTGCTTTCAACTCACAGAGTT
GAACCTTTCTTTTCATAGAGCAGTTTTGAAACACTCTTTTTGTAGAATCTG
>pan_troglodytes
CTAGACAGAAGCATTCTCAGAAACTTCTTTGTGATGTGTGCATTCAACTCACAGAGTTGA
ACCTTTCTTTTGATAGAGCAGTTTTGAAACACTCTTTTTGTAGAATCTGCAAGTGGATAT
TTGGAGCCCTTTGAGGCCTATGGTGGAAAAGGAAATATCTTCACATAAAAA
>pan_troglodytes_schweinfurtti
CCAACATAGGCCTCAAAGCGCTCCAAATATCCACTTGCAGATTCTACAAAAGAGTGT
CAAACTGCTCTATCAAAAGAAAGGTTCAACTCTGTGAGTTGAATGCACACATCACAAAG
AAGTTCTGAGAATGCTTCTGTCTAGTTTTTATGTGAAGATATTTCTTTT
>panicum_capillare
GTTTTGGGTCCATGGAGTGGATCGGGTGCCTTCCGAAAATCCGACGCAACTTCGT
TTAGCGAACTTGTGCGTTAATGGCACCAGTTGGCCCGTTTTGCACCGACTTTCGTGCAGT
AACGAAACGGTCCGAAACGCCAAAACATGA
>panicum_virgatum
GCACGAACTTTTGCATTAATTGCACCAGTTACCCCGTTTTGCACCGAGTTTCATGCAGT
TACGAAATGATCCCAAATGCACCCAAACACTATGAAACGTACCAAACATGAGTTTAGGG
TCCAATGGGGTGGATTGGGTGCGTTCGTTGCGAAAATCCCGACGTGACTTCGTG
>papilio_dardanus
TTTCTAGATTCAAATATGAACCCCTTTTTGACCCCAAGGTTGAAATTTGAAAATC
CTTAAATGGCAAAGTTATTTATTCATGCTGAAGAGCTCTCATTCCAATTTTCATGCAATT
CTGACCTAAGGTGTGAAAATA
>papio_hamadryas
GAGATGAATTCACAGAACACAAAGCAGTTTTCTCAGAAAGCTTCTTTCCAGTTTTTCATCTG
AGGATATTTCTTTTTACCATAGCCCTCAATGGGCTTCCAAATATCACTTTTCAAATTC
CACAAGAAATAGGCTAGCGAAAGGATCCATGAGAAGAAAGATGTAACCTCTGT
>pediculus_humanus
ATTAGCGCTATAAACGGCTAATTGGTCTGCTTAAATGTTTAAATATCCGGTTAATCGGA
TAAATTAGAATCCGATAACGGATTAATTTGTCATTTATGCGCCAG
>peromyscus_maniculatus
TTCAACTCCGTTTAAAGAAGTTGAATTGAACCCTAGTTGGGCCTTACAAGAAAAACTCT
GCTTTTGAGAAACAGGCACTCTTGCCTACTGTGTTTCCCTATAGGGCCAGTACAGTGA
GCTAGCTCAGAAACAAAGAAGTGTGCTTCCCTAAACAAACGGGGCATATCTAGTTCAACTC
AGTATCAGAACTAAGTAAACAAGAGCTTCTCTACAGTCCAATACACTGCACTCGCTAG
GAACAGACAAGAATGCTATTTGCACTGTGTATGGACAGAATAGCACAAAGAGTCGCCTTCT
TACCCTGAATGAACACTTAATGCTAGAACTTAAACTGAATGTGA
>petromyzon_marinus
GTGAATAGCAAAAAGCATTCAACCCATAATACATGTTTTTAATTGGTTCGAGCGTCCATT
TCATATCCCATAGCTTAACCACTCATATCTTTGCATTCCGCTCGATGAGGCGAGCAGTAC
GAGTACCACCTTGATGGGTCTCCGACGTTTCCCTCCAGAGTTATTACAAAAACCACAAA
CATCCCAGAATCCTCTCGATTTGGGGTCAAAATGTTGTGCTCAATAAACCCATAAGAA
ACGTCGCATCGAATAAATGTGATTGAATTTCTCCCGTCTGGACGAGCGGGATTGAATGGT
GCAACTGATTTTGTGCTGTGTTAAATAAGATATTTGCATGACTGCTTTTGTTTTATT
TT
>phlebotomus_papatasi

GCTCTAAATGGATGTAAAGTTTGAGGCCTCTATCTCTCATAGTTTCCGAGATAATCAACT
TTAAAGATTTTTAGACACTTTTATGCATTTCTCGTCCAATTTTCTTAATTTTCCAGTGAA
ATTTTGCACATATCAAGCCTGAAAGAG
>physcomitrella_patens
AGATGTAAGGTTGCCCAATTCATTTGGCAATGATGTCAAGCTTGAGCACCATTCTATATC
AAAGGTAGTCAA
>polychrus_marmoratus
AATACGTAGGAAAGAGAATGACCCTTTCTAAATGTATTAGGAAGGATATTGTACCTGTCT
CCCTTTAATATGTAGGAAGGAGAAGGTACCATTCTCATT
>pongo_abelii
CTCCAAATATCCACTTGCAGATTCTACAAAAAGAGTGTTTCAAACCTGCTCAATCAAAG
AAAGGTTCAACTCTGTGAGATGAATGCACACATCACAAGAAGTTTCTCAGAATGCTTCT
GTCTAATTTTTATGTGAAGATATTTCTTTTCCACCATAGGCCTCAAAGCG
>pongo_pygmaeus
TATGTGAAGATATTTCTTTTTTACCATAGGCCTCAAAGCGCTCCAAATATCCCTTTGCA
GATTCTACAAAAAGACTGTTTCAAACCTGCTCAATCAAAGAAAGGTTCAACTCTGTGAG
ATGAATGCACACATCACAAGAAGTTTCTCAGAATGCTTCTGTCTAGTTTT
>populus_balsamifera
GGTTGGCCGACCAGACCTCCTCGTCACCGAGTAGCGATTCCATAGCTACCCCAAGGAAAA
CGGCATCCGAAACTCGTGTAATAATTTGAGCGGATCCAACGGTCGGATCAAAGTTAT
GGCCCTTTTGACCCGTTACTCAA
>porites_lobata
GCCTCTAATTCATCGTTTTTCAGCTAGTCTTATGGTGCTTATCATCACAGCGACATTTGG
AGCTCTTACAGTGAAATTTCTACTTAACCCATTACGACCAAAGATGGTCAATTTGCAAA
ATACTGTACAC
>pristionchus_pacificus
AATCGAGTTATGATTTATGGAAATGATAGAAGCACCCTTGTTCACGTAGAACAGGCCTG
ACACCTCTTTTGTATCAAAGTGATACAAAAGATGAGTTCGCATGGAAGAAGGCCTTTGG
CTATGTGACCACCTAGCGCAAATGTCTTTCTAA
>procavia_capensis
ACACAGAGAATTCGAAGTATAACTACAAGAAAATAAGAGATACTAAGAAAACCTGGGAAAA
CCTACATTGCTGGTAGAGTGGGGAGTACTTAGCATTGTGAAAACAGTACTTTTCGCAGAAA
GAAATCTACTGCTCTAAGAAAGCACAACAGTGAACCGAGAATGTATGAGTTTCTTAAGAT
TGGTAACAGATAGAAACAAGAGAAAGTACACAGTGATTCTTCTACCCAGAGAAGTTACAG
AGGTTT
>prunus_persica
GACCCCTCCACAATATTATGATGTTCCCAAGTTTTGGACTCAATCCGATATCGATTGG
TCCATGAAATCGGACAATTCAGGTTTCGTACGAAGTTTCGTTCTGAAATGGAGTGGTTGGTG
TATTGTATAGTTCTAGACATTGGATTTCACTCAAACCCACCAAAT
>pteropus_vampyrus
CTATGAATGTAATGAATGTGGGAAAACTTTTGCTAAAATTCACACCTTAGTGAACATCA
GAGAATCACAAGGGGAGAAACC
>rattus_norvegicus
AAATTTTAAACGAACGGAATCTAAGTATCTTGGTGAATTCAGTTAGTTCCCAATAGGACGC
GCTTGTAAATAAGTGTACTTTTCAAGATATAGCA
>rhamphochromis_esox
CTGTAACTTTTGATAGAAGACTCAGACAAACATGTTTATGGCTTTATCTTATAGAACTCA
ATGTCCCCGTGCTGGGAAAACAGGATTTGCAGCTGTTTGGCTAAGATTTTCAAGTTATA
CACATAATGAAAACCTATACTTTGTTTCGGTCGAGTTCCCAATCAAATGCATGTAACAG
TGAGAAACGCCTGTCTTGGCGAAAGAAAGCGTTTTTGTACAACCTTCATAAAAATCG
>rhodnius_prolixus
TTTCATGACCCAAAAATTTTCAACCCTTTATATCTTCTCAATTTATGGATCTGTACACA
AATAAATATAGCTTATAACTGAGGAAAACAAAGTGTATAAGAGAACAAAATTTTCATACG
AATATGTTGTTTACAGAGGAAGATATAGAGTGGCCGTAATTTTACAGGA
>ricinus_communis
TATTTGTGAATATGAGAAAACAACCCCGTAAAAGGGGTA
>saccoglossus_kowalevskii

ATTGCAGAATACACCAGTTCTCGTCCGATCACTGAAGTTAAGCTGCATCGGGCGTGGTTA
ATACTTGCATGGGAGACCGGCTGGGAATACCACCTGCAGTAGCTTATCAACATTTTTATT
CCACCGTACATAACCACTTTTTCCCGGGATTTTTGCCTAGCCGAAGCGTTAAACGACAT
CAATTCGGACGAATATTCAGCCTACTGCCAAACC
>salmo_salar
GAAATTGCACTATGTTTTGGTGGGGACGTGTCCGTAGCATTTGGGTTACCAGGGGTGAAA
TTTTACAACGTTTTTAAATACTTTTTAAAGGCCATAACCACCCCGAGACACCCCTGACAG
CACCCACTACGGGCCCAAGTCAATGGGAGCAAGAATGACTGATTTATGGAAGTTTGAAA
AAATCCTCAGAAAATATTCTATGTTTTCTTCTCAGAAAATCGGCTATGTTTTCTTCTC
A
>schistosoma_mansoni
CTATGAAAATCGTTGTATCTCCGAAACCACTGGACGGATTTTTATGGTGTGTTGTTTTAGA
TTATTTGCGAGAGTGTGGGCGTTAATATAAAAACAAGAATCATCTCAAATCCGACACAGCC
GTT
>schmidtea_mediterranea
GACGAGCCCGTTATGATTTTTGCAATTTTTAAAATGCTATCATGTAGAGAATCAAAAGTT
ATCGAGAAATATATCAAAGATTATGAAAACAAATAAATATTGACAGAGATACAAGCCTAT
AAAGATTAAAAAATTTCCGTCCAGAATGACTTGTGTTT
>selaginella_meollendorffii
ACATGCACTGGAAGTCTAGCTGGGGGTGTGGAGCCGGGCACCCGAGGTCTGACCTCGGCT
GCCCAACACTCGCATCCCCACTATCCTTCCAGTGCTCACGGCCTACCACGCCCCAGGGA
GACAAGCGCTTTGGGCTTTACCCCCACGTGTCCATGTCCGAGCCGGAACCCGAGTCCGA
GATGGAGCCCGAGTCCGACCCCGACATGGTGCACGCGGGGAGGAGCCAGCAGCAGCCCG
C
>setaria_italica
AAATGCACCTGTTTTGCATCGTTTTTCGTGCCGGAACCGAATGCTCAAAAACACTCCCAA
ACATGTTCTAGGGTATAATTAGGAAGATTGCATGCGTTCGTTGCGAAAAAATCCACCCGA
GTTTCGCTACCCGAAAATAGTGCATTCGGGTGCCG
>solanum_phureja
AGATCACCAAAAAGTCCATGGACTATAGCACACGAAAATCGGCCAAAATTGGGGTTTTACC
TGCTCTGGGGCACATTTGACCTTCAAAAATGGGATGTTTTGGCCGTGAGGGCTAACTGGCT
CCATAGCTAAGGTCTTAACGGACGTCCATGAAAATTTTTGGCAAAAATTATGTCGGAATT
CC
>solanum_tuberosum
CGTTAAGACCTTAGCTATGGAGCCAGTTAGCCCTCACGGCCAAAACGTCCCATTTTAAAG
GTCAAATGTGCCCAAATCAGGAAAACCCCAATTTTGTGATTTTTCGTATGCTATAGTCC
ATGGACTTTTTGGTGATCTGGAATTCGGACAAAATTTTTGCCAAAATTTTTCGTGGACGTC
>sorex_araneus
CACGCATGCGCAGTGCCTCTGGCCGC
>sorghum_bicolor
GAGATAGTGTTAATCTTGATGCAAGATAGGTGCACGGTTTGACGGAACGCACCATAGGC
TAAGAAACCATTTTGGACGCACCCGATGGAACCTCTAGATGAAGTGTGTCAAATGGAAGC
TCGGTTCGGTCTGTTTG
>spermophilus_tridecemlineatus
CTAGCTCTTTGAACTTGACACAATAAAGCAGTTTTCAAGTTCTATCTCTATGGTTTTGTTT
GCTGTTGATGTAGCCCTAAGCAGAGACTGGCGAGAATCACTTTCATGGAAAGGGCCTGCC
AAGCTCCAAAAAACTACGAGTTGCCGTGAAATCTCAGCAAACACTTTTTACCCAATCTTG
ATGATACTTCAGGTAATGATCAGTACACCAATCCCCTTGGCTCGCCAAAATTTGTTCTT
CTAGGTTAAACCGTTGTTGAGTAACCGTTTTCATTTTGAGGTTTCACTCTGTTTTCTC
CTATAGGGATACATGATTTGGAACCTCAAATCAAACACGGTTTTGTG
>spirodela_polyrhiza
CACCAATTGAATCTGGAAGATATTGTAATTTTGTACTTGACAAATTAAGATATTCTAACT
TTATAAGTGATCCAATAGTACTTGAAGACTTTGTAATTTTGTGTTATGACACATCTAAAT
GTCTTAATTTTACAAGAG
>strongylocentrotus_purpuratus
TTATTTGAGCGCATATCAACCAATGTGCCAGAACAAACCTTAACGTTTAGCGCATATAAC
GTCCAGAGTATATAGAAGGGGGTTGGGGTTAATACATTCGTTGCTGATTTCCCATTTGCT

TTAAATGTGCTGAAACTCACATGAAATGTAGATTATTATATACCTCACCCAATACGTGGT
GCAAAAATTCTAGCAGCTGACAATAAAAAGGTC
>strongyloides_ratti
AGAAGCCTTTTTAGGGTAAAATATGTGTTGCTGAAACCATAGGAAAATGAAGATTTAGAA
GTCTAACAATGAAACCATTGTAATCTACATGAAAAATTAATCTAGAATCAACTTTTTTAT
TTTAATATATTTAAAGTCATTGATACATAACTGAATCTTTAATATAAGTTAC
>taeniopygia_guttata
ATGTTTGGCGCTCCGAGTCCTGTGGCCCTGAGCCGGCAGCTGACTGCAAAAAATCCGAACA
TCGAAGGATAAGTCCCAGACAGGAGCTGCCCCACCTCATACTTGTGCTGCCCTGACAGT
CCCAGGGGAGCCCTACAACTGACATCAGGAACCTGGACTGGTGAGTTTTCTTTCCCAGG
AAAAAGAGCCG
>takifugu_rubripes
TGCATTCACCTCTGTTTTGACAAAAATGTGTCTCCTGACCAAAAGTGATGGTTTTCCCCAC
GAGAAAACGTCAAAAACGTCAATAATGTGACCGCAGCATGAGTTTTTCAGATGATCATGT
>tarsius_syrichta
TGACTTAACTAGCTAGCCAGCTGGCTAGCCAGCTGACTTAACTAGCTAGCTACCTAGCTA
GCCAGCTGGCTAGCCAGCTGACTTAACTAGC
>teladorsagia_circumcincta
CACCTTCGGTCCCCACCAAATATGTTCCCGTCCCACCCCTACATCACTTGTTGGAACC
AACGCCTCACCGCTGCTGGGACGCGTGCTATGAATTTTCGTGAAATTTGCATTCCAGCGCC
TCTTATCGGCTCTTATCAGCCGTTAT
>tetranychus_urticae
CCAGCATTTACTTTACTCAACTATTTGTCCACACATGCAAAAATTTGATATTTGATGATTC
ACCTTGATAAGCTTTAAAGAGTGATGTCCAGAAAAATAGTCTCACGCGAAAAATAATTTTA
ACCTTTACTTTAACAGTCAAAAGTTTGAACAAAAATCCAAAATTTACACTTTGA
>tetraodon_nigroviridis
AACACTGGAAATCTGTGTGCTGCATTACATTTTGTCAAAAGTGAGCTTTTTCTCGCCGAGA
AAACGCTGTTTTTGACAAAAATCCATCATTCTGCACCAAACGCAGGTGCCAGAACTGAA
>tribolium_castaneum
TTGTCAAAATTTATCGAAACCAAATTTTCTTCATTATTTTTCAACTATTCGGAGTTATGT
CCTTAAAATTAAGTGTTTCTAACGTAAAATGACCGGCGAAATCCAAATTTGCAAGAATCA
AGTCGCTACGACTAACCGTTCTGAAAATATCGGCAAAAATTTAGCC
>trichinella_spiralis
AATATAGTTAAGCATTGTTAATCATTGCATTTTCAGACCGCACCAAGGAATATGAGCGGTT
TATCGGTATGCAAACTCTGGTAAGGAGTTACTCTTACCAATATTCCGGATTTCTACCTGT
GTTTCTCCCCACAGAAGTCAGGTAATGGTTCCCTCTCTATGGCCTGTAATACTATCT
>trichoplax_adhaerens
GGATGATTGTCACCAAGTGTTGCTAGTTCAATCTTGAGTGATTTGTTATACATTGATAGA
GCATCATCATACTTGCTTGATTACAATAGACAAGTCCAATGTTGTTATATGACATAGCA
ACATCA
>trichuris_muris
GGTATCGGCGAAAACGACAGCCATCATCAGTCGACCAGCACGAAAGCAGAGCGCACAGGA
AAGATCGGTTGTGTTTAGGTCTAGGCTTA
>tupaia_belangeri
TTTTGGCTGAAAATCTACATGCTTATCTCACGAAAGTAAGCTTCATTTCAAAACGTCCAA
TGAAATACACTGTAAAACCTCCTTCCAAAACGAAAATGAAGTAGAGCAACTGAACAT
CACAAGTTGTTCAAGTCCTCAGTTAAGTAAGTGGAACAACACTAGTTGCTGTAGTTTTTTTA
ACATTTCTTGGGAAGAGGGTTTCTTAGTTCTAGTTTGCTTTGAAAGTGAGTTCAATCTT
AGGCCAAAACATAAATCCAGCTACTACAAAAATCTTTAGGTGTGAAAATAAGCTCCAT
GAGTGGAGTCATGCTGCCAAAGATCTTTCCGACATTCCAAGGAAAAGTACAGA
>tursiops_truncatus
AACCAGGCAGGATTGACCTCACACCAGAGGGCCACATCACAAAGGGGATGGG
>vitis_vinifera
AGTACCGAAAAGGGTCAATCAGTGTGAGTACCGAAAATGGTAGAATCCGGGCGAGTA
CCGGGAAAAGGTAGAATCCGTGCGAGTATCGAAAACGTCCGGGCG
>volvox_carteri
CACCACCCGCGGCTTCTACTAGTGCAGTAGCCAGGCGCGCTGTGTCCACTGTCTTAGTA

GCCGCGGCGCTGACGTGT
>xenopus_tropicalis
GAGATATGTAAGTGTCCCTGGGCTGCAATGGTATCTTCCAGCCTTTGCCAGGCT
>zea_mays
CTTTAGGTCCAAAACATGTTTTGGGGTGATTTTCGCGCAATTTTCGTTGCCGCACGTCACC
CATTCCGAAAACGGGTATCGGGGTGCATACAAAGCACGAGTTTTTTGCCACCGGAACAATT
TCTTCGTTTTTCGCAACGAACATGCCCAATCCACTA
>Jatropha_carcus
CCCCAAATCGTAGGTATACCCCTTTGGTCTTAGGAGCCCTGTGTGAAGCCCTGTTCCGGA
GCCGATATCTTCTGTACGCCTGTATGGGAAGCTCCTATAGGCTCATCTAGGGGATATTTTA
GGGTCTTATGGTCCAATTCGGTATGCCTATCTCGGCTGTTCAATGCTTCATTAAGGATTGC
AAACTCAATATAAAATTAATGCGCAAAATCGGTGCCACTCCGGAAGCATTTCGCGAGTTTTTA
GCCCAATATCTCTGTCTATCGCTTGTCAAGCCATTCAAGGCCATAATATTTCTCTAA
GACATATAGAAAGCATTGTAATCATTTTTCGGGCAATTCGAGCCGGTGCTTCCGGGC
>Mus_musculus_castaneus
GAAAAATGAGAAATACACACTGTAGGACGTGAAATATGGCGAGAAAACGAAAAATCAT
>Bos_taurus_taurus
AATGGAAGATTGGACTTCCCTGGGCAACACAAGAAGGCCATCACTGATTTCCCGTTTCGTA
ACTCGAGATTCCGCGCCAAACTCGAGACACCAACGTGGATTCCCGCGTCATCGCACAAAG
ATTGAAGCCCTTTCCGCTACAGCGTCTCAGGAGAAGTCCCACGTTAGGAATTGAGCGGTG
GAACGGTACTTGGCACCCCTTACGGCGGCCCCACAAAGTTCCCGGCATCCCGTCTCCCT
GGAGAGGAACACCGAGTTTTCCGGCACCCTTCTCTGAGCCCTTCTACCCTCCTGATCT
CGACAGGGAGGGTTCGACTCCCCTGCTTTGTCTGGAAGGGGTTCCCGACCTTCCGGTTCGCA
CCTCAGGATGAGGCCGGGCTCACGACGACATTCCAGACGTGGCCTCGTGGGTGCTTCCAC
ATTGCGAAGCACCCCGATTTCCCGGTCCCCTCTTGGTAAGAACCCGATGCCCGGACACCT
CTCGAACTCCACCCTGTGAATGAGGTCAACACGAAGGGGCAGTGCCCGCCCGTGCATCGT
CCGGAAGAACCCCGAGTTCCAAATACAGCTCGACAAGTGGCCTCTCTCCCGGGGACA
CCTCGAGAGGCAAGCGGAGTTCATGCCTCAACCAAGACGAGGACCTGACTCTCCTGTCT
CCCAGTCTGCAGGGACCCCTGCGATTTCGGAGTCTGAAATCAGAGGAACCCCTGAGGTTCTGT
CCTCACTGAGAGTGGAGGCCCTTCCCAATGCACCAAAACCCCGTGGAGTCCCGAGAGG
CCCCTCCACCTCCAGTTCCGCTGATTCTCAGAGCCCACCATGAGAAGCCCCCTGAGGTC
ACCTGCACAAGTGCAGGGAAGCCAAGGGTTCCCTGCCTCAACCCGAGAAAGACCTCGAGA
GACCTTCTTCAACATCGTCTCGAGGCCAGGTTCCCTACCAGGACTCGAGGGCAATGACGC
GCTCCCCCTCGCCACTCGCGTGGAGACCCGACTTCCCTGGCGCCCCACGAGAGGCTCACT
GACCTCGCCGTTCGACCTCGTGAGAAACCGCACCCCTGGGGCCCGCGGCTCGAGAACCACC
CGAGACTCCCGGTTCATCGCGGAGATGAGGGCCTTCGTCTCCTGCATGGGCCTAGAGCCA
ACCTCGCGACCTCTCTCCAAACGCCTCAGGAGGCTGACTCCCATTTGTCCACCCAGTGGGA
GCTCAAGAGATACCCGTTCGCGACTCGGAGGCAGAAAGTTGGGTTTCGTTGCTTCCCCTCGA
GATGAATGCCTGTCTCCCGGGTGCCTTGGAAATGCCACCCCGAGTCCCGGTTCGCCCCCT
GGAGAGGAACCTCGGGCTTCTGGGCACAAGCCTAGATGAAGGTCTATCAGGGCCTGCAAG
TCACTCTGGAGCAATCCCCAGCTTTTCTTTTCGCAACTCG
>Mus_musculus
AAAACGAAAATCATGGAAAATGAGAAATATACACTTTAGGACGTGAAATATGGCGAG
>Mus_spretus
GTGTATATCAATGAGTTACAATGAGAAACCTGGAAAATGATAAAAACGACACTGTAGAAC
ATGTTAGATCAATGAGTTACACTGAAAAACAAATTCGTTGGAAACGGGATTTGTAGAACA
>Oryza_sativa
TGCCAATATTGGCATTAAATTGACAAAAGTTTCGCCGCGCGAATCACGAAGTGAATTTTTTC
CACGAACGCACCCAATACACTCCAATATGTCCAAAATCATGTTTTGGCCTTTTTGAACT
TTTTCAATCCGGTAAAAACATCGCACCCACGTG
>Sus_scrofa
CGCTGCATGGAATCCACTGCATTCAATCACGCTGCATGGAATCCACTGCATTCAATCGGG
ATGCATTTTACCATGCTGCATGGAATCCACTGCATTCAATCACAATGCATGGAATCCACT
GCATTCAATCAGGATGCATTTAAGCCACTGCATTCAATCGCAATGCATTACCACGCTGC
ATGGAATACACTGCATTCAATCACGCTGCATGGAATCCACTGCATTCAATCGGGATCCAT
TGCGCCA
>Canis_lupus_familiaris

GATCGGAAGAGCGTTCGAGAATGATACGGCATAACGAGATCGGTCTCGGCATTCTGCTGAA
CCGCTCTTCCGATCTAATGATACGGCATAACGAGATCGGTCTCGGCATTCTGCTGAACCG
CTCTTCCGATCTTCAATGATACGGCATAACGAGATCGGTCTCGGCATTCTGCTGAACCGC
TCTTCCGATCAGATCGGAAGAGCGTCTGTAGGGAAAGAGTGTAGATCTCGGTGGTCCG
GTATCATTA
>Sacrophilus_harrishii
CTTCAATAGAAATCAAACCTTTTCCACGCATTTCTGTCCGCATTGGGTTCTAGATTATTT
TTACGATCTCCAATCCAGAGAACATTTGTTCTAGATTTTTTTTAGTCTCATTTCATTTCCGG
AATCTTTTCTGGAA
>Gorilla_gorilla_graueri
AACCTTTCTTTTGTATACAGCAGTTTGAAACACTCTTTTTGTAGAATCTGCAAGTGGATAT
TTGGATACTCTGAAGATTTTCGTTGGAAACGGGAATATCTTCATATAAAAATCTAGACAGAA
GCATTCTCAGAAACTTCTTTGTGATGTGTCTCAACTAACAGAGTTG
>Mus_famulus
CACACTGTAGGACCTGGAATATGGCAAGAAAACCTGAAAATCGTGGAAAATGAGAAAAT
>Gorilla_gorilla_gorilla
GAAAGGTTAAACTCTGTGAGTGGAAACACACACAACACAAAGAAGTTACTGAGAATGATTC
TCTCTAGTCATTAGACGAAGATAATCCCGTTTTCCAACGAAAGCCCCAAAGAGCTCCAAAT
ATCCACTTGCAAACCTCCACAAAAGAGGGTTTTCAAACCTGCTCTGTCAAAA
>Echinococcus_multilocularis
ACCAAAAAAACCAAAATCTACTCGAACTACTCCCAAAGTGACTAAGCCTACCGTCACC
>Mus_caroli
TATGAGTGAGTTGCACTGAAAACTTAGAATATAAGAAACGCACAGTGTAGTACATAGTA
>Hymenolepis_microstoma
ATCCCACACAACCACCTCAACCAAACCACTTTTAAACCTTATTACACCCCAATACACC
TATTCTTGCCATTTGCACCACCAATTTCTCTTCCATTTAGCCAAAATCTTCGATTCTTCC
AAGTCAACCAATTTTTTCCACCTTCGCCAATTCATCCCCATTTTTCTCCCAC
>Nippostrongylus_brasiliensis
ATCACTTTGGCACTGTTTCGCTGAGAAAACAAAATTTTCACTTGAACCGGTGTGTCTGTAG
ATGATCTTTCATGGGTCTGCCATGGAGAACATCTTCTGTAGGAGACTGTCCACGAAGTTC
AGCTCGTTGAGCAC
>Bos_taurus_inducus
AATGGAAGATTGAACTTGCCCTGGGCCAACCAAAAGGCATCCTGACTTCCCCGTCGTAAC
TCAGAATCCCCGCCCGTAACCTCGAGAAAACACAGTGGCTCCCCGTCATCCGCAAGATG
AAGGCCCTTCCCGCAACAGCCGGCCCTCCAGGAGAAGTCCCACGTAGGATTGGAGGTCGA
AAGGGCACTTGGCGCCCTTGATGCGACCCACAAAGTTCCCCGAAATCCCCGGTCTCCCTC
GAGAGGAACACTGAGGCTTTTCGACCCCTCCTCTGACCCTTTTCTCCCCCTCCTGAATC
TGGACAGGAGGTGCACTCCCCTGCTTGTCTGGAAGGGTTCCGACCTTCCGTCCACCTCC
AGGAATGAGGCCGGTCTCAACGAAGACCATTCCAACGTGCCCTCCGTGGGTGGTTCCCA
CATTTCGTAGGACCCCGATTCCCGTCCCCTCCTGGATAAGAACCCGATGCCGGACCACCTC
TCCGAACCTCAACCTGGAATGAAGTCAACACGAAGGGCCAATTTTTCCGTGCATCGTTC
AGAAAAACCCAGTTCCAAATACAGCTCGACAAGCCGGCTCTTCTTCCCCCGGGACCATCT
CGAGATGCAAGCGGAGTTCCATGCCTCAAACCAAAGACAGCCGACTCTCCTGTCCCAGTC
CTGCAGACCTGCGATCGGAAGTCTGAATCAAGGTACCCTGCGGTTCCGCCCCCTCAACTGG
AGATGAGGCCTCTTCCAATGCACAAAACCCAGTGGGGTCCCGAGAGGCCCTTCCCACCT
CCAGGTTCCCTGCTTCTCAGAGCCACCATGGAGAAGCCCCCTGAGGTCACCTGCAACAAGT
CGAGGAACCCAGGTTTTCTCGCTCAACCGAAAAGACCTCGAGAGACCTTCTCAACACGT
CTCTGAGGCCAATCCCTAACATGGCTCGGGAATCCAGTGACGCGCTCCCCCCCACCACTT
CGCACTGGAGAACCCGACTTCCCTGGCACCCACCAGAGGCCTCACTGACCTCGCCGCGT
ACCTCCAGTGAAGAAAACACCACCGGGCCGCGCTCGAAGAACAACCCCCGAGAATTC
CACCTCATCGAGAGATGAGGGCCCTCCGCCCCCTCAGGCCTAGAAGGCCCAATCCTTCC
GCGAACCTTCCAAAAACGCCTCAGAGCCTGACTCCCTTCGCGAGTCCCACCCAGTGGAG
CCCAAGAGATGAACCGTCGCTGATTTCAGAGCCAGAGCGGCCCTCTTTGCTTCCACTTC
CGAGGTGAAATGCCTTGTCTCCCCGGTGGTCTGAATGCACCCCGAGATCCTGTCCGCTG
AGAGAAAACAATTGCTTCTGCACAAAGCCTAGAATGAGTCTATTGGCCCTCCAGTACAC
TCGATGAGCAATCCCCAGCTTTCCCTTCGCAACTCCA
>Danio_albolineatus

TTTAAGCAAATTCTGTCACTTGTCTCTTTTTGCACTTACCAAGCTCTGAAAAGCAAGTTGC
AGAATTCTAGGAATTGACAATTATGAAACATTATCCTTTTTGCTTAATTTTCACTTGCAAG
TTGTTAAACATGCTTAATACAGCATGCACTGTTGTTTTTAACTTAAAGAATGATGATT
TTCCTGT
>Danio_nigrofasciatus
GTTTAGAGGGCCCAGAACAGAGAGTGATCAAAACAAAAAGAAATGATGAAAACCATCATT
CTTTTTGTTTTGATCACTAACAGTACAGGCAACTCTAAACACGCTTTTCAGAGCAAGAGA
AAGCTGAAAATAAACAGTATGGCAAACCTCAGCCAGATCTGCTGATTGTCACTTGCAACTT
ATTA AACAC
>Echinococcus_granulosus
CACCCTCAAAAATAACAAAAACAACCAACAACCTAAAAATAAGTAAACCTAAAACAATCC
AAACTAATCATAGCACAAAAAACCCACATTTCATAAGAACTA
>Caenorhabditis_elegans
AAACTGAGAATTATGGAGAATATGGAAATTCAAATGTGCACTGGTTTTTCAAATTTTTT
>Ailuropoda_melanoleuca
TGAGTAAGGGGAGCATGAATGAAAAAGTTCAAGATTTTTCGAGGACTCAGCGCCCTTCTCAT
TGTAATAAAGCAGAGCGTCCAGGAAAACACCTCCAGCGAACAGCAGCCTTTTCACTGGG
GACCCCGATTCCACATTGGGTGTAGGGGCCTGGGGAGGATCCAGCCCTTAGAACCAAGAA
ACAAAGTGTGAGGGGAAAGCCCTTGAAGTCACGACGGCCTTATGGAAGGTGGAACAGGAA
TCAAGGTGCTTTGGTACCGTGAGTGAAACACGACGAACACAGCACTGAGAAAGACAATTC
GGCCAAAACCCGCTTCCAACGAAATGTTTGCTCCCTGGGGAAATCCTGTCAAACCTGCTG
GCGGCAATGGAACGAAAAGGCCCAAAACACGTCCGTGAGAAACAACACCGTACAGGGACC
GTCTTAGCACTATCATCACCTTTCGTGAATAGGGAAACATGAGGGAAAGTGGTCGCGGAA
GCCTGACGAGAGTGCCCCATAGTGGTCTCTGAGACACCACACAGTCCAGGGAAATATCAA
CGATCATCATCTCTCG
>Bombyx_mori
AGTGACCCCGATTCCCTACA
>Glycine_soja
TTTCTCGAGAGCTTCCGTTGTTCAATTTTCGAGCGTCTCGATATATTATGCGCCTGAATCG
GACATCCGAGTGAAAAGTTATGACCATTTGAA
>Drosophila_melanogaster
TATTC
>Drosophila_albomicans
AAAATTTTGAAAATAAAAAAATTA AAAAATTGGG
>Bombyx_mandarina
CCACAGTGTACGTCCACCACATAAGTA
>Bubalus_bubalis
CCCAGCAAGCGCCTGCCAGACTGGGCTTCCCTGGAGCTCTCCCCAGCGTAGAGTCGTGT
GGATGTGGTTTTGGGGCCTTCCCCGGTGCCTTTGGGCTAGGGAGAGCACAGCCCCAGCGCA
GGGGAACCAGTCCCTGAGCAGGGAGCTCCGGGCAAGTGCTCTGTGCCAGGCCTGGAAGC
CCGGTTCACAGCAGCCGGAGAGAAAGAGAGGGGTTGCGGGCCTGTTACTGGGGAGGACC
GAGCGAGGCTGCCAGAGCGGCGGAGCTCCAGCTCTGCGCGCCCAGGCGCGATAGCGCAGA
GCCCCGGCCGAGAGGCTGCTCTGGCCTGGGCGAGCCTCGCCCAGCGCTCCCCAGCTTCTA
GCGTTCTCGCACCGGGAAGGAGCAGGCTGCGGGAGTGGGGGAGACGTGCCTGGCGCCTGG
CTGGCCTCAGCTCCGCTCTGGCCTTCCCTTTGGACCTAGGAGCCAGGCCTCTTTGCAGAA
GGCTCAGGGGCCGGGGTGTGCAAACCTGCCAAAGCCTCCCGCAAGCAGAGCTCTTTGTCA
GGCAAAGAGAGCGCCCAGGGCTGCATTTCCAAGCGTTGCTTGGCCGCCAGACCTAGCG
CTGGGCGGAGGGAATCAGGGTCCAGGGCCCCCTGGCTGGGGGAGGCAGCACCCACAGCCAGA
GGGAACTCCGTTTGTG
>Onchocerca_flexuosa
AGGGGAGAAGAATACGAGGAGCAAGAAAAAAGCAAAATACAAAACGAGGAGAACACAA
GGGGCGAAAATCAGAGGAGGATCAAAAGTATGCCACTACGTGGAGTAAGAGAAGTGTGAA
AAACCCGAGGCGAAGAAAC
>Ficus_fistulosa
AAAACAAGCTTTGAGAATGATCAAAACACAAAAAACAGACCCAATCTGGTTTGGGTCA
AAAAAGTGGCAAATTAAGCCAGAATCAAGCATAAAGGGACCAAATGAGCAAATCTCAG
TTCAAGGCAAAGTGGATCATCTAGGCAGCCCCCTAAATGACC

>Capra_hircus

TCCCATCGAGGCTTGCCACGGGGCCTCTCGGGATTCTCTCCCGTCGATGCCGGGGCCT
AAGACCTTGTGTGGAGTCGGTGCCGGAACCTGAGGATTCTCTCCAGTGCAGACAGGGAT
AATGGGGTTCCCTGGAGTCGCCTCAGGGGATCAGGCCTCCTCTCGAATGGTGGCACGAAC
CTGGAGTTCTCTCGCCTTTCTGTGGAGAGCGCCTCCTCTTGCATGCGACGGGAATCC
CGGGAATTCTTTCCCTCCACGCAGGCACACGAGCCCTCCCCACGAGCTTACAAGGCGCAA
ACGGGCCACCTCTGGATGTGAGCGCGACCCTCGTGCTTAAACTCGAGTGCAGACAGGGAA
AACAGGGAACCTCTGGAATGGCAGCAAACATCTGAAGGACCCTTGGGAAGGTCCACACGT
AACCTGTGAGTAGCCTCGAGACGCCCCAGCGGAAATGCGCCTCATCTCGACAGGAGACGA
GAACCGCCGGGATTTTCCCACACGCGGAAGTCTCTCGACCTACGACGCGGACAACAG
GGACCCGCTCTGGTGGCCCGAGGAAACGCCAGTCCCCATGCGAGTTGCACACGGGCATCT
CGGAAACCTCTCCAGTCGAAGCAAGGGCCTAAGACCCTGTGTGAAGTCCCAGACGGAAC
CTGTGATTACCTCCAGCGCTCACACGGATAATGGGCCACATCTGAGTCTCCCCAGGGGA
GAAACTCCTCGTCTCGAGTGGCGGCATGCGTGCCTCGACTCACGAGCGGGAACAGCAGG
GACACGCTTCCCGTCGCTGCAGCAAAGGACCAGTGC

>Lithocarpus_balanseae

GAAAAATATTTCCAGCCAAATTCGTGAGCAAAACTTCAAACCTTCCCCTTTTGGAGCCCTT
ACATCGGCACGAAATTTGGAATCCAAATTTTCGGGTAACCTCGGTGGCCACATTCAAACGAG
GATAACTCTCCCGATTTTTATCAAAAAAATACAAAATTTGTGCTCAAATTCAGCTCAGG
ATGTCTACTTTCTAAAACACGAAGGCCGCGTCAAAGAATTCCTCACGGTTCAAAGTTAT
TGACGAAACGGTGGCCAAAGCACACTTTTCGTACACTTCTAACCATTAAACGCCCGCG
GATAACTACCCACTCACGATTTTTTTCCCGAAACTTGATTTTTGGGAAGATTGATCTCGC
GATATAG

>Lithocarpus_grandilofolius

CCGAAACCCAAAAATGACCAAAATACCCCGAAACCCAAAAATGACCAAAATACCCCC
GAAACCTAAAAATGACCAAAATACCCCTCGAAACAAAAAATACCCAAAATACCT

>Lithocarpus_hancei

AGACTTCTCTTTTGGAGCCCTTATATCGGCACAAAATTTGGAATCCAACTTTTCGGGTAAC
CAGTGGCCCATATTTCAAACGATAATAACTCTCATGATTTTTGTGCGAAAAAATACAAAAT
TGTGTTCAAATTCAGCTCAGGACGTCTACTTTCTAAAACACTTAGGCCGCGTTAAAGAA
TTCCTTTTCGGTTCAAAGTTATTGACGAAACGGTGGCCAAAGGTCACTTTTCGTCTCATT
TCCTAACCATTAAACGCTCGTGGATAACAACCCACTCACATATTTTTTTCCCGAAACTTG
ATTTTGGGAAGATTGATCTCGCGATGTAGGAAAAATATTTTCATGCACAAATTCGTGAGCA
AAACCAC

>Lithocarpus_xylocarpus

TTTACGCCTTTATATCGGCACAAAATTTGGAGTCCAAATTTTCGGGGAACCTCGGTGGCCAT
ATTCAAACGACAATAACTCTCTTGATTTTTATCGAAAAACACCAAATTTGTGTTCAAAT
TCAAGCTCAGAATGTCTACTTTCTAAAATATTAAGGCCGCGTTGAAGAATTCCTACGGT
TCAAAGTTATTGTGCGAAAGGGCGACCAAAGGTCACTTTTCGACACATTTCCAAACCGATG
AAGGCTCGTGAATAACTACCCACCAAAGTATTTTTTACACAAAACCTTCACTTTGAGAGGA
TTGACCTCAAGATATAGAAAAATATTTTCATCGCCAAATCCGAGAAAAAACCTTAGACA
TCAATG

>Lithocarpus_calolepis

TTTCGGGGGTATTTTGGTCAATTTTTGGGTTTCGGGGGTATTTTGGTCAATTTTTGGGTT
TCGGGAGTATTTTGGTCAATTTTTAGGTTTCGGGGGTATTTTGGTAATTTTTTAGG

>Castanopsis_echinocarpa

AAAATTTTAAACACATAAATTCATTATTAATTAATGTTAATGTCAACCTCGGCTAAGCC
AGGTCTCGACCTTCTGCCTTGGGAAAATTTAACATTCAATTTATTCAATTTTTTAAGTG
TTAAATGTCAACTGGGGCTACGCCAGGTCCTTATACCTTCTGCCTTAGG

>Castanopsis_indica

GCTGCCAAGGCCAAGGCATGCAGCCAAGGCCAAGGCAGCCCCCATGGGCGT

>Ficus_altissima

TATATATCAATTTCTAAAGCCTATAGCCTTCTCTAGCAACAGAAAATTTGGTTCGGGCTCAA
AATTTCTACAAATTTAAATCATTAAACATGCTCTAAACATAATTCTAACGATCCACTTT
AAGTCGAAAAACACCTTCCGGATCACGATTGACGATACTCA

>Ficus_langkokensis

TTTTGCTGGTTTCTTGACCCAAAGTTGTTAGGATCTGGTTTTTTGTGTTTTGATCCTTGT

CAAACCTTGTTTAGGTCATTTACAGGCCACCTCACTGGTTTACACGACCTTGATCTGATT
ACATTGCATTTTGGGTCATTTTTGCCTCATTTCGGGCTTGA
>Trigonobalanus_doichangensis
GGACAGACCGAATAAGAGTGAAAACAAAATTTTCGCACCGGGATCAGTTCTGCCCAAACCG
TGCCAGACATTCCTTAATAAATATTAATAAATAGAAATAAAATTTGAAAAATTAATAAAT
ATAATACTTGCATCATTCCCTGGCCAAACCGGGCCG
>Myzus_persicae
TCATTTGGTTGAATAGAACCGGAGAACGAGAACTTTGAATATCCCAGAAATTCGATTAATT
TTACCCATTTTCAAATTTGTCTCACGACCTGTGTATTTGGGCTAACCAAGTCAGAGTGGT
ATCAAAAGAAAGCTATTAACTTCCTCTTGAGTTTGGTGAAGGTTTGAAG
>Ficus_microcarpa
AAAAGAATATGCAGATGAGGAAAATAGAGGAGGTTAAAAAAAAAAAAAAAAAAAAAAAAAAAA
AAAAAAAAAAAAAAAAAAAAAAAAATGGTTGTTGTCCGAAATCTTCAATACTGTAGGGTTAACT
AAGTTTACTAGGTACTGCTAGAAGACGAAATTTACTTCGGACTACTACTCCTTTTTTTTTT
TTATCGTTTCGGACCGGTGCTGCAAATCTGTTAAAAAAAAATCCAGACCATC
>Ficus_tinctoria
TACCATTTTTAGAACACGGTCAATCCCGTTATGACCGTCTGTTGGGAAGAATCGAGAAAA
ATACAAAAAATCATTTTCGGGCCATTTTTAACACACGGTCAAAACCGTTATGACCGTCT
GGTCATAACAGTTATGACCACAAATGGAAAAAATCGAAAAAATACAAAAAATCATT
TCGGGCCATTTTTAACACACGGTCAATCCCGTTATGACCGTCTGGTCATAACAGTTATGA
CCACAAATGAAAAAAGCGAAAAAATGAAAAAATCTATTTT
>Anas_platythynchos
ACAACCTGAACTCCCCAGGGGAGCCTTTACGCAGCCCCACATGCAACTGGACCCTCCGGGT
TCGCTCTTTTACAGCAACCCTAAATATAGCCCTAGCCGCATGGCAGAAGACTGAAAAATC
GGGCCCCAGAAAACGCGTTGCAAGCCCCTTTTCGCCCATCCAAAAGTGCCCCAAAGGAAG
GCTTTGGGT
>Harpegnathos_saltator
TATCGAAGGTTAAAGTTTTCCAAGCTTTCTCCGTCGATATCTCCGCTTCTACTGGGAGTA
GAGAGTCGTCACTTACTCCAAAATGTAGGGTTTTGAAAGGACTTTAATTTGGTACCAGTA
CCAAGCCTGTATCTTAACCGTTTAGGAGA
>Camponotus_floridanus
AAGCATTCAATTTCTAGTTAGTTTCAGTAGTTTCGCATCATCGCATGATATCCCGGAAAAAAG
CGTTTAATTCTCGTTTGTACGTCGTATAGGCGTGCGTTATTCGGATTAA
>Linepithema_humile
TTCTTCGTATGTTTCTGGTCTCAAATTAATTTATAACTTCAGTACTATCGAAATATATAG
GAAAATGAATTTGTTGCTCGTTTTAAAGTATCGAGAAGCGACACTGTGTAACAAATTCA
TACAGCACACATTAGAAAAGTTATAATAGTAAAATAATTT
>Carica_papaya
GTCCGCAGGTTTTATTTCGCAAATGTGAGTCACGGCGCCGGGGCATTCTTACTTGATATTAGA
ACGAGAACGAGAGGTGCAGTGTGCACGCACAAGGAAACAAATGACGGGAGGGGGAAGAAA
GGAGAAGGAGTGTATGATTTGCAGCGCGAAATTAACAGGTGCGATCATACCAGCACTA
ATGCACCGGATCCCATCAGAACTCCGCAGTTAAGTGTGCTTGGGCGAGAGTAGTACTCGG
ATGGGTGACCTCCTGGGAAGTCTCGTGTGACCAATTTTTTTTTTCAGATGGGTGCTTCC
ACGTTACGCGGACTGGAATTATG
>Boechera_holboellii
AGAACCTTGTTCTAGAAGGATAAATTAGTAAGAACCTTGTCCGAGAAGGATAACTAGTGAG
AACCTTGTTCTAGAAGGATAACTAGTG
>Mimulus_laciniatus
ACATAAGTAAAAGTACAAAAGCATGCACAAAAGTACTCACGCAAAAAGTGCAATTCGCAAAA
AGGATCATGAAAACACAACTACAATCCTAGGACATTAATACAAATCAACAAACATGCAC
AAACACACTCCCTCAAATGGACATGCACAAACGTACATGTAAAAAACATGCGCAAAAAGT
GCATCCGCAACAACGTTCTTAAAAACACGAACTACAATACTATGACTTTAATACGCATCA
ACAAACAACAGCAAAAACACTAGATAAAAAAGATACAATGGAGTGTAGAAATAAACTCG
ACGTTTACGTTTACGTGGATTTTTGTTTGGATTAATTTATATTTCTGTTTTAATTGGTGG
ATTTGGTATCTTATAGGTACAAATCGAAAATTAGGTGTCCAGGAAGCAAAAATGATCAAA
GGGTAAGAAAAGAGTTGCAATTAAGAAAATAAAATCAAATTAGAAGAGAGAATCCCTCAA
CATCTTTGGTAGTGTCCACGAAGTCGAGCATAACTCTCTCATCCGACTCCAAATCAACT

GGTTCCGGCGGCATTAGAAAGCTATTTTCAGCGGGCTACAATTCCCGTCTAACGTCAAAAT
TCCAAATTCGGACTCGAACATGGTCAAAATTGGATAACAAAAGCGATCATGAAAATACGT
ACTACAATTC AAGGACATGAATGCGCATCAAGAAACGTGCACAAAAACACTCGCTAGAAA
AGATACGC

>Mimulus_guttatus

TTTCTTAATTGCAACTCTTTTTCTTACCCTTTGATCATTTTTTGCTTCCTGGACACCTAATT
TTTCGATTTGTACCTAAAAGATACCAAATCCACCAATAAAAACAGAAATATAAATTAATCC
AAACAAAAATCCACGTAAACGTAAACGTTGAGTGTTATTTCTACACTCCACTGTATCTTT
TGTATCTAGTGTTTTTGCTGTTGTTGGTTATGCGTATTAAGTCTTAGTATTGTAGTTC
GTGTTTTTAAGAACGTTGTTGCGAATGCACCTTTGCGCATGTTTTTTTACATGTACGTTT
GTGCATGTCCATTTGAGCGAGTGTTTTGTGCATGTTTGTGATTTGTATTAATGTCCCTA
GGATTGTAGTTTTGTGTTTTTCATGATCCTTTTTGCGAATGCACCTTTGCGTGAGTACTTTT
GTGCATGCTTTTTGAACCTTTACTCATGTGCGTATCTTTTCTAGCGAGTGTTTTTGTGCAC
GTTTTCTTGATGCGCATTTCATGTCCTCGAAGTGTAGCACGATTTTTTCATGATCGCTTTTGG
AATCCAATTTTGACCATGTTCCGAGTCCGAATTTGGAATTTTGACGTTAGACAGGAATTGT
AGCCAAGTAAATAGCTTTCTAATGCCACCGGAACCGAGTTCGATTTGGAGTCCGGATGAGA
AAGTTATG

>Mimulus_dentilobus

ATGAGAAAGTTATGCTCGACTTCGTGGACACTACCAAAGATGTTGAGGGATTCTCTCTTC
TAATTTGATTTTTATTTTCCTAATTGCAACTCCTTTCTTACTCTTTGATCATTTTTTGCTTC
CTCGACACCTAATTTTCGATTTGTACCTATAAGATACCAAATCCACCAATTAACAGAA
ATATAAATTAATCCAAAAAATCCACGTAAACGTAAACGTAGAGTGTTATTTCTACAC
TCCACTGTATCTTTTTTATCTAGTGTTTTTGCTGTTGTTGTTGATGCGTATTAAGTCC
TAGTATTGTAGTTCGTGATTTTTAAGAACGTTGTTGCGAATGCACCTTTGGCGCATGTTTTT
TTACATGTACGTTTGTGCATGTCCATTTGAGCGAGTGTTTGTGCATGTTTGTGATTT
GTATTAATGTCCTAGGATTGTAGTTTGTGTTTTTCATGATCCTTTTTGCGAATGCACCTTT
GCGTGAGTACTTTTATGCATGTTTTTGTACTTTTACTTATGTGCGTATCTTTTCTAGCGA
GTGTTTTTGTGCACGTTTCATGATGCGCATTTCATGTCCTCGAAGTGTAGTACGATTTTC
ATGATCGCTTTTGGAAATCCAATTTTGACCATGTTCCGAGTCCGAATTTGGAAATTTGCCAT
TAGACGGGAATTGTAGCCAAGTAAATAGCTTTCTAATGCCGCCGGAACCGAGTCAATTTG
GAGTCCGG

>Sorghum_propinquum

TCAAATGGAAGCTCGCTTTGGTCTGTTTGGAGACAGTGCTAATCTCGATGCAAGATAGGT
GCACGGTTTGCATGGAACATACCATATGCTAAGAAATCAATTTGGACGCACCCGATGGAA
CTCCTAGATGACGTGTG

>Panicum_hallii

AAAGTCGATGCAAAACTGGCCGAAGTGGTCCATTAACGCACAAGTTCGCTAAACAAAGT
CGCGTCGGAATTTTTCGCAACGAACGCACCCGATCCACTCCATTGGACCCAAAACATCATG
TTTTGGGGCGTTTTCGGACCGTTTTCGTTACTGCACG

>Staria_viridis

TTGCGAAAAATCCACCCGAGTTTCGCTACCCGGCAATAGTGCATTCCGGGTGCCGAAAT
GCACCCGTTTTGCATCATTTTTTCGTGCCGGAACCGAATGCCAAAAACACTCCCAAACAT
GTTCTAGGGTATAATTAGGAAGATTGCATGCGTTC

>Phaseolus_vulgaris

TAAAAGAAGTATTAACATATCAAAACACAATTTTAACACATGAAATTGTTTTTCAAAGA
TATCATAAGTGTTCATCAATTAATAGACTTAAATTGTAAAAACATATCAAAACACAA
TTTTAACACATGAAATTGTTTTCAAAGATATTCATAAGTTTTAAAACAATTAATAGACTA
ACATTG

>Arabidopsis_thaliana

GGTTGGTTAGTGTTTTGGAGTCGAATATGACTTGATGTGCATGTGTATGATTGAGTATAAG
AACTTAAACCGCAACCCGATCTTAAAGCCTAAGTAGTGTTTCTTGTAGAAAGACACAA
AGCCAAAGACTCATATGGACTTTGGCTACACCATGAAAGCTTTGAGAAGCAAGAAGAA

>Cajanus_cajan

ACTTGCTACACCTGGGGAGACTAATAACCAACACAGATGCACAACATAGCATGTAATTGG
TTTACTGTTTATTGGTTCTCTCTAATTTCTTCAACTGACTT

>Lemna_gibba

CACACGCACGTATGCACACACATACGCACGCACACACGCACGTACGCACGCACGTACACA

CGTA

>Medicago_truncatula

ATAAGGTCATTTTGAACGGTTCGGATTGAACGTGGCTGGTGTCTGTTACGATCTAGGCACG
TTTAGGTCCTCCCGCAGTGAAGTCTAGTTCCTAAGTTGACTAGTCAATTAGGTGATAGTTTCGTC
CGGATGACGTACCTCCGTGAACCCGATCTGAGAAATTCAGTTTCTGCATCCTTCTATGT
TTG

>Solanum_pimpinellifolium

CCCCAAATGCATCAAACCAACCAATGGGAGACCTACATCTCCTACCATAACAATGCTTCAA
ATGGAGCCATATCAATGCTTGAGTGATAGCTATTATTGTATGAAAACCTCCGCTAAGGGTA
GGAAGCTATCCCAATGACCACCAAACTCTATCACACACGCACGAAGCATATCCTCCAACA
CTTGAATCGTTCTCCAGACTGACCATCGGTCTGGGGATGGAACGCAGGACCGCCCCCCC
CCCCAACCCGACCCACCCCCCCACCC

>Neolamprologus_brichardi

CGGGCCGCTGGCCACCCTTTATTTCGGGTGTCCGCTCCCCAGGCTCCGAAAGCCTTGCCA
GCCCTTGTGATCGGGTGGCACCAGCCACCAGGCGTGTGAAAAAAGAAGAAAAACCCGG
AC

>Mustela_putorius_furo

AGGTTTCAGTTCAGGCTTACGGTTAGGGTCAGAGTTAGGTTTCAGGGTCAGGGTCAGCGTTA
GTAGGTTTCAGGTTCTGTTTTATGAGTAGGTTTCAGGATCAGGGTTAGCTTTAGGATT

>Pundamilia_nyererei

CAGTGAGAAACGCCTGTCTTGGCGAAATAAAGCGTTTTTGTACAACCTTCATATAAATCG
CTGTAACCTTTTGTAGAGAAGACTCAGACAAACATGTTTATGGCTTTATCTTATAGAACTCA
ATATCCCCGTGCTGGGCAAACAGGTTTTGCAGCCGTTTGTAGCTAAGATTTTAAATTTATT
CACATAATGAAAACCTATACTTTGTTTTAGGGCGAGTTTCCCATTCAAATGCATGT

>Zea_luxurians

TCTCCACCAGAAATCCAAGAATGTGATCTATGGCAAGGAAACATATGTGGGGTGAGGTGT
ATGAGCCTCTGGTCGATGATCAATGGCCACACAACCCCATTTTTTGTCAAAAATAGCCAT
GAACGACCATTTACGGATTTTTGACCAAGAAATGG

>Theobroma_cacao

AAAAAATGTAAAAAATTCAACTTAAAATCAATAATGAGATTATAAAACCATTTAAAGCG
AGTAATAAGGCTTACAAAGGCATTGGTGACTATAAATGGACTTTTTCTTGTCAATGGATGG
GATTCGCTTACGTTTTCTCGAGGGAAACATCCAATTATAATCTGTTTTAAC

>Salix_purpurea

AAATCCAAGGCTAACACCCCTCCAAAAACCAAGTTCAACCATTTTGGGGGGAAAAGTCT
ATTACCCATAAATTTGAAGTCTAATACCAACTAAAAGGGATTGGATATGAACAAGGTTAG
AAATCTAAGGCTAATACTCATTAAAAATGGGGCTCGTCGAGTCAGGACCAATTTGTCCG

>Branta_leucopsis

CAGGGAAACGAAGCAAAG

>Aegilops_tauschii

TTCTGACATCATTTGTTATTTTTTCAGGCATTTACCGAATTTTAAAGAGCTAAAAGACCC
TAAAATTGAAAAGCACTACAAAATGAACTCTGAAAAGGTTGAAAGTTGGCATGGTATCAT
CATTTTCATCCACATAGCATGTGCAAGAAAGTTGAGAGGGTTACGGCAAAAACCTGGATGCA
CTTCGTGTACAAAACGGACAATCTCTTTCAAAGTATCAGGATTTTCATACGGAAACTCGTC
TGTTACAAAGGGATTTTCATTTTTTAAAACCTATTTGAACTCCTGACTTTTTTGTGTGTTCA
AAATGCACCATTCAAAGCCACATCATCATTTTTTCAATCCT

>Lottia_digitalis

CAATAGGGTTAATCCTTGGTTGATTACGAACACTCACACCAAGTTTCGTCAAAATCCGTC
AAGAATTGTGCTTTCTAGAGTGTTCACGAGCTAAAAATTGAACGCGTTTTCAAGAACAAG
GGCAATAATTCATACTAAATATTTTTCGATTTTCGCTGATTTT

>Gallus_gallus

TGATTTTTCGGGTTAAATGGGGGATTCTTGAAGAGAAAATGCA

>Mayetiola_hordei

AACTTCATTTCTCACTGATCTAATGACATCGGTTTTGTAAATCTAGACATTTTTCAAGGC
AAATGCTGATTGGTTATCTCTCAGAGAATCATTTCTGAATTATGTATATAGCTATCGGCG
ACCCTGAATTTCCAATCCAATCATATATTGGTCATAGATTTGCTTCAAAGTTTTGAAAA
TATTCGAAAAACTTCATTTCTCACTGATCTAATGACATCGGTTTTGTAAATCTAGACATT
TTTTCAAGGCAAATGCTGATTGGTTATCTCTCAAGAATATAGCCATCAGCGATTCTGAATT

TCCAATCCAATCATATATTGGTCATAGATTTGCTTCAAAAGTTTTGAAAATATTCGAAA
>Eucalyptus_globulus
CAAAAAATGGCCGGAAAGGGAATTTTCTATGGAAAAACAGGGAATTTTCTCTGTGGAATC
TTCGTTCTCTTGTTCGCGGGCGTTCAGGGTGCTGTGATGTCCAAAATGATGGGTCCGGA
CTGATCTAATGCTTTTGGAAAGCCATGTTTCCCAACAGATTTCCAACACTGTCGGGGTTTTTC
AGC
>Lottia_scutum
CAAAAAATGGCCGGAAAGGGAATTTTCTATGGAAAAACAGGGAATTTTCTCTGTGGAATC
TTCGTTCTCTTGTTCGCGGGCGTTCAGGGTGCTGTGATGTCCAAAATGATGGGTCCGGA
CTGATCTAATGCTTTTGGAAAGCCATGTTTCCCAACAGATTTCCAACACTGTCGGGGTTTTTC
AGC
>Chinchilla_lanigera
CTAAGTTCACTATTCCAGGAAGCACTCACTGTAGGAAACCTATACCACCCACAGGAAAC
ATTCTGCCTTGCTCAGGTAAGGGGGGATTCCACACATTCTAAGTTGACTATTCCAGGAA
GCACTCACTGTAGGAAACCTATACCACCCACAGGAAACATTCTGCCTTGCTCAGGTAAGG
GGGAAACGCACTCACTCTTGTGCTCATAGGCGCCTATGTGAAAGGAATGCCATGGGTGC
ATTGCTCTGTGAAAACAAGCAGGGAGAGCATAGCCAATGTAGGCCATACTTAGTTTTAC
TAGGGAAGCTCACCACAGCACTTAGAAGTTTGGGAGTGTTCGGGAGTTTGGGGCAGAA
AGTTGTTCTTTTTCGTTCTAAGTGGGATTTACTGTTTTCTAAGGGAGCATGTATAGGACTG
GTGTGCGGTGATTCCACCCATT
>Trichechus_manatus_latirostris
TGCTATCACAAATGTTCTCTCAGTGGGAGAAGGCAGTAGAGAGAAGGCCTAGCAGGAATT
GGAATCCCTGTTTTCAAAGGGAACTTTGATAACAGGAATGAAGGTATTGCTAGCTTACAT
AGCCAAACAGGCAGATTGTTTGCCTTCAGCTAGAGAACAGCAGAAGAGGTTTCAGTTTTGC
TAACTAAACCTTGTGTGCTTAAACACGAGCATGTAGCTTCTTCCCTGCCTGAAAGAGAAA
CAAGAGCTTGCTGCTCTCAGTCTGGGGATGAAGGGAAAAAGATTCACTTTCTGTGTTTGA
AAATCCCTCTGTGTTACATGCCTAAGAAAGTTGCCTGTGCATTGTCTACCTGGATAAAGT
GTATGACTTTTCTCCCTTTCAAGTAGTTGAAGCCGTTTCAGGGTTTGCAGCATTCCGGGAG
GCATTCTGTGCTGCGCGGCTGAGAATACCGCTTTACAGACGGTATCGCTAAAGGAGAAGA
GAAACCGCGTTTCTGCCTTTCTGGAACACGAATGAGGCAAAACCGTAGTTGTGCTGTGTA
AAAATTTGTGTCAGCAGCAAGTGTAAGTTCCCATTCACCACATGAAAGAGAAAAGCAAAAT
ACAGCGTTTCTCCTTCATGCTGCTTAACTGAATCTACTGAAGTTTTTCAGTTTTGTTAGAAG
AAGCAGTCCGCCACCACAAGC
>Leptonychotus_weddellii
AGAAATATAGAAGATAAATGAGGCAGAAGAGAGAAGC
>Saimiri_boliviensis
ATTCCAGAGTGGATGGGAGAACAGGCTGTAAAGAGAAATACCTTGCTCTAAAACCAAAC
GGAGCTATCTAGCAGAATGGTTGTCAATGTGTGATTCAACTTCCAGAGTTAAACTGATG
TGTGTTTGCAGCAGTTTCAGAAACCTTTCTTTGGAGAATGCAGAAACAGTCATTTCCAGC
CCTAGAGACGCATATAAGAGTTAGCAGTAAGAATGCGTTTCAAACACGGAAAAAAGATGT
GTGTAAGCAGCAGTTAAGAAACCTTTCTTAGGAGAATGTAGAAACAGTCTCAGCGAGG
TAGAAACACGTTTCTTCTAAAAGCTGCGTTTTGGAC
>Cricetulus_griseus
TTAGGG
>Drosophila_bipunctinata
CCTGCCGAGGCGTGGAGTGCCCCGGCGATCCCCTGCCAGCTGATACCCCGCCAATACGTG
AAGTGCCTGGCCGATCTCCCTGCCAAGGCCTGGAGTGCCCCGGCCGATCCCCCTGCCAAGG
CGTGGAGTGCCCCGGCCGATTCC
>Drosophila_elegans
GTTTAGTTCTTCGACATATAGCAATGGTTAAATATTTTCAGAATTACGGTTTTAAATTTTCAT
CAAAATCGGACGACTATATCATATAGCTCCCATAGGAACAATCGAAAAATAAATGAAAAA
AATTATAACTTTTTCTGTTTTTAACCTTTTT
>Drosophila_ficusphila
TTTTTCGAATTTTTGGTCAATATTTTTGTAATTTTTTATGACCCCCGACCTGTCAAATTTG
CAAAAAATGGGTTTGCAGAAAAGTGACCAGATCCCAGCACTGCTTAGCCCATAACTTTTTG
AAATTTTTTACCCGATTTAAAAGTGAATACCTCTCTGAATTTGTTATTAAAATATCTATC
TAGCTGCATTATTGGTTTA

>Drosophila_kikkawai
ATACTCAATTGTAAATTTGTAAACAAAAAGTTTCAACTCAGCTAATAATGCATGTATCC
ACTTCAGAATTTGTATTTATATTAGTTTTTACAAGGCTAATACATTTGC

>Drosophila_rhopaloea
TTTCCGAGGACTTGTAACAGAGTGACTCAAAATTGGACTTAGAGAGTCCATAACTTTACC
AAACTTAAGCCGATTCCAAAGTGGCATACTCTAAAGACTTCTGATTTCGATTCTCTAAAA
ATCTGCATTCAAATTTTTCAATTTAACGTTGATCAAATTTTTGACCCATTTTCATGTCAG
TTATTTCTAA

>Drosophila_takahashii
ATTGGAATGTCCGATTTAAGCCATAATTGCTGAGTTTATAGGTCTTGATGAGTAGAACAA
AGTTGCCATAACAATCCTTCTTTCTATCTCTTGTAGTTTTTCAAACCGTCTTATATCTGA
AAATAAGGAAAAACATGGTAACGGATGAAAATGAAAAGACAAGTAGCTAAGACGGCCAAT
AACTTTTG

>Drosophila_eugracilis
GGTTTACCATTTTCTCCTTTAAGTGACAGTATTATGGCTATAACTAAGCCAATAGTAGC
CGAATCTGGAATGGCAGTAGTCGTTGGATTCTTTATTAATTTAAACTT

>Drosophila_biarmipes
TTTGCCATCGATCTGCATCATTTAAAAGAAAATTTATTTTTTGACCCACTTTTTTCATTTT
TTACAAGGAGGTGTGTCTTAATTTTTTAGAATTCGGATTTTAGCCAAAAACACATTTTC
TTGCGTTTTTCAATCGTAGTTTATCCAATTTAAGGAGTACAGCTAAAAGACCGACTGTT
TTGAAAGCTGGCTTAA

>Boechera_stricta
ATTTTCATGAACTTATTTTCTCCTTCTCGATTCTTATGAGTTATCGCTGTTTTCAATGGA
AGGTCACGAAATCTCGAAACGCAATGTCATAATAAAGTTTTGATATATTGAACTTACACC
ACTTATGAGCATATTTATCCCTTAATTCACTTTGGTGGTTTTCAAC

>Cannabis_sativa
TCAAGACAGCTTTCAAACATCCTCAATCAACCAACGTGAACGCACCCAATTGAGGGTGGT
GACACCGGATGATTTCAAATGAGTGTCCCCCATCACTCCGACAATGAAGTCGG

>Clonorchis_sinensis
GGGTTTGTGATGCGGTTGCCACGTGTTGTGTGACCGCGCAGGAGCG

>Ctenopharyngodon_idella
ATTGCGAGATATAAAGTCAGA

>Acropora_digitifera
GAAAATGCAAAAATGGCCACCATGCAAAGGCTATAGCCCATGCAAAAATCGTCACTTTGGG
TCAAAAATTAAAAATGCAAAAACATGCCAAAACCATTTCTACAAATCATTTACAGTTGT
TCTGTGCAAAAACCGCTCCAAAACACCAAATATTCGAAAAATGAGAGCATTTT

>Daubentonia_madagascariensis
GGTTAATCACTGCTGAAAAACCGGTTTTACTGCCAGAGAATCACATTCGCAGCAAGGC
GTTAGAAGAGGCAGGAGAAGAAAACATCGGTTTTTCTGCCAGCCAGCCGCTTATGGAGAG
TGCACGGGAGTTTACAGGAAACACTGCCTTTCCAGAAAGAAAGCACCTACTTCTTAGA
TTGATTGCAGGCTTGCTCTATTCTGTGAAAGGAAGCAGAATATACACTGCCTTCTCCTA
GCTTCTCCTAGGATGAATATTGAAACCTG

>Dirofilaria_immitis
ACAAATTCATCGTATATATATATGATTAGACGGGTCACAATGCATACCTATGATTAGACA
AACACAGACGAGTCATAATCCGTATCTATGATTAGACAAATATATACGACAAATTCATCG
TATATATATATGATTAGACGGGTCACAATGCGTATCTATGAGTTATACAAATATATACG

>Perdix_perdix
TTTGGGGAGAAAAGTGAAGATTCGAGCAGAAAAATGGGGATTTGAGGGGAAAAATGGGGA
TT

>Heliconius_cydno
AAACCATGAAACATGTGTTCAATTAATACTTTTAAGAGTCTAAATTTCAAATTTTATAA
AAATCGGTGACGATTTAAGAATTTTTCCATACAAACTTTCAACCCCTTATTTGCACCCTT
AGGGGGAGAATTCTAGA

>Heterocephalus_glaber
AGGGGCTTCTGGGCCACCATCCCTACTGCTTCCCGGCCAGAGGA

>Heterodera_glycines
CGTCATTTTTTTACGGAAGAATAACCGGAATACAAATTAATTTTTCAATTAATTTTTGG

CACTATACTGCTATAGTGGCTTGGCCTTGGCTTGGAAATTTTTCTGTAGCTCAGCTCCCTG
ACAGTCGTTTTTTGATTTGAAGGTACCATTGAAAGAGCTCTTTTTCTAGGCCTAATGGC
TAAGGTGG

>Lepisosteus_oculatus

GGCAGTAAAACCACATGTAACAAAACGGGCATAACAGGCACACTTTTTCAAACCGTGTTTT
TCAGCCCCGAAATAAACCGCGTTTTTTTCAGACAACCTGAATACCCATGTAGCAAGCAAGGCTC
AGAGAGCCCACACACTCAGATCTTAAAGTGTTTTTCAGCAGAAATAAACATGTTTTCTGCA
AGTTTTGGTCAACCCCATGTAAGTTATGGGGCCAACAGAAATAAACAAAACGTTTTGGTCAA
CCCCAAATAATACGC

>Leucoraja_erinacea

TGGTATGGTCAGACGTGGGGGCAAGCCTGCCGCTGATAAAGGAAAGGACAATCGTGATTA
TCTTGGCTGCCGCATTCCCTGAGCTTAATGCTGGGGACCGTGCTGGTGCTCATGCCTCCTC
CGC

>Linum_usitatissimum

GTTCTGTCTATTTATAACTCTTTTATGTCGGTGATATACACTTTACGAGTATGTTATGCG
TCTTTTATTTATGTCTTTGTTACGTCACCTTACGATTAGTTGAATTCATCATC

>Lytechinus_variegatus

TTGAATTACCATCATAACTTTGAAAGTTTTATGGATCTAGTTCATGAAACTTGGACATAAG
AGTAATCAAGTATCACTGAACATCCTGTGCGAGTTTCAGGTCACATGATCAAGGTCAAAG
GTCATTTAAGGTCAATGAACTTTGGCCGAATTGGGGGTATCTG

>Manihot_esculenta

TTTGGGATGGAAGCTATTAGGCCGAAATCGGGCACC GGATGTAACATGGGTGATAGACTT
GGCAGTT

>Musa_acuminata

GCTGAGAAAAGGGCAGTCAAATGCCAAGAAAACAGAACGAATACCAGGTGCTAAACCATA
GCAGATTCTAAACTTGGGGTTGATCTCTTTAGGGGATCGGCCTCCTTGGAACTCTATAGG
GGGAATTACTCCAAGTGGCTGTCAAAA

>Patiria_miniata

CTGACAAATCGGCAAGGTTTCAGACTTGAAACTTTTTGGAGTGAGCCCCAGACATAGGTACA
TGATGCCCCAGTTTTCGTTTTTGTGCAGTAAGTCCCATAGCAAGGGCTGTCAGCGCCAGC
CGACATGGCTCTCATGTGTGCGGGTCTAAAGGTACCTTAACATGGATGGATTTTTGACAAA
CTATAACTTGGTTGGATGGCGGATGAATGGCTCAACAAG

>Phoenix_dactylifera

TCGACTCGCCTCTCAGAGACGAAAATACCGTCTTCTGTCTTTTTGGAGTTGCGCTGTCTC
GGAGTCGACTCGAACTTTGCGGGAGTCGACTCGGCTCTCAGTGTCTGAAATTGGCTCTCT
GACTTTTTGCTTGTATTCTCTGGGAGTCGACTCTAGCTTCTTTGGAGTCGACCTGCCA
ACCATCGGAGTCGACTCGAGTTCTCAGGAGTCGACTCGGCTCTCAGAGTCCAAAATAGC
TCTCTGACTTTTGCCTTGTCTCCCTAGGAGTCGACTCGTACCACACTGGAGTCGACTCG
AAAAGCATCGGAG

>Pogonomyrmex_barbatus

ACCTGACGGTCTCGGCGGTACCTCCGCGCGGGCGTGTGCTTTTCGCTCGCGGGCGGT

>Radix_balthica

AATAATCTAAAAAATCAATAATTTAATTACGGTACATGCGATCGATCTGAAATTTTGATA
CATTGTTTTTATCATCGGTACGAAACTGCCTGCAAAATTTTCAGCTCGCTAGCTTACGAGC
AAGTGGGTTAAAAATCGATCAAAAAGTTTTGGCGACAAGCAAGCAAGCAAGGTTCGGC
CGCAGACACCACGAGTTAATATAAAGGATTTAATAAAAAAAACCCGTAAAAAACCAAGTT
TTTGACTATAAATCCTTTATGTACGAGACGTAACATAAAGAATGTTTATTATAATACGCA
GCGCAAGACCATCCAAAATACAAAATTGCAGTTGTGTGCGTAAAACATGTTTAAATATAATG
CGCACCGATCAGGAATATGTTTTATAAAAAGAGCTGTCAATAAAATACGCACCTTATTGCG
CGACAGAAAGGTTGTTCAATATAATACGCACCGCGACGCTCTATCTCAAAAAATAGCATG
ATACATAGGAATAAATAA

>Ovis_aries

TCCACAGGAAAGGCGAGAGGAACTCCAGGGTCGTGCCACCATTCCAAGAGTCCCCCAGAT
GTGTGACTCCATTCCAGAGGAACCTGTTTTCCCTGCACTGCCTTGACGTTCAAGCCGAGG
ATCGACTCCCACCACGTGTGCACGTGGGACAGCCCTGTGGGAAAGCCTCGTGGGAAAGCC
TCGTGGGAAAGACACGAGGGAAAACCATAGATGCTTTGATCCACGGGGCGGACTGCGTGA
CACTGCTGCTACCGCTCTGGAGGAAAGCGCAAGTGCATGCCCGCATTTCGAGACGAGGACT

GACTCCCCTGGGGAGACTCCAGAAGTACCCCAAGATCCATGTCAGCACTGGAGAGGAATC
CTCAGGTTCCGGCCCTGAGTTCACACAAGGTCTTAGGCCCCGGCATCAGCGGGAGAGGAA
TTCCGAAAGGCCCCCGAGGAACTCGCATGGGGACTGGCCTTTCCTGAGGCCACCAGAGCG
GGTCCCTGAGGGCCCCGTCGTAAGTCGAGAGCACCTGCCGCAACTCGAGAAAATCCAGGA
GGTTTTGCCCTCCAGGCGAGATGAGGCCATTTCCGCTGAGGCTTCTCGAGGCTAATCAC
ATCTAACCCTGGAACCTTCCAAAGGGTCTTTCACACCCTTGCTGCAACTCAAGAAGTTCC
CGACACACCCGCTCTCCACTCGAGAGGAAGCACGAGGGTCCCGAACACATCCAGGGGAGCC
CCGTTTCCGCTCCGAGCTCGAGATGAGGGATCCTTTCCTGTTTCGTAGGGAAAGAATT
CCCGGCGTTCCTCGCATCTCAAGAGGAGGCGCTC

>Euclidaris_tribuloides

TGGTTTTCTACCATATATGCTTGCATCTGACAGTATTAAGAAGAACACCAGACCGCAATC
AAACAAAACGAATGCATCACTATCTGATGAAACGAAAAAATATGTTTACACCCACTGGGA
AGTAGATTTTCAGCGAGATATTGTCATTGGTAGAAGATAGTTAGGGATAGGGTAGAGTTAG
ACGTTAGCATGTAGATTAGGGTTAGCGACAAGATATGCTTGCATCTGACAGTCCATTGAA
GAAGATTATCAGACCGCAATGAAACAAAACGGATGCATTACTATCTGATGAAACGAAAA
ATATGTTTACACCCACTGGGAAGTAGATTTTCAGCGAGATATTGTCATTGGTAGGGTTAGG
GTTAGGGTTAGGGTTAGGGTTAGGGTTAGGGTTAGGGTT

>Oryza_brachyantha

TTGTATGAATGGTGAAGTTGTTGATGGAATCCAAGTGTACCCTTCGTGCTCGAAAATTC
GCTACCGAAGTTGTGTTTCGAGCACGAAGTGTAAACCAAGTGGATACACAATTTGTGTAGT
TATCCCAAAGTTCATAGTCGAATCTTGGTAGACT

>Anopheles_merus

CTTTCCTCCATCCATCCATATGGCCATGGTTGAAATTTTGACGAAAATGCAAGGTCAACCAT
TATCGTTCTTATATCATTGAGGCTTCTTGAATAACCAAACCAAAGCCCTGGAACACAATA
ATAAGGATCTTGGCGATGAAAAAGTCTCAAAATGGGTCATAGTACCCTTTATACACATGC
TAAAATTGATAGGTTTTCCCGAGTACAATGCATTTCAGAGGCCATTTACTAGGCTACCAGT
GAGTCTTATCTTTAAACCTATGTGCGGATCTAGAAGACCACTTCAATACCTTTCCAAAAC
TGTCTTAATCGTCTCGCTAGGACACATGGTTACGAAGTTATGGCCATTTGAAGGAATGTC
CAA

>Zostera_marina

CGCACTAGAGTGCATTCCTTGGTCGGGATCACACGAATTGCACGCATGAAGTACTTAGTC
GGGAT

>Miscanthus_giganteus

ACACTAACACTATCTCCAAACGGACCGAAACGAGATTCCACATGACCCACGTCACCTAGG
AGTTCCATCGGGTGCCTCCAAAATGATTTCTGAGCCTATGGTACGTTTGGCGCAAACCGT
GCACCTATCTTGCATCA

>Hordeum_vulgare

TCATGCCTCTAGTTGGCTAGCCAGTTGATCAAAGATAGTCAAGGTCTTCTGACTATGAAC
AAGGTGTTGTTGCTTGATAACTGGATCACGTCATTAGGAGAATCACGTGATGGACTAGAC
CCAAACTAATAGACGTA

>Macaca_fascicularis

AAGAAGCTTTCTGAGAACTGCTTTGTGTTCTGTGAAATCATCTCACAGAGTTACAGCTT
TCCCCTCAAGAAGCCTTTGCTAAGACAGTTCTTGTGGAATTGGAAAAGAGATATTTCCGAA
GCCCATAGAAGACTATAGGGAAAAAGGAAATATCCTCAGATAAAAAAGAGA

>Thellungiella_parvula

TTTGAGAAGATACTAAAATCTAGAACTAAAAGACCAAGAGTGAACATGATCATGAAA
GGAGTCTCTTAGAGATCCTAAAGGGAGTTTTAAATCCAAAATCCTTACACACATACTTT
TGTTGAATCAAACAACTAAATGTATGGACACAACCTAGGCAAAGGATTAGGGAATCCTA
GATGCATTAGGACATGCATATCTAGTTGGTACTCATTGT

>Bison_bison

AATGGAAGATTGGACTTCCCTGGGCCAAACACAAGAGGCATCCTGAATTCCTCCGTCGTAA
TTCGAGAATCCTGCCGACACTCGAGAAAATCCACGTGTTCCCTCCGTCATCGCAAGATGAA
GCCCTTTCCTGCTACAGTGTCTCAGGAGAAGTCCCACGTTAGGTATTGGAGGTCGAAACG
GTACTTGGCACCTTGATGCGACCACAAAGTGGCCGACATCCCGGTCTCCTCCCTCGAGAGG
AACACCGAAGTTTTCCGGCACCACTTCTCTGAGCCCCTTCTACCCTCCTGATCTGGACA
GGAGGGTCGACTCCCCTGCTTTGTCTGGAAGGGTTCCCGACCTTCCGGTTCGCACCTCAG
GATGAGGCCGGGTCTCACGACGACATTTTCAGACGTGGCCTCGTGGGTGGTTCCACATTCC

GAAGGACCCCGATTTCCCGGTCCCCTCTTGATAAGAACCCGATGCCCGGACACCTCTTCG
AACCTCCACCCTGTGAATGAAGTCAACACGAAAGGGCAGTGACTCGCCCGTGCATCGTCCG
GGAAAAAACCCCAAGTTCCAAATACCGCTCGACAAGTGGCCTGTCTCCCGGGAAACAC
CTCGAGAGGCAAGCGGAGTTCCATGCCTCACCCAAGACGAGGCCTGACTCTCCCTGTCCC
AAGTCTGCAGGGACCTTGCATCAGAGTCTGAAGTCAAGAGGAACCCTGAGGTTCCCTGCCT
CAACTGGAGATGAGGCCCTCTTCCAATGCACCAACCCAGTGGGAGTGCCGAGAAGCCCT
CCCACCTCCAGTTTTCCCTGACTTCTCAGAGCCACCATGAGAAGCCCCCTGAGGTCACCT
GCACAAGTCAAGGGAAGCCAGGTTTTCTGCCTCAACCCGAGAAAGACCTCGAGAGACCTT
CTTCAACACGTCTCGAGCCAGATTCCCCTAACAGTGACTCGAGAGCAATGACGCGCTCCC
CCTCGCCATTGCGCATGGAGACCCCGACTTCCCCTGGCGCCCACGAGAGCTCACTGACCTC
GCCGTCGTACACTAGGAAAAACCGCACACTGTGGCGCCAGCTCGAGAACAACCCTGAGCC
CTCCCCATCATCGCGAGTTGAGGGCCTTCGTCTCCTGTATGGCCTAGAGACCAATCTCCT
CGACTCTCTCTCAAACGCCTCAGGAGGCTTACTCCCTTTAGTCCACCCAGTGAGCTCCA
AGAGATACCCGTCGCGACTCGAGAGCAGAGCGGGGTTCTTTGCTTCCACTCGACATGAAT
GCTGTCTCCCGGGTGCCTGGAATTGCAACCCTGAGATCCCTTTGCCCCCTGGAGAG
GAACACTGGCTTCTGGACACGAAGCCTAGATGAGGTCTATTGGCCCTGCAGTCACTCGAG
AGCAATCCCCAGCTTTCCCTTCGCAACTCG

>Bos_grunniens

GGTGGCCAAGTACCGTTTTGACCTCCAATTCCTAACGTGGGACTTCTCCTGAGACGCTGT
AGCGGGAAAGGGCTTCATCTTGCATGACGGGGGAACCACGTGGTTTTTCTCGAGTTGCG
GCGGGATTCTCGAGTTACGACGGGGAATTCAGGATGCCTCTTGTGTTGGCCAGGGAAGT
CCAATCTTCCATTGAGTTGCGAAGGAAAGCTGGGGATTGCTCTCGAGTGACTGCAGGGC
CAATAGACATCATCTAGGCTTGTGTCCAGAAGCCAATGTTCCCTCTCCAGGGCCGACAGGG
ATCTCGGGTTGCATTCCAGACGCACCCGGGGAGACAGGCATTCATTCTCGAGTGGAAGCA
AAGAACCCCGCCTGCTCTCGAATCGCGACGGGTATCTCTTGGAGCTCACTGGGTGGACT
AAAGGGAGTCAAGCCTCCTGAGGCGCTTGGAGAGAGGTGCGGAGATTTGGTCTCTAGGCC
ATGCAGGAGACGAAGGCCCTCATCTCGCGATGACGGGGGAGTCTCGGGGTTGTTCTCGA
GCGGGCGCCCCAGGGTGCGGTTTTCTCACGAGGTACGACGGCGAGGTCACTGAGCCTCTCG
TGGGGCCCAGGGAAGTCCGGTCTCCATGCAAGTGGCGAGGGGGAGCGCGTCACTTCTCCT
CGGAGTCAATGGTAGGGGAATCTGGCCTCGAGACGTGTTGAAGAAGGTCTCTCGAGGGGGT
CTTTCTCGGTTGAGGCAGGAAACACTGGTTCCCTCGACTTGTGCAGGTGACCTCAGGGGG
CTTCTCATGGTGGCTCTGAGAAGTCAGGGAAACTGGAGGTTGGGAGGGGCCTCTCGGGAC
TCCATGGGGTTGGTGCATTGGAAGAGGGCCTCATCTCCAGTTGAGGCAGGAACCTCAGGG
TTCCTCTGATTTAGACCGATCGCAGGGTCCCTGCAGACTTGGGACAGGAGAGTCAGGCC
TCGTCTTGGGTTGAGGCATGGAACCTCCGCTTGCCTCTCGAGGTGTCCCCGGGGAGAGAGG
CCCATTGTGCGAGCTGTATTTGGAACCTGGGGGTTTTCCCCGAACGATGCACGGGCGAGTC
ACTGCCCTTCTGTGTTGACTTCATTACAGGGTGGAGTTCGGAAGAGGTGTCCGGGCATC
GGGTTCTTATCAAGAGGGGACCGGGAAATCGGGTGTCTTACGCAATGTGGAACCCAC
GAGGCCACGTCTGGAATGTGCTGAGACCGGCCTCATCCTGAGGTGCGACCGGAAGG
TCGGGAACCCCTTCCAGAAAAAGCAGGGGAGTGCACCCTCCTGTCCAGATCAGGAGGGTA
GAAGGGGCTCAGAGGAAGTGGTGGCCGGAAAACCTCAGGGGTTCTCTCCGAGGGAGACC
GGGATGTCCGGAACTTTGTGGGTGCGATCAAG

References for Supplementary Table S2

(Wade et al., 2009; Hasson et al., 2011; Alkan et al., 2011)
(Matzke et al., 1990; Shang et al., 2010)
(Tek et al., 2010)
(Lee et al., 1997; Alkan et al., 2007; Hasson et al., 2011)
(Alkan et al., 2011)
(Alkan et al., 2011)
(Haaf et al., 1995; Alkan et al., 2007; Locke et al., 2011)
(Zhong et al., 2002; Nagaki et al., 2004)
(Cheng et al., 2002; Lee et al., 2005)
(Heslop-Harrison et al., 1999; Hall et al., 2003; Zhang et al., 2008)

(Krzywinski et al., 2005)
(Tarès et al., 1993; Beye and Moritz, 1995)
(Cellamare et al., 2009)
(Alkan et al., 2011)
(Abad et al., 1992; Abad et al., 2000; Sun et al., 2003)
(Haaf et al., 1995; Samonte et al., 1997; Alkan et al., 2007)
(Musich et al., 1980; Alkan et al., 2007)
(Fishman and Saunders, 2008)
(Guenatri et al., 2004; Kuznetsova et al., 2006)
(Cellamare et al., 2009)
(Alkan et al., 2011)
(Haaf et al., 1995; Samonte et al., 1997; Alkan et al., 2007)
(Musich et al., 1980; Alkan et al., 2007)
(Viñas et al., 2004)
(Tek and Jiang, 2004)
(Jiang et al., 1996; Zwick et al., 2000)
(Fischer et al., 2000; Roest Crollius et al., 2000)
(Ugarković et al., 1996)
(Harrison and Heslop-Harrison, 1995; Lim et al., 2007; Koo et al., 2011)
(Teschke et al., 1991; Niedermaier and Moritz, 2000)
(Alkan et al., 2011)
(Meyer et al., 2010)
(Ekes et al., 2004)
(Kikuchi et al., 2011)
(Tanaka et al., 1999; Pathak et al., 2006)
(Kipling et al., 1995)
(Spence et al., 1998)
(Jantsch et al., 1990; Bratanich et al., 2000)
(Gaillard et al., 1981; Plucienniczak et al., 1982; Taparowsky and Gerbi, 1982)
(Sternes and Vig, 1995)
(Buckland, 1983; Novak, 1984)
(Argout et al., 2011)
(Lee et al., 2011)
(Carone et al., 2009)
(Samonte et al., 1997; Alkan et al., 2007)

Supplementary Figures.

Figure S1 - group alignment (from Figure 2 - The Tree):

For each of the 26 groups of species with sequence similarity as depicted by the red bars in Figure 2, the alignment is shown in top-to-bottom order.

Figure S2 - primates and cichlids:

The colored bars represent the length of the centromere repeat sequences and the colors represent sequence similarity.

A There were 21 primates in the 282 species. All the Old World Monkeys (macaques and baboons) and apes (gibbons, gorillas, chimpanzees, bonobos, orangutans, and humans) have similar 171 bp centromere repeat sequences. The New World Monkeys (spidermonkey, marmoset, squirrelmonkey) have a 343 bp repeat. This 343 bp repeat is a

doubled version of the 171 bp repeat (lighter blue bars, Figure 5D). The (candidate) centromere repeat sequences of the more basal tarsiers and prosimians did not show sequence similarity with the apes or monkeys or between themselves.

B The centromere repeat sequences of the Lake Malawi cichlids (*Metriclima zebra*, *Melanochromis auratus*, *Labeotrophus fuelleborni*, *Rhamphochromis esox*, and *Pundamilia nyererei*) and the Nile tilapia (*Oreochromis niloticus*) showed sequence similarity, even though the Nile tilapia centromere repeat is 20 bp shorter than the 237 bp repeat found in the Lake Malawi cichlids. Surprisingly, the centromere repeat sequence of the Lake Tanganyika cichlid (*Neopamprologus brichardi*) did not show sequence similarity with either the Lake Malawi cichlids or the Nile tilapia.

Figure S3 - correlations between karyotype, genome size and our found parameters (length, GC content, genomic fraction):

Genome size and karyotype were correlated to tandem repeat length, GC content and genomic fraction, but no correlation was observed.

Figure S4 - Nile tilapia (*Oreochromis niloticus*) tandem repeat alignment:

In Nile tilapia (*Oreochromis niloticus*) is a close relative to the cichlids and the centromere repeat sequence is similar to the candidate centromere repeat sequence in Malawi cichlids, except that the most abundant tandem repeat in Nile tilapia has a 206 rather than a 237 bp repeat. In addition, a 237 bp repeat is also present in the Nile tilapia genome, but is less abundant. The alignment shows a 20 bp indel.

Figure S5 - Bovidae fractions of short (680 bp) and long repeat (1410 bp):

In Hereford cattle (*Bos taurus taurus*), Nellore cattle (*Bos taurus indicus*), yak (*Bos grunniens*), bison (*Bison bison*), and waterbuffalo (*Bubalus bubalis*) two predominant tandem repeats were found. One was around ~680 bp in length (named short) and one was around 1410 bp (named long). No sequence similarity was found between these two repeats, but all five species had these repeats, albeit in different ratios. In waterbuffalo the short repeat was the most abundant, whereas in the other species the long repeat was the most abundant.

Table S1 - all species info:

For each of the 282 species the basic phylogenetic, repeat, and genome information is given as well as the accession numbers used. The accession numbers for the NCBI Trace Archive (Sanger data) and DDBJ DRA (Illumina and 454 data) is given separately.

Table S2 - literature comparison:

For 60 of the 282 species literature data was available. For 51 of the 60 species we found the published repeat.

Table S3 - PRICE vs Sanger discordance explanation:

For 10 of the 37 we found a different repeat between PRICE assembled contigs and tandem repeat directly derived from Sanger sequences. Each case is individually addressed.

Table S4 - Number of species with data from a particular sequencing technology.

References

- Abad JP, Agudo M, Molina I, Losada A, Ripoll P, Villasante A. 2000. Pericentromeric regions containing 1.688 satellite DNA sequences show anti-kinetochore antibody staining in prometaphase chromosomes of *Drosophila melanogaster*. *Mol Gen Genet* **264**:371-377.
- Abad JP, Carmena M, Baars S, Saunders RD, Glover DM, Ludeña P, Sentis C, Tyler-Smith C, Villasante A. 1992. Dodeca satellite: a conserved G+C-rich satellite from the centromeric heterochromatin of *Drosophila melanogaster*. *Proc Natl Acad Sci U S A* **89**:4663-4667.
- Alkan C, Cardone MF, Catacchio CR, Antonacci F, O'Brien SJ, Ryder OA, Purgato S, Zoli M, Della Valle G, Eichler EE, *et al.* 2011. Genome-wide characterization of centromeric satellites from multiple mammalian genomes. *Genome Res* **21**:137-145.
- Alkan C, Ventura M, Archidiacono N, Rocchi M, Sahinalp SC, Eichler EE. 2007. Organization and evolution of primate centromeric DNA from whole-genome shotgun sequence data. *PLoS Comput Biol* **3**:1807-1818.
- Argout X, Salse J, Aury JM, Guiltinan MJ, Droc G, Gouzy J, Allegre M, Chaparro C, Legavre T, Maximova SN, *et al.* 2011. The genome of *Theobroma cacao*. *Nat Genet* **43**:101-108.
- Benson G. 1999. Tandem repeats finder: a program to analyze DNA sequences. *Nucleic Acids Res* **27**:573-580.
- Beye M, Moritz RF. 1995. Characterization of honeybee (*Apis mellifera* L.) chromosomes using repetitive DNA probes and fluorescence in situ hybridization. *J Hered* **86**:145-150.
- Bratanich AC, Ellis JA, Blanchetot A. 2000. Representational differential analysis detects amplification of satellite sequences in postweaning multisystemic wasting syndrome of pigs. *J Vet Diagn Invest* **12**:328-331.
- Buckland RA. 1983. Comparative structure and evolution of goat and sheep satellite I DNAs. *Nucleic Acids Res* **11**:1349-1360.
- Carone DM, Longo MS, Ferreri GC, Hall L, Harris M, Shook N, Bulazel KV, Carone BR, Oberfell C, O'Neill MJ, *et al.* 2009. A new class of retroviral and satellite encoded small RNAs emanates from mammalian centromeres. *Chromosoma* **118**:113-125.
- Cellamare A, Catacchio CR, Alkan C, Giannuzzi G, Antonacci F, Cardone MF, Della Valle G, Malig M, Rocchi M, Eichler EE, *et al.* 2009. New insights into centromere organization and evolution from the white-cheeked gibbon and marmoset. *Mol Biol Evol* **26**:1889-1900.
- Chen D-, Ronald PC. 1999. A Rapid DNA Minipreparation Method Suitable for AFLP and Other PCR Applications. *Plant Molecular Biology Reporter* **17**:53-57.
- Cheng Z, Dong F, Langdon T, Ouyang S, Buell CR, Gu M, Blattner FR, Jiang J. 2002. Functional rice centromeres are marked by a satellite repeat and a centromere-specific retrotransposon. *Plant Cell* **14**:1691-1704.

- Ekes C, Csonka E, Hadlaczky G, Cserpán I. 2004. Isolation, cloning and characterization of two major satellite DNA families of rabbit (*Oryctolagus cuniculus*). *Gene* **343**:271-279.
- Fischer C, Ozouf-Costaz C, Roest Crollius H, Dasilva C, Jaillon O, Bouneau L, Bonillo C, Weissenbach J, Bernot A. 2000. Karyotype and chromosome location of characteristic tandem repeats in the pufferfish *Tetraodon nigroviridis*. *Cytogenet Cell Genet* **88**:50-55.
- Fishman L, Saunders A. 2008. Centromere-associated female meiotic drive entails male fitness costs in monkeyflowers. *Science* **322**:1559-1562.
- Gaillard C, Doly J, Cortadas J, Bernardi G. 1981. The primary structure of bovine satellite 1.715. *Nucleic Acids Res* **9**:6069-6082.
- Guenatri M, Bailly D, Maison C, Almouzni G. 2004. Mouse centric and pericentric satellite repeats form distinct functional heterochromatin. *J Cell Biol* **166**:493-505.
- Haaf T, Mater AG, Wienberg J, Ward DC. 1995. Presence and abundance of CENP-B box sequences in great ape subsets of primate-specific alpha-satellite DNA. *J Mol Evol* **41**:487-491.
- Hall SE, Kettler G, Preuss D. 2003. Centromere satellites from *Arabidopsis* populations: maintenance of conserved and variable domains. *Genome Res* **13**:195-205.
- Harrison GE, Heslop-Harrison JS. 1995. *Centromeric repetitive DNA sequences in the genus* .
- Hasson D, Alonso A, Cheung F, Tepperberg JH, Papenhausen PR, Engelen JJ, Warburton PE. 2011. Formation of novel CENP-A domains on tandem repetitive DNA and across chromosome breakpoints on human chromosome 8q21 neocentromeres. *Chromosoma* **120**:621-632.
- Heslop-Harrison JS, Murata M, Ogura Y, Schwarzacher T, Motoyoshi F. 1999. Polymorphisms and genomic organization of repetitive DNA from centromeric regions of *Arabidopsis* chromosomes. *Plant Cell* **11**:31-42.
- Jantsch M, Hamilton B, Mayr B, Schweizer D. 1990. Meiotic chromosome behaviour reflects levels of sequence divergence in *Sus scrofa domestica* satellite DNA. *Chromosoma* **99**:330-335.
- Jenkins G, Hasterok R. 2007. BAC 'landing' on chromosomes of *Brachypodium distachyon* for comparative genome alignment. *Nat Protoc* **2**:88-98.
- Jiang J, Nasuda S, Dong F, Scherrer CW, Woo SS, Wing RA, Gill BS, Ward DC. 1996. A conserved repetitive DNA element located in the centromeres of cereal chromosomes. *Proc Natl Acad Sci U S A* **93**:14210-14213.
- Kikuchi S, Tsujimoto H, Sassa H, Koba T. 2011. JcSat1, a novel subtelomeric repeat of *Jatropha curcas* L. and its use in karyotyping. *Chromosome Science* **13**:11-16.
- Kipling D, Mitchell AR, Masumoto H, Wilson HE, Nicol L, Cooke HJ. 1995. CENP-B binds a novel centromeric sequence in the Asian mouse *Mus caroli*. *Mol Cell Biol* **15**:4009-4020.
- Koo DH, Hong CP, Batley J, Chung YS, Edwards D, Bang JW, Hur Y, Lim YP. 2011. Rapid divergence of repetitive DNAs in *Brassica* relatives. *Genomics* **97**:173-185.
- Krzywinski J, Sangaré D, Besansky NJ. 2005. Satellite DNA from the Y chromosome of the malaria vector *Anopheles gambiae*. *Genetics* **169**:185-196.

- Kuznetsova I, Podgornaya O, Ferguson-Smith MA. 2006. High-resolution organization of mouse centromeric and pericentromeric DNA. *Cytogenet Genome Res* **112**:248-255.
- Lee C, Wevrick R, Fisher RB, Ferguson-Smith MA, Lin CC. 1997. Human centromeric DNAs. *Hum Genet* **100**:291-304.
- Lee HR, Hayden KE, Willard HF. 2011. Organization and molecular evolution of CENP-A--associated satellite DNA families in a basal primate genome. *Genome Biol Evol* **3**:1136-1149.
- Lee HR, Zhang W, Langdon T, Jin W, Yan H, Cheng Z, Jiang J. 2005. Chromatin immunoprecipitation cloning reveals rapid evolutionary patterns of centromeric DNA in *Oryza* species. *Proc Natl Acad Sci U S A* **102**:11793-11798.
- Lim KB, Yang TJ, Hwang YJ, Kim JS, Park JY, Kwon SJ, Kim J, Choi BS, Lim MH, Jin M, *et al.* 2007. Characterization of the centromere and peri-centromere retrotransposons in *Brassica rapa* and their distribution in related *Brassica* species. *Plant J* **49**:173-183.
- Locke DP, Hillier LW, Warren WC, Worley KC, Nazareth LV, Muzny DM, Yang SP, Wang Z, Chinwalla AT, Minx P, *et al.* 2011. Comparative and demographic analysis of orang-utan genomes. *Nature* **469**:529-533.
- Matzke MA, Varga F, Berger H, Scherthaner J, Schweizer D, Mayr B, Matzke AJ. 1990. A 41-42 bp tandemly repeated sequence isolated from nuclear envelopes of chicken erythrocytes is located predominantly on microchromosomes. *Chromosoma* **99**:131-137.
- Meyer JM, Kurtti TJ, Van Zee JP, Hill CA. 2010. Genome organization of major tandem repeats in the hard tick, *Ixodes scapularis*. *Chromosome Res* **18**:357-370.
- Musich PR, Brown FL, Maio JJ. 1980. Highly repetitive component alpha and related alphoid DNAs in man and monkeys. *Chromosoma* **80**:331-348.
- Nagaki K, Cheng Z, Ouyang S, Talbert PB, Kim M, Jones KM, Henikoff S, Buell CR, Jiang J. 2004. Sequencing of a rice centromere uncovers active genes. *Nat Genet* **36**:138-145.
- Niedermaier J, Moritz KB. 2000. Organization and dynamics of satellite and telomere DNAs in *Ascaris*: implications for formation and programmed breakdown of compound chromosomes. *Chromosoma* **109**:439-452.
- Novak U. 1984. Structure and properties of a highly repetitive DNA sequence in sheep. *Nucleic Acids Res* **12**:2343-2350.
- Pathak D, Srivastava J, Premi S, Tiwari M, Garg LC, Kumar S, Ali S. 2006. Chromosomal localization, copy number assessment, and transcriptional status of BamHI repeat fractions in water buffalo *Bubalus bubalis*. *DNA Cell Biol* **25**:206-214.
- Plucienniczak A, Skowroński J, Jaworski J. 1982. Nucleotide sequence of bovine 1.715 satellite DNA and its relation to other bovine satellite sequences. *J Mol Biol* **158**:293-304.
- Roest Crollius H, Jaillon O, Dasilva C, Ozouf-Costaz C, Fizames C, Fischer C, Bouneau L, Billault A, Quetier F, Saurin W, *et al.* 2000. Characterization and repeat analysis of the compact genome of the freshwater pufferfish *Tetraodon nigroviridis*. *Genome Res* **10**:939-949.
- Samonte RV, Ramesh KH, Verma RS. 1997. Comparative mapping of human alphoid satellite DNA repeat sequences in the great apes. *Genetica* **101**:97-104.

- Shang WH, Hori T, Toyoda A, Kato J, Popendorf K, Sakakibara Y, Fujiyama A, Fukagawa T. 2010. Chickens possess centromeres with both extended tandem repeats and short non-tandem-repetitive sequences. *Genome Res* **20**:1219-1228.
- Spence JM, Blackman RL, Testa JM, Ready PD. 1998. A 169-base pair tandem repeat DNA marker for subtelomeric heterochromatin and chromosomal rearrangements in aphids of the *Myzus persicae* group. *Chromosome Res* **6**:167-175.
- Sternes KL, Vig BK. 1995. Satellite I DNA in transformed rat cells. *Cancer Genet Cytogenet* **79**:64-69.
- Sun X, Le HD, Wahlstrom JM, Karpen GH. 2003. Sequence analysis of a functional *Drosophila* centromere. *Genome Res* **13**:182-194.
- Tanaka K, Matsuda Y, Masangkay JS, Solis CD, Anunciado RV, Namikawa T. 1999. Characterization and chromosomal distribution of satellite DNA sequences of the water buffalo (*Bubalus bubalis*). *J Hered* **90**:418-422.
- Taparowsky EJ, Gerbi SA. 1982. Structure of 1.71 lb gm/cm³ bovine satellite DNA: evolutionary relationship to satellite I. *Nucleic Acids Res* **10**:5503-5515.
- Tarès S, Cornuet JM, Abad P. 1993. Characterization of an unusually conserved AluI highly reiterated DNA sequence family from the honeybee, *Apis mellifera*. *Genetics* **134**:1195-1204.
- Tek AL, Jiang J. 2004. The centromeric regions of potato chromosomes contain megabase-sized tandem arrays of telomere-similar sequence. *Chromosoma* **113**:77-83.
- Tek AL, Kashihara K, Murata M, Nagaki K. 2010. Functional centromeres in soybean include two distinct tandem repeats and a retrotransposon. *Chromosome Res* **18**:337-347.
- Teschke C, Solleder G, Moritz KB. 1991. The highly variable pentameric repeats of the AT-rich germline limited DNA in *Parascaris univalens* are the telomeric repeats of somatic chromosomes. *Nucleic Acids Res* **19**:2677-2684.
- Ugarković D, Podnar M, Plohl M. 1996. Satellite DNA of the red flour beetle *Tribolium castaneum*--comparative study of satellites from the genus *Tribolium*. *Mol Biol Evol* **13**:1059-1066.
- Viñas A, Abuín M, Pardo BG, Martínez P, Sánchez L. 2004. Characterization of a new HpaI centromeric satellite DNA in *Salmo salar*. *Genetica* **121**:81-87.
- Wade CM, Giulotto E, Sigurdsson S, Zoli M, Gnerre S, Imsland F, Lear TL, Adelson DL, Bailey E, Bellone RR, *et al.* 2009. Genome sequence, comparative analysis, and population genetics of the domestic horse. *Science* **326**:865-867.
- Young HA, Hernlem BJ, Anderton AL, Lanzatella CL, Tobias CM. 2010. Dihaploid stocks of switchgrass isolated by a screening approach. *BioEnergy Research* **3**:305-313.
- Young HA, Lanzatella CL, Sarath G, Tobias CM. 2011. Chloroplast genome variation in upland and lowland switchgrass. *PLoS One* **6**:e23980.
- Zhang, P., and Friebe, B. 2009. *FISH on Plant Chromosomes. In Fluorescence In Situ Hybridization (FISH) - Application Guide, Liehr T, ed (pp. 365 - 394).* Springer Berlin Heidelberg.
- Zhang W, Friebe B, Gill BS, Jiang J. 2010. Centromere inactivation and epigenetic modifications of a plant chromosome with three functional centromeres. *Chromosoma* **119**:553-563.

- Zhang W, Lee HR, Koo DH, Jiang J. 2008. Epigenetic modification of centromeric chromatin: hypomethylation of DNA sequences in the CENH3-associated chromatin in *Arabidopsis thaliana* and maize. *Plant Cell* **20**:25-34.
- Zhong CX, Marshall JB, Topp C, Mroczek R, Kato A, Nagaki K, Birchler JA, Jiang J, Dawe RK. 2002. Centromeric retroelements and satellites interact with maize kinetochore protein CENH3. *Plant Cell* **14**:2825-2836.
- Zwick MS, Islam-Faridi MN, Zhang HB, Hodnett GL, Gomez MI, Kim JS, Price HJ, Stelly DM. 2000. Distribution and sequence analysis of the centromere-associated repetitive element CEN38 of *Sorghum bicolor* (Poaceae). *Am J Bot* **87**:1757-1764.

Lithocarpus_calolepis TTTT-AGGTTTCGGGG 115
Lithocarpus_grandilifolius TTTTGGGTTTCGGAGG 114
**** * * * * * *

Candidate centromere repeat monomer:

>Lithocarpus_calolepis
TATTTTGGTCATTTTTGGGTTTCGGGGTATTTTGGTCATTTTTGGGTTTCGGGAGTA
TTTTGGTCATTTTTAGGTTTCGGGGTATTTTGGTAATTTTTAGGTTTCGGGGG
>Lithocarpus_grandilifolius
TATTTTGGTAATTTTTGTTTTCGAGGGTATTTTGGTCATTTTTAGGTTTCGGGGGTATT
TTGGTCATTTTTGGGTTTCGGGGTATTTTGGTCATTTTTGGGTTTCGGAGG

Beechs 2

Lithocarpus_balansae TTTGAGCCCTTACATCGGCACGAAATTGGAATCCAATTCGGGTAACTC 50
Lithocarpus_hancei TTTGAGCCCTTATATCGGCACAAAATTGGAATCCAATTCGGGTAACTC 50
Lithocarpus_xylocarpus TTTACGCCTTATATCGGCACAAAATTGGAGTCCAATTCGGGGAACTC 50
*** **

Lithocarpus_balansae GGTGGCCACATTCAAACGAGGATAACTCTCCCGATTTTTATCAAAAAA 100
Lithocarpus_hancei AGTGGCCCATATTCAAACGATAAATAACTCTCATGATTTTTGTTCGAAAAA 100
Lithocarpus_xylocarpus GGTGGCCCATATTCAAACGACAATAACTCTCTTGATTTTTATCGAAAAA 100
***** **

Lithocarpus_balansae TACAAAATTTGTGCTCAAATTCAAGCTCAGGATGTCTACTTTCTAAAACA 150
Lithocarpus_hancei TACAAAATTTGTGTTCAAATTCAAGCTCAGGACGTCTACTTTCTAAAACA 150
Lithocarpus_xylocarpus CACCAAATTTGTGTTCAAATTCAAGCTCAGAATGTCTACTTTCTAAAATA 150
** ***** *

Lithocarpus_balansae CGAAGGCCGCGTCAAAGAATTCCTCACGGTTCAAAGTTATTGACGAAAC 200
Lithocarpus_hancei CTTAGGCCGCGTTAAAGAATTCCTTTCGGTTCAAAGTTATTGACGAAAC 200
Lithocarpus_xylocarpus TTAAGGCCGCGTTGAAGAATTCCTCACGGTTCAAAGTTATTGACGAAAC 199
***** **

Lithocarpus_balansae GGTGGCCAAAGCACAATTTTCGTCACACTTCCTAACCGATTAACGCCCGC 250
Lithocarpus_hancei GGTGGCCAAAGGTCATTTTCGTCACACTTCCTAACCGATTAACGCTCGT 250
Lithocarpus_xylocarpus GGCGACCAAAGGTCATTTTCGACACATTTCCAAACCGATGAAGGCTCGT 249
** * ***** **

Lithocarpus_balansae GGATAACTACCCACTCACGTATTTTTTCCCGAAACTTGATTTTGGGAAG 300
Lithocarpus_hancei GGATAACAACCCACTCACATATTTTTTCCCGAAACTTGATTTTGGGAAG 300
Lithocarpus_xylocarpus GAATAACTACCCACCAAAGTATTTTTTACACAAAATTCACTTTGAGAGG 299
* ***** * ***** *

Lithocarpus_balansae ATTGATCTCGCGATATAGGAAAAATATTTCCAGCCAAATTCGTGAGCAA 350
Lithocarpus_hancei ATTGATCTCGCGATGTAGGAAAAATATTTTCATGCACAAATTCGTGAGCAA 350
Lithocarpus_xylocarpus ATTGACCTCAAGATATAGAAAAATATTTTCATCGCCAAATCCGAGAAAAA 349
***** **

Lithocarpus_balansae AACTTCAAATTCCTCCCT 367
Lithocarpus_hancei AACACAGACTTCTCCT 367
Lithocarpus_xylocarpus AACCTAGACATCAATG 366
*** * * *

Candidate centromere repeat monomer:

>Lithocarpus_balansae
TTTGAGCCCTTACATCGGCACGAAATTGGAATCCAATTCGGGTAACCTCGGTGGCCAC
ATTCAAACGAGGATAACTCTCCCGATTTTTATCAAAAAATACAAAATTTGTGCTCAAAT
TCAAGCTCAGGATGTCTACTTTCTAAAACACGAAGCCGCGTCAAAGAATTCCTCACGGT
TCAAAAAGTTATTGACGAAACGGTGGCCAAAGCACACTTTTCGTCACACTTCCTAACCGAT
TAACGCCCGGGATAACTACCCACTCACGTATTTTTTCCCGAAACTTGATTTTGGGAAG
ATTGATCTCGCGATATAGGAAAAATATTTCCAGCCAAATTCGTGAGCAAATTCAAAC
TTCCCT
>Lithocarpus_hancei
TTTGAGCCCTTATATCGGCACAAAATTGGAATCCAATTCGGGTAACCTCAGTGGCCAT
ATTCAAACGATAATAACTCTCATGATTTTTGTTCGAAAAATACAAAATTTGTGTTCAAAT
TCAAGCTCAGGACGTCTACTTTCTAAAACACTTAGGCCGCGTTAAAGAATTCCTTTCGGT
TCAAAAAGTTATTGACGAAACGGTGGCCAAAGGTCACTTTTCGTCACACTTCCTAACCGAT
TAACGCTCGTGGATAACAACCCACTCACATATTTTTTCCCGAAACTTGATTTTGGGAAG
ATTGATCTCGCGATGTAGGAAAAATATTTTCATGCACAAATTCGTGAGCAAACACAGAC

TTCTCCT
>Lithocarpus_xylocarpus
TTTACGCCTTTATATCGGCACAAAATTGGAGTCCAATTTTCGGGAACTCGGTGGCCCAT
ATTCAAACGACAATAACTCTCTGATTTTATCGAAAAACACCAAATTTGTGTTCAAAT
TCAAGCTCAGAATGTCTACTTTCTAAAAATTAAGGCCGCTTGAAGAATTCCTACGGT
TCAAAGTTATTGTCAAAGGGCGACCAAAGGTCACTTTTCGACACATTTCAAACCGATG
AAGGCTCGTGAATAACTACCCACCAAAGTATTTTTTACACAAAACCTCACTTTGAGAGGA
TTGACCTCAAGATATAGAAAAATATTTTCATCGCCAAATCCGAGAAAAAACCTTAGACA
TCAATG

Potato

Solanum_tuberosum CGTTAAGACCTTAGCTATGGAGCCAGTTAGCCCTCACGGCCAAAACGTCCCATTTTAAAG 60
Solanum_phureja CGTTAAGACCTTAGCTATGGAGCCAGTTAGCCCTCACGGCCAAAACATCCCATTTTGAAG 60

Solanum_tuberosum GTCAAATGTGCCCAAATCAGGAAAACCCCAATTTTGTGCGATTTTCGTATGCTATAGTC 119
Solanum_phureja GTCAAATGTGCCCCAGAGCAGGTAACCCCAATTTTGTGCGATTTTCGTGCTATAGTC 120

Solanum_tuberosum CATGGACTTTTGGTGATCTGGAATTCGACAAAATTTT-GCCAAAATTTTTCGTGGACG 178
Solanum_phureja CATGGACTTTTGGTGATCTGGAATTCGACATAATTTTTCGCAAAATTTTTCATGGACG 180

Solanum_tuberosum TC 180
Solanum_phureja TC 182
**

Candidate centromere repeat monomer:

>Solanum_tuberosum
CGTTAAGACCTTAGCTATGGAGCCAGTTAGCCCTCACGGCCAAAACGTCCCATTTTAAAG
GTCAAATGTGCCCAAATCAGGAAAACCCCAATTTTGTGCGATTTTCGTATGCTATAGTCC
ATGGACTTTTGGTGATCTGGAATTCGACAAAATTTTTCGCAAAATTTTTCGTGGACGTC
>Solanum_phureja
CGTTAAGACCTTAGCTATGGAGCCAGTTAGCCCTCACGGCCAAAACATCCCATTTTGAAG
GTCAAATGTGCCCCAGAGCAGGTAACCCCAATTTTGTGCGATTTTCGTGCTATAGTCC
CATGGACTTTTGGTGATCTGGAATTCGACATAATTTTTCGCAAAATTTTTCATGGACG
TC

Monkeyflower

Mimulus_guttatus CTTTGATCATTTTGTCTTCTGGACACCTAATTTTCGATTTGTACCTAAAAGATACCAA 60
Mimulus_laciniatus CTTTGATCATTTTGTCTTCTGGACACCTAATTTTCGATTTGTACCTATAAGATACCAA 60
Mimulus_dentilobus CTTTGATCATTTTGTCTTCTGGACACCTAATTTTCGATTTGTACCTATAAGATACCAA 60

Mimulus_guttatus TCCACCAATAAAAACAGAAATATAAATTAATCCAACAAAAATCCACGTAAACGTAAACG 120
Mimulus_laciniatus TCCACCAATAAAAACAGAAATATAAATTAATCCAACAAAAATCCACGTAAACGTAAACG 120
Mimulus_dentilobus TCCACCAATAAAAACAGAAATATAAATTAATCCAACAAAAATCCACGTAAACGTAAACG 120

Mimulus_guttatus TTGAGTGTTATTTCTACACTCCACTGTATCTTTTGTATCTAGTGTTTTGTGTTGTTG 180
Mimulus_laciniatus TCGAGTTTATTTCTACACTCCACTGTATCTTTTATCTAGTGTTTTGTGTTGTTG 180
Mimulus_dentilobus TAGAGTGTTATTTCTACACTCCACTGTATCTTTTATCTAGTGTTTTGTGTTGTTG 180
* ****

Mimulus_guttatus GTTATGCGTATTAAGTCTAGTATTGTAGTTTCGTGTTTTAAGAACGTTGTTGCGAATG 240
Mimulus_laciniatus TTGATGCGTATTAAGTCTAGTATTGTAGTTTCGTGTTTTAAGAACGTTGTTGCGGATG 240
Mimulus_dentilobus TTGATGCGTATTAAGTCTAGTATTGTAGTTTCGTGTTTTAAGAACGTTGTTGCGAATG 240
* ****

Mimulus_guttatus CACTTTTGGCGATGTTTTTTTACATGTACGTTTGTGCATGTCCATTTGAGCGAGTGTGTT 300
Mimulus_laciniatus CACTTTTGGCGATGTTTTTTTACATGTACGTTTGTGCATGTCCATTTGAGGGAGTGTGTT 300
Mimulus_dentilobus CACTTTTGGCGATGTTTTTTTACATGTACGTTTGTGCATGTCCATTTGAGCGAGTGTGTT 300

```

Mimulus_guttatus      TGTGCATGTTTGTGATTGTATTAATGTCCTAGGATTGTAGTTGTGTTTTTCATGATCC 360
Mimulus_laciniatus    TGTGCATGTTTGTGATTGTATTAATGTCCTAGGATTGTAGTTGTGTTTTTCATGATCC 360
Mimulus_dentilobus    TGTGCATGTTTGTGATTGTATTAATGTCCTAGGATTGTAGTTGTGTTTTTCATGATCC 360
*****

Mimulus_guttatus      TTTTTCGGAATGCACTTTTGCCTGAGTACTTTTGTGCATGCTTTTGAACCTTTTACTCATG 420
Mimulus_laciniatus    TTTTTCGGAATGCACTTTTGCCTGAGTACTTTTGTGCATGCTTTTGTACTTTTACTTATG 420
Mimulus_dentilobus    TTTTTCGGAATGCACTTTTGCCTGAGTACTTTTATGCATGTTTTTGTACTTTTACTTATG 420
*****

Mimulus_guttatus      TGCCTATCTTTTCTAGCGAGTGTTTTTGTGCACGTTTCTTGATGCGCATTCATGTCCTCG 480
Mimulus_laciniatus    TGCCTATCTTTTCTAGCGAGTGTTTTTGTGCACGTTTCTTGATGCGCATTCATGTCCTCG 480
Mimulus_dentilobus    TGCCTATCTTTTCTAGCGAGTGTTTTTGTGCACGTTTCTTGATGCGCATTCATGTCCTCG 480
*****

Mimulus_guttatus      AACTGTAGCACGTATTTTCATGATCGCTTTTGGAAATCCAATTTTGACCATGTTTCGAGTCC 540
Mimulus_laciniatus    AATTGTAGTACGTATTTTCATGATCGCTTTTGTATCCAATTTTGACCATGTTTCGAGTCC 540
Mimulus_dentilobus    AACTGTAGTACGTATTTTCATGATCGCTTTTGGAAATCCAATTTTGACCATGTTTCGAGTCC 540
** *****

Mimulus_guttatus      GAATTTGGAATTTTGCAGTTAGACAGGAATTGTAGCCAAGTGAATAGCTTTCTAATGCC 600
Mimulus_laciniatus    GAATTTGGAATTTTGCAGTTAGACAGGAATTGTAGCCCGCTGAATAGCTTTCTAATGCC 600
Mimulus_dentilobus    GAATTTGGAATTTTGCAGTTAGACAGGAATTGTAGCCAAGTGAATAGCTTTCTAATGCC 600
*****

Mimulus_guttatus      ACCGGAACCAAGTTCGATTTGGAGTCCGGATGAGAAAGTTATG----- 641
Mimulus_laciniatus    GCCGGAACCAAGTTCGATTTGGAGTCCGGATGAGAGAGTTATGCTCGACTTCGTGGACACTA 660
Mimulus_dentilobus    GCCGGAACCAAGTTCGATTTGGAGTCCGGATGAGAAAGTTATGCTCGACTTCGTGGACACTA 660
*****

Mimulus_guttatus      -----TTTCTTAATTGCAACTCTT 660
Mimulus_laciniatus    CCAAAGATGTTGAGGGATTCTCTCTTCTAATTTGATTTATTTTCTTAATTGCAACTCTT 720
Mimulus_dentilobus    CCAAAGATGTTGAGGGATTCTCTCTTCTAATTTGATTTATTTTCTTAATTGCAACTCTT 720
*****

Mimulus_guttatus      TTCTTACC 668
Mimulus_laciniatus    TTCTTACC 728
Mimulus_dentilobus    TTCTTACT 728
*****

```

Candidate centromere repeat monomer:

```

>Mimulus_guttatus
CTTTGATCATTTTTGCTTCCTCGACACCTAATTTTCGATTTGTACCTAAAAGATACCAAAA
TCCACCAATAAAAACAGAAATATAAATTAATCCAAAACAAAAATCCACGTAAACGTAAACG
TTGAGTGTATTCTTACACTCCACTGTATCTTTTGTATCTAGTGTTTTGTGCTGTTGTTTG
GTTATGCGTATTAAGTCCCTAGTATTGTAGTTCGTGTTTTTAAAGACGTTGTTGCGAATG
CACTTTTGGCGCATGTTTTTTACATGTACGTTTGTGCATGTCCATTTGAGCGAGTGTGTT
TGTGCATGTTTGTGATTGTATTAATGTCCTAGGATTGTAGTTTGTGTTTTTCATGATCC
TTTTTGCGAATGCACTTTTGCCTGAGTACTTTTGTGCATGCTTTTGAACCTTTTACTCATG
TGCGTATCTTTTCTAGCGAGTGTTTTTTGTGCACGTTTCTTGATGCGCATTCATGTCCTCG
AACTGTAGCACGTATTTTCATGATCGCTTTTGGAAATCCAATTTTGACCATGTTTCGAGTCC
GAATTTGGAATTTTGACGTTAGACAGGAATTGTAGCCAAGTGAATAGCTTTCTAATGCC
ACCGGAACCAAGTTCGATTTGGAGTCCGGATGAGAAAGTTATGTTCTTAATTGCAACTCTT
TTCTTACC
>Mimulus_dentilobus
CTTTGATCATTTTTGCTTCCTCGACACCTAATTTTCGATTTGTACCTATAAGATACCAAAA
TCCACCAATTAACAGAAATATAAATTAATCCAAAACAAAAATCCACGTAAACGTAAACG
TAGAGTGTATTCTTACACTCCACTGTATCTTTTTTATCTAGTGTTTTGTGCTGTTGTTTG
TTGATGCGTATTAAGTCCCTAGTATTGTAGTTCGTGATTTTAAAGACGTTGTTGCGAATG
CACTTTTGGCGCATGTTTTTTACATGTACGTTTGTGCATGTCCATTTGAGCGAGTGTGTT
TGTGCATGTTTGTGATTGTATTAATGTCCTAGGATTGTAGTTTGTGTTTTTCATGATCC
TTTTTGCGAATGCACTTTTGCCTGAGTACTTTTATGCATGTTTTTGTACTTTTACTTATG
TGCGTATCTTTTCTAGCGAGTGTTTTTTGTGCACGTTTCTTGATGCGCATTCATGTCCTCG
AACTGTAGTACGTATTTTCATGATCGCTTTTGGAAATCCAATTTTGACCATGTTTCGAGTCC
GAATTTGGAATTTGCCATTAGACGGGAATTGTAGCCAAGTGAATAGCTTTCTAATGCC
GCCGGAACCAAGTTCGATTTGGAGTCCGGATGAGAAAGTTATGCTCGACTTCGTGGACACTA
CCAAAGATGTTGAGGGATTCTCTCTTCTAATTTGATTTATTTTCTTAATTGCAACTCTT
TTCTTACT
>Mimulus_laciniatus
CTTTGATCATTTTTGCTTCCTCGACACCTAATTTTCGATTTGTACCTATAAGATACCAAAA

```

Drosophila_elegans ATAACTTTTCTGTTTTT---AACTTTTTGTTTAGTTCTTCGACATATAGCAATGGTTAAA 109
 *** ** * * * ** * *** ** * * * * * *

Drosophila_virilis TACTCCTCATATATATGCAAAATCCTATTAAGATCGGACC 153
Drosophila_elegans TATTCAGAATTACGGTTTAAATTCATCAAAATCGGACG 149
 ** * * * * **** ** ** * *****

Candidate centromere repeat monomer:

>Drosophila_virilis
ACTATATCATATAGCTGCCATAGGAACGATCGGTCGAAAATTAAGTTTTGTATGAAAA
CATTTTTGTTTTCAAGATATCTTGACCAAACCTCGGCATTTATTAGTTTTACTATACTCCT
CATATATATGCAAAATCCTATTAAGATCGGACC
>Drosophila_elegans
ACTATATCATATAGCTCCCATAGGAACAATCGAAAATAAATGAAAAAATTATAACTTT
TCTGTTTTTAACTTTTGTTTAGTTCTTCGACATATAGCAATGGTTAAATATTCAGAAT
TACGGTTTAAATTCATCAAAATCGGACG

Wasps

Nasonia_giraulti CGCTTTGGTTTTAGATTTTATACTCGCTTCGCTCGCCTTCCTTCGATGTGCCGAGGTGT 60
Nasonia_longicornis CGCTTTGGTTTTAGATTTTATACTCGCTTCGCTCGCCTTCCTTCGATGTGCCGAGGTGT 60
Nasonia_vitripennis CGCTTTGGTTTTGATTT-ATACTCGCTTGCTCGCCTTCCTCCGATGTGCCGAGGTGT 59
 ***** ***** ***** ***** *****

Nasonia_giraulti TTTTAAATAAATTATTGAGCTCGGGGAGCGTGGTGTAGTTGGGTTTAAAG 109
Nasonia_longicornis GATTAATAAATTATTGAGCTCGGGGAGCGTGGTGTAGTTGGGTTTAAAG 109
Nasonia_vitripennis GTTTAAATAAATTATTGAGCTCGGGGAGCGTGGTGTAGTTGGGTTTAAAG 108

Candidate centromere repeat monomer:

>Nasonia_giraulti
CGCTTTGGTTTTAGATTTTATACTCGCTTCGCTCGCCTTCCTTCGATGTGCCGAGGTGT
TTTTAAATAAATTATTGAGCTCGGGGAGCGTGGTGTAGTTGGGTTTAAAG
>Nasonia_longicornis
CGCTTTGGTTTTAGATTTTATACTCGCTTCGCTCGCCTTCCTTCGATGTGCCGAGGTGT
GATTAATAAATTATTGAGCTCGGGGAGCGTGGTGTAGTTGGGTTTAAAG
>Nasonia_vitripennis
CGCTTTGGTTTTGATTTATACTCGCTTTGCTCGCCTTCCTCCGATGTGCCGAGGTGTG
TTTTAAATAAATTATTGAGCTCGGGGAGCGTGGTGTAGTTGGGTTTAAAG

Zebrafish

Danio_erio ATTTTCACTTGCAACTTGCTTTAA---CATGTTAACAGTGCATGAATTGTT--GTCT 53
Danio_nigrofasciatus ATTTTCACTTTCTCTTGCTCTGAAAAGCGTGTTTAGAGTTGCCTGTACTGTTAGTGATC 60
Danio_albolineatus ATTTTCACTTGCAAGTTGTTAAAA---CATGCTTAATACAGCATGCACTGTG--TTTT 54
 ***** * *** * * * * * ** * * * * * *

Danio_erio AAAACAAAAAAGAATGATGCATTTTATGGCTGGATC--GTTTT-ATCACTTTCTGAATTG 110
Danio_nigrofasciatus AAAACAAAAA-GAATGATGGTTTTCATCATTCTTTTGTGTTGATCACTCTCTGTCTG 119
Danio_albolineatus TAAACTTAAA-GAATGATGATTTTCACTGTTTAAAGCAAATCTGTCACTTGCTCTTTT 113
 **** * * * * * * * * * * * * * * *

Danio_erio G-ACGTTGAAAATGAGCTTATCTCAG---CCAGCAGAGAGTCA---AATCACAGTAAT 162
Danio_nigrofasciatus G-GCCCTCTAAACG----TGTTTTAA---TAAGTTGCAAGTGAC----AATCA--GCAGA 165
Danio_albolineatus GCACCTACCAAGC-----TCTGAAAAGCAAGTTGCAGAATCTAGGAATTG--ACAAT 164
 * * ** * * * * * * *** *

Danio_erio GCAAACCTCAGTCAGAGACATAG--- 184
Danio_nigrofasciatus TCTGGCTGAGTTGCCATACGTGT- 190
Danio_albolineatus TATGAAACA--TTATCCTTTTGCTTA 188
 * *

Candidate centromere repeat monomer:

>danio_erio
TAAAACGATCCAGCCATAAAATGCATCATTCTTTTTGTTTTAGACAACAATTCATGCAC
TGTTAAACATGTTAAAGCAAGTTGCAAGTGAATCTATGTCTGACTGAGTTGCATT
ACTGTGATTTGACCTCTCTGCTGGCTGAGATAAGCTCATTTTCAACGTCCAATTCAGAAA
GTGA
>Danio_albolineatus
TTTAAAGCAAATTCGTCACTTGCTCTTTTTGCACTTACCAAGCTCTGAAAAGCAAGTTGC

```

Bison_bison          G-ACGTGGCCT--CGTGGGTGGTTCC-ACATTCCGAAGGAC-CCCGATTTCGGGTCCCC 445
Bos_taurus_taurus   G-ACGTGGCCT--CGTGGGTGCTTCC-ACATTGCGAAGCAC-CCCGATTTCGGGTCCCC 450
Bos_grunniens       GGACGTGGCCT--CGTGGGTGGTTCC-ACATTGCGTAAGACACCCGATTTCGGGTCCCC 449
Bos_taurus_indicus  --ACGTGCCCTCCGTGGGTGGTTCCACATT-CGTAGGAC-CCCGATTCCC--GTCCCC 448
      ***** *
      ***** *

Bison_bison          TCTTG-ATAAGAACCCGATGCCCGGACACCTCTT-CGAACCTCCACCCTGTGAATGAAGT 503
Bos_taurus_taurus   TCTTG-GTAAGAACCCGATGCCCGGACACCTCT--CGAAC-TCCACCCTGTGAATGAGGT 506
Bos_grunniens       TCTTG-ATAAGAACCCGATGCCCGGACACCTCTTCCGAAC-TCCACCCTGTGAATGAAGT 507
Bos_taurus_indicus  TCCTGGATAAGAACCCGATGCCCGACCACCTCTC-CGAACCTCAACCCTG-GAATGAAGT 506
      ** *
      ***** *

Bison_bison          CAACACGAAGGGCAGTGACTCGCCCGTGCATCGTCCGGAAAAAACCCCCAGGTTCAAA 563
Bos_taurus_taurus   CAACACGAAGGGGCAGTG-CCC GCCCGTGCATCGTCCGGAAAGAACCCCCAGGTTCAAA 565
Bos_grunniens       CAACACGAAGGGGCAGTGACTCGCCCGTGCATCGTTCCGGGAAAAAACCCCCAGGTTCAAA 567
Bos_taurus_indicus  CAACACGAAGGGCCAAT---TTTTCCGTGCATCGTTCAGAAAAA---CCAG-TTCCAAA 559
      ***** *
      ***** *

Bison_bison          TACCGCTCGACAAGT-GGCCTGTCT-CCCCGGGAAACACCTCGAGAGGCAAGCGGAGTTC 621
Bos_taurus_taurus   TACAGCTCGACAAGT-GGCCTCTCT-CCCCGGGGA-CACCTCGAGAGGCAAGCGGAGTTC 622
Bos_grunniens       TACAGCTCGACAATG-GGCCTCTCT-CCCCGGGGA-CACCTCGAGAGGCAAGCGGAGTTC 624
Bos_taurus_indicus  TACAGCTCGACAAGCCGGCTCTTCTTCCCCGGGACCATCTCGAGATGCAAGCGGAGTTC 619
      *** *****
      ***** *

Bison_bison          CATGCCTCA--CCCAAGACGAGG-CCTGACTCTCCCTGTCCCAAGTCTGCAGGGACCTTG 678
Bos_taurus_taurus   CATGCCTCAA--CCCAAGACGAGGACCTGACTCTCC-TGTCCCAGTCTGCAGGGACCTTG 680
Bos_grunniens       CATGCCTCAA--CCCAAGACGAGG-CCTGACTCTCC-TGTCCCAGTCTGCAGGGACCTTG 681
Bos_taurus_indicus  CATGCCTCAAACCAAGACAG---CCGACTCTCC-TGTCCCAGTCTGCAGA---CCTG 671
      ***** *
      ***** *

Bison_bison          CGAT-CAGAGTCTGAAGTCAAGGAAACCTGAGGTTCC-TGCC TCAACTGGAGATG-AGG 735
Bos_taurus_taurus   CGATTCCGAGTCTGAAATCAGAGGAAACCTGAGGTTCC-TGCC TCAACTGGAGATGAGG 739
Bos_grunniens       CGAT-CGG--TCTGAAATCAGAGGAAACCTGAGGTTCC-TGCC TCAACTGGAGATG-AGG 736
Bos_taurus_indicus  CGATCGGAAGTCTGAA-TCA-AGGTACCTGCGGTTCCGCCCTCAACTGGAGATG-AGG 728
      ****
      ***** *

Bison_bison          CCCTCTTCCAATGCACAAA-CCAGTGGGAGTGCCGAGAAGCCC-TCCCA-CCTCCAGT 792
Bos_taurus_taurus   CCCTCTTCCAATGCACAAAACCCCGTGG-AGTCCCAGAGGGCCCTCCCA-CCTCCAGT 797
Bos_grunniens       CCCTCTTCCAATGCACAAA--CCCCATGG-AGTCCCAGAGGGCCCTCCCAAGCTCCAGT 793
Bos_taurus_indicus  CC-TCTTCCAATGCACAAAACCCAGTGG-GGTCCCAGAGGGCCCTCCCA-CCTCCAGG 785
      ** *****
      ***** *

Bison_bison          TTTCCCTGACTTCTCAGAGCC-ACCATGAGAAGCCCCCTGAGGTCACCTGCA-CAAGTCA 850
Bos_taurus_taurus   TC-CGCTGA-TTCTCAGAGCCCACCATGAGAAGCCCCCTGAGGTCACCTGCA-CAAGTCG 854
Bos_grunniens       TT-CCCTGACTTCTCAGAGCC-ACCATGAGAAGCCCCCTGAGGTCACCTGCA-CAAGTCG 850
Bos_taurus_indicus  TT-CCCTG-CCTTCTCAGAGCC-ACCATGAGAAGCCCCCTGAGGTCACCTGCAACAAGTCG 842
      * *
      ***** *

Bison_bison          AGGGAAGCCA--GGTTTCTGCCTCAACCCGAGAAGACC---TCGAGAGACCTTCTTCA 905
Bos_taurus_taurus   AGGGAAGCCAAGGGTTCCCTGCCTCAACCCGAGAAGACC---TCGAGAGACCTTCTTCA 911
Bos_grunniens       AGGGAA-CCA-GTGTTCCTGCCTCAACC-GAGAAAGACCCCTCGAGAGACCTTCTTCA 907
Bos_taurus_indicus  AGG-AAACCA-GGGTTTCTGCCTCAACC--GAAAAGACC---TCGAGAGACCTTCT-CA 894
      *** **
      ***** *

Bison_bison          ACA-CGTCTC-GAG-CCAGATTCCCTAACAGTGACTC-GAGA-GCAATGACGCGCTCCC 960
Bos_taurus_taurus   ACATCGTCTC-GAGGCCAGGTTCCT-TACCAG-GACTC-GAGG-GCAATGACGCGCTCCC 966
Bos_grunniens       ACA-CGTCTC-GAGGCCAGATTCCCTTACCAT-GACTCCGAGGACCAATGACGCGCTCCC 964
Bos_taurus_indicus  ACA-CGTCTCTGAGGCCAA--TCCC-TAACAT-GGCTCGGGAA TCCAGT GACGCGCTCCC 949
      *** *****
      ***** *

Bison_bison          CCTCGCCATTGCGCA-TGGAGACCCGACTTCCCTGGCGCCC-ACGAGAG--CTCACTGA 1016
Bos_taurus_taurus   CCTCGCCACT-CGCG-TGGAGACC-GACTTCCCTGGCGCCCCACGAGAGG-CTCACTGA 1022
Bos_grunniens       CCTCGCCACT-TGCA-TGGAGACC-GACTTCCCTGG-GCCCCACGAGAGG-CTCACTGA 1019
Bos_taurus_indicus  CCCCACCACTTCGCACTGGAGAACCCTGACTTCCCTGGCACCCACCAAGAGGCTCACTGA 1009
      *** *
      ***** *

```

```

Bison_bison          CCTCGCCGTCGTACT--AGGA-AAAACCGCACACTGTGGC-GCCAGCTCGA-GAACAA 1071
Bos_taurus_taurus   CCTCGCCGTCGCACCTC--GTGA-GAAACCGCACCTTGGGGCCCGGGCTCGA-GAACCA 1078
Bos_grunniens        CCTCGCCGTCGTACTC--GTGA-GAAACCGCACCTTGGGGCCGCC-GCTCGA-GAACAA 1074
Bos_taurus_indicus   CCTCGCCG-CGTACTCCAGTGAAGAAAACAC-CACCGGGCCGCC-GCTCGAAGAACAA 1066
***** ** * * * * * * * * * * * * * * * * * * * * * * * * * * * *

Bison_bison          --CCCTGAGCCCTCC-CCATCATCGCG-AGTTGAGGG-CCTTCGTCTCCTGTATGG-CCT 1125
Bos_taurus_taurus   --CCC-GAGACTCCC-CCGTCATCGCGGAGATGAGGG-CCTTCGTCTCCTGCATGGGCCT 1133
Bos_grunniens        --CCCCGAGACTCCC-CCGTCATCGCG-AGATGAGGGCCCTTCGTCTCCTGCATGG-CCT 1129
Bos_taurus_indicus   ACCCCCGAGAATTCCACCCTCATCGAG-AGATGAGGGCCCTCCGCCCTCCT--CAGGCCT 1122
***** ** * * * * * * * * * * * * * * * * * * * * * * * * * * * *

Bison_bison          AGA--GACCAA-TCT--CCTCGACTCTCTCAAACGCCTCAGGAGGCTTGACTCCCTTT 1180
Bos_taurus_taurus   AGA--G-CCAA-CCT--CGCGACTCTCTC-CAAACGCCTCAGGAGGCT-GACTCCCATTT 1185
Bos_grunniens        AGA--GACCAAATCT--CGCGACTCTCTC-CAAGCGCTCAGGAGGCTTGACTCCCTTT 1184
Bos_taurus_indicus   AGAAGGCCCAATCCTTCCGCGAACCTCTCCAAAACGCCTCAGA--GCCTGACTCCCTTC 1180
***** * **** * * * * * * * * * * * * * * * * * * * * * * * * * * * *

Bison_bison          ---AGTCC-ACCCAGTGAGCTCCAAGAGAT-ACCCGTGCG--GACTCGAGAGC-AGAGCG 1232
Bos_taurus_taurus   ---TGTCC-ACCCAGTGGAGCTCAAGAGAT-ACCCGTGCG--GACTCGGAGGC-AGAAAG 1237
Bos_grunniens        ---AGTCC-ACCCAGTGAGCTCCAAGAGAT-ACCCGTGCG--GATTCGAGAGC-AGGCGG 1236
Bos_taurus_indicus   GCGAGTCCCACCCAGTGGAGCCCAAGAGATGAACCGTCGCCTGATTCGAGAGCCAGAGCG 1240
***** ***** * * * * * * * * * * * * * * * * * * * * * * * * * * * *

Bison_bison          --GGGTTCTTTGCTTCCACT--CGACA-TGAATGC--TGTCTCCCCGGGTGCGTCTGGAA 1285
Bos_taurus_taurus   TTGGGTTCTGTTGCTTCCCT--CGAGA-TGAATGCC-TGTCTCCCCGGGTGCGTCTGGAA 1293
Bos_grunniens        --GGGTTCTTTGCTTCCACT--CGAGAATGAATGCC-TGTCTCCCCGGGTGCGTCT-GGA 1290
Bos_taurus_indicus   --GCCCTCTTTGCTTCCACTTCCGAGGTGAAATGCCTTGTCTCCCCGG-TG-GTCT--GA 1294
* ** ***** * * * * * * * * * * * * * * * * * * * * * * * * * * * *

Bison_bison          TTGCAACCCCTGAGATCCCTTTTCGCCCCCTGGAGAGGAA-CACTGG-CTTCTGGACACGAA 1343
Bos_taurus_taurus   ATGCCACCCCGAG-TCCCGGTGCGCCC-TGGAGAGGAA-CCTCGGGCTTCTGGGCAC-AA 1349
Bos_grunniens        ATGCAACCC-GAGATCCCTGTGCGCCC-TGGAGAGGAA-CATTGG-CTTCTGGACAC-AA 1345
Bos_taurus_indicus   ATGC-ACCCGAGATCC-TGTGCGCCT---GAGAGAAAACAATTG-CTTCTG--CACAAA 1346
***** **** * * * * * * * * * * * * * * * * * * * * * * * * * * * *

Bison_bison          GCCTAGA-TGA-GGTCTATT-GGCCCTGCA-GT-CACTCGA-GAGCAATCCCC-AGCTTT 1396
Bos_taurus_taurus   GCCTAGA-TGAAGTCTATCAGGCGCTGCAAGT-CACTCTG-GAGCAATCCCC-AGCTTT 1405
Bos_grunniens        GCCTAGA-TGA-TGTCTATT-GGCCCTGCA-GT-CACTCGA-GAGCAATCCCC-AGCTTT 1398
Bos_taurus_indicus   GCCTAGAATGA-GTCTATT-GGCCCTCA-GTACACTCGATGAGCAATCCCCAGCTTT 1403
***** **** * * * * * * * * * * * * * * * * * * * * * * * * * * * *

Bison_bison          CCTT-CGCAACTCG- 1409
Bos_taurus_taurus   TCTTTCGCAACTCG- 1419
Bos_grunniens        CCTT-CGCAACTCGA 1412
Bos_taurus_indicus   CCTTTCGCAACTCCA 1418
* * *****

```

Candidate centromere repeat monomer:

```

>Bison_bison
AATGGAAGATTGGACTTCCCTGGGCCAAACACAAGAGGCATCCTGAATTCCCCGTCGTAA
TTCGAGAAATCCTGCCGACTCGAGAAAATCCAGTGTTCGCCGTCATCGCAAGATGAA
GCCCTTTCCCGTACAGTGTCTCAGGAGAAGTCCCACGTTAGGTATTGGAGGTCGAAACG
GTACTTGGCACCTTGATGCGACCACAAAGTGCCCGACATCCCGGTCTCCCTCGAGAGG
AACACCGAAGTTTTCGCGACCACTTCTCTGAGCCCTTCTACCCTCCTGATCTGGACA
GGAGGTCGACTCCCCTGCTTTGCTTGAAGGGGTTCCTGACCTTCCGGTTCGACCTCAG
GATGAGGCGGGTCTCAGCAGCATTTTCAGACGTGGCTCGTGGGTGTTCCACATTC
GAAGACCCCGATTTCCCGTCCCTCTTGATAAGAACCCGATGCCCGACACCTCTTCG
AACCTCCACCCTGTGAATGAAGTCAACACGAAAGGGCAGTGACTCGCCCGTGCATCGTCG
GGAAAAAACCCAGGTTCCAAATACCGCTCGACAAGTGGCCTGTCTCCCGGGAACAC
CTCGAGAGGCAAGCGAGTTCCATGCCTCACCCAGACGAGGCTGACTTCCCTGTCCC
AAGTCTGCAGGACCTTTCGATCAGAGTCTGAAGTCAAGGAAACCTGAGGTTCTGCCT
CACTGGAGATGAGGCCCTTCCAATGCACCAACCCAGTGGGAGTCCGAGAAGCCCT
CCCACCTCCAGTTTCCCTGACTTCTCAGAGCCACCATGAGAAGCCCTGAGGTCACCT
GCACAAGTCAAGCGAGTTGAGGGCTTCGTCTCCTGTATGGCCTAGAGACCAATCTCCT
CTTCAACAGTCTCGAGCAGATTCCTTACAGTGAAGTCAAGGAAACCTGAGGTTCTGCCT
CCTCGCATTTGCGCATGGAGACCCGACTTCCCTGGCGCCACGAGAGCTCACTGACCTC
GCCGTCGTACTAGGAAAAACCGCACACTGTGGCGCCAGCTCGAGAACAACCTGAGCC
CTCCCATCATCGGAGTTGAGGGCTTCGTCTCCTGTATGGCCTAGAGACCAATCTCCT
CGACTCTCTCAACGCCTCAGGAGGCTTACTCCCTTTAGTCCACCAGTGAAGTCCA
AGAGATACCCGTCGACTCGAGAGCAGAGCGGGTCTTGTCTCCACTCGACATGAAT

```

GCTGTCTCCCGGGTGCCTGGAATTGCAACCTGAGATCCCTTTGCCCCCTGGAGAG
GAACACTGGCTTCTGGACACGAAGCCTAGATGAGGTCTATTGGCCCTGCAGTCACTCGAG
AGCAATCCCCAGCTTTCCTTCGCAACTCG

>Bos_taurus_taurus

AATGGAAGATTGGACTTCCCTGGGCAACACAAGAAGGCCATCACTGATTCCCCCGTTCGTA
ACTCGAGATTCCCGCCGCAAACTCGAGACACCAACGTGGATTCCCCCGTCAATCGCACAAAG
ATTGAAGCCCTTCCCGTACAGCGTCTCAGGAGAAGTCCCAGTTAGGAATTGAGCGGTG
GAACGGTACTTGGCACCTTGACGGCGGCCCAAAAGTTCGCCGGCATCCCGTCTCCCT
GGAGAGAACACCGAGTTTCCCGGACCCTTCTCTGAGCCCTTCTACCTCCTGATCT
CGACAGGGAGGGTTCGACTCCCTGCTTTGTCTGGAAGGGGTTCCCGACCTTCCGGTTCGCA
CCTCAGGATGAGGCGGGCTCACGACGACATTCCAGACGTGGCTTCGTGGGTGCTTCCAC
ATTGCGAAGCACCCCGATTTCCCGGTCCCTCTTGGTAAGAACCCGATGCCCGGACACCT
CTCGAATCCACCTGTGAATGAGGTCAACACGAAGGGGAGTCCCGCCCGTGCATCGT
CCGGAAAGAACCCCAAGTTCCAAATACAGCTCGACAGTGGCTTCTTCCCGGGGACA
CCTCGAGAGGCAAGCGGAGTTCATGCCTCAACCAAGACGAGGACCTGACTTCTCTGTC
CCCAGTCTGCAGGGACCTGCGATTTCGAGTCTGAAATCAGAGGAACCTGAGGTTCTCTG
CCTCAACTGGAGATGGAGGCCCTTTCATGCACCAAAACCCCGTGGAGTCCCGAGAGG
CCCTCCACCTCCAGTTCGCTGATTCTCAGAGCCACCATGAGAAGCCCTGAGGTC
ACCTGCACAAGTCGAGGAAGCAAGGGTTCCTGCCTCAACCCGAGAAAGACCTCGAGA
GACCTTCTTCAACCTCGTCTCGAGGCCAGGTTCCCTACCAGGACTCGAGGGCAATGACGC
GCTCCCTTCGCCACTCGCGTGGAGACCCGACTTCCCTGGCGCCACGAGAGGCTCACT
GACCTCGCGCTCGCACCTCGTGAGAAACCGCACCTGGGGCCCGCGCTCGAGAACCACC
CGAGACTCCCGCTCATCGGGAGATGAGGGCTTCGTCTCTGCATGGGCTAGAGCCA
ACCTCGGACCTCTCTCCAAACGCTCAGGAGGCTGACTCCATTTGTCCACCCAGTGA
GCTCAAGAGATACCCGTCGCACTCGGAGGCAGAAAGTTGGGTTGTTGCTTCCCTCGA
GATGAATGCCTGTCTCCCGGGTGCCTTGGAAATGCCACCCGAGTCCCGTTCGCCCT
GGAGAGGAACCTCGGGTTCGGGCACAAGCCTAGATGAAGGTCTATCAGGGCCTGCAAG
TCACTCTGGAGCAATCCCCAGCTTTTCTTCGCAACTCG

>Bos_taurus_indicus

AATGGAAGATTGAACTTGCCTGGGCAACCAAAAGGCATCCTGACTTCCCGTTCGTAAC
TCAGAATCCCGCCGTAACCTCGAGAAAACCAACGTGGCTCCCGTCCATCCGCAAGATG
AAGGCCCTTCCCGCAACAGCCGCGCTCCAGGAGAAGTCCACGTAGGATTGGAGGTGCA
AAGGGCACTTGGCGCCTTGATGCGACCCACAAAGTTCGCCGAAATCCCGGTCTCCCTC
GAGAGAACACTGAGGCTTTCGACCCCTCTCTGACCTTTCTCCCGTCTGAAATC
TGGACAGGAGTTCGACTCCCTGCTTGTCTGGAAGGGGTTCCGACCTTCCGTCCACCTCC
AGGAATGAGCGGTCTCAACGAAGACATTCCAACGTGCCCTCCGTGGGTGGTTCCCA
CATTCTGATAGACCCGATTTCCCGTCCCTCTGGATAAGAACCCGATGCCGGACACCTC
TCCGAATCCAACCTGGAATGAAGTCAACACGAAGGGCAATTTTTCCGTGCATCGTTC
AGAAAACCCAGTTCCAAATACAGCTCGACAAGCCGGTCTTCTTCCCGGGGACCATCT
CGAGATGCAAGCGGAGTTCATGCCTCAACCAAAAGACAGCCGACTTCTGTGCCAGTC
CTGCGACCTGCGATCGGAAGTCTGAATCAAGGTACCTGCGGTTCCGCCCTCAACTGG
AGATGAGGCTCTTCCATGACCAAAACCCAGTGGGTTCCCGAGAGGCCCTTCCACCT
CCAGGTTCCCTGCTTCTCAGAGCCACATGGAGAAGCCCTGAGGTCACTGCAACAAGT
CGAGAAACCCAGGGTCTCCCTGCCTCAACCGAAAGACCTCGAGAGACCTTCTCAACAGT
CTCTGAGGCCAATCCCTAACATGGCTCGGGAATCCAGTGACGCGCTCCCCCACCCTT
CGCACTGGAGAACCCGACTTCCCTGGCACCCACCAGAGGCCCTCACTGACCTCGCCGCT
ACCTCCAGTGAAGAAAACACCACCGGGCCCGCTCGAAGAACAACCCCGGAGAAATTC
CACCTCATCGAGAGATGAGGGCCCTCCGCCCTCAGGCTAGAAAGGCCAAATCTTCC
GCGAACCTTCCAAAAACGCTCAGAGCCTGACTCCCTTCGCGAGTCCACCCAGTGGAG
CCCAAGAGATGAACCGTGCCTGATTGAGAGCCAGAGGGCCCTCTTGCTTCCACTTC
CGAGGTGAAATGCCTTGTCTCCCGGTGGTCTGAATGCACCCGAGATCTGTCCGCCCTG
AGAGAAAACAATTGCTTTCGACAAAGCCTAGAATGAGTCTATTGGCCCTCCAGTACAC
TCGATGAGCAATCCCCAGCTTTCCCTTCGCAACTCCA

>Bos_grunniens

ATGGAAGATTGGACTTCCCTGGGCAACACAAGAGGCATCCTGAATTCCCGTTCGTAAC
CGAGAATCCCGCCGCAACTCGAGAAAACCAACGTGGTTCCCCGTCAATCGCAAGATGAAG
CCCTTTCGGCTACAGCTCTCAGGAGAAGTCCCAGTTAGGAATTGGAGGTGAAACGG
TACTTGGCCACCTTGATGCGACCCACAAGTTCGCCGACATCCCGTCTCCCTCGGAGAG
GAACCCCTGAGGTTTTCCGGCCACCACTTCTCTGAGCCCTTCTACCTCCTGATCTGG
ACAGGAGGTCGACTCCCTGCTTTTTCTGGAAGGGGTTCCCGACCTTCCGGTTCGCACCT
CAGGATGAGGCGGTCTCAGCAGACATTCCAGGACGTGGCCCTCGTGGGTGGTTCCACAT
TGCGTAAGACACCCGATTTCCCGTCCCTCTTGATAAGAACCCGATGCCCGGACACCTC
TTCCGAATCCACCTGTGAATGAAGTCAACACGAAGGGGAGTACTCGCCCGTGCATC
GTTCCGGGAAAACCCAGGTTCCAAATACAGCTCGACAATGGGCTCTTCCCGGGGA
CACCTCGAGAGGCAAGCGGAGTTCATGCCTCAACCAAGACGAGGCCCTGACTTCTCTGT
CCCAAGTCTCAGGGACCTGCGATCGGTCTGAATCAGAGGAACCTGAGGTTCTCTGCC
TCAACTGGAGATGAGGCCCTTTCATGCACCAACCCATGGAGTCCCGAGAGGCCCT
CCCAACCTCCAGTTTCCCTGACTTCTCAGAGCCACATGAGAAGCCCTGAGGTACCT
GCACAAGTCGAGGCAAGCGGAGTTCCTGCCTCAACCGAGAAAGACCCCTCGAGAGACC
TTCTTCAACAGTCTCGAGGCCAGATTTCCCTACCATGACTCCGAGGAGCAATGACGCGC
TCCCTCGCCACTTGCATGGAGACCCGACTTCCCTGGGCCCCACGAGAGGCTCACTGAC

CAAAAGAGTGTTCAAAAGTCTATGAAAAGAAAGGTTCAACTCTGTGAGTTGAAAGCACACATCACAAGAAGTTTCTGAGAATGCTTCTGTG
 TAGTTTTTATGTGAAGATATTTCTTTTCAAAGTAGGCTCAAAGCGCTCCAAATGTCCACTGCAGATTCTA
 >pan_troglodytes_troglodytes
 CAAAAGAGTGTTCAAAAGTCTATCAAAAGAAAGGTTCAACTCTGTGAGTTGAATGCACACATCACAAGAAGTTTCTGAGAATGCTTCTGTG
 TAGTTTTTATGTGAAGATATTTCTTTTCCACCATAGGCTCAAAGGGCTCCAAATATCCACTGCAGATTCTA
 >pan_troglodytes_schweinfurtii
 CAAAAGAGTGTTCAAAAGTCTATCAAAAGAAAGGTTCAACTCTGTGAGTTGAATGCACACATCACAAGAAGTTTCTGAGAATGCTTCTGTG
 TAGTTTTTATGTGAAGATATTTCTTTTCCAACATAGGCTCAAAGCGCTCCAAATATCCACTGCAGATTCTA
 >papio_hamadryas
 CAAGAAATAGGCTAGCGAAAGGATCCATGAGAAGAAAGATGTAACCTCTGTGAGATGAATTCACAGAACACAAGCAGTTTCTCAGAAAGCTTCTTTT
 CAGTTTTCATCTGAGGATATTTCTTTTCCACCATAGGCTCAATGGGCTTCCAAATATCACTTTTCAAATTTCA
 >pongo_abelii
 CAAAAGAGTGTTCAAAAGTCTCAATCAAAAGAAAGGTTCAACTCTGTGAGATGAATGCACACATCACAAGAAGTTTCTCAGAATGCTTCTGTG
 TAATTTTTATGTGAAGATATTTCTTTTCCACCATAGGCTCAAAGCGCTCCAAATATCCACTGCAGATTCTA
 >pongo_pygmaeus
 CAAAAGAGTGTTCAAAAGTCTCAATCAAAAGAAAGGTTCAACTCTGTGAGATGAATGCACACATCACAAGAAGTTTCTCAGAATGCTTCTGTG
 TAGTTTTTATGTGAAGATATTTCTTTTCCACCATAGGCTCAAAGCGCTCCAAATATCCCTTTGCAGATTCTA
 >Macaca_fascicularis
 CAAGAACTGTCTTAGCAAAGGCTTCTTGAGGGAAAGCTGTAACCTCTGTGAGATGATTTACAGAACACAAGCAGTTTCTCAGAAAGCTTCTTTCT
 CTTTTTATCTGAGGATATTTCTTTTCCCTATAGTCTTCTATGGGCTTCGAAATATCTCTTTTCCAATTCCA
 >ateles_geoffroyi
 CACAGAAAGGGTTTCTAAACTGTGCAAAACACACACGAGTTTAACTCTGTAAGTTGAATGCACACATTCACAAGCATTTCAGTTAGATTGCTCCGTTT
 TGGTTTTAGAGCGAGATATTTCTCTGTACAGCAAATGCTCCCTTTTCGCTCTGGAAAATCCAACGCAGTTTCTAGAGAAGAAAGCTTTGCTAACTCGC
 TGAATGAAACTCCGCTTACAGTCCCTTAGTTGAAACGAAACACACAGCAGAGCAGTTTGAATGATGCGTTTCTCTGTGTTTTAGACGCACTATTACT
 GCTTTTTCTGACGTGCTGGATTGGCTGGAATGACAGTTTTGCATCTCTG
 >callithrix_jacchus
 GAAGGAACGTGCTCCACTCTGAATCTAAACGCGGATTTCACTCCCTTAGTTAAGCGAACGCACAGGAGAGCAGTTTGAAGGATACGTTTCGTTTTG
 TGTTTTAGACGGAGATTTACAGTATTTCTGAAATGCTGGATTTGGCTGGAAAATGCGTTTCCGCTGCTTCACAGAAAGGGTTTACAAACTCCT
 GCAAACGCATATCAGTTTAACTCTGTAAGTTGAATGCACACATTTGAAGACCGTTCTGTAGGTAGCTGCGTTTTGGTTCTAGAAAGCAGATATTTCTC
 AATACAGCGTTTACTCCATTACAGCTGGAATAGCAAACGCAGCTCCTA
 >Saimiri_boliviensis
 GAAGAAACGTGTTTCTACTCGCTGAGACTGTTTCTACATTTCTTAAGAAAGGGTTTCTTAACTGCGTGCTTACACACATCTTTTTCCGTTGTTG
 AAACGCATTCTTACTGCTAACTTTATATGCGTCTTAGGGCTGGAATGACTGTTTCTGCAATTTCCAAAGAAAGGGTTTCTGAACTGCTGCAAAC
 ACACATCAGTTTAACTCTGGAAGTTGAATACACACATTTGACAACCATTTCTGTAGATAGCTCCGTTTTGGTTTTAGAGCAAGGATTTCTCTTTACA
 GCCTGTTCTCCATCCACTCTGGAATGTCCAACGCAGCTTTTA

 Mice

Mus_musculus	TAGGACGTGAAATATGGCGAGAAAACCTGAAAATCATGGAAAATGAGAAAT	50
Mus_famulus_domesticus	TAGGACCTGGAATATGGCAAAAACCTGAAAACGTGGAAAATGAGAAA	50
	***** * ***** * ** ***** * ** *****	
Mus_musculus	GCCCACTT	58
Mus_famulus_domesticus	TCACACTG	58
	* ****	

Candidate centromere repeat monomer:

>Mus_musculus
 TAGGACGTGAAATATGGCGAGAAAACCTGAAAATCATGGAAAATGAGAAATGCCCACTT
 >Mus_famulus_domesticus
 TAGGACCTGGAATATGGCAAAAACCTGAAAACGTGGAAAATGAGAAAATCACACTG

 Flying lemurs

cynocephalus_variegatus	CTCCCTGGAGGTTTCAGCTTCTGCAAGCCACTTTAACTTTAAGAAATGAGA	50
cynocephalus_volans	CTCCCCGGAGGTTTCAGCTTTCAGAAGCTAGTTTAACTTAAAGGAGGAAG	50
	***** ***** ***** ***** * ***** ***** * **	
cynocephalus_variegatus	GAGCAGAATATGCTTCTCACATCTAGCATGCAGGAATTCAGGTTTGCAAG	100
cynocephalus_volans	CAGCAGAATGTGCTTCTCACATCTAGCCTGTAGGAATTCAGGTTTGCAAG	100
	***** * ** ***** ***** * ***** ***** *****	
cynocephalus_variegatus	TTCTATGTGAAAGCCCATGAAAGCCTATGGGGGAAACGGCTTCTGAGACT	150
cynocephalus_volans	TTCTATGGGAAGCCCATGCTGCCTATGGTGGAAACGGCATGGGAGATT	150
	***** * ***** ***** ***** ***** * ***** *	
cynocephalus_variegatus	TCTGTTTCAAATCTCTGTCAAAGCATCAGAGAAGCTTCCCCGCTTAG	200
cynocephalus_volans	TCAGTTTCAAATCTCTGTCAAAGCATCAGAGAAGCTTCTCCGTTTAG	200
	** ***** ***** ***** ***** ***** ***** *****	

```

cynocephalus_variegatus      AATCCAGCATAACTCACTGAACCGAAGATGTGGCAGTTACAAGAGAAGTT 250
cynocephalus_volans          AATCCAGCATATCTCACAGAACCGAAGAAGTGGTAGTTAGAAGGGAGTTA 250
                              *****
cynocephalus_variegatus      GAGCTAAGAGAAGTTTGTGTTTCTGAAATTAGAAGCAAATCACACTGCAA 300
cynocephalus_volans          GAGCTGCAAGCAGTTTGCTTTGGGAAATTAGACGCGAAATGAAACTGCAA 300
                              *****
cynocephalus_variegatus      ACGGCATTCAAGCAGGCTTG-AAAAGTGTGGTGCATATCTCTGCCAAAAA 349
cynocephalus_volans          ATG-CCTTCCAACAGGCTTGAAAAGTGTGTTCTATATCTCTGCCAAACA 349
                              * * * * *
cynocephalus_variegatus      CA 351
cynocephalus_volans          AA 351
                              *

```

Candidate centromere repeat monomer:

```

>cynocephalus_variegatus
CTCCCTGGAGGTTGAGCTTCTGCAAGCCACTTTAACTTTAAGAAATGAGAGAGCAGAATA
TGCTTCTCACATCTAGCATGCAGGAATTCAGGTTTGCAAGTTCTATGTGAAAGCCCATG
AAGCCTATGGGGGAAACGGCTTCTGAGACTTCTGTTTCAAATCTCTGTCAAAAAGCATC
AGAGAAGCTTCCCGCTTAGAATCCAGCATAACTCACTGAACCGAAGATGTGGCAGTTAC
AAGAGAAGTTGAGCTAAGAGAAGTTTGTGTTTCTGAAATTAGAAGCAAATCACACTGCAA
ACGGCATTCAAGCAGGCTTGAAAAGTGTGGTGCATATCTCTGCCAAAAACA
>cynocephalus_volans
CTCCCCGAGGTTGAGCTTTCAGAAGCTAGTTTAACTCTAAGGGAGGAAGCAGCAGAATG
TGCTTCTCACATCTAGCCTGTAGGAATTCAGGTTGGCAAGTTCTATGGGGAAGCCCATG
CTGCCTATGGTGGAAACGGCATGGGAGATTTGAGTTTCAAATCTCTGTGAAAAGCATC
AGAGAAGCTTCTCCGTTTAGAATCCAGCATATCTCACAGAACCGAAGAAGTGGTAGTTAG
AAGGGAGTTAGAGCTGCAAGCAGTTTGCCTTTGGGAAATTAGACGCGAAATGAAACTGCAA
ATGCCTTCCAACAGGCTTGAAAAGTGTGTTCTATATCTCTGCCAAACAAA

```

Supplementary Figure S2: Centromere repeats in primates only conserved among apes and monkeys
 The centromere repeat sequences of the more basal primates (tarsiers and prosimians) do not show sequence similarity. Closer inspection of basal primate genomes did not reveal any sequences with sequence similarity to the ape and monkey centromere repeat.

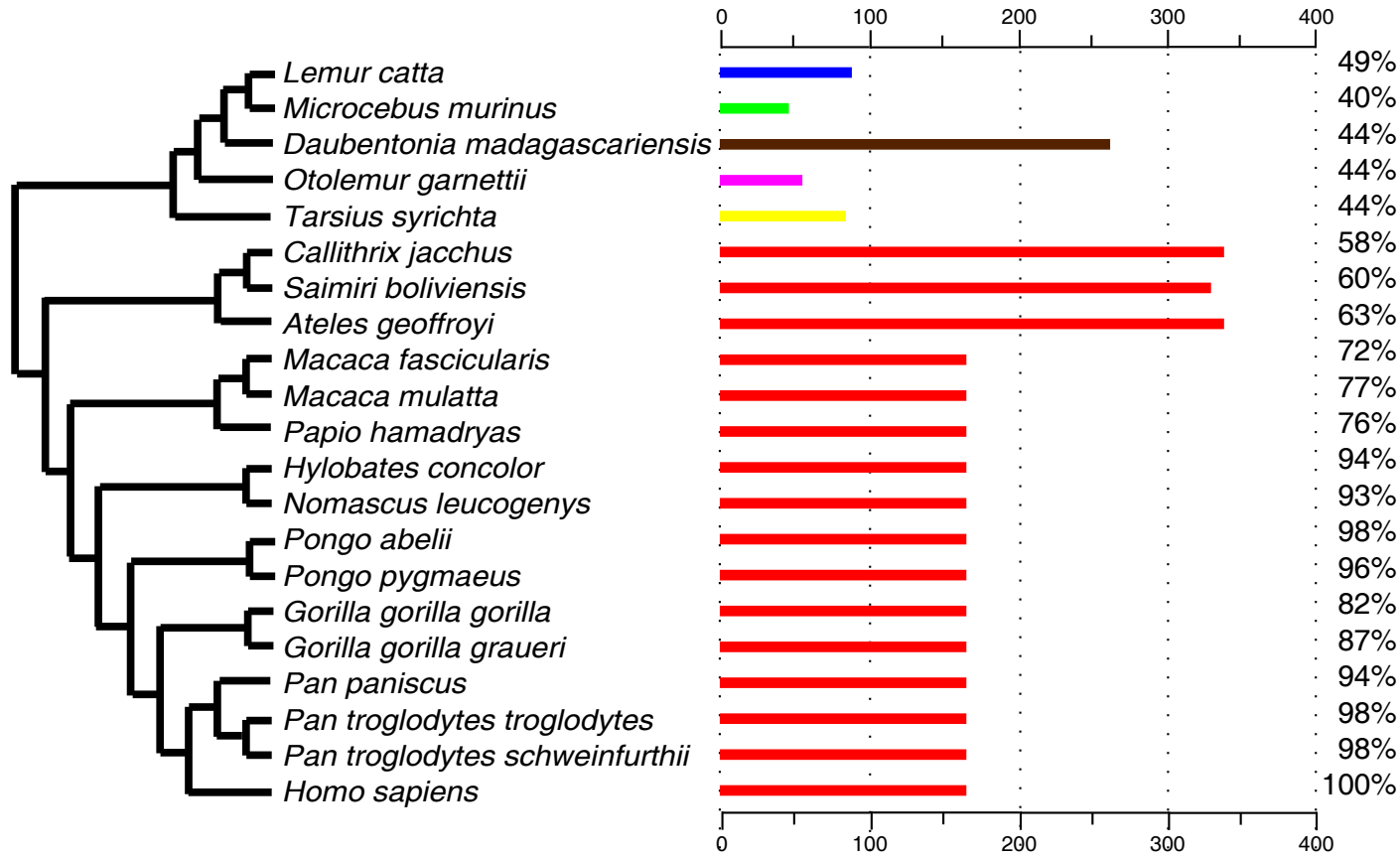

Supplementary Figure 3A: No correlation was observed between repeat length, GC content, kingdom or genomic fraction.

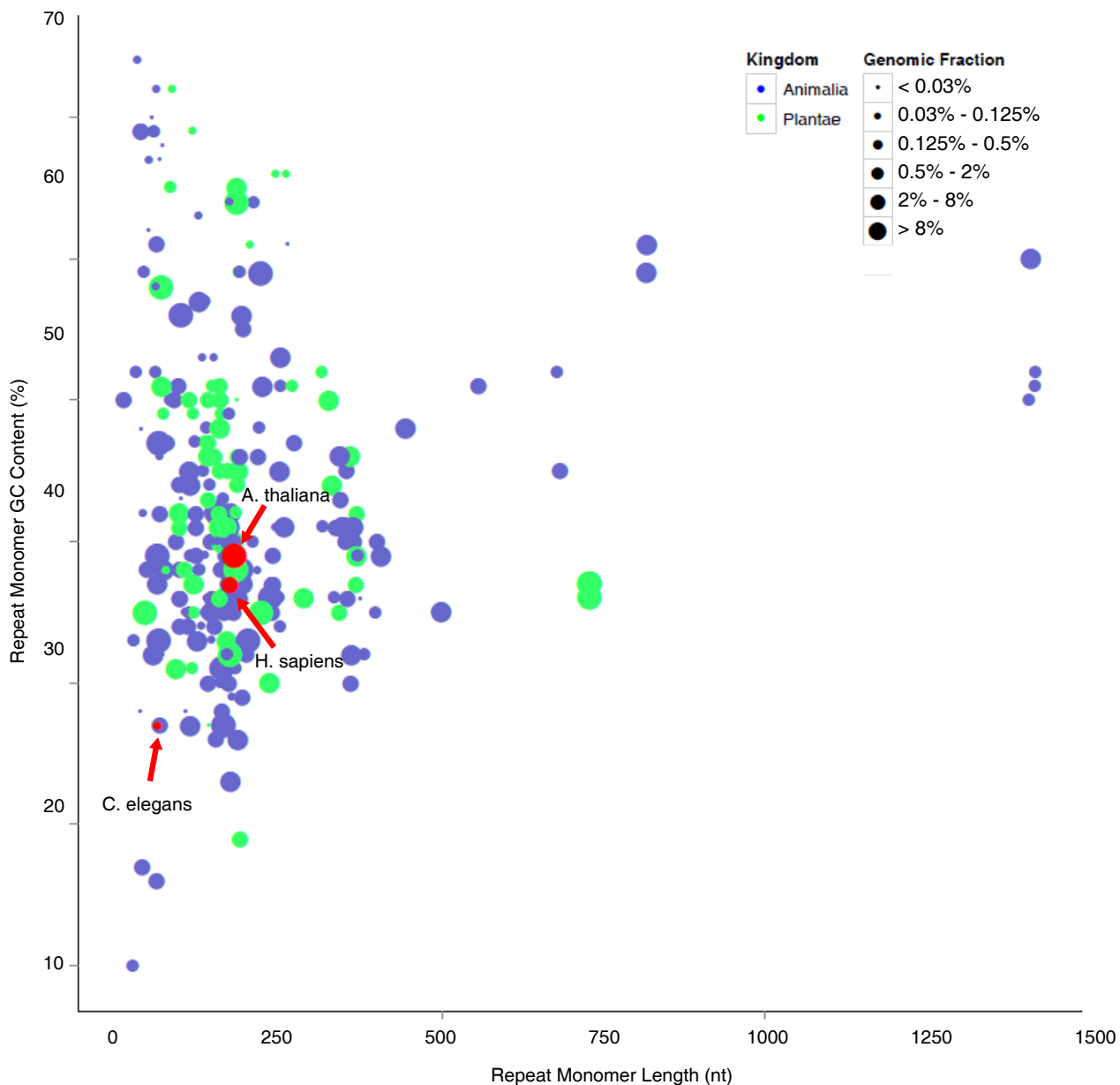

Supplementary Figure S3B: We did not observe a correlation between genome size and chromosome number versus either repeat length, GC content or genomic fraction.

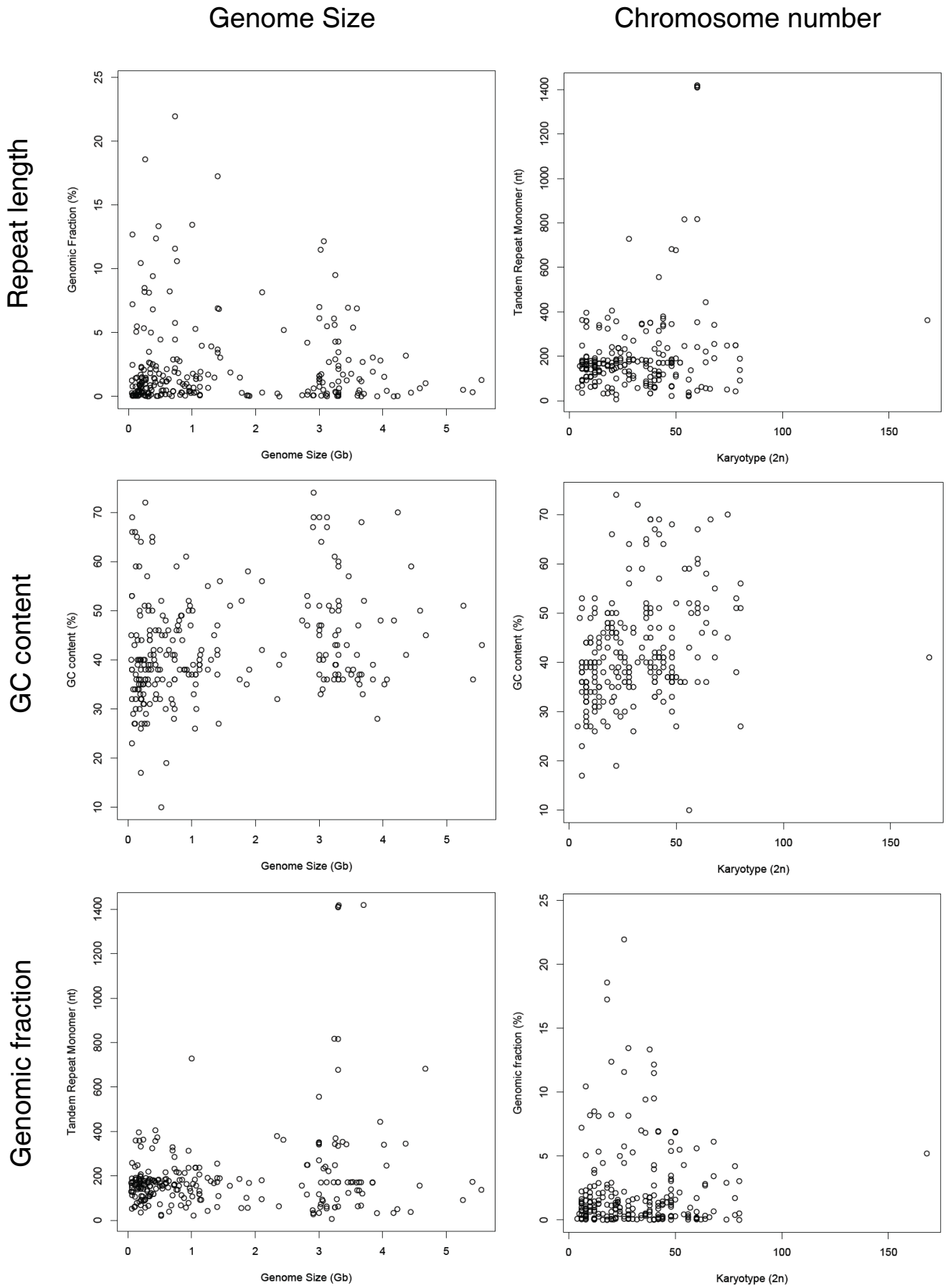

Supplementary Figure S4 – Nile tilapia contains related tandem repeats that differ by a 29 bp indel.

```

tandem-71      TGTGTTTCAGGCGAGAACTCCATTCAAATGCATGTAATAGCGAGAAACGCACTGTCTCGC 60
tandem-519    TGTGTTTCAGGCGAGAA-----ACGCACTGTCTCGC 31
                *****
                *****

tandem-71      CGAAATAAAGCGATTTTCACTAAGTTCATAAAGACAGCTGTAACCTTTTGATAGAAGACTC 120
tandem-519    CGAAATAAAGCGATTTTCACTAAGTTCATAAAGACAGCTGTAACCTTTTGATAGGAGACTC 91
                *****

tandem-71      GGACACACATATTTTCAGGCTTGGCCTTATAGAATTCAGCATTCTATGCTGGGGAAATAG 180
tandem-519    GGACACACATATTTTCAGGCTTGGCCTTATAGAATTCAGCATTCCATGCTGGGGAAATAG 151
                *****

tandem-71      GTTTTGCAGCTGTTTGAGCTAAGATTTTCAAGTTATTACAAAATGAAAACCCATAA 237
tandem-519    GTTTTGCCACTGTTTGAGCTAAGATTTTCA-GTTATGACTAAATGAAAACC-ATAA 206
                *****

```

```

>tandem-71
TGTGTTTCAGGCGAGAACTCCATTCAAATGCATGTAATAGCGAGAAACGCACTGTCTCGC
CGAAATAAAGCGATTTTCACTAAGTTCATAAAGACAGCTGTAACCTTTTGATAGAAGACTC
GGACACACATATTTTCAGGCTTGGCCTTATAGAATTCAGCATTCTATGCTGGGGAAATAG
GTTTTGCAGCTGTTTGAGCTAAGATTTTCAAGTTATTACAAAATGAAAACCCATAA
>tandem-519
TGTGTTTCAGGCGAGAAACGCACTGTCTCGCCGAAATAAGGCGATTTTCACTAAGTTCAT
AAAGACAGCTGTAACCTTTTGATAGGAGACTCGGACACACATATTTTCAGGCTTGGCCTTAT
AGAATTCAGCATTTCATGCTGGGGAAATAGTTTTGCCACTGTTTGAGCTAAGATTTTC
AGTTATTGACTAAATGAAAACCCATAA

```

Figure S5 - Relative ratios of short repeat (~680 bp) and long repeat (~1410 bp) in the five *Bovidae* species.

Species	Short repeat	Long repeat
<i>Bos taurus taurus</i>	29%	71%
<i>Bos taurus indicus</i>	32%	68%
<i>Bos grunniens</i>	40%	60%
<i>Bison bison</i>	41%	59%
<i>Bubalus bubalis</i>	57%	43%

Figure S6A. Tabular comparison to figure 6A of sequence comparison. Empty cells show sequence comparison with less than 40% sequence similarity. The three letter abbreviation corresponds to the species in top-to-bottom order as shown in Figure 6A.

	Gac	Oni	Mze	Mau	Lfu	Res	Pny	Nbr
Gac	100							
Oni		100						
Mze		66	100					
Mau		62	94	100				
Lfu		67	95	94	100			
Res		60	93	92	93	100		
Pny		74	94	95	97	93	100	
Nbr								100

Figure S6B. Tabular comparison to figure 6C of sequence comparison. Empty cells represent sequence comparison with less than 40% sequence similarity. The three letter abbreviation corresponds to the species in top-to-bottom order as shown in Figure 6C.

	Hvu	Ata	Bdi	Obr	Osa	Svi	Sit	Pha	Pca	Pvi	Zma	Zlu	Sbi	Spr	Mgi
Hvu	100														
Ata		100													
Bdi			100												
Obr				100											
Osa					100										
Svi					57	100									
Sit					59	98	100								
Pha					62	68	67	100							
Pca					65	63	63	94	100						
Pvi					41	44	45	56	55	100					
Zma					50	56	55	67	67	42	100				
Zlu					49	54	53	65	66	40	98	100			
Sbi													100		
Spr													91	100	
Mgi													87	84	100