

Scaling of a random walk on a supercritical contact process

F. den Hollander ¹
R. dos Santos ¹

October 24, 2021

Abstract

A proof is provided of a strong law of large numbers for a one-dimensional random walk in a dynamic random environment given by a supercritical contact process in equilibrium. The proof is based on a coupling argument that traces the space-time cones containing the infection clusters generated by single infections and uses that the random walk eventually gets trapped inside the union of these cones. For the case where the local drifts of the random walk are smaller than the speed at which infection clusters grow, the random walk eventually gets trapped inside a single cone. This in turn leads to the existence of regeneration times at which the random walk forgets its past. The latter are used to prove a functional central limit theorem and a large deviation principle.

The qualitative dependence of the speed and the volatility on the infection parameter is investigated, and some open problems are mentioned.

Acknowledgment. The authors would like to thank Stein Bethuelsen and Markus Heydenreich for stimulating discussions, and the anonymous referee for useful suggestions.

MSC 2000. Primary 60F15, 60K35, 60K37; Secondary 82B41, 82C22, 82C44.

Key words and phrases. Random walk, dynamic random environment, contact process, strong law of large numbers, functional central limit theorem, large deviation principle, space-time cones, clusters of infections, coupling, regeneration times.

1 Introduction

1.1 Background, motivation and outline

Background. A random walk in a dynamic random environment on \mathbb{Z}^d , $d \geq 1$, is a random process where a “particle” makes random jumps with transition rates that

¹Mathematical Institute, Leiden University, P.O. Box 9512, 2300 RA Leiden, The Netherlands

depend on its location and themselves evolve with time. A typical example is when the dynamic random environment is given by an interacting particle system

$$\xi = (\xi_t)_{t \geq 0} \text{ with } \xi_t = \{\xi_t(x) : x \in \mathbb{Z}^d\} \in \Omega, \quad (1.1)$$

where Ω is the configuration space, and ξ_0 is typically drawn from equilibrium. In the case where $\Omega = \{0, 1\}^{\mathbb{Z}^d}$, the configurations can be thought of as consisting of “particles” and “holes”. Given ξ , run a random walk $W = (W_t)_{t \geq 0}$ on \mathbb{Z}^d that jumps at a fixed rate, but uses different transition kernels on a particle and on a hole. The key question is: What are the scaling properties of W and how do these properties depend on the law of ξ ?

The literature on random walks in dynamic random environments is still modest (for a recent overview, see Avena [1], Chapter 1). In Avena, den Hollander and Redig [4] a strong law of large numbers (SLLN) was proved for a class of interacting particle systems satisfying a mild space-time mixing condition, called *cone-mixing*. Roughly speaking, this is the requirement that for every $m > 0$ all states inside the space-time cone (see Fig. 1)

$$\text{CONE}_t := \{(x, s) \in \mathbb{Z}^d \times [t, \infty) : \|x\| \leq m(s - t)\}, \quad (1.2)$$

are conditionally independent of the states at time zero in the limit as $t \rightarrow \infty$. The proof of the SLLN uses a *regeneration-time* argument. Under a cone-mixing condition involving multiple cones, a functional central limit theorem (FCLT) can be derived as well, and under monotonicity conditions also a large deviation principle (LDP).

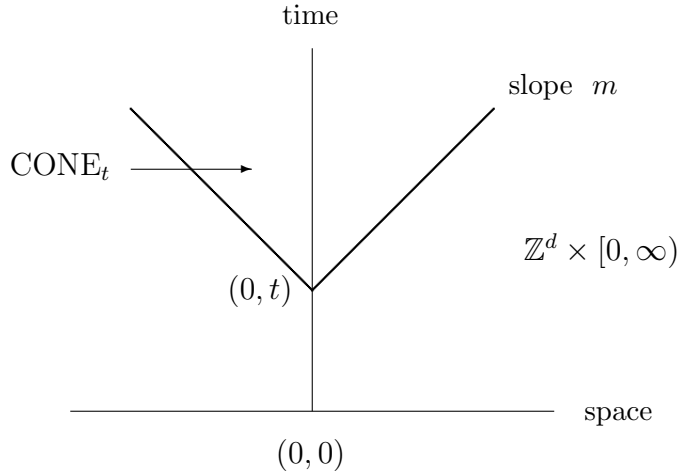

Figure 1: The cone defined in (1.2).

Many interacting particle systems are cone-mixing, including spin-flip systems with spin-flip rates that are weakly dependent on the configuration, e.g. the stochastic Ising model above the critical temperature. However, also many interacting particle systems are not cone-mixing, including independent simple random walks, the exclusion process, the contact process and the voter model. Indeed, these systems have *slowly decaying*

space-time correlations. For instance, in the exclusion process particles are conserved and cannot sit on top of each other. Therefore, if at time zero there are particles everywhere in the box $[-t^2, t^2] \cap \mathbb{Z}^d$, then these particles form a “large traffic jam around the origin”. This traffic jam will survive up to time t with a probability tending to 1 as $t \rightarrow \infty$, and will therefore affect the states near the tip of CONE_t . Similarly, in the contact process, if at time zero there are no infections in the box $[-t^2, t^2] \cap \mathbb{Z}^d$, then no infections will be seen near the tip of CONE_t as well.

Motivation. Several attempts have been made to extend the SLLN to interacting particle systems that are not cone-mixing, with partial success. Examples include: independent simple random walks (den Hollander, Kesten and Sidoravicius [11]) and the exclusion process (Avena, dos Santos and Völlering [5], Avena [2]). The present paper considers the *supercritical contact process*. We exploit the graphical representation, which allows us to simultaneously couple all realizations of the contact process starting from different initial configurations. This coupling in turn allows us to first prove the SLLN when the initial configuration is “all infected” (with the help of a subadditivity argument), and then show that the same result holds when the initial configuration is drawn from equilibrium. The main idea is to use the coupling to show that configurations agree in large space-time cones containing the infection clusters generated by single infections and that the random walk eventually gets trapped inside the *union* of these cones.

Under the assumption that the local drifts of the random walk are smaller than the speed at which infection clusters grow, the random walk eventually gets trapped inside a *single* cone. We show that this implies the existence of *regeneration times* at which the random walk “forgets its past”. The latter in turn allow us to prove the FCLT and the LDP.

It is typically difficult to obtain information about the speed in the SLLN, the volatility in the FCLT and the rate function in the LDP. In general, these are non-trivial functions of the parameters in the model, a situation that is well known from the literature on random walks in static random environments (for overviews, see Sznitman [16] and Zeitouni [17]). The reason is that these quantities depend on the *environment process* (i.e., the process of environments as seen from the location of the walk), which is typically hard to analyze. For the supercritical contact process we are able to derive a few qualitative properties as a function of the infection parameter, but it remains a challenge to obtain a full quantitative description.

A model of a random walk on the infinite cluster of supercritical oriented percolation (the discrete-time analogue of the contact process) is treated in Birkner, Černý, Depperschmidt and Gantert [8], where a SLLN and a quenched and annealed CLT are obtained. This model can be viewed as a random walk in a dynamic random environment, but it has non-elliptic transition probabilities different from the ones we consider here, because the random walk is confined to the infinite cluster.

Outline. In Section 1.2 we define the model. In Section 1.3 we state our main results: two theorems claiming the SLLN, the FCLT and the LDP under appropriate conditions

on the model parameters. In Section 1.4 we mention some open problems. The proofs of the theorems are given in Sections 3, 5, and 6. Sections 2 and 4 contain preparatory work.

1.2 Model

In this paper we consider the case where the dynamic random environment is the one-dimensional linear *contact process* $\xi = (\xi_t)_{t \geq 0}$, i.e., the spin-flip system on $\Omega := \{0, 1\}^{\mathbb{Z}}$ with local transition rates given by

$$\eta \rightarrow \eta^x \text{ with rate } \begin{cases} 1 & \text{if } \eta(x) = 1, \\ \lambda \{\eta(x-1) + \eta(x+1)\} & \text{if } \eta(x) = 0, \end{cases} \quad (1.3)$$

where $\lambda \in (0, \infty)$ and η^x is defined by $\eta^x(y) := \eta(y)$ for $y \neq x$, $\eta^x(x) := 1 - \eta(x)$. We call a site *infected* when its state is 1, and *healthy* when its state is 0. See Liggett [12], Chapter VI, for proper definitions.

The empty configuration $\mathbf{0} \in \Omega$, given by $\mathbf{0}(x) = 0$ for all $x \in \mathbb{Z}$, is an absorbing state for ξ , while the full configuration $\mathbf{1} \in \Omega$, given by $\mathbf{1}(x) = 1$ for all $x \in \mathbb{Z}$, evolves towards an equilibrium measure ν_λ , called the “upper invariant measure”, that is stationary and ergodic under space-shifts. There is a critical threshold $\lambda_c \in (0, \infty)$ such that: (1) for $\lambda \in (0, \lambda_c]$, $\nu_\lambda = \delta_{\mathbf{0}}$; (2) for $\lambda \in (\lambda_c, \infty)$, $\rho_\lambda := \nu_\lambda(\eta(0) = 1) > 0$. In the latter case, $\delta_{\mathbf{0}}$ and ν_λ are the only equilibrium measures. It is known that ν_λ has exponentially decaying correlations, and that $\lambda \mapsto \rho_\lambda$ is continuous and non-decreasing with $\lim_{\lambda \rightarrow \infty} \rho_\lambda = 1$.

For a fixed realization of ξ , we define the random walk $W := (W_t)_{t \geq 0}$ as the time-inhomogeneous Markov process on \mathbb{Z} that, given $W_t = x$, jumps to

$$\begin{aligned} x+1 & \text{ at rate } \alpha_1 \xi_t(x) + \alpha_0 [1 - \xi_t(x)], \\ x-1 & \text{ at rate } \beta_1 \xi_t(x) + \beta_0 [1 - \xi_t(x)], \end{aligned} \quad (1.4)$$

where $\alpha_i, \beta_i \in (0, \infty)$, $i = 0, 1$. We assume that

$$\alpha_0 + \beta_0 = \alpha_1 + \beta_1 =: \gamma, \quad (1.5)$$

and that

$$v_1 > v_0 \text{ with } v_1 := \alpha_1 - \beta_1 \text{ and } v_0 := \alpha_0 - \beta_0, \quad (1.6)$$

i.e., the jump rate is constant and equal to γ everywhere, while the drift to the right is larger on infected sites than on healthy sites. Observe that the assumption in (1.6) is made without loss of generality: since the contact process is invariant under reflection in the origin, $-W$ has the same law as W with inverted jump rates.

1.3 Theorems

For a probability measure μ on Ω , let \mathbb{P}_μ denote the joint law of W and ξ when the latter is started from μ . Our SLLN reads as follows.

Theorem 1.1. *Suppose that (1.5–1.6) hold.*

(a) *For every $\lambda \in (\lambda_c, \infty)$ there exists a $v(\lambda) \in [v_0, v_1]$ such that, for any probability measure μ on Ω that is stochastically larger than a non-trivial shift-invariant and ergodic measure,*

$$\lim_{t \rightarrow \infty} t^{-1}W_t = v(\lambda) \quad \mathbb{P}_\mu\text{-a.s. and in } L^p, p \geq 1. \quad (1.7)$$

In particular, (1.7) holds for $\mu = \nu_\lambda$.

(b) *The function $\lambda \mapsto v(\lambda)$ is non-decreasing and right-continuous on (λ_c, ∞) , with $v(\lambda) \in (v_0, v_1)$ for all $\lambda \in (\lambda_c, \infty)$ and $\lim_{\lambda \rightarrow \infty} v(\lambda) = v_1$.*

We note in passing that if $\lambda \in (0, \lambda_c)$, then ξ_t agrees with $\mathbf{0}$ on an interval that grows exponentially fast in t (Liggett [12], Chapter VI), and so it is trivial to deduce that W satisfies the SLLN with $v(\lambda) = v_0$.

A FCLT and an LDP hold under an additional restriction, namely, $\lambda \in (\lambda_W, \infty)$ with

$$\lambda_W := \inf \{ \lambda \in (\lambda_c, \infty) : |v_0| \vee |v_1| < \iota(\lambda) \}. \quad (1.8)$$

Here, $\lambda \mapsto \iota(\lambda)$ is the infection propagation speed (see (2.4) in Section 2.1), which is known to be continuous, strictly positive and strictly increasing on (λ_c, ∞) , with $\lim_{\lambda \downarrow \lambda_c} \iota(\lambda) = 0$ and $\lim_{\lambda \rightarrow \infty} \iota(\lambda) = \infty$.

Theorem 1.2. *Suppose that (1.5–1.6) hold.*

(a) *For every $\lambda \in (\lambda_W, \infty)$ there exists a $\sigma(\lambda) \in (0, \infty)$ such that, under \mathbb{P}_{ν_λ} ,*

$$\left(\frac{W_{nt} - v(\lambda)nt}{\sigma(\lambda)\sqrt{n}} \right)_{t \geq 0} \Longrightarrow (B_t)_{t \geq 0} \quad \text{as } n \rightarrow \infty, \quad (1.9)$$

where B is standard Brownian motion and \Longrightarrow denotes weak convergence in path space.

(b) *The functions $\lambda \mapsto v(\lambda)$ and $\lambda \mapsto \sigma(\lambda)$ are continuous on (λ_W, ∞) .*

(c) *For every $\lambda \in (\lambda_W, \infty)$, $(t^{-1}W_t)_{t > 0}$ under \mathbb{P}_{ν_λ} satisfies the large deviation principle on \mathbb{R} with a finite and convex rate function that has a unique zero at $v(\lambda)$.*

The intuitive reason why the rate function has a unique zero is that deviations of the empirical speed in the: (i) upward direction require a density of infected sites larger than ρ_λ , which is costly because infections become healthy independently of the states at the other sites; (ii) downward direction require a density of infected sites smaller than ρ_λ , which is costly because infection clusters grow at a linear speed and rapidly fill up healthy intervals everywhere.

1.4 Discussion

1. It is natural to expect that $\lambda \mapsto v(\lambda)$ is continuous and strictly increasing on (λ_c, ∞) with $\lim_{\lambda \downarrow \lambda_c} v(\lambda) = v_0$. Fig. 2 shows a qualitative plot of the speed in that setting. If $0 \in (v_0, v_1)$, then there is a critical threshold $\lambda^* \in (\lambda_c, \infty)$ at which the speed changes sign. It is natural to ask whether $\lambda \mapsto v(\lambda)$ is concave on (λ_c, ∞) and Lipschitz at λ_c .

2. We know that W is transient when $v(\lambda) \neq 0$. Is W recurrent when $v(\lambda) = 0$?

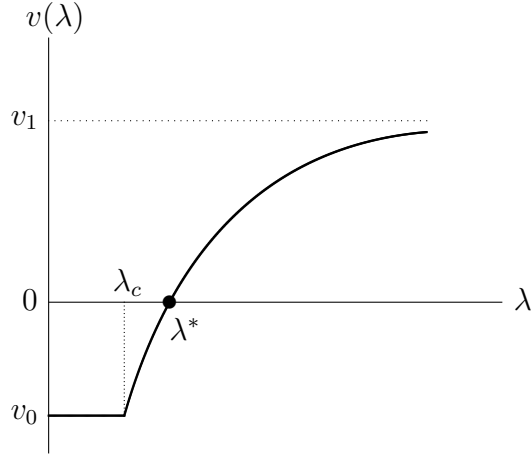

Figure 2: Qualitative plot of $\lambda \mapsto v(\lambda)$ when $0 \in (v_0, v_1)$.

- 3.** We expect (1.8) to be redundant. Moreover, we expect that for every $\lambda \in (\lambda_c, \infty)$ the *environment process* (i.e., the process of environments as seen from the location of the random walk) has a unique and non-trivial equilibrium measure that is absolutely continuous with respect to ν_λ .
- 4.** Theorem 1.1 can be extended to arbitrary initial configurations that have a “strictly positive lower density” (see Remark 3.7 in Section 3.2 below). Also, Theorem 1.1 remains valid for μ stochastically larger than ν_λ even when some of the jump rates $\alpha_i, \beta_i, i \in \{0, 1\}$, are equal to zero (see Remark 3.4 in Section 3.2 below).
- 5.** Theorem 1.2(a) can be extended (with the same mean and variance) to arbitrary initial configurations containing infinitely many infections, while Theorem 1.2(c) can be extended (with a different rate function) to any initial measure that has positive correlations and is stochastically larger than a non-trivial Bernoulli product measure (see Remark 6.3 in Section 6.1 below).
- 6.** Theorems 1.1–1.2 can presumably be extended to \mathbb{Z}^d with $d \geq 2$. Also in higher dimensions single infections create infection clusters that grow at a linear speed (i.e., asymptotically form a ball with a linearly growing radius). The construction of the regeneration times when $\lambda \in (\lambda_W, \infty)$, with λ_W the analogue of (1.8), appears to be possible.
- 7.** It would be interesting to extend Theorems 1.1–1.2 to *multi-type contact processes*. On each type i the random walk has transition rates α_i, β_i such that $\alpha_i + \beta_i = \gamma$ for all i . As long as the dynamics is monotone and $i \mapsto v_i$ is non-decreasing, many of the arguments in the present paper carry over.

This construction allows us to *simultaneously couple* copies of the contact process starting from *all* configurations $\eta \in \Omega$. In the following we will write $\xi(\eta)$ and $\xi_t(\eta)(x)$ when we want to exhibit that the initial configuration is η .

We note two consequences of the graphical construction, stated in Lemmas 2.1–2.3 below. The first is the monotonicity of $\eta \mapsto \xi(\eta)$, the second concerns the state of the sites surrounded by the cluster of an infected site. The notation $\eta \leq \eta'$ stands for $\eta(x) \leq \eta'(x)$ for all $x \in \mathbb{Z}$.

Lemma 2.1. *If $\eta \leq \eta'$, then $\xi_t(\eta) \leq \xi_t(\eta')$ for all $t \geq 0$.*

Proof. Immediate from the definition of ξ_t in terms of η and $(C_t(x))_{x \in \mathbb{Z}}$. ■

For $x \in \mathbb{Z}$, define the left-most and the right-most site influenced by site x at time t as

$$\begin{aligned} L_t(x) &:= \inf C_t(x), \\ R_t(x) &:= \sup C_t(x), \end{aligned} \tag{2.3}$$

where $\inf \emptyset = \infty$ and $\sup \emptyset = -\infty$. By symmetry, for any $t \geq 0$, $R_t(x) - x$ and $x - L_t(x)$ have the same distribution, independently of x .

Lemma 2.2. *Fix $x \in \mathbb{Z}$ and $t \geq 0$. If $C_t(x) \neq \emptyset$ and $y \in [L_t(x), R_t(x)] \cap \mathbb{Z}$, then $\eta \mapsto \xi_t(\eta)(y)$ is constant on $\{\eta \in \Omega: \eta(x) = 1\}$.*

Proof. It suffices to show that, under the conditions stated, $\xi_t(\eta)(y) = 1$ if and only if $y \in C_t(x)$. The ‘if’ part is obvious. For the ‘only if’ part, note that if there is a $z \neq x$ such that $(z, 0) \leftrightarrow (y, t)$, then any path realizing the connection must cross a path connecting $(x, 0)$ to either $(R_t(x), t)$ or $(L_t(x), t)$, so that $(x, 0) \leftrightarrow (y, t)$ as well. ■

If $\xi_0 = \mathbb{1}_x$, then $R_t(x)$ and $L_t(x)$ are, respectively, the right-most and the left-most infections present at time t . In particular, in this case the infection survives for all times if and only if $R_t(x) - L_t(x) \geq 0$ for all $t \geq 0$. For $\lambda \in (\lambda_c, \infty)$ it is well known that, given $\xi_0 = \mathbb{1}_0$, the infection survives with positive probability and there exists a constant $\iota = \iota(\lambda) > 0$ such that, conditionally on survival,

$$\lim_{t \rightarrow \infty} t^{-1} R_t(0) = \iota \quad \xi\text{-a.s.} \tag{2.4}$$

2.2 Random walk on top of contact process

Under assumptions (1.5–1.6), the random walk W can be constructed as follows. Let $N := (N_t)_{t \geq 0}$ be a Poisson process with rate γ . Denote by $J := (J_k)_{k \in \mathbb{N}_0}$ its generalized inverse, i.e., $J_0 = 0$ and $(J_{k+1} - J_k)_{k \in \mathbb{N}_0}$ are i.i.d. $\text{EXP}(\gamma)$ random variables. Let $U := (U_k)_{k \in \mathbb{N}}$ be an i.i.d. sequence of $\text{UNIF}([0, 1])$ random variables, independent of N . Set $S_0 := 0$ and, recursively for $k \in \mathbb{N}_0$,

$$S_{k+1} := S_k + 2 \left(\mathbb{1}_{\{0 \leq U_{k+1} \leq \alpha_0/\gamma\}} + \xi_{J_{k+1}}(S_k) \mathbb{1}_{\{\alpha_0/\gamma < U_{k+1} \leq \alpha_1/\gamma\}} \right) - 1, \tag{2.5}$$

i.e., $S_{k+1} = S_k + 1$ with probability α_i/γ and $S_{k+1} = S_k - 1$ with probability $\beta_i/\gamma = 1 - \alpha_i/\gamma$ when $\xi_{J_{k+1}}(S_k) = i$, for $i = 0, 1$ (recall that $\alpha_0 < \alpha_1$ by (1.5–1.6)). Setting

$$W_t := S_{N_t}, \quad (2.6)$$

we can use the right-continuity of ξ to verify that W indeed is a Markov process with the correct jump rates.

A useful property of the above construction is that it is monotone in the environment, in the following sense. For two dynamic random environments ξ and ξ' , we say that $\xi \leq \xi'$ when $\xi_t \leq \xi'_t$ for all $t \geq 0$. Writing $W = W(\xi)$ in the previous construction (i.e., exhibiting W as a function of ξ), it is clear from (2.5) that

$$\xi \leq \xi' \implies W_t(\xi) \leq W_t(\xi') \quad \forall t \geq 0. \quad (2.7)$$

We denote by

$$\mathcal{G}_t := \mathcal{F}_t \vee \sigma((N_s)_{s \in [0, t]}, (U_k)_{1 \leq k \leq N_t}) \quad (2.8)$$

the filtration generated by all the random variables that are used to define the contact process ξ and the random walk W .

3 The strong law of large numbers

Theorem 1.1(a) is proved in two steps. In Section 3.1 we use subadditivity to prove the SLLN when ξ starts from δ_1 . In Section 3.2 we show that, under the hypotheses stated about μ in Theorem 1.1(a), we can couple two copies of ξ starting from μ and δ_1 so as to transfer the SLLN, with the same speed.

In the following, for a random process $X = (X_t)_{t \in \mathcal{I}}$ with $\mathcal{I} = \mathbb{R}$ or $\mathcal{I} = \mathbb{Z}$, we write

$$X_{[0, t]} := (X_s)_{s \in [0, t] \cap \mathcal{I}}. \quad (3.1)$$

3.1 Starting from the full configuration: subadditivity

Since $\eta \leq \mathbf{1}$ for all $\eta \in \Omega$, it follows from (2.7) and Lemma 2.1 that $W_t(\xi(\eta)) \leq W_t(\xi(\mathbf{1}))$ for all $t \geq 0$. Therefore, if in the graphical construction we replace ξ_s by $\mathbf{1}$ at any given time s , then the new increments after time s lie to the right of the old increments after time s , and are independent of the increments before time s . This leads us to a subadditivity argument, which we now formalize.

For $n \in \mathbb{N}_0$, let

$$\begin{aligned} H^{(n)} &= (H_t^{(n)}(x))_{t \geq 0, x \in \mathbb{Z}} &:= (H_{t+n}(x + W_n) - H_n(x + W_n))_{t \geq 0, x \in \mathbb{Z}}, \\ I^{(n)} &= (I_t^{(n)}(x))_{t \geq 0, x \in \mathbb{Z}} &:= (I_{t+n}(x + W_n) - I_n(x + W_n))_{t \geq 0, x \in \mathbb{Z}}, \\ N^{(n)} &= (N_t^{(n)})_{t \geq 0} &:= (N_{t+n} - N_n)_{t \geq 0}, \\ U^{(n)} &= (U_k^{(n)})_{k \in \mathbb{N}} &:= (U_{k+N_n})_{k \in \mathbb{N}}. \end{aligned} \quad (3.2)$$

Then, for any $n \in \mathbb{N}_0$, $(H^{(n)}, I^{(n)}, N^{(n)}, U^{(n)})$ has the same distribution as (H, I, N, U) and is independent of

$$H_{[0, n-j]}^{(j)}, I_{[0, n-j]}^{(j)}, N_{[0, n-j]}^{(j)}, U_{[1, N_{n-j}^{(j)}]}^{(j)}, \quad 0 \leq j \leq n-1. \quad (3.3)$$

Abbreviate $\xi = \xi(\eta, H, I)$ and $W = W(\xi, N, U)$. For $n \in \mathbb{N}_0$, let

$$\begin{aligned} \xi^{(n)} &:= \xi(\mathbf{1}, H^{(n)}, I^{(n)}), \\ W^{(n)} &:= W(\xi^{(n)}, N^{(n)}, U^{(n)}), \end{aligned} \quad (3.4)$$

and define the double-indexed sequence

$$X_{m,n} := W_{n-m}^{(m)}, \quad n, m \in \mathbb{N}_0, n \geq m. \quad (3.5)$$

Lemma 3.1. *The following properties hold:*

- (i) For all $n, m \in \mathbb{N}_0$, $n \geq m$: $X_{0,n} \leq X_{0,m} + X_{m,n}$.
- (ii) For all $n \in \mathbb{N}_0$: $(X_{n, n+k})_{k \in \mathbb{N}_0}$ has the same distribution as $(X_{0,k})_{k \in \mathbb{N}_0}$.
- (iii) For all $k \in \mathbb{N}$: $(X_{nk, (n+1)k})_{n \in \mathbb{N}_0}$ is i.i.d.
- (iv) $\sup_{n \in \mathbb{N}} \mathbb{E}_{\delta_1} [n^{-1} |X_{0,n}|] < \infty$.

Proof. (i) Fix $n, m \in \mathbb{N}_0$, $n \geq m$ and define $\hat{\xi} := \xi(\hat{\eta}, H^{(m)}, I^{(m)})$, where $\hat{\eta}(x) = \xi_m(x + W_m)$. This is the contact process after time m as seen from W_m . Note that $X_{0,n} - X_{0,m} = W_n - W_m = W_{n-m}(\hat{\xi}, N^{(m)}, U^{(m)})$. Since $\hat{\eta} \leq \mathbf{1}$, it follows from (2.7) and Lemma 2.1 that the latter is $\leq W_{n-m}(\xi^{(m)}, N^{(m)}, U^{(m)}) = W_{n-m}^{(m)}$.

(ii) Immediate from the construction.

(iii) By definition, $X_{nk, (n+1)k} = W_k(\xi^{(nk)}, N^{(nk)}, U^{(nk)})$. By construction, for each $t \geq 0$, $W_t(\xi, N, U)$ is a function of $N_{[0,t]}$, $U_{[1, N_t]}$ and $\xi_{[0,t]}$, which in turn is a function of $H_{[0,t]}$, $I_{[0,t]}$ and η . Therefore $X_{nk, (n+1)k}$ is equal to a (fixed) function of

$$H_{[0,k]}^{(nk)}, I_{[0,k]}^{(nk)}, N_{[0,k]}^{(nk)}, U_{[1, N_{(n+1)k}^{(nk)}]}^{(nk)}, \quad (3.6)$$

which are jointly i.i.d. in n (when k is fixed).

(iv) This follows from the fact that $|W_t| \leq N_t$. ■

Lemma 3.1 allows us to prove the SLLN when ξ starts from δ_1 .

Proposition 3.2. *Let*

$$v(\lambda) := \inf_{n \in \mathbb{N}} \mathbb{E}_{\delta_1} [n^{-1} W_n], \quad \lambda \in [0, \infty). \quad (3.7)$$

Then

$$\lim_{t \rightarrow \infty} t^{-1} W_t = v(\lambda) \quad \mathbb{P}_{\delta_1}\text{-a.s. and in } L^p, \quad p \geq 1. \quad (3.8)$$

Proof. Conditions (i)–(iv) in Lemma 3.1 allow us to apply the subadditive ergodic theorem of Liggett [13] (see also Liggett [12], Theorem VI.2.6) to the sequence $(X_{0,n})_{n \in \mathbb{N}_0} = (W_n)_{n \in \mathbb{N}_0}$, which gives $\lim_{n \rightarrow \infty} n^{-1}W_n = v$ \mathbb{P}_{δ_1} -a.s. Via a standard argument this can subsequently be extended to $(t^{-1}W_t)_{t \geq 0}$ by using that, for any $n \in \mathbb{N}_0$,

$$\sup_{s \in [0,1]} |W_{n+s} - W_n| \leq N_{n+1} - N_n, \quad (3.9)$$

which implies that $\lim_{t \rightarrow \infty} t^{-1}|W_t - W_{\lfloor t \rfloor}| = 0$ a.s. w.r.t. \mathbb{P}_{δ_1} . Since $|W_t| \leq N_t$, we see that $(t^{-p}|W_t|^p)_{t \geq 1}$ is uniformly integrable for any $p \geq 1$, so the convergence also holds in L^p . \blacksquare

3.2 Other initial measures: coupling

In this section, we show that whenever two copies of the contact process starting from μ and δ_1 can be coupled so as to agree with large probability at large times inside a space-time cone, the LLN holds also under \mathbb{P}_μ with the same velocity $v(\lambda)$. We subsequently show that such a coupling is possible when μ is stochastically larger than a non-trivial shift-invariant and ergodic measure. Some remarks regarding extensions are made after the corresponding results.

For $m > 0$, let

$$V_m := \{(x, s) \in \mathbb{Z} \times [0, \infty) : |x| \leq ms\} \quad (3.10)$$

be a cone of inclination m opening upwards in space-time.

Proposition 3.3. *Fix $\lambda \in (0, \infty)$, and let $\xi^{(\mu)}$ and $\xi^{(\mathbf{1})}$ denote the contact process started from μ and $\mathbf{1}$, respectively. Suppose that there exists a coupling measure \mathbb{P} of $\xi^{(\mu)}$ and $\xi^{(\mathbf{1})}$ such that, for some $m > |v_0| \vee |v_1|$,*

$$\lim_{T \rightarrow \infty} \mathbb{P} \left(\exists (x, t) \in V_m \cap \mathbb{Z} \times [T, \infty) : \xi_t^{(\mu)}(x) \neq \xi_t^{(\mathbf{1})}(x) \right) = 0. \quad (3.11)$$

Then

$$\lim_{t \rightarrow \infty} t^{-1}W_t = v(\lambda) \quad \mathbb{P}_\mu\text{-a.s. and in } L^p, p \geq 1, \quad (3.12)$$

where $v(\lambda)$ is as in (3.7).

Proof. Let $N^{(\mu)}, U^{(\mu)}$ and $N^{(\mathbf{1})}, U^{(\mathbf{1})}$ be independent copies of N, U and rename \mathbb{P} to denote the joint law of $\xi^{(a)}, N^{(a)}, U^{(a)}$, $a \in \{\mu, \mathbf{1}\}$. Then $W^{(\mu)} := W(\xi^{(\mu)}, N^{(\mu)}, U^{(\mu)})$ under \mathbb{P} has the same law as W under \mathbb{P}_μ .

Denote by $\bar{\mathbf{0}}, \bar{\mathbf{1}}$ the elements of $\Omega^{[0, \infty)}$ that are constant and equal to 0, respectively, 1, i.e., $\bar{\mathbf{0}}_t(x) = 0$ for all $(x, t) \in \mathbb{Z} \times [0, \infty)$ and analogously for $\bar{\mathbf{1}}$, and set

$$\bar{W}^{(\mu)} := |W(\bar{\mathbf{1}}, N^{(\mu)}, U^{(\mu)})| \vee |W(\bar{\mathbf{0}}, N^{(\mu)}, U^{(\mu)})|. \quad (3.13)$$

For $T > 0$, let

$$D_T := \left\{ \bar{W}_s^{(\mu)} \leq ms \quad \forall s \geq T \right\} \quad (3.14)$$

and

$$\Gamma_T := D_T \cap \{\xi_s^{(\mu)}(x) = \xi_s^{(1)}(x) \ \forall (x, s) \in V_m \cap \mathbb{Z} \times [T, \infty)\}. \quad (3.15)$$

For $i \in \{0, 1\}$, $W(\bar{\mathbf{i}}, N^{(\mu)}, U^{(\mu)})$ is a homogeneous random walk with total jump rate γ and drift v_i . Hence, by (3.11),

$$\lim_{T \rightarrow \infty} \mathbb{P}(\Gamma_T) = 1. \quad (3.16)$$

Therefore it suffices to prove that

$$\mathbb{P}\left(\lim_{t \rightarrow \infty} t^{-1}W_t^{(\mu)} = v \mid \Gamma_T\right) = 1 \ \forall T > 0. \quad (3.17)$$

In order to prove (3.17), we couple $W^{(\mu)}$ with a random walk \widehat{W} distributed as W under \mathbb{P}_{δ_1} , as follows. Fix $T > 0$ and let $\widehat{N} = (\widehat{N}_s)_{s \geq 0}$, $\widehat{U} = (\widehat{U}_n)_{n \in \mathbb{N}}$ be defined by

$$\widehat{N}_t := \begin{cases} N_t^{(1)} & \text{if } t \leq T, \\ N_T^{(1)} + N_t^{(\mu)} - N_T^{(\mu)} & \text{otherwise,} \end{cases} \quad (3.18)$$

and

$$\widehat{U}_n := \begin{cases} U_n^{(1)} & \text{if } n \leq N_T^{(1)}, \\ U_n^{(\mu)} & \text{otherwise.} \end{cases} \quad (3.19)$$

Then it is clear that $\widehat{W} := W(\xi^{(1)}, \widehat{N}, \widehat{U})$ has the correct law, and that $\widehat{N}_{[0, T]}$, $\widehat{U}_{[1, \widehat{N}_T]}$ are independent of $W^{(\mu)}$. Moreover, we claim that

$$\text{on } \Gamma_T: \quad W_T^{(\mu)} = \widehat{W}_T \implies W_s^{(\mu)} = \widehat{W}_s \ \forall s \geq T. \quad (3.20)$$

To see (3.20), note that, by monotonicity,

$$W(\bar{\mathbf{0}}, N^{(\mu)}, U^{(\mu)}) \leq W_s^{(\mu)} \leq W(\bar{\mathbf{1}}, N^{(\mu)}, U^{(\mu)}), \quad (3.21)$$

so that, on D_T , $(W_s^{(\mu)}, s) \in V_m$ for all $s \geq T$. Since $W^{(\mu)}$ and \widehat{W} use the same jump decisions after time T , if they are equal at time T and Γ_T occurs, then they will see forever the same random environment, and will thus remain equal for all subsequent times.

With this observation, we are now ready to prove (3.17) by showing that

$$\mathbb{P}\left(\lim_{t \rightarrow \infty} t^{-1}W_t^{(\mu)} = v \mid \Gamma_T, W_T^{(\mu)} = x\right) = 1 \quad (3.22)$$

for each $x \in \mathbb{Z} \cap [-mT, mT]$. To that end, first note that, for each fixed x , there exists an event $B_x \in \sigma(\widehat{N}_{[0, T]}, \widehat{U}_{[1, \widehat{N}_T]})$ with positive probability such that $\widehat{W}_T = x$ on B_x . Indeed, since all the jump rates α_i, β_i , $i \in \{0, 1\}$ are strictly positive, we can fix the number and direction of jumps of \widehat{W} on $[0, T]$ by imposing restrictions on $\widehat{N}_{[0, T]}$, $\widehat{U}_{[1, \widehat{N}_T]}$. To conclude (3.22), we write

$$\begin{aligned} \mathbb{P}\left(\lim_{t \rightarrow \infty} t^{-1}W_t^{(\mu)} = v \mid \Gamma_T, W_T^{(\mu)} = x\right) &= \mathbb{P}\left(\lim_{t \rightarrow \infty} t^{-1}W_t^{(\mu)} = v \mid \Gamma_T, W_T^{(\mu)} = x, B_x\right) \\ &= \mathbb{P}\left(\lim_{t \rightarrow \infty} t^{-1}W_t^{(1)} = v \mid \Gamma_T, W_T^{(\mu)} = x, B_x\right) \\ &= 1, \end{aligned} \quad (3.23)$$

where we use Proposition 3.2. ■

Remark 3.4. In the case $\mu = \nu_\lambda$ (for which (3.11) holds by Proposition 3.5 below), the conclusion of Proposition 3.3 is true even when some of the jump rates $\alpha_i, \beta_i, i \in \{0, 1\}$ are equal to zero (note that the proof of Proposition 3.2 does not need all rates to be strictly positive). To adapt the proof, replace the conditioning on $W_T^{(\mu)} = x$ in (3.22) by the event $\{N_T^{(\mu)} = 0\}$, which implies $W_T^{(\mu)} = 0$. Then $(W_{t+T}^{(\mu)} - W_T^{(\mu)})_{t \geq 0}$ under $\mathbb{P}(\cdot | N_T^{(\mu)} = 0)$ has the same distribution as W under \mathbb{P}_{ν_λ} . Since $\widehat{N}_T = 0$ implies $\widehat{W}_T = 0$ and has positive probability, the claim follows as before.

We next show that (3.11) is satisfied whenever μ contains a non-trivial ergodic measure. This together with Proposition 3.3 finishes the proof of Theorem 1.1(a).

Proposition 3.5. *If μ is stochastically larger than a non-trivial probability measure $\bar{\mu}$ that is shift-invariant and ergodic, then (3.11) holds under the coupling given by the graphical representation in Section 2.1.*

Proof. Let $\xi^{(\mu)}, \xi^{(\bar{\mu})}$ and $\xi^{(1)}$ be copies of the contact process started from the corresponding initial measures, constructed with the same graphical representation given by H, I and such that $\xi_0^{(\bar{\mu})} \leq \xi_0^{(\mu)}$. Since this coupling preserves the ordering, we have $\xi_t^{(\bar{\mu})} \leq \xi_t^{(\mu)} \leq \xi_t^{(1)}$ for all $t \geq 0$, and so we may assume that μ is non-trivial, shift-invariant and ergodic.

Denote by P the joint law of $\xi_0^{(\mu)}, H, I$. Regarding P as a law on the product space

$$(\{0, 1\} \times D(\mathbb{N}_0, [0, \infty)))^{\mathbb{Z}} = \{0, 1\}^{\mathbb{Z}} \times (D(\mathbb{N}_0, [0, \infty)))^{\mathbb{Z}}, \quad (3.24)$$

where $D(\mathbb{N}_0, [0, \infty))$ is the space of càdlàg functions from $[0, \infty)$ to \mathbb{N}_0 , we see that P is shift-ergodic because it is the product of probability measures that are shift-ergodic, namely, μ and the distributions of H and I . Let

$$\Lambda_x := \left\{ \eta(x) = 1, (x - L_t(x)) \wedge (R_t(x) - x) \geq \lfloor (\iota/2)t \rfloor \forall t \geq 0 \right\}, \quad (3.25)$$

i.e., the event that x generates a “wide-spread infection” (moving at speed at least half the typical asymptotic speed ι). Since Λ_x is a translation of Λ_0 , we have

$$\lim_{n \rightarrow \infty} \frac{1}{n} \sum_{x=1}^n \mathbb{1}_{\Lambda_x} = P(\Lambda_0) = P(\xi_0(0) = 1) P(\Lambda_0 | \xi_0(0) = 1) := \varrho > 0 \quad P\text{-a.s.}, \quad (3.26)$$

where the last inequality is justified as follows: $P(\xi_0(0) = 1) > 0$ since μ is assumed to be non-trivial, and $P(\Lambda_0 | \xi_0(0) = 1) > 0$ by (2.4) and local modifications of the graphical representation.

Next, for $n \in \mathbb{N}$, define $Z_n \in \mathbb{N}$ by the equation

$$\sum_{x=1}^{Z_n} \mathbb{1}_{\Lambda_x} = n. \quad (3.27)$$

Then we also have

$$\lim_{n \rightarrow \infty} \frac{Z_n}{n} = \varrho^{-1} \quad P\text{-a.s.} \quad (3.28)$$

$(Z_n)_{n \in \mathbb{N}}$ marks the positions of wide-spread infections to the right of the origin, i.e., $x > 0$ such that Λ_x occurs. Equation (3.28) means that these wide-spread infections are not too far apart. Extending the definition of Z_n to the negative integers, we obtain analogously that $\lim_{n \rightarrow \infty} n^{-1}(-Z_{-n}) = \varrho^{-1}$ P -a.s. Let $\mathcal{Z} := \cup_{n \in \mathbb{N}} \{Z_n, Z_{-n}\}$ and

$$\mathcal{S} := \{(y, t) \in \mathbb{Z} \times [2/\iota, \infty) : \exists x \in \mathcal{Z} \text{ such that } |y - x| \leq (\iota/2)t - 1\}. \quad (3.29)$$

Then \mathcal{S} is the union of cones of inclination angle $\iota/2$ with tips at $(2/\iota, z)$ with $z \in \mathcal{Z}$ (see Fig. 4). We call \mathcal{S} the *safe region*. This is justified by the following fact, whose proof is a direct consequence of Lemma 2.2.

Lemma 3.6. *If $(x, t) \in \mathcal{S}$, then $\xi_t^{(\mu)}(x) = \xi_t^{(1)}(x)$.*

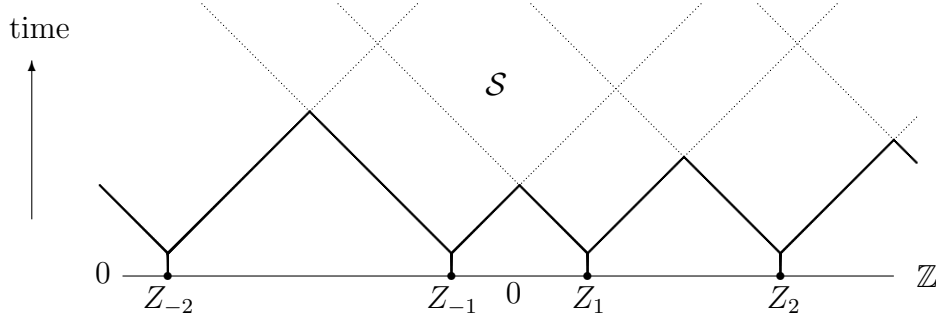

Figure 4: Cones have inclination angle $\iota/2$. The safe region \mathcal{S} lies above the thick lines.

By Lemma 3.6, it is enough to prove that, for any $m > 0$,

$$V_m \cap \mathcal{S}^c \text{ is a bounded subset of } \mathbb{Z} \times [0, \infty) \quad P\text{-a.s.} \quad (3.30)$$

To that end, note that \mathcal{S}^c is contained in the union of space-time “houses” (unions of triangles and rectangles) with base at time 0. The tips of the houses to the right of 0 form a sequence with spatial coordinates $\frac{1}{2}(Z_{n+1} + Z_n)$ and temporal coordinates $(Z_{n+1} - Z_n + 2)/\iota$, $n \in \mathbb{N}$. By (3.28), the ratio of temporal/spatial coordinates tends to 0 as $n \rightarrow \infty$, so that only finitely many tips can be inside V_m . The same is true for the tips of the houses to the left of 0. Therefore V_m touches only finitely many houses, which proves (3.30). ■

Remark 3.7. It is possible to show that (3.11) holds for any initial configuration that has a positive lower density of infections to the right and to the left of the origin. We will not pursue this extension here, and content ourselves with giving a sketch of a proof strategy that uses the techniques from Section 4 below. Let

$$\Lambda_x^* := \left\{ \begin{array}{l} \text{there exist two paths } \pi_s^-, \pi_s^+ \text{ such that } (x, 0) \leftrightarrow (\pi_s^\pm, s) \\ \text{and } \lfloor \iota/2s \rfloor \leq \pm(\pi_s^\pm - x) \leq 2\iota s \quad \forall s \geq 0 \end{array} \right\}. \quad (3.31)$$

Fix x with $\xi_0(x) = 1$. With the help of the methods used in the proof of Lemma 4.3 below, we may show that if Λ_x^* does not occur, then there is a positive random variable L_x with a (uniform) exponential moment such that, for any $k \in \mathbb{N}$, $\Lambda_{x+L_x+k}^*$ is independent of Λ_x^* , L_x and distributed as Λ_0^* . Therefore, after a geometric number of trials we find a point $y > x$ such that $\xi_0(y) = 1$ and Λ_y^* occurs. Next, we use Lemma 4.1 and the FKG-inequality (see [7]) to forget all information gathered so far and start afresh at the next point $z > y$ such that $\xi_0(z) = 1$. In this way we prove that the configuration $\eta^*(x) := \xi_0(x)\mathbb{1}_{\Lambda_x^*}$ has a positive lower density, and from this point on we may continue as in the proof of Proposition 3.5.

4 More on the contact process

In this section we collect some additional facts about the contact process on \mathbb{Z} that will be needed in the remainder of the paper. The proofs rely on geometric observations that will also illuminate the proof strategies developed in Sections 5–6.

In the following we will use the notation

$$\mathbb{Z}_{\leq x} := \mathbb{Z} \cap (-\infty, x] \quad (4.1)$$

and analogously for $\mathbb{Z}_{\geq x}$.

Stochastic domination. We start with a useful alternative construction of the equilibrium ν_λ . Let $\eta(x) := \mathbb{1}_{\{C_t(x) \neq \emptyset \forall t \geq 0\}}$. Then, by the graphical representation, η has distribution ν_λ . This follows from duality (see Liggett [12], Chapter VI). We can also graphically construct the contact process starting from ν_λ : extend the graphical representation to negative times, and declare $\xi_t(x) = 1$ if and only if for all $0 \leq s \leq t$ there exists a y such that $(y, s) \leftrightarrow (x, t)$, i.e., if and only if there exists an infinite infection path going backwards in time from (x, t) .

Let $\bar{\nu}_\lambda$ denote the restriction of ν_λ to $\mathbb{Z}_{\leq -1}$. Abusing notation, we will write the same symbol to denote the measure on Ω that is the product of $\bar{\nu}_\lambda$ with the measure concentrated on all sites healthy to the right of -1 . Using the alternative construction above, we can prove that the restriction of $\nu_\lambda(\cdot \mid \eta(0) = 1)$ to $\mathbb{Z}_{\leq -1}$ is stochastically larger than $\bar{\nu}_\lambda$. In the following, we will focus on a similar result for the distribution of ξ_t to the left of certain infection paths.

For $\varpi_{[0,t]}$ a nearest-neighbor càdlàg path with values in \mathbb{Z} , let

$$\bar{\mathcal{R}}_t^\varpi := \sigma \left\{ \left(\xi_0(x) \right)_{x \geq \varpi_0}, \right. \\ \left. \left(H_v(x) - H_u(x), I_v(x) - I_u(x) \right)_{\{(x,u,v) \in \mathbb{Z} \times [0,t]^2 : u \leq v, x \geq \sup_{s \in [u,v]} \varpi_s\}} \right\}. \quad (4.2)$$

Suppose that $\pi_{[0,t]}$ is a random path of the same type, with the following properties:

- (p1) $\xi_0(\pi_0) = 1$ a.s. and $(\pi_s, s) \leftrightarrow (\pi_u, u)$ for all $s, u \in [0, t]$.

(p2) π is \mathcal{F} -adapted and $\{\pi_s \geq \varpi_s \forall s \in [0, t]\} \in \bar{\mathcal{R}}_t^\varpi$ for all deterministic paths ϖ .

We call π a *random infection path* (see Fig. 5), a name that is justified by (p1). Property (p2) means that π is causal and that, when we discover it, we leave the graphical representation to its left untouched. For such π , let

$$\mathcal{R}_t^\pi := \left\{ A \in \mathcal{F}_\infty : A \cap \{\pi_s \geq \varpi_s \forall s \in [0, t]\} \in \bar{\mathcal{R}}_t^\varpi \text{ for every deterministic nearest-neighbor càdlàg path } \varpi_{[0,t]} \right\}. \quad (4.3)$$

Note that, since π is an infection path, also $(\xi_s(x))_{x \geq \pi_s} \in \mathcal{R}_t^\pi$ for each $s \in [0, t]$ (see the proof of Lemma 2.2). We have the following stochastic domination result.

Lemma 4.1. *For any random infection path $\pi_{[0,t]}$ as above, the law of $\xi_t(\cdot + \pi_t + 1)$ under $\mathbb{P}_{\bar{\nu}_\lambda}(\cdot | \mathcal{R}_t^\pi)$ is stochastically larger than $\bar{\nu}_\lambda$.*

Proof. Construct $\mathbb{P}_{\bar{\nu}_\lambda}$ from a graphical representation on $\mathbb{Z} \times \mathbb{R}$ as outlined above by adding healing events on $(x, 0)$ for each $x \in \mathbb{Z}_{\geq 0}$. Extend π to negative times by making it equal to the right-most infinite infection path going backwards in time from $(\pi_0, 0)$. (Such a path exists because $\xi_0(\pi_0) = 1$.) We may check that the resulting path still has properties (p1) and (p2). Extend also \mathcal{R}_t^π to include negative times.

Next, regard H and I as Poisson point processes on subsets of $\mathbb{Z} \times \mathbb{R}$. Let (see Fig. 5)

$$D := \{(x, s) \in \mathbb{Z} \times \mathbb{R} : s > t \text{ or } \pi_s > x\}. \quad (4.4)$$

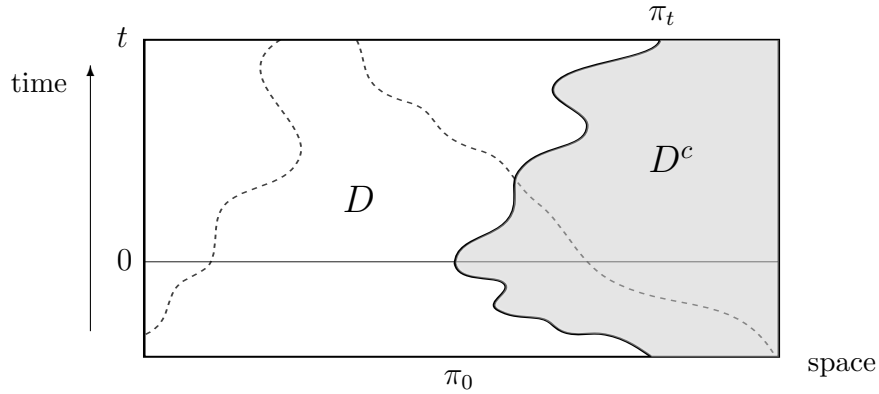

Figure 5: The thick line represents the random infection path π . The dashed lines represent other infection paths.

Given \mathcal{R}_t^π , by (p2) H and I are still Poisson point processes with the same densities on D . This can be justified first for π taking values in a countable set and then for general π using right-continuity.

With this observation we can couple \mathbb{P}_{ν_λ} to $\mathbb{P}_{\bar{\nu}_\lambda}(\cdot | \mathcal{R}_t^\pi)$ in the following way. Draw independent Poisson point processes \hat{H}, \hat{I} on D^c . Take $\hat{\xi}$ to be the contact process obtained by using H, I on D and \hat{H}, \hat{I} on D^c . Then $\hat{\xi}$ is distributed as the contact process under \mathbb{P}_{ν_λ} , and is independent of \mathcal{R}_t^π . Furthermore, $\xi_t(x) \geq \hat{\xi}_t(x)$ for all $x < \pi_t$.

Indeed, if $\xi_t(x) = 1$, then infinite infection paths going backwards in time must either stay inside D or cross π , so that, by (p1), $\xi_t(x) = 1$ as well. \blacksquare

Remark 4.2. In Lemma 4.1, we may replace t by a finite stopping time \mathcal{T} w.r.t. the filtration \mathcal{F} , as long as the event in (p2) is replaced by $\{\mathcal{T} \leq t, \pi_s \geq \varpi_s \forall s \in [0, \mathcal{T}]\}$ and we add \mathcal{T} to \mathcal{R}_T^π . We may also enlarge all filtrations by adding information that is independent of ξ_0, H, I , in particular, $N_{[0,t]}$ and $U_{[1, N_t]}$ (recall Section 2.2).

Infection range. Lemma 4.3 below concerns the positions of wide-spread infections. For $\delta \in (0, \iota)$ and $x \in \mathbb{Z}$, let $\mathcal{W}_x^\delta := \{(z, t) \in \mathbb{Z} \times [0, \infty) : (\iota - \delta)t - 1 < z - x \leq (\iota + \delta)t\}$ be a wedge between two lines of inclination $\iota - \delta$ and $\iota + \delta$. Set $C_t^\delta(x) := \{y \in \mathbb{Z} : (y, t) \leftrightarrow (x, 0) \text{ via a path contained in } \mathcal{W}_x^\delta\}$, and

$$Z_\delta(x) := \sup \{z \in \mathbb{Z}_{<x} : \xi_0(z) = 1, C_t^\delta(z) \neq \emptyset \forall t \geq 0\}, \quad (4.5)$$

i.e., the first infected site to the left of x that spreads its infection forever inside a wedge.

Lemma 4.3. *If $\lambda \in (\lambda_c, \infty)$ then $|Z_\delta(x) - x|$ has exponential moments under \mathbb{P}_{ν_λ} for every $\delta \in (0, \iota)$, uniformly in $x \in \mathbb{Z}_{\leq 0}$.*

Proof. We will use the fact that, for any $\lambda \in (\lambda_c, \infty)$, ν_λ stochastically dominates a non-trivial Bernoulli product measure μ_λ . This follows from Liggett and Steif [15], Theorem 1.2, Durrett and Schonmann [9], Theorem 1, and van den Berg, Häggström and Kahn [6], Theorem 3.5. Since $Z_\delta(x)$ is monotone in ξ_0 , it is therefore enough to prove the statement under \mathbb{P}_{μ_λ} . We may also assume $x = 0$, as $Z_\delta(x)$ does not depend on $(\xi_0(z))_{z \geq x}$.

Construct a sequence of pairs $(Z_n, T_n)_{n \in \mathbb{N}_0}$ as follows. Set $Z_0 = T_0 := 0$ and, recursively for $n \in \mathbb{N}_0$,

$$\begin{aligned} Z_{n+1} &:= \begin{cases} Z_n & \text{if } T_n = \infty, \\ \sup\{z < Z_n - [(\iota + \delta)T_n] : \xi_0(z) = 1\} & \text{otherwise,} \end{cases} \\ T_{n+1} &:= \begin{cases} \infty & \text{if } T_n = \infty, \\ \inf\{t > 0 : C_t^\delta(Z_{n+1}) = \emptyset\} & \text{otherwise.} \end{cases} \end{aligned} \quad (4.6)$$

Conditionally on $T_n < \infty$, $\Delta_{n+1} := Z_{n+1} - Z_n + [(\iota + \delta)T_n]$ and T_{n+1} are independent of $(Z_k, T_k)_{k=1}^n$ and distributed as (Z_1, T_1) . This is because the region of the graphical representation plus initial configuration on which T_{n+1} and Δ_{n+1} depend is disjoint from the region on which the previous random variables depend. Since μ_λ is a non-trivial product measure, $|Z_1|$ has exponential moments. Noting that T_1 is independent of Z_1 we conclude, using standard facts about the contact process (see Liggett [12], Chapter VI, Theorem 2.2, Corollary 3.22 and Theorem 3.23), that $\mathbb{P}_{\mu_\lambda}(T_1 = \infty) > 0$ and that, conditionally on $T_1 < \infty$, T_1 has exponential moments. Defining the random index

$$K := \inf\{n \in \mathbb{N} : T_n = \infty\} \quad (4.7)$$

whose distribution is $\text{GEO}(\mathbb{P}_{\mu_\lambda}(T_1 = \infty))$, we see that $|Z_\delta(0)| \leq |Z_K|$. Taking $a > 0$ such that $\mathbb{E}_{\mu_\lambda}[e^{a(|Z_1| + [(\iota + \delta)T_1])} \mid T_1 < \infty] < 1/\mathbb{P}_\mu(T_1 < \infty)$, we get after a short calculation that $\mathbb{E}_{\mu_\lambda}[\mathbb{1}_{\{K=n\}} e^{a|Z_n|}]$ decays exponentially in n . \blacksquare

5 Properties of the speed

In this section we prove Theorem 1.1(b).

Take $\lambda_\infty, \lambda_k \in (\lambda_c, \infty)$ such that $\lim_{k \rightarrow \infty} \lambda_k = \lambda_\infty$, and write $\mathbb{P}_\mu^{\lambda_\infty}, \mathbb{P}_\mu^{\lambda_k}$ for the measure described in Section 2 with the corresponding parameter and initial measure μ . Fix $n \in \mathbb{N}$ and $\epsilon > 0$, and take $L_{n,\epsilon} > 0$ such that $\mathbb{E}_{\delta_1}^{\lambda_k}[N_n \mathbb{1}_{\{N_n > L_{n,\epsilon}\}}] \leq \epsilon$ uniformly in $k \in \mathbb{N} \cup \{\infty\}$. On the event $\{N_n \leq L_{n,\epsilon}\}$, W_n depends on ξ only inside the finite space-time region $\mathbb{Z} \cap [-L_{n,\epsilon}, L_{n,\epsilon}] \times [0, n]$. Therefore $\mathbb{E}_{\delta_1}^{\lambda_k}[n^{-1}W_n \mathbb{1}_{\{N_n \leq L_{n,\epsilon}\}}]$ converges as $k \rightarrow \infty$ to the same quantity with parameter λ_∞ (see Liggett [14], Part I). Since $|W_n| \leq N_n$, it follows that

$$\begin{aligned} \left| \mathbb{E}_{\delta_1}^{\lambda_k}[n^{-1}W_n] - \mathbb{E}_{\delta_1}^{\lambda_\infty}[n^{-1}W_n] \right| &\leq \left| \mathbb{E}_{\delta_1}^{\lambda_k}[n^{-1}W_n \mathbb{1}_{\{N_n \leq L_{n,\epsilon}\}}] - \mathbb{E}_{\delta_1}^{\lambda_\infty}[n^{-1}W_n \mathbb{1}_{\{N_n \leq L_{n,\epsilon}\}}] \right| \\ &\quad + 2\epsilon. \end{aligned} \tag{5.1}$$

Taking the lim sup as $k \rightarrow \infty$ of (5.1) followed by $\epsilon \downarrow 0$, we get that $\lambda \mapsto \mathbb{E}_{\delta_1}[n^{-1}W_n]$ is continuous. By monotonicity, the latter is also non-decreasing, so it follows from (3.7) that $\lambda \mapsto v(\lambda)$ is right-continuous and non-decreasing.

It remains to show that $v(\lambda) \in (v_0, v_1)$ and $\lim_{\lambda \rightarrow \infty} v(\lambda) = v_1$. This will be done in Sections 5.1–5.2 below. These properties come from the fact that the random walk spends positive fractions of its time on top of infected sites and on top of healthy sites. To keep track of this, define $N_t^i := \#\{n \in \mathbb{N} : \xi_{J_n}(W_{J_{n-1}}) = i\}$, $i \in \{0, 1\}$. Recalling the construction of W in Section 2.2, we may write

$$W_t = S_{N_t^0}^0 + S_{N_t^1}^1, \tag{5.2}$$

where S_n^i , $i = 0, 1$, are discrete-time homogeneous random walks that jump to the right with probability α_i/γ and to the left with probability β_i/γ . From this representation we immediately get the following.

Lemma 5.1.

$$\begin{aligned} \liminf_{t \rightarrow \infty} t^{-1}W_t &= v_0 + (v_1 - v_0) \liminf_{t \rightarrow \infty} (\gamma t)^{-1}N_t^1, \\ \limsup_{t \rightarrow \infty} t^{-1}W_t &= v_1 - (v_1 - v_0) \liminf_{t \rightarrow \infty} (\gamma t)^{-1}N_t^0. \end{aligned} \tag{5.3}$$

Lemma 5.1 is valid for any dynamic random environment, even without a SLLN for W . But (5.3) shows that a SLLN for W holds with speed v if and only if a SLLN holds for N^1 with limit $\gamma\rho_{\text{eff}}$, where $\rho_{\text{eff}} := (v - v_0)/(v_1 - v_0)$ is the effective density of 1's seen by W . Thus, $v > v_0$ and $v < v_1$ are equivalent to, respectively, $\rho_{\text{eff}} > 0$ and $\rho_{\text{eff}} < 1$.

5.1 Proof of $v(\lambda) < v_1$

In the contact process, infected sites heal spontaneously. Therefore it is easier to find 0's than 1's. For this reason, it is easier to prove that W often jumps from healthy sites than from infected sites.

Proof. For $k \in \mathbb{N}$, let $Y_k := \xi_{J_k}(W_{J_{k-1}})$, and note that $\{Y_{k+1} = 0\}$ contains all configurations that between times J_k and J_{k+1} have a cross at site W_{J_k} and no arrows between W_{J_k} and its nearest-neighbors, i.e., such that the events $H_{J_{k+1}}(W_{J_k}) - H_{J_k}(W_{J_k}) \geq 1$ and $I_{J_{k+1}}(W_{J_k}) - I_{J_k}(W_{J_k}) = I_{J_{k+1}}(W_{J_k} - 1) - I_{J_k}(W_{J_k} - 1) = 0$ occur. The probability of the latter events given $\sigma\{(J_k, \xi_s, W_s)_{0 \leq s \leq J_k}\}$ is constant in k and equal to $p := \gamma/(\gamma + 2\lambda)(1 + \gamma + 2\lambda)$. Therefore the sequence $(Y_k)_{k \in \mathbb{N}}$ is stochastically dominated by a sequence of i.i.d. $\text{BERN}(1 - p)$ random variables, which implies that $\liminf_{t \rightarrow \infty} t^{-1} N_t^0 \geq \gamma p > 0$, so that $v(\lambda) < v_1$ by Lemma 5.1. \blacksquare

5.2 Proof of $v(\lambda) > v_0$ and $\lim_{\lambda \rightarrow \infty} v(\lambda) = v_1$

This is the harder part of the proof. We will need results from Section 4. In the following we will assume that $v_0 \leq 0$. The case $v_0 > 0$ can be treated analogously.

Let us start with an informal description of the argument. The idea is that there are “waves of infection” coming from $\pm\infty$ from which the random walk cannot escape. When $v_0 \leq 0$, we can concentrate on the waves coming from the left, represented schematically in Fig. 6. Each time the random walk hits a new wave, there is an infection path starting from its current location and going backwards in time entirely to the left of the random walk path. By Lemma 4.1, at this time the law of ξ to the left of the random walk has an appreciable density, which means that there are new waves coming in from locations not very far to the left. On the other hand, any infections to the right of the random walk can be ignored, since they only push it to the right. But doing so makes the random walk behave as a homogeneous random walk with a non-positive drift, meaning that it does not take the random walk long to hit the next infection wave. Since at each collision there is a fixed probability for the random walk to jump while sitting on an infection, $v(\lambda) > v_0$ will follow from Lemma 5.1. With some care in the computations we also get the limit for large λ .

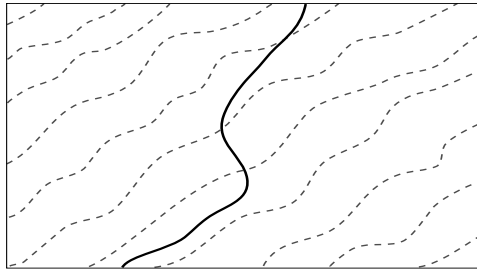

Figure 6: The dashed lines represent infection waves. The thick line represents the path of W .

Proof. Using the graphical representation, we will construct, on a larger probability space, a second random walk \hat{W} coupled to W in such a way that $\hat{W}_t \leq W_t$ for all $t \geq 0$ and that \hat{W} has a speed with the desired properties. Let

$$V_1 := \inf\{t > 0 : \xi_t(W_t) = 1\}. \quad (5.4)$$

Note that V_1 has exponential moments under $\mathbb{P}_{\bar{\nu}_\lambda}$ by Lemma 4.3 and the fact that $v_0 \leq 0$. Let

$$\tau_1 := \inf \{t > V_1 : W_t \neq W_{V_1} \text{ or } H_t(W_{V_1}) > H_{V_1}(W_{V_1})\}, \quad (5.5)$$

i.e., τ_1 is the first time after time V_1 at which either W jumps or there is a healing event at the position of the random walk. Note that τ_1 is a stopping time w.r.t. the filtration \mathcal{G} and that, given \mathcal{G}_{V_1} , $\tau_1 - V_1$ has distribution $\text{EXP}(1 + \gamma)$.

We will construct a sequence $(W^{(n)}, \tau_n)_{n \in \mathbb{N}}$ with the following properties:

- (A1) $W_t^{(n+1)} \leq W_{\tau_n+t}^{(n)} - W_{\tau_n}^{(n)}$ for all $t \geq 0$;
- (A2) $(W^{(n)}, \tau_n)$ is distributed as (W, τ_1) under $\mathbb{P}_{\bar{\nu}_\lambda}$;
- (A3) $(W_{[0, \tau_n]}^{(n)}, \tau_n)_{n \in \mathbb{N}}$ is i.i.d.;
- (A4) If $\hat{v}(\lambda) := \mathbb{E}_{\bar{\nu}_\lambda}[W_{\tau_1}]/\mathbb{E}_{\bar{\nu}_\lambda}[\tau_1]$, then $\hat{v}(\lambda) > v_0$ and $\lim_{\lambda \rightarrow \infty} \hat{v}(\lambda) = v_1$.

Once we have this sequence, we can put $T_0 := 0$, $T_n := \sum_{k=1}^n \tau_k$ for $n \in \mathbb{N}$, and

$$\hat{W}_t := \sum_{k=1}^n W_{\tau_k}^{(k)} + W_{t-T_n}^{(n+1)} \quad \text{for } T_n \leq t < T_{n+1}. \quad (5.6)$$

By (A1), $\hat{W}_t \leq W_t^{(1)}$ for all $t \geq 0$. By (A2), the latter is distributed as W under $\mathbb{P}_{\bar{\nu}_\lambda}$, which by monotonicity is stochastically smaller than W under \mathbb{P}_{ν_λ} . By (A3), $\lim_{n \rightarrow \infty} T_n^{-1} \hat{W}_{T_n} = \hat{v}(\lambda)$, and so the claim follows from (A4). Thus, it remains to construct the sequence $(W^{(n)}, \tau_n)_{n \in \mathbb{N}}$ with properties (A1)–(A4).

To do so, we draw ξ_0 from $\bar{\nu}_\lambda$, let $\xi^{(1)} := \xi$, $W^{(1)} := W$, define τ_1 as above, and note the following.

Lemma 5.2. *Under $\mathbb{P}_{\bar{\nu}_\lambda}(\cdot \mid \tau_1, W_{[0, \tau_1]})$, the law of $\xi_{\tau_1}(\cdot + W_{\tau_1})$ is stochastically larger than $\bar{\nu}_\lambda$.*

Proof. Since $\xi_{V_1}(W_{V_1}) = 1$, there exists a right-most infection path $\pi_{[0, V_1]}$ connecting (W_{V_1}, V_1) to $\mathbb{Z}_{\leq -1} \times \{0\}$. Extend π to $[V_1, \tau_1]$ by making it constant and equal to W_{V_1} on this time interval. Since $\pi_s \leq W_s$ for all $0 \leq s < \tau_1$, we have $(\tau_1, W_{[0, \tau_1]}) \in \mathcal{R}_{\tau_1}^\pi \vee \sigma(N_{[0, \tau_1]}, U_{[1, N_{\tau_1}]})$. Note that π is not an infection path, but only because of a possible healing event at time τ_1 , which does not affect $(\xi_{\tau_1}(x + W_{V_1}))_{x \leq -1}$. Therefore, by Lemma 4.1, the distribution of $\eta_1(\cdot) := \xi_{\tau_1}(\cdot + W_{V_1})$ given $(\tau_1, W_{[0, \tau_1]})$ is stochastically larger than $\bar{\nu}_\lambda$. Moreover, $(\eta_1(x))_{x < W_{V_1}}$ is independent of $W_{\tau_1} - W_{V_1}$, and so we need only verify that the distribution of $\eta_2 := \xi_{\tau_1}(\cdot + W_{\tau_1}) = \theta_{W_{\tau_1} - W_{V_1}} \eta_1$ is stochastically larger than $\bar{\nu}_\lambda$ for each possible outcome of $W_{\tau_1} - W_{V_1} \in \{0, \pm 1\}$. Since, by the definitions of V_1 and τ_1 , $W_{\tau_1} \neq W_{V_1}$ if and only if $\xi_{\tau_1}(W_{V_1}) = 1$, the possible choices for η_2 are: η_1 if $W_{\tau_1} = W_{V_1}$, $\theta_{-1} \eta_1$ if $W_{\tau_1} = W_{V_1} - 1$, or $\theta_1 \eta_1$ if $W_{\tau_1} = W_{V_1} + 1$. In the latter case, $\eta_2(-1) = 1$, and therefore all three possibilities are indeed stochastically larger than $\bar{\nu}_\lambda$ as claimed. \blacksquare

By Lemma 5.2, there exists a configuration $\xi_0^{(2)}$ distributed as $\bar{\nu}_\lambda$, independent of $(\tau_1, W_{[0, \tau_1]})$ and smaller than $\xi_{\tau_1}^{(1)}(\cdot + W_{\tau_1})$. We may now define $\xi^{(2)}$ by using the events of the graphical representation that lie above time τ_1 with the origin shifted to W_{τ_1} , using $\xi_0^{(2)}$ as starting configuration. We may then define $W^{(2)}$ and τ_2 from $\xi^{(2)}$, $(N_{t+\tau_1} - N_{\tau_1})_{t \geq 0}$ and $(U_k)_{k > N_{\tau_1}}$. With this coupling, clearly $W_t^{(2)} \leq W_{\tau_1+t}^{(1)} - W_{\tau_1}^{(1)}$ for all $t \geq 0$. Furthermore, since $\xi_0^{(2)}$ is independent of $(\tau_1, W_{[0, \tau_1]})$, the distribution of $\xi_{\tau_2}^{(2)}(\cdot + W_{\tau_2}^{(2)})$ given $(W_{[0, \tau_i]}^{(i)}, \tau_i)_{i=1,2}$ depends only on the random variables with $i = 2$ and hence, by Lemma 5.2, is again stochastically larger than $\bar{\nu}_\lambda$.

We may therefore repeat the argument. More precisely, suppose by induction that we have defined $\xi^{(k)}$, $W^{(k)}$ and τ_k for $k = 1, \dots, n$ and $n \geq 2$, in such a way that:

$$(B1) \quad W_t^{(k+1)} \leq W_{\tau_n+t}^{(k)} - W_{\tau_n}^{(n)} \text{ for all } t \geq 0 \text{ and } k = 1 \dots n-1;$$

$$(B2) \quad (W^{(k)}, \tau_k) \text{ is distributed as } (W, \tau_1) \text{ under } \mathbb{P}_{\bar{\nu}_\lambda} \text{ for all } k = 1, \dots, n;$$

$$(B3) \quad (W_{[0, \tau_k]}^{(k)}, \tau_k)_{k=1}^n \text{ is i.i.d.};$$

$$(B4) \quad \text{The law of } \xi^{(n)}(\cdot + W_{\tau_n}^{(n)}) \text{ given } (W_{[0, \tau_k]}^{(k)}, \tau_k)_{k=1}^n \text{ is stochastically larger than } \bar{\nu}_\lambda.$$

Then we proceed as before: there exists a configuration $\xi_0^{(n+1)}$ distributed as $\bar{\nu}_\lambda$, smaller than $\xi^{(n)}(\cdot + W_{\tau_n}^{(n)})$ and independent of $(W_{[0, \tau_k]}^{(k)}, \tau_k)_{k=1}^n$, from which we obtain $\xi^{(n+1)}$, $W^{(n+1)}$ and τ_{n+1} , and we prove (B1)–(B4) as in the case $n = 2$. This settles the existence of the sequence $(W^{(n)}, \tau_n)_{n \in \mathbb{N}}$. All that is left to show is that $\hat{v}(\lambda) > v_0$ and $\lim_{\lambda \rightarrow \infty} \hat{v}(\lambda) = v_1$.

Note that Lemma 5.1 is valid also for \hat{W} , and write \hat{N}_t^1 to denote the number of jumps that \hat{W} takes on infected sites. Then $\hat{N}_{T_n}^1$ has distribution $\text{BINOM}(n, \gamma/(1+\gamma))$, and by standard arguments we obtain

$$\lim_{t \rightarrow \infty} t^{-1} \hat{N}_t^1 = \frac{\gamma}{(1+\gamma)\mathbb{E}_{\bar{\nu}_\lambda}[\tau_1]} > 0, \quad (5.7)$$

which proves $\hat{v}(\lambda) > v_0$. Furthermore, we claim that $\lim_{\lambda \rightarrow \infty} \mathbb{E}_{\bar{\nu}_\lambda}[V_1] = 0$. Indeed, V_1 is nonincreasing in λ and, since $\lim_{\lambda \rightarrow \infty} \rho_\lambda = 1$ (recall Section 1.2), it is not hard to see that V_1 converges in probability to zero as $\lambda \rightarrow \infty$. Therefore $\lim_{\lambda \rightarrow \infty} \mathbb{E}_{\bar{\nu}_\lambda}[\tau_1] = 1/(1+\gamma)$, and so $\lim_{\lambda \rightarrow \infty} \hat{v}(\lambda) = v_1$. \blacksquare

6 Regeneration, functional CLT and LDP

The proof of Theorem 1.2 depends on the construction of *regeneration times*, i.e., times at which the random walk forgets its past. This construction will be carried out in Section 6.1 and is based on two propositions (Propositions 6.1–6.2 below), which are proved in Sections 6.2–6.3. At the end of Section 6.1 we will see that these propositions imply Theorem 1.2(a,c). The proof of Theorem 1.2(b) is deferred to Section 6.4.

6.1 Regeneration times

If the infection propagation speed $\iota = \iota(\lambda)$ is larger than $|v_0| \vee |v_1|$, the maximum absolute speed at which the random walk can move, then each time W finds itself on an infected site it can become “trapped” forever in an infection cluster generated by this site alone. In that case, by Lemma 2.2, the future increments of W become independent of its past. The issue is therefore to find enough moments when W sits on an infection. This can be dealt with in a way similar to what was done in the proof of $v(\lambda) > v_0$ in Section 5.2.

Hitting, failure and trial times. In order to build the regeneration structure, we first need to extend some definitions related to clusters and right-most infections. For $s \geq t$ and $x \in \mathbb{Z}$, let

$$C_{t,s}(x) := \{y \in \mathbb{Z} : (x, t) \leftrightarrow (y, s)\} \quad (6.1)$$

and

$$R_{t,s}(x) := \sup C_{t,s}(x), \quad L_{t,s}(x) := \inf C_{t,s}(x). \quad (6.2)$$

Furthermore, let

$$r_{t,s}(x) := \sup_{\substack{y < x \\ \xi_t(y)=1}} R_{t,s}(y), \quad (6.3)$$

i.e., $r_{t,s}(x)$ is the right-most infection at time s that comes from $\mathbb{Z}_{\leq x-1} \times \{t\}$.

For $t \geq 0$ and $z \in \mathbb{Z}$, let

$$V_t(z) := \inf \{s > t : W_s = r_{t,s}(z)\} \quad (6.4)$$

be the first time after time t at which W meets the right-most infection coming from $\mathbb{Z}_{\leq z-1} \times \{t\}$. We will call this the z -wave hitting time after t . It is not hard to see that $V_t(z) < \infty$ \mathbb{P}_{ν_λ} -a.s. for any t and $z \leq W_t$. Indeed, at any time t there is an infected site $x < z$ whose infection survives forever, and in this case $\lim_{s \rightarrow \infty} s^{-1} R_{t,s}(x) = \iota > |v_0| \vee |v_1|$. Therefore there must be an $s > t$ for which $R_{t,s}(x) = W_s$. By right-continuity, $\mathbb{P}_{\nu_\lambda}(V_t(z) < \infty \forall z \leq W_t, t \geq 0) = 1$ as well.

Now define the first *failure time* after time t by (see Fig. 8)

$$F_t := \inf \{s > t : W_s \notin [L_{t,s}(W_t), R_{t,s}(W_t)]\}, \quad (6.5)$$

i.e., the first time after time t when W exits the region surrounded by the cluster of (W_t, t) . To keep track of the space-time region on which the failure time depends, define, for $t \geq 0$ and $x \in \mathbb{Z}$,

$$(Y_{t,s}(x))_{s \geq t} \quad (6.6)$$

as the process with values in \mathbb{Z} that starts at time t at site x and jumps down by following the infection arrows to the left in the graphical representation (see Fig. 7). Then, given \mathcal{G}_t , $(x - Y_{t,t+s}(x))_{s \geq 0}$ is a Poisson process with rate λ .

With the above observations we can define the *trial time* after a failure time (see Fig. 8):

$$T_t := \begin{cases} \infty & \text{if } F_t = \infty, \\ V_{F_t}(Y_{t,F_t}(W_t)) & \text{otherwise,} \end{cases} \quad (6.7)$$

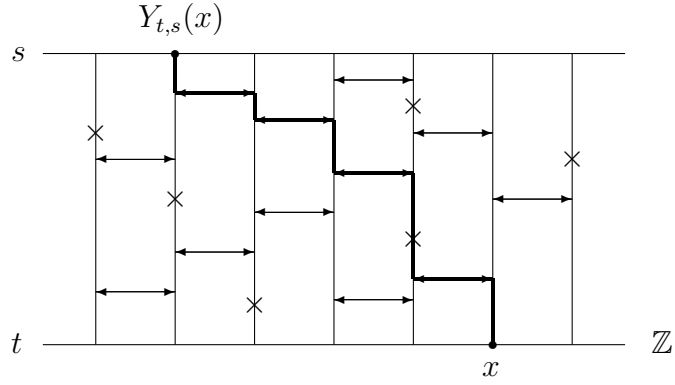

Figure 7: $Y_{t,s}(x)$ starts at x and goes upwards and to the left across the arrows of the graphical representation.

i.e., T_t is the $Y_{t,F_t}(W_t)$ -wave time after time F_t when the latter is finite. This wave ensures “good conditions” at the trial time, meaning an appreciable density of infections to the left of W .

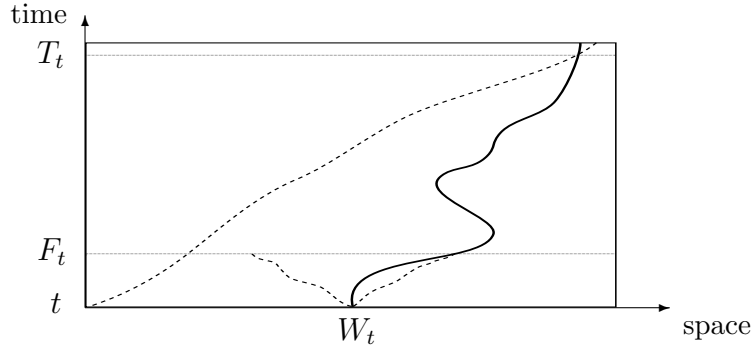

Figure 8: A failure time F_t and a trial time T_t after time t . The dashed lines represent infection paths. The thick line represents the path of W .

Regeneration times. We can now define our regeneration time τ . First let

$$\mathcal{T}_1 := V_0(0) \tag{6.8}$$

and, under the assumption that $\mathcal{T}_1, \dots, \mathcal{T}_k, k \in \mathbb{N}$, are all defined, let

$$\mathcal{T}_{k+1} := \begin{cases} \infty & \text{if } \mathcal{T}_k = \infty, \\ T_{\mathcal{T}_k} & \text{otherwise.} \end{cases} \tag{6.9}$$

Note that the \mathcal{T}_k 's are stopping times w.r.t. the filtration \mathcal{G} . Finally, put

$$K := \inf \{k \in \mathbb{N} : \mathcal{T}_k < \infty, \mathcal{T}_{k+1} = \infty\}, \tag{6.10}$$

and let

$$\tau := \mathcal{T}_K. \tag{6.11}$$

Note that $K < \infty$ a.s. since, at any trial time, the probability for the next failure time to be infinite is uniformly bounded from below. We will prove in Sections 6.2–6.3 that τ is a regeneration time and has exponential moments. This is stated in the following two propositions.

Proposition 6.1. *The distribution of $(W_{t+\tau} - W_\tau)_{t \geq 0}$ under both $\mathbb{P}_{\nu_\lambda}(\cdot \mid \tau, W_{[0,\tau]})$ and $\mathbb{P}_{\nu_\lambda}(\cdot \mid \Gamma, \tau, W_{[0,\tau]})$ is the same as that of W under $\mathbb{P}_{\nu_\lambda}(\cdot \mid \Gamma)$, where*

$$\Gamma := \{\xi_0(0) = 1, F_0 = \infty\}. \quad (6.12)$$

Proposition 6.2. *τ and $|W_\tau|$ have exponential moments under both \mathbb{P}_{ν_λ} and $\mathbb{P}_{\nu_\lambda}(\cdot \mid \Gamma)$, uniformly in $\lambda \in [\lambda_-, \lambda_+]$ for any fixed $\lambda_-, \lambda_+ \in (\lambda_W, \infty)$.*

These two propositions imply the LLN and Theorem 1.2(a), with

$$v(\lambda) = \frac{\mathbb{E}_{\nu_\lambda}[W_\tau \mid \Gamma]}{\mathbb{E}_{\nu_\lambda}[\tau \mid \Gamma]}, \quad \sigma(\lambda)^2 = \frac{\mathbb{E}_{\nu_\lambda}[(W_\tau)^2 \mid \Gamma] - \mathbb{E}_{\nu_\lambda}[W_\tau \mid \Gamma]^2}{\mathbb{E}_{\nu_\lambda}[\tau \mid \Gamma]}. \quad (6.13)$$

They also imply that

$$\limsup_{t \rightarrow \infty} \frac{1}{t} \log \mathbb{P}_{\nu_\lambda}(t^{-1}W_t \notin (v - \epsilon, v + \epsilon)) < 0 \quad \forall \epsilon > 0. \quad (6.14)$$

For a proof of these facts, the reader can follow word-by-word the arguments given in Avena, dos Santos and Völlering [5], Theorem 3.8 and Section 4.1 (which do not require (1.5)–(1.6)).

Theorem 1.2(c) follows from (6.14) and the partial LDP proven in Avena, den Hollander and Redig [3] for attractive spin-flip systems (including the contact process). Here, partial means that the LDP is shown to hold outside a possible interval where the rate function is zero. However, (6.14) precisely precludes the presence of such an interval. (See Glynn and Whitt [10], Theorem 3, for more details.)

The proof of Theorem 1.2(b) is deferred to Section 6.4.

Remark 6.3. It is easy to check that $\tau < \infty$ \mathbb{P}_η -a.s. whenever η contains infinitely many infections. Hence the FCLT also holds under \mathbb{P}_η for any such η . Moreover, the result in [3] concerning the partial LDP holds whenever the initial measure μ has positive correlations. If additionally μ is stochastically larger than a non-trivial Bernoulli product measure, then it is possible to show that τ has exponential moments under \mathbb{P}_μ , which implies that the LDP also holds under \mathbb{P}_μ , with a possibly different rate function that however still has a unique zero at v . A proof that τ has exponential moments in this situation does not follow directly from the proof of Theorem 6.2 given below, but can be obtained with the help of the method that was used in the proof of Lemma 4.3.

6.2 Proof of Proposition 6.1

We first show that the regeneration strategy indeed makes sense.

Lemma 6.4. For all $t \geq 0$,

$$\mathbb{P}_{\nu_\lambda} (F_t = \infty, (W_{s+t} - W_t)_{s \geq 0} \in \cdot \mid \mathcal{G}_t) = \mathbb{P}_{\mathbf{1}_0} (\Gamma_0, W \in \cdot) \text{ a.s. on } \{\xi_t(W_t) = 1\}, \quad (6.15)$$

where $\Gamma_0 := \{F_0 = \infty\}$. The same is true for a finite stopping time w.r.t. \mathcal{G} replacing t .

Proof. First note that $\mathbb{P}_\eta(\Gamma_0, W \in \cdot) = \mathbb{P}_{\mathbf{1}_0}(\Gamma_0, W \in \cdot)$ for any η with $\eta(0) = 1$. This follows from Lemma 2.2 because, on Γ_0 , W depends on ξ only through $\{\xi_t(x) : t \geq 0, x \in [L_t(0), R_t(0)]\}$, and Γ_0 does not depend on ξ_0 . Now, letting $\hat{\xi}_t(\cdot) := \xi_t(\cdot + W_t)$, we can write (recall (6.5))

$$\begin{aligned} \mathbb{P}_{\nu_\lambda} \left(\xi_t(W_t) = 1, F_t = \infty, (W_{s+t} - W_t)_{s \geq 0} \in \cdot \mid \mathcal{G}_t \right) \\ = \mathbb{E}_{\nu_\lambda} \left[\xi_t(W_t) \mathbb{P}_{\hat{\xi}_t}(\Gamma_0, W \in \cdot) \mid \mathcal{G}_t \right] = \xi_t(W_t) \mathbb{P}_{\mathbf{1}_0}(\Gamma_0, W \in \cdot), \end{aligned} \quad (6.16)$$

where the first equality is justified by the Markov property and the translation invariance of the graphical representation. To extend the result to stopping times we can use the strong Markov property of (ξ, W) . \blacksquare

With the help of Lemma 6.4 we are ready to prove Proposition 6.1.

Proof. We will closely follow the proof of Theorem 3.4 in [5]. Let \mathcal{G}_τ be the σ -algebra of all events B such that, for all $n \in \mathbb{N}_0$, there exists a $B_n \in \mathcal{G}_{\mathcal{T}_n}$ such that $B \cap \{K = n\} = B_n \cap \{K = n\}$. Note that τ and $W_{[0, \tau]}$ are in \mathcal{G}_τ .

In the following, we abbreviate $W^{(t)} := (W_{s+t} - W_t)_{s \geq 0}$. Pick f bounded and measurable, $B \in \mathcal{G}_\tau$, and write (recall (6.9))

$$\begin{aligned} \mathbb{E}_{\nu_\lambda} [\mathbb{1}_B f(W^{(\tau)})] &= \sum_{n \in \mathbb{N}_0} \mathbb{E}_{\nu_\lambda} [\mathbb{1}_{B_n} \mathbb{1}_{\{K=n\}} f(W^{(\mathcal{T}_n)})] \\ &= \sum_{n \in \mathbb{N}_0} \mathbb{E}_{\nu_\lambda} \left[\mathbb{1}_{B_n} \mathbb{1}_{\{\mathcal{T}_n < \infty\}} \mathbb{E}_{\nu_\lambda} [\mathbb{1}_{\{F_{\mathcal{T}_n} = \infty\}} f(W^{(\mathcal{T}_n)}) \mid \mathcal{G}_{\mathcal{T}_n}] \right]. \end{aligned} \quad (6.17)$$

Since $\xi_{\mathcal{T}_n}(W_{\mathcal{T}_n}) = 1$ on $\{\mathcal{T}_n < \infty\}$, by Lemma 6.4 the last line of (6.17) equals

$$\begin{aligned} \mathbb{E}_{\mathbf{1}_0} [f(W) \mathbb{1}_{\Gamma_0}] \sum_{n \in \mathbb{N}_0} \mathbb{E}_{\nu_\lambda} [\mathbb{1}_{B_n} \mathbb{1}_{\{\mathcal{T}_n < \infty\}}] \\ = \mathbb{E}_{\mathbf{1}_0} [f(W) \mid \Gamma_0] \sum_{n \in \mathbb{N}_0} \mathbb{E}_{\nu_\lambda} [\mathbb{1}_{B_n} \mathbb{1}_{\{\mathcal{T}_n < \infty\}}] \mathbb{P}_{\mathbf{1}_0}(\Gamma_0), \end{aligned} \quad (6.18)$$

which, again by Lemma 6.4, equals

$$\begin{aligned} \mathbb{E}_{\mathbf{1}_0} [f(W) \mid \Gamma_0] \sum_{n \in \mathbb{N}_0} \mathbb{E}_{\nu_\lambda} [\mathbb{1}_{B_n} \mathbb{1}_{\{\mathcal{T}_n < \infty\}} \mathbb{P}_{\nu_\lambda}(F_{\mathcal{T}_n} = \infty \mid \mathcal{G}_{\mathcal{T}_n})] \\ = \mathbb{E}_{\mathbf{1}_0} [f(W) \mid \Gamma_0] \sum_{n \in \mathbb{N}_0} \mathbb{P}_{\nu_\lambda}(B_n, K = n) \\ = \mathbb{E}_{\mathbf{1}_0} [f(W) \mid \Gamma_0] \mathbb{P}_{\nu_\lambda}(B) \\ = \mathbb{E}_{\nu_\lambda} [f(W) \mid \Gamma] \mathbb{P}_{\nu_\lambda}(B), \end{aligned} \quad (6.19)$$

where the last equality is, one more time, justified by Lemma 6.4. This proves the claim under \mathbb{P}_{ν_λ} .

To extend the claim to $\mathbb{P}_{\nu_\lambda}(\cdot \mid \Gamma)$, note that $\Gamma \in \mathcal{G}_\tau$ since

$$\Gamma \cap \{K = n\} = \{\xi_0(0) = 1, W_s \in [L_s(0), R_s(0)] \forall s \in [0, \mathcal{T}_n]\} \cap \{K = n\}, \quad (6.20)$$

and apply (6.19) to $B \cap \Gamma$ instead of B . \blacksquare

6.3 Proof of Proposition 6.2

Exponential moments. We first show that T_0 has exponential moments when it is finite, uniformly for λ in compact sets. Fix $\lambda_-, \lambda_+ \in (\lambda_W, \infty)$, $\lambda_- \leq \lambda_+$.

Lemma 6.5. *For every $\lambda \in [\lambda_-, \lambda_+]$ and $\epsilon > 0$ there exists an $a = a(\lambda_-, \lambda_+, \epsilon) > 0$ such that, for any probability measure μ stochastically larger than $\bar{\nu}_\lambda$,*

$$\begin{aligned} (a) \quad & \mathbb{E}_\mu \left[\mathbb{1}_{\{T_0 < \infty\}} e^{aT_0} \right] \leq 1 + \epsilon. \\ (b) \quad & \mathbb{E}_\mu \left[e^{aV_0(0)} \right] \leq 1 + \epsilon. \end{aligned} \quad (6.21)$$

Proof. We couple systems with infection rates λ_-, λ and λ_+ starting, respectively, from $\bar{\nu}_{\lambda_-}, \mu$ and $\mathbf{1}$, by coupling their initial configurations and their infection events monotonically. Denote their joint law by \mathbb{P} . In what follows, we will refer to these systems by their rates and we will use a superscript to indicate on which system a random variable depends.

We will bound $T_0 \mathbb{1}_{\{T_0 < \infty\}} = T_0 \mathbb{1}_{\{F_0 < \infty\}}$ by a time D_0 that depends only on systems λ_\pm and has exponential moments under \mathbb{P} . We start by bounding $F_0 \mathbb{1}_{\{F_0 < \infty\}}$ by a variable D_1 depending only on system λ_- . Let

$$r_t := \sup_{x \in \mathbb{Z}_{\leq 0}} R_t(x), \quad l_t := \inf_{x \in \mathbb{Z}_{\geq 0}} L_t(x). \quad (6.22)$$

Then r_t is the same as $r_{0,t}(0)$ in (6.3) when all sites in $\mathbb{Z}_{\leq 0}$ are infected, and analogously for l_t . Furthermore, $R_t(0), L_t(0)$ are equal to r_t, l_t while $C_t(0) \neq \emptyset$: this can be seen by using the graphical representation (see e.g. Liggett [12] Chapter VI, Theorem 2.2). Therefore

$$F_0 = \inf\{t \geq 0: r_t < W_t \text{ or } l_t > W_t\}. \quad (6.23)$$

Let $m := \frac{1}{2}(\iota(\lambda_-) + |v_0| \vee |v_1|)$. Take homogeneous random walks X^i jumping at rates α_i, β_i , $i \in \{0, 1\}$, independent of ξ and coupled to W in such a way that $X_t^0 \leq W_t \leq X_t^1$ for all $t \geq 0$. Set

$$\begin{aligned} D_{1a} &:= \sup\{t \geq 0: l_t^{\lambda_-} \geq -mt \text{ or } r_t^{\lambda_-} \leq mt\}, \\ D_{1b} &:= \sup\{t \geq 0: |X_t^0| \vee |X_t^1| > mt\}. \end{aligned} \quad (6.24)$$

Then D_{1a} depends only on system λ_- and has exponential moments by known large deviation bounds for r_t (see Liggett [12] Chapter VI, Corollary 3.22), while D_{1b} is independent of ξ and has exponential moments by standard large deviation bounds for

X^0 and X^1 . Noting that r_t and l_t are monotone, we can take $D_1 := D_{1a} \vee D_{1b}$, which does not depend on the initial configuration.

Set $\delta := \frac{1}{2}(\iota(\lambda_-) - m)$, $x_0 := Y_{0,D_1}^{\lambda_+}(0) - [(\iota(\lambda_+) + \delta)D_1]$ and note, using the graphical representation, that $\Delta_0 := x_0 - Z_\delta^{\lambda_-}(x_0)$ is independent of x_0 , where $Z_\delta(x)$ is as in (4.5). Then

$$D_0 := \frac{\Delta_0 + |x_0| + 1}{\iota(\lambda_-) - \delta - m} = 4 \frac{\Delta_0 + |x_0| + 1}{\iota(\lambda_-) - |v_0| \vee |v_1|} \quad (6.25)$$

depends only on λ_- , λ_+ and has exponential moments under \mathbb{P} by Lemma 4.3. It is easy to check that D_0 is the intersection time of the line of inclination $\iota(\lambda_-) - \delta$ passing through $(Z_\delta^{\lambda_-}(x_0) - 1, 0)$ and the line of inclination m passing through the origin. Since the system λ has more infections than the system λ_- and $D_0 \geq D_1$, we have $T_0 \mathbb{1}_{\{T_0 < \infty\}} \leq D_0$, which proves (a). For (b), we can bound $V_0(0)$ analogously, taking $x_0 = 0$ instead. \blacksquare

Infections at trial times. We next show that at trial times there are more infections to the left of the random walk than under $\bar{\nu}_\lambda$.

Lemma 6.6. *For all $n \in \mathbb{N}$, on the event $\{\mathcal{T}_n < \infty\}$ the law of $\xi_{\mathcal{T}_n}(\cdot + W_{\mathcal{T}_n})$ under $\mathbb{P}_{\nu_\lambda}(\cdot \mid \mathcal{T}_{[1,n]}, W_{[0,\mathcal{T}_n]})$ a.s. is stochastically larger than $\bar{\nu}_\lambda$.*

Proof. Suppose that $n \geq 2$ (the case $n = 1$ is simpler). Using the definition of \mathcal{T}_n , we can show by induction that, if $\mathcal{T}_n < \infty$, then there exist infection paths connecting $(W_{\mathcal{T}_n}, \mathcal{T}_n)$ to $\mathbb{Z}_{\leq -1} \times \{0\}$ and never touching the paths $Y^{\mathcal{T}_k}(W_{\mathcal{T}_k})$, $k = 1, \dots, n-1$, or the region to the right of W . Take π to be the right-most of these infection paths. Then π is a random infection path with properties (p1) and (p2), and

$$(\mathcal{T}_{[1,n]}, W_{[0,\mathcal{T}_n]}) \in \mathcal{R}_{\mathcal{T}_n}^\pi \vee \sigma(N_{[0,\mathcal{T}_n]}, U_{[1,N_{\mathcal{T}_n}]}) \quad (6.26)$$

Therefore the result follows from Lemma 4.1. \blacksquare

Conclusion. We are now ready to prove Proposition 6.2.

Proof. Let

$$\kappa := \mathbb{P}_{\mathbb{1}_0}(\Gamma_0). \quad (6.27)$$

By Lemma 6.4, $\mathbb{P}_{\nu_\lambda}(\Gamma) = \kappa \rho_\lambda \geq \kappa \rho_{\lambda_-}$ by monotonicity (recall the definition of ρ_λ from Section 1.2). Also, there exists a $\kappa_- > 0$ such that $\kappa \geq \kappa_-$ for any $\lambda \geq \lambda_-$: we can take κ_- to be the probability that X^0 and X^1 in the proof of Lemma 6.5 never cross $L(0)$ or $R(0)$ in system λ_- . Therefore it is enough to prove the claim for \mathbb{P}_{ν_λ} . Since $|W_t|$ is dominated by N_t , which is a Poisson process independent of ξ , we only need to worry about τ .

For $\epsilon > 0$ such that $(1 + \epsilon)(1 - \kappa_-) < 1$, take $a > 0$ as in Lemma 6.5. On the event $\{\mathcal{T}_n < \infty\}$, let $\hat{\xi}_n := \xi_{\mathcal{T}_n}(\cdot + W_{\mathcal{T}_n})$ and note that, given $\mathcal{G}_{\mathcal{T}_n}$, $\mathcal{T}_{n+1} - \mathcal{T}_n$ is distributed as

T_0 under $\mathbb{P}_{\hat{\xi}_n}$. By Lemma 6.6, the law of $\hat{\xi}_n$ under $\mathbb{P}_{\nu_\lambda}(\cdot | \mathcal{T}_{[1,n]}, W_{[0,\mathcal{T}_n]})$ is stochastically larger than $\bar{\nu}_\lambda$, and we get from Lemma 6.5 that

$$\begin{aligned} & \mathbb{E}_{\nu_\lambda} \left[\mathbb{1}_{\{\mathcal{T}_{n+1} < \infty\}} e^{a(\mathcal{T}_{n+1} - \mathcal{T}_n)} \mid \mathcal{T}_{[1,n]}, W_{[0,\mathcal{T}_n]} \right] \\ &= \mathbb{E}_{\nu_\lambda} \left[\mathbb{E}_{\hat{\xi}_n} \left[\mathbb{1}_{\{T_0 < \infty\}} e^{aT_0} \right] \mid \mathcal{T}_{[1,n]}, W_{[0,\mathcal{T}_n]} \right] \leq 1 + \epsilon. \end{aligned} \quad (6.28)$$

Using this bound, estimate

$$\begin{aligned} \mathbb{E}_{\nu_\lambda} \left[\mathbb{1}_{\{\mathcal{T}_{n+1} < \infty\}} e^{a\mathcal{T}_{n+1}} \right] &= \mathbb{E}_{\nu_\lambda} \left[\mathbb{1}_{\{\mathcal{T}_n < \infty\}} e^{a\mathcal{T}_n} \mathbb{E}_{\nu_\lambda} \left[\mathbb{1}_{\{\mathcal{T}_{n+1} < \infty\}} e^{a(\mathcal{T}_{n+1} - \mathcal{T}_n)} \mid \mathcal{T}_n \right] \right] \\ &\leq (1 + \epsilon) \mathbb{E}_{\nu_\lambda} \left[\mathbb{1}_{\{\mathcal{T}_n < \infty\}} e^{a\mathcal{T}_n} \right], \end{aligned} \quad (6.29)$$

so that, by induction,

$$\mathbb{E}_{\nu_\lambda} \left[\mathbb{1}_{\{\mathcal{T}_n < \infty\}} e^{a\mathcal{T}_n} \right] \leq (1 + \epsilon)^n. \quad (6.30)$$

Using Lemma 6.4, write, for $n \in \mathbb{N}$,

$$\mathbb{P}_{\nu_\lambda} (K \geq n + 1) = \mathbb{P}_{\nu_\lambda} (\mathcal{T}_n < \infty, F_{\mathcal{T}_n} < \infty) = (1 - \kappa) \mathbb{P}_{\nu_\lambda} (K \geq n) \quad (6.31)$$

to note that K has distribution $\text{GEO}(\kappa)$. To conclude, use (6.30)–(6.31) to write

$$\begin{aligned} \mathbb{E}_{\nu_\lambda} \left[e^{\frac{a}{2}\tau} \right] &= \sum_{n \in \mathbb{N}} \mathbb{E}_{\nu_\lambda} \left[\mathbb{1}_{\{K=n\}} e^{\frac{a}{2}\mathcal{T}_n} \right] = \sum_{n \in \mathbb{N}} \mathbb{E}_{\nu_\lambda} \left[\mathbb{1}_{\{K=n\}} \mathbb{1}_{\{\mathcal{T}_n < \infty\}} e^{\frac{a}{2}\mathcal{T}_n} \right] \\ &\leq \sum_{n \in \mathbb{N}} \mathbb{P}_{\nu_\lambda} (K = n)^{\frac{1}{2}} \mathbb{E}_{\nu_\lambda} \left[\mathbb{1}_{\{\mathcal{T}_n < \infty\}} e^{a\mathcal{T}_n} \right]^{\frac{1}{2}} \\ &\leq (1 - \kappa_-)^{-\frac{1}{2}} \sum_{n \in \mathbb{N}} \left(\sqrt{(1 - \kappa_-)(1 + \epsilon)} \right)^n < \infty, \end{aligned} \quad (6.32)$$

where in the second line we use the Cauchy-Schwarz inequality. \blacksquare

6.4 Continuity of the speed and the volatility

Given $\lambda_- \leq \lambda_+$ in (λ_W, ∞) and $(\lambda_n)_{n \in \mathbb{N}}$, $\lambda_* \in [\lambda_-, \lambda_+]$ such that either $\lambda_n \uparrow \lambda_*$ or $\lambda_n \downarrow \lambda_*$ as $n \rightarrow \infty$, we can simultaneously construct systems with infection rates $(\lambda_n)_{n \in \mathbb{N}}$, λ_* and λ_\pm , starting from equilibrium, with a single graphical representation in the standard fashion, taking a monotone sequence of Poisson processes for infection events and coupling the initial configurations monotonically. For $n \in \mathbb{N} \cup \{*, +, -\}$, denote by $\Lambda^n := (\xi_0^n, H, I^n, N, U)$ the system with infection rate λ_n , and by \mathbb{P} their joint law. In the following, we will use a superscript n to indicate functionals of Λ^n .

In view of (6.13) and Proposition 6.2, in order to prove convergence of $v(\lambda_n)$ and $\sigma(\lambda_n)$ it is enough to prove convergence in distribution of Γ^n and of $(W_{\tau^n}^n, \tau^n) \mathbb{1}_{\Gamma^n}$. The main step to achieve this will be to approximate relevant random variables with uniformly large probability by random variables depending on bounded regions of the graphical representation.

Note that, by monotonicity and continuity of $\lambda \mapsto \rho_\lambda$ (see Liggett [12] Chapter VI, Theorem 1.6),

$$\lim_{n \rightarrow \infty} \xi_0^n(x) = \xi_0^*(x) \quad \forall x \in \mathbb{Z} \quad \mathbb{P}\text{-a.s.} \quad (6.33)$$

Recall the definitions of F_0 , \mathcal{T}_k and K in (6.5), (6.8)–(6.9) and (6.10), respectively. For $n \in \mathbb{N} \cup \{*\}$ and $k \in \mathbb{N}$, let

$$\Gamma_k^n := \left\{ \xi_0^n(0) = 1, W_s^n \in [L_s^n(0), R_s^n(0)] \forall s \in [0, \mathcal{T}_k^n] \cap \mathbb{R} \right\}, \quad (6.34)$$

so that $\Gamma^n = \Gamma_k^n$ on $\{K^n = k\}$ as in (6.20).

Proposition 6.7. *For every $k \in \mathbb{N}$, $(W_{\mathcal{T}_k^n}^n, \mathcal{T}_k^n, \mathbb{1}_{\Gamma_k^n}) \mathbb{1}_{\{\mathcal{T}_k^n < \infty\}}$, $\mathbb{1}_{\{\mathcal{T}_k^n < \infty\}}$ and $\mathbb{1}_{\{F_0^n < \infty\}}$ converge in probability as $n \rightarrow \infty$ to the corresponding functionals of Λ^* .*

Proof. We first show that, for every fixed $T \in (0, \infty)$,

$$(W_{\mathcal{T}_k^n}^n, \mathcal{T}_k^n, \mathbb{1}_{\Gamma_k^n}) \mathbb{1}_{\{\mathcal{T}_k^n \leq T\}}, \quad \mathbb{1}_{\{\mathcal{T}_k^n \leq T\}}, \quad \mathbb{1}_{\{F_0^n \leq T\}}, \quad (6.35)$$

converge a.s. as $n \rightarrow \infty$ to the corresponding functionals of Λ^* . To that end, let $\bar{Y}_{t,s}(x)$ be the increasing analogue of $Y_{t,s}(x)$ in (6.6), starting from x but jumping across the arrows of I to the right. Let $\bar{Z}_\delta(x)$, analogously to $Z_\delta(x)$ in (4.5), be the first infected site to the right of x whose infection spreads inside a wedge between lines of inclination $-(\iota + \delta)$ and $-(\iota - \delta)$. Take $\delta := \iota(\lambda_-)/2$, set $\underline{y} := Y_{0,T}^+(-N_T)$ and $\underline{z} := Z_\delta^-(\underline{y} - [(\iota(\lambda_-) + \delta)T])$. Analogously, put $\bar{y} := \bar{Y}_{0,T}^+(N_T)$ and $\bar{z} := \bar{Z}_\delta^-(\bar{y} + [(\iota(\lambda_-) + \delta)T])$.

Now observe that, for any $n \in \mathbb{N} \cup \{*\}$, all random variables in (6.35) depend on Λ^n only in the space-time box $\mathcal{B} := [\underline{z}, \bar{z}] \times [0, T]$. Indeed, for any $0 \leq t \leq s \leq T$, we have $L_{t,s}^n(W_t^n) \geq Y_{t,s}^n(W_t^n) \geq y^-$ and $R_{t,s}^n(W_t^n) \leq y^+$, so that $\{F_t^n \leq s\}$ depends on Λ^n only inside $[\underline{y}, \bar{y}] \times [0, T]$. Also, there are infection paths from time 0 to time T inside $[\underline{z}, \underline{y}]$ and $[\bar{y}, \bar{z}]$. Therefore the states of ξ^n inside $[\underline{y}, \bar{y}] \times [0, T]$ depend on Λ^n only in \mathcal{B} (see the proof of Lemma 2.2). The same is true for $\{\mathcal{T}_t^n \leq s\}$, since any infection path needed to discover T_t^n can be taken inside \mathcal{B} . Therefore, by (6.33) (and since the graphical representation is a.s. eventually constant inside bounded space-time regions), the claim after (6.35) follows.

To conclude note that, because $\mathcal{T}_k \mathbb{1}_{\{\mathcal{T}_k < \infty\}} \leq \tau$ and $F_0 \mathbb{1}_{\{F_0 < \infty\}} \leq T_0 \mathbb{1}_{\{T_0 < \infty\}}$,

$$\lim_{T \rightarrow \infty} \sup_{n \in \mathbb{N} \cup \{*\}} \mathbb{P}(T < \mathcal{T}_k^n < \infty \text{ or } T < F_0^n < \infty) = 0 \quad (6.36)$$

by Proposition 6.2 and Lemma 6.5, which implies that, for large T , the random variables in the statement are equal to the ones in (6.35) with uniformly large probability. \blacksquare

Corollary 6.8. *Let κ^n be as in (6.27). Then $\lim_{n \rightarrow \infty} \kappa^n = \kappa^*$ and K^n converges in distribution to K^* .*

Proof. This follows directly from Proposition 6.7 and the definition of κ since, by (6.31), K^n is a geometric random variable with parameter κ^n . \blacksquare

With these results we can conclude the proof of Theorem 1.2(c).

Proof. Let f be a bounded measurable function. For $k \in \mathbb{N}$, write

$$\begin{aligned}
\mathbb{E} [f(W_{\tau^n}^n, \tau^n) \mathbb{1}_{\Gamma^n} \mathbb{1}_{\{K^n=k\}}] &= \mathbb{E} \left[f(W_{\mathcal{T}_k^n}^n, \mathcal{T}_k^n) \mathbb{1}_{\Gamma_k^n} \mathbb{1}_{\{\mathcal{T}_k^n < \infty, F_{\mathcal{T}_k^n} = \infty\}} \right] \\
&= \kappa^n \mathbb{E} \left[f(W_{\mathcal{T}_k^n}^n, \mathcal{T}_k^n) \mathbb{1}_{\Gamma_k^n} \mathbb{1}_{\{\mathcal{T}_k^n < \infty\}} \right] \\
&\xrightarrow{n \rightarrow \infty} \kappa^* \mathbb{E} \left[f(W_{\mathcal{T}_k^*}^*, \mathcal{T}_k^*) \mathbb{1}_{\Gamma_k^*} \mathbb{1}_{\{\mathcal{T}_k^* < \infty\}} \right] \\
&= \mathbb{E} [f(W_{\tau^*}^*, \tau^*) \mathbb{1}_{\Gamma^*} \mathbb{1}_{\{K^*=k\}}],
\end{aligned} \tag{6.37}$$

where for the second and the third equality we use Lemma 6.4 and the strong Markov property, and for the convergence we use Proposition 6.7 and Corollary 6.8. Therefore

$$\begin{aligned}
&|\mathbb{E} [f(W_{\tau^n}^n, \tau^n) \mathbb{1}_{\Gamma^n}] - \mathbb{E} [f(W_{\tau^*}^*, \tau^*) \mathbb{1}_{\Gamma^*}]| \\
&\leq \|f\|_{\infty} \{ \mathbb{P}(K^n > M) + \mathbb{P}(K^* > M) \} \\
&\quad + \sum_{k=1}^M \left| \mathbb{E} [f(W_{\tau^n}^n, \tau^n) \mathbb{1}_{\Gamma^n} \mathbb{1}_{\{K^n=k\}}] - \mathbb{E} [f(W_{\tau^*}^*, \tau^*) \mathbb{1}_{\Gamma^*} \mathbb{1}_{\{K^*=k\}}] \right|,
\end{aligned} \tag{6.38}$$

and we conclude by taking $n \rightarrow \infty$, using Corollary 6.8 and (6.37), and taking $M \rightarrow \infty$. \blacksquare

References

- [1] L. Avena, *Random Walks in Dynamic Random Environments*, PhD-thesis, Leiden University, 26 October 2010.
- [2] L. Avena, Symmetric exclusion as a model of non-elliptic dynamical random conductances, *Electron. Commun. Probab.* 17 (2012).
- [3] L. Avena, F. den Hollander and F. Redig, Large deviation principle for one-dimensional random walk in dynamic random environment: attractive spin-flips and simple symmetric exclusion, *Markov Proc. Relat. Fields* 16 (2010) 139–168.
- [4] L. Avena, F. den Hollander and F. Redig, Law of large numbers for a class of random walks in dynamic random environments, *Elect. J. Probab.* 16 (2011) 587–617.
- [5] L. Avena, R. dos Santos and F. Völlering, Transient random walk in symmetric exclusion: limit theorems and an Einstein relation, arXiv:1102.1075 [math.PR].
- [6] J. van den Berg, O. Häggström and J. Kahn, Some conditional correlation inequalities for percolation and related processes, *Random Structures & Algorithms* 29 (2006) 417–435.
- [7] C. Bezuidenhout and G. Grimmett, Exponential decay for subcritical contact and percolation processes, *Ann. Probab.* 19 (1991) 984–1009.

- [8] M. Birkner, J. Černý, A. Depperschmidt and N. Gantert, Directed random walk on an oriented percolation cluster, arXiv:1204.2951 [math.PR].
- [9] R. Durrett and R.H. Schonmann, Large deviations for the contact process and two-dimensional percolation, *Probab. Theory Relat. Fields* 77 (1988) 583–603.
- [10] P. Glynn and W. Whitt, Large deviations behavior of counting processes and their inverses, *Queueing Systems: Theor. Appl.* 17 (1994) 107–128.
- [11] F. den Hollander, H. Kesten and V. Sidoravicius, Random walk in a high density dynamic random environment, preprint 2010.
- [12] T.M. Liggett, *Interacting Particle Systems*, Grundlehren der Mathematischen Wissenschaften 276, Springer, New York, 1985.
- [13] T.M. Liggett, An improved subadditive ergodic theorem, *Ann. Probab.* 13 (1985) 1279–1285.
- [14] T.M. Liggett, *Stochastic Interacting Systems: Contact, Voter and Exclusion Processes*, Grundlehren der Mathematischen Wissenschaften 324, Springer, Berlin, 1999.
- [15] T.M. Liggett and J. Steif, Stochastic domination: the contact process, Ising models and FKG measures, *Ann. Inst. H. Poincaré: Probab. Statist.* 42 (2006) 223–243.
- [16] A.-S. Sznitman, Lectures on random motions in random media, in: *Ten Lectures on Random Media*, DMV-Lectures 32, Birkhäuser, Basel, 2002, pp. 1851–1869.
- [17] O. Zeitouni, Random walks in random environment, in: *XXXI Summer School in Probability, Saint-Flour, 2001*, Lecture Notes in Math. 1837, Springer, 2004, pp. 193–312.