

Prediction of inorganic superconductors with quasi-one-dimensional crystal structure

L M Volkova and D V Marinin

Institute of Chemistry, Far Eastern Branch of the Russian Academy of Sciences
690022 Vladivostok, Russia

E-mail: volkova@ich.dvo.ru

Abstract

Models of superconductors having a quasi-one-dimensional crystal structure based on the convoluted into tube Ginsburg sandwich, which comprises a layered dielectric – metal – dielectric structure, have been suggested. The critical crystal chemistry parameters of the Ginsburg sandwich determining the possibility of emergence of superconductivity and the T_c value in layered high- T_c cuprates, which could have the same functions in quasi-one-dimensional fragments (sandwich-type tubes), have been examined. The crystal structures of known low-temperature superconductors, in which one can mark out similar quasi-one-dimensional fragments, have been analyzed. Five compounds with quasi-one-dimensional structures, which can be considered as potential parents of new superconductor families, possibly, with high transition temperatures, were suggested. The methods of doping and modification of these compounds were provided.

1. Introduction

For the first time the notion on the possibility of emergence of high-temperature superconductivity (HTSC) in quasi-one-dimensional systems was put forward by Little in 1964 [1]. His model system comprises a molecule consisting of two parts: first, a long chain called the ‘spine’, in which electrons fill the various states and may or may not form a conducting system, and, second, a series of arms or side chains attached to the spine. However, up to recently, the model has not yet been realized. The same year Ginsburg suggested a quasi-two-dimensional system – metal film with dielectric layers from both sides (sandwich – layered structure: dielectric – metal – dielectric ($I/S/T$)) – as high-temperature superconductor [2]. Thereafter Katz demonstrated [3] that layered chemical compounds with dramatically different conductivities of adjacent layers can be considered as stacks made of the above sandwiches. Although one have not yet managed

to create such superconducting systems artificially; however, in these very two-dimensional systems (complex copper oxides) high-temperature superconductivity was discovered for the first time by Bednorz and Müller [4]. According to Ginsburg [5], these two model systems are based on the common notion consisting in a spatial separation of the conductivity (superconductivity) region and the dielectric region responsible for the electron polarization.

However, the earlier performed studies [6-9] of correlations between T_c and crystal chemistry parameters ratios in superconducting fragments (sandwiches of different families of superconducting cuprates) demonstrated that the maximum value of T_c , which can be attained on the basis of the CuO_2 plane, would not exceed ~160 K independently of the number of such planes in a superconductor. So we came to the idea of creating models of superconductors with a

quasi-one-dimensional crystal based on the Ginsburg sandwich that could have higher T_c .

In the present work we will outline crystal chemistry parameters of the Ginsburg sandwich determining the possibility of emergence of superconductivity and T_c in layered high- T_c cuprates, which could have the same functions in quasi-one-dimensional fragments – tubes of sandwich type. Taking into account all these parameters, we will suggest models of superconductors with a quasi-one-dimensional structure based on the Ginsburg sandwich convoluted into a tube. We will demonstrate that in crystal structures of some well-known low-temperature superconductors one can mark out similar quasi-one-dimensional fragments of the sandwich type. Then we will identify in the Inorganic Crystal Structure Database (ICSD) (version 1.8.2, FIZ Karlsruhe, Germany, 2012-1) and present 5 compounds with a quasi-one-dimensional structure – potential parents of new families of superconductor having, possibly, high transition temperatures.

2. Prediction crystal chemistry criteria

To predict new superconductors, it is important to know the role of crystal chemistry factors in creating conditions for the emergence of high temperatures of transition into the superconducting state (T_c). The earlier performed studies [6-9] of high-temperature superconducting cuprates attaining, for the moment, the highest transition temperatures T_c , enabled us to reveal these factors. Let us explain it in more detail. In cuprates with several CuO_2 layers the perovskite-like layer $\text{A}_{n+1}(\text{CuO}_2)_n$ is divided, in accordance with the number of CuO_2 planes (n), to n elementary fragments – A_2CuO_2 sandwiches (Fig. 1). Even at equal $d(\text{Cu-Cu})$ distances they can differ in the concentration of charge carriers (number of holes (p) in CuO_2 layers as calculated per one copper atom), the distances between the CuO_2 plane and those of A-cations, and element composition of A-cations planes. The main difference of the structure of cuprate HTSC from that of perovskite type of other elements consists in the fact that CuO_2 planes emerge between positively charged planes of A-cations as a result of moving off (or absence) of apical oxygen atoms from the CuO_2 plane by larger distances than A-cations planes due to strong Jahn-Teller effect.

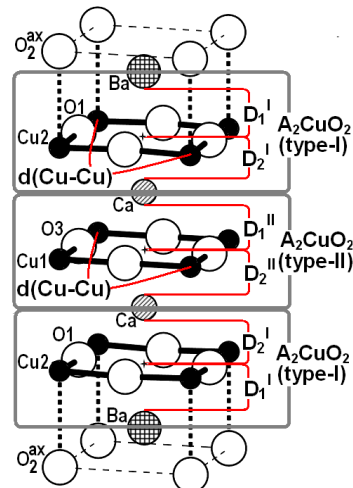

Figure 1. Perovskite-type layer $\text{A}_{n+1}(\text{CuO}_2)_n$ ($n = 3$) in the crystal structure of $\text{HgBa}_2\text{Ca}_2\text{Cu}_3\text{O}_8$. The superconducting fragments – sandwiches are highlighted.

We revealed [6-9] a general empirical correlation $T_c(J)$ between T_c and the ratio of crystal chemistry parameters in superconducting fragments (sandwiches) for different families of superconducting cuprates with several CuO_2 planes ($n = 2 - 4$) and any cation composition and doping degree. The $T_c(J)$ curve (Fig. 2 c) was built without using any normalizing coefficients for 132 compounds (among them, with the number of CuO_2 planes: $n = 2 - 94$, $n = 3-4 - 38$). In graphic terms, the $T_c(J)$ correlation is close to parabola; however, the best approximation (97%) of this correlation is provided by a third-degree polynomial equation. The transition temperature T_c correlates with the value of the ratio ($J = d(\text{Cu-Cu})/(\text{D}_1+\text{D}_2)$) of the distance $d(\text{Cu-Cu})$ between copper atoms along the diagonal direction of the CuO_2 plane to the sum of effective distances (D_1+D_2) from the CuO_2 plane to the surface of two adjacent layers of A cations in the sandwich A_2CuO_2 calculated with taking into account the charge and size of A cation and doping atoms. One should mention that the A cations radii were taken from [10] with the coordination number 8.

In the $T_c(J)$ correlation the number of holes is taken into account indirectly through the value of the distance $d(\text{Cu-Cu})$, to which it is virtually inverse proportional, since the oxygen atoms are located immediately in the copper atoms plane or slightly deviate from it. According to the estimation of the value of charges of copper (q) on the bond valence sum (BVS) of copper

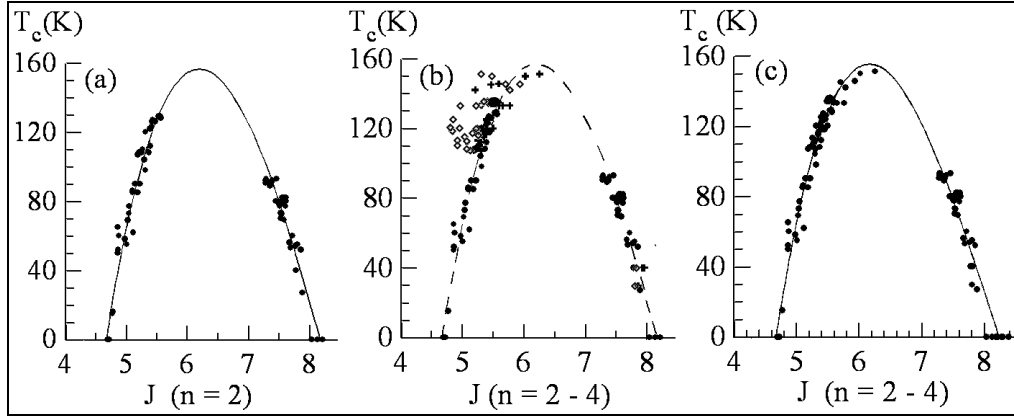

Figure 2. T_c as a function of J in high- T_c cuprates (a) with only one type (external) of fragments A_2CuO_2 , (b) cuprates with two types fragments (external (+) and internal (\diamond)) were added to cuprates with one type of fragments, (c) fragments with higher T_c were selected from cuprates with two types of fragments.

($BVS = \sum_i \exp[(1,679-R_i)/0,37]$ [11], where R_i – the Cu-O distance), the copper atoms charge and, therefore, the number of holes ($p = q-2$) in external CuO_2 planes is higher (by the fraction contributed from the apical oxygen atom) than that in internal planes. However, our attempts to build a universal (general) correlation for all HTSC families with taking into account the increase of the number of holes in external CuO_2 planes was not successful. So one can conclude that T_c depends on the number of holes emerging due to contributions from oxygen atoms located exclusively in the CuO_2 plane.

According to $T_c(J)$ correlation, the transition temperature T_c does not depend on the number of CuO_2 planes in a superconductor that contradicts the generally accepted opinion. At $n > 2$ the crystal chemistry parameters of sandwiches formed by external (type I) and internal (type II) CuO_2 planes are not equivalent that yields different values of J and, therefore, T_c (Fig. 2b). The transition temperature T_c of the compound having several sandwiches is the individual T_c of one of them, namely, the sandwich, whose parameters ($d(Cu-Cu)$ distances and sum of effective D_1 and D_2 distances) are close to optimal ones and T_c is higher. Figure 2a shows the dependence of $T_c(J)$ built for cuprates ($n = 2$) having identical sandwiches of type I, in Fig. 2b they are complemented with cuprates ($n > 2$) with different types (I and II) of sandwiches, whereas in Fig. 2c, in the presence of two sandwich types, those having the J ratio corresponding to higher T_c are selected. One should emphasize

that in most (28 from 38) of the examined compounds with several types of sandwiches A_2CuO_2 the compound T_c is determined by the sandwich formed by the external CuO_2 plane. For example, in the superconductor $HgBa_2Ca_2Cu_3O_{8+d}$ [12] at low pressure down to 0,59 GPa ($T_{c,exp} = 135-136K$) the compound T_c , according to the curve $T_c(J)$, is that of sandwiches of type I ($T_{c,calculat.}^I = 128-133K$, $J^I = 5,49 - 5,56$), whereas the transition temperature of the sandwich of type II is noticeably lower ($T_{c,calculat.}^{II} = 120-125 K$, $J^{II} = 5,40 - 5,46$). Along with the pressure increase up to 4 GPa ($T_{c,exp} = 142 K$), the compound T_c is determined by the sandwich of type II ($T_{c,calculat.}^{II} = 147 K$, $J^{II} = 5,78$), whereas the transition temperature of fragments of type I is significantly lower ($T_{c,calculat.}^I = 96 K$, $J^I = 5,20$). Further pressure increase up to 9,2 GPa ($T_{c,exp} = 151.1 K$) returns the leading position to the sandwiches of type I ($T_{c,calculat.}^I = 154 K$, $J^I = 6,25$) and decreases dramatically the transition temperature of the sandwich of type II ($T_{c,calculat.}^{II} = 107 K$, $J^{II} = 5,30$).

The role of parameters D_1 and D_2 characterizing the distances between the internal CuO_2 plane and the surface of layers of A ions, the degree of heterogeneity A ions plane surfaces, and the field created by charges of A and doping ions in the sandwich A_2CuO_2 in superconductivity emergence and T_c changes is very significant. There exists a nearly parabolic dependence (polynomial approximation 81%, $T_c(D_2)$) (Fig. 3a) of T_c on the effective distance D_2 between the CuO_2 plane and the layer of A

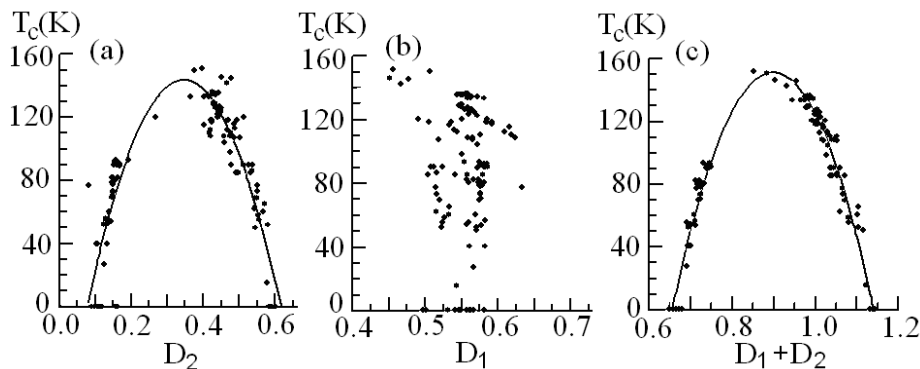

Figure 3. T_c as a function of (a) D_2 , (b) D_1 and (c) $D_1 + D_2$ in high- T_c HTSC cuprates formed by some CuO_2 planes ($n = 2-4$).

cations that does not contain oxygen atoms in superconducting cuprates with the number of layers $n > 1$. At the same time, the external (type I) sandwich A_2CuO_2 does not have a correlation between T_c and the effective distance D_1 from the CuO_2 plane to the external plane of A cations (Fig. 3b), which could be related to the decrease of the effective positive charge of the external plane of cations due to its proximity to O_{ax} atoms and, as a result, the decrease of the focusing effect on carriers. The correlation between T_c and the sum of D_1 and D_2 is even closer to parabolic (approximation $T_c(D_1 + D_2)$ to polynomial 95%) (Fig. 3c), of one takes 124 sandwiches of type I and 8 sandwiches of type II manifesting the highest T_c in accordance with the $T_c(J)$ correlation in the compounds under study.

According to the $T_c(J)$ correlation, the maximal T_c , which can be attained in high-temperature superconducting cuprates, is as low as 155 K ($J = 6,15$), of one uses the structural data of all 132 compounds under examination. The transition temperature of 162 K ($J = 6.15$, $T_c = 12.1113J^3 - 286.406J^2 + 2149.29J - 5041$), close to the highest one of 164 K [13] attained in Hg 1223 (phase under pressure), is obtained upon using the structural data of 50 compounds investigated with the highest accuracy by means of X-ray and neutron single crystal diffraction methods. As follows from the revealed $T_c(J)$ correlation, it is not possible to significantly increase T_c in superconductors based on the CuO_2 copper-oxygen plane. However, it is possible to attain this temperature in cuprates without pressure application, if one creates a sandwich with the ratio value $J = 6,15$. In this case, according to $T_c(J)$ correlations (Fig. 2c), $T_c(D_2)$

and $T_c(D_1 + D_2)$ (Fig. 3a and c), the structural parameters of the sandwich Ca_2CuO_2 must be as follows: the distances between copper atoms along the diagonal direction of the CuO_2 plane $d(\text{Cu-Cu}) = 5.326 \text{ \AA}$; the sum of effective distances from the CuO_2 plane to the surfaces of two adjacent layers of Ca cations $D_1 + D_2 = 0.866 \text{ \AA}$, where $D_1 = D_2$; the parameter of the copper square lattice $a = 3.766 \text{ \AA}$; the distance $d(\text{Cu-O}) = 1.883 \text{ \AA}$; the distance between the CuO_2 and Ca planes 1.553 \AA ; the number of holes $p = 0.305$. For the sandwich Mg_2CuO_2 , the parameters are the same, except for the distance between the CuO_2 and Mg planes that must be decreased down to 1.323 \AA .

We established similar correlations between T_c and the crystal chemistry parameters ratio in other layered superconductors (diborides AB_2 and nickel borocarbides $\text{RNi}_2\text{B}_2\text{C}$) as well [14, 15].

Thus, we demonstrated that the critical crystal chemistry parameters of the 'Ginsburg sandwich' determining the possibility of emergence of superconductivity and the T_c value in these materials included: concentration of charge carriers, distances between atoms-charge carriers in the metal layer, parameters of the cross-section size of the space between the metal layer and dielectric layers from both sides, and charge and degree of heterogeneity of dielectric layers. The presence of defects in metal layers, overlapping of the transfer space by covalent bond electrons, and different signs of carriers and dielectric layers charges could yield the decrease of T_c until the superconductivity suppression. One of the reasons of high T_c in superconducting cuprates consists in moving off of binding electrons between copper ions and axial oxygen ones from

the CuO_2 plane due to the Jahn-Teller effect. The above criteria can be applied to develop models and search for superconductors with quasi-one-dimensional structure, whose temperature of superconducting transition could be higher than in two-dimensional cuprates.

3. Crystal chemistry prediction of superconductors with quasi-one-dimensional crystal structure

Since the Little assumption on the possibility of existence of HTSC in quasi-one-dimensional systems comprising long conducting molecules with side ‘branches’ has not yet been corroborated, we have decided on using, for the sake of prediction, a quasi-two-dimensional Ginsburg system with taking into account the found crystal chemistry parameters controlling T_c of high-temperature superconducting cuprates. It is possible to transform the Ginsburg sandwich, consisting of dielectric – metal – dielectric layers, into a quasi-one-dimensional system by convoluting it into a tube. In this way, one would avoid the formation of alternative bonds ...M-M...M-M... in the Little model ‘spine’ that hampers the emergence of superconductivity with high T_c .

We believe that on the above basis one can build quasi-one-dimensional systems of three types. They must contain the following fragments: (1) conducting tubes with dielectric outside and inside them; (2) conducting tubes with dielectric between them; (3) stacks (tubes) of metal rings (clusters) with dielectric inside and outside them; (4) stacks (tubes) of metal rings (clusters) with dielectric between them. For the superconductivity emergence, these systems must have the required concentration and mobility of charge carriers, space (channels) for charge carriers flow, compression of the carriers flow and its focusing in the direction of spreading by the dielectric shell. The known low-temperature superconductors with a quasi-one-dimensional structure can serve as parents of such compounds.

3.1. Known inorganic superconductors with quasi-one-dimensional crystal structure

Let us consider the crystal structures of known superconductors and mark out their different quasi-one-dimensional fragments that could be responsible for superconductivity emergence.

3.1.1. MRuX. Superconducting transition temperatures of the compounds MRuX with the hexagonal Fe_2P -type structure are considerably high, about 13 K for h-ZrRuP and h-HfRuP [16, 17], 12 K for h-ZrRuAs [18, 19]. Usually, the structure of compounds of this type is considered as a layered one consisting of layers alternating along the c axis, occupied by Ru and X or M and X, and separated by a distance of $c/2$. However, Seo et al. [20] and Hase [21], who performed studies of the electron structure of superconducting compounds $h\text{-ZrRuX}$ ($X = \text{P, As, Si}$), relate superconducting properties to one-dimensionality of the electronic properties – partially filled one-dimensional band dispersive along the c direction. Hase demonstrates that the density of states at the Fermi energy is very sensitive to the in-plane Ru-Ru distance. Seo believes that this band is largely associated with the $\text{P}(2)\text{Ru}_3$ prismatic chains along the c axis, whereas the shrinking of Ru-Ru bonds in triangular clusters does not have any role. The absence of the dependence of T_c on just one parameter (Ru-Ru distance in clusters) was also indicated by experimental studies of $h\text{-MRuX}$ [22-24].

We will show quasi-one-dimensional features in the structure of h-MRuX that can be the basis to discuss T_c in these compounds. For instance, let us consider the structure of ZrRuP [16] (Fig. 4a, b). The main fragment of this structure comprises stacks of two-dimensional triangular clusters of Ru_3 along the c axis. These stacks can be also considered as columns of trigonal prisms of Ru_6 centered by P2 atoms. The distances between Ru atoms in this quasi-one-dimensional fragment are the shortest in the structure (2.63 Å in cluster, 3.79 Å between clusters). These fragments are located in hexagonal cavities formed by triangular networks of Zr atoms and hexagonal networks of P1 atoms located in planes $z = 1/2$ and 0, respectively. The lengths of sides in the distorted Zr_6 hexagon and in the larger regular Si_6 hexagon are equal to 3.37 Å and 3.73 Å, respectively.

The characteristic feature of the crystal structure of MRuX compounds (Table 1) consists in the presence of numerous bonds that are shorter than the sum of covalent radii [25], such as: between Ru atoms in triangular Ru_3 clusters (except the compound ScRuSi); between Ru atoms from Ru_3 clusters column and M atoms

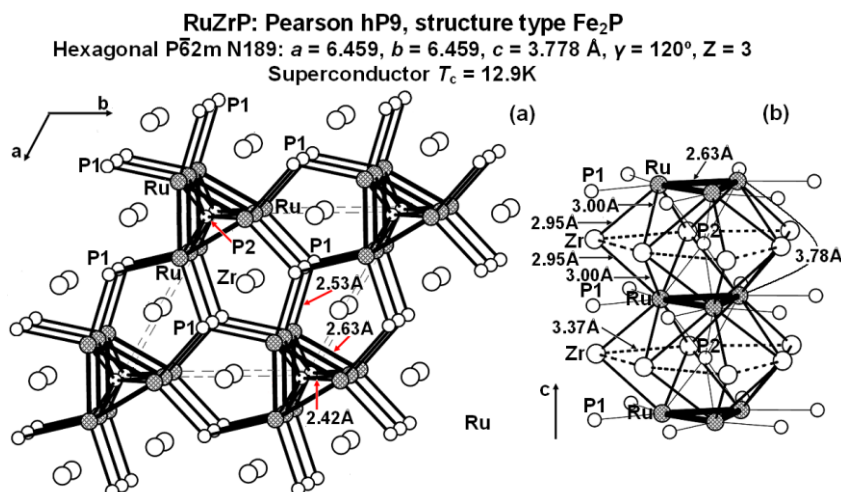

Figure 4. Crystal structure of RuZrP (a) and quasi-one-dimensional fragment – stack of triangular metal clusters of Ru₃ with P2 atoms inside it and Zr and P1 atoms outside it (b).

Table 1. Superconducting transition temperatures (T_c), lattice parameters, interatomic distances Ru-Ru inside Ru₃ triangular clusters and between them; dependence of T_c on the ratio (f_n) of these distances in ternary pnictides MRuX with the hexagonal Fe₂P-type ($P\bar{6}2m$, N189)

Data for ICSD	Compound MRuX	T_c , K	a^a , Å	c^b , Å	$d(\text{Ru-Ru})_{\text{intra}}^c$, Å	$d(\text{Ru-Ru})_{\text{inter-}ab}^d$, Å	f_1	f_2	f_3
-	ZrRuP [16]	13 - 10.56 [16,17]	6.459	3.778	2.629	4.384	1.437	0.222	0.328
53035	HfRuP [26]	12.70 - 11.08 [16]	6.414	3.753	2.700	4.294	1.390	0.217	0.324
611301 ^e	ZrRuAs [26]	11.9 - 10.2 [18,19]	6.586	3.891	2.852	4.356	1.364	0.207	0.313
35593	ZrRuAs [18]		6.586	3.891	2.795	4.394	1.392	0.211	0.317
604605 ^e	HfRuAs [18]	4.93 - 4.37 [18]	6.568	3.842	2.787	4.382	1.378	0.210	0.314
610654 ^e	HfRuAs [26, 27]		6.568	3.842	2.799	4.374	1.372	0.209	0.314
77792	TiRuP [26]	1.33 [16]	6.303	3.567	2.773	4.141	1.286	0.204	0.311
636584 ^e	HfRuGe [28]	not ^f [28]	6.715	3.726	2.908	4.442	1.281	0.190	0.288
600432 ^e	ZrRuSi [29]	12.2 - 7 [23]	6.660	3.655	2.861	4.420	1.278	0.192	0.289
16306	ZrRuSi [30]	not ^f [16]	6.684	3.672	2.871	4.436	1.279	0.191	0.288
638841 ^e	Hf Ru Si [31]	not ^f [31]	6.643	3.646	2.877	4.394	1.267	0.191	0.288
610918 ^e	MnRuAs [32, 33]	not ^f [34]	6.518	3.619	2.879	4.275	1.257	0.193	0.294
650603 ^e	ScRuSi [35]	not ^f [31]	6.851	3.423	2.967	4.530	1.154	0.168	0.255

^a Distances between centers of Ru₃ clusters in the plane ab , equal to parameters a and b .

^b Ru-Ru distances between Ru₃ clusters along c -axis ($d(\text{Ru-Ru})_{\text{inter-}c}$), equal to parameter c .

^c Ru-Ru distances in Ru₃ clusters ($d(\text{Ru-Ru})_{\text{intra}}$).

^d Ru-Ru distances between Ru₃ clusters in the plane ab ($d(\text{Ru-Ru})_{\text{inter-}ab}$).

^e Atom positions and distribution estimated by the editor, not refined.

^f Not superconducting above 1.2 K [1]

forming the cavity, in which this column is located (except the compounds TiRuP, MnRuAs, and ScRuSi); between M atoms in M₆ hexagons of this cavity (except the compounds TiRuP, MnRuAs, and ScRuSi), that indicates to the presence of metal bond. Besides, the Ru₃ clusters

are linked to each other through the Ru-X2 bond along the c axis and Ru-X1 bonds in the basal plane. The bond lengths Ru-X1 and Ru-X2 in the compounds RuX are equal ($d(\text{Ru-P1}) = 2.53$ Å) or less (except $d(\text{Ru-Si1}) = 2.62$ Å in ScRuSi) than the sum of covalent radii by ~ 0.1 Å.

We investigated the dependence of T_c of the compounds h -MRuX on the lengths of each of the above bonds and became convinced of its absence. However, there exists the dependence of T_c on the ratio (f) of two main parameters characterizing quasi-one-dimensional fragments – stacks of two-dimensional triangular clusters of Ru₃: bond lengths in the cluster ($d(\text{Ru-Ru})_{\text{intra}}$) and distances between clusters in stacks ($d(\text{Ru-Ru})_{\text{inter-c}}$) equal to the parameter c (Table 1). This dependence can be written as:

$$f_1 = d(\text{Ru} - \text{Ru})_{\text{inter-c}} / d(\text{Ru} - \text{Ru})_{\text{intra}} \quad (1)$$

One should take into consideration that the structures of the compounds MRuX were not determined accurately, since the coordinates x of M and Ru atoms were evaluated, in most cases, similarly to isotopic compounds and did not undergo refinement. The measurements of T_c and structural parameters must have been performed on different samples, although superconductivity is known to be sensitive to the sample composition. For example, the samples ZrRuSi prepared by the arc-melted method did not manifest superconductivity above 1.2 K [16], whereas in the samples prepared at high temperatures and high pressures superconductivity emerges at around 7-12 K [23]. Here one can assume that we calculated the f values for ZrRuSi (Table 1) from the structural data of samples that are not superconducting. The absence of a noticeable difference between the f values for ZrRuAs (11.7 K) and HfRuAs (4.9 K), whose T_c differ significantly, can be related to inaccuracy in evaluation of the coordinate x Ru in HfRuAs that did not undergo correction.

In general, T_c would depend not only on these two parameters characterizing quasi-one-dimensional fragments, but also on the distances between them (Table 1). In the structure of h -MRuX the distances between stacks can be considered as minimal ones ($d(\text{Ru-Ru})_{\text{inter-ab}}$) between Ru atoms from adjacent stacks or as those between the centers of Ru₃ clusters in the plane ab equal to parameters a and b ($a=b$). These dependencies can be written as:

$$f_2 = \frac{d(\text{Ru} - \text{Ru})_{\text{inter-c}}}{d(\text{Ru} - \text{Ru})_{\text{intra}} d(\text{Ru} - \text{Ru})_{\text{inter-ab}}} \quad (2)$$

and

$$f_3 = c / d(\text{Ru} - \text{Ru})_{\text{intra}} a \quad (3)$$

To sum up, the critical crystal chemistry parameters controlling the T_c value are the size of Ru₃ clusters and the distances between them in stacks and between stacks.

The T_c value is proportional to the distance between Ru₃ clusters in stacks $d(\text{Ru-Ru})_{\text{inter-c}}$ (or parameter c) and inversely proportional to the distances between Ru atoms in clusters $d(\text{Ru-Ru})_{\text{intra}}$ and the distance between stacks $d(\text{Ru-Ru})_{\text{inter-ab}}$ (or parameter a). The presence of such dependence enables one to assume that the emergence of superconductivity in h -MRuX is related not to an individual cluster, but to a quasi-one-dimensional fragment – a stack of Ru₃ clusters along the axis c .

3.1.2. $\text{Tl}_2\text{Mo}_6\text{Se}_6$. In the crystal structure of the superconductor $\text{Tl}_2\text{Mo}_6\text{Se}_6$ [36] (Fig. 5ab), triangular clusters of Mo₃ are about the same size ($d(\text{Mo-Mo}) = 2.652 \text{ \AA}$) as triangular Ru₃ clusters in the structure of h -ZrRuP – they forms stacks along the axis c . However, T_c of $\text{Tl}_2\text{Mo}_6\text{Se}_6$ attains as low as 6.5 K [37]. Unlike the structure of h -ZrRuP, these stacks are so strongly compressed that the distances between Mo₃ clusters in the stack become equal to 2.241 Å. The increase of the internuclear repulsion upon compression forces triangular Mo₃ clusters to rotate relatively to each other by 180° (to get packed antiprismatically) and, as a result, to attain acceptable distances (2.714 Å) between molybdenum atoms from adjacent clusters to preserve the system stability. In the end, quasi-one-dimensional clusters (Mo₃)_∞ from face sharing antiprisms (octahedra) Mo₆ are formed (Fig. 5b). They can be also considered as triangular screw tubes. All Mo-Mo distances in (Mo₃)_∞ clusters are less than the sums of covalent radii of Mo (3.08 Å) that indicates to a strong metal bond. Se atoms remain outside these quasi-one-dimensional metal clusters – (Mo₃)_∞ screw tubes and encapsulate them. They are bonded to Mo atoms by covalent bonds ($d(\text{Mo-Se}) = 2.604$ and 2.614 Å) forming chains of (Mo₃Se₃)_∞ running along the hexagonal c axis separated by the Tl atoms. The Tl atoms bonds with chains are very weak ($d(\text{Tl-Se}) = 3.393 \text{ \AA}$).

In the system $M_2\text{Mo}_6\text{Se}_6$ ($M = \text{Tl, In, Rb, Li, Na, K, Cs}$) [38], only $\text{Tl}_2\text{Mo}_6\text{Se}_6$ and $\text{In}_2\text{Mo}_6\text{Se}_6$ are superconducting, with $T_c=3-6.6$ K (varying between samples) and 2.9 K, respectively [39-41]. These two inorganic compounds with an

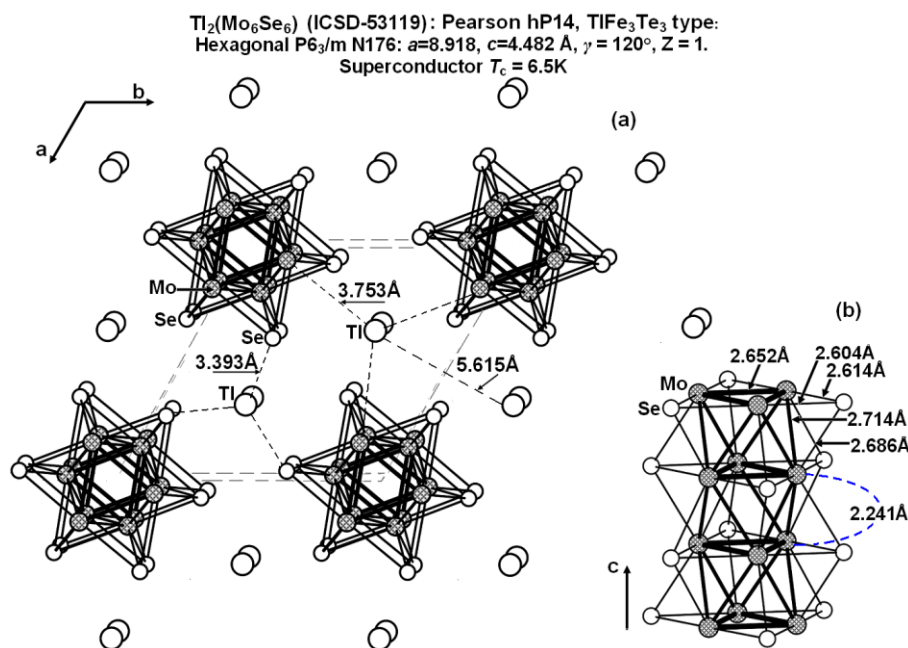

Figure 5. Crystal structure of $\text{Ti}_2\text{Mo}_6\text{Se}_6$ (a) and quasi-one-dimensional fragment – triangular metal screw tubes $(\text{Mo}_3)_\infty$ with Se atoms outside them (b).

expressed quasi-one-dimensional crystal structure are the most strictly anisotropic quasi-one-dimensional superconductors found until recently [42–45].

3.1.3. $\text{Lu}_2\text{Fe}_3\text{Si}_5$. According to [46–48], $\text{Lu}_2\text{Fe}_3\text{Si}_5$ is a weakly one-dimensional superconductor ($T_c = 6.1$ K). The crystal structure of $\text{Lu}_2\text{Fe}_3\text{Si}_5$ [49] (Fig. 6a) contains two types of quasi-one-dimensional fragments along the axis c . The point is which of these fragments could be responsible for the emergence of one-dimensional anisotropy? We tried to answer this question from the crystal chemistry point of view.

In the first fragment (Fig. 6b), the squares from Fe1 atoms are packed into stacks along the axis c at distances of 5.388 Å. Large-sized and rotated in the plane squares from Lu atoms are located in the middle between Fe1_4 squares. The distances between atoms in Fe1_4 ($d(\text{Fe1-Fe1}) = 2.756$ Å) and Lu_4 ($d(\text{Lu-Lu}) = 3.620$ Å) squares and between these squares ($d(\text{Fe1-Lu}) = 3.040$ Å) are less by 0.28 Å, 0.12 Å, and 0.15 Å, respectively, than the sum of the elements covalent radii ($R_{\text{Fe}} = 1.52$ Å, $R_{\text{Lu}} = 1.87$ Å [25]), which indicates to the presence of metal bond. As a result, the stack of Fe1_4 and Lu_4 squares alternating along the axis c can be considered as a corrugated metal tube. Inside this tube, chains of

Si3 atoms are located at alternating along the axis c distances ($d(\text{Si3-Si3}) = 2.68$ and 2.71 Å) that are much larger than the sum of covalent radii ($R_{\text{Si}} = 1.11$ Å [25]). The Si3 atoms have covalent bonds with Fe1 atoms ($d(\text{Si3-Fe1}) = 2.37$ Å) and Lu atoms ($d(\text{Si3-Lu}) = 2.90$ Å). The silicon atoms Si1 ($d(\text{Si1-Fe1}) = 2.37$ –2.38 Å and $d(\text{Si1-Lu}) = 2.73$ –2.86 Å) and Si2 ($d(\text{Si2-Fe1}) = 2.36$ Å and $d(\text{Si2-Lu}) = 3.00$ –3.03 Å) covalently bonded to Fe and Lu atoms are located outside the tube as well.

Up to present, the role of Fe and Lu atoms in the emergence of superconductivity has remained partially unclear [50–54]. If just 3d-electrons of Fe are responsible for superconductivity, this superconducting fragment must be considered as a stack of metal clusters Fe1_4 with chains of Si3 atoms inside it and Lu, Si1, and Si2 atoms outside it. The reason of low temperature of transition (T_c) into $\text{Lu}_2\text{Fe}_3\text{Si}_5$ could consist in overlapping the space of carrier transfer inside the Fe1_4 clusters stack by electrons of the covalent bond Fe1-Si3 and the outside space by electrons of metal bonds Fe1-Lu and covalent bonds Fe1-Si1 and Fe1-Si2

The second one-dimensional fragment (Fig. 6c) in $\text{Lu}_2\text{Fe}_3\text{Si}_5$ comprises a chain of Fe_2Si_4 tetrahedra bonded through common edges. The Fe2 atoms in these fragments form linear metal

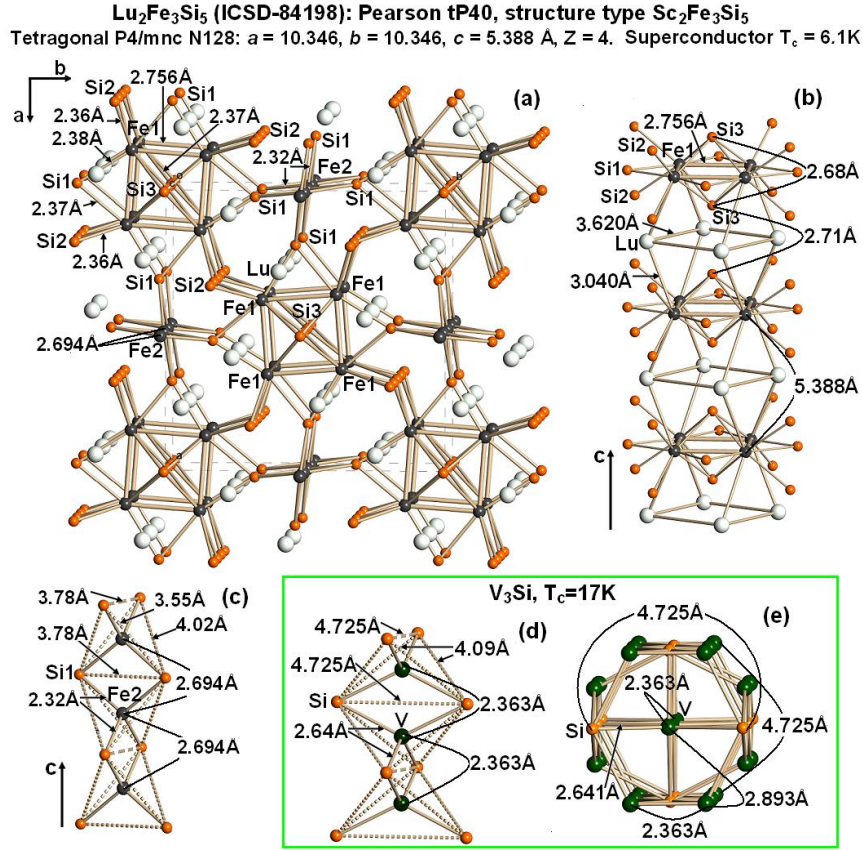

Figure 6. Crystal structure of Lu₂Fe₃Si₅ (a) and quasi-one-dimensional fragments: (b) stack of metal clusters Fe₁₄ with Si₃ atoms chains inside it and Lu, Si₁, and Si₂ atoms outside it, (c) chain of FeSi₄ tetrahedra linked through common edges. Chains of VSi₄ tetrahedra linked through common edges (d) and channels with linear chains -V-V-V- (e) in the structure of V₃Si.

Table 2. T_c values and geometrical parameters of chains formed from tetrahedra linked through common edges in A_3X superconductors (Cr₃Si type (A-15), cP8, cubic $Pm\bar{3}n$) and in Lu₂Fe₃Si₅.

ICSD	A_3X	T_c , K [67]	$d(X-X)^a$, Å	$d(X-X) - 2R_X^b$, Å	$d(A-A)^c$, Å	$2R_A^b - d(A-A)^c$, Å
76584	Nb ₃ Si [55]	19.0	5.155	2.935	2.578	0.702
637221	Nb ₃ Ge [56]	23.2	5.144	2.744	2.572	0.708
634745	Nb ₃ Ga [57]	20.7	5.176	2.736	2.588	0.692
645502	Nb ₃ Sn [58]	17.9	5.2887	2.509	2.644	0.636
652500	V ₃ Si [59]	17.0	4.725	2.505	2.363	0.697
106076	Ta ₃ Sn [60]	8.4	5.276	2.496	2.638	0.642
645347	Nb ₃ Sb [61]	2.0	5.262	2.482	2.631	0.649
51996	Nb ₃ In [62]	9.2	5.293	2.453	2.647	0.633
105188	Nb ₃ Pb [63]	8.0	5.319	2.399	2.659	0.621
603983	V ₃ Ge [64]	6.2	4.781	2.381	2.391	0.669
58817	Nb ₃ Bi [65]	3.1	5.320	2.360	2.660	0.620
106097	V ₃ Sn [66]	3.8	4.975	2.195	2.488	0.572
84198	Lu ₂ Fe ₃ Si ₅ [49]	-	3.780	1.560	2.694	0.346

^a $d(X-X)$ – length of common edges of tetrahedral in the chain ($d(X-X) = a$ in structures of Cr₃Si)

^b Covalent radii [25]: $R_{Si} = 1.11$, $R_{Ge} = 1.20$, $R_{Ga} = 1.22$, $R_{Sn} = 1.39$, $R_{Sb} = 1.39$, $R_{In} = 1.42$, $R_{Pb} = 1.48$, $R_{Bi} = 1.48$, $R_{Fe} = 1.52$, $R_V = 1.53$, $R_{Nb} = 1.64$ and $R_{Ta} = 1.70$ Å.

^c $d(A-A)$ – distance between metal atoms in the chain ($d(A-A) = a/2$ in structures of Cr₃Si type).

chains along the axis c , where the distances between iron atoms ($d(\text{Fe2-Fe2}) = 2.694$) are less (by 0.35 \AA) than the sum of covalent radii. Similar fragments built of AX_4 tetrahedra bonded through common edges exist in the structure of compounds A_3X with the structure A-15 (Fig. 6d), in which well-known superconductors V_3Si and Nb_3Sn , as well as Nb_3Ge having the maximal T_c (23.2 K) for this type of compounds, crystallize. We decided to compare geometrical parameters of these one-dimensional fragments in order to understand whether the second fragment could be responsible for the emergence of a weakly one-dimensional superconductivity in $\text{Lu}_2\text{Fe}_3\text{Si}_5$. To solve this problem, it was necessary to find the correlation between T_c and geometrical parameters of one-dimensional fragments in A_3X superconductors.

The characteristic feature of the structure A-15 consists in the fact that the transition atoms (A-atoms) form families of noncrossing linear chains that are stretched in three perpendicular directions and located in channels (Fig. 6e). The distances between A atoms in a single chain are significantly less than A-A distances to adjacent chains forming the channel walls. ‘Free space’ around linear metal chains emerged in A-15 superconductors as a result of a strong compression of AX_4 tetrahedra along one of twofold rotation axes. Such a compression yields: (1) decrease of the distances between A atoms in the chain and respective increase of the metal bond strength; (2) increase of the lengths of common edges of X-X tetrahedra and, as a result, channel widening; (3) increases of A-X distances and weakening of covalent bonding and concentration of electron density of binding electrons near the A atoms chain. As a result of studies of 12 A_3X superconductors (A = V, Nb and Ta; X = Si, Ge, Sn, Pb, Ga, In, Sb, and Bi) (Table 2), we revealed that T_c increases along with the increase of the difference between the length of the tetrahedra common edge $d(\text{X-X})$ and the sum of covalent radii of X. Just two compounds (Nb_3Si and Nb_3Sb) manifest a significant deviation from the $T_c(d(\text{X-X}) - 2R_X)$ correlation, according to which the transition temperature T_c must be significantly higher than 23 K and 8 K, respectively. Predictions of high T_c (in the range 25-38 K) of the stoichiometric compound Nb_3Si were made on the basis of different arguments in other works as well [67-69]. Aside from this dependence, for each

individual family of Nb_3X and V_3X one observes the dependence of T_c on distances between A atoms in the chain. The temperature T_c increases along with the decrease of the A-A distance. Thus, we established that T_c of A_3X superconductors correlates to the cross-section size of the channel, in which the A atoms chain is located, and the distances between atoms in this chain, i.e., the strength of metal bond in it. As was shown above, the possibility of emergence of superconductivity and the T_c value in layered materials are determined by the following critical parameters: concentration of charge carriers, distances between charge carrier atoms in metal layer, and parameters of the cross-section size of the space between metal layer and dielectric layers from both sides.

The critical parameters of chains from tetrahedra bonded with common edges differ substantially in $\text{Lu}_2\text{Fe}_3\text{Si}_5$ and V_3Si ($T_c = 17 \text{ K}$) (Fig. 6e, Table 2), in spite of almost identical covalent radii of Fe ($R_{\text{Fe}} = 1.52 \text{ \AA}$) and V ($R_{\text{V}} = 1.53 \text{ \AA}$) metals. In $\text{Lu}_2\text{Fe}_3\text{Si}_5$ the distances between iron atoms in the chain are larger by 0.33 \AA , whereas the length of tetrahedra common edges is, in opposite, smaller by 0.95 \AA than in V_3Si . For the emergence of superconductivity based on the above chains in $\text{Lu}_2\text{Fe}_3\text{Si}_5$, at least with $T_c \sim 3 \text{ K}$, the chains must be compressed until the state when the distance between iron atoms decreases down to 2.45 \AA , whereas the length of common edges increases up to 4.42 \AA .

So it can be concluded that the second fragment cannot be superconducting, whereas the emergence of a weak one-dimensional superconductivity in $\text{Lu}_2\text{Fe}_3\text{Si}_5$ must be related to the first quasi-one-dimensional fragment comprising a stack of metal clusters Fe_{14} with Si_3 atoms chains inside it and Lu, Si1, and Si2 atoms outside it.

3.1.4. $\text{Sc}_3\text{Rh}_4\text{Si}_{10}$. According to [71-74], ternary silicides and germanides $\text{R}_5\text{T}_4\text{X}_{10}$ with the structure of $\text{Sc}_5\text{Co}_4\text{Si}_{10}$, where $R = \text{Sc}$, Y, and rare-earth elements, $T = \text{Co}$, Rh, Ir, or Os, and $X = \text{Si}$, Ge [75-77], are quasi-one-dimensional superconductors. Among $\text{R}_5\text{T}_4\text{X}_{10}$ compounds, $\text{Sc}_5\text{Rh}_4\text{Si}_{10}$ (Fig. 7), $\text{Sc}_5\text{Ir}_4\text{Si}_{10}$, and $\text{Y}_5\text{Os}_4\text{Ge}_{10}$ manifest superconductivity with the highest T_c of 8.4, 8.6, and 9.10 K, respectively [78]. To explain one-dimensional anisotropy in the superconducting properties, one marks out in the crystal structure of these compounds different

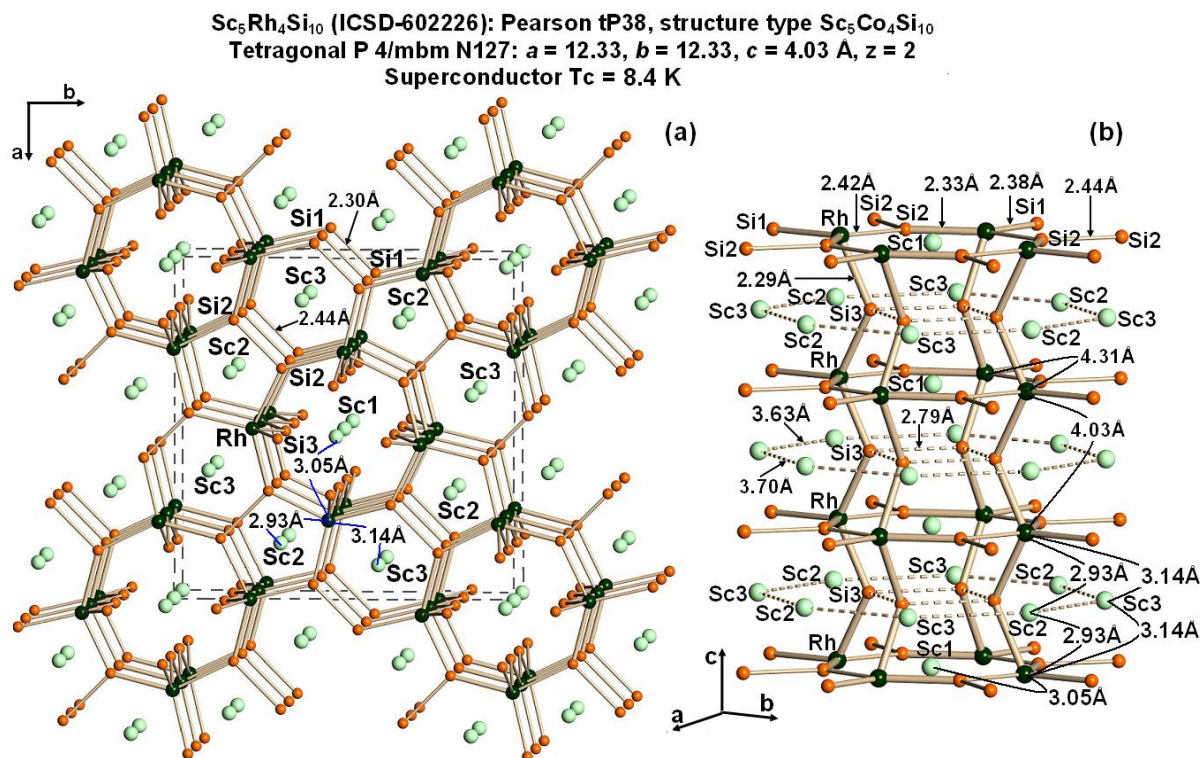

Figure 7. Crystal structure of Sc₅Rh₄Si₁₀ (a) and quasi-one-dimensional fragment – corrugated octagonal tube from covalently bonded Rh and Si atoms with Sc atoms inside and outside it (b).

one-dimensional fragments along the axis c , for example, zigzag chain T - X - T atoms or chains of $R1$ linked by short bonds with $X3$ atoms. Sometimes one marks out more complex formations, for example, in the form of 1D chains of $R1$ atoms (bonded to T and $X3$ atoms), which are embedded in a network of closely bonded $R2$ and $R3$ atoms [79]. However, the chains of $R1$ atoms along the axis c have only an indirect relation to the one-dimensional character of this structure due to the following reasons: i) strength of the covalent bond between $R1$ and $X3$ atoms in this chain is not very high; ii) metal bond between $R1$ and T is realized only in the plain ab and is not strong as well; iii) there is no metal bond between $R1$ atoms along the axis c and between $R2$ and $R3$ atoms.

In structural terms, in these silicides one can mark out another quasi-one-dimensional fragment along the axis c based on transition d -elements. Let us demonstrate this on the example of the compound Sc₅Rh₄Si₁₀ (Fig. 7a). The main structural unit of this compound is a square pyramid RhSi₅, in which the bonds Rh-Si (2.29-2.42 Å) are covalent. The length of these bonds is

far smaller than the sum of covalent radii (2.53 Å). RhSi₅ pyramids are linked by four units through four Si2 atoms located in the pyramids bases and form octagonal rings Rh₄Si₄ in the plane ab . The lengths of Rh-Si2 bonds in the ring equal to 2.33 and 2.42 Å are in alternating order. In their turn, these four-pyramid units are linked to each other by Si3 atoms ($d(\text{Rh-Si3}) = 2.29$ Å), also located in the pyramid bases, into corrugated tubes (Fig. 7b) stretched along the axis c .

The Sc1 atoms are located inside these tubes in the centers of Rh₄Si₄ rings. They are coupled by metal bonds with four Rh atoms from the Rh₄Si₄ ring and by covalent bonds with eight Si3 atoms. The metal bond Sc1-Rh (3.045 Å) is not strong since its length is just a bit smaller than the sum of covalent radii (3.12 Å) of these atoms. The length of the bond of Sc1 atom with Si3 atoms ($d(\text{Sc1-Si3}) = 2.82$ Å) linking them into a chain along the axis c slightly exceeds the sum of covalent radii (2.81 Å) of these atoms. There is no metal bond between Sc1 atoms along the axis c , since the distances Sc1-Sc1 (4.030 Å) exceed substantially (by 0.63 Å) the sum of Sc covalent radii (3.40 Å).

The vertices of square pyramids (Si1 atoms) are directed outside from tubes and link them to each other. Extra bonds between tubes emerge due to approaching of Si1 ($d(\text{Si1-Si1}) = 2.30 \text{ \AA}$) and Si2 ($d(\text{Si2-Si2}) = 2.44 \text{ \AA}$) atoms of adjacent tubes at distances slightly exceeding the sum of covalent radii of Si (2.22 \AA). As a result, there emerge pentagonal and hexagonal channels from Rh and Si atoms filled by Sc2 and Sc3 atoms, respectively. The Sc2 and Sc3 atoms form flat octagonal rings of larger size ($d(\text{Sc2-Sc3}) = 3.632 \text{ \AA}$ and 3.697 \AA) than that of Rh_4Si_4 , between which the former are located. There is no metal bond between Sc2 and Sc3 atoms in these rings, but it is present with Rh atoms ($d(\text{Sc2-Rh}) = 2.927 \text{ \AA}$, $d(\text{Sc3-Rh}) = 3.045 \text{ \AA}$) from Rh_4Si_4 rings.

To sum up, the corrugated octagonal tubes built from covalently bonded Rh and Si atoms, inside and outside which Sc atoms are located (Fig. 7b), can be responsible for the emergence of quasi-one-dimensional superconductivity in $\text{Sc}_5\text{Rh}_4\text{Si}_{10}$. The fact that the distances between Sc atoms and Rh atoms from tubes are smaller (by

0.19 and 0.08 \AA) than the sum of covalent radii is similar to the superconducting sandwich in $\text{YBa}_2\text{Cu}_3\text{O}_7$ [80], where the distances ($d(\text{Cu2-Y}) = 3.206 \text{ \AA}$) between Y atoms and Cu atoms from the CuO_2 layer are smaller (by 0.014 \AA) than the sum of covalent radii of Y and Cu (3.22 \AA). The quasi-one-dimensional fragment in $\text{Sc}_5\text{Rh}_4\text{Si}_{10}$ we marked out has some similarities with the first fragment in $\text{Lu}_2\text{Fe}_3\text{Si}_5$ (Fig. 7b), but it has no metal bonds between atoms of d -element (Rh).

3.1.5. $\text{Yb}_7\text{Co}_4\text{InGe}_{12}$. In quaternary compounds $\text{R}_7\text{Co}_4\text{InGe}_{12}$ ($\text{R} = \text{Dy}, \text{Ho}, \text{Yb}$) [81] (Fig. 8) quasi-one-dimensional fragments in the form of corrugated octagonal tubes from cobalt and germanium atoms, inside and outside which R atoms are located, are similar to the fragments in structures of the $\text{Sc}_5\text{Co}_4\text{Si}_{10}$ type. However, these compounds are not superconductors. If one substitutes Yb by Y and Co by Os in the compound $\text{Yb}_7\text{Co}_4\text{InGe}_{12}$, it is possible that the compound $\text{Y}_7\text{Os}_4\text{InGe}_{12}$ would become a superconductor, just like $\text{Y}_5\text{Os}_4\text{Ge}_{10}$.

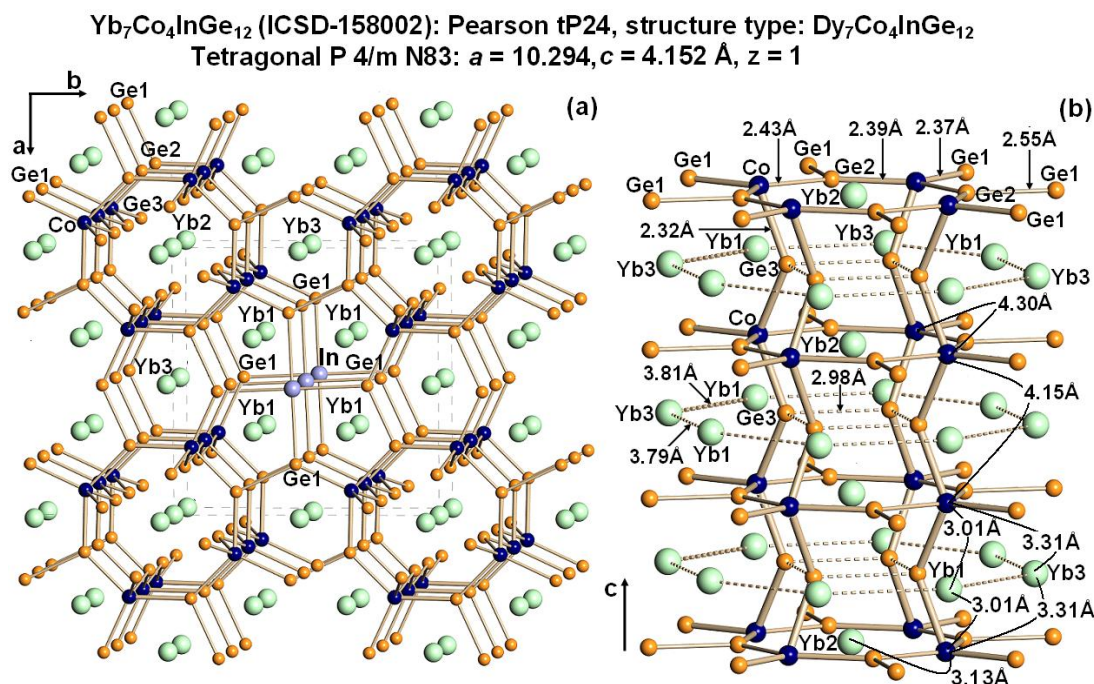

Figure 8. Crystal structure of $\text{Yb}_7\text{Co}_4\text{InGe}_{12}$ (a) and quasi-one-dimensional fragment – corrugated octagonal tube from cobalt and germanium atoms with Yb atoms inside and outside it Yb (b).

3.2. Models of superconductors with quasi-one-dimensional crystal structure

In the inorganic crystal structure database (ICSD) we identified 5 compounds ($\text{La}_4\text{BaCu}_4\text{FeO}_{12.96}$ (ICSD-96335), $\text{Ba}_9\text{Cu}_7\text{O}_{15}\text{Cl}_2$ (ICSD-9628), KCuO (ICSD-40158), LaGaBi_2 (ICSD-165559) and $\text{NaBa}_6\text{Cu}_3\text{Te}_{14}$ (ICSD-82671)), whose structures generally comply with the crystal chemistry parameters we revealed, at which the emergence of superconductivity with high temperatures of superconducting transition is possible. These compounds can be parents of new families of inorganic superconductors with quasi-one-dimensional crystal structure, if one performs respective substitutions and doping with holes.

3.2.1. Oxygen-deficient perovskites $\text{La}_4\text{BaCu}_5\text{O}_{13}$ and $\text{La}_4\text{BaCu}_4\text{FeO}_{12.96}$. Since the discovery of copper oxide superconductors [82], dozens of works devoted to findings of superconductivity at a temperature 165K and higher, up to 300 K, in new layered copper oxide systems with structures of the perovskite type have been reported. As a rule, the reports contained the information that not the whole sample, but just its small part manifests superconducting properties at such high temperature. However, in all cases these results were not reproducible and, most probably, inaccurate. In view of this, we posed the question whether this superconducting part could be a copper oxide system with the quasi-one-dimensional structure. We have analyzed the

crystal structures of copper oxide systems available in the ICSD database and found the compound $\text{La}_4\text{BaCu}_4\text{FeO}_{12.96}$ [83], which is suitable, according to our criteria, to be the model of superconductors with a quasi-one-dimensional structure after appropriate substitutions. Interestingly, this compound belongs to the very system of oxygen-deficient perovskites $\text{La}_4\text{BaCu}_5\text{O}_{13+\delta}$ [84], whose study with respect to metal conductivity led Bednorz and Müller to search of high-temperature superconductivity in Ba-La-Cu oxides [85].

$\text{La}_4\text{BaCu}_4\text{FeO}_{12.96}$ has been reported by Anderson et al. [83] to crystallize in a tetragonal structure with $P4/m$ space group ($a = 8.638$, $c = 3.904$ Å, $z = 1$). According to the conventional description of the crystal structure of perovskite $\text{La}_4\text{BaCu}_5\text{O}_{13+\delta}$ [83, 84, 86], the structure of $\text{La}_4\text{BaCu}_4\text{FeO}_{12.96}$ (Fig. 9a) has groups of four corner-sharing CuO_5 pyramids linked through FeO_6 octahedra. Each octahedron shares four corners with four pyramids and two corners with two other octahedra; each pyramid is linked to four other pyramids and one octahedron. The framework exhibits one perovskite-like tunnel and two hexagonal tunnels per cell. Ba^{2+} and La^{3+} are ordered, with 12-coordinate Ba^{2+} in perovskite tunnels and 10-coordinate La^{3+} in hexagonal tunnels. $\text{La}_4\text{BaCu}_4\text{FeO}_{12.96}$ is an example of a successful occupation of the octahedral site in the $\text{La}_4\text{BaCu}_5\text{O}_{13+\delta}$ phase by $\text{Fe}(a)$ ions, and on its basis it is easier to observe

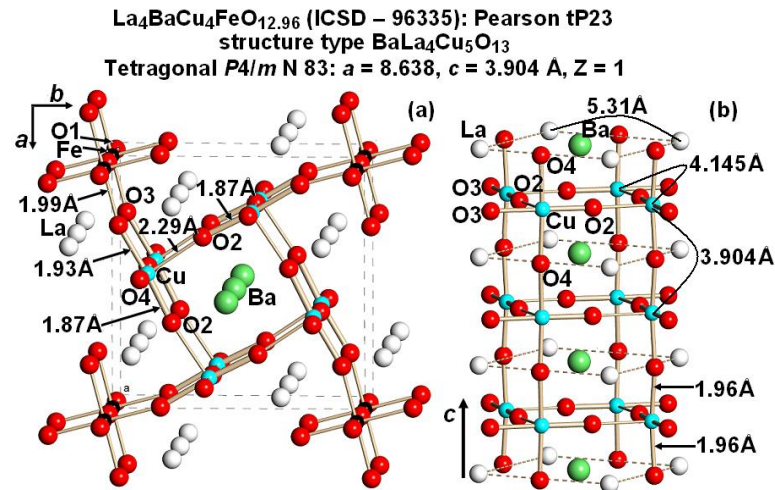

Figure 9. Crystal structure of $\text{La}_4\text{BaCu}_4\text{FeO}_{12.96}$ (a) and quasi-one-dimensional fragment – tetragonal copper-oxygen tube with Ba ions inside it and La ions outside it (b). Axial and basal Cu-O bonds of CuO_5 pyramids alternate along square sides in the plane ab .

quasi-one-dimensional features of the structural type $\text{La}_4\text{BaCu}_5\text{O}_{13}$ and represent the structure of these compounds in a different way by stressing their inherent quasi-one-dimensional anisotropy.

The main difference of a structure of the type $\text{La}_4\text{BaCu}_5\text{O}_{13}$ from that of layered high- T_c cuprates consists in the fact that the former perovskite structure is divided in the plane ab into individual perovskite-type units shaped into columns along the axis c rather than perovskite-type layers perpendicular to the same axis c . From this point of view, the structure of $\text{La}_4\text{BaCu}_4\text{FeO}_{12.96}$ consists of two types of one-dimensional fragments stretched along the axis c : tetragonal copper-oxygen tubes (Fig. 9a, b) built from networks of distorted copper-oxygen squares and linear chains of top-linked FeO_6 octahedra. Tubes and chains are linked to each other through common oxygen atoms O3. Ba ions are located inside the tubes, whereas La ions are located outside them in the formed cavities. In tubes the Cu-O2 bond lengths in the plane ab are unequal (1.87 and 2.29 Å) and alternate along the square sides, whereas along the axis c the Cu-O3 bonds lengths are identical and equal to 1.96 Å. The latter is concerned with the fact that square pyramids CuO_5 having a characteristic Jahn–Teller distortion are linked in the plane ab by four alternately through O2 oxygen atoms located in the pyramids vertices and bases and along the axis c just by oxygen atoms located in pyramids bases. Anisotropy of the crystal structure of compounds of this type corresponds to that of electrical transport property in $\text{La}_4\text{BaCu}_5\text{O}_{13}$ [87]: in the a - b plane, it is semiconducting, while along the c -direction, it is metallic.

$\text{La}_4\text{BaCu}_5\text{O}_{13+\delta}$ and $\text{La}_4\text{BaCu}_4\text{FeO}_{12.96}$ are known to be nonsuperconducting [83, 88]. We believe that attaining the optimal concentration of charge carriers in copper-oxygen tubes could yield the emergence of the superconducting state. Variation of the charge carriers concentration through compression or stretching of Cu-O bonds can be realized by heterovalent and isovalent substitution of Cu1(Fe), La, and Ba ions occupying the 1(a), 4(k), and 1(d) positions, respectively. The problem of substitutions consists in preserving the superconducting fragment comprising quasi-one-dimensional copper-oxygen tubes with positively charged ions inside and outside them and preventing the increase of the oxygen content above 13 leaving the following positions occupied by oxygen

atoms: O1 – 1(b), O2 – 4(j), O3 – 4(j), and O4 – 4(k). Deficit of the oxygen atoms O1 (position 1(b)) binding (Cu1(Fe)) octahedra into a chain would enable one to additionally adjust the carriers concentration and would not cause the destruction of this structural type. Otszchi et al. [89] managed to obtain the compound $(\text{La}_{0.8333}\text{Sr}_{0.1666})_5\text{Cu}_5\text{O}_{13}$, whose structure was similar to $\text{La}_4\text{BaCu}_5\text{O}_{13}$, but lanthanum and strontium in the structure were statistically distributed, in contrast to $\text{La}_4\text{BaCu}_5\text{O}_{13+\delta}$, where lanthanum and barium were located in an ordered manner. Comparison of the Cu2-O bond lengths in copper-oxygen tubes of the compounds $\text{La}_4\text{BaCu}_4\text{FeO}_{12.96}$ and $(\text{La}_{0.8333}\text{Sr}_{0.1666})_5\text{Cu}_5\text{O}_{13}$ demonstrates the expected results. Substitution of a large barium ion located inside the tube by a mixture of smaller La and Sr ions resulted in shortening of Cu2-O2 bonds in the plane ab by 0.02 – 0.04 Å Cu2-O4 bonds along the axis c by 0.04 Å. Substitution of a part of La ions located outside the tube by larger Sr ions increased the length of the bonds of the tube with the octahedra chain (Cu2-O3) by 0.075 Å.

Aside from variation of the carriers' concentration, we suggest an attempt to slightly modify the structural type $\text{La}_4\text{BaCu}_5\text{O}_{13}$. The purpose of this modification consists in strengthening of one-dimensional anisotropy – 'isolation' of copper-oxygen tubes and achievement of similarity of the structure of copper-oxygen tubes with CuO_2 layers. For this purpose, it is necessary just to rotate the pyramids Cu_2O_5 in the tube with apical vertices looking outside and significantly increase the distance to these vertices (Fig. 10a). Then the copper-oxygen tube (Fig. 10b), just like the CuO_2 layer in high- T_c cuprates, will be formed from vertex-linked bases of CuO_5 pyramids, whose apical vertices would be directed outside, and the Cu-O bonds in the tube will be much shorter than the bonds to apical vertices. In fact, one needs to strongly compress the tube by substituting large Ba ions located inside it by small ones (Ca, Mg, Y, La), whereas small La ions located inside, in opposite, must be substituted by larger ions (Ba or Sr). Here both positions must contain, along with two-valent ions, three-valent ones (La, Y, or Tl) to preserve the charge compensation. Copper ions in Cu_2O_6 octahedra can be left or substituted by Hg^{2+} , Tl^{3+} , or $\text{Pb}^{2+,4+}$. All the above substitutions were successfully performed in high- T_c cuprates [see, for example, 90-92]. The composition of these

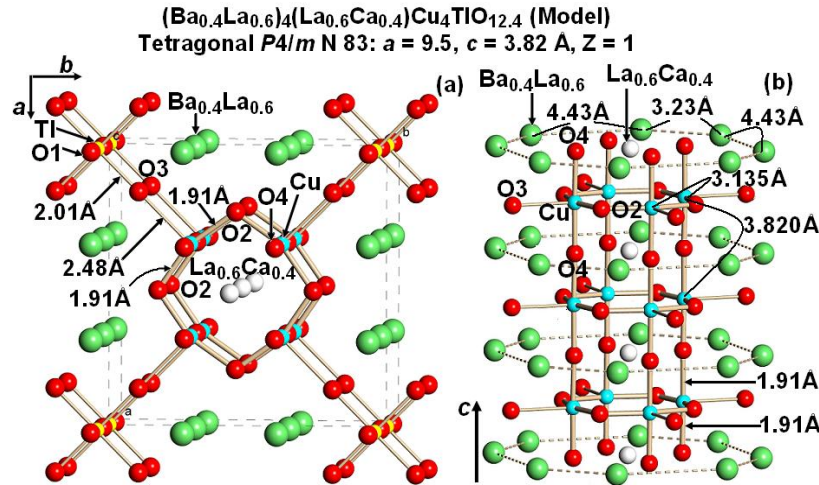

Figure 10. Modification of the structural type La₄BaCu₅O₁₃: crystal structure (Ba_{0.4}La_{0.6})₄(La_{0.6}Ca_{0.4})Cu₄TiO_{12.4} (model) (a) and quasi-one-dimensional fragment – copper-oxygen from CuO₅ pyramids, whose axial vertices are directed outside the tube (b). Small cations (La_{0.6}Ca_{0.4}) are located inside the tube, large cations (Ba_{0.4}La_{0.6}) are located outside the tube.

hypothetical superconductors can be as follows: (Ba_{0.4}A_{0.6})₄(A_{0.6}Ca_{0.4})Cu₄BO_{13-δ} (where A = Ti³⁺, La, Y; B = Ti³⁺, Cu, (Hg_{1-x}Tl_x), (Hg_{1-x}Cu_x)) and (Sr_{0.4}Y_{0.6})₄(Y_{0.6}Ca_{0.4})Cu₄BO_{13-δ} (where B = Cu, (Tl_{1-x}Pb_x)). We represented their structure in the tetragonal space group P4/mmm. For the (Ba_{0.4}La_{0.6})₄(La_{0.6}Ca_{0.4})Cu₄TiO_{12.4} structure (Fig. 10) the lattice parameters are $a = 9.5$, $c = 3.82$ Å, $z = 1$ with atomic positions of (Ba_{0.4}La_{0.6}) at $4m$ (0.33, 0, 1/2), (La_{0.6}Ca_{0.4}) at $1d$ (1/2, 1/2, 1/2), Cu at $4j$ (0.335, 0.335, 0), Ti at $1a$ (0, 0, 0), O1 at $1b$ (0, 0, 1/2), O2 at $4n$ (0.22, 1/2, 0), O3 at $4j$ (0.15, 0.15, 0) and O4 at $4k$ (0.337, 0.337, 1/2). One should mention that there exist oxygen vacancies in the position O1 (position occupancy $q = 0.4$). The Cu-O distances in the CuO₅ pyramid are equal to 2.485 Å, 1.911 Å, and 1.910 Å to apical vertex (O3), two basal vertices (O2) in the plane ab , and two basal vertices (O4) along the axis c , respectively. The number of charge carriers per copper atom is equal to 0.25 according to evaluation made from the copper bond valence sum (BVS) [11].

Thus, oxygen-deficient perovskites of the structural type La₄BaCu₅O₁₃ contain quasi-one-dimensional fragments – conducting copper-oxygen tubes with dielectric (positively charged ions) inside and outside them. In essence, these fragments are similar to the Ginsburg sandwich (*ISI*). Besides, one should emphasize similarity of the structures of these fragments to those in low-temperature superconductor Sc₅Rh₄Si₁₀ (see

above) comprising rhodium-silicon tubes with Sc atoms located inside and outside them. We assume that these compounds could be the candidates yielding superconductors upon respective substitutions or structural modifications

3.2.2. Ba₉Cu₇O₁₅Cl₂. Among oxocuprates and halocuprates, the structure of Ba₉Cu₇O₁₅Cl₂ is a unique one. Ba₉Cu₇O₁₅Cl₂ [93, 94] (Fig. 11a) crystallizes in hexagonal space group $P6/mmm$ ($a = 11.257$ and $c = 5.853$ Å, $Z = 1$). Copper ions occupy two crystallographically independent sites Cu1 ($1b$) and Cu2 ($6l$) differing by the surrounding coordination. Cu2 has the well-known square O²⁻ coordination. Flat square CuO₄ fragments are linked by edges and form Cu₆O₁₂ ring clusters. Within the ring clusters, the Cu2-O2 distances are 1.899 Å, the Cu2-O2-Cu2, bond angles are 84.5°, and the Cu2-Cu2 distances (2.554 Å) are less than the sum of covalent radii (2.64 Å), which indicates to the presence of metal bond in Cu₆ rings. One should mention that the Cu2-O2 distance in CuO₄ squares of this compound and the number of holes ($p = 0.21$) in Cu₆O₁₂ ring clusters are close, according to estimations on copper BVS, to respective values (1.891 Å and $p = 0.26$) in the internal plane of HgBa₂Ca₂Cu₃O_{8.16} [95] responsible for the emergence of superconductivity at $T_c = 145.5$ K under pressure of 6.0 GPa. Similar Cu₆O₁₂ clusters, but of a larger size ($d(\text{Cu-O}) = 1.96$ Å,

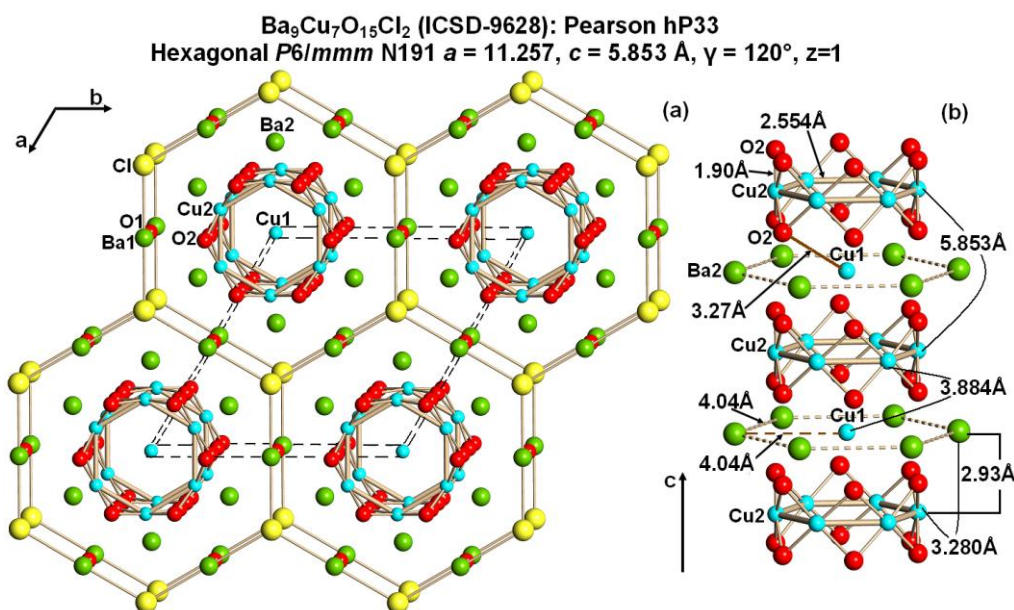

Figure 11. Crystal structure of Ba₉Cu₇O₁₅Cl₂ (a) and quasi-one-dimensional fragment – hexagonal tube from Cu₆O₁₂ ring clusters with Cu1 ions inside it and Ba2 ions outside it (b).

Cu-O-Cu = 82.9°, and (Cu-Cu) = 2.605 Å), can be observed in another compound (BaCuO₂) [96-99]; however, 8 of such clusters in a large cubic unit cell (lattice parameter $a = 18.28$ Å) are distributed in a different fashion and do not form one-dimensional fragments.

The main feature of the structure of Ba₉Cu₇O₁₅Cl₂ consists in the fact that Cu₆O₁₂ rings are packed in stacks along the axis c and comprise quasi-one-dimensional fragments – hexagonal tubes (Fig. 11a). The diameter of Cu₆ rings is equal to 5.108 Å, whereas the Cu2-Cu2 distances between rings in the stack and between stacks are equal to 5.853 Å and 6.833 Å, respectively. Large cavities between ring clusters are occupied by Cu1 atoms ($d(\text{Cu1-Cu1}) = 5.853$ Å and $d(\text{Cu1-Cu2}) = 3.884$ Å). As a result of such positioning, copper atoms acquire an uncharacteristic biplanar 12-fold coordination ($d(\text{Cu1-O2}) = 3.266$ Å). According to the BVS estimation, the charge of Cu1 atoms is as low as 0.16. Tubes of Cu₆O₁₂ rings are centered by Cu1 atoms, surrounded from the outside by hexagonal rings of Ba2 atoms ($d(\text{Ba2-Ba2}) = 4.036$ Å, $d(\text{Ba2-Cu2}) = 3.884$ Å and $d(\text{Ba2-O2}) = 2.698$ Å), and placed into large hexagonal channels forming linear -Ba1-O1- chains ($d(\text{Ba1-O1}) = 2.927$ Å), bonded to each other by Cl ions ($d(\text{Ba1-Cl}) = 3.249$ Å), along the axis c .

To realize transition of Ba₉Cu₇O₁₅Cl₂ into the superconducting state, one can vary the number of carriers and the values of important interatom distances, for example, by hole-doping of Cu₆O₁₂ rings through introduction of Na or K atoms into the positions Ba1 and Ba2 and Li, Na, or K atoms into the position Cu1. Through isovalent substitutions of large ions Ba²⁺ and Cl⁻ by smaller ones Sr²⁺, Ca²⁺, and F⁻, one can reduce the Cu2-Cu2 distances between clusters inside tubes (along the axis c) and between them (in the plane ab). To attain similarity to high- T_c cuprates, one can substitute atoms of Cu1 by those of Ca or Y. The latter would not yield a substantial decrease of the holes number, since the elementary unit contains only one Cu1 atom and Cu1-O distances are very big. It is possible to attempt substituting Cl atoms by those of oxygen, but this must result in structural changes.

We assume that the quasi-one-dimensional fragment comprising a tube of metal rings Cu₆O₁₂ with a dielectric cation chain inside the tube and surrounded by dielectric cation ring outside it could cause the emergence of superconducting properties in this compound. The principal difference of this quasi-one-dimensional fragment from the Ginsburg sandwich consists in the fact that in the former the tube with charge carriers is not continuous, as the CuO₂ layer in the

sandwich, but consists of metal clusters. However, this fact does not hamper their transition into the superconducting state, since there are well-known superconductors (for example, $\text{Lu}_2\text{Fe}_3\text{Si}_5$ and RuZrP , see above) with the quasi-one-dimensional cluster structure, but low transition temperature. Nevertheless, one has grounds to expect high T_c in compounds of the structural type $\text{Ba}_9\text{Cu}_7\text{O}_{15}\text{Cl}_2$. The point here is in the fact that, unlike superconductors $\text{Lu}_2\text{Fe}_3\text{Si}_5$ and RuZrP , in the quasi-one-dimensional fragment $\text{Ba}_9\text{Cu}_7\text{O}_{15}\text{Cl}_2$ there is virtually no overlapping of the space of charge carriers' transfer by binding electrons along the tube from Cu_6O_{12} rings, just like in the internal CuO_2 of plane high- T_c cuprates with the number of CuO_2 planes equal to 3.

3.2.3. KCuO and RbCuO . Binary oxides ACuO ($A = \text{Li}, \text{Na}, \text{K}$ and Rb) [100-104] crystallize in a tetragonal system, but their space group was not immediately established unambiguously. First, it was believed that the space group of these compounds was $I\bar{4}$ N82 [100, 101], then $I\bar{4}m2$ N119 [102, 103] while later [104] the conclusion was put forward that for all the compounds (except, possibly, RbCuO) the centrosymmetric space group $I4/mmm$ N139 was the most relevant. It is possibly related to the presence of vacancies in A cations positions.

The structure of ACuO oxides (Fig. 12a) contains two types of quasi-one-dimensional fragments stretched along the axis c : stacks of square rings $[\text{Cu}_4\text{O}_4]^{4+}$ (Fig. 12b) and chains of common edge-bonded A_4^{4+} tetrahedra located between stacks. Tetrahedra chains are linked to oxygen atoms from $[\text{Cu}_4\text{O}_4]^{4+}$ rings. The ACuO structures in $I4/mmm$ and $I\bar{4}m2$ space groups differ only by the fact that in the first $[\text{Cu}_4\text{O}_4]^{4+}$ rings are flat, whereas in the second one oxygen atoms slightly deviate from Cu_4 square plane.

Further we will show changes of the most important structural parameters in a row $A = \text{Li}, \text{Na}, \text{K}$ and Rb within the space group $I4/mmm$ using experimental data of [103].

Increase of the A atom size results in increase of lattice parameters a (from 8.514 Å (LiCuO) up to 9.541 Å (RbCuO)) and c (from 3.809 Å (LiCuO) up to 5.812 Å (RbCuO)), whereas the latter one (parameter c) increases much more steeply due to chains of A tetrahedra stretched along the axis c . Accordingly, the

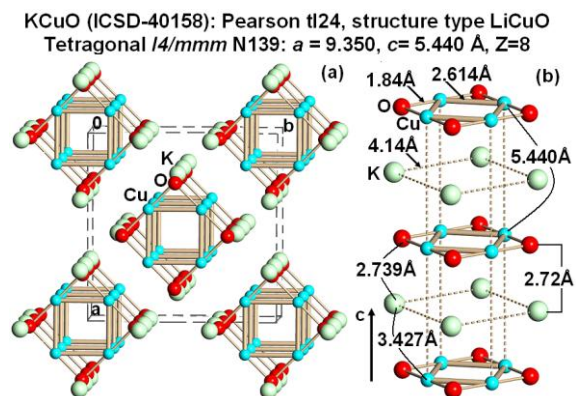

Figure 12. Crystal structure of KCuO (a) and quasi-one-dimensional fragment – tube from square rings $[\text{Cu}_4\text{O}_4]^{4+}$, with potassium ions outside it.

Cu-Cu distances between $[\text{Cu}_4\text{O}_4]^{4+}$ rings in a stack increase significantly (by 2.00 Å: from 3.809 Å (LiCuO) up to 5.812 Å (RbCuO)), whereas the distance between stacks increases by as little as 1.30 Å (from 2.942 Å (LiCuO) up to 4.244 Å (RbCuO)). A different situation is observed for Cu_4O_4 rings ($d(\text{Cu-Cu}) = 2.672$ Å in LiCuO and 2.584 Å in RbCuO) – they shrink by 0.088 Å under effect of extending chains of A atoms: here the strength of metal bond in the ring increases, since the Cu-Cu distances in compounds of Na, K, and Rb become less than the sum of copper covalent radii (2.64 Å). The Cu-O bond length slightly decreases as well (from 1.85 (LiCuO) down to 1.82 (LiCuO) Å), which, according to BVS calculations, indicates to the increase of copper atoms charge from 1.26 up to 1.37.

To sum up, one can regulate, through complete or partial substitution of A atoms, the structural parameters of these compounds.

We assume that doping the compounds ACuO with holes through creation of vacancies in A atoms chains or substitution of a part of O^{2-} ions by N^{3-} ions could result in the emergence of superconductivity. The most suitable candidate to become a superconductor is the compound KCuO (Fig. 12a), since the Cu-Cu distances (5.440 Å) between $[\text{Cu}_4\text{O}_4]^{4+}$ rings in KCuO stacks are close to those (5.443 Å) between copper atoms along the diagonals of squares in the CuO_2 -plane of the superconductor $(\text{Hg}_{0.6}\text{Tl}_{0.4})\text{Ba}_2\text{Ca}_2\text{Cu}_3\text{O}_{8.33}$ [105]. Possibly, the compound LiCuO will have an ion conductivity, if one creates some deficit of Li^+ ions to induce the Li^+ ionic diffusion.

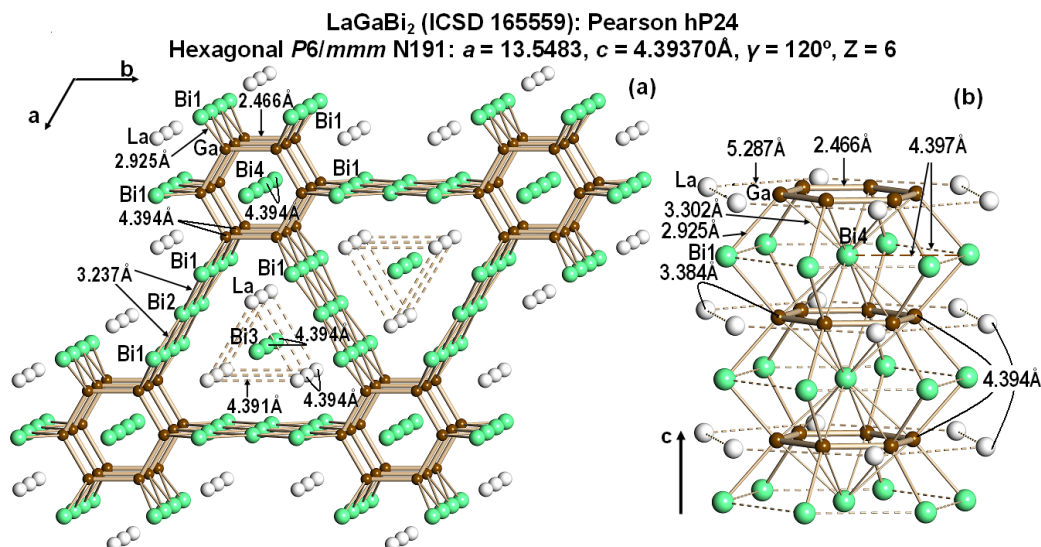

Figure 13. Crystal structure of LaGaBi₂ (a) and quasi-one-dimensional fragment – tube from hexagonal Ga₆ rings, with Bi⁴⁺ ions inside it and La³⁺ ions outside it.

3.2.4. LaGaBi₂. In the crystal structure of LaGaBi₂ (hexagonal, space group *P6/mmm*, $a = 13.548\text{ \AA}$, $c = 4.394(1)\text{ \AA}$, $Z = 6$) [106] (Fig. 13a), one can mark out three types of quasi-one-dimensional fragments along the c -direction: tubes from hexagonal Ga₆ rings, inside which Bi⁴⁺ atoms are pressed between rings, columns of La₆ trigonal prisms centered by Bi³⁺ atoms, and three-atom-wide Bi ribbons.

The Ga₆ rings are rigorously planar and have ideal bond angles of 120° . The Ga-Ga distances of 2.466 \AA are virtually equal to the sum of covalent radii of Ga (2.44 \AA). The Ga₆ rings are arranged in a one-dimensional stack along the c -direction (Fig. 13b), but the inter-ring distance is very long (equal to the c -parameter, 4.394 \AA). The length of bonds between Ga and Bi⁴⁺ (the atoms sandwiched between Ga₆ rings) of 3.302 \AA exceeds significantly the sum of covalent radii (2.70 \AA) of these atoms. In La₆ trigonal prisms all La-La distances ($\sim 4.39\text{ \AA}$) are larger (by $\sim 0.84\text{ \AA}$), whereas the length of bonds La-Bi³⁺ (3.355 \AA) is, in opposite, smaller (by 0.195 \AA) than the sum of covalent radii. The Bi¹-Bi² distances in Bi ribbons (3.237 \AA) are larger than the sum of covalent radii by 0.277 \AA .

The LaGaBi₂ is metallic with the resistivity decreasing only slightly with decreasing temperature [106]. In contrast to the closely related structure of La₁₃Ga₈Sb₂₁ (the onset of superconductivity below $T_c = 2.4\text{ K}$) [107-109], it is not superconducting. However, there exists a

principal difference between these structures in one fragment that, in our opinion, is responsible for the emergence of superconductivity. In La₁₃Ga₈Sb₂₁ similarly charged La³⁺ ions are located inside and outside of hexagonal Ga₆ rings, whereas in LaGaBi₂ negatively charged Bi⁴⁺ ions are located inside the tubes, and positively charged La ions are located outside them. Our studies of high- T_c cuprates (see paragraph 2) demonstrated that the charge of dielectric layers, between which the plane with carriers is located, was of primary importance for the emergence of superconductivity. In LaGaBi₂ we observed another case when dielectric fragments inside and outside the tube had opposite charges, which must hamper the emergence of superconductivity. To realize the latter situation, possibly, with high T_c in compounds of the structural type LaGaBi₂ (whose formula within the frames of the elementary unit is La₆Ga₆Bi₁₂), we suggest to carry out a number of substitution and dope them with holes: (i) substitute Bi⁴⁺ atoms located inside the tube by atoms of La or other rare earth element (Re); (ii) substitute Ga atoms by those of d-element Fe that must be possible, since Ga and Fe form isomorphic mixtures [110, 111]; (iii) substitute a part of La ions by calcium ions. As a result, the compound formula will become (Re_{7-x}Ca_x)Fe₆Bi₁₁ in the LaGaBi₂-type. One can also attempt to obtain the compound (Re_{7-x}Ca_x)Fe₆Sb₁₁ in this structural type.

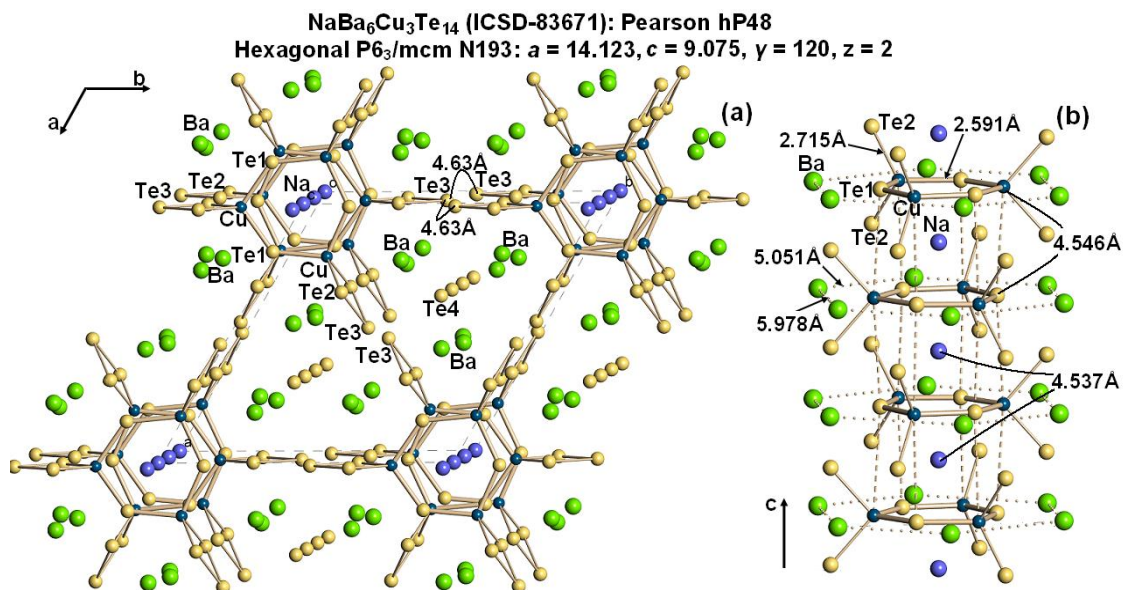

Figure 14. Crystal structure of NaBa₆Cu₃Te₁₄ (a) and quasi-one-dimensional fragment – tube from six-membered Cu₃Te₃ rings with Na⁺ ions inside it and Ba²⁺ ions outside it.

3.2.5. *NaBa₆Cu₃Te₁₄*. The crystal structure of NaBa₆Cu₃Te₁₄ (hexagonal, space group *P6₃/mcm* N193, $a = 14.123(2)$ Å, $c = 9.075(1)$ Å, $Z = 2$) [112] (Fig. 14a) contains a quasi-one-dimensional fragment which satisfies our requirements in structural terms. Its structure is based on the [Cu₃Te₃(Te₃)₃]⁹⁻ clusters. These clusters comprise six-membered Cu₃Te₃ rings located on a $\bar{6}2m$ site, they must be strictly planar. The Cu-Te1 bonds, Te1-Cu-Te1 and Cu-Te1-Cu angles in the Cu₃Te₃ ring are 2.59 Å, 109.4° and 130.6°, respectively. Each copper atom is coordinated in a bidentate fashion to the Te₃²⁻ ligand to form the four-membered CuTe₃ ring, which is also planar and lies perpendicularly to the Cu₃Te₃ ring. The [Cu₃Te₃(Te₃)₃]⁹⁻ clusters stack along the *c* axis in a staggered arrangement and encapsulate Na⁺ ions inside the column stack. The distances between Cu₃Te₃-rings in a stack are equal to 4.537 Å ($c/2$). The distances Na-Cu and Na-Te between Na atoms and Cu₃Te₃ rings are equal to 3.540 Å and 3.333 Å, respectively. The clusters linked this way and shaped like a paddle-wheel form a highly negatively charged, one-dimensional column of [NaCu₃Te₃(Te₃)₃]⁸⁻ along the *c* axis. These columns are surrounded by six columns of divalent barium cations. In other words, this structure contains tubes from six-membered Cu₃Te₃ rings, Na⁺ ions are located inside the tubes, Ba²⁺ ions are located outside them (see Fig.

14 b). Elsewhere in the lattice discrete Te²⁻ ions (Te4) are each surrounded by six Ba²⁺ ions in a trigonal prismatic arrangement. Therefore, the structure of this telluride is best described by the formula Ba₆[NaCu₃Te₃(Te₃)₃]Te₂, as was suggested in [113].

According to the data of measurements [112], this telluride is a p-type semiconductor that is explained in [112, 113] by the existence of ionic Te^{••}Te contacts, which are shortened as compared to the sum of the van der Waals radii.

One can assume that doping six-membered Cu₃Te₃-rings with holes would result in the emergence of superconductivity in NaBa₆Cu₃Te₁₄. Doping can be realized through substitution of Ba²⁺ ions by K⁺ ions: here one can leave Na⁺ ions in the same position and obtain the compound NaBa_{6-x}K_xCu₃Te₁₄ or substitute them completely by K⁺ ions and obtain the compound K_{1+x}Ba_{6-x}Cu₃Te₁₄. There is also one more way – substitution of Te²⁻ (preferably Te4 (site 4d)) by Sb³⁻.

4. Conclusions

We believe that superconductors with the quasi-one-dimensional crystal structure based on the Ginsburg sandwich, comprising a layered structure dielectric – metal – dielectric, convoluted into a tube can have high

temperatures of the superconducting transition. These tubes of the sandwich type comprise conducting tubes or those from conducting rings with dielectric inside and outside them. The system metal – dielectric can be also suitable only when dielectric is present only inside or only outside of a conducting tube or that built of conducting rings. This assumption is based on the fact that crystal chemistry factors creating the conditions for the emergence of superconductivity and determining the value of T_c in A-CuO₂-A sandwiches of layered superconducting cuprates and tubes of the sandwich-type must be essentially similar. Besides, we managed to mark out similar quasi-one-dimensional fragments in known low-temperature superconductors that, in our opinion, are responsible for the emergence of superconductivity.

In the inorganic crystal structure database (ICSD) we identified five compounds (La₄BaCu₄FeO_{12.96}, Ba₉Cu₇O₁₅Cl₂, KCuO, LaGaBi₂, and NaBa₆Cu₃Te₁₄) whose structures mainly correspond to the determined crystal chemistry conditions, at which the emergence of superconductivity with high superconducting transition temperatures is possible. These compounds could be the parents of new families of inorganic superconductors with quasi-one-dimensional structure upon doping, substitutions, or modifications in variants we have suggested.

References

- [1] Little W A 1964 *Phys. Rev. A* **134** 1416
- [2] Ginzburg V L 1964 *Zh Eksp i Teor Fiz* **47** 2318; [1965 *Sov Phys - JETP* **20** 1549]
- [3] Kats E I, 1969 *Zh Eksp i Teor Fiz* **56** 1675; [1970 *Sov Phys - JETP* **29** 897]
- [4] Bednorz J G and Müller K A 1986 *Z. Phys. B* **64**, 189
- [5] Ginzburg V L 1970 *Usp. Fiz. Nauk* **101** 185; [1971 *Sov. Phys. Usp.* **13** 335]
- [6] Volkova L M, Polyshchuk S A and Herbeck F E 2004 *Focus on Superconductivity* ed B P Martins (New York: Nova Science) (Preprints [cond-mat/0402272](#) and [cond-mat/0310511](#))
- [7] Volkova L M, Polyshchuk S A, Magarill S A and Herbeck F E 2003 *J. Supercond.* **16** 937
- [8] Volkova L M, Polyshchuk S A and Herbeck F E 2000 *J. Supercond.* **13** 583
- [9] Volkova L M, Polyshchuk S A, Magarill S A and Sobolev A N 2000 *Inorg. Mater.* **36** 919
- [10] Shannon R D 1976 *Acta Crystallogr. A* **32** 751
- [11] Brown I D and Altermatt D 1985 *Acta Crystallogr.* **B41** 244
- [12] Hunter B A, Jorgensen J D, Wagner J L, Radaelli P G, Hinks D G, Shaked H and Hitterman R L 1994 *Physica C* **221** 1
- [13] Gao L, Xue Y Y, Chen F, Xiong Q, Meng R L, Ramirez D, Chu C W, Eggert J H and Mao H K 1994 *Phys. Rev. B* **50** 4260
- [14] Volkova L M, Polyshchuk S A, Magarill S A and Herbeck F E 2001 *J. Supercond.* **14**, 693
- [15] Volkova L M, Polyshchuk S A, Magarill S A and Herbeck F E 2002 *J. Supercond.* **15**, 663
- [16] Barz H, Ku H C, Meisner G P, Fisk Z and Mattis B T 1980 *Proc. Natl. Acad. Sci. USA* **77** 3132
- [17] Shirovani I, Ichihashi N, Nozawa K, Kinoshita M, Yagi T, Suzuki K and Enoki T 1983 *Jpn J. Appl. Phys. Suppl.* **32**(3) 695
- [18] Meisner G P, Ku H C and Barz H 1983 *Mater. Res. Bull.* **18** 983
- [19] Shirovani I, Tachi K, Konno Y, Todo S and Yagi T 1999 *Philos. Mag. B* **79** 767
- [20] Seo D-K, Ren J and Whangbo M-H 1997 *Inorg. Chem.* **36** 6058
- [21] Hase I 2002 *Phys. Rev. B* **65** 174507
- [22] Müller R, Shelton R N, Richardson J W Jr and Jacobson R A 1983 *J Less-Common Met.* **92** 177.
- [23] Shirovani I, Tachi K, Takeda K, Todo S, Yagi T and Kanoda K 1995 *Phys. Rev. B* **52** 6197
- [24] Shirovani I, Tachi K, Ichihashi N, Adachi T, Kikegawa T, Shimomura, O. *Phys. Lett. A* 1995, **205**, 77.
- [25] Cordero B, Gómez V, Platero-Prats A E, Revès M, Echeverría J, Cremades E, Barragán F and Alvarez S 2008 *Dalton Trans.* 2832
- [26] Meisner G P and Ku H C 1983 *Appl. Phys. A* **31** 201
- [27] Meisner G P and Ku H C 1983 *Phys. Lett. A* **96** 483
- [28] Xian-Zhong W, Chevalier B, Etourneau J and Hagenmuller P 1987 *Mat. Res. Bull.* **22** 331
- [29] Subba Rao G V, Wagner K, Balakrishnan G, Janaki J, Paulus W, Schöllhorn R, Subramanian V S and Poppe U 1985 *Bull. Mater. Sci.* **7** 215
- [30] Johnson V and Jeitschko W 1972 *J. Solid State Chem.* **4** 123
- [31] Xian-Zhong W, Chevalier B, Etourneau J and Hagenmuller P 1986 *Solid State Commun.* **59** 839
- [32] Kanomata T, Kawashima T, Utsugi H, Goto T, Hasegawa H and Kaneko T 1991 *J. Appl. Phys.* **69** 4639
- [33] Deyris B, Roy-Montreuil J, Michel A, Sénateur J P, Rouault A, Krumbugel-Nylund A and Fruchart R 1975 *Mater. Res. Bull.* **10** 603
- [34] Harada T, Kanomata T and Kaneko T 1990 *J. Magn. Magn. Mat.* **90 - 91** 169.
- [35] Hovestreydt E, Engel N, Klepp K O, Chabot B and Parthé E 1982 *J Less-Common Met.* **85** 247
- [36] Hönle W, von Schnering H G, Lipka A and Yvon K 1980 *J Less-Common Met* **71** 135
- [37] Tarascon J, DiSalvo F and Waszczak J 1984 *Solid State Commun.* **52** 227
- [38] Dronskowskit R and Hoffmann R 1992 *Inorg. Chem.* **31** 3107
- [39] Armici J C, Decroux M, Fisher Ø, Potel M, Chevrel R and Sergent M 1980 *Solid State Commun.* **33** 607
- [40] Hor P, Fan W, Chou L, Meng R, Chu C, Tarascon J and Wu M 1985 *Solid State Commun.* **55** 231
- [41] Lepetit R and Monceau P, Potei M, Gougeon P and Sergent M 1984 *J Low Temp. Phys.* **56** 219
- [42] Brusetti R, Monceau P, Potel M, Gougeon P and Sergent M 1988 *Solid State Commun.* **66** 181
- [43] Tessema G X, Tseng Y T, Skove M J, Stillwell E P, Brusetti R, Monceau P, Potel M and Gougeon P 1991 *Phys. Rev. B* **43** 3434
- [44] Petrović A P, Lortz R, Santi G, Decroux M, Monnard H, Fischer Ø, Boeri L, Andersen O K, Kortus J, Salloum D, Gougeon P and Potel M 2010 *Phys. Rev. B* **82** 235128
- [45] Bergk B, Petrović A P, Wang Z, Wang Y, Salloum D, Gougeon P, Potel M and Lortz R 2011 *New Journal of Physics* **13** 103018
- [46] Tamegai T, Nakagawa T and Tokunaga M 2007 *Physica C* **460-462** 708
- [47] Tamegai T, Nakajima Y, Nakagawa T, Li G and Harima H 2008 *Sci. Technol. Adv. Mater.* **9** 044206
- [48] Tamegai T, Nakajima Y, Nakagawa T, Li G J and Harima H 2009 *Journal of Physics: Conference Series* **150** 052264
- [49] Chabot B 1984 *J Less-Common Met.* **102** 23
- [50] Johnston D C and Braun H F 1982 *Superconductivity Ternary Compounds II* (Springer-Verlag)
- [51]. Sasame H, Masubuchi T, Takase K, Takano Y and Watanabe T 2009 *J Physics: Conference Series* **150** 052226

- [52] Watanabe T, Sasame H, Okuyama H, Takase K and Takano Y 2009 *Phys. Rev. B* **80**, 100502
- [53] Machida Y, Sakai S, Izawa K, Okuyama H and Watanabe T. 2011 *Phys. Rev. Lett.* **106** 107002
- [54] Karkin A E, Yangirov M R, Akshentsev Yu N and Goshchitskii B N 2011 *Phys. Rev. B* **84** 054541
- [55] Wang W K, Iwasaki H, Suryanarayana C, Masumoto T, Toyota N, Fukase T and Kogiku F 1982 *J. Mater. Sci.* **17** 1523
- [56] Haase E L 1985 *Thin Solid Films* **124** 283
- [57] Drys M, Sosnowski J and Folcik L 1979 *J. Less-Common Met.* **68** 175
- [58] Maier R G and Wilhelm G 1964 *Z. Naturforsch. Teil A* **19** 399
- [59] Jorda J L and Muller J 1982 *J Less-Common Met.* **84** 39
- [60] Geller S, Matthias B T and Goldstein R 1955 *J. Am. Chem. Soc.* **77**, 1502
- [61] Wood E A, Compton V B, Matthias B T and Corenzwit E 1958 *Acta Crystallogr.* **11** 604
- [62] Villars P and Girgis K 1982 *Z. Metallkde* **73** 169
- [63] Leger J M and Hall H T 1974 *J. Less-Common Met.* **34** 17
- [64] Oota A, Ogasawara M and Noguchi S 1983 *J. Phys. F* **13** 1257
- [65] Killpatrick D H 1964 *J. Phys. Chem. Solids* **25** 1213
- [66] Alekseevskii N E, Kornilov I I and Mateeva N M 1970 *Dokl. Akad. Nauk SSSR* **195** 417
- [67] Poole Jr C P and Farach H A 2000 *J. Supercond.* **13** 47
- [68] Noolandi J and Testardi L R 1977 *Phys. Rev. B* **15** 5462
- [69] Dew-Hughens D and Rivlin V G 1974 *Nature* **250** 723
- [70] Geller S 1975 *Appl. Phys.* **7** 321
- [71] Li G J, Miura M, Shi Z X and Tamegai T 2007 *Physica C* **463-465** 76
- [72] Galli F, Ramakrishnan S, Taniguchi T, Nieuwenhuys G J, Mydosh J A, Geupel S, Lüdecke J and van Smaalen S 2000 *Phys. Rev. Lett.* **85** 158
- [73] Tamegai T, Nakajima Y, Nakagawa T, Li G and Harima H 2008 *Sci. Technol. Adv. Mater.* **9** 044206
- [74] Nakajima Y, Li G J and Tamegai T 2009 *J. Phys.: Conf. Ser.* **150**, 052180,
- [75] Braun H F and Segre C U 1980 *Solid State Commun.* **35** 735
- [76] Braun H F, Yvon K and Braun R. M 1980 *Acta. Crystallogr. B* **36**, 2397
- [77] Braun H F 1984 *J. Less-Common Met.* **100** 105
- [78] Hausermann-Berg L. S and Shelton R N 1987 *Phys. Rev. B* **35** 6659
- [79] Becker B, Patil N G, Ramakrishnan S, Menovsky A A, Nieuwenhuys G J, Mydosh J A, Kohgi M and Iwasa K 1999 *Phys. Rev. B* **59** 7266
- [80] Calestani G and Rizzoli C 1987 *Nature* **328** 606
- [81] Chondroudi M, Balasubramanian M, Welp U, Kwok W-K and Kanatzidis M G 2007 *Chem. Mater.* **19**, 4769
- [82] Bednorz J G and Müller K A 1986 *Z. Phys.* **B 64** 189
- [83] Anderson P S, Kirk C A, Skakle J M S and West A R 2003 *J. Solid State Chem.* **170** 1.
- [84] Michel C, Er-Rakho L and Raveau B 1985 *Mat. Res. Bull.* **20** 667.
- [85] Bednorz J G and Müller K A 1988 *Usp. Fiz. Nauk* **156** 323
- [86] Shivakumara C, Hegde M S, Rajagopal H and Sequiera A 2000 *Mat. Res. Bull.* **35** 2063
- [87] Venimadhav A, Subramanya Herle P, Vedawyas M, Shivakumara C and Hegde M S 1999 *Appl Phys Lett* **75** 1598
- [88] Torrance J B, Tokura Y, Nazzari A, and Parkin S S P 1988 *Phys. Rev. Lett.* **60** 542
- [89] Ottschi K, Hayashi A, Fujiwara Y and Ueda Y 1993 *J. Solid State Chem.* **105** 573.
- [90] Goldschmidt D, Reisner G M, Direktovitch Y, Knizhnik A, Gartstein E, Kimmel G and Eckstein Y 1993 *Phys. Rev. B* **48**, 532
- [91] Subbarao M V, Rajagopal H, Sequeira A and Kulkarni R G 1999 *Physica C* **319** 181.
- [92] Kao H-C I, Leu Y D, Huang W N, Wang C-M, Chen D H and Lee T J 1996 *Supercond. Sci. Technol.* **9** 893
- [93] Kipka R and Mueller-Buschbaum H 1976 *Z. Naturforsch.* **B 31** 1067
- [94] Müller-Buschbaum H 1977 *Angew. Chem.* **16** 674
- [95] Armstrong A R, David W I F, Gameson I, Edwards P P, Capponi J J, Bordet P and Marezio M 1995 *Phys. Rev. B* **52** 15551
- [96] Kipka R and Mueller-Buschbaum H 1977 *Z. Naturforsch. Z. B* **32** 121
- [97] Weller M. T. and Lines D R 1989 *J. Solid. State Chem.* **82** 21
- [98] Yamamoto A, Koyama T, Mito T, Wada S, Fisher R A, Phillips N E, Wang Z-P and Johnston D C 2003 *J. Phys.: Condens. Matter.* **15** 8587
- [99] Wang Z R, Johnston D C, Miller L L and Vaknin D 1995 *Phys. Rev. B* **52** 7384
- [100] Hestermann K and Hoppe R 1968 *Z. Anorg. Allgem. Chem.* **360** 113.
- [101] Hoppe R, Hesterman K and Schenk F 1969 *Z Anorg. Allgem. Chem.* **367** 275
- [102] Migeon H N, Zanne M and Gleitzer C 1976 *J. Solid. State Chem.* **16** 325
- [103] Losert W and Hoppe R 1985 *Z. Anorg. Allgem. Chem.* **524** 7
- [104] Fischer D, Carl W, Glaum H and Hoppe R 1990 *Z. Anorg. Allgem. Chem.* **585** 75
- [105] Dai P, Chakoumakos B C, Sun G F, Wong K W, Xin Y and Lu D F 1995 *Physica C* **243** 201
- [106] Morgan M G, Wang M, Chan W Y and Mar A 2003 *Inorg. Chem.* **42** 1549
- [107] Mills A M, Deakin L and Mar A 2001 *Chem. Mater.* **13** 1778
- [108] Mills A M, Lam R, Ferguson M J, Deakin L and Mar A 2002 *Coord. Chem. Rev.* **233-234** 207
- [109] Mills A M and Mar A 2000 *Inorg. Chem.* **39** 4599
- [110] Makarov E S 1973 *Atom Isomorphy in Crystals* (Moscow: Atomizdat)
- [111] Hoppe R 1986 *J. Solid State. Chem.* **64** 372
- [112] Zhang X, Schindler J L, Hogan T, Albritton-Thomas J, Kannewurf C R and Kanatzidis M G 1995 *Angew. Chem.* **107** 117
- [113] Starodub V A 1999 *Russ. Chem. Rev.* **68**, 801