

Defining the Symmetry of the Universal Semi-regular Autonomous Asynchronous Systems

Serban E. Vlad
Str. Zimbrului, Nr. 3, Bl. PB68, Ap. 11, 410430, Oradea,
Romania, email: serban_e_vlad@yahoo.com

Abstract

The regular autonomous asynchronous systems are the non-deterministic Boolean dynamical systems and universality means the greatest in the sense of the inclusion. The paper gives four definitions of symmetry of these systems in a slightly more general framework, called semi-regularity and also many examples.

MSC: 94C10

keywords: asynchronous system, symmetry

1 Introduction

Switching theory has developed in the 50's and the 60's as a common effort of the mathematicians and the engineers of studying the switching circuits (=asynchronous circuits) from digital electrical engineering. After 1970 we do not know to exist any mathematical published work in what we call switching theory. The published works are written by engineers and their approach is always descriptive and unacceptable for the mathematicians. The label of *switching theory* has changed to *asynchronous systems* (or *circuits*) *theory*. One of the possible motivations of the situation consists in the fact that the important producers of digital equipments have stopped the dissemination of such researches.

Our interest in asynchronous systems had bibliography coming from the 50's and the 60's, as well as engineering works giving intuition, as well as mathematical works giving analogies. An interesting *rendezvous* has happened when the asynchronous systems theory has met the dynamical systems theory, resulting the so called *regular* autonomous systems=Boolean dynamical systems; the vector field is $\Phi : \{0,1\}^n \rightarrow \{0,1\}^n$, time is discrete or real and we obtain the *unbounded delay model*

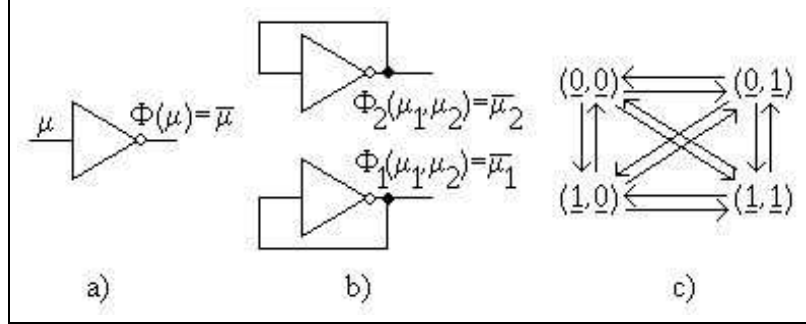

Figure 1: a) the logical gate NOT, b) circuit with logical gates NOT, c) state portrait

of computation of Φ , suggested by the engineers. The *synchronous* iterations of $\Phi : \Phi \circ \Phi, \Phi \circ \Phi \circ \Phi, \dots$ of the dynamical systems are replaced by *asynchronous* iterations in which each coordinate Φ_1, \dots, Φ_n is iterated independently on the others, in arbitrary finite time.

We denote with $\mathbf{B} = \{0, 1\}$ the binary Boolean algebra, together with the discrete topology and with the usual algebraical laws:

$-$	$\cdot 01$	$\cup 01$	$\oplus 01$
$01,$	$000,$	$001,$	001
10	101	111	110

Table 1

We use the same notations for the laws that are induced from \mathbf{B} on other sets, for example $\forall x \in \mathbf{B}^n, \forall y \in \mathbf{B}^n$,

$$\bar{x} = (\bar{x}_1, \dots, \bar{x}_n),$$

$$x \cup y = (x_1 \cup y_1, \dots, x_n \cup y_n)$$

etc. In Figure 1 we have drawn at a) the logical gate NOT, i.e. the circuit that computes the logical complement and at b) a circuit that makes use of logical gates NOT. The asynchronous system that models the circuit from b) has the state portrait drawn at c). In the state portraits, the arrows show the increase of (the discrete or continuous) time. The underlined coordinates $\underline{\mu}_i$ are these coordinates for which $\Phi_i(\mu_i) \neq \mu_i$ and they are called *excited*, or *enabled*, or *unstable*. The coordinates μ_i that are not underlined fulfill by definition $\Phi_i(\mu_i) = \mu_i$ and they are called *not excited*, or *not enabled*, or *stable*. The existence of two underlined coordinates in $(0, 0)$ shows that $\Phi_1(0, 0) = 1$ may be computed first, $\Phi_2(0, 0) = 1$ may be computed first, or $\Phi_1(0, 0), \Phi_2(0, 0)$

may be computed simultaneously, thus when the system is in $(0, 0)$, it may run in three different directions, non-determinism.

Our present purpose is to define the symmetry of these systems.

2 Semi-regular systems

Notation 1 We denote $\mathbf{N}_- = \{-1, 0, 1, 2, \dots\}$.

Notation 2 $\chi_A : \mathbf{R} \rightarrow \mathbf{B}$ is the notation of the characteristic function of the set $A \subset \mathbf{R}$: $\forall t \in \mathbf{R}, \chi_A(t) = \begin{cases} 0, & \text{if } t \notin A \\ 1, & \text{if } t \in A \end{cases}$.

Notation 3 We denote with $\overline{\Pi}_n$ the set of the sequences $\alpha = \alpha^0, \alpha^1, \dots, \alpha^k, \dots \in \mathbf{B}^n$.

Notation 4 The set of the real sequences $t_0 < t_1 < \dots < t_k < \dots$ that are unbounded from above is denoted with *Seq*.

Notation 5 We use the notation \overline{P}_n for the set of the functions $\rho : \mathbf{R} \rightarrow \mathbf{B}^n$ having the property that $\alpha \in \overline{\Pi}_n$ and $(t_k) \in \text{Seq}$ exist with $\forall t \in \mathbf{R}$,

$$\rho(t) = \alpha^0 \chi_{\{t_0\}}(t) \oplus \alpha^1 \chi_{\{t_1\}}(t) \oplus \dots \oplus \alpha^k \chi_{\{t_k\}}(t) \oplus \dots \quad (1)$$

Definition 6 Let $\Phi : \mathbf{B}^n \rightarrow \mathbf{B}^n$ be a function. For $\nu \in \mathbf{B}^n, \nu = (\nu_1, \dots, \nu_n)$ we define the function $\Phi^\nu : \mathbf{B}^n \rightarrow \mathbf{B}^n$ by $\forall \mu \in \mathbf{B}^n$,

$$\Phi^\nu(\mu) = (\overline{\nu}_1 \mu_1 \oplus \nu_1 \Phi_1(\mu), \dots, \overline{\nu}_n \mu_n \oplus \nu_n \Phi_n(\mu)).$$

Definition 7 Let be $\alpha \in \overline{\Pi}_n$. The function $\widehat{\Phi}^\alpha : \mathbf{B}^n \times \mathbf{N}_- \rightarrow \mathbf{B}^n$ defined by $\forall \mu \in \mathbf{B}^n, \forall k \in \mathbf{N}_-$,

$$\begin{cases} \widehat{\Phi}^\alpha(\mu, -1) = \mu, \\ \widehat{\Phi}^\alpha(\mu, k+1) = \Phi^{\alpha^{k+1}}(\widehat{\Phi}^\alpha(\mu, k)) \end{cases} \quad (2)$$

is called **discrete time α -semi-orbit of μ** . We consider also the sequence $(t_k) \in \text{Seq}$ and the function $\rho \in \overline{P}_n$ from (1), for which the function $\Phi^\rho : \mathbf{B}^n \times \mathbf{R} \rightarrow \mathbf{B}^n$ is defined by: $\forall \mu \in \mathbf{B}^n, \forall t \in \mathbf{R}$,

$$\begin{aligned} \Phi^\rho(\mu, t) = & \widehat{\Phi}^\alpha(\mu, -1) \chi_{(-\infty, t_0)}(t) \oplus \widehat{\Phi}^\alpha(\mu, 0) \chi_{[t_0, t_1)}(t) \oplus \\ & \oplus \widehat{\Phi}^\alpha(\mu, 1) \chi_{[t_1, t_2)}(t) \oplus \dots \oplus \widehat{\Phi}^\alpha(\mu, k) \chi_{[t_k, t_{k+1})}(t) \oplus \dots \end{aligned} \quad (3)$$

Φ^ρ is called **continuous time ρ -semi-orbit of μ** .

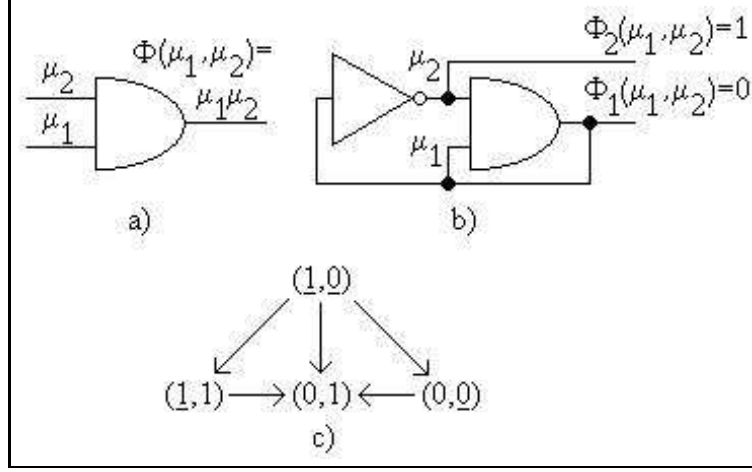

Figure 2: The semi-regular system $\bar{\Xi}_\Phi$ from Example 10

Definition 8 The *discrete time* and the *continuous time universal semi-regular autonomous asynchronous systems* are defined by

$$\begin{aligned}\widehat{\Xi}_\Phi &= \{\widehat{\Phi}^\alpha(\mu, \cdot) \mid \mu \in \mathbf{B}^n, \alpha \in \overline{\Pi}_n\}, \\ \bar{\Xi}_\Phi &= \{\Phi^\rho(\mu, \cdot) \mid \mu \in \mathbf{B}^n, \rho \in \overline{P}_n\}.\end{aligned}$$

Remark 9 $\widehat{\Xi}_\Phi$, $\bar{\Xi}_\Phi$ and Φ are usually identified.

Example 10 In Figure 2 we have drawn at a) the AND gate that computes the logical intersection, at b) a circuit with two gates and at c) the state portrait of $\Phi : \mathbf{B}^2 \rightarrow \mathbf{B}^2, \forall (\mu_1, \mu_2) \in \mathbf{B}^2, \Phi(\mu_1, \mu_2) = (0, 1)$. We conclude that

$$\bar{\Xi}_\Phi = \{(\mu_1, \mu_2)\chi_{(-\infty, t_0)} \oplus (\mu_1\lambda_1, \mu_2 \cup \lambda_2)\chi_{[t_0, t_1)} \oplus$$

$$\oplus (\mu_1\lambda_1\nu_1, \mu_2 \cup \lambda_2 \cup \nu_2)\chi_{[t_1, \infty)} \mid \mu, \lambda, \nu \in \mathbf{B}^2, t_0, t_1 \in \mathbf{R}, t_0 < t_1\},$$

since the first coordinate might finally decrease its value and the second coordinate might finally increase its value, but the order and the time instant when these things happen are arbitrary.

3 Anti-semi-regular systems

Definition 11 Let be $\Phi : \mathbf{B}^n \rightarrow \mathbf{B}^n, \alpha \in \overline{\Pi}_n, (t_k) \in \text{Seq}$ and $\rho \in \overline{P}_n$ from (1). The function ${}^*\widehat{\Phi}^\alpha : \mathbf{B}^n \times \mathbf{N}_- \rightarrow \mathbf{B}^n$ is defined by: $\forall \mu \in \mathbf{B}^n, \forall k \in \mathbf{N}_-$,

$$\begin{cases} {}^*\widehat{\Phi}^\alpha(\mu, -1) = \mu, \\ \Phi^{\alpha^{k+1}}({}^*\widehat{\Phi}^\alpha(\mu, k+1)) = {}^*\widehat{\Phi}^\alpha(\mu, k) \end{cases} \quad (4)$$

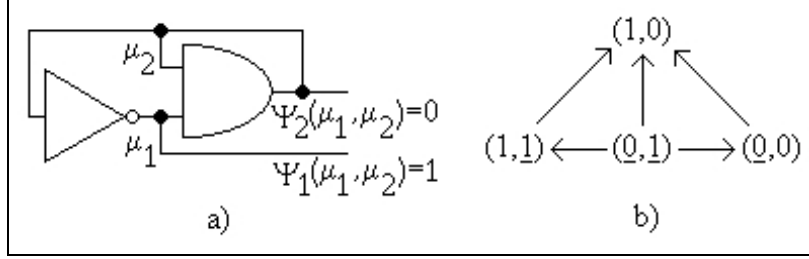

Figure 3: The semi-regular system Ξ_{Ψ}^* from Example 14

and ${}^*\Phi^{\rho} : \mathbf{B}^n \times \mathbf{R} \rightarrow \mathbf{B}^n$ is defined by: $\forall \mu \in \mathbf{B}^n, \forall t \in \mathbf{R}$,

$${}^*\Phi^{\rho}(\mu, t) = {}^*\widehat{\Phi}^{\alpha}(\mu, -1)\chi_{(-\infty, t_0)}(t) \oplus {}^*\widehat{\Phi}^{\alpha}(\mu, 0)\chi_{[t_0, t_1)}(t) \oplus \quad (5)$$

$$\oplus {}^*\widehat{\Phi}^{\alpha}(\mu, 1)\chi_{[t_1, t_2)}(t) \oplus \dots \oplus {}^*\widehat{\Phi}^{\alpha}(\mu, k)\chi_{[t_k, t_{k+1})}(t) \oplus \dots$$

${}^*\widehat{\Phi}^{\alpha}$ is called **discrete time α -anti-semi-orbit of μ** , while ${}^*\Phi^{\rho}$ is called **continuous time ρ -anti-semi-orbit of μ** .

Remark 12 We compare the semi-orbits and the anti-semi-orbits now and see that they run both from the past to the future, but the relation cause-effect is different: in $\widehat{\Phi}^{\alpha}$, Φ^{ρ} the cause is in the past and the effect is in the future, while in ${}^*\widehat{\Phi}^{\alpha}$, ${}^*\Phi^{\rho}$ the cause is in the future and the effect is in the past.

Definition 13 The **discrete time** and the **continuous time universal anti-semi-regular autonomous asynchronous systems** are defined by

$${}^*\widehat{\Xi}_{\Phi} = \{ {}^*\widehat{\Phi}^{\alpha}(\mu, \cdot) \mid \mu \in \mathbf{B}^n, \alpha \in \overline{\Pi}_n \},$$

$${}^*\Xi_{\Phi} = \{ {}^*\Phi^{\rho}(\mu, \cdot) \mid \mu \in \mathbf{B}^n, \rho \in \overline{P}_n \}.$$

Example 14 In Figure 3 we have drawn at a) the circuit and at b) the state portrait of $\Psi : \mathbf{B}^2 \rightarrow \mathbf{B}^2, \forall (\mu_1, \mu_2) \in \mathbf{B}^2, \Psi(\mu_1, \mu_2) = (1, 0)$ for which

$$\overline{\Xi}_{\Psi} = \{ (\mu_1, \mu_2)\chi_{(-\infty, t_0)} \oplus (\mu_1 \cup \lambda_1, \mu_2 \lambda_2)\chi_{[t_0, t_1)} \oplus$$

$$\oplus (\mu_1 \cup \lambda_1 \cup \nu_1, \mu_2 \lambda_2 \nu_2)\chi_{[t_1, \infty)} \mid \mu, \lambda, \nu \in \mathbf{B}^2, t_0, t_1 \in \mathbf{R}, t_0 < t_1 \}.$$

The arrows in Figures 2 c) and 3 b) are the same, but with a different sense and we note that $\overline{\Xi}_{\Psi} = {}^*\overline{\Xi}_{\Phi}$, where Φ is the one from Example 10.

4 Isomorphisms and anti-isomorphisms

Definition 15 Let be $g : \mathbf{B}^n \rightarrow \mathbf{B}^n$. It defines the functions $\widehat{g} : \overline{\Pi}_n \rightarrow \overline{\Pi}_n, \forall \alpha \in \overline{\Pi}_n, \forall k \in \mathbf{N}$,

$$\widehat{g}(\alpha)(k) = g(\alpha^k);$$

$\widetilde{g} : \overline{P}_n \rightarrow \overline{P}_n, \forall \rho \in \overline{P}_n, \forall t \in \mathbf{R}$,

$$\widetilde{g}(\rho)(t) = \begin{cases} (0, \dots, 0), & \text{if } \rho(t) = (0, \dots, 0), \\ g(\rho(t)), & \text{otherwise} \end{cases}$$

and $g : (\mathbf{B}^n)^{\mathbf{R}} \rightarrow (\mathbf{B}^n)^{\mathbf{R}}, \forall x \in (\mathbf{B}^n)^{\mathbf{R}}, \forall t \in \mathbf{R}$,

$$g(x)(t) = g(x(t)).$$

Theorem 16 Let be the functions $\Phi, \Psi, g, g' : \mathbf{B}^n \rightarrow \mathbf{B}^n$. The following statements are equivalent:

a) $\forall \nu \in \mathbf{B}^n$, the diagram

$$\begin{array}{ccc} \mathbf{B}^n & \xrightarrow{\Phi^\nu} & \mathbf{B}^n \\ g \downarrow & & \downarrow g \\ \mathbf{B}^n & \xrightarrow{\Psi^{g'(\nu)}} & \mathbf{B}^n \end{array}$$

is commutative;

b) $\forall \mu \in \mathbf{B}^n, \forall \alpha \in \overline{\Pi}_n, \forall k \in \mathbf{N}_-$,

$$g(\widehat{\Phi}^\alpha(\mu, k)) = \widehat{\Psi}^{\widehat{g}(\alpha)}(g(\mu), k);$$

c) $\forall \mu \in \mathbf{B}^n$,

$$g(\mu) = \Psi^{g'(0, \dots, 0)}(g(\mu))$$

and $\forall \mu \in \mathbf{B}^n, \forall \rho \in \overline{P}_n, \forall t \in \mathbf{R}$,

$$g(\Phi^\rho(\mu, t)) = \Psi^{\widetilde{g}(\rho)}(g(\mu), t).$$

Proof. a) \implies b) We fix arbitrarily $\mu \in \mathbf{B}^n, \alpha \in \overline{\Pi}_n$ and we use the induction on $k \geq -1$. For $k = -1$, b) becomes $g(\mu) = g(\mu)$, thus we suppose that it is true for k and we prove it for $k + 1$:

$$\begin{aligned} g(\widehat{\Phi}^\alpha(\mu, k + 1)) &= g(\Phi^{\alpha^{k+1}}(\widehat{\Phi}^\alpha(\mu, k))) = \Psi^{g'(\alpha^{k+1})}(g(\widehat{\Phi}^\alpha(\mu, k))) = \\ &= \Psi^{g'(\alpha^{k+1})}(\widehat{\Psi}^{\widehat{g}(\alpha)}(g(\mu), k)) = \widehat{\Psi}^{\widehat{g}(\alpha)}(g(\mu), k + 1). \end{aligned}$$

b) \implies c) The first statement results from b) if we take $\alpha^0 = (0, \dots, 0)$ and $k = 0$. In order to prove the second statement, let $\mu \in \mathbf{B}^n$ and $\rho \in \overline{P}_n$ be arbitrary, thus (1) holds with $(t_k) \in \text{Seq}, \rho(t_0), \dots, \rho(t_k), \dots \in$

$\overline{\Pi}_n$. If $\forall t \in \mathbf{R}, \rho(t) = (0, \dots, 0)$ the statement to prove takes the form $g(\mu) = g(\mu)$ so that we can suppose now that a finite or an infinite number of $\rho(t_k)$ are $\neq (0, \dots, 0)$. In the case $\forall k \in \mathbf{N}, \rho(t_k) \neq (0, \dots, 0)$ that does not restrict the generality of the proof, we have that

$$\tilde{g}'(\rho)(t) = g'(\rho(t_0))\chi_{\{t_0\}}(t) \oplus \dots \oplus g'(\rho(t_k))\chi_{\{t_k\}}(t) \oplus \dots \quad (6)$$

is an element of \overline{P}_n and

$$\begin{aligned} g(\Phi^\rho(\mu, t)) &= g(\mu\chi_{(-\infty, t_0)}(t) \oplus \widehat{\Phi}^\alpha(\mu, 0)\chi_{[t_0, t_1)}(t) \oplus \dots \\ &\quad \dots \oplus \widehat{\Phi}^\alpha(\mu, k)\chi_{[t_k, t_{k+1})}(t) \oplus \dots) = \\ &= g(\mu)\chi_{(-\infty, t_0)}(t) \oplus g(\widehat{\Phi}^\alpha(\mu, 0))\chi_{[t_0, t_1)}(t) \oplus \dots \\ &\quad \dots \oplus g(\widehat{\Phi}^\alpha(\mu, k))\chi_{[t_k, t_{k+1})}(t) \oplus \dots = \\ &= g(\mu)\chi_{(-\infty, t_0)}(t) \oplus \widehat{\Psi}^{\widehat{g}'(\alpha)}(g(\mu), 0)\chi_{[t_0, t_1)}(t) \oplus \dots \\ &\quad \dots \oplus \widehat{\Psi}^{\widehat{g}'(\alpha)}(g(\mu), k)\chi_{[t_k, t_{k+1})}(t) \oplus \dots = \Psi^{\tilde{g}'(\rho)}(g(\mu), t). \end{aligned}$$

c) \implies a) Let $\nu, \mu \in \mathbf{B}^n$ be arbitrary and fixed and we consider $\rho \in \overline{P}_n$ given by (1), with $(t_k) \in Seq$ fixed, $\rho(t_0) = \nu$ and $\forall k \geq 1, \rho(t_k) \neq (0, \dots, 0)$. We have

$$\begin{aligned} g(\Phi^\rho(\mu, t)) &= \quad (7) \\ &= g(\mu\chi_{(-\infty, t_0)}(t) \oplus \Phi^\nu(\mu)\chi_{[t_0, t_1)}(t) \oplus \widehat{\Phi}^\alpha(\mu, 1)\chi_{[t_1, t_2)}(t) \oplus \dots) = \\ &= g(\mu)\chi_{(-\infty, t_0)}(t) \oplus g(\Phi^\nu(\mu))\chi_{[t_0, t_1)}(t) \oplus g(\widehat{\Phi}^\alpha(\mu, 1))\chi_{[t_1, t_2)}(t) \oplus \dots \end{aligned}$$

Case i) $\nu = (0, \dots, 0)$,

the commutativity of the diagram is equivalent with the first statement of c).

Case ii) $\nu \neq (0, \dots, 0)$,

$$\tilde{g}'(\rho)(t) = g'(\rho(t)) = g'(\nu)\chi_{\{t_0\}}(t) \oplus g'(\rho(t_1))\chi_{\{t_1\}}(t) \oplus \dots,$$

$$\Psi^{\tilde{g}'(\rho)}(g(\mu), t) =$$

$$= g(\mu)\chi_{(-\infty, t_0)}(t) \oplus \Psi^{g'(\nu)}(g(\mu))\chi_{[t_0, t_1)}(t) \oplus \widehat{\Psi}^{\widehat{g}'(\alpha)}(g(\mu), 1)\chi_{[t_1, t_2)}(t) \oplus \dots$$

and from (7), for $t \in [t_0, t_1)$, we obtain

$$g(\Phi^\nu(\mu)) = \Psi^{g'(\nu)}(g(\mu)).$$

■

Definition 17 We consider the functions $\Phi, \Psi : \mathbf{B}^n \rightarrow \mathbf{B}^n$. If $g, g' : \mathbf{B}^n \rightarrow \mathbf{B}^n$ bijective exist such that one of the equivalent properties a), b), c) from Theorem 16 is satisfied, then we say that the couple (g, g') defines an **isomorphism** from $\widehat{\Xi}_\Phi$ to $\widehat{\Xi}_\Psi$, or from $\overline{\Xi}_\Phi$ to $\overline{\Xi}_\Psi$, or from Φ to Ψ . We use the notation $\overline{Iso}(\Phi, \Psi)$ for the set of these couples and we also denote with $\overline{Aut}(\Phi) = \overline{Iso}(\Phi, \Phi)$ the set of the **automorphisms** of $\widehat{\Xi}_\Phi, \overline{\Xi}_\Phi$, or Φ .

Theorem 18 For $\Phi, \Psi, g, g' : \mathbf{B}^n \rightarrow \mathbf{B}^n$, the following statements are equivalent:

a) $\forall \nu \in \mathbf{B}^n$, the diagram

$$\begin{array}{ccc} \mathbf{B}^n & \xrightarrow{\Phi^\nu} & \mathbf{B}^n \\ g \downarrow & & \downarrow g \\ \mathbf{B}^n & \xleftarrow{\Psi^{g'(\nu)}} & \mathbf{B}^n \end{array}$$

is commutative;

b) $\forall \mu \in \mathbf{B}^n, \forall \alpha \in \overline{\Pi}_n, \forall k \in \mathbf{N}_-$,

$$g(\mu) = {}^* \widehat{\Psi}^{g'(\alpha)}(g(\widehat{\Phi}^\alpha(\mu, k)), k);$$

c) $\forall \mu \in \mathbf{B}^n$,

$$g(\mu) = \Psi^{g'(0, \dots, 0)}(g(\mu))$$

and $\forall \mu \in \mathbf{B}^n, \forall \rho \in \overline{P}_n, \forall t \in \mathbf{R}$,

$$g(\mu) = {}^* \widetilde{\Psi}^{g'(\rho)}(g(\Phi^\rho(\mu, t)), t).$$

Proof. a) \implies b) We fix arbitrarily $\mu \in \mathbf{B}^n, \alpha \in \overline{\Pi}_n$ and we use the induction on $k \geq -1$. In the case $k = -1$ the equality to be proved is satisfied

$$g(\mu) = g(\widehat{\Phi}^\alpha(\mu, -1)) = \widehat{\Psi}^{g'(\alpha)}(g(\widehat{\Phi}^\alpha(\mu, -1)), -1),$$

thus we presume that the statement is true for k and we prove it for $k + 1$. We have:

$$\begin{aligned} g(\mu) &= {}^* \widehat{\Psi}^{g'(\alpha)}(g(\widehat{\Phi}^\alpha(\mu, k)), k) = {}^* \widehat{\Psi}^{g'(\alpha)}(\Psi^{g'(\alpha^{k+1})}(g(\Phi^{\alpha^{k+1}}(\widehat{\Phi}^\alpha(\mu, k)))), k) \\ &= {}^* \widehat{\Psi}^{g'(\alpha)}(g(\widehat{\Phi}^\alpha(\mu, k+1)), k+1). \end{aligned}$$

The proof is similar with the proof of Theorem 16. ■

Definition 19 Let be the functions $\Phi, \Psi : \mathbf{B}^n \rightarrow \mathbf{B}^n$. If $g, g' : \mathbf{B}^n \rightarrow \mathbf{B}^n$ bijective exist such that one of the equivalent properties a), b), c) from Theorem 18 is fulfilled, we say that the couple (g, g') defines an **anti-isomorphism** from $\widehat{\Xi}_\Phi$ to $^*\widehat{\Xi}_\Psi$, or from $\overline{\Xi}_\Phi$ to $^*\overline{\Xi}_\Psi$, or from Φ to Ψ . We use the notation $^*\overline{Iso}(\Phi, \Psi)$ for these couples and we also denote with $^*\overline{Aut}(\Phi) = ^*\overline{Iso}(\Phi, \Phi)$ the set of the **anti-automorphisms** of $\widehat{\Xi}_\Phi, \overline{\Xi}_\Phi$ or Φ .

5 Symmetry and anti-symmetry

Remark 20 The fact that $(1_{\mathbf{B}^n}, 1_{\mathbf{B}^n}) \in \overline{Aut}(\Phi)$ implies $\overline{Aut}(\Phi) \neq \emptyset$, but all of $\overline{Iso}(\Phi, \Psi), ^*\overline{Iso}(\Phi, \Psi)$ and $^*\overline{Aut}(\Phi)$ may be empty.

Definition 21 Let be $\Phi, \Psi : \mathbf{B}^n \rightarrow \mathbf{B}^n, \Phi \neq \Psi$. If $\overline{Iso}(\Phi, \Psi) \neq \emptyset$, then $\widehat{\Xi}_\Phi, \widehat{\Xi}_\Psi; \overline{\Xi}_\Phi, \overline{\Xi}_\Psi; \Phi, \Psi$ are called **symmetrical**, or **conjugated**; if $^*\overline{Iso}(\Phi, \Psi) \neq \emptyset$, then $\widehat{\Xi}_\Phi, ^*\widehat{\Xi}_\Psi; \overline{\Xi}_\Phi, ^*\overline{\Xi}_\Psi; \Phi, \Psi$ are called **anti-symmetrical**, or **anti-conjugated**.

If $\text{card}(\overline{Aut}(\Phi)) > 1$, then $\widehat{\Xi}_\Phi, \overline{\Xi}_\Phi$ and Φ are called **symmetrical** and if $^*\overline{Aut}(\Phi) \neq \emptyset$, then $\widehat{\Xi}_\Phi, \overline{\Xi}_\Phi$ and Φ are called **anti-symmetrical**.

Remark 22 The symmetry of Φ, Ψ means that $(g, g') \in \overline{Iso}(\Phi, \Psi)$ maps the transfers $\mu \rightarrow \Phi^\nu(\mu)$ in transfers $g(\mu) \rightarrow g(\Phi^\nu(\mu)) = \Psi^{g'(\nu)}(g(\mu))$; the situation when Φ is symmetrical and $(g, g') \in \overline{Aut}(\Phi)$ is similar. Anti-symmetry may be understood as mirroring: $(g, g') \in ^*\overline{Iso}(\Phi, \Psi)$ maps the transfers (or arrows) $\mu \rightarrow \Phi^\nu(\mu)$ in transfers $g(\mu) \leftarrow g(\Phi^\nu(\mu)) = \Psi^{g'(\nu)}(g(\mu))$ and similarly for $(g, g') \in ^*\overline{Aut}(\Phi)$.

Theorem 23 Let be $\Phi, \Psi : \mathbf{B}^n \rightarrow \mathbf{B}^n$.

- a) If $(g, g') \in \overline{Iso}(\Phi, \Psi)$, then $(g^{-1}, g'^{-1}) \in \overline{Iso}(\Psi, \Phi)$.
- b) If $(g, g') \in ^*\overline{Iso}(\Phi, \Psi)$, then $(g^{-1}, g'^{-1}) \in ^*\overline{Iso}(\Psi, \Phi)$.

Proof. a) The hypothesis states that $\forall \nu \in \mathbf{B}^n$, the diagram

$$\begin{array}{ccc} \mathbf{B}^n & \xrightarrow{\Phi^\nu} & \mathbf{B}^n \\ g \downarrow & & \downarrow g \\ \mathbf{B}^n & \xrightarrow{\Psi^{g'(\nu)}} & \mathbf{B}^n \end{array}$$

commutes, with g, g' bijective. We fix arbitrarily $\nu \in \mathbf{B}^n, \mu \in \mathbf{B}^n$. We denote $\mu' = g(\mu), \nu' = g'(\nu)$ and we note that

$$g^{-1}(\Psi^{\nu'}(\mu')) = \Phi^{g'^{-1}(\nu')}(g^{-1}(\mu')). \quad (8)$$

As ν, μ were chosen arbitrarily and on the other hand, when ν runs in \mathbf{B}^n , ν' runs in \mathbf{B}^n and when μ runs in \mathbf{B}^n , μ' runs in \mathbf{B}^n , we infer that (8) is equivalent with the commutativity of the diagram

$$\begin{array}{ccc} \mathbf{B}^n & \xrightarrow{\Psi^{\nu'}} & \mathbf{B}^n \\ g^{-1} \downarrow & & \downarrow g^{-1} \\ \mathbf{B}^n & \xrightarrow{\Phi^{g'^{-1}(\nu')}} & \mathbf{B}^n \end{array}$$

for any $\nu' \in \mathbf{B}^n$. We have proved that $(g^{-1}, g'^{-1}) \in \overline{Iso}(\Psi, \Phi)$.

b) By hypothesis $\forall \nu \in \mathbf{B}^n$, the diagram

$$\begin{array}{ccc} \mathbf{B}^n & \xrightarrow{\Phi^\nu} & \mathbf{B}^n \\ g \downarrow & & \downarrow g \\ \mathbf{B}^n & \xrightarrow{\Psi^{g'(\nu)}} & \mathbf{B}^n \end{array}$$

is commutative, g, g' bijective and we prove that $\forall \nu' \in \mathbf{B}^n$, the diagram

$$\begin{array}{ccc} \mathbf{B}^n & \xrightarrow{\Psi^{\nu'}} & \mathbf{B}^n \\ g^{-1} \downarrow & & \downarrow g^{-1} \\ \mathbf{B}^n & \xleftarrow{\Phi^{g'^{-1}(\nu')}} & \mathbf{B}^n \end{array}$$

is commutative. ■

Theorem 24 $\overline{Aut}(\Phi)$ is a group relative to the law: $\forall (g, g') \in \overline{Aut}(\Phi)$, $\forall (h, h') \in \overline{Aut}(\Phi)$,

$$(h, h') \circ (g, g') = (h \circ g, h' \circ g').$$

Proof. The fact that $\forall (g, g') \in \overline{Aut}(\Phi)$, $\forall (h, h') \in \overline{Aut}(\Phi)$, $(h \circ g, h' \circ g') \in \overline{Aut}(\Phi)$ is proved like this: $\forall \nu \in \mathbf{B}^n$,

$$\begin{aligned} (h \circ g) \circ \Phi^\nu &= h \circ (g \circ \Phi^\nu) = h \circ (\Phi^{g'(\nu)} \circ g) = (h \circ \Phi^{g'(\nu)}) \circ g = \\ &= (\Phi^{h'(g'(\nu))} \circ h) \circ g = \Phi^{(h' \circ g')(\nu)} \circ (h \circ g); \end{aligned}$$

the fact that $(1_{\mathbf{B}^n}, 1_{\mathbf{B}^n}) \in \overline{Aut}(\Phi)$ was mentioned before; and the fact that $\forall (g, g') \in \overline{Aut}(\Phi)$, $(g^{-1}, g'^{-1}) \in \overline{Aut}(\Phi)$ was shown at Theorem 23 a). ■

Definition 25 Any subgroup $G \subset \overline{Aut}(\Phi)$ with $\text{card}(G) > 1$ is called a *group of symmetry* of $\widehat{\Xi}_\Phi$, of Ξ_Φ or of Φ .

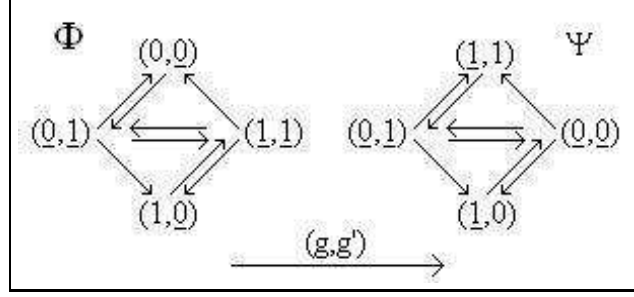

Figure 4: Symmetrical systems, Example 26

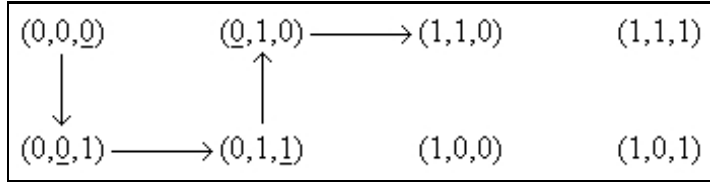

Figure 5: Symmetrical system, Example 27

6 Examples

Example 26 $\Phi, \Psi : \mathbf{B}^2 \rightarrow \mathbf{B}^2$ are given by, see Figure 4

$$\forall (\mu_1, \mu_2) \in \mathbf{B}^2, \Phi(\mu_1, \mu_2) = (\mu_1 \oplus \mu_2, \overline{\mu_2}),$$

$$\forall (\mu_1, \mu_2) \in \mathbf{B}^2, \Psi(\mu_1, \mu_2) = (\overline{\mu_1}, \overline{\mu_1} \overline{\mu_2} \cup \mu_1 \mu_2)$$

and the bijections $g, g' : \mathbf{B}^2 \rightarrow \mathbf{B}^2$ are $\forall (\mu_1, \mu_2) \in \mathbf{B}^2$,

$$g(\mu_1, \mu_2) = (\overline{\mu_2}, \overline{\mu_1}),$$

$$g'(\mu_1, \mu_2) = (\mu_2, \mu_1)$$

(in order to understand the choice of g' , to be remarked in Figure 4 the positions of the underlined coordinates for Φ and Ψ). Φ and Ψ are conjugated.

Example 27 The system from Figure 5 is symmetrical and a group of symmetry is generated by the couples $(g, 1_{\mathbf{B}^3}), (u, 1_{\mathbf{B}^3}), (v, 1_{\mathbf{B}^3})$, see Table 2; g, u, v are transpositions that permute the isolated fixed points $(1, 0, 0), (1, 0, 1), (1, 1, 1)$.

(μ_1, μ_2, μ_3)	$1_{\mathbf{B}^3}$	g	u	v
(0, 0, 0)	(0, 0, 0)	(0, 0, 0)	(0, 0, 0)	(0, 0, 0)
(0, 0, 1)	(0, 0, 1)	(0, 0, 1)	(0, 0, 1)	(0, 0, 1)
(0, 1, 0)	(0, 1, 0)	(0, 1, 0)	(0, 1, 0)	(0, 1, 0)
(0, 1, 1)	(0, 1, 1)	(0, 1, 1)	(0, 1, 1)	(0, 1, 1)
(1, 0, 0)	(1, 0, 0)	(1, 0, 0)	(1, 0, 1)	(1, 1, 1)
(1, 0, 1)	(1, 0, 1)	(1, 1, 1)	(1, 0, 0)	(1, 0, 1)
(1, 1, 0)	(1, 1, 0)	(1, 1, 0)	(1, 1, 0)	(1, 1, 0)
(1, 1, 1)	(1, 1, 1)	(1, 0, 1)	(1, 1, 1)	(1, 0, 0)

Table 2

Example 28 The function $\Phi : \mathbf{B}^2 \rightarrow \mathbf{B}^2$ defined by $\forall \mu \in \mathbf{B}^2, \Phi(\mu_1, \mu_2) = (\overline{\mu_1}, \overline{\mu_2})$ fulfills for $\nu \in \mathbf{B}^2$:

$$\begin{aligned}
\Phi^\nu(\mu_1, \mu_2) &= (\overline{\nu_1}\mu_1 \oplus \nu_1\overline{\mu_1}, \overline{\nu_2}\mu_2 \oplus \nu_2\overline{\mu_2}), \\
(\Phi^\nu \circ \Phi^\nu)(\mu_1, \mu_2) &= (\overline{\nu_1}\Phi_1^{\nu_1}(\mu_1, \mu_2) \oplus \nu_1\overline{\Phi_1^{\nu_1}(\mu_1, \mu_2)}, \\
&\quad \overline{\nu_2}\Phi_2^{\nu_2}(\mu_1, \mu_2) \oplus \nu_2\overline{\Phi_2^{\nu_2}(\mu_1, \mu_2)}) \\
&= (\overline{\nu_1}(\overline{\nu_1}\mu_1 \oplus \nu_1\overline{\mu_1}) \oplus \nu_1(\overline{\nu_1}\mu_1 \oplus \nu_1\overline{\mu_1} \oplus 1), \\
&\quad \overline{\nu_2}(\overline{\nu_2}\mu_2 \oplus \nu_2\overline{\mu_2}) \oplus \nu_2(\overline{\nu_2}\mu_2 \oplus \nu_2\overline{\mu_2} \oplus 1)) \\
&= ((\nu_1 \oplus 1)\mu_1 \oplus \nu_1(\mu_1 \oplus 1) \oplus \nu_1, (\nu_2 \oplus 1)\mu_2 \oplus \nu_2(\mu_2 \oplus 1) \oplus \nu_2) \\
&= (\nu_1\mu_1 \oplus \mu_1 \oplus \nu_1\mu_1 \oplus \nu_1 \oplus \nu_1, \nu_2\mu_2 \oplus \mu_2 \oplus \nu_2\mu_2 \oplus \nu_2 \oplus \nu_2) = (\mu_1, \mu_2),
\end{aligned}$$

thus $(1_{\mathbf{B}^2}, 1_{\mathbf{B}^2}) \in \overline{*Aut}(\Phi)$ and Φ is anti-symmetrical. The state portrait of Φ was drawn in Figure 1 c).

Notation 29 Let $\sigma : \{1, \dots, n\} \rightarrow \{1, \dots, n\}$ be a bijection. We use the notation $\pi_\sigma : \mathbf{B}^n \rightarrow \mathbf{B}^n$ for the bijection given by $\forall \mu \in \mathbf{B}^n$,

$$\pi_\sigma(\mu_1, \dots, \mu_n) = (\mu_{\sigma(1)}, \dots, \mu_{\sigma(n)}).$$

Definition 30 Any of $\widehat{\Xi}_\Phi, \overline{\Xi}_\Phi$ and $\Phi : \mathbf{B}^n \rightarrow \mathbf{B}^n$ is called **symmetrical relative to the coordinates** if the bijection σ exists, $\sigma \neq 1_{\{1, \dots, n\}}$ such that $(\pi_\sigma, \pi_\sigma) \in \overline{Aut}(\Phi)$.

Example 31 We consider the function $\Phi : \mathbf{B}^3 \rightarrow \mathbf{B}^3$ defined by $\forall \mu \in \mathbf{B}^3, \Phi(\mu_1, \mu_2, \mu_3) = (\mu_2\mu_3 \oplus \mu_1 \oplus \mu_2, \mu_1\mu_3 \oplus \mu_2 \oplus \mu_3, \mu_1\mu_2 \oplus \mu_1 \oplus \mu_3)$ and the permutation $\sigma : \{1, 2, 3\} \rightarrow \{1, 2, 3\}, \sigma = \begin{pmatrix} 1 & 2 & 3 \\ \sigma(1) & \sigma(2) & \sigma(3) \end{pmatrix} = \begin{pmatrix} 1 & 2 & 3 \\ 3 & 1 & 2 \end{pmatrix}$. A group of symmetry of $\overline{\Xi}_\Phi$ is represented by $G = \{(1_{\mathbf{B}^3}, 1_{\mathbf{B}^3}), (\pi_\sigma, \pi_\sigma), (\pi_{\sigma\sigma}, \pi_{\sigma\sigma})\}$. We have given in Figure 6 the state portrait of Φ .

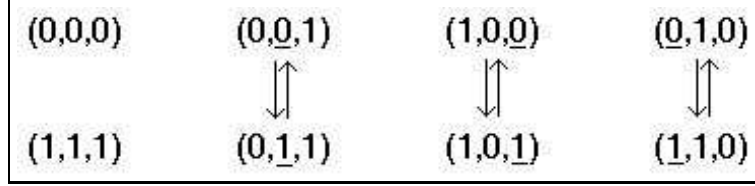

Figure 6: System that is symmetrical relative to the coordinates, Example 31

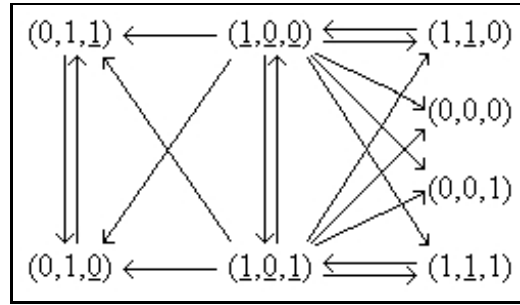

Figure 7: Φ has the automorphism $(\theta^{(0,0,1)}, 1_{\mathbf{B}^3})$, Example 34

Notation 32 For $\lambda \in \mathbf{B}^n$, we denote by $\theta^\lambda : \mathbf{B}^n \rightarrow \mathbf{B}^n$ the translation of vector $\lambda : \forall \mu \in \mathbf{B}^n$,

$$\theta^\lambda(\mu) = \mu \oplus \lambda.$$

Definition 33 If $(\theta^\lambda, g') \in \overline{\text{Aut}}(\Phi)$ holds for some $(\theta^\lambda, g') \neq (1_{\mathbf{B}^n}, 1_{\mathbf{B}^n})$, we say that any of $\widehat{\Xi}_\Phi$, $\overline{\Xi}_\Phi$ and Φ is **symmetrical relative to translations**.

Example 34 In Figure 7 we have the system with Φ given by Table 3

(μ_1, μ_2, μ_3)	Φ
$(0, 0, 0)$	$(0, 0, 0)$
$(0, 0, 1)$	$(0, 0, 1)$
$(0, 1, 0)$	$(0, 1, 1)$
$(0, 1, 1)$	$(0, 1, 0)$
$(1, 0, 0)$	$(0, 1, 1)$
$(1, 0, 1)$	$(0, 1, 0)$
$(1, 1, 0)$	$(1, 0, 0)$
$(1, 1, 1)$	$(1, 0, 1)$

Table 3

and $(\theta^{(0,0,1)}, 1_{\mathbf{B}^3}) \in \overline{\text{Aut}}(\Phi)$, as resulting from the state portrait.

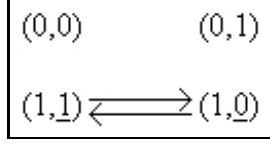

Figure 8: Φ is symmetrical relative to translations with $(0,0)$, Example 35

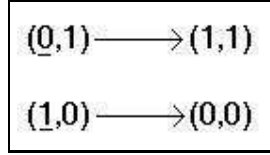

Figure 9: Function Φ that is self dual, $(\theta^{(1,1)}, 1_{\mathbf{B}^2}) \in \overline{\text{Aut}}(\Phi)$, Example 36

Example 35 In Table 4 we have a function $\Phi : \mathbf{B}^2 \rightarrow \mathbf{B}^2$ for which four functions $g'_1, g'_2, g'_3, g'_4 : \mathbf{B}^2 \rightarrow \mathbf{B}^2$ exist:

(μ_1, μ_2)	Φ	g'_1	g'_2	g'_3	g'_4
$(0,0)$	$(0,0)$	$(0,0)$	$(1,0)$	$(0,0)$	$(1,0)$
$(0,1)$	$(0,1)$	$(0,1)$	$(0,1)$	$(1,1)$	$(1,1)$
$(1,0)$	$(1,1)$	$(1,0)$	$(0,0)$	$(1,0)$	$(0,0)$
$(1,1)$	$(1,0)$	$(1,1)$	$(1,1)$	$(0,1)$	$(0,1)$

Table 4

such that $(1_{\mathbf{B}^2}, g'_1), (1_{\mathbf{B}^2}, g'_2), (1_{\mathbf{B}^2}, g'_3), (1_{\mathbf{B}^2}, g'_4) \in \overline{\text{Aut}}(\Phi)$. The state portrait of Φ is drawn Figure 8.

Example 36 The system from Figure 9 is symmetrical relative to translations, since it has the group of symmetry $G = \{(1_{\mathbf{B}^2}, 1_{\mathbf{B}^2}), (\theta^{(1,1)}, 1_{\mathbf{B}^2})\}$. Φ is self-dual $\Phi = \Phi^*$, where the dual Φ^* of Φ is defined by $\Phi^*(\mu) = \Phi(\overline{\mu})$.

Example 37 Functions $\Phi : \mathbf{B}^2 \rightarrow \mathbf{B}^2$ exist, see Figure 10 that are invariant relative to the translations with any $\lambda \in \mathbf{B}^2$, thus their group of symmetry is $G = \{(1_{\mathbf{B}^2}, 1_{\mathbf{B}^2}), (\theta^{(0,1)}, 1_{\mathbf{B}^2}), (\theta^{(1,0)}, 1_{\mathbf{B}^2}), (\theta^{(1,1)}, 1_{\mathbf{B}^2})\}$. The fact that $(\theta^{(1,1)}, 1_{\mathbf{B}^2}) \in G$ shows that all these functions: $\Phi(\mu) = (\mu_1, \mu_2)$, $\Phi(\mu) = (\mu_1, \overline{\mu_2})$, $\Phi(\mu) = (\overline{\mu_1}, \mu_2)$, $\Phi(\mu) = (\overline{\mu_1}, \overline{\mu_2})$ are self-dual, $\Phi = \Phi^*$.

Example 38 The group of symmetry G of the system from Figure 11 has four elements given by

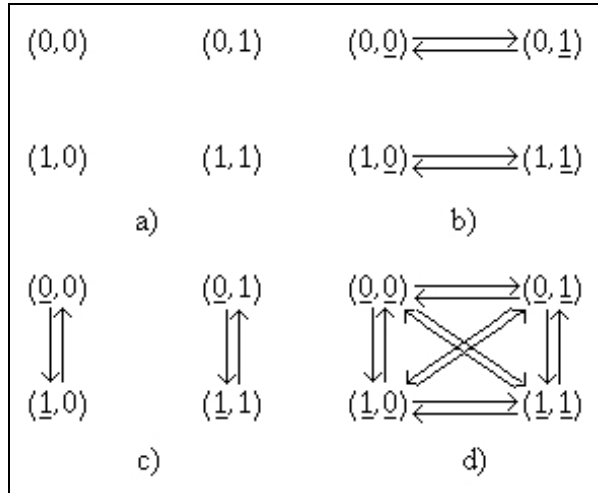

Figure 10: Functions Φ that are self dual, $(\theta^{(1,1)}, 1_{\mathbf{B}^2}) \in \overline{\text{Aut}}(\Phi)$, Example 37

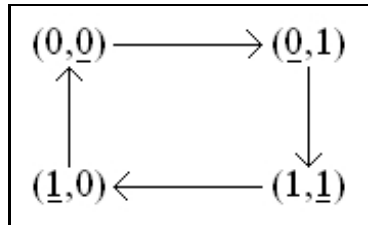

Figure 11: Symmetry including symmetry relative to translations, Example 38

(μ_1, μ_2)	$1_{\mathbf{B}^2}$	g	h	$\theta^{(1,1)}$
(0, 0)	(0, 0)	(0, 1)	(1, 0)	(1, 1)
(0, 1)	(0, 1)	(1, 1)	(0, 0)	(1, 0)
(1, 0)	(1, 0)	(0, 0)	(1, 1)	(0, 1)
(1, 1)	(1, 1)	(1, 0)	(0, 1)	(0, 0)

Table 5

and we remark that $h = g^{-1}, \theta^{(1,1)} = (\theta^{(1,1)})^{-1}$ hold. On the other hand

(ν_1, ν_2)	$(1_{\mathbf{B}^2})'$	g'	h'	$(\theta^{(1,1)})'$
(0, 0)	(0, 0)	(0, 0)	(0, 0)	(0, 0)
(0, 1)	(0, 1)	(1, 0)	(1, 0)	(0, 1)
(1, 0)	(1, 0)	(0, 1)	(0, 1)	(1, 0)
(1, 1)	(1, 1)	(1, 1)	(1, 1)	(1, 1)

Table 6

G has a proper subgroup $G' = \{(1_{\mathbf{B}^2}, 1_{\mathbf{B}^2}), (\theta^{(1,1)}, 1_{\mathbf{B}^2})\}$, showing that $\Phi = \Phi^*$ like previously.

7 Conclusions

The paper defines the universal semi-regular autonomous asynchronous systems and the universal anti-semi-regular autonomous asynchronous systems. It also defines and characterizes the isomorphisms (automorphisms) and the anti-isomorphisms (anti-automorphisms) of these systems. Symmetry is defined as the existence of such isomorphisms (automorphisms), while anti-symmetry is defined as the existence of such anti-isomorphisms (anti-automorphisms). Many examples are given. A by-pass product in this study is anti-symmetry, that is related with systems having the cause in the future and the effect in the present. Another by-pass product consists in semi-regularity, since important examples of isomorphisms (automorphisms) are of semi-regular systems only, they do not keep progressiveness and regularity [2], [3].

References

- [1] Yu. A. Kuznetsov, *Elements of Applied Bifurcation Theory, Second Edition*, Springer, 1997.
- [2] S. E. Vlad, *Boolean dynamical systems*, ROMAI Journal, Vol. 3, Nr. 2, 2007.
- [3] S. E. Vlad, *Universal Regular Autonomous Asynchronous Systems: Fixed Points, Equivalencies and Dynamical Bifurcations*, ROMAI Journal, Vol. 5, Nr. 1, 2009.