

A quick proof of the classification of real Lie superalgebras

Biswajit Ransingh and K C Pati

Abstract

This article classifies the real forms of Lie Superalgebra by Vogan diagrams, developing Borel and de Seibenthal theorem of semisimple Lie algebras for Lie superalgebras. A Vogan diagram is a Dynkin diagram of triplet $(\mathfrak{g}_C, \mathfrak{h}_{\overline{\sigma}}, \Delta^+)$, where \mathfrak{g}_C is a real Lie superalgebra, $\mathfrak{h}_{\overline{\sigma}}$ cartan subalgebra, Δ^+ positive root system. Although the classification of real forms of contragradient Lie superalgebras is already done. But our method is a quicker one to classify.

2010 AMS Subject Classification : 17B05, 17B22, 17B40

Keywords : Lie superalgebras, Vogan diagrams

1 Introduction

For a complex semi-simple Lie algebra \mathfrak{g} , it is well known that the conjugacy classes of real forms of \mathfrak{g} are in one to one correspondence with the conjugacy classes of involutions of \mathfrak{g} , if we associate to a real form $\mathfrak{g}_{\mathbb{R}}$ one of its Cartan involutions θ . Using a suited pair $(\mathfrak{h}, \overline{\Pi})$ of a Cartan subalgebra \mathfrak{h} and a basis $\overline{\Pi}$ of the associated root system, an involution is described by a "Vogan diagram".

Knapp [4] brought Vogan diagrams of simple Lie algebras into the light to represent the real forms of the complex simple Lie algebras. Batra [2, 3] developed a corresponding theory of Vogan diagrams for almost compact real forms of indecomposable nontwisted affine Kac-Moody Lie algebras. Similar theory is also developed to find out the Vogan diagrams of hyperbolic Kac-Moody algebras [8].

A Vogan diagram is a Dynkin diagram with some additional information as follows. The 2-elements orbits under θ (Cartan involution) are exhibited by joining the corresponding simple roots by a double arrow and the 1-element orbit is painted in black (respectively, not painted), if the corresponding imaginary simple root is noncompact (respectively compact).

The real form is defined as a real Lie superalgebra such that its complexification is the original complex Lie superalgebra. It can be seen easily that every standard real form is naturally associated to an antilinear involutive automorphism of the complex Lie superalgebra.

The classification of real semisimple Lie algebras will use maximally compact and split Cartan subalgebras. The Vogan diagram is based on the classification of maximally compact Cartan subalgebras. Recently similar work has been done using Vogan superdiagrams to classify the real forms of contragradient Lie superalgebras [5], where the extended Dynkin diagrams of Lie superalgebra is used. But our method uses the ordinary Dynkin diagram as done by Knapp [4]. In this article we construct all the real forms of Lie superalgebras by Vogan diagrams.

2 Real forms and Vogan diagrams

Proposition 1 ([7] Proposition 1.4). *Let \mathfrak{g} be a complex classical Lie superalgebra and let C be an involutive semimorphism of \mathfrak{g} . Then $\mathfrak{g}_C = \{x + Cx | x \in \mathfrak{g}\}$ is a real classical Lie superalgebra.*

Proposition 2 ([7] Proposition 1.5). *If \mathfrak{g}_C is a real classical Lie superalgebra, its complexification $\mathfrak{g} = \mathfrak{g}_C \otimes \mathbb{C}$ is a Lie superalgebra which is either classical or direct sum of two isomorphic ideals which are classical.*

Theorem 3 ([7] Theorem 4). *Up to isomorphism, the real forms of the classical Lie superalgebras are uniquely determined by the real form $\mathfrak{g}_{\overline{\sigma}_C}$ of the Lie subalgebra $\mathfrak{g}_{\overline{\sigma}}$.*

The real form is said to be standard (graded) when the real structure is standard (graded). Let \mathfrak{g}_C be a real form of \mathfrak{g} and let ω be the corresponding complex conjugation. Then $\omega|_{\mathfrak{g}_{\overline{0}}}$ is an antilinear involution of the Lie algebra $\mathfrak{g}_{\overline{0}}$. Hence there is a corresponding Cartan decomposition $\mathfrak{g}_{\overline{0}} = \mathfrak{t}_{\overline{0}} \oplus \mathfrak{p}_{\overline{0}}$.

Definition 4. The Vogan diagram of Lie superalgebras is the Dynkin diagram of the basic Lie superalgebras. In addition to that

- (a) The vertices fixed by the automorphism (it's Cartan involution for even part) of the even part is painted (or unpainted) depending whether the the root is noncompact (or compact).
- (b) Label the 2- elements orbit by the diagram automorphism indicated with two sided arrow.
- (c) The odd root remain unchanged.

We will modify the Borel and de Siebenthal Theorem for Lie superalgebra.

Theorem 5 (Main Theorem). *Let \mathfrak{g}_C be a non complex real Lie superalgebra and Let the Vogan diagram of \mathfrak{g}_C be given that corresponding to the triple $(\mathfrak{g}_C, \mathfrak{h}_0, \Delta^+)$. Then \exists a simple root system Π' for $\Delta = \Delta(\mathfrak{g}, \mathfrak{h})$, with corresponding positive system Δ^+ , such that $(\mathfrak{g}_C, \mathfrak{h}_{\overline{0}}, \Delta^+)$ is a triple and there is at most two painted simple root in its Vogan diagrams of $\mathfrak{sl}(m, n), D(m, n)$ and at most three painted vertices in $D(2, 1; \alpha)$. Furthermore suppose the automorphism associated with the Vogan diagram is the identity, that $\Pi' = \alpha_1, \dots, \alpha_l$ and that $\omega_1, \dots, \omega_l$ is the dual basis for each even part such that $\langle \omega_j, \alpha_k \rangle = \delta_{jk} / \epsilon_{kk}$, where ϵ_{kk} is the diagonal entries to make Cartan matrix symmetric. Then the double painted simple root of even parts may be chosen so that there is no i' with $\langle \omega_i - \omega_{i'}, \omega_{i'} \rangle > 0$ for each even part.*

Proof of Main Theorem.

Proof. We know $\mathfrak{g} = \mathfrak{g}_{\overline{0}} \oplus \mathfrak{g}_{\overline{1}}$. The positive even root system Δ_0^+ can be written as

$$\Delta_0^+ = \Delta_{01}^+ \cup \Delta_{02}^+$$

where Δ_{01}^+ are the even positive root system for simple root system formed by e_i basis and Δ_{02}^+ are for δ_j basis. For the even part, we take $\langle \omega_i, \alpha_j \rangle = \delta_{ij} / \epsilon_{kk}$. This makes the Cartan matrix symmetric and so that we can get the inverse of Cartan matrix of A_m and A_n for $\mathfrak{sl}(m, n)$ Lie superalgebra. Similarly construction will follows for other Lie superalgebras. Each inverse for even part is associated with the dual basis ω . The symmetrizable condition of Kac-Cartan matrix gives $S = \epsilon_{kk} A$, where S is the symmetric Cartan matrix. The below table gives the values of ϵ_{kk} for different superalgebras.

Lie superalgebra	ϵ_{kk}
$\mathfrak{sl}(m, n)$	$(1, \dots, 1, -1, \dots, -1)$
$B(m, n)$	$(1, \dots, 1, -1, \dots, -1, -2)$
$B(0, n)$	$1, \dots, 1, 2$
$C(n)$	$(-1, 1, \dots, 1, \frac{1}{2})$
$D(m, n)$	$(1, \dots, 1, -1, -1, \dots, -1, -1, -1)$
$D(2, 1; \alpha)$	$(1, -1, \frac{1}{2})$
$F(4)$	$(-1, 1, \frac{1}{2})$
$G(3)$	$(-\frac{1}{2}, 1, \frac{1}{3},)$

Taking suitable normalization condition for each type of Lie superalgebras and from the two Lemmas 6.97 and 6.98 [4] we get redundancy test for each even part. So now the Vogan diagram of Lie superalgebras becomes two painted vertices Vogan diagram for $\mathfrak{sl}(m, n), D(m, n)$ and three painted for $D(2, 1; \alpha)$. \square

In fact from the results of Main theorem the following Corollary is immediate.

Corollary 6. The number of painted vertices of the basic real Lie superalgebra by Vogan diagram is number of even parts of the corresponding Lie superalgebra.

2.1 Equivalence of Vogan diagrams

A reflection change the colors of neighbor to opposite color except the odd root and change neighbor color to opposite if it is a shorter root.

Example 7. The two Vogan diagrams of $C(m)$ are equivalence by above rule.

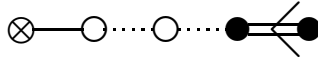
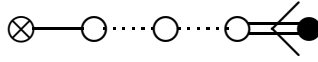

1. $\mathfrak{sl}(m, n)$

The Vogan diagrams and real forms of Lie superalgebras $A(m, n)$ are as follows.

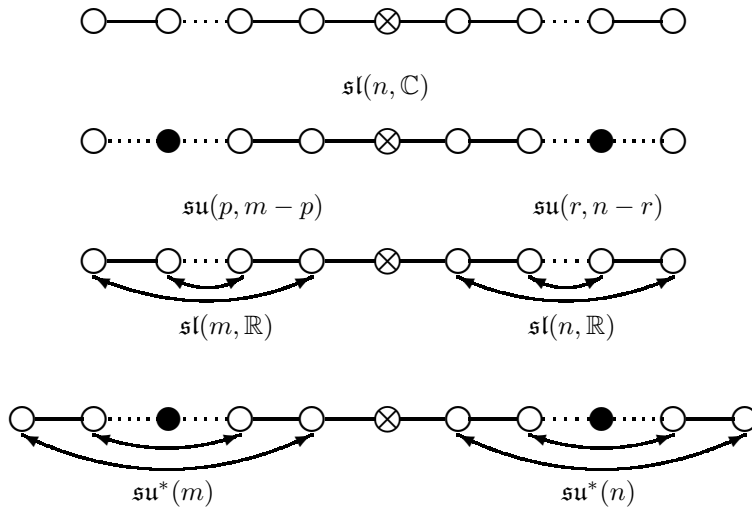

2. $B(m, n)$. The Lie subalgebra of \mathfrak{g}_0 is $C_m \oplus B_n$. The only trivial automorphism of even part of Vogan diagram of $B(m, n)$ is shown below and the real form is $\mathfrak{sp}(2n, \mathbb{R}) \oplus \mathfrak{so}(p, q)$

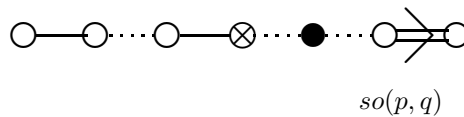

Because of missing of real form of the first even part, we need an additional C_n Dynkin diagram superimposed Vogan diagrams below.

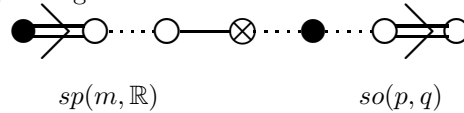

3. $B(0, n)$. The Vogan diagram below is a unpainted diagram but it consists of its own painted vertices on the extreme right.

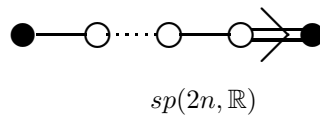

4. $C(m)$.

The unpainted Vogan diagram of $C(m)$ correspondence to the real form $so(2) \oplus sp(m, \mathbb{R})$

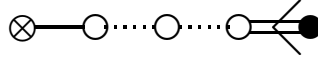

The trivial automorphism of the even part of $C(m)$ makes the Vogan diagram below and the real form is $so(2) \oplus sp(r, s)$

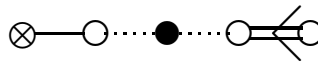

5. $D(m, n)$. The Lie subalgebra of \mathfrak{g}_0 is $C_m \oplus D_n$.

The trivial involution for the Vogan diagram of $D(m, n)$ is given below and the real form of this diagram is $sp(r, s) \oplus so^*(2p)$.

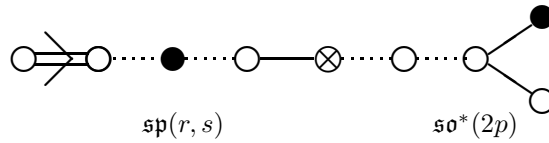

The below Vogan diagram is formed by the nontrivial and trivial involution with associated real form is the same $sp(m, \mathbb{R}) \oplus so(p, q)$.

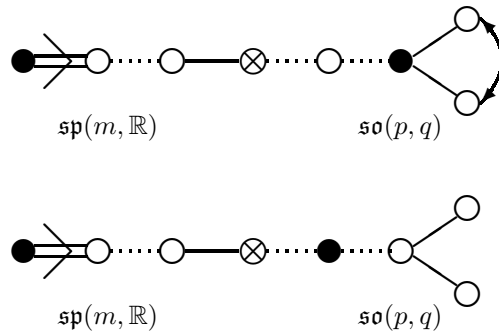

6. $D(2, 1; \alpha)$.

The unpainted and no two element orbit Vogan diagram is given below with the real form. Since we can get only the real form $su(2) \oplus su(2)$ from ordinary Vogan diagram

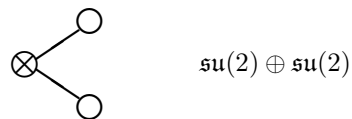

So our requisite Vogan diagrams for the suitable real forms are

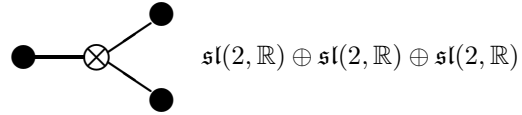
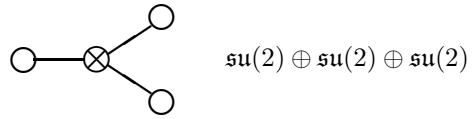

The nontrivial involution of the Dynkin diagram of $D(2, 1; \alpha)$ makes the following Vogan diagram as shown below.

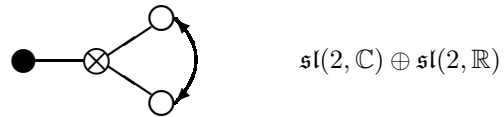

7. F(4). From the Dynkin diagram we can get only the real form $\mathfrak{so}(7)$ and the Vogan diagram

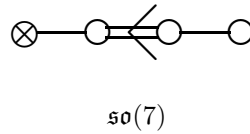

we add the extra even part root to get the desired real forms and Vogan diagrams.

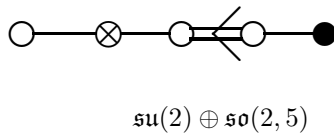
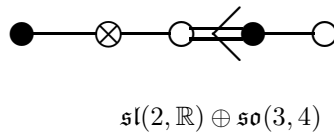
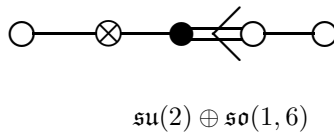
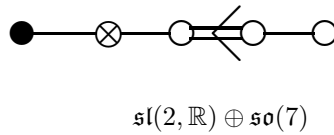

8. $G(3)$.

The Vogan diagram of $G(3)$ with real form $\mathfrak{sl}(2, \mathbb{R}) \oplus G_{2,0}$ and $\mathfrak{sl}(2, \mathbb{R}) \oplus G_{2,2}$ are

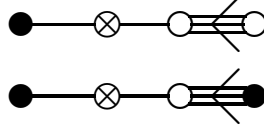

Acknowledgement: The authors thank National Board of Higher Mathematics, India (Project Grant No. 48/3/2008-R&DII/196-R) for financial support.

References

[1] Knapp A.W., A quick proof of the classification of simple real Lie algebra, Proc. American Math. Society, 124(10) (1996).

[2] Batra P, *Invariant of Real forms of Affine Kac-Moody Lie algebras*, Journal of Algebra 223, 208-236 (2000).

[3] Batra P, *Vogan diagrams of affine Kac-Moody algebras*, Journal of Algebra 251, 80-97 (2002).

[4] Knapp A.W., *Lie groups beyond an Introduction*, Second Edition.

[5] Meng-Kiat Chuah, *Cartan automorphisms and Vogan superdiagrams*, Math.Z. 273, 793-800 (2012).

[6] Pati K.C., Parashar, D. *Satake superdiagrams, real forms and Iwasawa decomposition of classical Lie superalgebras*, J. Phys. A 31, 767-778 (1998)

[7] Parker M, *Classification of real simple Lie superalgebras of classical type*, J. Math.Phys. 21(4), April (1980).

[8] Ransingh B and Pati K.C., *Vogan diagrams of some hyperbolic Kac-Moody algebras*, arXiv:1205.3724 [math.RT] (2012).

Biswajit Ransingh, Harish Chandra Research Institute, Allahabad(INDIA) 211019, email-bransingh@gmail.com

K C Pati, Department of Mathematics, National Institute of Technology, Rourkela (India) 769008, email- kcpati@rediffmail.com