

# Constructing a Minimum-Level Phylogenetic Network from a Dense Triplet Set in Polynomial Time

Michel Habib\*, Thu-Hien To\*

April 24, 2022

## Abstract

For a given set  $\mathcal{L}$  of species and a set  $\mathcal{T}$  of triplets on  $\mathcal{L}$ , we want to construct a phylogenetic network which is consistent with  $\mathcal{T}$ , i.e which represents all triplets of  $\mathcal{T}$ . The level of a network is defined as the maximum number of hybrid vertices in its biconnected components. When  $\mathcal{T}$  is dense, there exist polynomial time algorithms to construct level-0, 1, 2 networks [1, 10, 11, 17]. For higher levels, partial answers were obtained in [18] with a polynomial time algorithm for simple networks. In this paper, we detail the first complete answer for the general case, solving a problem proposed in [11] and [17]: for any  $k$  fixed, it is possible to construct a minimum level- $k$  network consistent with  $\mathcal{T}$ , if there is any, in time  $O(|\mathcal{T}|^{k+1}n^{\lfloor \frac{4k}{3} \rfloor + 1})$ <sup>1</sup>.

**Keywords:** phylogenetic networks, level, triplets, reticulations.

## 1 Introduction

The goal of phylogenetics is to reconstruct plausible evolutionary histories of currently living organisms from biological data. To describe evolution, the standard model is a phylogenetic tree in which each leaf is labeled by a species, or a sequence and in which each node having descendants represents a common ancestor of its descendants. However this model is not pertinent for capturing the hybridization, recombination and lateral gene transfer events. So a new model of network was introduced, which allows a species to have more than one parent, see [2]. In recent years, a lot of work has been done on developing methods for computing phylogenetic networks [4, 8, 12, 13]. In [5] a parameter was introduced for phylogenetic networks, which is the number of hybridization nodes per biconnected component and called the level. The level of a network measures its distance to a tree.

It is always difficult to reconstruct the evolution on all data set, so normally it is done on only smaller data. Therefore, it is necessary to recombine them together into one model. A triplet is the smallest tree that contains information on evolution, so a classic problem is to recombine a set of triplets. If there is no constraint on the triplet set, the problem of constructing a level- $k$  phylogenetic network consistent with a triplet set is NP-hard for all levels higher than 0 [10, 17, 19]. However if the triplet set is dense, that is if we require that there is at least one triplet in the data

\*Université Paris Diderot - Paris 7, LIAFA, Case 7014, 75205 Paris Cedex 13, France. E-mail: michel.habib/thu-hien.to/@liafa.jussieu.fr.

<sup>1</sup>This is an improved result of a preliminary version presented at CPM'2009 [15]

for each three species, then the species set is better structured and then it is possible to construct a level-1 [10, 11], or a level-2 [17] network, if one exists, in polynomial time. The following question was first asked in [11]: Does the problem remain polynomial for level- $k$  network for a fixed  $k$ ? We present here an affirmative answer to this question. Our preliminary version in [15] proved that we can construct a minimum level- $k$  network in time  $O(|\mathcal{T}|^{k+1}n^{3k+1})$ . In this version, we present an improved result with a complexity of  $O(|\mathcal{T}|^{k+1}n^{\lfloor \frac{4k}{3} \rfloor + 1})$ . As a consequence, it is possible to find a network with the minimum level in polynomial time if the minimum level is restricted. It means that the complexity is a polynomial function with the power of the minimum level.

### Related works:

[1] presented an  $O(|\mathcal{T}|.n)$ -time algorithm for determining whether a given set  $\mathcal{T}$  of triplets on  $n$  leaves is consistent with some rooted, distinctly leaf-labeled tree, i.e. a level-0 network, and if so, returning such a tree. Later, improvements were given in [7, 9]. But the problem has been proved to be NP-hard for all other levels [10, 17, 19]. Similarly the problem of finding a network consistent with the maximum number of triplets is also NP-hard for all levels [10, 19]. The approximation problem which gives a factor on the number of triplets that we can construct a network consistent with, has been also studied in [3] for level-0, level-1, and level-2 networks.

Concerning the particular case of dense triplet sets, there are following results. For level-1, [10] give an  $O(|\mathcal{T}|)$ -time algorithm to construct a consistent network, and [18] gives an  $O(n^5)$ -time algorithm to construct a consistent one with the minimum number of reticulations. For level-2, [17] gives an  $O(|\mathcal{T}|^{\frac{8}{3}})$ -time algorithm to construct a consistent network, and [18] presents an  $O(n^9)$ -time algorithm to construct the consistent one with the minimum number of reticulations. For level- $k$  networks with any fixed  $k$ , there is only a result constructing all simple networks in  $O(|\mathcal{T}|^{k+1})$ -time [18]. Recently, in [16] it was proved that when the level is unrestricted, the problem is NP-hard. Besides an interesting recursive construction of level- $k$  phylogenetic networks was proposed in [6]. Moreover the problem of finding a network consistent with the maximum number of triplets is NP-hard for all levels [19].

There are also studies on the version of extremely dense triplet sets, that is when  $\mathcal{T}$  is considered to contain all triplets of a certain network. In this case, an  $O(|\mathcal{T}|^{k+1})$  time algorithm was given in [18] for level- $k$  networks.

## 2 Preliminaries

Let us recall here some useful definitions also used in [5, 10, 11, 17]. Let  $\mathcal{L}$  be a set of  $n$  species or taxa or sequences.

**Definition 1** *A phylogenetic network  $N$  on  $\mathcal{L}$  is a connected, directed, acyclic graph which has:*

- *a unique vertex of indegree 0 and outdegree 2 (root).*
- *vertices of indegree 1 and outdegree 2 (speciation vertices).*
- *vertices of indegree 2 and outdegree 1 (hybrid vertices or reticulation vertices).*
- *$n$  vertices labeled distinctly by  $\mathcal{L}$  of indegree 1 and outdegree 0 (leaves). So  $\mathcal{L}$  is also called the leaf set.*

In other words a phylogenetic network  $N$  is an acyclic directed graph with a unique root and all its sinks are labelled with distinct elements of  $\mathcal{L}$ .

Figure 1(a) for an example of a phylogenetic network on  $\mathcal{L} = \{a, b, \dots, l\}$

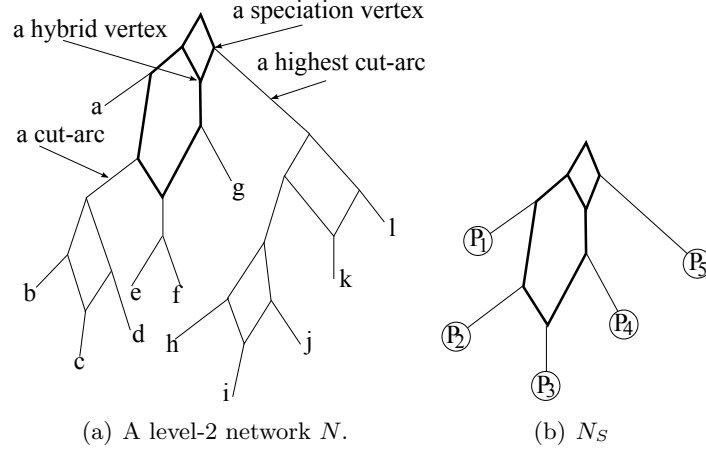

Figure 1: A level-2 network and its simple network.

For any two vertices  $u, v$  of  $N$ , we denote  $u \rightsquigarrow v$  if  $u, v$  are distinct and there is a path in  $N$  from  $u$  to  $v$ . In this case, we say that  $u$  is *above*  $v$  or equivalently  $v$  is *below*  $u$ . Given two paths  $p_1 : u_1 \rightsquigarrow v_1$  and  $p_2 : u_2 \rightsquigarrow v_2$  such that  $u_1$  is not on  $p_2$ ,  $u_2$  is not on  $p_1$  and  $p_1, p_2$  have common vertices. Let  $h$  be their highest common vertex, so  $h$  must be a hybrid vertex. We say that  $p_1, p_2$  **intersect** at  $h$ .

We denote  $\mathbf{u} \rightarrow \mathbf{v}$  for a path from  $u$  to  $v$  which does not contains any hybrid vertex below  $u$  and above  $v$ , if such a path exists.

Let  $\mathcal{U}(N)$  be the underlying undirected graph of  $N$ , obtained by replacing each directed edge of  $N$  by an undirected edge.

**Definition 2** [5] *A phylogenetic network  $N$  is a level- $k$  **phylogenetic network** iff each block of  $\mathcal{U}(N)$  contains at most  $k$  hybrid vertices.*

The network in Figure 1(a) is of level-2. It is easy to see that  $N$  is a level-0 phylogenetic network iff  $N$  is a phylogenetic tree.

The block of  $\mathcal{U}(N)$  that contains the vertex corresponding to the root of  $N$  is called the highest block. We use an abuse of language to call the subgraph of  $N$  which implies this block also as the **highest block** of  $N$ . In Figure 1(a), the highest block is in bold. Denote  $\mathbf{H}_N$  as the set of the hybrid vertices contained in the highest block of  $N$ , so  $|\mathbf{H}_N| \leq k$ .

Each arc of  $N$  whose removal disconnects  $N$  is called a **cut-arc**. A cut-arc  $(u, v)$  is **highest** if there is no cut-arc  $(u', v')$  such that  $v' \rightsquigarrow u$ . It can be seen that a highest cut-arc always has its tail in the highest block.

A phylogenetic network is **simple** if each of its highest cut-arcs connects a vertex of the highest block to a leaf. Figure 1(b) represents a simple level-2 network.

**Definition 3** *A **triplet**  $x|yz$  is a rooted binary tree whose leaves are  $x, y, z$  such that  $x$ , and the parent of  $y$  and  $z$ , are children of the root. A set  $\mathcal{T}$  of triplets is **dense** if for any set  $\{x, y, z\} \subseteq \mathcal{L}$ , at least one triplet on these three leaves belongs to  $\mathcal{T}$ .*

A triplet  $x|yz$  is **consistent** with a network  $N$  if it is 'in' this network, i.e  $N$  contains two vertices  $p \neq q$  and pairwise internal vertex-disjoint paths  $p \rightsquigarrow x$ ,  $p \rightsquigarrow q$ ,  $q \rightsquigarrow y$ , and  $q \rightsquigarrow z$ .

If a triplet is consistent with a network, we says also that this network is consistent with the triplet. For example,  $a|bc$  is consistent with the network in Figure 1(a), but  $b|ac$  is not.

A network is *consistent* with a set of triplets iff it is consistent with all triplets in this set.

For sake of simplicity, in the following it is always assumed that  $\mathcal{T}$  is a dense triplet set, and we will consider the following problem :

### Main Problem

**data:** A dense triplet set  $\mathcal{T}$ .

**research:** A level- $k$  phylogenetic network consistent with  $\mathcal{T}$ .

We call a level- $k$  network consistent with  $\mathcal{T}$  having the minimum number of hybrid vertices as a **minimum** level- $k$  network consistent with  $\mathcal{T}$ .

Let  $L$  be a subset of the  $\mathcal{L}$ . The restriction of  $\mathcal{T}$  to  $L$  is denoted by  $\mathcal{T}|L = \{x|yz \in \mathcal{T} \text{ such that } x, y, z \in L\}$ .

Let  $\mathcal{P}$  be a partition of  $\mathcal{L}$ :  $\mathcal{P} = \{P_1, \dots, P_m\}$ . Denote  $\mathcal{T}\nabla\mathcal{P} = \{P_i|P_jP_k \text{ such that } \exists x \in P_i, y \in P_j, z \in P_k \text{ with } x|yz \in \mathcal{T} \text{ and } i, j \text{ and } k \text{ are distinct}\}$ .

For each network  $N$ , by removing the highest block and the highest cut-arcs, we obtain several vertex-disjoint subnetworks  $N_1, \dots, N_m$ . Each one was hung below a highest cut-arc. If in  $N$ , we replace each  $N_i$  by a leaf, then we have a simple network called  $\mathbf{N}_S$  (Figure 1(b)). Let  $l(N_i)$  be the leaf set of  $N_i$ , so a  $l(N_i)$  is called a *leaf set below a highest cut-arc*. It is easy to see that  $\mathbf{P}(\mathbf{N}) = \{l(N_1), \dots, l(N_m)\}$  is a partition of  $\mathcal{L}$ . We can use biconnectivity to decompose our problem as described in [17].

### Lemma 1 Decomposition lemma

$N$  is a level- $k$  network consistent with  $\mathcal{T}$  iff each  $N_i$  is a level- $k$  network consistent with  $\mathcal{T}|l(N_i)$  for any  $i = 1, \dots, m$  and  $N_S$  is a simple level- $k$  network consistent with  $\mathcal{T}\nabla\mathcal{P}(N)$ .

Constructing a simple level- $k$  network consistent with  $\mathcal{T}\nabla\mathcal{P}(N)$ , if such a one exists, can be done in polynomial time using [18]. Therefore the main difficulty if we want to derive from this lemma a divide and conquer approach is to estimate the number of partitions that have to be checked. Fortunately the search can be restricted to a polynomial number of partitions and to this aim further definitions and technical lemmas are developed in the next sections.

## 2.1 SN-sets

Remark that if  $A$  is leaf set below a cut-arc, or a part of  $P(N)$ , then for any  $z \in \mathcal{L} \setminus A$ ,  $x, y \in A$ , the only triplet on  $\{x, y, z\}$  that can be consistent with the network is  $z|xy$ . Based on this remark, we define a family of leaf sets, called **CA-sets**, for CutArc-sets, as follows.

**Definition 4** Let  $A \subseteq \mathcal{L}$ , then  $A$  is a CA-set if either it is a singleton or the whole  $\mathcal{L}$ , or if it satisfies the following property: For any  $z \in \mathcal{L} \setminus A$ ,  $x, y \in A$ , the only triplet on  $\{x, y, z\}$  in  $\mathcal{T}$ , if there is any, is  $z|xy$ .

As noticed above, each part of  $P(N)$  is a CA-set, but the converse claim is not always true. Let us recall that [11] introduced a variation of these CA-sets, namely the notion of SN-set. A *SN-set* is defined by a closure operation as follows. Let  $A$  be a subset of  $\mathcal{L}$ , the SN-set of  $A$ , denoted  $SN(A)$ , is the set recursively defined as  $SN(A \cup \{z\})$  if there exists some  $z \in \mathcal{L} \setminus A$  and  $x, y \in A$  such that  $x|yz \in \mathcal{T}$ , and as  $A$  otherwise. The following lemma shows the equivalence between these two definitions.

**Lemma 2** (i) For any  $A \subseteq \mathcal{L}$ ,  $SN(A)$  is a CA-set.

(ii) For any CA-set  $A$ , there exists  $B$ , a subset of  $\mathcal{L}$ , such that  $SN(B) = A$ .

*Proof:* All claims are obviously true for singletons. Let us now consider only the non trivial sets.

(i) For any non trivial  $A \subseteq \mathcal{L}$ ,  $\forall z \in \mathcal{L} \setminus SN(A)$ ,  $\forall x, y \in SN(A)$ , neither  $x|yz$  nor  $y|xz$  is in  $\mathcal{T}$  because if one of them is, by the definition of SN-set,  $SN(A)$  would be  $SN(A \cup \{z\})$ , and would contain  $z$ . So, the only triplet on  $\{x, y, z\}$  in  $\mathcal{T}$ , if there is any, is  $z|xy$ . In other words,  $SN(A)$  is a CA-set.

(ii) For any CA-set  $A$ , there can exist several  $B$  such that  $SN(B) = A$ . We take, for example,  $B$  is equal to  $A$ . We have to show that  $SN(A) = A$ . Indeed, as  $A$  is a CA-set, there does not exist any  $z \in \mathcal{L} \setminus A$  and  $x, y \in A$  such that  $x|yz \in \mathcal{T}$ . It means that  $SN(A)$  is exactly  $A$ , according to the recursive definition of SN-set.  $\square$

Therefore, the family of SN-sets is exactly the family of CA-sets and we will stick to the notation of SN-set for any CA-set determined by Definition 4. It was proved in [11] that if  $\mathcal{T}$  is dense, then the collection of its SN-sets is a laminar family [14]. It means that 2 SN-sets are either disjoint or one of them contains the other, hence this family can be represented by a tree when considering inclusion. This tree is called **SN-tree**, its root corresponds to  $\mathcal{L}$ , and the leaves correspond to the singletons. Moreover each node  $v$  of the SN-tree represents a SN-set made up with the leaves of the subtree rooted in  $v$ . Let  $s_1, s_2$  be two SN-sets. We say that  $s_1$  is a **child** of  $s_2$ , or  $s_2$  is a **parent** of  $s_1$ , if in the SN-tree, the node representing  $s_1$  is a child of the node representing  $s_2$ . For example, in the SN-tree of Figure 2(a), the SN-set  $\{d, e\}$  is a child of the SN-set  $\{a, b, c, d, e\}$ . A non trivial maximal SN-set is a child of  $\mathcal{L}$ . To simplify the notation, we call such a set a **maximal SN-set**.

Of course as a first step of our method we use an algorithm provided in [10] to compute in  $O(n^3)$  the SN-tree associated with  $\mathcal{T}$ .

## 2.2 Split SN-sets

[11, 10] showed that if  $\mathcal{T}$  is consistent with a level-1 network, then there exists a level-1 network  $N$  consistent with  $\mathcal{T}$  such that each maximal SN-set is a part of  $P(N)$ .

[17] showed that if  $\mathcal{T}$  is consistent with a level-2 network, then there exists a level-2 network  $N$  consistent with  $\mathcal{T}$  in which each maximal SN-set is a part of  $P(N)$ , except at most one maximal SN-set  $S$  such that each child of  $S$  equal a part of  $P(N)$ . So, to determine  $P(N)$ , we only need to find this exceptional one, if there is any, by checking all maximal SN-sets of  $\mathcal{T}$ .

For level- $k$  networks, with  $k \geq 3$ , each part of  $P(N)$  does not always correspond to a maximal SN-set and it can be any SN-set at any level in the SN-tree (its depth in the SN-tree is not bounded by a function of  $k$ ). However we will show that: if  $\mathcal{T}$  is consistent with a level- $k$  network  $N$ , then there are at most  $3k$  SN-sets such that each child of each one is a part of  $P(N)$ . Moreover, there exists another level- $k$  network  $N'$  consistent with  $\mathcal{T}$  having the same number of hybrid vertices as

$N$ , in which there are at most  $\lfloor \frac{4}{3}k \rfloor$  SN-sets such that each child of each one is a part of  $P(N')$ . We call each such a SN-set as a split SN-set in  $N$ .

**Definition 5** Let  $N$  be a network consistent with  $\mathcal{T}$ , and let  $S$  be a SN-set of  $\mathcal{T}$ . We say that  $S$  is **split** in  $N$  iff each child of  $S$  is equal to a part of  $P(N)$ . In other words, each child of  $S$  is the leaf set below a highest cut-arc of  $N$ , or a certain  $l(N_i)$ .

**Example 1** For example, suppose that  $\mathcal{T}$  has the SN-tree in Figure 2(a).  $\mathcal{T}$  can be the set of all possible triplets on the leaf set  $\mathcal{L} = \{a, b, \dots, k, l\}$  except  $x|yz$  such that  $x, y$  but not  $z$  are in a SN-set. It can be verified that the network  $N$  in Figure 2(b) is consistent with  $\mathcal{T}$ .  $N$  has 9 subnetworks  $N_i$  which gives us the partition  $P(N) = \{\{a, b, c\}, \{d\}, \{e\}, \{f\}, \{g\}, \{h\}, \{i\}, \{k\}, \{j, l\}\}$ . The SN-set  $\{g, h, j, l\}$  is split in this network because each of its children,  $\{g\}, \{h\}, \{j, l\}$ , corresponds to a part of  $P(N)$ . The SN-sets  $\{d, e\}, \{f, k\}$  are also split here. However, the SN-set  $\{a, b, c, d, e\}$  is not split in this network. Indeed, its children are  $\{a, b, c\}, \{d, e\}$  and the latter one is not equal to any part of  $P(N)$ . All other SN-sets,  $\{a, b, c\}, \{j, l\}, \{f, g, h, j, k, l\}, \{f, g, h, i, j, k, l\}$ , the singletons, and the whole  $\mathcal{L}$ , are neither split. In Figure 2(a), each round node corresponds to a SN-set which is split in  $N$ , each square node corresponds to a SN-set which is a part of  $P(N)$ .

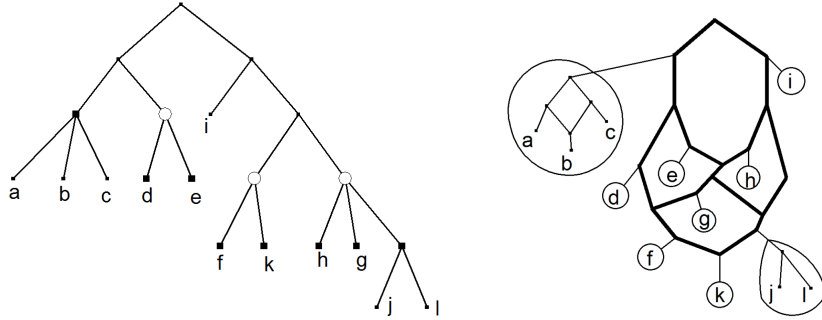

(a) The SN-tree of  $\mathcal{T}$ . The white round nodes represent the SN-sets that split in  $N$ . The black square nodes represent the partition of  $\mathcal{L}$  in  $N$ . (b) A network  $N$  consistent with  $\mathcal{T}$ .

Figure 2: Example 1 of split SN-set.

For any SN-set  $S$  of  $\mathcal{T}$  which is split in  $N$ , denote  $s_1, \dots, s_m$  as the children of  $S$ , i.e. each  $s_i$  is a part of  $P(N)$ . Let  $\mathbf{u}_i$  be the tail of the highest cut-arc below which  $s_i$  is attached to, so  $u_i$  is on the highest block of  $N$ . Sometimes, we denote  $u_{s_i}$  for  $u_i$  when there are more than one split SN-sets that are involved.

Let  $f$  be a subset of  $\mathcal{L} \setminus S$ , and let  $s_i, s_j$  be two children of  $S$ . Since  $S$  is a SN-set, we can deduce that if  $x, y, z \in f \cup s_i \cup s_j$  and  $x|yz \in \mathcal{T}$ , then  $x \in f$  and  $y, z \in s_i \cup s_j$ . So, if we denote  $f|s_i s_j = \{x|yz \text{ such that } x \in f \text{ and } y, z \in s_i \cup s_j\}$ , then this set is actually equal to  $\mathcal{T}|(f \cup s_i \cup s_j)$ .

It is easy to see that two SN-sets which are both split in  $N$  are disjoint.

A SN-set may be split in a network but not-split in another network which is also consistent with the same triplet set. Therefore, when we say that  $S$  is split, we have to indicate in which network. However, for convenience, from now on, when we say  $S$  is a split SN-set, it means that  $S$  is split in  $N$ , a level- $k$  network consistent with  $\mathcal{T}$  that we are going to construct.

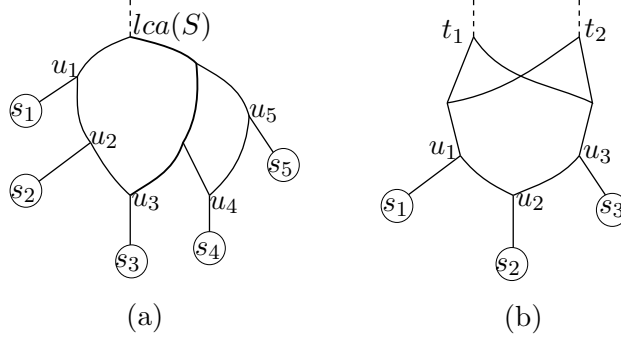

Figure 3: (a)  $S$  has one lowest common ancestor  $lca(S)$ ; (b)  $S$  has two lowest common ancestors  $t_1, t_2$

**Lemma 3** *The set of split SN-sets of  $N$  totally determines  $P(N)$ .*

*Proof:* Suppose that we know the sets of all split SN-sets of a network  $N$ , we can determine  $P(N)$  as follows. Let  $P_i$  be a part of  $P(N)$ . So either  $P_i$  is a child of a split SN-set or not included in any split SN-set. In the latter case, it is a biggest one that is not comparable (neither included nor containing) with any split SN-set. For example, see Figure 2(a) where each split SN-set corresponds to a white round node and each part of  $P(N)$  corresponds to a black square node.  $\square$

So, to bound the number of possible partitions of consistent level- $k$  networks, we will find a bound for the number of split SN-sets in a consistent level- $k$  network. The idea is to find the relations between the number of split SN-sets and the number the hybrid vertices. To this aim, some functions from a split SN-set to a set of hybrid vertices will be introduced.

### 3 Some properties and functions of split SN-sets

This section explores some properties and functions of split SN-sets which will be used in Section 4 to find a stricter bound for the number of split SN-sets in a level- $k$  network.

A vertex of  $N$  is a lowest common ancestor,  $lca$  for abbreviation, of  $S$  if it is the  $lca$  of all leaves of  $s_i$  for  $i = 1, \dots, m$ . If  $S$  has only one  $lca$ , then we denote it by  $\mathbf{lca}(\mathbf{S})$ . Remark that a  $lca$  of  $S$  is never a hybrid vertex.

Let  $t$  be a  $lca$  of  $S$ , denote by  $\mathbf{N}_t[\mathbf{S}]$  the induced subgraph of  $N$  consisting of all paths from  $t$  to the leaves of  $S$ , and  $\mathbf{N}[\mathbf{S}] = \cup \mathbf{N}_t[\mathbf{S}]$  for all  $lca$ s  $t$  of  $S$ . So, if  $S$  has only one  $lca$ , then  $\mathbf{N}[\mathbf{S}] = \mathbf{N}_{lca(S)}[\mathbf{S}]$ . In the figures which describe  $N$  in the following, we represent  $\mathbf{N}[\mathbf{S}]$  by continuous lines and the parts not in  $\mathbf{N}[\mathbf{S}]$  by dotted lines.

#### 3.1 Function $a$

**Definition 6** *For any split SN-set  $S$  of  $N$ , let:*

$$a(S) = \{h \in H_N \mid h \text{ is in } \mathbf{N}[\mathbf{S}] \text{ and } \exists s_i \text{ such that either } h = u_i \text{ or there is a path } h \rightarrow u_i\}$$

( $a$  for above)

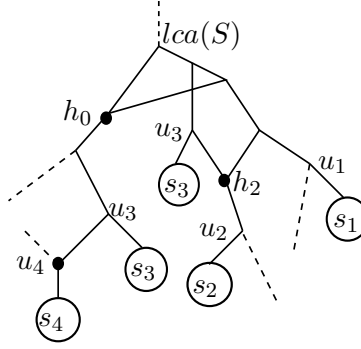

Figure 4:  $a(S) = \{h_0, h_2, u_4\}$

For example, in Figure 4,  $a(S) = \{h_0, h_2, u_4\}$  because they are in  $N[S]$  and we have  $h_0 \rightarrow u_3$ ,  $h_2 \rightarrow u_2$  and  $u_4 \in H_N$ .

**Lemma 4** *Let  $S$  be a split SN-set of  $N$ .*

(i)  $a(S) = \emptyset$  iff  $N[S]$  does not contain any hybrid vertex of  $H_N$ .

(ii) If  $|a(S)| \leq 1$  then  $S$  has only one lca.

(iii) If  $a(S) = \emptyset$ , then  $\forall x \notin S$ , there must exist a path from the root to  $x$  which is vertex-disjoint with  $N[S]$ .

*Proof:* (i) This claim is inferred directly from the definition of  $a$ .

(ii) Suppose that  $S$  has 2 lcas, called  $t_1, t_2$  (Figure 5(a)). Let  $s_1$  be a child of  $S$ , so there exists a path  $t_1 \rightsquigarrow u_1$  and a path  $t_2 \rightsquigarrow u_1$ . Since  $t_1$  is neither above nor below  $t_2$ , these two paths must intersect at a hybrid vertex above  $u_1$ . Let  $h_1$  be a lowest hybrid vertex below  $t_1, t_2$  and above  $u_1$ , then there is a path  $h_1 \rightarrow u_1$ . By definition,  $h_1 \in a(S)$ . Let  $s_2$  be another child of  $S$  such that  $t_1, t_2$  are lcas of  $s_1, s_2$ . By the same argument, there is a hybrid vertex  $h_2$  and a path  $h_2 \rightarrow u_2$ . Then  $h_2 \in a(S)$ . It is evident that  $h_1 \neq h_2$  because otherwise  $h_1$  is a lca of  $s_1, s_2$ . So  $a(S)$  contains at least two hybrid vertices  $h_1, h_2$ , a contradiction.

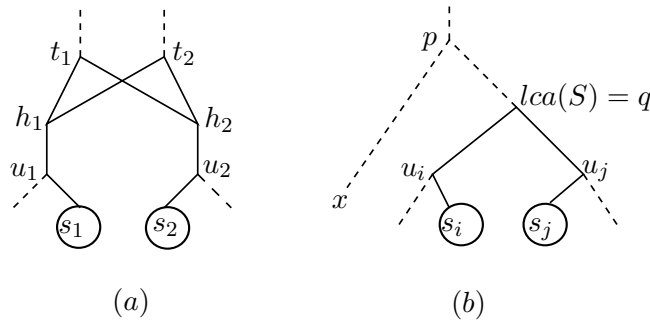

Figure 5: Proof of Lemma 4

(iii) Because  $a(S) = \emptyset$  then  $N[S]$  does not have any hybrid vertex in  $H_N$  and  $S$  has only one lca. Let  $s_i, s_j$  be two children of  $S$  such that  $lca(s_i, s_j) = lca(S)$  (Figure 5(b)). Because  $S$  is a



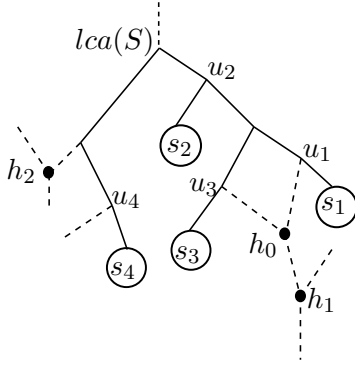

Figure 6:  $b(S) = \{h_0, h_1, h_2\}$

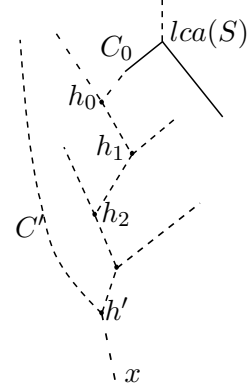

Figure 7: Proof of Lemma 5

SN-set then  $x|_{s_i s_j}$  is consistent with  $N$ . So, there exist two vertices  $p, q$  of  $N$  such that there are 4 internal vertex-disjoint paths  $p \rightsquigarrow q$ ,  $p \rightsquigarrow x$ ,  $q \rightsquigarrow u_i$  and  $q \rightsquigarrow u_j$ . Because  $u_i, u_j$  have only one lca which is  $lca(S)$ , then  $q = lca(S)$ . Suppose that every path from the root to  $x$  has common vertex with  $N[S]$ , then the path  $p \rightsquigarrow x$  must also have common vertex with  $N[S]$ . Since  $N[S]$  does not have any hybrid vertex in  $H_N$  then this path must pass  $lca(S)$ . We deduce that the paths  $p \rightsquigarrow x$ ,  $q \rightsquigarrow u_i$ ,  $q \rightsquigarrow u_j$  have  $lca(S)$  as a common vertex, a contradiction. Hence, there must exist a path from the root to  $x$  which is vertex-disjoint with  $N[S]$ .  $\square$

### 3.2 Function $b$

Let  $S$  be a split SN-set of  $N$  such that  $a(S) = \emptyset$ . Let  $u$  be a vertex in  $N[S]$  and  $v$  be a vertex not in  $N[S]$  below  $u$ . We denote  $\mathbf{u} \leftrightarrow_S \mathbf{v}$  for a path from  $u$  to  $v$  such that for any hybrid vertex  $h$  different from  $u, v$  on this path, *any path from the root to  $h$  must have common vertex with  $N[S]$* , if such a path exists. Note that if there is a path  $u \rightarrow v$ , i.e if there is no hybrid vertex different from  $u, v$  on this path, then this path is also a path  $u \leftrightarrow_S v$ .

**Definition 7** For any split SN-set  $S$  of  $N$  such that  $a(S) = \emptyset$ , let:

$$b(S) = \{h \in H_N \mid \exists \text{ a path } V \leftrightarrow_S h \text{ where either } V = lca(S) \text{ or } \exists s_i \text{ such that } V = u_i\}$$

( $b$  for below)

For example in Figure 6,  $b(S) = \{h_0, h_1, h_2\}$  because they are not in  $N[S]$  and we have  $u_1 \leftrightarrow_S h_0$ ,  $u_1 \leftrightarrow_S h_1$  and  $lca(S) \leftrightarrow_S h_2$ .

**Lemma 5** Let  $S$  be a split SN-set of  $N$  such that  $a(S) = \emptyset$  and let  $x$  be a leaf not in  $S$  which is below  $lca(S)$ . Let  $C_0$  be a path from  $lca(S)$  to  $x$ , then  $C_0$  must contain a hybrid vertex  $h_x$  in  $b(S)$  such that:

- there is a path from the root to  $h_x$  which is vertex-disjoint with  $N[S]$ , and
- for any hybrid vertex  $h$  on  $C_0$  above  $h_x$ , every path from the root to  $h$  has common vertex with  $N[S]$ .

*Proof:* Following Lemma 4 (i),  $N[S]$  does not contain any hybrid vertex in  $H_N$ . Since  $x \notin S$  then by Lemma 4 (iii), there must exist a path  $C'$  from the root to  $x$  which is vertex-disjoint with  $N[S]$ . This path must intersect with  $C_0$  at a hybrid vertex  $h'$  above  $x$  (Figure 7).

Let  $h_0$  be the highest hybrid vertex on  $C_0$ . So, there is not any hybrid vertex on the induced subpath of  $C_0$  from  $lca(S)$  to  $h_0$ , i.e. it is a path  $lca(S) \hookrightarrow_S h_0$ . Moreover, because  $N[S]$  does not contain any hybrid vertex, then  $h_0 \notin N[S]$ . By definition of  $b$ , we have  $h_0 \in b(S)$ . If there is a path from the root to  $h_0$  which is vertex-disjoint with  $N[S]$ , then by choosing  $h_x = h_0$  we are done. Otherwise, every path from the root to  $h_0$  has common vertex with  $N[S]$ . Let  $h_1$  be the hybrid vertex on  $C_0$  which is right below  $h_0$ . By definition, the subpath of  $C_0$  from  $lca(S)$  to  $h_1$  is a path  $lca(S) \hookrightarrow_S h_1$ , i.e.  $h_1 \in b(S)$ . Hence, if there is a path from the root to  $h_1$  which is vertex-disjoint with  $N[S]$ , then we can choose  $h_x = h_1$ . Otherwise, we consider the hybrid vertex  $h_2$  on  $C_0$  which is right below  $h_1$ .

By continuing this process, there will be a moment that either we meet a hybrid vertex  $h_i$  having the wanted property, or we meet  $h'$ . In the later case, the path  $C'$  from the root to  $h'$  which is vertex disjoint with  $N[S]$ , so we can choose  $h_x = h'$ .  $\square$

### 3.3 Restricting the searching class

We will restrict the research to a class of level- $k$  phylogenetic network which have fewer split SN-sets without losing the ones with the minimum number of hybrid vertices.

For a split SN-set  $S$  such that  $a(S) = \emptyset$ , let us define  $\mathbf{F}_S$  as the set  $(x, y, s_i)$  where  $x, y \notin S$ ,  $x, y$  are below  $lca(S)$  and  $s_i$  is a child of  $S$  such that there is at least a leaf  $z \in s_i$  such that  $x|yz \in \mathcal{T}$ .

**Lemma 6** *Let  $N$  be a level- $k$  network consistent with  $\mathcal{T}$ , let  $S$  be a SN-set of  $\mathcal{T}$  which is split in  $N$  such that  $a(S) = \emptyset$ . Suppose that for any  $(x, y, s_i) \in \mathbf{F}_S$ :*

- either  $N$  has a path from the root to  $x$  which is vertex-disjoint with a path from  $lca(S)$  to  $y$ ,
- or there exist 2 vertices  $p, q$  in  $N$  such that  $p$  is above  $lca(S)$  and there are 4 internal vertex-disjoint paths  $p \rightsquigarrow q$ ,  $p \rightsquigarrow x$ ,  $q \rightsquigarrow y$ ,  $q \rightsquigarrow u_i$ .

*Then, there is a level- $k$  network  $N'$  consistent with  $\mathcal{T}$ , having the same number of hybrid vertices as  $N$ , in which  $S$  is not split but is equal to a part of  $P(N')$ .*

*Proof:* Suppose that  $S$  satisfies the condition stated in the lemma. Because  $a(S) = \emptyset$ , then by Lemma 4,  $S$  has only one lca. Let  $G_S$  be the network obtained from  $N[S]$  by contracting all arcs having one extremity of in-degree 1 and out-degree 1. So,  $G_S$  has one lca, called  $u_S$ .

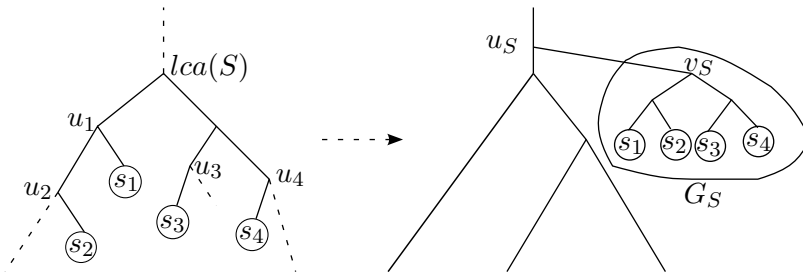

Figure 8: Modify  $N \rightarrow N'$ ,  $u_S$  is added in the middle of the arc coming to  $lca(S)$ .

We construct  $N'$  from  $N$  as follows (see Figure 8 in which only the part of the network that concerns  $S$  is drawn): delete from  $N$  all subnetworks on  $s_i$ , contract all arcs having one extremity of in-degree 1 and out-degree 1, add a new vertex  $u_S$  in the middle of the arc coming to  $lca(S)$  and

then add a new arc from  $u_S$  to  $v_S$  where we attach  $G_S$ . So  $(u_S, v_S)$  is a highest cut-arc of  $N'$ , i.e.  $S$  is a part of  $P(N')$ .

Because  $a(S) = \emptyset$ , then there is not any hybrid vertex of  $H_N$  in  $N[S]$ . So,  $G_S$  does not contain any hybrid vertex except those in the subnetworks on  $s_i$ . It implies that  $N'$  has the same level and the same number of hybrid vertices as  $N$ . Now, it remains to show that  $N'$  is consistent with all triplets of  $\mathcal{T}$ . For a triplet  $x|yz \in \mathcal{T}$ , we can distinguish the 6 following cases:

(1) Since  $S$  is a SN-set, the cases  $x, y \in S$  and  $z \notin S$  or  $x, z \in S$  and  $y \notin S$  are excluded.

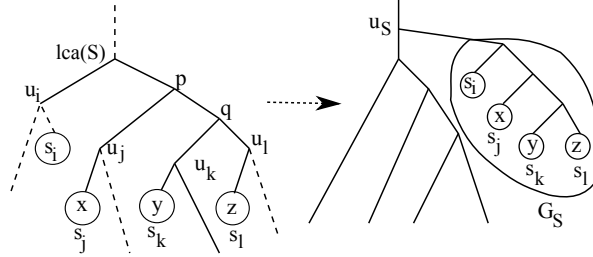

Figure 9: (2):  $x, y, z \in S$

(2)  $x, y, z \in S$  (Figure 9), so there exist  $s_j, s_k, s_l$  such that  $x \in s_j, y \in s_k, z \in s_l$  ( $j, k, l$  are not necessarily distinct). By definition of consistency,  $N$  has 2 vertices  $p, q$  and the internal vertex-disjoint paths  $p \rightsquigarrow q, p \rightsquigarrow x, q \rightsquigarrow y, q \rightsquigarrow z$ . Because there is not any hybrid vertex in  $N[S]$ , then any path from a vertex above  $lca(S)$  to any leaf of  $S$  must pass  $lca(S)$ . So,  $p, q$  can not be above  $lca(S)$  because otherwise, there are at least 2 among the 4 paths  $p \rightsquigarrow q, p \rightsquigarrow x, q \rightsquigarrow y, q \rightsquigarrow z$  have  $lca(S)$  as a common vertex. We deduce that  $p, q$  are in  $N[S]$ . So,  $x|yz$  is consistent with  $N[S]$ , or with  $G_S$ , and then is consistent with  $N'$ .

(3)  $x, y, z \notin S$ . We do not change the configuration of the network except the positions of the subnetworks on  $s_i$ . So all triplets of this case remain consistent with  $N'$ .

(4)  $x \notin S, y, z \in S$ . In  $N'$ ,  $y, z$  are below the highest cut-arc  $(u_S, v_S)$  while  $x$  is not. Hence, the triplet  $x|yz$  is consistent with  $N'$  in this case.

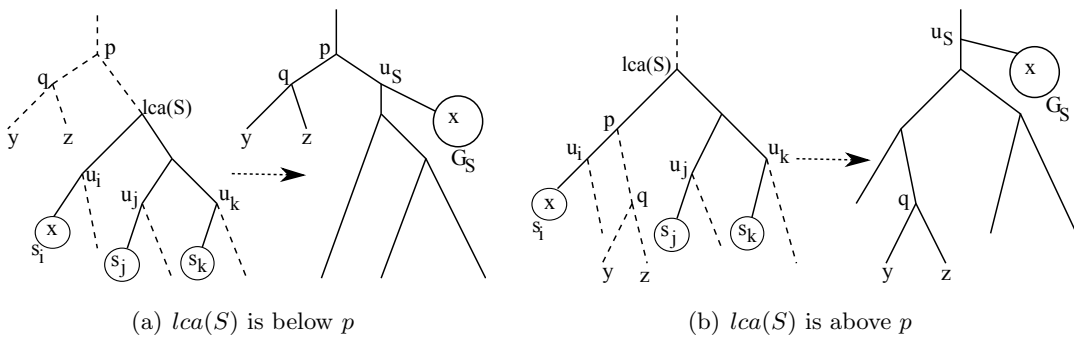

Figure 10: (5):  $x \in S, y, z \notin S$ .

(5)  $x \in S, y, z \notin S$ . Since  $x \in S$ , then there exists  $s_i$  such that  $x \in s_i$ . Let  $p, q$  be two vertices of  $N$  such that there are internal vertex-disjoint paths  $p \rightsquigarrow x, p \rightsquigarrow q, q \rightsquigarrow y, q \rightsquigarrow z$ .

We will prove that  $lca(S)$  and  $p$  are comparable. Suppose otherwise, then any paths  $p \rightsquigarrow u_i$  and  $lca(S) \rightsquigarrow u_i$  intersect at a hybrid vertex  $h'$ . If  $h' = u_i$  then  $u_i$  is a hybrid vertex in  $a(S)$ , a contradiction because  $a(S) = \emptyset$ . So  $h'$  is above  $u_i$ . However,  $h'$  is below  $lca(S)$ , then  $a(S)$  contains at least one vertex, a contradiction. Hence, we have two cases:

a) If  $lca(S)$  is below  $p$  (see Figure 10(a)), then  $q$  can not be below  $lca(S)$  because otherwise, the paths  $p \rightsquigarrow x$  and  $p \rightsquigarrow q$  have  $lca(S)$  as a common vertex, a contradiction. In  $N$  the path  $p \rightsquigarrow x$  must pass  $lca(S)$ . So the path  $p \rightsquigarrow u_S$  in  $N'$  is a subpath of  $p \rightsquigarrow x$  in  $N$ . It implies that in  $N'$ ,  $p \rightsquigarrow u_S$  is also internal vertex-disjoint with  $p \rightsquigarrow q$ ,  $q \rightsquigarrow y$  and  $q \rightsquigarrow z$ . So, because  $x$  is below  $u_S$  then  $x|yz$  is consistent with  $N'$ .

b) If  $lca(S)$  is above or equal to  $p$  (see Figure 10(b)), because  $y, z$  are below  $p$ , then they are also below  $lca(S)$ . So,  $y, z$  have a lca  $q$  below  $lca(S)$ , i.e below  $u_S$  in  $N'$ . Moreover, in  $N'$ ,  $x$  is hung below the highest cut-arc  $(u_S, v_S)$ , then any path  $u_S \rightsquigarrow x$  is internal vertex-disjoint with  $u_S \rightsquigarrow q, q \rightsquigarrow y, q \rightsquigarrow z$ . In other words,  $x|yz$  is consistent with  $N'$ .

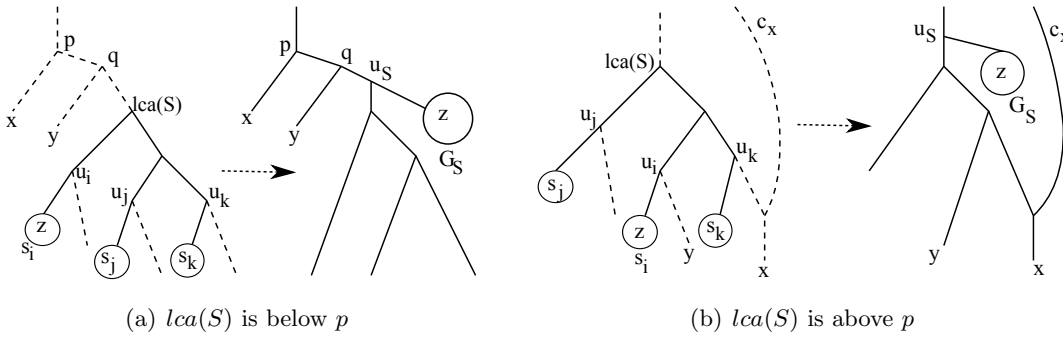

Figure 11: (6):  $x, y \notin S, z \in S$ .

(6)  $x, y \notin S, z \in S$ . Since  $z \in S$  then  $\exists s_i$  such that  $z \in s_i$ . For any two vertices  $p, q$  of  $N$  such that there are 4 internal vertex-disjoint paths  $p \rightsquigarrow x, p \rightsquigarrow q, q \rightsquigarrow y, q \rightsquigarrow z$ . By the same argument as that of the previous case (5), we deduce that  $lca(S)$  and  $p$  are comparable.

a) If  $lca(S)$  is below  $p$  (see Figure 11(a)), then in  $N'$ ,  $u_S$  is below  $p$ . Similarly as the case (5a), the path  $p \rightsquigarrow u_S$  in  $N'$  is a subpath of  $p \rightsquigarrow z$  in  $N$ , so it is internal vertex-disjoint with  $p \rightsquigarrow x, q \rightsquigarrow y$  in  $N'$ . Because in  $N'$ ,  $z$  is below the cut-arc  $(u_S, v_S)$ , then every path  $u_S \rightsquigarrow z$  is internal vertex-disjoint with the paths  $p \rightsquigarrow x, p \rightsquigarrow q, q \rightsquigarrow y$ , no matter where the position of  $q$  is (above or below  $lca(S)$ ). Hence,  $x|yz$  is consistent with  $N'$ .

b) If  $lca(S)$  is above or equal to  $p$  (see Figure 11(b)), because  $x, y$  are below  $p$ , then they are also below  $lca(S)$ , i.e  $(x, y, s_i) \in F_S$ . According to the assumption:

- either there exist two other vertices  $p', q'$  such that  $p'$  is above  $lca(S)$  and the internal vertex-disjoint path  $p' \rightsquigarrow x, p' \rightsquigarrow q', q' \rightsquigarrow y, q' \rightsquigarrow z$ , then it returns to the case (a).

- or there is a path  $c_x$  from the root to  $x$  which is vertex disjoint with a path  $c_y$  from  $lca(S)$  to  $y$ . In this case,  $c_x$  in  $N'$  is also vertex disjoint with the path from  $u_S$  to  $y$  by using  $c_y$ . So,  $x|yz$  is also consistent with  $N'$ .

We conclude that  $N'$  is consistent with all triplets of  $\mathcal{T}$ . □

**Lemma 7** Let  $N$  be a level- $k$  network consistent with  $\mathcal{T}$ , let  $S$  be a SN-set of  $\mathcal{T}$  which is split in  $N$  such that  $a(S) = \emptyset$  and  $|b(S)| \leq 2$ . Then there is a level- $k$  network  $N'$  consistent with  $\mathcal{T}$ , having

the same number of hybrid vertices as  $N$ , in which  $S$  is not split but equal to a part of  $P(N')$ .

*Proof:* If  $S$  satisfies the conditions in Lemma 6, then we are done. Otherwise, suppose that  $|b(S)| \leq 2$  and  $S$  does not satisfy the conditions in Lemma 6. Then let  $F'_S$  be the non empty subset of  $F_S$  containing the elements  $(x, y, s_i)$  which do not satisfy the conditions, it means that:

- (\*) every path from the root to  $x$  has common vertex with every path from  $lca(S)$  to  $y$ .
- (\*\*) for any two vertices  $p, q$  of  $N$  such that there are internal vertex-disjoint paths  $p \rightsquigarrow q$ ,  $p \rightsquigarrow x$ ,  $q \rightsquigarrow u_i$ ,  $q \rightsquigarrow y$ ,  $p$  is below or equal to  $lca(S)$  ( $p$  and  $lca(S)$  must be comparable, see the proof of Lemma 6).

We will use (\*) and (\*\*) to deduce some properties of the elements in  $F'_S$ . Let  $(x, y, s_i) \in F'_S$ , then  $x|y|s_i$  is consistent with  $N$ . So, let  $p_{xy}, q_{xy}$  be two vertices of  $N$  such that there are internal vertex-disjoint paths  $p_{xy} \rightsquigarrow q_{xy}$ ,  $p_{xy} \rightsquigarrow x$ ,  $q_{xy} \rightsquigarrow u_i$ ,  $q_{xy} \rightsquigarrow y$  (Figure 12). By (\*\*),  $p_{xy}$  is below or equal to  $lca(S)$ . Moreover, because  $p_{xy}$  is above  $u_i$  then it is in  $N[S]$ . Let us denote  $c_x$  the path  $p_{xy} \rightsquigarrow x$ , and  $c_y$  the path  $p_{xy} \rightsquigarrow q_{xy} \rightsquigarrow y$ . So  $c_x, c_y$  are internal vertex-disjoint. Let  $h_x$  be the hybrid vertex of  $b(S)$  on the path from  $lca(S)$  to  $x$  containing  $c_x$  which is defined as in Lemma 5. Because  $h_x \notin N[S]$ ,  $p_{xy} \in N[S]$ , then  $h_x$  is below  $p_{xy}$ , i.e  $h_x$  is on  $c_x$ . Similarly, we define the hybrid vertex  $h_y$  of  $b(S)$ , which is on  $c_y$ . Because  $c_x, c_y$  are vertex-disjoint then  $h_x \neq h_y$ . It implies that  $|b(S)| \geq 2$ , so  $|b(S)| = 2$ .

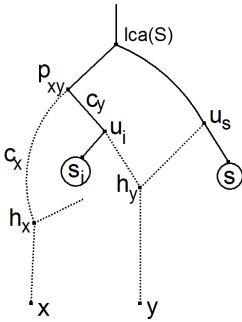

Figure 12:  $(x, y, s_i) \in F'_S$

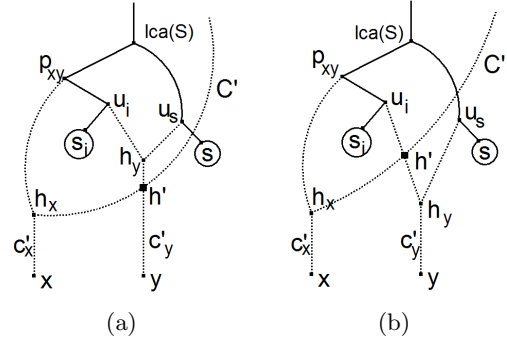

Figure 13:  $h_x$  is below  $h_y$ .

We will prove that  $h_x$  is below  $h_y$  (Figure 13). Let  $c'_x$  be the subpath of  $c_x$  from  $h_x$  to  $x$ , and  $c'_y$  be the subpath of  $c_y$  from  $h_y$  to  $y$ . Following Lemma 5, there is a path called  $C'$  from the root to  $h_x$  which is vertex-disjoint with  $N[S]$ . Let  $C_x$  be a path from the root to  $x$  consisting of  $C'$  and  $c'_x$  and let  $C_y$  be a path from  $lca(S)$  to  $y$  containing  $c_y$ . By the property (\*),  $C_x, C_y$  must have common vertex with  $c_y$ . Because  $C_x$  does not pass  $lca(S)$ , while  $x$  is below  $lca(S)$ , then  $C_x$  intersects with  $C_y$  at a hybrid vertex  $h'$ . If  $h'$  is on  $c'_y$  (Figure 13(a)), then  $h'$  is above  $h_x$  and below  $h_y$ , i.e  $h_y$  is above  $h_x$ , we are done. Suppose that  $h'$  is above  $h_y$  (Figure 13(b)). Using Lemma 5 with the path  $C_y$  and the vertex  $h_y$ , we deduce that for any hybrid vertex  $h$  on  $C_y$  above  $h_y$ , every path from the root to  $h$  has common vertex with  $N[S]$ . However,  $h'$  is on the path  $C_y$  and above  $h_y$ , but the subpath of  $C'$  from the root to  $h'$  is vertex-disjoint with  $N[S]$ , a contradiction. Hence,  $h_x$  must be below  $h_y$ .

Let  $b(S) = \{h_1, h_2\}$ . So if there exists an element  $(x, y, s_i) \in F'_S$  and  $h_1 = h_x, h_2 = h_y$  then by the property proved above  $h_1$  is below  $h_2$ . In this case,  $F'_S$  does not contain any element  $(x', y', s'_i)$  such that  $h_1 = h_{y'}$  and  $h_2 = h_{x'}$ . Because otherwise, we will deduce from this property that  $h_2$  is

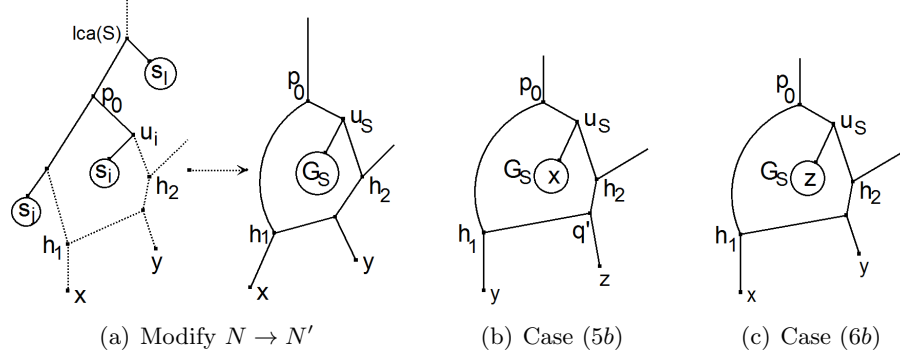

Figure 14: Proof of Lemma 7

below  $h_1$ , contradicting  $N$  being acyclic. In other words, if  $h_1$  is below  $h_2$ , then for any element  $(x, y, s_i)$  of  $F'_S$ , we have  $h_1 = h_x$  and  $h_2 = h_y$ .

We construct  $G_S$  and modify  $N$  by the same way that we did in the proof of Lemma 6. However, the position of  $u_S$  below which we hang  $G_S$  will be chosen differently. Let  $p_0$  be a vertex of  $N[S]$  such that there are two internal vertex disjoint paths  $p_0 \rightsquigarrow h_1$  and  $p_0 \rightsquigarrow h_2$ . There exists always such a  $p_0$ , for example  $p_0 = p_{xy}$  for a certain element  $(x, y, s_i) \in F'_S$ .  $u_S$  is put in the middle of the arc going from  $p_0$  on the path  $p_0 \rightsquigarrow h_2$  (Figure 14(a)). Denote the obtained network by  $N'$ . We must check that all triplets  $x|yz$  of  $\mathcal{T}$  are consistent with  $N'$ . Let  $p, q$  be two vertices of  $N$  such that there exist 4 internal vertex disjoint paths  $p \rightsquigarrow q, p \rightsquigarrow x, q \rightsquigarrow y, q \rightsquigarrow z$ . It can be verified that the proof of Lemma 6 still holds here for all triplets except the cases (5b) and (6b).

(5b)  $x \in S, y, z \notin S$  and  $p$  is below  $lca(S)$ , i.e.  $y, z$  are also below  $lca(S)$  (Figure 14(b)). By Lemma 5, any leaf below  $lca(S)$  and not in  $S$  must be below a hybrid vertex of  $b(S)$ . Because  $b(S)$  contains only  $h_1, h_2$  and  $h_1$  is below  $h_2$ , then  $y, z$  are below  $h_2$ . Hence, there exists a  $lca$   $q'$  of  $y, z$  which is below  $h_2$ . Furthermore,  $u_S$  is above  $h_2$  then in  $N'$  there are 4 internal vertex-disjoint paths  $u_S \rightsquigarrow x, u_S \rightsquigarrow q', q' \rightsquigarrow y$  and  $q' \rightsquigarrow z$ , i.e.  $x|yz$  is consistent with  $N'$ .

(6b)  $x, y \notin S, z \in S$  and  $p$  is below  $lca(S)$ , i.e.  $x, y$  are below  $lca(S)$ . Then, each triplet  $x|yz$  in this case corresponds to an element  $(x, y, s_i)$  of  $F_S$  where  $z \in s_i$ .

- If  $(x, y, s_i) \in F_S \setminus F'_S$ , then it satisfies the properties in Lemma 6. We can easily use the same argument as the proof in Lemma 6 to prove that  $x|yz$  is consistent with  $N'$ .

- Otherwise,  $(x, y, s_i) \in F'_S$ , so it satisfies the property proved above, i.e.  $h_1 = h_x, h_2 = h_y$  (Figure 14(c)). In other words,  $x$  is below  $h_1$  and  $y$  is below  $h_2$ . Because  $u_S$  is added on the path  $p_0 \rightsquigarrow h_2$ , then in  $N'$  there are 4 internal vertex-disjoint paths  $p_0 \rightsquigarrow h_1 \rightsquigarrow x, p_0 \rightsquigarrow u_S, u_S \rightsquigarrow h_2 \rightsquigarrow y$  and  $u_S \rightsquigarrow z$ . Hence,  $x|yz$  is consistent with  $N'$ .  $\square$

Using Lemmas 6, 7 without loss the networks having the minimum number of hybrid vertices, we can restrict the research on the networks  $N$  such that: each split SN-set  $S$  of  $N$  having  $a(S) = \emptyset$  does not satisfy the 2 conditions in these Lemmas. **In the following, we use only one of these two conditions, i.e. if  $a(S) = \emptyset$ , then  $|b(S)| \geq 3$ .**

## 4 A stricter bound on the restricted networks class

As concluded in Section 3.3, without loss the level- $k$  networks having the minimum number of hybrid vertices, we can suppose that the constructing level- $k$  networks  $N$  having the following property: for any split SN-set  $S$  of  $N$ , if  $a(S) = \emptyset$ , then  $|b(S)| \geq 3$ .

Let  $\mathcal{C}$  be the set of SN-sets of  $\mathcal{T}$  that are split in  $N$ . We will bound  $|\mathcal{C}|$  by a stricter linear function of  $k$ . To this aim, the functions  $a, b$  defined in Section 3 and another function  $s$  defined in the next will be explored. The following lemmas show some properties of each function which allow us to establish the relation between the number of hybrid vertices in  $H_N$  and the cardinality of  $\mathcal{C}$ .

**Lemma 8** *For any  $h \in H_N$ ,  $|a^{-1}(h)| \leq 1$ , i.e. a hybrid vertex is assigned to at most one split SN-set by function  $a$ .*

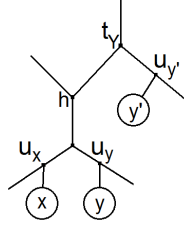

Figure 15: Proof of Lemma 8

*Proof:* Assume that there exist 2 split SN-sets  $X, Y$  such that  $h \in a(X) \cap a(Y)$ . By definition, there exists  $x$  which is a child of  $X$  such that either  $h = u_x$  or there is a path  $h \rightarrow u_x$ . Similarly we have a child  $y$  of  $Y$ . Let  $t_Y$  be a lca of  $Y$ , so  $t_Y$  is above  $h$  and let  $y'$  be another child of  $Y$  such that  $\text{lca}(y, y') = t_Y$  (Figure 15). We see that any paths from a vertex above  $t_Y$  to  $x$  and to  $y$  must pass  $h$  because there is no hybrid vertex on the paths from  $h$  to  $u_x$  and to  $u_y$ . So  $x|yy'$  is not consistent with the network, contradicting  $Y$  being a SN-set.  $\square$

Using the function  $a$ , we partition  $H_N$  and  $\mathcal{C}$  into several subsets: (Figure 16(a)).

- $A_0 = \{h \in H_N | a^{-1}(h) = \emptyset\}$ , and  $C_0 = \{S \in \mathcal{C} | a(S) = \emptyset\}$ .
- For any  $i \geq 1$ ,  $C_i = \{S \in \mathcal{C} | |a(S)| = i\}$ , so all  $C_i$  are pairwise disjoint.
- $A_i$  is the image of  $C_i$  by the function  $a$ . By Lemma 8, all  $A_i$  are pairwise disjoint.

**Lemma 9**  $|\mathcal{C}| \leq k + |C_0| - |A_0| - \frac{1}{2}|A_{\geq 2}|$

*Proof:* By definition, all  $A_i$  are pairwise disjoint, and  $|A_i| = i|C_i|$  for any  $i \geq 1$ .

Then:  $|\mathcal{C}| = |C_0| + |C_1| + \sum_{i \geq 2} |C_i| = |C_0| + |A_1| + \sum_{i \geq 2} \frac{1}{i}|A_i|$ .

Furthermore,  $|H_N| = |A_0| + |A_1| + \sum_{i \geq 2} |A_i| \leq k$

So,  $|\mathcal{C}| \leq k + |C_0| - |A_0| - \sum_{i \geq 2} \frac{i-1}{i}|A_i| \leq k + |C_0| - |A_0| - \frac{1}{2}|A_{\geq 2}|$   $\square$

Then, in order to bound  $|\mathcal{C}|$ , it remains to determine the relations between  $|C_0|$ ,  $|A_0|$  and  $|A_{\geq 2}|$ .

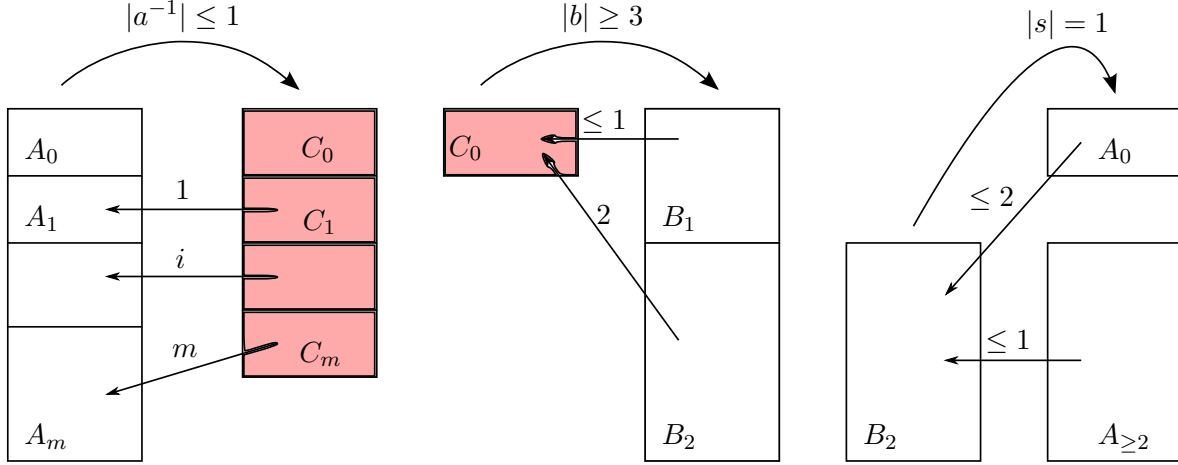

(a)  $|A_i| = i|C_i|$  for any  $i \geq 1$       (b)  $3|C_0| \leq |B_1| + 2|B_2|$       (c)  $|B_2| \leq (2|A_0| + |A_{\geq 2}|)$

Figure 16: The 3 functions  $a, b, s$  and their properties. The white regions represent the hybrid vertices:  $H_N = \cup A_i = B_1 \cup B_2$ . The rose regions represent the split SN-sets:  $\mathcal{C} = \cup C_i$ .

**Lemma 10**  $\forall h \in H_N$ , there are at most 2 split SN-sets  $X, Y$  of  $C_0$  such that  $h \in b(X) \cap b(Y)$ .

*Proof:* Suppose that there are 3 split SN-sets  $X, Y, Z$  of  $C_0$  and a hybrid vertex  $h \in b(X) \cap b(Y) \cap b(Z)$ . By definition,  $h$  is not in  $N[X]$  and there is a path  $c_x: V_x \leftrightarrow_X h$  where either  $V_x = lca(X)$  or there exists a child  $x$  of  $X$  such that  $V_x = u_x$ . Similarly, we have  $c_y$  and  $c_z$ .

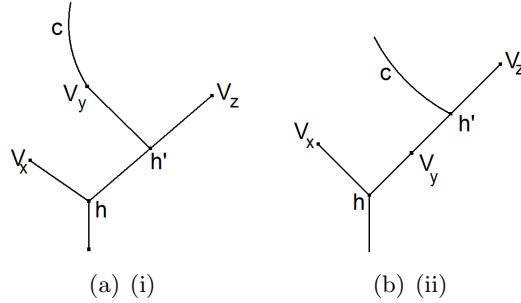

Figure 17: Proof of Lemma 10

The 3 paths  $c_x, c_y, c_z$  pass  $h$ , then there are at least two among them, for example  $c_y, c_z$  have common vertex above  $h$ . So, we have the following cases:

(i)  $c_y$  and  $c_z$  intersect at a hybrid vertex  $h'$  above  $h$  (Figure 17(a)).

Suppose that there exists a leaf  $y'$  of  $Y$  which is below  $V_y$ . By Lemma 4 (iii), there must exist a path  $c$  from the root to  $y'$  which is vertex-disjoint with  $N[Z]$ . Because  $Y \in C_0$ , then  $N[Y]$  does not contain any hybrid vertex in  $H_N$ , i.e every path from the root to  $y'$  must pass  $V_y$ .  $c$  is vertex-disjoint with  $N[Z]$ , then  $V_y$  is not in  $N[Z]$ . So, the subpath of  $c$  from the root to  $V_y$  extended to  $h'$



is vertex-disjoint with  $N[Z]$ . The later is a contradiction with the fact that  $c_z$  is a path  $V_z \hookrightarrow_Z h$ .

(ii)  $V_y$  is on  $c_z$  (Figure 17(b)). Similarly as the above case, there is a path  $c$  from the root to  $V_y$  which is vertex disjoint with  $N[Z]$ . So  $c$  intersects with  $c_z$  at a hybrid vertex  $h'$  above  $V_y$ . The subpath of  $c$  from the root to  $h'$  is also vertex-disjoint with  $N[Z]$ . The later is a contradiction with the fact that  $c_z$  is a path  $V_z \hookrightarrow_Z h$ .

(iii) The same for the case where  $V_z$  is on  $c_y$ . □

Due to Lemma 10, we can use the function  $b$  to partition  $H_N$  into 2 subsets (Figure 16(b)):

$B_1 = \{h \in H_N \mid \text{there is at most one split SN-set } X \text{ of } C_0 \text{ such that } h \in b(X)\}$ .

$B_2 = \{h \in H_N \mid \text{there are two split SN-sets } X, Y \text{ of } C_0 \text{ such that } h \in b(X) \cap b(Y)\}$ .

So,  $B_1$  and  $B_2$  are disjoint.

**Lemma 11** (i)  $3|C_0| \leq |B_1| + 2|B_2|$ .

(ii)  $|C| \leq \frac{4}{3}k + \frac{1}{3}|B_2| - |A_0| - \frac{1}{2}|A_{\geq 2}|$

*Proof:* (i) According to the assumption on restricted searching class,  $\forall S \in C_0, |b(S)| \geq 3$ . With the definition of  $B_1, B_2$  as above, we are done (see Figure 16(b)).

(ii) By Lemma 9 and Claim (i), we have:

$$|C| \leq k + |C_0| - |A_0| - \frac{1}{2}|A_{\geq 2}| \leq k + \frac{1}{3}|B_1| + \frac{2}{3}|B_2| - |A_0| - \frac{1}{2}|A_{\geq 2}|.$$

Because  $|B_1| + |B_2| = |H_N| \leq k$ , then  $|B_1| \leq k - |B_2|$ .

So,  $|C| \leq \frac{4}{3}k + \frac{1}{3}|B_2| - |A_0| - \frac{1}{2}|A_{\geq 2}|$ . □

To reach our main result we need to compare  $|B_2|$  and  $|A_0|, |A_{\geq 2}|$ . To this aim, a function  $s$  from  $B_2$  to  $A_0 \cup A_{\geq 2}$  (Figure 16(c)) is introduced. However, this function is not so easy to define directly, so we define it through another function  $t$ , which assigns a split SN-set of  $C_1$  to at most one hybrid vertex of  $A_0 \cup A_{\geq 2}$ . The function  $t$  is put in the Appendix because it is complicated to define and to prove its properties.

Let us denote  $C_1(B_2) = \{S \in C_1 \mid a(S) \subseteq B_2\}$ .

**Lemma 12** *The function  $t$  has the following properties:*

(i)  $\forall S \in C_1(B_2), t(S)$  is equal to a hybrid vertex of  $(A_0 \cup A_{\geq 2}) \setminus B_2$ .

(ii)  $\forall h_0 \in A_0, t^{-1}(h_0)$  contains at most 2 split SN-sets of  $C_1(B_2)$ .

(iii)  $\forall h_0 \in A_{\geq 2}, t^{-1}(h_0)$  contains at most 1 split SN-set of  $C_1(B_2)$ .

*Proof:* See Lemma 17 in the Appendix. □

**Definition 8** *For any  $h \in B_2$ , the function  $s$  assigns for  $h$  a hybrid vertex in  $A_0 \cup A_{\geq 2}$  as follows:*

- If  $h \in A_0 \cup A_{\geq 2}$  then  $s(h) = h$ .

- Otherwise,  $h \in A_1$ , let  $S = a^{-1}(h)$ , so  $S \in C_1(B_2)$ , then we define  $s(h) = t(S)$ .

**Lemma 13** (i) *For any  $h \in B_2$ ,  $s(h)$  is a hybrid vertex of  $A_0 \cup A_{\geq 2}$ .*

(ii) *For any  $h \in A_0, |s^{-1}(h)| \leq 2$ .*

(iii) *For any  $h \in A_{\geq 2}, |s^{-1}(h)| \leq 1$ .*

(iv)  $|B_2| \leq (2|A_0| + |A_{\geq 2}|)$ .

*Proof:* (i) Following the definition of  $s$ , and Claim (i) of Lemma 12,  $s(h)$  is always defined and equal to one hybrid vertex of  $A_0 \cup A_{\geq 2}$ .

(ii)  $\forall h \in A_0$ , if  $h \in B_2$ , then by definition of  $s$  we have  $s(h) = h$ , i.e  $h \in s^{-1}(h)$ . Suppose that there exists another  $h' \neq h$  such that  $h' \in s^{-1}(h)$ , so  $s(h')$  is defined by using the function  $t$ . It means that  $h' \in A_1$  and  $s(h') = t(S') = h$  where  $S' = a^{-1}(h')$ . By Claim (i) of Lemma 12,  $h \notin B_2$ , a contradiction. So,  $h$  is the only element of  $s^{-1}(h)$  and we are done.

If  $h \notin B_2$ , then  $h \notin s^{-1}(h)$  because the function  $s$  is defined only on  $B_2$ . Suppose that  $\exists h' \neq h$  in  $B_2$  such that  $h' \in s^{-1}(h)$ . So the split SN-set  $S' = a^{-1}(h')$  is in  $C_1(B_2)$  and  $s(h')$  is defined by using the function  $t$ , i.e  $s(h') = t(S') = h$ . Following Claim (ii) of Lemma 12, there are at most 2 split SN-sets  $S'$  of  $C_1(B_2)$  such that  $S' = t^{-1}(h)$ . Each  $S'$  corresponds to only one hybrid vertex  $h'$ . So, there are at most two  $h'$  such that  $h' \in s^{-1}(h)$ .

(iii) Similarly as (ii) by using Claim (iii) of Lemma 12.

(iv) This claim is directly deduced from the 3 previous claims (see Figure 16(c)).  $\square$

**Theorem 1** *If  $\mathcal{T}$  is consistent with a level- $k$  network  $N$ , then there exists a level- $k$  network  $N'$  with the same number of hybrid vertices of  $N$ , which has at most  $\lfloor \frac{4}{3}k \rfloor$  split SN-sets.*

*Proof:* According to Lemmas 11 (ii), 13 (iv), we have:

$$|\mathcal{C}| \leq \frac{4}{3}k + \frac{1}{3}|B_2| - |A_0| - \frac{1}{2}|A_{\geq 2}| \leq \frac{4}{3}k - \frac{1}{6}|B_2| \leq \frac{4}{3}k.$$

Therefore, by Lemma 7 and the assumption stated at the beginning of the section, if  $\mathcal{T}$  is consistent with a level- $k$  network  $N$ , then there exists a level- $k$  network  $N'$  with the same number of hybrid vertices of  $N$ , which has at most  $\lfloor \frac{4}{3}k \rfloor$  split SN-sets.  $\square$

**Remark:** Up to now we do not have any example achieving this bound. Therefore it is possible that the bound  $\lfloor \frac{4}{3}k \rfloor$  is not optimal, in fact each time we were able to construct an example of a network which reaches this bound, we can modify it into another network which has a smaller number of split SN-sets without changing the number of hybrid vertices. Especially, for the cases of  $k \leq 8$ , it can be checked case by case by using Lemmas 6 and 7 that the number of split SN-sets in the restricted networks class is bounded by  $k$ .

## 5 Constructing a minimum phylogenetic network.

**Theorem 2** *For every  $\mathcal{T}$  set of dense triplets and a fixed  $k$ , algorithm 1 takes time  $O(|\mathcal{T}|^{k+1}n^{\lfloor \frac{4k}{3} \rfloor + 1})$  and return a minimum level- $k$  network consistent with  $\mathcal{T}$  if there is any.*

*Proof:* **The correctness of Algorithm 1**

This algorithm consists of constructing a network on each SN-set following a non-decreasing order of size (the loop For at line 3). So for each iteration corresponding to a SN-set  $A$ , a minimum level- $k$  network on each SN-set smaller than  $A$  is already constructed. Remark that if  $N$  is a minimum level- $k$  network consistent with  $\mathcal{T}$  then each  $N_i$  is a minimum level- $k$  network consistent with  $\mathcal{T}|l(N_i)$ . So, by constructing for each  $A$  a minimum level- $k$  network  $N_A^m$  consistent with  $\mathcal{T}|A$ , finally  $N_{\mathcal{L}}^m$  is a minimum level- $k$  network consistent with  $\mathcal{T}$ .

For each SN-set  $A$ , we must find a partition of  $A$  which is the one in a minimum level- $k$  network consistent with  $\mathcal{T}|A$ . By Lemma 3, each partition is determined by a set of split SN-sets, and each one is a non-singleton descendant of  $A$ . By Theorem 1, we need only to check all the possible sets

<p><b>Data:</b> A dense triplet set <math>\mathcal{T}</math> on the set <math>\mathcal{L}</math> of <math>n</math> species, and a fixed <math>k</math></p> <p><b>Result:</b> A minimum level-<math>k</math> network consistent with <math>\mathcal{T}</math>, if there exists one</p> <pre style="font-family: monospace; font-size: 0.9em;"> 1 Compute the SN-tree of <math>\mathcal{T}</math>; 2 For every singleton <math>u</math> of <math>\mathcal{L}</math>, let <math>N_u^m</math> be the network containing only one leaf <math>u</math>; 3 <b>for</b> (each non-singleton SN-set <math>A</math> of <math>\mathcal{T}</math>, in non-decreasing order of size) <b>do</b> 4   <math>\mathcal{T}' = \mathcal{T} A; N_A^m = null; min = 0;</math> 5   <b>for</b> (each set <math>\mathcal{C}</math> of at most <math>\lfloor \frac{4}{3}k \rfloor</math> disjoint non-singleton descendants of <math>A</math>) <b>do</b> 6     <math>\mathcal{P} \leftarrow</math> the partition of <math>A</math> inferred from <math>\mathcal{C}</math>; 7     <math>N_A^m \leftarrow</math> a level-<math>k</math> network consistent with <math>\mathcal{T}</math> and has <math>\mathcal{P}</math> as its partition; 8     <math>min \leftarrow</math> the number of hybrid vertices in <math>N_A^m</math>; 9     <b>for</b> (each level-<math>k</math> network <math>N_A</math> consistent with <math>\mathcal{T}</math> and has <math>\mathcal{P}</math> as its partition) <b>do</b> 10      <b>if</b> (the number of hybrid vertices of <math>N_A &lt; min</math>) <b>then</b> 11        <math>min \leftarrow</math> the number of hybrid vertices of <math>N_A</math>; 12        <math>N_A^m = N_A</math>; 13      <b>if</b> (<math>N_A^m = null</math>) <b>then</b> 14        <b>return</b> null; 15 <b>return</b> <math>N_{\mathcal{L}}^m</math> </pre>
---

**Algorithm 1:** Constructing a minimum level- $k$  phylogenetic network

of descendants of  $A$  having cardinality at most  $\lfloor \frac{4}{3}k \rfloor$ . That is what the loop For at line 5 does. Next, for each partition  $\mathcal{P}$  inferred from each set of split SN-sets, the algorithm checks all level- $k$  networks which are consistent with  $\mathcal{T}$  and have  $\mathcal{T}$  as their partition, and then chooses the one which contains the minimum number of hybrid vertices. The finding network is stocked in  $N_A^m$ . That is what the loop For at line 9 does. If  $N_A^m = null$ , i.e there is not any level- $k$  network consistent with  $\mathcal{T}|A$ , then we conclude that there is not any level- $k$  network consistent with  $\mathcal{T}$ .

### The complexity of Algorithm 1

- The SN-tree of  $\mathcal{T}$  can be computed in  $O(n^3)$  (using the algorithm in [10]).
- The first loop For: There are at most  $O(n)$  non-singleton SN-sets, so there are at most  $O(n)$  constructions.
- The second loop For repeats at most  $n^{\lfloor \frac{4}{3}k \rfloor}$  times because  $A$  has at most  $O(n)$  non-singletons descendants, so there are at most  $n^{\lfloor \frac{4}{3}k \rfloor}$  possibilities for  $\mathcal{C}$ .
- In the body of the second loop For: based on Lemma 1, to construct a level- $k$  network consistent with  $\mathcal{T}'$  and has  $\mathcal{P}$  as its partition, there are two steps: First, we compute a level- $k$  simple network  $N_S$  consistent with  $\mathcal{T}' \nabla \mathcal{P}$ . Then, we replace each leaf of  $N_S$  by the subnetwork already found on the corresponding part of  $\mathcal{P}$ . According to [19], we can compute all level- $k$  simple networks consistent with  $\mathcal{T}' \nabla \mathcal{P}$  in time  $O(|\mathcal{T}' \nabla \mathcal{P}|^{k+1})$ , or in time  $O(|\mathcal{T}|^{k+1})$ . The times needed to compute the partition  $\mathcal{P}$  of  $A$  from the set of split SN-sets  $\mathcal{C}$  (Lemma 3), to replace each leaf of  $N_S$  by a subnetwork, are negligible compared to the time for computing all the simple networks. So this loop takes time  $O(|\mathcal{T}|^{k+1})$ .

Hence, the total complexity is  $O(|\mathcal{T}|^{k+1} n^{\lfloor \frac{4}{3}k \rfloor + 1})$ . □

**Corollary 1** *For every  $\mathcal{T}$  set of dense triplets, it is polynomial to compute a minimum level phylogenetic network consistent with  $\mathcal{T}$  which minimizes the number of hybrid vertices if the minimum level is restricted.*

*Proof:* It is easy to see that we can slightly modify Algorithm 1 so that it returns a minimum level network. Indeed, we try to construct a minimum level- $i$  network consistent with  $\mathcal{T}$  if there is any, in increasing order of  $i$ . Then, the first value of  $i$  that the algorithm returns a network corresponds to the minimum level of the networks consistent with  $\mathcal{T}$ . So the complexity is  $O(k|\mathcal{T}|^{k+1}n^{\lfloor \frac{4}{3}k \rfloor + 1})$  where  $k$  is the minimum level.  $\square$

## 6 Conclusion and perspectives

We proved that for any  $k$  fixed, we can construct a level- $k$  network having the minimum number of hybrid vertices, if there exists one, in polynomial time. Furthermore, if the minimum level of the networks consistent with  $\mathcal{T}$  is restricted, we can also construct one in polynomial time.

[17] implemented the algorithm for level-2 networks and applied it to some part of yeast genomic data. However, on a bigger data set, there does not exist any level-2 networks. So with our result, one could expect to practically find solution on real data, for small values of  $k$  (as for example with  $k \leq 5$ ).

For simple networks, [11, 10, 17] showed, there are efficient algorithms for level-1, level-2. However, for general level- $k$  networks, there exists only a  $O(|\mathcal{T}|^{k+1})$  algorithm [19]. Any improvement for this problem, even on small levels, will allow us to implement more efficiently our algorithm.

For any triplet set  $\mathcal{T}$  we can define its *Treerank*( $\mathcal{T}$ ) as the minimum  $k$  for which there exists a level- $k$  network representing  $\mathcal{T}$ . This measures the distance from  $\mathcal{T}$  to be consistent with a tree. This distance is measured in terms of the number of hybrid vertices. We proved in this paper that for dense triplet sets, and for any fixed  $k$ , checking if *Treerank*( $\mathcal{T}$ )  $\leq k$  can be done in polynomial time. Furthermore [16] proved the NP-hardness of the computation of the *Treerank*( $\mathcal{T}$ )  $\leq k$ . Therefore this parameter has a similar behavior on phylogenetic networks that treewidth or undirected graphs. Perhaps this analogy could yield further interesting structural insights as shown in [6] with a nice recursive construction.

Another question is under which conditions on the triplet set  $\mathcal{T}$  there is only one network consistent with  $\mathcal{T}$ . It would be also interesting to know whether the condition of density on the triplet set can be relaxed so that there is still a polynomial algorithm to construct a consistent level- $k$  network, if there is any, with any fixed  $k$ .

## Aknowledgements:

The authors wish to thank P. Gambette for many discussions on the subject and his careful reading of this version.

## Appendix

Function  $t$  in Section 4.

For any  $S$  in  $C_1$ ,  $a(S)$  contains only one hybrid vertex. So we denote this hybrid vertex by  $a_S$ . Conversely, if  $h$  is a hybrid vertex in  $A_1$ , then by denoting  $h = a_S$ , we imply that  $S$  is the split SN-set such that  $a(S) = \{h\}$ .

There can be several paths from  $lca(S)$  to  $a_S$ , among them there is one path, called  $P_S$ , which satisfies the following property:  $\forall S_1, S_2 \in C_1$ , if  $P_{S_1}, P_{S_2}$  have to common vertices  $u, v$  such that  $u$  is above  $v$  and the two subpaths of  $P_{S_1}$  and  $P_{S_2}$  from  $u$  to  $v$  are the same. It is easy to see that there exists always such a path for each split SN-sets of  $C_1$ . Indeed, if there exist such two vertices  $u, v$ , then we need only to change the subpath of  $P_{S_2}$  from  $u$  to  $v$  to be the same as the subpath of  $P_{S_1}$  from  $u$  to  $v$ . The new path  $P_{S_2}$  is always a path from  $lca(S_2)$  to  $a_{S_2}$  (Figure 18).

We define three sets of hybrid vertices of  $P_S$  different from  $a_S$  as follows:

$$I_S^0 = \{h' \text{ is on } P_S \mid h' \in A_0 \text{ and } h' \neq a_S\}$$

$I_S^1 = \{h' \text{ is on } P_S \mid h' \in A_1, h' \neq a_S, \text{ and } P_S \text{ intersects with } P_{S'} \text{ at a hybrid vertex above } h' \text{ where } S' = a^{-1}(h')\}$

$I_S^2 = \{h' \text{ is on } P_S \mid h' \in A_2, h' \neq a_S, \text{ and } P_S \text{ intersects with a path from a lca of } S' \text{ at a hybrid vertex above } h' \text{ where } S' = a^{-1}(h')\}$

$$I_S = I_S^0 \cup I_S^1 \cup I_S^2.$$

**Example 2** For example, let  $S$  be a split SN-set of  $C_1$  such that the path  $P_S$  from  $lca(S)$  to  $a_S$  contains 4 hybrid vertices  $h_1, h_2, h_3, h_4$  as in in Figure 19.

Suppose that  $h_1 \in A_1, h_2 \in A_0, h_3 \in A_1, h_4 \in A_2$  and let  $S_i = a^{-1}(h_i)$  for  $i = 1, 3, 4$ . So,  $S_1 \in C_1, S_3 \in C_1, S_4 \in C_2$ . The position of  $lca(S_i)$  is as in the figure.

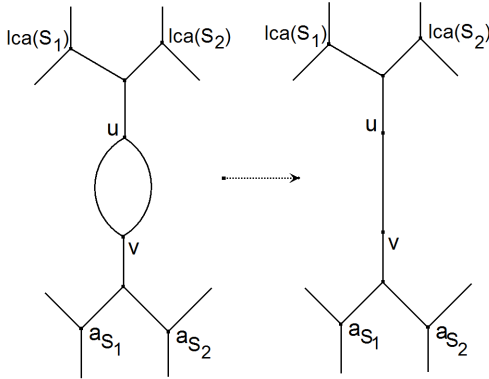

Figure 18: Property of  $P_S$  for any  $S \in C_1$

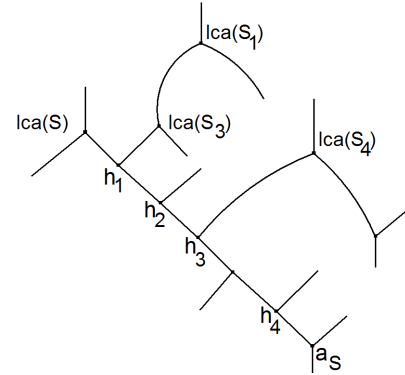

Figure 19:  $h_2 \in I_S^0, h_3 \in I_S^1, h_4 \in I_S^2$

We have  $h_2 \in I_S^0, h_3 \in I_S^1, h_4 \in I_S^2$  and  $h_1 \notin I_S$ .

Next, the function  $\mathbf{t}$  is defined as follows.

**Definition 9**  $\forall S \in C_1$ , if  $I_S = \emptyset$  then  $t(S) = \text{null}$ . Otherwise, let  $h_0$  be the highest hybrid vertex of  $I_S$ , so:

If  $h_0 \in I_S^0 \cup I_S^2$  then  $t(S) = h_0$ .

If  $h_0 \in I_S^1$ , then  $t(S) = t(S_0)$ , and we denote  $S \rightarrow S_0$  where  $S_0 = a^{-1}(h_0) \in C_1$ .

For example, in Figure 20(a) suppose that  $h_1 \in a(S_1), h_2 \in a(S_2)$ , and  $h_0 \in A_0$ , then  $t(S) = h_0$ . In Figure 20(b), suppose that  $h_1 \in a(S_1)$ , and  $h_0 = a_{S_0}$ , then  $t(S) = t(S_0)$  and  $S \rightarrow S_0$ .

The following lemmas will be used to prove some properties of the function  $t$ .

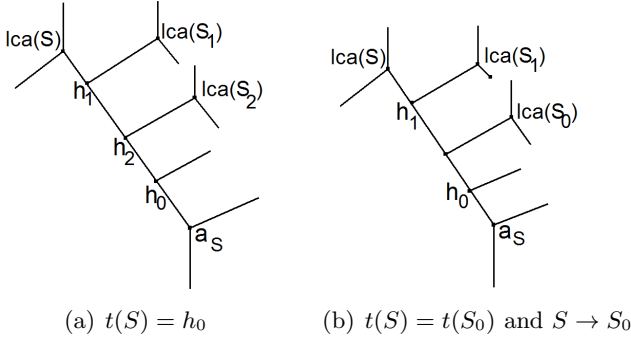

Figure 20: The function  $t$ .

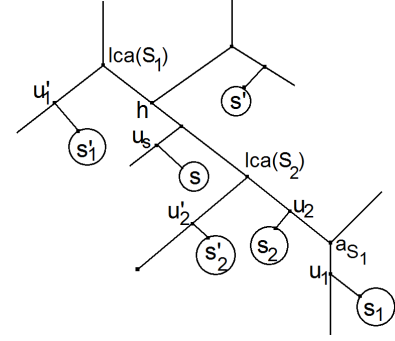

Figure 21: Proof of Lemma 14

**Lemma 14**  $\forall S_1 \in C_1, \forall S_2 \in C_0 \cup C_1$ , if  $lca(S_2)$  is on  $P_{S_1}$  then there exists a hybrid vertex in  $A_0$  which is on  $P_{S_1}$  and above  $lca(S_2)$ .

*Proof:* By definition, because  $a_{S_1} \in a(S_1)$ , then there exists a child  $s_1$  of  $S_1$  such that either  $a_{S_1} = u_1$  or there is a path  $a_{S_1} \rightarrow u_1$ . Let  $s'_1$  be another child of  $S_1$  such that  $lca(s_1, s'_1) = lca(S_1)$  (Figure 21). So, there is not any hybrid vertex on any path from  $lca(S_1)$  to  $u'_1$ , because otherwise  $a(S_1)$  contains another hybrid vertex different from  $a_{S_1}$ , a contradiction with the fact that  $S_1 \in C_1$ . It implies that every path from a vertex above  $lca(S_1)$  to  $u'_1$  must pass  $lca(S_1)$ .

Let  $s_2, s'_2$  be two children of  $S_2$  such that  $lca(s_2, s'_2) = lca(S_2)$ . Suppose that there is a hybrid vertex on  $P_{S_1}$  below  $lca(S_1)$  and above  $lca(S_2)$ , then let  $h$  be the lowest one. If  $h \in A_0$  then we are done. Suppose that  $h$  is not in  $A_0$ , let  $S = a^{-1}(h)$ , then there is a child  $s$  of  $S$  and a path  $h \rightarrow u_s$ . Let  $s'$  be another child of  $S$  which is not below  $h$ .  $S$  has always such a child because otherwise a lca of  $S$  will be below  $h$ . The later is a contradiction because  $h \in a(S)$  so  $h$  is in  $N[S]$ , i.e a lca of  $S$  must be above or equal to  $h$ . In order that  $s_2|ss'$  is consistent with  $N$ , there must be a path  $c$  from the root to  $u_2$  which is vertex-disjoint with  $N[S']$ . As supposed,  $h$  is the lowest hybrid vertex on  $P_{S_1}$  below  $lca(S_1)$  and above  $lca(S_2)$ , then there is no hybrid vertex on  $P_S$  which is below  $h$  and above  $lca(S_2)$ . Hence,  $c$  must intersect with the path from  $lca(S_2)$  to  $u_2$  at a hybrid vertex. Similarly for  $s'_2|ss'$ , there must be a hybrid vertex below  $lca(S_2)$  and above  $u'_2$ . It means that  $a(S_2)$  contains at least two elements, a contradiction.

Hence, there is not any hybrid vertex on  $P_{S_1}$  below  $lca(S_1)$  and above  $lca(S_2)$ . By the same argument as above for  $s_2|s_1s'_1$  and  $s'_2|s_1s'_1$ , we deduce that there must exist a hybrid vertex below  $lca(S_2)$ , above  $u_2$ , and a hybrid vertex below  $lca(S_2)$ , above  $u'_2$ . It means that  $a(S_2)$  contains at least two elements, a contradiction.  $\square$

**Lemma 15** For any  $S \in C_1$ , let  $h$  be a hybrid vertex of  $P_S$  which is in  $B_2$ . Then there is a hybrid vertex of  $A_0$  above  $h$  on  $P_S$ .

*Proof:* Because  $h \in B_2$ , then there exist  $T, T' \in C_0$  such that  $h \in b(T) \cap b(T')$ . By definition,  $h \notin N[T]$  and there exist a path  $c_T : V_T \leftrightarrow_T h$  where either  $V_T = lca(T)$  or there is a child  $t$  of  $T$  such that  $V_T = u_t$ . The same for  $T'$  we have  $c_{T'}$ .

We will prove that there exists a path  $c_S$  from the root to  $lca(S)$  which is vertex-disjoint with  $N[T]$  (Figure 22(a)). Let  $s$  be the child of  $S$  such that either  $u_s = a_S$  or there is path  $a_S \rightarrow u_s$ . Let  $s'$  be another child of  $S$  such that  $lca(s, s') = lca(S)$ . There is not any hybrid vertex above

$u_{s'}$  and below  $lca(S)$  because otherwise  $a(S)$  contains another hybrid vertex different from  $a_S$ . By Lemma 4 (iii), there is a path  $c'$  from the root to  $u_{s'}$  which is vertex disjoint with  $N[T]$ .  $c'$  must pass  $lca(S)$  because otherwise there must be a hybrid vertex above  $u_{s'}$  and below  $lca(S)$ . Let  $c_S$  be the subpath of  $c'$  from the root to  $lca(S)$ , so  $c_S$  is also vertex-disjoint with  $N[T]$ .

The 3 paths  $c_T, c_{T'}, P_S$  pass  $h$ , so at least two among them have common vertices above  $h$ . If these two paths are  $c_T, c_{T'}$ , then by the same argument with the proof of Lemma 10 where  $T, T'$  correspond to  $Y, Z$ , we deduce a contradiction. So one of these two paths is  $P_S$ , i.e  $P_S$  has common vertex above  $h$  with either  $c_T$  or  $c_{T'}$ , suppose that it is  $c_T$ . There are the following cases:

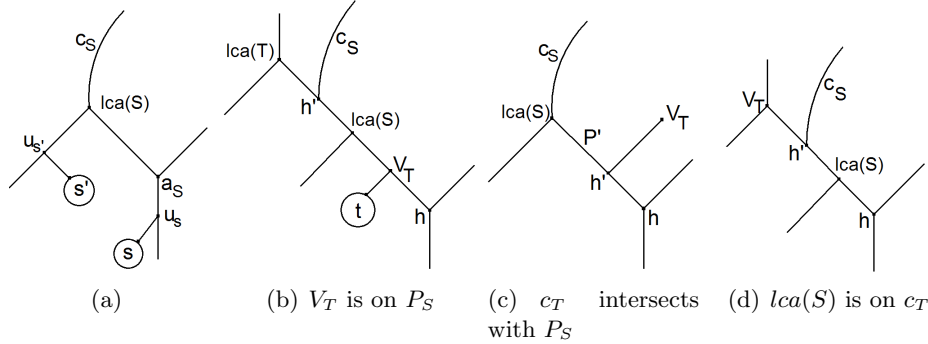

Figure 22: Proof of Lemma 15

-  $V_T$  is on  $P_S$ : If  $V_T = lca(T)$ , then by applying Lemma 14 with  $S_1 = S, S_2 = T$ , there is a hybrid vertex of  $A_0$  on  $P_S$  which is above  $lca(T)$ , so above  $h$ , we are done.

Otherwise, there is a child  $t$  of  $T$  such that  $V_T = u_t$ . We consider the position of  $lca(T)$ : either there is a path from  $lca(T)$  to  $V_T$  which intersects with  $P_S$  at a hybrid vertex, or  $lca(T)$  is above  $lca(S)$ . The first case implies that  $a(S) \neq \emptyset$ , a contradiction. For the second case (Figure 22(b)), let consider the path  $c_S$ . Because  $c_S$  is vertex disjoint with  $N[T]$ , then  $lca(T)$  is not on  $c_S$ . It means that  $c_S$  intersects with a path from  $lca(T)$  to  $V_T$  at a hybrid vertex  $h'$ . It also implies that  $a(T) \neq \emptyset$ , a contradiction.

-  $c_T$  intersects with  $P_S$  at a hybrid vertex  $h'$  above  $h$  (Figure 22(c)): Then every path from the root to  $h'$  must have common vertex with  $N[T]$  because  $c_T$  is a path  $V_T \leftrightarrow_T h$ . Since  $N[T]$  does not contain any hybrid vertex, then we deduce from the later that every path from the root to  $h'$  must pass  $lca(T)$  (\*). As proved above, there is a path  $c_S$  from the root to  $lca(S)$  which is vertex-disjoint with  $N[T]$ . Let  $P'$  be the subpath of  $P_S$  from  $lca(S)$  to  $h'$ , and  $c$  be the path consisting of  $c_S$  and  $P'$ . Following (\*),  $c$  must pass  $lca(T)$ . Because  $c_S$  is vertex disjoint with  $N[T]$  then  $lca(T)$  must be on  $P'$ , or on  $P_S$ . Hence, we return to the previous case.

-  $lca(S)$  is on  $c_T$  (Figure 22(d)): As proved above, there is a path  $c_S$  from the root to  $lca(S)$  which is vertex-disjoint with  $N[T]$ . This path intersects with  $c_T$  at a hybrid vertex  $h'$  above  $lca(S)$ . The subpath of  $c_S$  from the root to  $h'$  is also vertex disjoint with  $N[T]$ , contradicting the fact that  $c_T$  is a path  $V_T \leftrightarrow_T h$ .  $\square$

Let us denote  $C_1(B_2) = \{S \in C_1 | a(S) \subseteq B_2\}$ . To define the function  $s$  (Definition 8), we need only to know the restriction of  $t$  to  $C_1(B_2)$ .

**Lemma 16** (i)  $\forall S_1, S_2 \in C_1$  if  $S_1 \rightarrow S_2$  then  $S_2 \notin C_1(B_2)$ .

(ii)  $\forall S_1, S_2 \in C_1$  such that  $S_1 \neq S_2$ , if  $S_1 \rightarrow S'_1$  and  $S_2 \rightarrow S'_2$  then  $S'_1 \neq S'_2$ .

*Proof:* (i) Suppose that  $S_2 \in C_1(B_2)$ , then  $a_{S_2} \in B_2$ . Because  $S_1 \rightarrow S_2$  then by Definition 9,  $a_{S_2}$  is on  $P_{S_1}$ . According to Lemma 15, there is a hybrid vertex of  $A_0$  on  $P_{S_1}$  above  $a_{S_2}$ . Then, this hybrid vertex is in  $I_{S_1}^0$ . It is a contradiction because  $a_{S_2}$  must be the highest hybrid vertex of  $I_{S_1}$ . Hence,  $S_2 \notin C_1(B_2)$ .

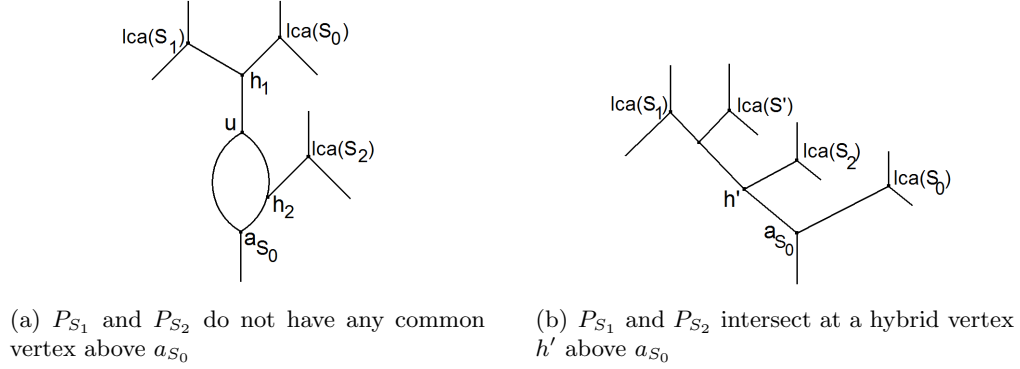

Figure 23: Proof of Lemma 16 (ii)

(ii) Suppose that  $S'_1 = S'_2 = S_0$ . So, the 2 paths  $P_{S_1}, P_{S_2}$  pass  $a_{S_0}$ , then there are the following cases:

-  $P_{S_1}$  and  $P_{S_2}$  do not have any common vertex above  $a_{S_0}$  (Figure 23(a)). Because  $S_1 \rightarrow S_0$ , then  $P_{S_1}$  intersects with  $P_{S_0}$  at a hybrid vertex  $h_1$  above  $a_{S_0}$ . Similarly,  $P_{S_2}$  intersects with  $P_{S_0}$  at a hybrid vertex  $h_2$  above  $a_{S_0}$ . Suppose that  $h_1$  is above  $h_2$ , the case where  $h_2$  is above  $h_1$  will be treated similarly. Note that the two paths  $P_{S_0}$  and  $P_{S_1}$  have two common vertices:  $h_1$  and  $a_{S_0}$ . Then, by the property that we impose on  $P_S$  for any split SN-set in  $C_1$ , the two subpaths of  $P_{S_1}$  and  $P_{S_2}$  from  $h_1$  to  $a_{S_0}$  are the same.  $h_2$  is a vertex on the subpath of  $P_{S_2}$  from  $h_1$  to  $a_{S_0}$ . However,  $h_2$  is not on the subpath of  $P_{S_1}$  from  $h_1$  to  $a_{S_0}$  because otherwise  $P_{S_1}$  and  $P_{S_2}$  have a common vertex above  $a_{S_0}$ . Hence,  $h_2$  is on one subpath but not on the other, i.e these two subpaths can not be the same, a contradiction.

-  $lca(S_1)$  is on  $P_{S_2}$ , then by Lemma 14, there is a hybrid vertex  $h_0$  of  $A_0$  on  $P_{S_1}$  above  $lca(S_2)$ . It means that  $h_0 \in I_{S_1}^0$  and is above  $a_{S_0}$ , contradicting  $a_{S_0}$  being the highest hybrid vertex of  $I_{S_1}$ . Similarly for the case  $lca(S_2)$  is on  $P_{S_1}$ .

-  $P_{S_1}$  and  $P_{S_2}$  intersect at a hybrid vertex  $h'$  above  $a_{S_0}$  (Figure 23(b)). By definition 9,  $h' \notin I_{S_1} \cup I_{S_2}$ . We deduce that  $h' \in A_{\geq 1}$ . Let  $S' = a^{-1}(h')$ , we see that a path from a lca of  $S'$  to  $h'$  must have common vertex above  $a_{S_0}$  with either  $P_{S_1}$  or  $P_{S_2}$ , or  $h'$  is either in  $I_{S_1}^1 \cup I_{S_1}^2$  or in  $I_{S_2}^1 \cup I_{S_2}^2$ , a contradiction.

So  $S'_1 \neq S'_2$ . □

**Lemma 17** *The function  $t$  has the following properties:*

- (i)  $\forall S \in C_1(B_2)$ ,  $t(S)$  is defined and equal to a hybrid vertex of  $(A_0 \cup A_{\geq 2}) \setminus B_2$ .
- (ii)  $\forall h_0 \in A_0$ ,  $t^{-1}(h_0)$  contains at most 2 split SN-sets of  $C_1(B_2)$ .
- (iii)  $\forall h_0 \in A_{\geq 2}$ ,  $t^{-1}(h_0)$  contains at most 1 split SN-set of  $C_1(B_2)$ .



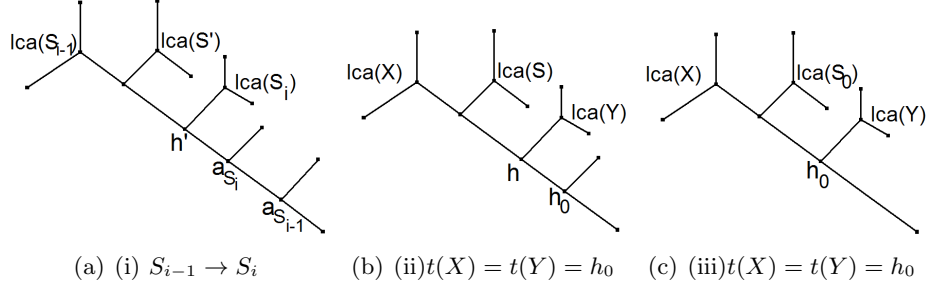

Figure 24: Proof of Lemma 17

*Proof:* (i) Let  $S \in C_1(B_2)$ , suppose that we have a chain of split SN-sets  $S \rightarrow S_1 \cdots \rightarrow S_m$  defined as in Definition 9.

Firstly, we will prove that  $S_i \neq S$  for any  $i$ . It is obvious that  $S \neq S_1$  because  $S \rightarrow S_1$ . Suppose that  $S_i = S$  for a certain  $i > 1$ , then  $S_{i-1} \rightarrow S$ . By Claim (i) of Lemma 16,  $S \notin C_1(B_2)$ , a contradiction.

Next, we will prove that  $S_i \neq S_j$  for any  $i, j = 1, \dots, m$ . Suppose otherwise, let  $i$  be the smallest index such that there exists  $j$  greater than  $i$  and  $S_i = S_j = S'$ . If  $i > 1$ , then we have  $S_{i-1} \rightarrow S_i$  and  $S_{j-1} \rightarrow S_j$ . However,  $S_{i-1} \neq S_{j-1}$  because  $i$  is the smallest index having this property, so it is a contradiction with Claim (ii) of Lemma 16. If  $i = 1$ , we have  $S \rightarrow S_i$  and  $S_{j-1} \rightarrow S_j$ . However, as proved recently,  $S \neq S_{j-1}$ , so it is a contradiction with Claim (ii) of Lemma 16.

Hence, the recursive calls do not loop, and since the number of split SN-Sets is finite, then  $t(S)$  is always defined.

Now, we show that  $\forall S \in C_1(B_2)$ ,  $t(S) \neq null$ . Because  $S \in C_1(B_2)$ , then by Lemma 15, there is a hybrid vertex of  $A_0$  on  $P_S$  above  $a_S$ . In other words,  $I_S^0 \neq \emptyset$ , i.e  $I_S \neq \emptyset$ . Let  $h_0$  be the highest vertex of  $I_S$ , if  $h_0 \in I_S^0 \cup I_S^2$ , then by definition  $t(S) = h_0 \neq null$ . Suppose that  $h_0 \in I_S^1$ , and to define  $t(S)$  we pass a chain of other split SN-sets:  $S \rightarrow S_1 \rightarrow \cdots \rightarrow S_i$  and suppose that  $I_{S_i} = \emptyset$ , i.e  $t(S_i) = null$ . Because  $S_{i-1} \rightarrow S_i$ , then the two paths  $P_{S_{i-1}}$  and  $P_{S_i}$  pass  $a_{S_i}$  and have common vertex above  $a_{S_i}$ . There are the following cases:

- $lca(S_i)$  is on  $P_{S_{i-1}}$ . Then by Lemma 14, there is a hybrid vertex of  $A_0$  on  $P_{S_{i-1}}$ , above  $lca(S_i)$ , so above  $a_{S_i}$ . It means that this hybrid vertex is in  $I_{S_{i-1}}^0$  and above  $a_{S_i}$ , contradicting  $a_{S_i}$  being the highest hybrid vertex in  $I_{S_{i-1}}$ .

- $lca(S_{i-1})$  is on  $P_{S_i}$ . Then by Lemma 14, there is a hybrid vertex of  $A_0$  on  $P_{S_i}$  above  $lca(S_{i-1})$ . It means that this hybrid vertex is in  $I_{S_i}^0$ , contradicting  $I_{S_i} = \emptyset$ .

- $P_S$  and  $P_{S_{i-1}}$  intersect at a hybrid vertex  $h'$  above  $a_{S_i}$  (Figure 24(a)). Because  $a_{S_i}$  is the highest vertex of  $I_{S_{i-1}}$ , then  $h' \notin I_{S_{i-1}}$ . It implies that  $h' \in A_{\geq 1}$ . Let  $S' = a^{-1}(h')$ . By the assumption,  $I_{S_i} = \emptyset$ , then  $h' \notin I_{S_i}$ . It means that  $P_{S'}$  does not have common vertex above  $h'$  with  $P_{S_i}$ . So  $P_{S'}$  must have common vertex above  $h'$  with  $P_{S_{i-1}}$ . In other words,  $h' \in I_{S_{i-1}}$ , a contradiction.

So  $t(S_i) \neq null$  or  $t(S) \neq null$ . Let  $t(S_i) = h$ , we deduce from definition of  $t$  that  $h$  is a hybrid vertex of  $A_0 \cup A_{\geq 2}$ . If  $h \in B_2$ , then by Lemma 15, there is a hybrid vertex of  $A_0$  on  $P_{S_i}$  above  $h$ . Then, this hybrid vertex is in  $I_{S_i}^0$ , contradicting  $h$  being the highest vertex of  $I_{S_i}$ . Hence,  $h \notin B_2$ , i.e  $h \in (A_0 \cup A_{\geq 2}) \setminus B_2$ .

(ii) Let  $h_0$  be a hybrid vertex in  $A_0$ . Suppose that there are 3 distinct split SN-sets  $X_0, Y_0, Z_0$

of  $C_1(B_2)$  such that  $t(X_0) = t(Y_0) = t(Z_0) = h_0$ .

Suppose that before reaching  $h_0$ , each one passes a chain of split SN-sets:  $X_0 \rightarrow \cdots \rightarrow X$ ,  $Y_0 \rightarrow \cdots \rightarrow Y$ ,  $Z_0 \rightarrow \cdots \rightarrow Z$  and  $h_0$  is the highest hybrid vertex of  $I_X, I_Y, I_Z$ . Following Claim (i) of Lemma 16, in each chain, only the first split SN-set, i.e  $X_0, Y_0, Z_0$ , is in  $C_1(B_2)$ , the others are not. By Claim (ii) of Lemma 16, since  $X_0, Y_0, Z_0$  are distinct then these chains do not have common split SN-sets. In other words,  $X, Y, Z$  are also distinct. So, we need only to show that  $h_0$  can not be the highest hybrid vertex of  $I_X, I_Y, I_Z$ . Suppose otherwise, the 3 paths  $P_X, P_Y, P_Z$  pass  $h_0$ , then among them there are at least 2, for example  $P_X$  and  $P_Y$ , which have common vertex above  $h_0$ . If  $lca(Y)$  is on  $P_X$ , then by Lemma 14, there is a hybrid vertex of  $A_0$  on  $P_X$ , above  $lca(Y)$ , i.e above  $h_0$ . Then, this hybrid vertex is in  $I_X^0$ . It is a contradiction because  $h_0$  is supposed to be the highest hybrid vertex of  $I_X$ . Similarly for the case where  $lca(X)$  is on  $P_Y$ . If  $P_X$  and  $P_Y$  intersect at a hybrid vertex  $h$  above  $h_0$  (Figure 24(b)), then  $h \notin I_X \cap I_Y$ . So,  $h \in A_{\geq 1}$ . Let  $S = a^{-1}(h)$ , a certain path from a lca of  $S$  to  $h$  must have common vertex above  $h$  with either  $P_X$ , or  $P_Y$ . So, either  $h \in I_X^1 \cup I_X^2$  or  $h \in I_Y^1 \cup I_Y^2$ , a contradiction.

(iii) Let  $h_0$  be a hybrid vertex in  $A_{\geq 2}$ , and  $S_0 = a^{-1}(h_0)$ . Suppose that there are 2 split SN-sets  $X_0, Y_0$  of  $C_1(B_2)$  such that  $t(X_0) = t(Y_0) = h_0$ .

Suppose that before reaching  $h_0$ , each one passes a chain of split SN-sets:  $X_0 \rightarrow \cdots \rightarrow X$ ,  $Y_0 \rightarrow \cdots \rightarrow Y$ , and  $h_0$  is the highest hybrid vertex of  $I_X, I_Y$ . Similarly with Claim (ii),  $X_0, Y_0$  are the only split SN-sets of  $C_1(B_2)$  in these 2 chains and  $Y, Z$  are distinct. So, we have to show that  $h_0$  can not be the highest hybrid vertex of  $I_X, I_Y$ . Suppose otherwise, since  $P_X, P_Y$  pass  $h_0$  then we have the following cases. The cases that  $lca(Y)$  is on  $P_X$ , or  $lca(X)$  is on  $P_Y$ , or  $P_X, P_Y$  intersect at a hybrid vertex  $h$  above  $h_0$  can be proved to be contradictions by the same argument with Claim (ii). The last case is the case where  $P_X$  and  $P_Y$  intersect at  $h_0$  (Figure 24(c)). Because  $h_0 \in A_{\geq 2}$ , then there is a split SN-set  $S_0 = a^{-1}(h_0)$ . A certain path from a lca of  $S_0$  to  $h_0$  must have common vertex above  $h_0$  with either  $P_X$  or  $P_Y$ . It means that either  $h_0 \in I_X$  or  $h_0 \in I_Y$ , a contradiction.  $\square$

## References

- [1] Alfred V. Aho, Yehoshua Sagiv, Thomas G. Szymanski, and Jeffrey D. Ullman. Inferring a tree from lowest common ancestors with an application to the optimization of relational expressions. *SIAM J. Comput.*, 10(3):405–421, 1981.
- [2] M. Arenas, G. Valiente, and D. Posada. Characterization of reticulate networks based on the coalescent with recombination. *Mol Biol Evol*, 25(12):2517–2520, 2008.
- [3] Jaroslaw Byrka, Pawel Gawrychowski, Katharina T. Huber, and Steven Kelk. Worst-case optimal approximation algorithms for maximizing triplet consistency within phylogenetic networks. *J. Discrete Algorithms*, 8(1):65–75, 2010.
- [4] Semple C. In: *Gascuel O, Steel M, editors. Reconstructing Evolution: New Mathematical and Computational Advances*. Oxford University Press, 2007.
- [5] Charles Choy, Jesper Jansson, Kunihiro Sadakane, and Wing-Kin Sung. Computing the maximum agreement of phylogenetic networks. *Theor. Comput. Sci.*, 335(1):93–107, 2005.

- [6] Philippe Gambette, Vincent Berry, and Christophe Paul. The structure of level-k phylogenetic networks. In *CPM*, pages 289–300, 2009.
- [7] Leszek Gasieniec, Jesper Jansson, Andrzej Lingas, and Anna Östlin. Inferring ordered trees from local constraints. In *CATS*, pages 67–76, 1998.
- [8] Dan Gusfield, Dean Hickerson, and Satish Eddhu. An efficiently computed lower bound on the number of recombinations in phylogenetic networks: Theory and empirical study. *DAM*, 155(6-7):806–830, 2007.
- [9] Monika Rauch Henzinger, Valerie King, and Tandy Warnow. Constructing a tree from homeomorphic subtrees, with applications to computational evolutionary biology. *Algorithmica*, 24(1):1–13, 1999.
- [10] Jesper Jansson, Nguyen Bao Nguyen, and Wing-Kin Sung. Algorithms for combining rooted triplets into a galled phylogenetic network. *SIAM J. Comput.*, 35(5):1098–1121, 2006.
- [11] Jesper Jansson and Wing-Kin Sung. Inferring a level-1 phylogenetic network from a dense set of rooted triplets. *Theor. Comput. Sci.*, 363(1):60–68, 2006.
- [12] L. Nakhleh. In: Heath L, Ramakrishnan N, editors. *Problem Solving Handbook in Computational Biology and Bioinformatics*. Springer, 2009.
- [13] Gambette Phillippe. Who’s who in phylogenetic networks, 2010. available at <http://www.lirmm.fr/gambette/phylogeneticnetworks/>.
- [14] A. Schrijver. *Combinatorial Optimization - Polyhedra and Efficiency*. Springer, 2003.
- [15] Thu-Hien To and Michel Habib. Level-k phylogenetic networks are constructable from a dense triplet set in polynomial time. In *CPM*, pages 275–288, 2009.
- [16] L. van Iersel and S. Kelk. When two trees go to war. *Journal of Theoretical Biology*, 269(1):245–255, 2011.
- [17] Leo van Iersel, Judith Keijsper, Steven Kelk, Leen Stougie, Ferry Hagen, and Teun Boekhout. Constructing level-2 phylogenetic networks from triplets. *IEEE/ACM Trans. Comput. Biology Bioinform.*, 6(4):667–681, 2009.
- [18] Leo van Iersel and Steven Kelk. Constructing the simplest possible phylogenetic network from triplets. In *ISAAC*, pages 472–483, 2008.
- [19] Leo van Iersel, Steven Kelk, and Matthias Mnich. Uniqueness, intractability and exact algorithms: Reflections on level-k phylogenetic networks. *J. Bioinformatics and Computational Biology*, 7(4):597–623, 2009.