

Generation of Hidden Optical-Polarization: Squeezing and Non-Classicality

Gyaneshwar K. Gupta^{1*}, Akhilesh Kumar², Ravi S. Singh^{1#}

¹Department of Physics, DDU Gorakhpur University, Gorakhpur-273009 (U.P.) – INDIA

²Department of Physics, Govt. P. G. College, Rishikesh-249201(U.K.) - INDIA

e-mail: # yesora27@gmail.com, * gyankg@gmail.com

Abstract: A monochromatic double-mode coherent light endowed with orthogonally polarized photons propagating collinearly is studied in Degenerate Parametric Amplification. Generation of Hidden Optical-Polarized States is shown by non-zero values of Index of Hidden Optical-Polarization. Squeezing in HOPS is demonstrated by recognizing a Squeezing function. The Non-Classical feature of HOPS is observed by ‘degree of Hidden Optical-Polarization’ which attains non-classical value ‘greater than unity’. The dynamical nature of Generation, Squeezing and Non-Classicality are numerically presented.

Keywords: Hidden Optical-Polarization, Polarization Squeezing, Non-classicality, Optical Polarization

1 Introduction

Polarization in Optics is an age-old concept enunciated by a Dutch Physicist Christian Huygens while investigating birefringence in Quartz crystal [1-3]. The optical-polarization ensures the transversal nature of light and is revealed by temporal evolution of electric field vector (light vector) at any spatial point which traverses, in general, an ellipse of non-random eccentricity and orientation defining light in the state of elliptical polarization. Varying non-random ‘ratio of amplitudes’ and non-random ‘phase-difference’ along two orthogonal bases-modes, elliptically polarized light degenerates into linear and circular polarizations. Polarization in Classical Optics is quantitatively characterized by experimentally measurable Stokes Parameters [4-5]. Several techniques, namely, Jones Matrix, Mueller Matrix and Coherency matrix [6-10] are introduced for quantitative investigations of optical-polarization states. Stokes-Parameters have an edge over these techniques since they find straightforward application for characterizing optical-polarization properties in Quantum Optics. Field-Quantization of electromagnetic radiation field due to Dirac [11] and the advent of lasers in 1960s [12-14] revolutionized and enlarged the domain of Classical Optics leading to Non-linear Optics and Quantum Optics. Several investigators [15-16] have contributed in clarifying nonlinear and nonclassical (quantum) properties of light interacting

with matter. In 1970's Prakash and Chandra[16-18] and Agarwal [20] derived the density operator of Unpolarized light and defined it by demanding invariance of statistical properties deduced by moments of field amplitudes of all orders. Lehner et al. [21] and others [22-23] re-visited Unpolarized light offering some new insights. Mehta and Sharma [24] define, rigorously, perfect optical-polarization but the treatment doesn't provide a prescription for investigating optical-polarization states. Prakash and Singh [25] worked out an Optical-Polarization operator in terms of the product of Bosonic inverse-annihilation operator [26] and annihilation operator along two orthogonal bases-modes. This Optical-Polarization operator helps in testing whether a light in any quantum state is perfectly polarized by satisfying the Modified Eigen-value Equation. Prakash et al. [27] generalized the concept of optical-polarization by considering bi-modal monochromatic rectilinearly propagating optical field of which 'ratio of amplitudes' and 'sum of phases' rather than 'ratio of amplitudes' and 'difference of phases', as in usual concept of optical-polarization, along two orthogonal bases-modes are non-random parameters and defined it as 'Hidden Polarized states of light'. This Hidden Optical-Polarization state (HOPS) is unusual optical-polarization since it is not characterized by Stokes-Parameters and, hence, Hidden optical-polarization parameters are introduced for its characterization [28]. Recently, Singh and Gupta [29] proposed the design of Phase-Conjugating Mirror Michelson Interferometer for generating HOPS and a formal experimental set-up for measuring Hidden Optical-Polarization parameters. The possibility of single-photon sources from semiconductor Quantum dot [30-32] has received flurry of activities in manipulating optical-polarization states in Single-Photonic regime. Notably, polarization-state of photon, being easily manipulated and controlled by a combination of rotator (anisotropic Quartz Crystal) and phase retarders (wave plates), renders many novel experiments in Quantum Optics which tests fundamental postulates of Quantum Mechanics such as violation of Bell-inequalities tests [33], quantum tomography [34], quantum cryptography [35-36], quantum teleportation, entanglement and precision measurement[37-39].

Squeezing of a quantized optical field (light) [40-41] pertains to the possibility of reducing fluctuations (noise) in various field-parameters below those of vacuum-level or possessed by optical field in coherent states. The consecutive decades, 1980s and 1990s witnessed remarkable interests for

generating, detecting and investigating properties of variant sorts of squeezing such as quadrature components squeezing, Number phase squeezing, Higher order squeezing[42-43], Generalized squeezing[44], Amplitude-squared squeezing[45] etc.. Recently, subjects like optical estimation of squeezing [46], simultaneous squeezing of multi-modes [47], squeezing with strong photon-number oscillations [48] and temporal evolution of squeezed states [49] have received renewed spurts. Moreover, reduction in noise (squeezing) have found notable applications in Quantum metrology in beating the limit set by Heisenberg Uncertainty principle [50-52]. Heisenberg Uncertainty relation provides the minimal limit of fluctuations (noise) among non-commutable set of canonically conjugate variables. Squeezing in fluctuation of one variable would induce increased fluctuation (anti-squeezing) in other conjugate variable of quantized electromagnetic field.

Stokes-Operators in Quantum Optics describe the optical-polarization properties. These parameters are well known to obey $SU(2)$ Lie algebra and, hence, simultaneous measurements of them are precluded. The squeezing (noise-reduction) of one stokes parameter below than that in coherent state of optical field is understood as the signature of ‘polarization-squeezed state’. To enhance the sensitivity of polarization-interferometer Grangier et al. [53] generated polarization-squeezed beam using an optical-parametric process. Following the scheme proposed by Korolkova et al. [54] Bowen et al. [55] succeeded in generating polarization-squeezed light beam by interfering the orthogonally-polarized quadrature squeezed beams. Nonetheless, the ‘polarization-squeezing’ is utilized to characterize the continuous-variable polarization entanglement [56].

The present paper is devoted to study the Generation, Squeezing and Non-Classical behavior in Hidden Optical-Polarization States (HOPS), when bi-modal coherent light bearing orthogonally-polarized photons and moving collinearly undergoes Degenerate Parametric-Amplification. The paper is organized as follows: Section 2 deals with the review of HOPS in Classical as well as in Quantum Optics utilizing Glauber-Coherence functions; a quantum criterion for HOPS is derived. Characterization Parameters for HOPS are defined in Section 3 and comparison with Stokes Parameters is drawn. Section 4 deals the

generation of HOPS and is numerically investigated by Hidden Optical-Polarization index. Section 5 and 6 describe Squeezing and Non-classical signature in HOPS respectively.

2 Review of Hidden Optical-Polarization States

A monochromatic beam of light (optical field) propagating rectilinearly along z-direction, in Classical optics, is dwelt by Maxwell's Classical Electromagnetic Theory having Vector Potential (analytic signal),

$$\begin{aligned}
\mathcal{A} &= \hat{\mathbf{e}}_x A_{0x} \cos(\psi - \phi_x) + \hat{\mathbf{e}}_y A_{0y} \cos(\psi - \phi_y), \\
&= \text{Re}(\hat{\mathbf{e}}_x A_{0x} e^{-i(\psi - \phi_x)} + \hat{\mathbf{e}}_y A_{0y} e^{-i(\psi - \phi_y)}), \\
&= [\hat{\mathbf{e}}_x \underline{A}_x + \hat{\mathbf{e}}_y \underline{A}_y] e^{-i\psi}, \tag{1}
\end{aligned}$$

where $\psi = \omega t - kz$, Re stands for real part, $i = (-1)^{1/2}$, \mathbf{k} ($= k \hat{\mathbf{e}}_z$) is propagation vector, and $\hat{\mathbf{e}}_{x,y,z}$ are respective unit vectors along x-, y-, and z- axes. Obviously, vector potential, \mathcal{A} and, hence, the optical field is completely specified by its real transverse-amplitudes, $A_{0x,0y}$ and phase-parameters, $\phi_{x,y}$. These four parameters ($A_{0x,0y}; \phi_{x,y}$) have, in general, random spatio-temporal variations. Moreover, optical field, Eq.(1) is representative of bi-modal optical field because it needs two random complex-amplitudes $\underline{A}_{x,y} = A_{0x,0y} \exp(i\phi_{x,y})$ in orthogonal basis-modes ($\hat{\mathbf{e}}_{x,y} \bar{\mathbf{k}}$) for its complete statistical-characterization.

In Quantum Optics the optical field, Eq.(1) is quantized utilizing field-quantization technique due to Dirac [11]. The analytic signal of Vector Potential operator is tacitly expressed in terms of positive-frequency vector potential, $\hat{\mathcal{A}}^{(+)}$ and negative-frequency vector potential, $\hat{\mathcal{A}}^{(-)}$ as

$$\hat{\mathcal{A}} = \hat{\mathcal{A}}^{(+)} + \hat{\mathcal{A}}^{(-)} \tag{2}$$

where $\hat{\mathcal{A}}^{(+)}$ and $\hat{\mathcal{A}}^{(-)}$ is Hermitian conjugate pair (i.e. $\hat{\mathcal{A}}^{(+)} = \hat{\mathcal{A}}^{(-)\dagger}$). The positive-frequency Vector Potential part $\hat{\mathcal{A}}^{(+)}$ [57] is given by

$$\hat{\mathcal{A}}^{(+)} = \left(\frac{2\pi}{\omega V}\right)^{1/2} [\hat{\mathbf{e}}_x \hat{a}_x(t) + \hat{\mathbf{e}}_y \hat{a}_y(t)] e^{-i\psi} \tag{3}$$

where $\hat{a}_{x,y}$ are Bosonic-annihilation operators recognized as quantized complex amplitudes of electromagnetic field in ($\hat{\mathbf{e}}_{x,y} \bar{\mathbf{k}}$) basis-modes by which spatio-temporal bi-mode can be excited [59], ω is angular frequency of the optical field and V is the quantization volume.

Mehta and Sharma [24] has provided strict definition of polarized light in Quantum Optics by transforming rectilinearly propagating bi-modal monochromatic light to a linearly-polarized single-mode on passing through compensator and/or rotator (SU(2)-transformation). Such polarized light may be termed as ‘truly’ single-mode optical field as the signal is absent in orthogonal mode. The usual (ordinary) polarized light is completely determined either by the pair of non-random ‘ratio of amplitudes’ and non-random ‘difference in phases’ in orthogonal basis-modes, $(\hat{\mathbf{e}}_{x,y}, \bar{k})$ or by a non-random complex parameter defined as Index of polarization [25]. Prakash and Singh [25] deduced an optical-polarization operator which prescribes the Index of polarization for perfectly polarized optical-field states.

Moreover, in Ref.[27] the concept of Hidden Optical-Polarization States (HOPS) has been introduced in which signal is, in general, present in all modes but only one complex amplitude suffices for its complete statistical description. HOPS, may, therefore, be termed as ‘essential’ single-mode optical-field state. Recently, Singh and Gupta [29] proposed a formal Phase-conjugating Mirror Michelson Interferometer for generation of HOPS and an experimental set up for measuring Hidden optical-polarization parameters to characterize HOPS. Notably, HOPS has non-random ‘sum of phases’ and non-random ‘ratio of real amplitudes’ contrary to ‘truly’ single-mode polarized optical field where non-random ‘difference of phases’ and non-random ‘ratio of real amplitudes’ in orthogonally basis-modes $(\hat{\mathbf{e}}_{x,y}, \bar{k})$ served as characteristic polarization-parameters. Instead of adopting basis of description $(\hat{\mathbf{e}}_x, \hat{\mathbf{e}}_y)$ one may work in a general basis $(\hat{\mathbf{e}}, \hat{\mathbf{e}}_{\perp})$. Here $\hat{\mathbf{e}}$ is complex unit vector, $\hat{\mathbf{e}} = \varepsilon_x \hat{\mathbf{e}}_x + \varepsilon_y \hat{\mathbf{e}}_y$, satisfying normalization condition, $\hat{\mathbf{e}}^* \cdot \hat{\mathbf{e}} = |\varepsilon_x|^2 + |\varepsilon_y|^2 = 1$. A unit vector orthogonal to $\hat{\mathbf{e}}$ is given by complex unit vector $\hat{\mathbf{e}}_{\perp}$ satisfying $\hat{\mathbf{e}}_{\perp}^* \cdot \hat{\mathbf{e}}_{\perp} = |\varepsilon_{\perp x}|^2 + |\varepsilon_{\perp y}|^2 = 1$; $\hat{\mathbf{e}}_{\perp} \cdot \hat{\mathbf{e}} = \varepsilon_x^* \varepsilon_{\perp x} + \varepsilon_y^* \varepsilon_{\perp y} = 0$, providing $\frac{\varepsilon_{\perp y}}{\varepsilon_{\perp x}} = \frac{\varepsilon_x^*}{\varepsilon_y^*}$, where dot(.) denotes inner product of Cartesian vectors. The unit vector $\hat{\mathbf{e}}$ [25] may be viewed as the unique direction in Poincare sphere and may, therefore, serve as polarization vector. The analytic signal (vector potential), \mathcal{A} of a single-mode polarized optical field in the mode $(\hat{\mathbf{e}}_0, \bar{k})$ is described by,

$$\mathcal{A} = \underline{\mathbf{A}} e^{-i\Psi} \quad (4)$$

where $\underline{A} = \hat{\mathbf{e}}_0 \underline{A}$ is the complex amplitude along $\hat{\mathbf{e}}_0$. Complex amplitudes of optical-field represented by Eq.(4) in the basis $(\hat{\mathbf{e}}, \hat{\mathbf{e}}_\perp)$ are $\underline{A}_{\hat{\mathbf{e}}} = (\hat{\mathbf{e}}^* \cdot \underline{A}) = \underline{A} \cdot (\hat{\mathbf{e}}^* \cdot \hat{\mathbf{e}}_0)$; $\underline{A}_{\hat{\mathbf{e}}_\perp} = (\hat{\mathbf{e}}_\perp^* \cdot \underline{A}) = \underline{A} \cdot (\hat{\mathbf{e}}_\perp^* \cdot \hat{\mathbf{e}}_0)$. Using Eq.(4) one may derive index of polarization in the basis, $(\hat{\mathbf{e}}, \hat{\mathbf{e}}_\perp)$ as

$$p_{(\hat{\mathbf{e}}, \hat{\mathbf{e}}_\perp)} = \underline{A}_{\hat{\mathbf{e}}_\perp} / \underline{A}_{\hat{\mathbf{e}}} = (\hat{\mathbf{e}}_\perp^* \cdot \hat{\mathbf{e}}_0) / (\hat{\mathbf{e}}^* \cdot \hat{\mathbf{e}}_0), \quad (5)$$

for usual (ordinary) polarized light. Decomposing complex amplitudes, $\underline{A}_{\hat{\mathbf{e}}}$ ($\underline{A}_{\hat{\mathbf{e}}_\perp}$) in terms of real amplitudes $A_{0\hat{\mathbf{e}}}$ ($A_{0\hat{\mathbf{e}}_\perp}$) and phase parameters $\varphi_{\hat{\mathbf{e}}}$ ($\varphi_{\hat{\mathbf{e}}_\perp}$) as $\underline{A}_{\hat{\mathbf{e}}} (\underline{A}_{\hat{\mathbf{e}}_\perp}) = A_{0\hat{\mathbf{e}}} (A_{0\hat{\mathbf{e}}_\perp}) \exp(i\varphi_{\hat{\mathbf{e}}} (\varphi_{\hat{\mathbf{e}}_\perp}))$, Eq. (5) yields, (i) non-random ‘ratio of real amplitudes’, $A_{0\hat{\mathbf{e}}_\perp} / A_{0\hat{\mathbf{e}}}$ and, (ii) non-random ‘difference in phases’, $\varphi_{\hat{\mathbf{e}}_\perp} - \varphi_{\hat{\mathbf{e}}}$ in basis-modes of description $(\hat{\mathbf{e}}, \hat{\mathbf{e}}_\perp)$. Thus, usual polarized light is completely determined either by non-random ‘ratio of amplitudes’ and non-random ‘difference in phases’ in the orthogonal modes or by a non-random complex parameter, $p_{(\hat{\mathbf{e}}, \hat{\mathbf{e}}_\perp)}$, defining index of polarization. Parametrizing complex amplitudes, $\underline{A}_{\hat{\mathbf{e}}}$ ($\underline{A}_{\hat{\mathbf{e}}_\perp}$) and $\varphi_{\hat{\mathbf{e}}}$ ($\varphi_{\hat{\mathbf{e}}_\perp}$) by introducing new set real parameters A_0 , χ and Δ such that $0 \leq A_0$, $0 \leq \chi \leq \pi$, $0 \leq \bar{\varphi} \leq 2\pi$ and $-\pi < \Delta \leq \pi$ as

$$A_{0\hat{\mathbf{e}}} = A_0 \cos \frac{\chi}{2}, A_{0\hat{\mathbf{e}}_\perp} = A_0 \sin \frac{\chi}{2}, \varphi_{\hat{\mathbf{e}}} = \bar{\varphi} - \Delta/2, \varphi_{\hat{\mathbf{e}}_\perp} = \bar{\varphi} + \Delta/2, \quad (6)$$

where A_0 and $\bar{\varphi}$ are random parameters satisfying, $A_0 = (A_{0\hat{\mathbf{e}}_\perp}^2 + A_{0\hat{\mathbf{e}}}^2)^{1/2}$, $\chi = 2 \tan^{-1}(\frac{A_{0\hat{\mathbf{e}}_\perp}}{A_{0\hat{\mathbf{e}}}})$,

$2\bar{\varphi} = \varphi_{\hat{\mathbf{e}}_\perp} + \varphi_{\hat{\mathbf{e}}}$ and $\Delta = \varphi_{\hat{\mathbf{e}}_\perp} - \varphi_{\hat{\mathbf{e}}}$, Inserting Eq.(6) into Eq.(5), one obtains $p_{(\hat{\mathbf{e}}, \hat{\mathbf{e}}_\perp)} = \frac{A_{\hat{\mathbf{e}}_\perp}}{A_{\hat{\mathbf{e}}}} = \tan \frac{\chi}{2} e^{i\Delta}$.

Conditions for ‘ratio of real amplitudes’ and ‘difference in phases’ pertaining to HOPS may be casted in terms of a non-random complex parameter,

$$p_{h(\hat{\mathbf{e}}, \hat{\mathbf{e}}_\perp)} = \underline{A}_{\hat{\mathbf{e}}_\perp} / \underline{A}_{\hat{\mathbf{e}}}^* = \tan \frac{\chi_h}{2} e^{i\Delta_h}, \quad (7)$$

where χ_h and Δ_h are non-random angle parameters ($0 \leq \chi_h \leq \pi$ and $-\pi < \Delta_h \leq \pi$), defining Index of Hidden Optical-Polarization (IHOP). Parameterizing real amplitudes and phase parameters,

$$A_{0\hat{\mathbf{e}}} = A_0 \cos \chi_h/2, A_{0\hat{\mathbf{e}}_\perp} = A_0 \sin \chi_h/2; \varphi_{\hat{\mathbf{e}}} = \varphi + \Delta_h/2, \varphi_{\hat{\mathbf{e}}_\perp} = -\varphi + \Delta_h/2 \quad (8)$$

where A_0 and φ are random parameters ($0 \leq A_0$, $0 \leq \varphi \leq 2\pi$) satisfying by $A_0 = (A_{0\hat{\mathbf{e}}_\perp}^2 + A_{0\hat{\mathbf{e}}}^2)^{1/2}$,

$\chi_h = 2 \tan^{-1}(\frac{A_{0\hat{\mathbf{e}}_\perp}}{A_{0\hat{\mathbf{e}}}})$, and $2\varphi = -(\varphi_{\hat{\mathbf{e}}_\perp} - \varphi_{\hat{\mathbf{e}}})$, $\Delta_h = \varphi_{\hat{\mathbf{e}}_\perp} + \varphi_{\hat{\mathbf{e}}}$. The analytic signal of vector potential of HOPS can, then, be written in general basis-modes, $(\hat{\mathbf{e}}, \hat{\mathbf{e}}_\perp)$ as

$$\underline{\mathcal{A}} = [\hat{\mathbf{e}} \cos \frac{\chi_h}{2} A_0 e^{i\varphi} e^{i\Delta_h/2} + \hat{\mathbf{e}}_\perp \sin \chi_h/2 A_0 e^{-i\varphi} e^{i\Delta_h/2}] e^{-i\psi}. \quad (9)$$

Obviously, Eq.(9) describes an optical-polarized field in which ‘difference of phases’, ϕ in orthogonal modes is random parameter but its statistical properties are governed by one random complex amplitude or random real amplitudes, A_0 and random phase parameter, ϕ .

The Glauber coherence functions [57, 58] which describe correlation properties at any spatio-temporal point is,

$$\Gamma^{(m_x m_y n_x n_y)} = \text{Tr}[\rho(0) \hat{\mathcal{A}}_x^{(-)m_x} \hat{\mathcal{A}}_y^{(-)m_y} \hat{\mathcal{A}}_x^{(+m_x} \hat{\mathcal{A}}_y^{(+m_y)}] \quad (10)$$

where $\rho(0)$ is density operator of optical field. Setting the condition on quantized complex amplitudes,

$$\hat{a}_y(t)\rho(0) = p\hat{a}_x(t)\rho(0), \quad (11)$$

where p is index of polarization, and inserting Eq.(11) into (10) one obtain the Glauber functions,

$$\Gamma^{(m_x, m_y, n_x, n_y)} = p^{*m_y} p^{m_y} \Gamma^{(m_x + m_y, 0, n_x + n_y, 0)} \quad (12)$$

which describes ‘truly’ single-mode optical-polarization state. Clearly, Glauber coherence function, Eq.(12) is determined by p (index of polarization) and one of quantized complex amplitudes $\hat{a}_x(t)$. Notably, since, Eq.(12) gives the coherence function for polarized light, Eq.(11) may be regarded as quantum analogue of classical criterion $\underline{A}_y = p \underline{A}_x$ for optical- polarized field. Similarly having employed the criterion,

$$\hat{a}_y(t)\rho(0) = p_h e^{-2i\omega t} \rho(0) \hat{a}_x^\dagger(t), \quad (13)$$

where p_h is (Hidden index of polarization), and substituting Eq.(13) into Eq.(10), we obtain coherence functions for ‘essential’ single-mode Hidden Optical-Polarization state,

$$\Gamma^{(m_x, m_y, n_x, n_y)} = p_h^{*m_y} p_h^{n_y} \Gamma^{(m_x + m_y, 0, n_x + n_y, 0)} \quad (14)$$

Again, Eq.(14) are governed by p_h and one of the quantized complex amplitudes $\hat{a}_x(t)$. The Eq.(13) may be regarded as quantum criterion for HOPS, quantum counterpart of $\underline{A}_y = p_h \underline{A}_x^*$.

3 Characteristic Parameters for Hidden Optical-Polarization

Optical-polarization states in Classical Optics is characterized by Stokes Parameters,

$$s_0 = \langle |\underline{A}_y|^2 + |\underline{A}_x|^2 \rangle; s_1 = \langle |\underline{A}_y|^2 - |\underline{A}_x|^2 \rangle; s_2 + i s_3 = 2 \langle \underline{A}_y^* \underline{A}_x \rangle \quad (15)$$

which take the roles of operators, (Stokes Operators) for characterizing usual optical-polarization state in Quantum Optics and bear relations,

$$\hat{S}_0 = \hat{a}_y^\dagger(t)\hat{a}_y(t) + \hat{a}_x^\dagger(t)\hat{a}_x(t),$$

$$\hat{S}_1 = \hat{a}_y^\dagger(t)\hat{a}_y(t) - \hat{a}_x^\dagger(t)\hat{a}_x(t),$$

$$\hat{S}_2 + i\hat{S}_3 = 2\hat{a}_y^\dagger(t)\hat{a}_x(t),$$

whose expectation values in the optical-field state, $\rho(0)$ are,

$$s_0 = \langle \hat{S}_0 \rangle = \text{Tr} [\rho(0) \{ \hat{a}_y^\dagger(t)\hat{a}_y(t) + \hat{a}_x^\dagger(t)\hat{a}_x(t) \}],$$

$$s_1 = \langle \hat{S}_1 \rangle = \text{Tr} [\rho(0) \{ \hat{a}_y^\dagger(t)\hat{a}_y(t) - \hat{a}_x^\dagger(t)\hat{a}_x(t) \}],$$

$$s_2 + i s_3 = \langle \hat{S}_2 + i\hat{S}_3 \rangle = 2\text{Tr} [\rho(0) \hat{a}_y^\dagger(t)\hat{a}_x(t)], \quad (16)$$

where $\langle \rangle$ provides ensemble average (expectation value) in Classical Optics (Quantum Optics), Tr is trace of parenthesized quantity and $\underline{A}_{x,y}$ ($\hat{a}_{x,y}(t)$) gives Classical (Quantized) complex amplitudes of optical field. Taking non-random vanishing angle parameters ($\chi_h = 0 = \Delta_h$) and the basis of description ($\hat{\mathbf{e}}, \hat{\mathbf{e}}_\perp$) as the linear-polarization basis ($\hat{\mathbf{e}}_x, \hat{\mathbf{e}}_y$) in Eq.(9) for evaluation of Stokes Parameters, Eq.(15), noting the fact that random variables φ has equal probability between 0 to 2π , one obtains,

$$s_0 = A_0^2 \text{ and } s_1 = s_2 = s_3 = 0. \quad (17)$$

Eq.(17), at first glance, demonstrates that the light is in Unpolarized state which is not, clearly, the fact because light is in HOPS. Several authors [60-63] have critically investigated inadequacy of Stokes-Parameters in characterizing optical-polarization state. The polarization properties of such an optical field, Eq.(9) is described by Hidden Optical –Polarization Parameters, defined in Classical optics,

$$h_0 = \langle |\underline{A}_y|^2 + |\underline{A}_x|^2 \rangle,$$

$$h_1 = \langle |\underline{A}_y|^2 - |\underline{A}_x|^2 \rangle,$$

$$h_2 + i h_3 = 2\langle \underline{A}_y \underline{A}_x \rangle, \quad (18)$$

or, in Quantum Optics,

$$\hat{H}_0 = \hat{a}_y^\dagger(t)\hat{a}_y(t) + \hat{a}_x^\dagger(t)\hat{a}_x(t),$$

$$\hat{H}_1 = \hat{a}_y^\dagger(t)\hat{a}_y(t) - \hat{a}_x^\dagger(t)\hat{a}_x(t),$$

$$\hat{H}_2 + i \hat{H}_3 = 2 e^{2i\omega t} \hat{a}_y(t) \hat{a}_x(t),$$

having expectation in optical-field states, $\rho(0)$,

$$h_0 = \langle \hat{H}_0 \rangle = \text{Tr}[\rho(0) \{ \hat{a}_y^\dagger(t) \hat{a}_y(t) + \hat{a}_x^\dagger(t) \hat{a}_x(t) \}],$$

$$h_1 = \langle \hat{H}_1 \rangle = \text{Tr}[\rho(0) \{ \hat{a}_y^\dagger(t) \hat{a}_y(t) - \hat{a}_x^\dagger(t) \hat{a}_x(t) \}],$$

$$h_2 + i h_3 = \langle \hat{H}_2 + i \hat{H}_3 \rangle = 2 e^{2i\omega t} \text{Tr}[\rho(0) \hat{a}_y(t) \hat{a}_x(t)], \quad (19)$$

Following the procedure proposed by N. Korolkova et al.[54] W. P. Bowen et al.[56], experimentally, produced the Optical-Polarized squeezed state allowing interference between quadrature squeezed light and measure the fluctuations in Stokes-Parameters. Similarly, Singh and Gupta [29] formally designed experimental setup for production of Hidden Optical-Polarization State of light and also for measuring the Hidden Optical-Polarization parameters. The Hidden Optical-Polarization operators, Eq.(19) obey commutation relations,

$$\begin{aligned} [\hat{H}_1, \hat{H}_0] &= [\hat{H}_1, \hat{H}_2] = [\hat{H}_1, \hat{H}_3] = 0 \\ [\hat{H}_0, \hat{H}_2] &= 2i\hat{H}_3, [\hat{H}_0, \hat{H}_3] = 2i\hat{H}_2 \\ [\hat{H}_2, \hat{H}_3] &= 2i(\mathbb{I} + \hat{H}_0) \end{aligned} \quad (20)$$

having obvious relationship $\hat{H}_1^2 + \hat{H}_2^2 + \hat{H}_3^2 = \hat{H}_0^2 + 2(\mathbb{I} + \hat{H}_0)$ or $\hat{H}^2 - \hat{H}_0^2 = 2(\mathbb{I} + \hat{H}_0)$ and \mathbb{I} is identity operator. Comparing Eq.(20) with the SU (2) Lie group algebraic equations of stokes operators,

$$[\hat{S}_0, \hat{S}_1] = [\hat{S}_0, \hat{S}_2] = [\hat{S}_0, \hat{S}_3] = 0; [\hat{S}_1, \hat{S}_2] = 2i\hat{S}_3, [\hat{S}_2, \hat{S}_3] = 2i\hat{S}_1, [\hat{S}_3, \hat{S}_2] = 2i\hat{S}_1 \quad (21)$$

One may take cognizance that hidden-polarization operator \hat{H}_1 commutes with all others while \hat{H}_0 not (cf. \hat{S}_0). Non-commutability of Hidden optical-polarization parameter precludes their simultaneous

measurements. Heisenberg Uncertainty Principle ($\Delta \hat{H}_j^2 \Delta \hat{H}_k^2 \geq \left| \frac{1}{2i} \langle [\hat{H}_j, \hat{H}_k] \rangle \right|^2$) can be invoked for hidden optical-polarization operators to give uncertainty products,

$$\begin{aligned} \Delta \hat{H}_0^2 \Delta \hat{H}_2^2 &\geq | \langle \hat{H}_3 \rangle |^2, \\ \Delta \hat{H}_2^2 \Delta \hat{H}_3^2 &\geq | \langle \mathbb{I} + \hat{H}_0 \rangle |^2, \\ \Delta \hat{H}_3^2 \Delta \hat{H}_0^2 &\geq | \langle \hat{H}_2 \rangle |^2, \end{aligned} \quad (22)$$

where $\langle \Delta \hat{H}_j^2 \rangle = \langle \hat{H}_j^2 \rangle - \langle \hat{H}_j \rangle^2$ is a shorthand notation for the variance (noise) of the parameter \hat{H}_j ($j = 0, 1, 2, 3$), whose square root provide the uncertainty in hidden optical-polarization parameters.

4 Generation of Hidden Optical-Polarized States

A double-mode coherent optical field in which photons have orthogonal polarization but collinearly propagating is utilized as pump in Degenerate Parametric Amplification. Photons having orthogonal linear polarization, say x and y, and propagating along the same direction, the Hamiltonian of the process undergoing may, in Heisenberg convention, be written as.

$$H = [\omega \{ \hat{a}_x^\dagger(t) \hat{a}_x(t) + \hat{a}_y^\dagger(t) \hat{a}_y(t) + k \{ \hat{a}_x^\dagger(t) \hat{a}_y^\dagger(t) e^{-2i\omega t} + \hat{a}_x(t) \hat{a}_y(t) e^{2i\omega t} \}], \quad (23)$$

where k is real coupling constant proportional to second ordered nonlinear susceptibility. Glauber and Mallow [64] has obtained the exact solution of equations of motion $i \dot{\hat{a}}_{x,y} = [\hat{a}_{x,y}, \hat{H}]$, where over dot (.) represent time variation and usage of natural convention $c = \hbar = 1$ is adopted, of quantized complex amplitudes and obtained as,

$$\hat{a}_x(t) = e^{-i\omega t} [C(2) \hat{a}_x - iS(2) \hat{a}_y^\dagger]; \quad \hat{a}_y(t) = e^{-i\omega t} [C(2) \hat{a}_y - iS(2) \hat{a}_x^\dagger], \quad (24)$$

where $\hat{a}_{x,y} = \hat{a}_{x,y}(t = 0)$, C(2) and S(2) are hyperbolic time-varying functions defined as $C(2m) \equiv \text{Cosh}2mkt$ and $S(2) \equiv \text{Sinh}2mkt$; m takes positive integral values. Taking double-mode coherent light in pure state having density operator,

$$\rho(0) = |\alpha_x, \alpha_y\rangle \langle \alpha_x, \alpha_y|, \quad (25)$$

and inserting Eqs.(24, 25) in Eq.(13) one obtains, after simple algebraic manipulations, the index of Hidden optical-polarization (IHOP) at an arbitrary interaction time t,

$$p_h(t) = (p_h - i \tanh 2kt) / (1 + i p_h \tanh 2kt), \quad (26)$$

where $p_h \equiv p_h(0) = \alpha_y / \alpha_x^*$, of which non-zero values ensures the generation of HOPS. Since IHOP, p_h being a complex parameter (absolute magnitude, $|p_h|$ and the phase, $\arg(p_h)$ at time t) which are the characterizing parameters for single-mode HOPS, are deduced to have the expressions,

$$|p_h(t)| = [\{ |p_h|^2 (1 + \sin^2 \Delta_h \sinh^2 4kt) - (1/2) |p_h| (1 + |p_h|^2) \sin \Delta_h \sinh 8kt + (1/4) (1 + |p_h|^2)^2 \sinh^2 4kt \} / \{ (\cosh 2kt + |p_h| \sinh 2kt)^2 - |p_h| (1 + \sin \Delta_h) \sinh 4kt \}^2]^{1/2}, \quad (27)$$

$$\Delta_h(t) = \tan^{-1} [\tan \Delta_h \cosh 4kt - \{ (1 + |p_h|^2) / 2 |p_h| \} \sec \Delta_h \sinh 4kt]. \quad (28)$$

The dynamical features of characteristic parameters, $|p_h(t)|$ and $\Delta_h(t)$, are numerically investigated for variant values of “ratio of amplitudes”, the “sum of phases” and interaction time in Figs.(1). From the graph we can find at particular interaction time the value of IHOP on varying parameters for incident coherent light.

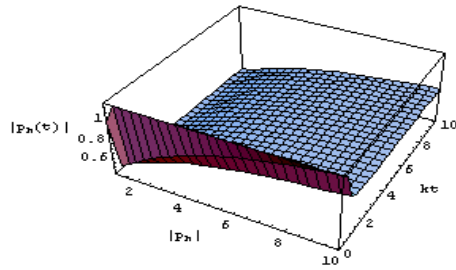

Fig.(1a) Variation of absolute magnitude of IHOP at nonrandom “sum of phases”, Δ_h equal to π of incident coherent light.

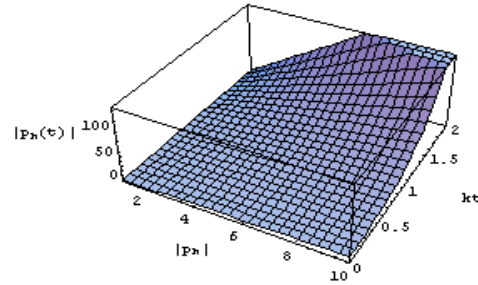

Fig.(1b) Variation of absolute magnitude of IHOP at nonrandom “sum of phases”, Δ_h equal to $\pi/2$ of incident coherent light.

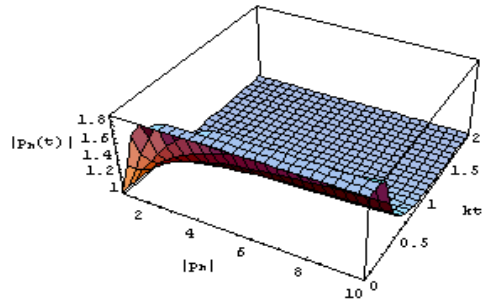

Fig.(1c) Variation of absolute magnitude of IHOP at nonrandom “sum of phases”, Δ_h equal to $3\pi/2$ of incident coherent light.

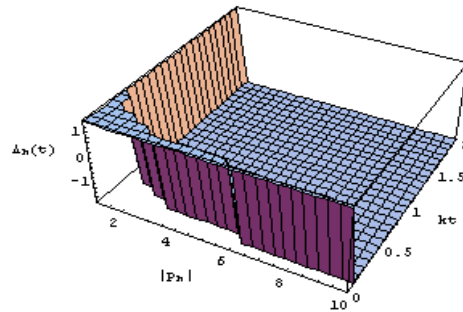

Fig.(1d) Variation of phase of IHOP at non-random value of “sum of phases”, Δ_h equal to $\pi/2$ of incident coherent light.

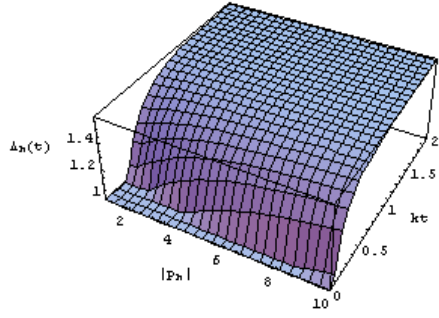

Fig.(1e) Variation of phase of IHOP at non-random value of “sum of phases”, Δ_h equal to π of incident coherent light.

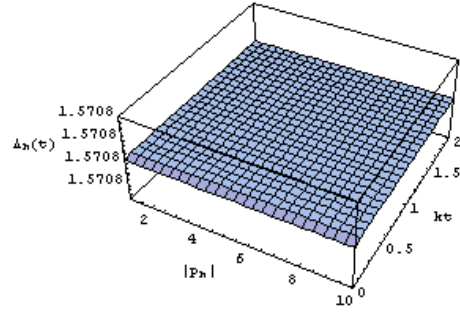

Fig.(1f) Variation of phase of IHOP at non-random value of “sum of phases”, Δ_h equal to $3\pi/2$ of incident coherent light.

5 Squeezing in Hidden Optical-Polarized states of light

Light is said to be in Hidden Optical-Polarization Squeezed States (HOPSS) if the variance (fluctuations) of one or more of the hidden optical-polarization parameters is smaller than those of corresponding value(s) for vacuum state of light, which possesses least variance. Squeezing in HOPS is seen by referring the following inequalities,

$$\langle \Delta \hat{H}_0^2(t) \rangle \text{ or } \langle \Delta \hat{H}_2^2(t) \rangle < |\langle \hat{H}_3 \rangle|,$$

or,

$$\langle \Delta \hat{H}_2^2(t) \rangle \text{ or } \langle \Delta \hat{H}_3^2(t) \rangle < |1 + \langle \hat{H}_0 \rangle|,$$

or,

$$\langle \Delta \hat{H}_3^2(t) \rangle \text{ or } \langle \Delta \hat{H}_0^2(t) \rangle < |\langle \hat{H}_2 \rangle|, \quad (29)$$

obtained by the principle of uncertainty propounded by Heisenberg. The expectation values (Quantum mechanical average values) and their variances for the dynamical Hidden Optical-Polarization operators, $\hat{H}_0, \hat{H}_1, \hat{H}_2, \hat{H}_3$, are evaluated to yield with the aid of simple algebraic calculations after insertion of Eqs.(24, 25) into Eq.(19) and Eq.(22) respectively, when crystal is pumped by double-mode coherent light in pure state,

$$\langle \hat{H}_0 \rangle = |\alpha_x|^2 (1 + |p_h|^2) C(4) - 2|\alpha_x|^2 |p_h| S(4) \sin \Delta_h + 2S^2(2), \quad (30)$$

$$\langle \hat{H}_1 \rangle = |\alpha_x|^2 (|p_h|^2 - 1), \quad (31)$$

$$\langle \hat{H}_2 \rangle = 2|\alpha_x|^2 |p_h| \cos \Delta_h, \quad (32)$$

$$\langle \hat{H}_3 \rangle = 2|\alpha_x|^2 |p_h| C(4) \sin \Delta_h - \{1 + |\alpha_x|^2 (1 + |p_h|^2)\} S(4) \quad (33)$$

$$\langle \Delta \hat{H}_0^2(t) \rangle = |\alpha_x|^2 (1 + |p_h|^2) C(8) - 2|\alpha_x|^2 |p_h| S(8) \sin \Delta_h + S^2(4) \quad (34)$$

$$\langle \Delta \hat{H}_1^2(t) \rangle = |\alpha_x|^2 (1 + |p_h|^2), \quad (35)$$

$$\langle \Delta \hat{H}_2^2(t) \rangle = 1 + |\alpha_x|^2 (1 + |p_h|^2), \quad (36)$$

$$\langle \Delta \hat{H}_3^2(t) \rangle = |\alpha_x|^2 (1 + |p_h|^2) C(8) - 2|\alpha_x|^2 |p_h| S(8) \sin\Delta_h + S^2(4) - 1, \quad (37)$$

where $\Delta_h = (\varphi_x + \varphi_y)$ denotes the dependences on the sum of phases, a weird property of HOPS.

The condition for Squeezing [65] associated with $\langle \Delta \hat{H}_2^2(t) \rangle$ is,

$$\langle \Delta \hat{H}_2^2(t) \rangle < |1 + \langle \hat{H}_0 \rangle|, \quad (38)$$

utilizing Eq.(36) with Eq(30) one may easily obtain,

$$1 + |\alpha_x|^2 (1 + |p_h|^2) < | \{1 + |\alpha_x|^2 (1 + |p_h|^2)\} C(4) - 2|\alpha_x|^2 |p_h| S(4) \sin\Delta_h|. \quad (39)$$

Squeezing is manifested provided that,

$$Sq(kt, |p_h|, |\alpha_x|) < 1 \quad (40)$$

where

$$Sq(kt, |p_h|, |\alpha_x|) = 1 + |\alpha_x|^2 (1 + |p_h|^2) / | \{1 + |\alpha_x|^2 (1 + |p_h|^2)\} C(4) - 2|\alpha_x|^2 |p_h| S(4) \sin\Delta_h|. \quad (41)$$

Thus, we conclude that Squeezing in HOPS is obtained on satisfying Eq. (40) along with Eq.(41). It is displayed in Figs.(2) that Squeezing is, in general, obtained as interaction time increases depending upon intensities in two orthogonally polarized modes and their “sum of phases”. When “sum of phases” is $\pi/2$ Squeezing starts after an Onset-time $kt = 0.7$ second and when the values attain among 0 to $\pi/2$ and $\pi/2$ to π , Squeezing is obtained on different Onset-times. Moreover, for “sum of phases”, π , $3\pi/2$ Squeezing is obtained as on every interaction time as shown in Figs.(2a, 2b, 2c). The Squeezing is observed to depend on intensities in two orthogonal basis-modes as in Figs. (2d, 2e, 2f) on non-random values of “sum of phases”. In our earlier investigation [66] we have studied Squeezing in HOPS employing chaotic light as pump field in Degenerate Parametric Amplification.

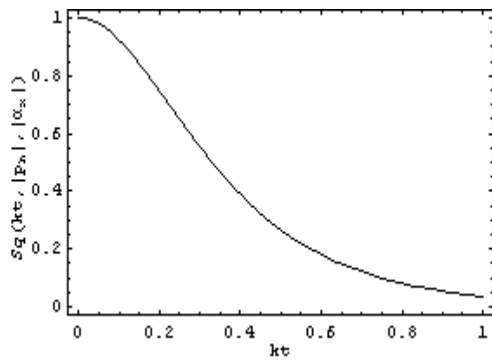

Fig. (2a) Squeezing on arbitrary values of intensities ($|\alpha_x| = 10$, $|p_h| = 10$ and $\Delta_h = \pi$) varying with interaction time.

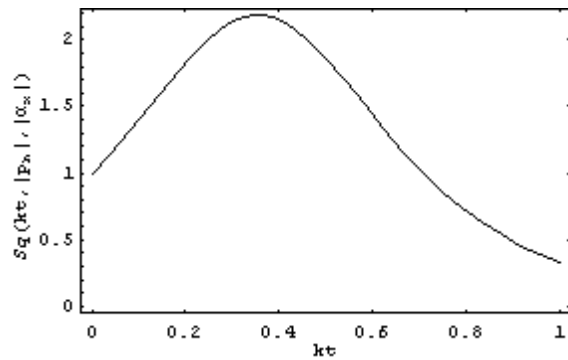

Fig. (2b) Squeezing is obtained after $kt = 0.7$ sec, $\Delta_h = \pi/2$ on arbitrary values of intensities ($|\alpha_x| = 2$, $|p_h| = 1$).

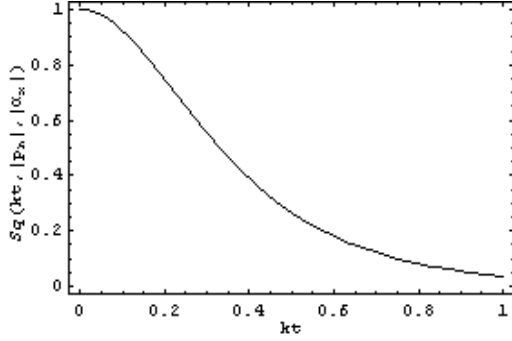

Fig. (2c) Squeezing on arbitrary values of intensities ($|\alpha_x| = 10$, $|p_y| = 10$ and $\Delta_h = 3\pi/2$) varying with interaction time.

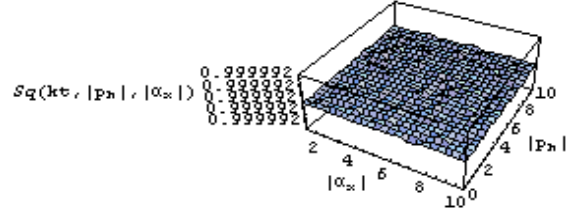

Fig. (2d) Squeezing as $kt = 0.001$ sec, $\Delta_h = \pi$ on varying intensities.

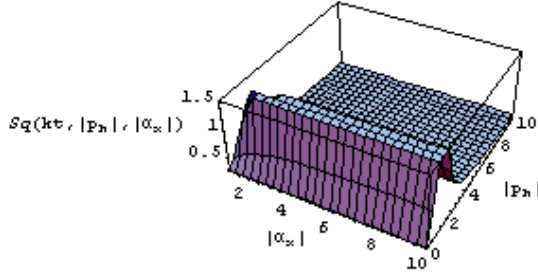

Fig. (2e) Squeezing as $kt = 0.5$ sec, $\Delta_h = \pi/2$ on varying intensities.

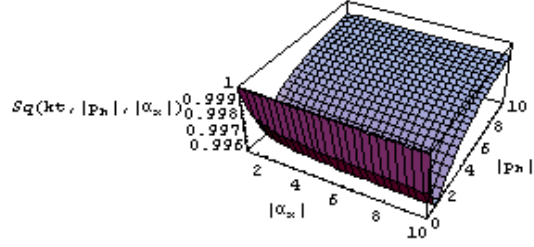

Fig. (2f) Squeezing as $kt = 0.001$ sec, $\Delta_h = 3\pi/2$ on varying intensities.

6 Non-Classical Signature in HOPS

In tune with Stokes parameters used to quantify partially polarized state of light by measurable quantity (degree of polarization), the degree of Hidden Optical-Polarization may, analogously, be defined as,

$$\mathcal{H} = \frac{h}{h_0} = \frac{(h_1^2 + h_2^2 + h_3^2)^{1/2}}{h_0} \quad (41)$$

where, utilizing Eqs.(30-33) one get,

$$\begin{aligned} h &= (h_1^2 + h_2^2 + h_3^2)^{1/2} \\ &= [\{|\alpha_x|^2 (1 + |p_h|^2) \{|\alpha_x|^2 (1 + |p_h|^2) + 2\} + 1\} S^2(4) - 2 |\alpha_x|^2 |p_h| \{1 + |\alpha_x|^2 (1 + |p_h|^2)\} S(8) \sin\Delta_h \\ &\quad + 4 |\alpha_x|^4 |p_h|^2 (\cos^2\Delta_h + C^2(4) \sin^2\Delta_h) + |\alpha_x|^4 (1 + |p_h|^4)]^{1/2} \end{aligned} \quad (42)$$

Classically, \mathcal{H} should have range of values, $0 \leq \mathcal{H} \leq 1$. Signature of Non-classicality in HOPS is exemplified when the Degree of Hidden Optical-Polarization assumes values greater than unity, i. e., $\mathcal{H} > 1$ at certain interaction time. Insertion of Eq.(30) and Eq.(42) into Eq.(41) one can obtain,

$$\begin{aligned} & [[\{ |\alpha_x|^2 (1 + |p_h|^2) \{ |\alpha_x|^2 (1 + |p_h|^2) + 2 \} + 1 \} S^2(4) - 2 |\alpha_x|^2 |p_h| \{ 1 + |\alpha_x|^2 (1 + |p_h|^2) \} S(8) \sin \Delta_h \\ & + 4 |\alpha_x|^4 |p_h|^2 (\cos^2 \Delta_h + C^2(4) \sin^2 \Delta_h) + |\alpha_x|^4 (1 + |p_h|^4)^{1/2} / \{ |\alpha_x|^2 (1 + |p_h|^2) C(4) \\ & - 2 |\alpha_x|^2 |p_h| S(4) \sin \Delta_h + 2 S^2(2) \}] > 1. \end{aligned} \quad (43)$$

On simplifying through simple algebraic manipulations, Eq.(43) yields,

$$S_{NCL} \equiv |\alpha_x|^2 |p_h| S(4) \sin \Delta_h - \{ 1 + |\alpha_x|^2 (1 + |p_h|^2) \} S^2(2) < 0 \quad (44)$$

Eq.(44) asserts clear signature of non-classicality(NCL) for hidden optical-polarization state(in Figs.3).

Eq.(44) is plotted on variation of intensities in two orthogonal basis-modes at different interaction time. Non-Classicality is demonstrated at different interaction times on different intensities in two orthogonal basis-modes.

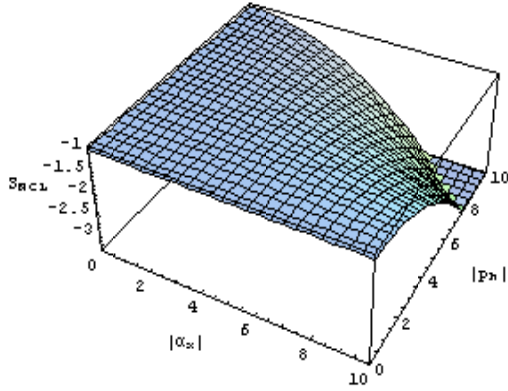

Fig. (3a) Negative values of S_{NCL} is Signature of non-classicality ($kt = 0.01$ sec., $\Delta_h = \pi$).

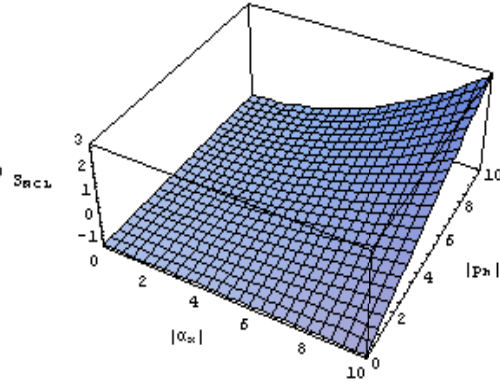

Fig. (3b) Negative values of S_{NCL} is Signature of non-classicality ($kt = 0.001$ sec., $\Delta_h = \pi/2$).

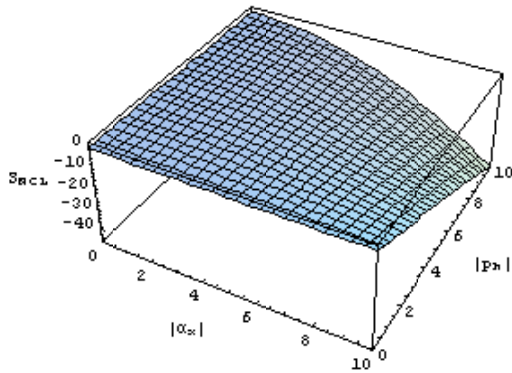

Fig. (3c) Negative values of S_{NCL} is Signature of non-classicality ($kt = 0.01$ sec., $\Delta_h = 3\pi/2$).

Conclusion:- HOPS is generated by utilizing double-mode coherent light equipped with orthogonally polarized collinearly propagating photons as pump field in Degenerate Parametric Amplification. Also Squeezing in Hidden Optical-Polarization is demonstrated by investigating the dynamic behavior of Hidden Optical-Polarization parameters. A squeezing function is recognized having critical dependences on interaction time for particular intensities of light beam. The critical time may be termed as Onset-Time for squeezing with values, $kt = 0.7$ second, at $\varphi_{\text{sum}} = \pi/2$ and for other values of φ_{sum} squeezing is obtained at different onset-times depending on intensities in two orthogonal modes and attains maximum value $\varphi_{\text{sum}} = \pi/2$ (Figs.2a, 2b, 2c, 2d). The key point is to note that squeezing occurs only in two (\hat{H}_2, \hat{H}_3) of the four components of Hidden Optical-Polarization parameters satisfying the condition (Eq.(25)). The non-classical behavior of HOPS is seen by signature of negative values of S_{NCL} in Figs.(3a, 3b, 3c). Non-Classicality manifests at particular interaction time on different intensities in two orthogonal basis-modes. Present study of Non-Classicality, Variances (noise) and Squeezing in HOPS may be applied to characterize continuous-variable Hidden polarization entanglement (to be published elsewhere) which paves the way for utilization HOPS in Quantum Computation and Communication technology.

References

- [1] C. Huygens, *Traite de la Lumiere*, Van der Aa, Leiden, 1690.
- [2] W. Nicol, *Edinburgh New Phl. J.* 6 (1829) 83.
- [3] Max. Born and Emil Wolf, *Principles of Optics*, Cambridge University Press, Cambridge England, 1999.
- [4] G. G. Stokes, *Trans. Cambridge Philos. Soc.* 9 (1852) 399.
- [5] H. Poincare, *Theories', Mathematique de la Lumiere Vol. 2*, Paris, Georgescaree, 1892.
- [6] R. C. Jones, *J. Opt. Soc. Am.* 31 (1941) 488.
- [7] H. Mueller, *J. Opt. Soc. Am.* 38 (1948) 661.
- [8] N. Wiener, *J. Maths and Phys. (M. I. T.)*, 7 (1927) 109.
- [9] L. Mandel and E. Wolf, *Optical Coherence and Quantum Optics*, Cambridge University Press, Cambridge England, 1995.
- [10] W. H. McMaster, *Rev. Mod. Phys.*, 33 (1961) 8.
- [11] P. A. M. Dirac, *Proc. Roy. Soc., A* 114 (1927) 243.
- [12] T. H. Maiman, *Nature*, 187 (1960) 493.
- [13] A. Javan, W. R. Bennett and D.R. Herriot, *Phys. Rev. Lett.* 63 (1961) 106.
- [14] C. K. N. Patel, *Phys. Rev. A* 136 (1964) 1187.
- [15] P. A. Franken, A. E. Hill, C. W. Peters and G. Weinreich, *Phys. Rev. Lett.* 7 (1961) 118.
- [16] N. Bloembergen, *Nonlinear Optics*, Benjamin, New York, 1965.
- [17] H. Prakash and N. Chandra, *Phys. Rev. A* 4 (1971) 796.
- [18] H. Prakash and N. Chandra, *Phys. Lett.* 34 (1971) 28.
- [19] H. Prakash and N. Chandra, *Phys. Rev. A* 9 (1974) 1021.
- [20] G. S. Agarwal, *Lett. Nuovo Cim.* 1 (1971) 53.
- [21] J. Lehner, U. Leonhardt and H. Paul, *Phys. Rev. A* 53 (1996) 2727.
- [22] V. P. Karassiov, *J. Phys. A: Math. Gen.* 26 (1993) 4345.
- [23] J. Soderholm and A. Trifonov, *Opt. Spectrosc.* 91 (2001) 532.
- [24] C. L. Mehta and M. K. Sharma, *Phys. Rev. D* 10 (1974) 2396.
- [25] H. Prakash and Ravi S. Singh, *J. Phys. Soc. Japan*, 69 (2000) 284.
- [26] C. L. Mehta and Anil K. Roy and G. M. Saxena, *Phys. Rev A* 46 (1992) 1565.
- [27] H. Prakash, Naresh Chandra, R. Prakash and Ravi S. Singh, *Current Trends in Atomic and Molecular Physics*, Ed: Rajesh Shrivastva (Phoenix Publication, New Delhi, 2001).
- [28] D. N. Klysko has applied the term 'Hidden-polarization' for monochromatic beam of light for which order of polarization, defined by Intensity-Correlation vanishes for usual polarization while it attains a nonzero value for light polarized in forth order. The author does not discuss for the generation of Hidden Polarization.
- [29] Ravi S. Singh and Gyaneshwar K. Gupta (communicated).
- [30] A. Faraon, J. Fushman and D. Englund, *Nature Phys.*, 4 (2008) 859.

- [31] K. Koshino, Phys. Rev. A **79** (2009) 013804.
- [32] E. B. Flagg, A. Muller, S. V. Polyakov, A. Ling, A. Migdall and G. S. Solomon, Phys. Rev. Lett. **104** (2010) 137401.
- [33] A. Aspect, P. Grangier, and G. Roger, Phys. Rev. Lett. **47** (1981) 460.
- [34] M. Barbieri, F. De Martini, G. Di Nepi, P. Mataloni, G. M. D'Ariano, and C. Macchiavello, Phys. Rev. Lett., **91** (2003) 22790.
- [35] C.H. Bennet, F. Bessette, G. Brassarel, L. Salvail and J. Smolin, J. Cryptology, **5** (1992) 3.
- [36] A. Muller, T. Hertgoz, B. Heettner, W. Tittel, H. Zbinden and N. Gisin, Appl. Phys. Lett. **70** (1997) 793.
- [37] D. Bouwmeester, A. Ekert, and A. Zeilinger The Physics of quantum information, Springer, Berlin, 2000.
- [38] H. Paul, Introduction to quantum optics, Cambridge University Press, Cambridge, England, 2004.
- [39] A. Luis and L. L. Sanchez- Soto, Prog. Opt. **41** (2000) 421.
- [40] D. F. Walls, Nature **306** (1983) 141.
- [41] M. C. Teich and B. E. A Saleh, Quantum Opt. **1** (1989) 153.
- [42] C. K. Hong and L. Mandel, Phys. Rev. A **32** (1985) 974.
- [43] M. Kozierowski, Phys. Rev. A **34** (1986) 3474.
- [44] S. L. Braunstein and R. I. McLachlan, Phys. Rev. A **35** (1986) 1659.
- [45] Mark Hillery, Phys. Rev. A **36** (1987) 3796.
- [46] G. Chiribella and G. M. D'Ariano, Phys. Rev. A **73** (2006) 062103.
- [47] Wojciech Wasilewski, A. I. Lvovsky, Konard Banaszek, Phys. Rev. A **73** (2006) 063819.
- [48] Moritz Mehmet, Henning Vahlbruch and R. Schnabel, Phys. Rev. A **81** (2010) 013814.
- [49] J. E. Santos and N. M. R. Peres, Phys. Rev. A **80** (2009) 053401.
- [50] H. Vahlbruch, R. Schnabel, New J. Phys. **9** (2007) 371.
- [51] P. M. Anisimov, G. M. Raterman, A. Chinivelli, W. N. Plick, S. D. Huver, H. Lee and J. P. Dowling Phys. Rev. Lett. **104** (2010) 103602.
- [52] V. Giovannetti, S. Lloyd and L. Maccone, Science **306** (2004) 1330.
- [53] P. Grangier, R. E. Slusher, B. Yurke and A. Laporta, Phys. Rev. Lett. **59** (1987) 2153.
- [54] N.V. Korolkova, G. Leuchs, R. Loudon, T. C. Ralph, and C. Silberhorn, Phys. Rev. A **65** (2002) 052306.
- [55] W.P. Bowen, R. Schnabel, H. A. Bachor and P. K. Lam, Phys. Rev. Lett. **88** (2002) 093601.
- [56] W.P. Bowen, N. Treps, R. Schnabel and P. K. Lam, Phys. Rev. Lett. **89** (2002) 253601.
- [57] R. J. Glauber, Phys. Rev. **130** (1963) 2529.
- [58] R. J. Glauber, Phys. Rev. Lett. **10** (1963) 84; E. C. G. Sudarshan, Phys. Rev. Lett. **10** (1963) 277.
- [59] U. Leonhardt, Measuring the Quantum States of Light, Cambridge University Press, Cambridge, 1997.
- [60] A. B. Klimov, L. L. Sanchez-Soto, J. Soderholm and G. Bjork, Phys. Rev. A **72** (2005) 033813.
- [61] J. Soderholm, A. Trifonov and B. E. A. Saleh et al., Phys. Rev. Lett. **85** (2000) 5013.
- [62] A. Trifonov, T. Tsegaye et al., J. Opt. B **2** (2000) 105.
- [63] P. Usachev, J. Soderholm, G. Bjork and A. Trifonov, Opt. Commun. **193** (2001) 161.
- [64] R. J. Glauber and B. R. Mollow, Phys. Rev. A **160** (1967) 1097.
- [65] Squeezing is seen only in two of the four Hidden Optical-Polarization parameters enunciated strictly by only one uncertainty relation($\langle \Delta \hat{H}_2^2(t) \rangle$ or $\langle \Delta \hat{H}_3^2(t) \rangle < |1 + \langle \hat{H}_0 \rangle|$).
- [66] Ravi S. Singh, Gyaneshwar K. Gupta and Lallan Yadva, arXiv:1006.4481v1[quant-ph].