

PREDICTING KNOT AND CATENANE TYPE OF PRODUCTS OF SITE-SPECIFIC RECOMBINATION ON TWIST KNOT SUBSTRATES

KARIN VALENCIA^A AND DOROTHY BUCK^B

(A) (corresponding author) e-mail:

karin.valencia06@imperial.ac.uk

Imperial College London, South Kensington Campus,
Department of Mathematics, Office: 640 London SW7
2AZ, England

Telephone number: +44 (0)20 758 58625

(B) d.buck@imperial.ac.uk

Imperial College London, South Kensington Campus,
Department of Mathematics, Office: 623, London SW7
2AZ, England

ABSTRACT

Site-specific recombination on supercoiled circular DNA molecules can yield a variety of knots and catenanes. Twist knots are some of the most common conformations of these products and they can act as substrates for further rounds of site-specific recombination. They are also one of the simplest families of knots and catenanes. Yet, our systematic understanding of their implication in DNA and important cellular processes like site-specific recombination is very limited. Here we present a topological model of site-specific recombination characterising all possible products of this reaction on twist knot substrates, extending previous work of Buck and Flapan. We illustrate how to use our model to examine previously uncharacterised experimental data. We also show how our model can help determine the sequence of products in multiple rounds of processive recombination and distinguish between products of processive and distributive recombination.

This model studies generic site-specific recombination on arbitrary twist knot substrates, a subject for which there is limited global understanding. We also provide a systematic method of applying our model to a variety of different recombination systems.

1. INTRODUCTION

1.1. Site-specific recombination. Site-specific recombination is a cellular process that involves reciprocal exchange between defined DNA sites. Prototypes of site-specific recombination include the integration of bacteriophage λ into the *Escherichia coli* chromosome and the DNA inversions responsible for flagellar phase variation in *Salmonella* [1]. Apart from their fundamental functions in the cell, site-specific recombinases give scientists an elegant, precise and efficient way to insert, delete, and

invert DNA segments. This means that they are rapidly becoming of pharmaceutical and agricultural interest and are being used in the development of biotechnological tools [2–5].

Minimally, site-specific recombination requires one or two duplex DNA molecules (linear, relaxed and plectonemically supercoiled covalently closed-circular DNA are all good substrates for many site-specific recombination reactions. However, plectonemically supercoiled covalently closed circular DNA molecules are the most prevalent in topological enzymology studies, so we focus on these substrates here) containing two short (30-50 base pairs (bp)) sequence specific DNA segments, the *crossover sites* and specialized proteins, *site-specific recombinases*, responsible for recognizing the sites and breaking and rejoining the DNA with conservation of the phosphodiester bond energy (Figure 1). The sites are usually nonpalindromic, so each can be assigned an orientation and if the sites are on a single DNA molecule, they can either be in *direct* orientation (head-to-tail) or in *inverted* orientation (head-to-head). Depending on the initial arrangement of the parental recombination sites and recombinase used, site-specific recombination has one of three possible outcomes: integration, excision or inversion. Larger site-specific recombination systems may also require additional proteins (e.g., accessory proteins) and sites (e.g., accessory sequences).

The reaction starts when a recombinase dimer binds at each of the two recombination sites (from now on, sites). The sites are then brought together to form the *synaptic complex* with the crossover sites juxtaposed, possibly trapping a fixed number of (interdomainal) supercoils. The sites are cleaved, exchanged and resealed. Finally, the proteins dissociate releasing the product molecule, completing the reaction. (Figure 1.)

We refer to the region of space containing the two juxtaposed sites and the recombinase molecules as the *recombinase complex*. The synaptic complex is called a *productive synapse* if the recombinase complex meets the substrate in precisely the two crossover sites. In this model (as opposed to the tangle model), we assume that any enhancer sequences and/or accessory proteins are sequestered from the recombinase complex and that the recombinase complex meets the substrates at precisely the two crossover sites. That is, we assume that the synaptic complex is a productive synapse (Figure 2). During the intermediate step, once the crossover sites have been cleaved, multiple rounds of strand exchange can occur before resealing the DNA, this is called *processive recombination*. The entire process of recombination (including releasing and rebinding) can also occur multiple times, either at the same site or at different sites, this process

Date: 15th May 2022.

is called *distributive recombination*. In this work we use the term *substrate* to refer specifically to the DNA prior to the first cleavage. Processive recombination is treated as one extended process, given an initial substrate with several intermediate exiting points for the reaction.

Site-specific recombinases can be broadly divided into two subfamilies: serine recombinases and tyrosine recombinases, based on sequence homology, catalytic residues and their mechanisms of cutting and rejoining the DNA. Only serine recombinases can mediate processive recombination. See [1] (and references therein) for a detailed exposition of site-specific recombination.

1.2. DNA knots and catenanes. A variety of DNA knots and catenanes have been observed since their discovery in the 1960s [6–8,12]. (Experimentally, two techniques have been widely used to resolve DNA knots and catenanes, electron microscopy and electrophoretic migration, [9–11].) However, they arise more commonly as products of topological enzymology experiments on artificially constructed small (3-5 kb) DNA plasmids. Knots and catenanes are generated and then used as experimental tools to investigate the mechanisms of enzymes acting on DNA. They are used as substrates for these reactions and careful analysis of the topology of the product DNA molecules allows inferences to be drawn about the detailed mechanism of the reaction [9,13–21,21–23,23–41].

1.3. DNA twist knots as substrates for site-specific recombination. A *twist knot* $C(2, v)$ is a knot that admits a projection as illustrated in Figure 3d. Mathematically, twist knots are the simplest family of knots (after the torus knots and catenanes $T(2, m)$, which admit a projection as in Figure 3c) and appear more prevalently for small *minimal crossing number* (See Section 2.1 for a definition).

Twist knots are ubiquitous DNA knot molecules *in vivo* and *in vitro*. Most DNA inside prokaryotic cells is plectonemically supercoiled and in the lab most experiments done with site-specific recombinases use small plectonemically supercoiled circular DNA molecules. This supercoiling promotes strand collision and DNA entanglement. A simple crossing change in such a molecule can result in knotting of the DNA into twist knots (Figure 4).

Together with torus knots and catenanes, twist knots are the most common products of site-specific recombination both *in vivo* [41] and *in vitro* [13–16,41,42], mediated by serine recombinases and tyrosine recombinases on unknotted, unlinked and torus knot and torus catenane substrates (see Table 1 in [43] and references therein). For example, recombination mediated by λ Int on the torus catenane $T(2, -2)$ with *attP* and *attB* bacteriophage lambda attachment sites, one on each of the components of the catenane substrate, yields the twist knot products $C(-2, 3)$, $C(-2, 5)$, $C(-2, 7)$ and $C(-2, 9)$ (Table

7 in [16], see also the top image of Figure 5). Site-specific recombination mediated by Hin recombinase on an unknot substrate with inverted sites, has the following sequence of processive recombination: $C(-2, -1)$ (substrate) $\rightarrow C(-2, -1) \rightarrow C(-2, 1) \rightarrow C(-2, 2) \rightarrow C(-2, 3)$ [41] (see also the middle image of Figure 5). The twist knots $C(-2, 1)$, $C(-2, 2)$ and $C(-2, 3)$ are products of the second, third and fourth rounds of processive recombination on an unknotted substrate.

Experimental conditions do not always preclude distributive rounds of recombination, and both can occur¹. In multiple rounds of processive and distributive recombination on unknot, unlink and torus knot and catenane substrates, twist knots can become substrates of new recombination reactions. For example, in experiments of Kanaar et al [20], site-specific recombination on an unknot substrate with inverted sites, mediated by Gin, yields the following products of processive recombination: $C(-2, -1)$ (substrate) $\rightarrow C(-2, -1) \rightarrow C(-2, 1) \rightarrow C(-2, 2) \rightarrow C(-2, 3)$ [41] (see also the middle image of Figure 5). The twist knots $C(-2, 1)$, $C(-2, 2)$ and $C(-2, 3)$ are products of the second, third and fourth rounds of processive recombination. Also, the composite knot on six crossings, the granny knot $C(-2, 1)\sharp C(-2, 1)$ was analysed to be a product of distributive recombination on two trefoils, each a product from the first round of recombination.

Thus, a better understanding of DNA twist knots and their role in site-specific recombination reactions may contribute to the understanding of the mechanisms of this cellular process.

1.4. Our Model. Given the variety of DNA knots and catenanes that arise from site-specific recombination, it is clear that stratification of these products is necessary. Topological techniques such as those presented here, can aid experimentalists in characterizing DNA knot and catenane products. Our model predicts the exact topology and chirality of possible products, thus restricting the knot or catenane type of the products observed.

Despite the ubiquity and biological importance of of these knots, previous systematic study of twist knots involved in DNA-protein interactions has been limited and there has yet to be a systematic model incorporating these as substrates for a generic site-specific recombinase. Earlier predictions of knots arising from site-specific recombination did not consider twist knot substrates [19, 43, 44]. Here we rectify this by presenting a model, extending the work of [44], classifying all possible knots and links that can arise from site-specific recombination on a twist knot substrates.

¹Distributive recombination can be minimized for example by stereostructural impediments or diluted protein concentration (see e.g., [14, 46]).

Our model is built on three biological assumptions, stated in Section 3. From these, we construct a model that predicts all possible knots and catenanes that can arise as products of a single round of recombination, multiple rounds of (processive) recombination, or distributive recombination on a plectonemically supercoiled twist knot substrate $C(2, v)$. We predict that products arising from site-specific recombination on a twist knot substrate $C(2, v)$ must be members of three families of products, illustrated in Figure 6. Members of these families of knots and catenanes include prime and composite knots and catenanes with up to three components. Our model is independent of site orientation. We make no assumption on the size (number of basepairs) of the molecule(s). In [45] we provide detailed topological proofs for the model presented here.

Note that, although the three assumptions are not for a generic recombinase, but rather, for general site-specific recombination, our model can restrict the topology of products in a specific system. If for example, the site-orientation is taken into account, the model further restricts the possible products of such a reaction. We illustrate this in Section 5 with many examples.

1.5. Structure of this paper. This article is organized as follows. In Section 2 we explain mathematical terminology and notation. In Section 3, we state the three assumptions of our model. In Section 4, we explain how, given a twist knot $C(2, v)$, all possible knotted or catenated products fall into three characterised families. We also consider the (common) case of products that have minimal crossing number (MCN) one more than the substrate, and show that the product knot or catenane type is even more tightly prescribed. Finally, in Section 5, we discuss how the model can help predict all possible products of (non-distributive) recombination mediated by a serine recombinase and a tyrosine recombinase, determine the order of products of processive recombination, distinguish products of distributive recombination, and narrow the possible knot or catenane type for previously uncharacterised experimental data.

2. MATHEMATICS TERMINOLOGY AND NOTATION

In this section we define a few mathematical terms and introduce notation. Figures 2 and 3 present diagrams for each one of the terms defined. (We note that all line segments in these images represent the central axis of the double helix of a duplex DNA molecule.)

Throughout this article, we adopt the convention for crossings illustrated in Figure 3a.

2.1. Mathematical terminology. A *catenane* L is a collection of separate rings that may or may not be knotted, called *components*. (Figure 3b.) A *knot* K is considered to be a catenane of one component (Figure 3b.) Roughly, two knots or catenanes K, J are *equivalent* if

there is a continuous deformation from K to J (without cutting them). A *torus knot or catenane*, $T(2, m)$ is a knot or catenane formed by closing a row of m plectonemic twists (such a closing is achieved by identifying the top and bottom endpoints of the arcs representing twists, without introducing or removing further crossings, see Figure 3c). A *twist knot* $C(2, v)$ is a knot that admits a projection with two non-adjacent rows of crossings: a row of $v \neq 0, 1$ vertical crossings and a *hook*, of the form shown in Figure 3d. Note that $C(-2, v - 1) = C(2, v)$. The equivalence of these two forms can be seen via a continuous deformation by flipping the hook. Note that twist knots can be generalized to *clasp knots* (Figure 3e). A clasp knot $C(r, v)$ is a knot that has two non-adjacent rows of crossings, one with $r \neq 0, \pm 1$ crossings and the other with $v \neq 0$ crossings. A clasp knot $C(r, v)$ with $r = \pm 2$ is a twist knot.

In this work we may use the standard Rolfsen notation and the $T(2, m)$, $C(2, r)$ notation interchangeably. We give examples of both notations for knots and catenanes with the smallest minimal crossing number (the standard Rolfsen notation is on the left): $0_1 = C(2, 1)$, $(+)2_1^2 = T(2, 2) = C(2, 0)$, $(-)3_1 = C(-2, 1)$, $(+)3_1 = C(2, -1)$, $4_1 = C(2, -2)$, $(-)4_1^2 = T(2, -4)$, $(+)5_1 = T(2, 5)$, $5_2 = C(2, -3)$, $6_1 = C(2, -4)$. For more examples, see [47]. Note that $T(2, m)$ is a catenane if m is even and is a knot if m is odd (Figure 3c).

Given two knots or catenanes K_1 and K_2 , their *composite knot or catenane*, written $K_1 \# K_2$, is obtained by removing an unknotted arc from each and gluing the resulting two endpoints of K_1 to the two endpoints of K_2 without introducing (or removing) any additional knotting (Figure 3f). A *prime* knot is one that can only be decomposed into two sub-knots $K_1 \# K_2$ if one is trivial (i.e. equivalent to the unknot). The *minimal crossing number* of a knot or catenane K , denoted $\text{MCN}(K)$, is the fewest number of crossings with which it can be drawn. For example, $\text{MCN}(\text{unknot}) = 0$ and $\text{MCN}(C(2, -2)) = 4$. Similarly, $\text{MCN}(C(2, v)) = |v| + 2$ if $v < 0$ or $\text{MCN}(C(2, v)) = v + 1$ if $v > 0$. See [47–49] for a mathematical study of knots and catenanes.

Let J denote the substrate $C(2, v)$. Recall that in this model we assume that the synaptic complex is a productive synapse (defined in page 2, see also Figure 2), so let B denote the smallest region containing the four bound recombinase molecules and the two crossover sites, that is, the recombinase complex. (B is a topological ball i.e., it can be continuously deformed to a round ball, see Figure 1.) The *recombinase-DNA complex* $B \cup J$ is the recombinase complex B along with the rest of the substrate molecule J .

2.2. Notation for product families. In the Section 4 we show all knots and catenanes arising from site-specific recombination on a twist knot substrate must fall into

three families of knots and catenanes: $F(p, q, r, s, t, u)$, $G_1(k)$ and $G_2(k)$, illustrated in Figures 6a, 6b and 6c respectively.

In the family $F(p, q, r, s, t, u)$ of knots and catenanes, the variables p, q, r, s, t, u describe the number of crossings between two DNA duplexes in that particular row of crossings. In this family, the variables p, q, r, s, t, u can be positive, negative or zero. t, r and p can take horizontal and vertical zero crossings and only horizontal non-zero crossings. u, s and q can only take (both zero and non-zero) vertical crossings. In the families $G_1(k)$ and $G_2(k)$ of knots and catenanes, the variable k describes the number of crossings between the two DNA duplexes. Depending on the value of k , we obtain either a knot or a catenane: if k is odd, the members of these families are knots and if k is even, then the members of these families are two-component catenanes. Note that there are knots and catenanes that have projections in both $F(p, q, r, s, t, u)$ and one of $G_1(k)$ or $G_2(k)$. For example the trefoil knot has a projection as a member of $F(p, q, r, s, t, u)$ with $p = 0, t, u = 1, r = 2, s = -1$, and a projection as a member of $G_2(k)$ with $k = 2$. Most knotted and catenated products are in the family $F(p, q, r, s, t, u)$. However, there are a series of products of site-specific recombination with a tyrosine recombinase that do not belong to this family but belong to one of $G_1(k)$ or $G_2(k)$.

3. ASSUMPTIONS OF OUR MODEL

Given a twist knot substrate and a given recombinase, we now state assumptions about the recombinase-DNA complex. Evidence that these assumptions are biologically reasonable is given in Section 2 of [43].

Assumption 1. *The recombinase complex is a productive synapse, and there is a projection of the crossover sites with 0 or 1 crossing between the sites and no crossings within a single site.*

Figure 7 illustrates projections of B before recombination.

Assumption 2. *The productive synapse does not pierce through a supercoil or a branch point in a nontrivial way and the supercoiled segments are closely juxtaposed. Also, no persistent knots or catenanes are trapped in the branches of the DNA on the outside of the productive synapse.*

Figure 2 illustrates examples of recombinase complexes that either are or are not productive synapses. Figure 8 illustrates different examples of DNA molecules that are and that are not allowed according to assumption 2. Note that we allow hooked junctions (see Figure 3a) because these have projections where there is only one crossing between the sites, but no projections with no crossings between the sites.

Assumption 3 for Serine recombinases. *Serine recombinases perform recombination via the **subunit exchange mechanism** [1]. This mechanism involves making two simultaneous double-stranded breaks in the sites, rotating two recombinase monomers in opposite sites by 180° within the productive synapse and resealing the new DNA partners. In each subsequent round of processive recombination, the same set of subunits is exchanged and the sense of rotation remains constant.*

Figure 9 illustrates Assumption 3 for serine recombinases. It illustrates projections of B at each round of processive recombination mediated by a serine recombinase. Recall that in processive recombination, the term substrate refers specifically to the DNA prior to the first cleavage.

Assumption 3 for Tyrosine recombinases. *After recombination mediated by a tyrosine recombinase, there is a projection of the crossover sites which has 0 or 1 crossing.*

Figure 10 illustrates Assumption 3 for tyrosine recombinases. It illustrates all possible projections of B after recombination mediated by a tyrosine recombinase. For the post-recombinant synapse, note that we allow hooked junctions because these have projections where there is only one crossing between the sites, but no projections with no crossings between the sites. Note also that tyrosine recombinases can sometimes give the appearance of “processive recombination” in the circumstances involving multiple rounds of recombine and reset, without loss of accessory factor binding. In this work we regard this action mediated by tyrosine recombinases as distributive recombination.

4. RESULTS

Given the three assumptions in the previous section, we predict that all product knots and catenanes of (non-distributive) site-specific recombination on twist knots with a tyrosine recombinase (Theorem 1) or with a serine recombinase (Theorem 2) fall within the three families of knots and catenanes illustrated in Figure 6. We also predict the exact knot and catenane type of possible products of one round of recombination on a twist knot substrate that have MCN one more than the substrate molecule. The technical proofs of these results can be found in [45].

4.1. Products of non-distributive site-specific recombination belong to three families of knots and catenanes.

Theorem 1. (Tyrosine recombinases) *Suppose that Assumptions 1, 2 and 3 hold for a particular tyrosine recombinase-DNA complex. Then the only possible products of (non-distributive) recombination on a twist knot $C(2, v)$ are those illustrated in the left half of Figure 11.*

(That is, if the substrate knot is a twist knot $C(2, v)$ then the only possible products (of a non-distributive reaction) are the unknot, the two node catenane 2_1^2 , $T(2, m)$ for $m = v, v \pm 1, v \pm 2$, $C(2, s)$ for $s = v \pm 1, v \pm 2$, $C(r, v)$ for $r = \{\pm 2, \pm 3, 4\}$, a connected sum $T(2, \pm 2) \sharp C(2, v)$, a member of the family $F(p, q, r, s, t, u)$ with $|r| = 2, |t| = 1$ or $2, |p| \leq 1$, or a member of the family of knot and links $G_1(k)$ or of the family of knots and links $G_2(k)$.)

Theorem 2. (Serine recombinases) Suppose that Assumptions 1, 2 and 3 hold for a particular serine recombinase-DNA complex. Then the only possible products of n rounds of processive (non-distributive) recombination on a twist knot $C(2, v)$ are those illustrated in right half of Figure 11.

(That is, if the substrate knot is $C(2, v)$ then the only possible products of n rounds of (non-distributive) processive recombination are the $C(r, v)$ for $r = \pm n, \pm n + 2$, $C(2, s)$ for $s = v, v \pm n$, $T(2, v \pm n)$, a connected sum $T(2, \pm n) \sharp C(2, v)$ and any member of the family $F(p, q, r, s, t, u)$ with $|r| \geq 2, t \neq 0$ and $|p| \leq 1$.)

Note: Theorems 1 and 2 distinguish between the chirality of the product DNA molecules, since using our model we can work out the exact conformation of all possible products of site-specific recombination starting with a particular twist knot substrate and site-specific recombinase. For example, starting with the twist knot substrate $C(2, -1)$ (a $(-)$ trefoil, see Figure 3g for an illustration of a $(-)$ -trefoil and $(+)$ -trefoil) then according to our model site-specific recombination mediated by a tyrosine recombinase yields $T(2, -5)$, which is a $(-)$ 5₁ (among other products) and can never yield $T(2, +5)$, which is a $(+)$ 5₁.

4.2. Characterization of products of distributive recombination.

Theorem 3. Any products whose knot or catenane type is not listed in the Theorems 1 and 2 must arise from distributive recombination.

Knots and links in $F(p, q, r, s, t, u)$ that cannot arise from recombination mediated by a serine recombinase, nor by a tyrosine recombinase. Recall that all products from recombination with a tyrosine recombinase or a serine recombinase belonging to $F(p, q, r, s, t, u)$ can be expressed with $r > 2, t \neq 0$ and $|p| \leq 1$. Thus, any knots that cannot be expressed in this form cannot arise as products of recombination with either a serine recombinase or a tyrosine recombinase. 8_{18} and 10_{141} are examples of such knots.

Knots that cannot arise from recombination mediated by a tyrosine recombinase. There are knots and links in $F(p, q, r, s, t, u)$ which do not have a projection with $|t| = \{\pm 1, \pm 2\}$ and $|p| \leq 1$, for example, the knot $8_{11} = F(2, 2, 2, -1, -3, 0)$. By inspection we can see that there is no way to express 8_{11} as a member of $F(p, q, r, s, t, u)$ with $t = \{\pm 1, \pm 2\}$ and $|p| \leq 1$, hence 8_{11} is not a product

of recombination with a tyrosine recombinase. The knot 10_{64} is another knot that cannot be a product of recombination with a tyrosine recombinase.

Knots that can arise as products of recombination mediated by a serine recombinase, but not by a tyrosine recombinase. In contrast with Theorem 1, any knot or link in the family $F(p, q, r, s, t, u)$ with $t \neq 0$ (not just $t = \{\pm 1, \pm 2\}$) and $|p| \leq 1$, can occur as a consequence of Theorem 2. The knot 8_{11} mentioned above is an example of this; this knot is a possible product of recombination with a serine recombinase, but not with a tyrosine recombinase.

4.3. Products whose MCN is one more than the substrate.

Often recombination increases the minimal crossing number of a knotted or catenated substrate by one (e.g., [50]). In this case, we can further restrict the knot and catenane type of the possible products of recombination.

Theorem 4. Suppose that Assumptions 1, 2, and 3 hold for a particular recombinase-DNA complex with substrate $J = C(2, v)$ and suppose site-specific recombination increases the minimal crossing number by one. Let L be the product of a single recombination event. Then for $v > 0$, L can be any of the knots and catenanes illustrated in the left half of Figure 12 and for $v < 0$, L can be any of the knots and catenanes illustrated in the right half of Figure 12. These are the only possibilities for L .

(That is, if $v > 0$, L is one of the following: $C(2, v+1)$, $C(2, -v)$, $C(-2, v)$, $C(-2, -(1+v))$, $C(3, v)$, $T(2, \pm(2+v))$, $F(0, q, 2, s, 2, u)$ where $q + s = v$, $F(0, \pm 1, 2, s, 0, u)$ where $q + s = v$ and $s \neq 0$ or $F(0, 0, 2, s, 2, u)$ where $q + s = v$.)

If $v < 0$ L is one of the following: $C(2, 2 + |v|)$, $C(2, -(1 + |v|))$, $C(-2, 1 + |v|)$, $C(-2, -(2 + |v|))$, $C(3, v)$, $C(-4, v)$, $T(2, \pm(3 + |v|))$ or $F(0, \pm 1, 2, s, 0, u)$ for $q + s = v$.)

5. DISCUSSION AND APPLICATIONS

Our model predicts products of processive and distributive recombination in a number of ways that we discuss in detail below. In Sections 5.1, 5.2 and 5.3 we outline three algorithms that help us: predict all possible products of (non-distributive) processive site-specific recombination on twist knot substrates mediated by a serine recombinase, determine the sequence of products of processive recombination given a substrate and a list of experimentally characterized products, and determine all the products of (non-distributive) recombination of a twist knot substrate, mediated by a tyrosine recombinase. We illustrate how to use these algorithms in Applications 1, 2 and 3. In Application 3 we we employ Algorithm

3 to analyse previously uncharacterised products of distributive recombination mediated by a tyrosine recombinase. In Section 5.4 we illustrate other applications of our model: In Application 4 we discuss how our model can reduce the number of possibilities of products in situations where they have MCN one more than the substrate. In Application 5 we explain how our model can be used to distinguish between products of processive and distributive recombination.

5.1. Algorithm 1: Determining all products of recombination mediated by a serine recombinase.

- (1) Choose a twist knot substrate. Determine if the substrate is of the form $C(-2, v)$ or $C(2, v)$. If necessary, employ a deformation of the substrate molecule by flipping the hook to make the substrate molecule the twist knot $C(2, v)$ (instead of $C(-2, v - 1)$). Determine v .
- (2) The right half of Figure 11 illustrates all the possible conformations of products of site-specific recombination on the twist knot $C(2, v)$ mediated by a serine recombinase. For each, replace v with the value of v (that is, v should be replaced for the value of v of the substrate. For instance, if the substrate is the trefoil knot $C(2, -1)$ then the number of crossings in the row of crossings v in these figures should be replaced by one negative crossing) and recall that $q + s = v$ so consider each combination of q and s such that $q + s = v$.
- (3) For a substrate that does not have mismatched sites: to obtain all possible products of the k^{th} round of processive recombination, for each each image of the right half of Figure 11, replace n by k number of either positive, negative crossings if the handedness of recombination of the enzyme is known, or both positive and negative crossings if the handedness is not known.
- (4) For a substrate that has mismatched sites: to obtain all products of the k^{th} round of processive recombination, replace n by $2k$ crossings.
- (5) Exclude any predicted products that are not possible due to the relative orientation and alignment of the specific sites or any other special properties of the particular system in question. (Depending on the relative orientation (direct or inverted repeat) of the sites catenanes may or may not be possible products of the reaction. Also, the alignment (parallel or antiparallel) of the sites, may produce mismatched crossover sites. In this case, an even number of site exchanges are necessary in order for the recombinase to be able to reseal the DNA sites, leaving the parental genomic sequence intact but introducing two or more crossings.)

Application 1. Predicting all products of recombination on a twist knot substrate mediated by a serine recombinase. Suppose we choose the substrate $C(2, -2)$ with

wild-type sites. Then $v = -2$, so replace $v = -2$ in each image of the right-hand side of Figure 11 and recombination proceeds through one round of strand exchange during each round of processive recombination. Suppose also that we do not know the direction of rotation of one half of the recombinase complex relative to the other, during strand exchange. We want to know all possible products of the first three rounds of processive recombination.

The products of the first round of recombination (obtained by replacing n with one (positive and negative) crossing) are: $C(+1, -2)$, $C(-1, -2)$, $C(+1+2, -2)$, $C(-1+2, -2)$, $C(2, -2)$, $C(2, -2 + 1)$, $C(2, -2 - 1)$, $T(2, -2 + 1)$, $T(2, -2 - 1)$, $T(2, +1)\#C(2, -2)$, $T(2, -1)\#C(2, -2)$, $F(0, 0, 2, -2, +1, u)$, $F(0, 0, 2, -2, -1, u)$, $F(0, -1, 2, -1, +1, u)$, $F(0, -1, 2, -1, -1, u)$, $F(0, -2, 2, 0, +1, u)$, $F(0, -2, 2, 0, +1, u)$, $F(0, q, 2, -2, +1, u)$, $F(0, q, 2, -2, -1, u)$.

The products of the second round of recombination (obtained by replacing n with two (positive and negative) crossings) are: $C(+2, -2)$, $C(-2, -2)$, $C(+2+2, -2)$, $C(-2+2, -2)$, $C(2, -2+2)$, $C(2, -2-2)$, $T(2, -2+2)$, $T(2, -2-2)$, $T(2, +2)\#C(2, -2)$, $T(2, -2)\#C(2, -2)$, $F(0, 0, 2, -2, +2, u)$, $F(0, 0, 2, -2, -2, u)$, $F(0, -1, 2, -1, +2, u)$, $F(0, -1, 2, -1, -2, u)$, $F(0, -2, 2, 0, +2, u)$, $F(0, -2, 2, 0, +2, u)$, $F(0, q, 2, -2, +2, u)$, $F(0, q, 2, -2, -2, u)$.

The products of the third round of recombination (obtained by replacing n with three (positive and negative) crossings) are: $C(+3, -2)$, $C(-3, -2)$, $C(+3+2, -2)$, $C(-3+2, -2)$, $C(2, -2+3)$, $C(2, -2-3)$, $T(2, -2+3)$, $T(2, -2-3)$, $T(2, +3)\#C(2, -2)$, $T(2, -3)\#C(2, -2)$, $F(0, 0, 2, -2, +3, u)$, $F(0, 0, 2, -2, -3, u)$, $F(0, -1, 2, -1, +3, u)$, $F(0, -1, 2, -1, -3, u)$, $F(0, -2, 2, 0, +3, u)$, $F(0, -2, 2, 0, +3, u)$, $F(0, q, 2, -2, +3, u)$, $F(0, q, 2, -2, -3, u)$.

These correspond to: (knots) $0_1, (-)3_1, 4_1, 5_2, (-)6_1, 7_2$, (catenanes) $(+)2_1^2, (-)4_1^2$, (composite knots and catenanes) $(\pm 3_1)\#4_1, (\pm)2_1^2\#4_1$ and any products belonging to the infinite families $F(0, 0, 2, -2, \pm n, u)$, $F(0, -1, 2, -1, \pm n, u)$, $F(0, -2, 2, 0, \pm, u)$, $F(0, q, 2, -2, \pm n, u)$ for u any positive integer. Two important observations: the products not in the infinite families are very tightly prescribed and the handedness of all the chiral products (except 2_1^2) is negative.

5.2. Algorithm 2: Determining the sequence of products of processive recombination (given a specific substrate and experimentally characterized products). When the products of processive recombination are known, but not the ordering, the algorithm below can determine the sequence of products.

- (1) Determine if the substrate is of the form $C(-2, v)$ or $C(2, v)$. If necessary, employ a deformation of the substrate molecule by flipping the hook to make the substrate molecule the twist knot $C(2, v)$ (instead of $C(-2, v - 1)$). Determine v .

- (2) Figure 13 lists all the possible conformations of the synaptic complex and the possible products that particular conformations yields. Use the characterised products from the experiment to determine which image in Figure 13 is the pre-recombinant conformation of the synaptic complex. Perform the rest of the algorithm only for that conformation.
- (3) For Figures 13(b) – 13(h) replace v by its value (that is, v should be replaced by the value of v of the substrate). In Figure 13(a) recall that the number of crossings q and s should add up to the number of crossings v . So consider each combination of q and s such that $q + s = v$.
- (4) Figure 13 also gives the possible pre-recombinant forms of B for each conformation of the synaptic complex, and Figure 9 gives the post-recombinant forms of B at each stage of processive recombination. Use the characterised products and these Figure 13 to determine the pre-recombinant form of B and for that form, from Figure 9, which path yields those products.
- (5) In the synaptic complex form chosen, replace B with each of its post-recombinant forms at each stage of processive recombination to obtain a sequence of products.
- (6) Exclude any predicted products that are not possible due to specific properties of the particular system in question. (See the step (5) of the algorithm in Section 5.1.)

This algorithm gives the order of products of processive recombination and any products arising from the experiment that are not in the list of predicted products are assumed to arise from distributive recombination.

Application 2. *Determining the possible sequences of products of processive recombination.*

Example. Suppose that for the twist knot substrate $C(-2, 3)$, experimental conditions minimize distributive recombination and analysis of the products reveal unknots, (unknown) torus knots and (unknown) clasp knots $C(r, s)$.

We can determine the order of products of recombination by using Figures 9 and 13 as follows:

- We perform a deformation of the substrate molecule by flipping the hook to make the substrate molecule the twist knot $C(2, 4)$ (instead of $C(-2, 3)$).
- From Figure 13 we see that the conformation of the synaptic complex must be that illustrated in Figure 13(e). This is the only conformation of the synaptic complex that yields unknots, torus knots (and catenanes) and clasp knots.
- Also from Figure 13, the pre-recombinant conformation of B must be form $B1$.

- From Figure 9, we see that path 1 is the only path that gives an unknot as a product (of the second round of recombination).

Thus, in Figure 13(e) replace the B by the post-recombinant form after each round of processive recombination. We deduce that the sequence of products is: $C(2, 4)$ (substrate) $\rightarrow T(2, -1 + 4) \rightarrow C(0, 4)$ (unknot) $\rightarrow T(2, 1 + 4) \rightarrow C(-2, 4) \rightarrow C(-3, 4)$. Any products of further rounds of processive recombination are clasp knots $C(r, 4)$ with increasing minimal crossing number.

Example (Substrate with mismatched sites). In cases where there is a mismatch in the crossover sites, two subunit exchanges are necessary in order for the recombinase to be able to reveal the DNA sites. (That is, processive recombination performs two 180° rotations of one half of the productive synapse relative to the other before ligating the sites.)

Assume that for the twist knot substrate $C(-2, 2)$ experimental conditions minimize distributive recombination and that processive recombination encounters mismatched sites after one round of exchange, so it proceeds through two exchanges of the crossover sites per round of recombination. Suppose that the products of multiple rounds of processive recombination are twist knots and connected sums of a torus knot and a twist knot. Then we employ a similar method to that explained in the example above:

- We perform a deformation of the substrate molecule by flipping the hook to make the substrate molecule the twist knot $C(2, 3)$ (instead of $C(-2, 2)$).
- Figure 13(c) gives the conformation of the synaptic complex because this is the only conformation that gives connected sums of torus knots or catenanes and twist knots.
- B is either $B3$ or $B4$ because: from 13(c), $B = B1, B3$ or $B4$, but all paths of $B1$ give only the twist knot $C(2, 3)$.
- The path must be path 1 for both $B3$ and $B4$ because path 2 does not give any twist knots and paths 3 and 4 give only the twist knot $C(-2, v)$.

So, using $B = B3$, path 1, we obtain the following sequence of products: $C(2, 3)$ (substrate) $\rightarrow C(2, 3) \rightarrow T(2, -3)\sharp C(2, 3) \rightarrow T(2, -5)\sharp C(2, 3)$. Moreover, any products of further rounds of recombination are connected sums of the form $T(2, m)\sharp C(2, 3)$ for m an odd negative integer, with increasing minimal crossing number.

Using $B = B4$, path 1, we obtain the following sequence of products: $C(2, 3)$ (substrate) $\rightarrow C(2, 3) \rightarrow T(2, 3)\sharp C(2, 3) \rightarrow T(2, 5)\sharp C(2, 3)$ Moreover, any products of further rounds of recombination are connected sums of the form $T(2, m)\sharp C(2, 3)$ for m an odd positive integer, with increasing minimal crossing number.

5.3. Algorithm 3: Determining all products of (non-distributive) recombination mediated by a tyrosine recombinase.

- (1) Use the characterised products from the experiment to determine if the substrate is a twist knot of the form $C(2, v)$ or $C(-2, v)$. If necessary, employ a deformation of the substrate molecule by flipping the hook to make the substrate molecule the twist knot $C(2, v)$ (instead of $C(-2, v - 1)$). Determine v .
- (2) The left half of Figure 11, illustrates all the possible conformations of a product of site-specific recombination on the twist knot $C(2, v)$ mediated by a tyrosine recombinase. For products other than $G_1(k)$ or $G_2(k)$, replace v (and/or q and s , recall $q + s = v$, so consider all combinations) with the value of v (that is, v should be replaced for the value of v of the substrate).
- (3) For products of the form $G_1(k)$ or $G_2(k)$:
 - If v is a negative odd number, the product is a knot belonging to family $G_1(k)$ with $k = |v|$.
 - If v is a positive odd number, the product is a knot belonging to family $G_2(k)$ with $k = |v| - 1$.
 - If v is a negative even number, the product is a link belonging to family $G_1(k)$ with $k = |v|$.
 - If v is a positive even number, the product is a link belonging to family $G_2(k)$ with $k = |v| - 1$.
- (4) Exclude any predicted products that are not possible due to specific properties of the particular system in question. (See the step (5) of the algorithm in Section 5.1.)

For both serine and tyrosine site-specific recombinases, any product molecules that arise from the experiment that are not in the list of knots and catenanes predicted by the algorithms are assumed to have arise from distributive recombination reactions.

Application 3. *Narrowing possible knot and catenane type for previously uncharacterised experimental data: Products of distributive recombination of a tyrosine recombinase.* We now consider products of multiple rounds of distributive recombination mediated by a tyrosine recombinase. In [16] Crisona *et al* performed experiments using the Flp recombinase of the yeast $2\mu\text{m}$ plasmid on unknotted substrates. They studied Flp inversion reactions by carrying out the experiments on plasmids containing two inverted FRT sites. Note that FRT sites in inverted repeats cannot yield catenanes as products of one round of recombination with a Flp recombinase. Flp can catalyse multiple rounds of distributive recombination, so it forms both even and odd-noded knots. In their paper, they were only interested in the odd-noded knots as they

are products of the first round of distributive recombination. They found that trefoil knots $C(2, -1) = 3_1$ were among these products and did not identify product of further rounds of distributive reactions.

An interesting question is: What are the possible products of further rounds of distributive recombination? This can be answered using Theorem 1 and Figure 11 (left-hand side). We assume that the product of the first round of distributive recombination (and thus our substrate) is the trefoil knot $C(2, -1)$. In Figure 11 (left-hand side), we set $v = -1$ in each image (since the substrate is $C(2, -1)$). From this we can see that the possible products of a second round of distributive recombination by Flp recombinase on the unknot are $0_1, 3_1, 4_1, 5_1, 5_2, 0_1^2, 2_1^2, 4_1^2, 2_1^2\#3_1$ and any non-catenane products belonging to the family $F(p, q, 2, s, t, u)$ with $|p| = 1$, $q + s = -1$ and $|t| = 2$ as illustrated in Figure 11 (left-hand side). (Note that here we did not take into account handedness, but it can be revealed by writing the products in $C(r, s)$ and $T(2, m)$ notation as in the left-hand side of Figure 11.) Recall that for these images, the vertical row of u crossings can be any number of crossings. This means that topologically, there are infinitely many possibilities for these product knots. However, biologically, due to physical and other constraints of the DNA molecule, conformations with a small value of u would probably be the most abundant.

5.4. Other applications of our model.

Application 4: *Products of recombination reactions that increase the MCN by 1.* Very commonly, site-specific recombination adds one crossing to the substrate, resulting in an increase by one of the MCN of the substrate. For example Bath *et al* used the catenanes $T(2, 6)$ and $T(2, 8)$ as substrates for XerCD recombination yielding product knots with MCN equal to 7 and 9 [51]. They did not characterise these products beyond their MCN (although they did make strong biological predictions as to their exact topology). Buck and Flapan [43] significantly reduced the possibilities for each of these products, Darcy [23] used the tangle model to reduce the number of mathematical solutions to the tangle equations involving the 4-noded catenane 4_1^2 (product of one round of recombination on an unknot substrate) and a 7-noded knot (products of one round of recombination on the torus catenane 6_2^2) and Vazquez *et-al* [24] designed a three-dimensional model for Xer recombination.

As DNA twist knots are common recombination substrates, considering a similar scenario to the Xer example above is relevant. To do this we apply Theorem 4. Figure 12 summarizes this theorem. Suppose the twist knots $C(2, 5)$ and $C(2, 7)$ (MCN 6 and 8 respectively) are used as substrates for a site-specific recombination reaction with Xer recombinase, where experimental conditions minimize distributive recombination and products are knots and catenanes with minimal crossing number 7 and 9. (Note that Xer has been shown to recombine on both

directly and inversely repeated sites, thus knots or catenanes are expected depending on site orientation.) In this case the minimal crossing number is not sufficient to determine the knot type, since there are 7 knots and 8 two-component catenanes with $MCN=7$ and 49 knots and 61 two-catenanes with $MCN=9$. However, we can use Theorem 4 (and Figure 12) to significantly reduce the number of possibilities for these products. By replacing v for 5 crossings in each illustration of Figure 12, it follows that the possible seven-crossing products are $7_1, 7_2, 7_3, 7_6, 7_2^2, 7_3^2$, or $3_1 \# 4_1$. Similarly, by replacing v for 7 crossings in each illustration of Figure 12, it follows that the possible nine-crossing products are $9_1, 9_2, 9_3, 9_8, 9_{11}, 9_1^2, 9_{10}^2, 6_1 \# 3_1$, or $4_1 \# 5_2$. We have reduced from 15 choices for 7-noded knots to just 7 and from 110 possibilities for 9-noded knots and catenanes to just 9 possibilities. Thus, Theorem 4 can help to significantly reduce the knot and catenane type of products of site-specific recombination that add one crossing to the substrate.

Application 5: Processive vs Distributive recombination. In some cases, processive recombination does not preclude distributive rounds of recombination, and both occur in a recombination reaction. Our model can be helpful in distinguishing between products of distributive recombination and products of processive recombination.

Example. Suppose that a trefoil knot $C(-2, 1)$, is used as a substrate for a reaction with a serine recombinase and that electron microscopy and gel electrophoresis reveal the figure of eight knot $C(-2, 2)$ as the primary product and $T(2, 2) \# C(-2, 1)$, $T(2, 2) \# C(-2, 2)$ and a three-component catenane as secondary products. It follows from Theorem 2 that recombination proceeds from the trefoil knot to $C(-2, 2)$, product of the first round of processive recombination. The original $C(-2, 1)$ and the product $C(-2, 2)$ are then substrates yielding the composite catenanes $T(2, 2) \# C(-2, 1)$ and $T(2, 2) \# C(-2, 2)$, products of the first round of distributive recombination. The product knots and these composite catenanes are then used as substrates to yield the three-component catenanes, products of the second round of distributive recombination (however, this composite is not one of the substrates that we consider). Overall, this would be akin to the serine recombinase performing multiple rounds of processive and distributive recombination.

6. CONCLUSIONS AND DIRECTIONS FOR FURTHER RESEARCH.

We have developed a model to predict and characterise the topology and chirality of DNA knots and catenanes that can arise as a result of a site-specific recombinase acting on a twist knot substrate. Our model is based on three biological assumptions about site-specific recombination. Our model predicts that all knotted or catenated products of such enzyme actions are in one of the three families of Figure 6, as described in Theorems 1 and 2.

In [45] we have also shown that the total number of knots and catenanes in our product families with $MCN=n$ grows linearly with n^5 , whereas the total number of all knots and catenanes increases exponentially with the MCN [53]. Hence, the calculation n^5/e^n gives the proportion of all knots and catenanes which are putative recombination products and as n increases, n^5/e^n decreases exponentially rapidly to zero. Knowing the MCN of a product and knowing that the product is in one of our families allow us to significantly narrow the possibilities for its knot or catenane type. The model described herein thus provides an important step in characterizing DNA knots and catenanes, which arise as products of site-specific recombination.

We have shown how our model can be helpful in determining the sequences of products of processive recombination on twist knot substrates, and how it can help distinguish between products of processive and distributive recombination. The algorithms presented allow the interested reader to apply our results to a specific site-specific recombination system.

We plan to expand this project in three main ways. First, we are further testing the model with experimental data from our experimental collaborators. Second, we are developing a computer program based on the model presented on this paper and in [45]. This will allow the automatic computation of products of site-specific recombination on any twist knot substrate. Finally, although we have assumed that the productive synapse has only two crossover sites and that any accessory sites are sequestered from the synaptic complex, electron micrographs of recombinase complexes such as those of Gin and Hin [13–15, 41, 52] reveal three three DNA duplexes looping out of the enzyme complex. This suggests that our model could be developed by making biologically reasonable assumptions of a synaptic complex with three crossover sites (see for example [25]) and predicting the putative products that could arise.

7. ACKNOWLEDGMENTS

We wish to thank Erica Flapan, Mauro Mauricio, Julian Gibbons, Kai Ishihara, Ken Baker for insightful discussions, and the referees for their valuable suggestions. DB is supported in part by EPSRC Grants EP/H0313671, EP/G0395851 and EP/J1075308, and thanks the LMS for their Scheme 2 Grant. KV is supported by EP/G0395851.

REFERENCES

- [1] N. D.F. Grindley, K. L. Whiteson, and P. A. Rice, Mechanisms of Site-Specific Recombination, *Annu. Rev. Biochem.* (2006) 75, 567-605.
- [2] N. J. Kilby, M. R. Snaith and J. A. H. Murray, Site-specific recombinases: tools for genome engineering, *Trends in Genetics* (1993) 120, 413-421

- [3] Jia F, Wilson KD, Sun N, Gupta DM, Huang M, Li Z, Panetta NJ, Chen ZY, Robbins RC, Kay MA, Longaker MT, Wu JC., A nonviral minicircle vector for deriving human iPS cells. *Nat Methods.* (2010) 7(3), 197-9.
- [4] Zhao N, Fogg JM, Zechiedrich L, Zu Y., Transfection of shRNA-encoding Minivector DNA of a few hundred base pairs to regulate gene expression in lymphoma cells., *Gene Ther.* (2010), advance online publication.
- [5] R. Feil(2007), Conditional SomaticMutagenesis in the Mouse Using Site-Specific Recombinases, Springer-Verlag Berlin Heidelberg HEP (2007) 178, 3-28.
- [6] R. Dulbecco R and M. Vogt. *Proc. Natl. Acad. Sci.* (1963) 50, 236-243
- [7] R. Weil, J. Vinograd, *Proc. Natl. Acad. Sci.* (1963) 50, 730-738
- [8] J. Yan, M. O. Magnasco, J. F. Marko, A kinetic proofreading mechanism for disentanglement of DNA by topoisomerases. *Nature* (1999), 401, 932-935.
- [9] M. A. Krasnow, A. Stasiak, A. J. Spengler, F. Dean, T. Koller and N. R. Cozzarelli, Determination of the absolute handedness of knots and catenanes of DNA. *Nature* (1983) 304, 559-560.
- [10] S. Trigueros, J. Arsuaga, M. E. Vazquez, D. W. Sumners, and J. Roca, Novel display of knotted DNA molecules by two-dimensional gel electrophoresis. *Nucleic Acids Res.* (2001) 29, E67.
- [11] E. L. Zechiedrich and N. J. Crisona, Coating DNA with RecA protein to distinguish DNA path by electron microscopy. In *Methods in Molecular Biology: DNA Topoisomerase Protocols* (1989)
- [12] W. Fiers and R. L. Sinsheimer *J. Mol. Biol.* (1962) 5, 424-434
- [13] N. J. Crisona, R. Kanaar, T. N. Gonzalez, E. L. Zechiedrich, A. Klippel and N. R. Cozzarelli, Processive recombination by wild-type Gin and an enhancerindependent mutant. Insight into the mechanisms of recombination selectivity and strand exchange. *J. Mol. Biol.* (1994) 243, 437-457.
- [14] K. A. Heichman, I. P. Moskowitz and R. C. Johnson Configuration of DNA strands and mechanism of strand exchange in the Hin invertasome as revealed by analysis of recombinant knots. *Genes Dev.* (1991) 5, 1622-1634.
- [15] R. Kanaar, A. Klippel, E. Shekhtman, J. M. Dungan, R. Kahmann and N. R. Cozzarelli, Processive recombination by the phage Mu Gin system: implications for the mechanisms of DNA strand exchange, DNA site alignment, and enhancer action. *Cell* (1990) 62, 353-366.
- [16] N. J. Crisona, R. L. Weinberg, B. J. Peter, D. W. Sumners, and N. R. Cozzarelli, The topological mechanism of phage lambda integrase. *J. Mol. Biol.* (1999) 289, 747-775.
- [17] S. J. Spengler, A. Stasiak, N. R. Cozzarelli, The stereostructure of knots and catenanes produced by phage λ integrative recombination: Implications for mechanism and DNA structure, *Cell* (1985) 42, 325-334.
- [18] S. D. Colloms, J. Bath, D. J. Sherratt, Topological selectivity in Xer site-specific recombination, *Cell* (1997) 88, 855-864.
- [19] D. W. Sumners, C. Ernst, A. Spengler, N. Cozzarelli, Analysis of the mechanism of DNA recombination using tangles. *Quart. Review Bioph.* (1995) 28, 253-313.
- [20] R. Kanaar, A. Klippel, E. Shekhtman, J. M. Dungan, R. Kahmann, N. R. Cozzarelli, Processive recombination by the phage Mu Gin System: Implications for the mechanisms of the DNA strand Exchange, DNA site alignment and Enhancer action. *Cell* (1990) 62, 353-366.
- [21] C. Ernst and D. W. Sumners, A calculus for rational tangles: applications to DNA recombination. *Math. Proc. Cambridge Philos. Soc.* (1990) 108, 489-515.
- [22] M. Vazquez, D. W. Sumners, Tangle analysis of Gin site-specific recombination, *Math. Proc. Camb. Phil. Soc.* (2004) 136, 565-582
- [23] I. Darcy, Biological distances on DNA knots and links: Applications to Xer recombination, *J. Knot Theory and its Ramifications.*
- [24] M. Vazquez, S. D. Colloms and D. W. Sumners, 3-Tangle Analysis of Xer Recombination Reveals only Three Solutions, all Consistent with a Single Threedimensional Topological Pathway, *J. Mol. Biol.* (2005), 346, 493-504
- [25] H. C. Ibarra and D. A. Lizrraga Navarrob, An algorithm based on 3-braids to solve tangle equations arising in the action of Gin DNA invertase, *Applied Mathematics and Computation* (2010),216, 95-106
- [26] I. K. Darcy, J. Luecke, M. Vazquez, Tangle analysis of difference topology experiments: applications to a Mu protein-DNA complex, *Algebraic and Geometric Topology* (2009), 9, 22472309
- [27] S. Kim, I. K. Darcy, Topological Analysis of DNA-protein Complexes, *Mathematics of DNA Structure, Function, and Interactions* edited by Craig John Benham, Stephen Harvey, Wilma K. Olson, De Witt L. Sumners, and David Swigon, Springer Science + Business Media, LLC, New York, (2009)
- [28] I. K. Darcy, Modeling protein-DNA complexes with tangles, *Comput. Math. Appl.* (2008), 55 , 924937
- [29] A. A. Vetcher, A. Y. Lushnikov, J. Navarra-Madsen, R. G. Scharein, Y. L. Lyubchenko, I. K. Darcy, S. D. Levene, DNA Topology and Geometry in Flp and Cre Recombination, *Journal of Molecular Biology*, (2006), 4, 1089-104.
- [30] I. K. Darcy, D. W. Sumners, Rational Tangle Distances on Knots and Links, *Mathematical Proceedings of the Cambridge Philosophical Society*, 128 (2000), no. 3, 497510.
- [31] Y. Saka, M. Vazquez, TangleSolve: topological analysis of site-specific recombination, *Bioinformatics*, (2002), 18, 1011-1012
- [32] I. K. Darcy, K. Ishihara, R. Medikonduri and K. Shimokawa, Rational tangle surgery and Xer recombination on catenanes, preprint (2009)
- [33] K. Shimokawa, K. Ishihara and M. Vazquez, Tangle analysis of DNA unlinking by the Xer/FtsK system, to appear in Bussei Kenkyu (2009), Proceedings of the International Conference Knots and soft-matter physics: topology of polymers and related topics in physics, mathematics and biology.
- [34] C. Ernst, Tangle equations, *Journal of Knot Theory and Its Ramifications* (JKTR), (1996), 5, 145-159
- [35] C. Ernst, Tangle equations II, *Journal of Knot Theory and Its Ramifications* (JKTR), (1996), 6, 1-11
- [36] I. K. Darcy and R. G. Scharein, TopoCE-R: 3D visualization modeling the topology of DNA recombination, *Bioinformatics, Applications Note*, (2006), 22, 1790-1791.
- [37] D. Buck and C. Verjovsky Marcotte, Tangle solutions for a family of DNA-rearranging proteins, *Math. Proc. Camb. Phil. Soc.* (2005), 139, 59
- [38] D. Buck and C. Verjovsky Marcotte, Classification of tangle solutions for integrases, a protein family that

- changes DNA topology, *J Knot Theory Ramifications*, (2007) 16.
- [39] D. Buck and M.M.Mauricio, Tangle solutions for composite knots: applications to Hin recombination arXiv:1007.0948v1.
- [40] I. Grainge, D. Buck and M. Jayaram. Geometry of site alignment during Int family recombination: Antiparallel synapsis by the Flp recombinase. *Journal of Molecular Biology* (5) 298 (2000), 749-764.
- [41] S. K. Merickel and R. C. Johnson, Topological analysis of Hin-catalysed DNA recombination in vivo and in vitro. *Mol. Microbiol.* (2004) 51, 1143-1154.
- [42] S. A. Wasserman, J. M. Dungan and N. R. Cozzarelli, Discovery of a predicted DNA knot substantiates a model for site-specific recombination. *Science* (1985) 229, 171-174.
- [43] D. Buck and E. Flapan, Predicting Knot or Catenane Type of Site-Specific Recombination Products, *J. Mol. Biol.* (2007) 374, 1186-1199.
- [44] D. Buck and E. Flapan, A topological characterization of knots and links arising from site-specific recombination, *J. Phys. A: Math. Theor.* (2007) 40, 12377-12395.
- [45] K. Valencia and D. Buck, Characterization of Knots and Links Arising From Site-specific Recombination on Twist Knots, 2011 *J. Phys. A: Math. Theor.* 44, 045002.
- [46] R. C. Johnson and M. F. Bruist, Intermediates in Hin-mediated DNA inversion: a role for Fis and the recombinational enhancer in the strand exchange reaction, *The EMBO Journal*, (1989), 8, 1581-1590
- [47] D. Rolfsen, *Knots and Links*, AMS, (2003).
- [48] P. Cromwell, *Knots and Links*, Cambridge University Press, (2005).
- [49] A. Kawachi, *A survey of Knot Theory*, Birkhauser, (1996).
- [50] Cox, DNA inversion in the $2\mu\text{m}$ plasmid of *Saccaromyces cervisiae* In *Mobile DNA* pp. 661-670, American Society for microbiology, Washington, DC. (1989)
- [51] J. Bath, D. J. Sherratt and S. D. Colloms, Topology of Xer recombination on catenanes produced by λ integrase. *J. Mol. Biol.* (1999) 289, 873-883.
- [52] S. Pathania, M. Jayaram, R. M. Harshey, Path of DNA within the Mu transpososome: Transposase interactions bridging two Mu ends and the enhancer trap five DNA supercoils, *Cell* (2002) 109, 425-436.
- [53] C. Ernst, D. W. Sumners, The growth of the number of prime knots, *Math. Proc. Camb. Phil. Soc.* (1987), 102, 303.

FIGURES

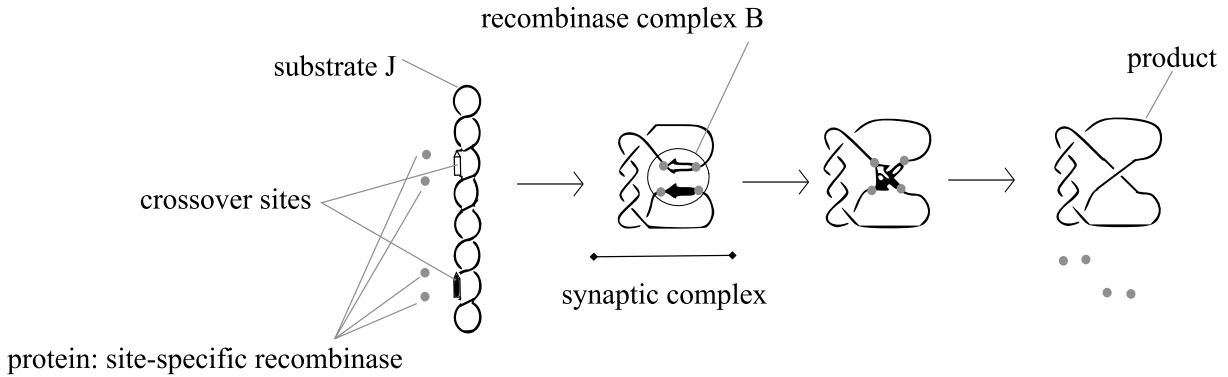

FIGURE 1. Illustration of a small site-specific recombination reaction. The black line represents the central axis of the DNA molecule. *Left*: Four dimer site-specific recombinases. The substrate molecule: an unknotted, duplex covalently closed-circular and plectonemically supercoiled DNA molecule with the crossover sites (empty and filled arrows). *Left middle*: Juxtaposition of the crossover sites, creating the synaptic complex. *Right middle*: Recombination of the crossover sites. *Right*: Knotted product molecule and detached proteins.

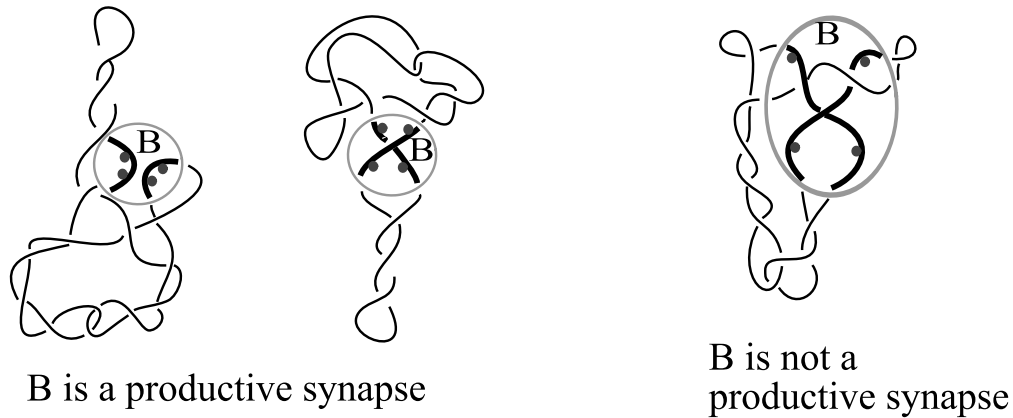

FIGURE 2. Productive synapse. We assume that the synaptic complex is a productive synapse. B (light grey circle) denotes the smallest region containing the four bound recombinase molecules (small grey discs) and the two crossover sites (highlighted in black). *Left and middle*: The synaptic complex is a productive synapse. *Right*: The synaptic complex is not a productive synapse. In this case we cannot draw B such that only the two crossover sites are inside it without also including the third (horizontal, non-highlighted) strand.

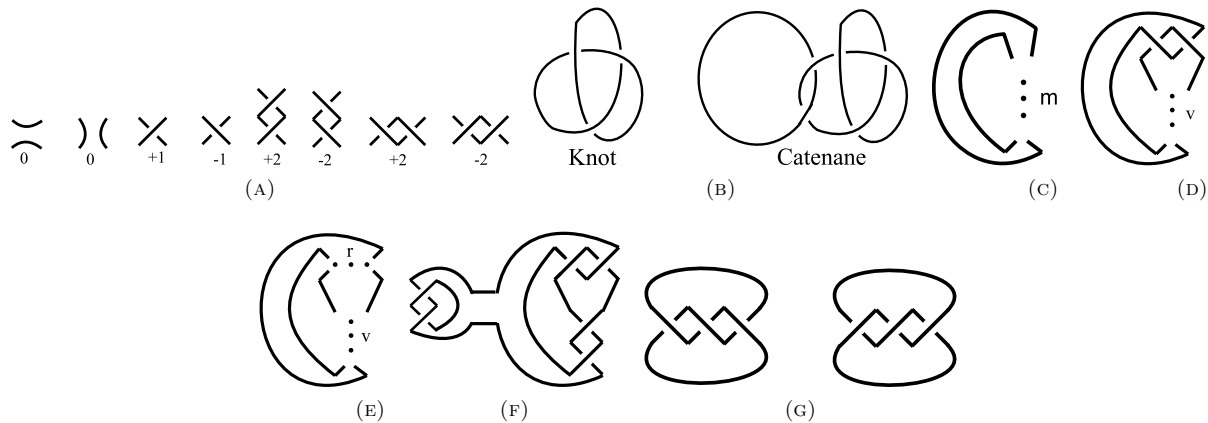

FIGURE 3. Background terminology. (A) Crossing sign convention used in this paper: 0 horizontal and vertical; +1, -1; +2 and -2 vertical; +2 and -2 horizontal, also called hooked junctions. (B) A example of a knot and a catenane. (C) Generalised structures of torus knots (m is odd) and catenanes (m even) denoted $T(2, m)$. (D) The substrate we consider, the twist knot $C(2, v)$. (E) A clasp knot $C(r, s)$. (F) An example of a composite catenane. This particular example, denoted $T(2, 2) \sharp C(-2, 2)$ consists of the catenane $T(2, 2) = 2_1^2$ and the twist knot $C(-2, 2) = 4_1$. (G) The (+)trefoil and (-)trefoil, respectively from left to right.

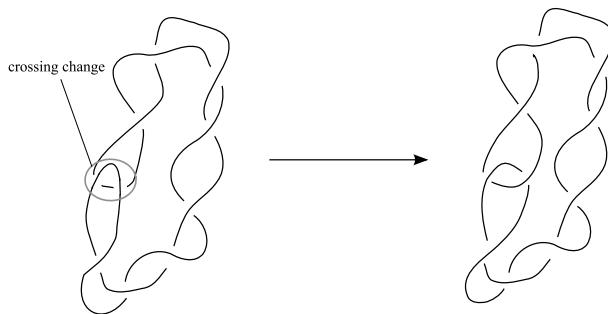

FIGURE 4. Twist knots are ubiquitous DNA knots. DNA *in vivo* and *in vitro* is plectonemically supercoiled so an unknot can be transformed to a twist knot by a single crossing change.

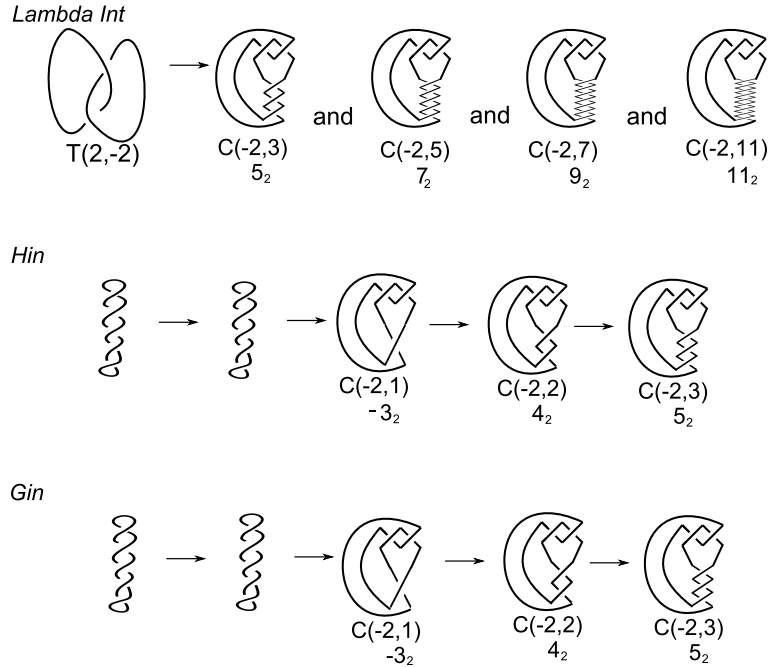

FIGURE 5. Site-specific recombination mediated by both serine recombinases and tyrosine recombinases often yields twist knot products.

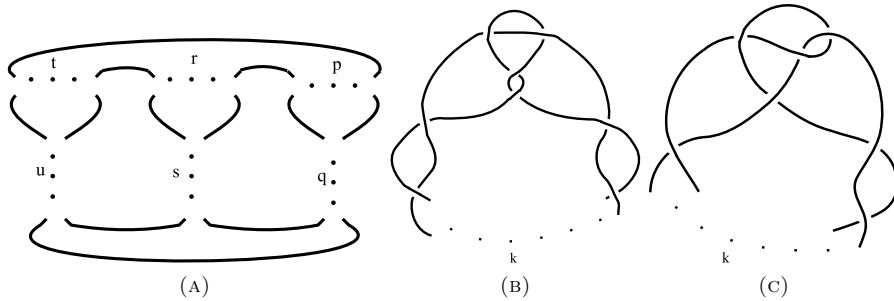

FIGURE 6. The family of knots and catenanes $F(p, q, r, s, t, u)$, $G_1(k)$ and $G_2(k)$ (from left to right respectively). Given the three assumptions in Section 3, we predict that all product knots and catenanes of (non-distributive) site-specific recombination on twist knots with a tyrosine recombinase or a serine recombinase fall within these three families of knots and catenanes. In 6a, the letters p, q, r, s, t and u denote the number of crossings in that particular row of crossings. In 6b and 6c, k describes the number of crossings between the two DNA duplexes. Note that depending on the value of k , a member of $G_1(k)$ or $G_2(k)$ is either a knot or catenane.

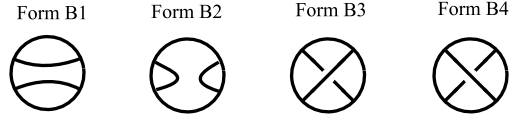

FIGURE 7. Assumption 1: Projections of the pre-recombinant B . Assumption 1 states that there is a projection of the pre-recombinant recombinase complex with at most one crossing.

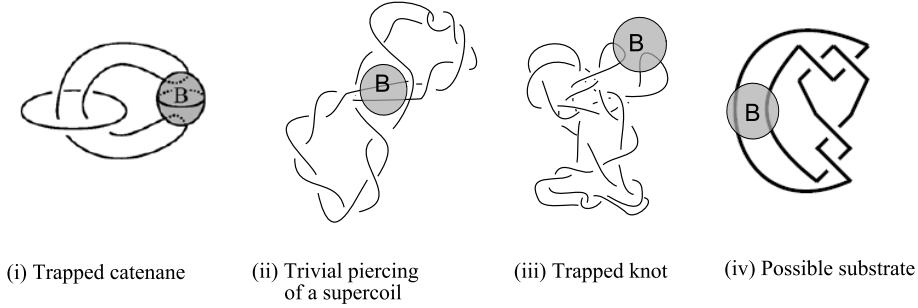

FIGURE 8. Different scenarios for Assumption 2. (i) A catenane is trapped in the DNA branches outside of B . (ii) The productive synapse pierces a supercoil in a non-trivial way. (iii) A knot is trapped in the DNA branches outside of B . (iv) An unknotted substrate with the synaptic complex already formed. Scenarios (i) and (iii) are not allowed by the assumption, (ii) and (iv) are.

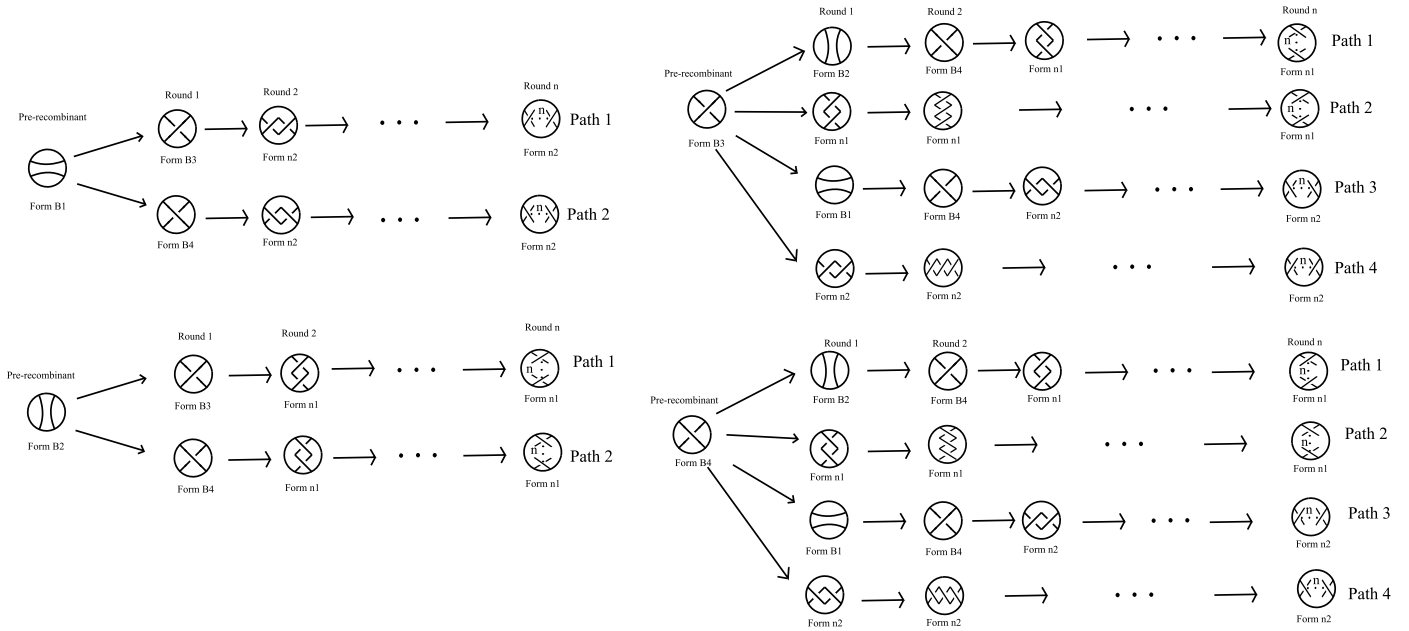

FIGURE 9. Assumption 3 for Serine recombinases. Starting with a projection of pre-recombinant B with zero or one crossings, we illustrate projections of the post-recombinant conformations of B at each round of processive recombination. Processive recombination can result in a row of n vertical crossings, which we denote by $n1$ or in a row of n horizontal crossings which we denote $n2$.

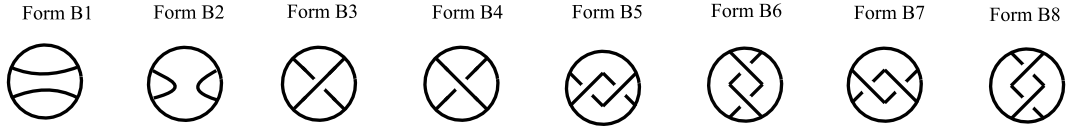

FIGURE 10. Assumption 3 for Tyrosine recombinases. All possible projections of B after recombination mediated by a tyrosine recombinase.

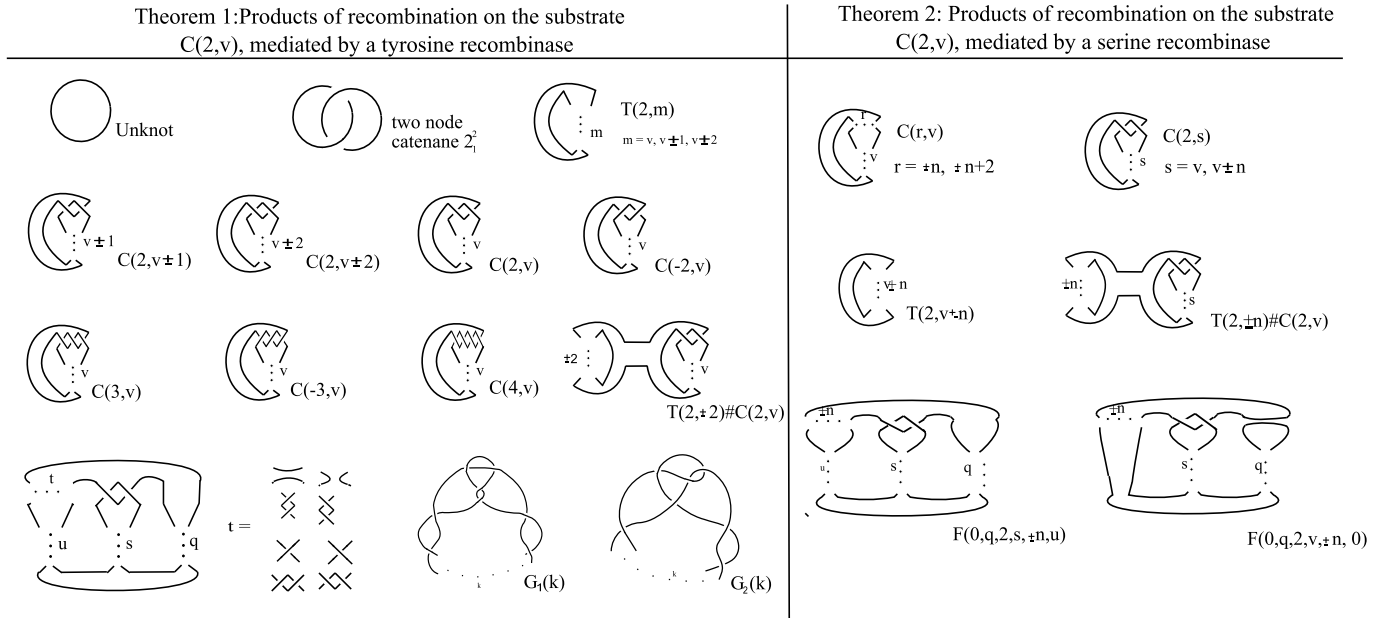

FIGURE 11. *Left:* Summary of Theorem 1. These are all the possible products of a reaction mediated by a tyrosine recombinase on a twist knot substrate $C(2,v)$, predicted by the model. *Right:* Summary of Theorem 2. Similarly, these are all the possible products of a reaction mediated by a serine recombinase on a twist knot substrate $C(2,v)$, predicted by the model. For all, $q + s = v$. These products are listed in the same order as in the Theorems (left to right, top to bottom).

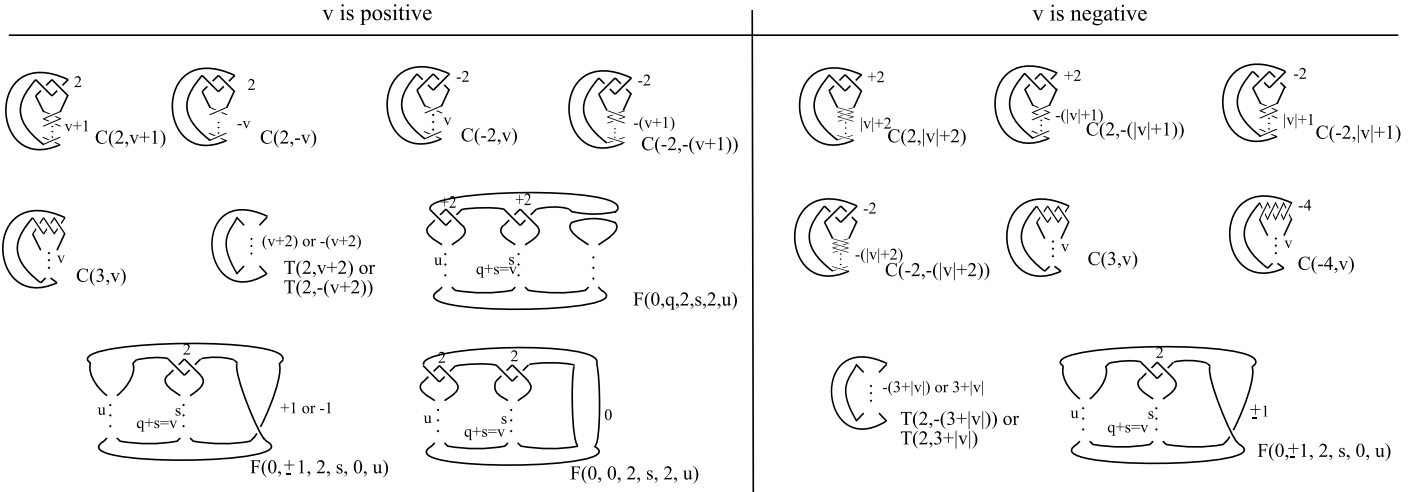

FIGURE 12. Summary of Theorem 4. Products of a recombination reaction with a twist knot substrate that have MCN one more than that of the substrate. If the substrate is a twist knot $C(2, v)$ with $MCN(C(2, v)) = m$ and the product has MCN equal to $m + 1$ then the knots and catenanes illustrated here are the only possible such products. Depending on whether v is positive or negative (see illustration 3 for the convention on crossings) then we obtain different possible products. For all, $q + s = v$. These products are listed in the same order as in the Theorems (left to right, top to bottom).

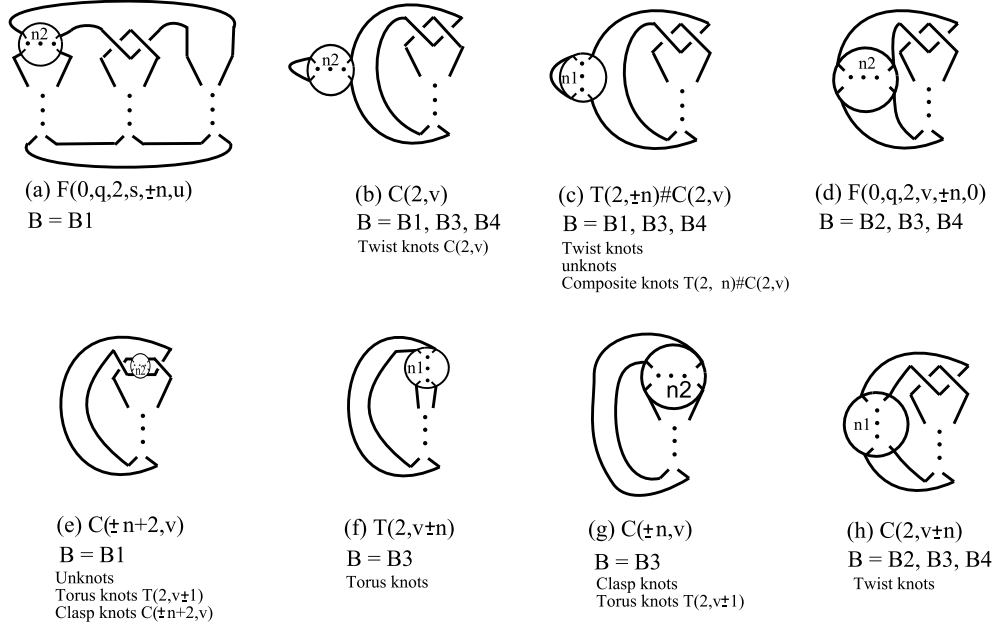

FIGURE 13. Summary of Theorem 2: After n rounds of processive recombination with a serine recombinase on a twist knot substrate, the product DNA molecule must have one of the forms illustrated here. The images inside the circles denote B after n rounds of processive recombination. There are two possible conformations, a horizontal row of n crossings, $n1$ and a vertical row of n crossings, $n2$. Under each conformation we list some of the possible products that can arise from that particular conformation after n rounds of processive recombination.