

Morphogenesis by coupled regulatory networks: Reliable control of positional information and proportion regulation

Thimo Rohlf^{a,b}, Stefan Bornholdt^c

^a*Epigenomics Project, Genopole, Tour Evry 2, 523 Terrasses de l'Agora, F-91034 Evry cedex, France*

^b*Max-Planck-Institute for Mathematics in the Sciences, Inselstrasse 22, D-04103 Leipzig, Germany*

^c*Institute for Theoretical Physics, University of Bremen, Otto-Hahn-Allee, D-28334 Bremen, Germany*

Abstract

Based on a non-equilibrium mechanism for spatial pattern formation we study how position information can be controlled by locally coupled discrete dynamical networks, similar to gene regulation networks of cells in a developing multicellular organism. As an example we study the developmental problems of domain formation and proportion regulation in the presence of noise, as well as in the presence of cell flow. We find that networks that solve this task exhibit a hierarchical structure of information processing and are of similar complexity as developmental circuits of living cells. Proportion regulation is scalable with system size and leads to sharp, precisely localized boundaries of gene expression domains, even for large numbers of cells. A detailed analysis of noise-induced dynamics, using a mean-field approximation, shows that noise in gene expression states stabilizes (rather than disrupts) the spatial pattern in the presence of cell movements, both for stationary as well as growing systems. Finally, we discuss how this mechanism could be realized in the highly dynamic environment of growing tissues in multi-cellular organisms.

Key words: Morphogenesis; Pattern formation; Gene regulatory networks; Positional information; Proportion regulation

1. Introduction

Understanding the molecular machinery that regulates development of multicellular organisms is among the most fascinating problems of modern science. Today, a growing experimental record about the regulatory mechanisms involved in development is accumulating, in particular in well-studied model-organisms as, e.g., *Drosophila* or *Hydra* (Technau et al., 2000; Bosch, 2003). Still, the genomic details known today are not sufficient to derive dynamical models of developmental gene regulation processes in full detail. Phenomenological models

of developmental processes, on the other hand, are well established today. Pioneering work in this field was done by Turing, who in his seminal paper in 1952 (Turing, 1952) considered a purely physico-chemical origin of biological pattern formation. His theory is based on an instability in a system of coupled reaction-diffusion equations. In this type of model, for certain parameter choices, stochastic fluctuations in the initial conditions can lead to self-organization and maintenance of spatial patterns, e.g. concentration gradients or periodic patterns. This principle has been successfully applied to biological morphogenesis in numerous applications (Gierer and Meinhardt, 1972; Meinhardt and Gierer, 2000). However, as experiments make us wonder about the astonishingly high complexity of single regulating genes in development (Bosch and Khalturin, 2002), they also seem to suggest that diffusion models will not be able to capture all details of developmental regulation, and point at a complex network of regulating interactions instead.

In theoretical work on pattern formation, both the crucial role of local, induction-like phenomena in development (Slack, 1993) and limitations of diffusion based mechanisms in cellular environments (Reilly and Melton, 1996) have lead to consideration of models that rely on local signal transfer via membrane-bound receptors. A well-studied model in this context is *juxtacrine signaling* (Wearing et al., 2000; Owen et al., 2000). Positive feed-back, combined with juxtacrine signaling, can lead to generation of spatial patterns with wavelengths that extend over many cell lengths (Owen et al., 2000). Further, it has been shown that a relay mechanism based on juxtacrine signaling can also lead to travelling wave fronts, and hence provide an alternative mechanism of long-range pattern regulation (Monk, 1998). The emergence of *sharp spatial expression boundaries* of many genes in development, besides other genes that exhibit more graded profiles, is notoriously hard to explain in reaction-diffusion-based models. Recently it was shown in models of homeoprotein intercellular transfer (Kasatkin et al., 2007; Holcman et al., 2007) that restricted local diffusion of a morphogen regulating its own expression can generate a morphogenetic gradient. When two of these gradients meet, for certain parameter values a sharp boundary is created (Kasatkin et al., 2007).

The role of information processing in gene regulatory networks during development has entered the focus of theoretical research only recently. One pioneering study was published by Jackson et al. (1986), who investigated the dynamics of spatial pattern formation in a system of locally coupled, identical dynamical networks. In this model, gene regulatory dynamics is approximated by Boolean networks with a subset of nodes communicating not only with nodes in the (intracellular) network, but also with some nodes in the neighboring cells. Boolean networks are minimal models of information processing in network structures and have been discussed as models of gene regulation since the end of the 1960s (Kauffman, 1969, 1993; Glass, 1973). The model of Jackson et al. demonstrated the enormous pattern forming potential of local information processing. More elaborate models that include a Boolean network description of cell-internal gene regulatory networks, local inductive inter-cellular signals and a discrete model of cell adhesion (Hogeweg, 2000) point at a complex interplay between

regulatory dynamics, cell differentiation and morphogenesis.

Along similar lines, Salazar-Ciudad et al. introduced a gene network model based on continuous dynamics (Salazar-Ciudad et al., 2000; Sole et al., 2002) and coupling their networks by direct contact induction. Interestingly, they observe a larger variety of spatial patterns than Turing-type models with diffusive morphogens, and find that patterns are less sensitive to initial conditions, with more time-independent (stationary) patterns. This matches well the intuition that networks of regulators have the potential for more general dynamical mechanisms than diffusion driven models. Furthermore, dynamical models of regulatory networks that control basic stages in development, e.g. the segment polarity network in *Drosophila* embryos (von Dassow et al., 2000), have shown that developmental modules are extremely robust against large parameter variations; Albert and Othmer (2003) even showed that the topology of regulatory interactions alone in a Boolean network model is sufficient to correctly predict both wild type and mutant patterns generated by the segment polarity network. Considering the temporal succession of regulatory dynamics rather than spatial patterns, similar results were obtained for other gene regulatory networks important for cell development, e.g. the cell cycle network of different yeast species (Li et al., 2004; Davidich and Bornholdt, 2007). The fact that, in many instances, simple discrete dynamical network models are sufficient to capture essential properties of developmental dynamics, suggests that information-transfer-based processes controlled by the topology of regulatory interactions both within and between cells are very important for the extreme robustness and reliability observed in development despite considerable noise and large rearrangements of cell ensembles due to cell proliferation and -movements. In this paper, we follow this new paradigm of interacting networks in pattern formation and in particular consider information-transfer-based processes.

We start with a particular problem of position-dependent gene activation, as motivated from similar observations in *Hydra*. This animal is one of the most basal metazoa and exhibits extremely precise regulation of expression boundaries under continuous cell movements. Also, it has remarkable properties to regenerate *de novo* after dissociation of cells, and to regulate its body proportions during growth. We introduce a novel, two-level theoretical approach to model pattern formation problems of this type: First, a coarse-grained description in a deterministic cellular automata model is developed, which then is extended to a detailed model based on locally coupled, discrete dynamical networks. We show that this deterministic model explains both de-novo pattern formation after randomization of the pattern, and proportion regulation of gene activity domains. A threshold network model is derived which yields an upper estimate of the complexity of the regulatory module needed to solve the pattern formation task. Next, model dynamics is studied under noise and cell movements, and solved analytically in a mean-field approximation. It is shown that local, stochastic changes in gene expression states do not disrupt the spatial pattern, but contribute to its stabilization in the presence of cell flow by production of traveling domain boundaries ("quasi-particles") that coordinate global positional information, bearing some similarity to traveling waves found

in models based on juxtacrine signaling (Monk, 1998). This suggests an interesting, new mechanism for reliable morphogenetic control, that might well apply to different types of tissues with high demands on regeneration. It is shown that the mechanism also works in growing tissues, explains pattern restoration after cutting the tissue in half, and is robust against noise in the detection of the body axis direction. Last, potential applications of the model are discussed.

2. Motivation and model

Let us first introduce and define the morphogenetic problem that we will use as a motivation for our novel pattern formation model.

2.1. Proportion regulation in *Hydra*

A classical model organism for studies of position dependent gene activation is the fresh water polyp *Hydra*, which has three distinct body regions - a head with mouth and tentacles, a body column and a foot region. The positions of these regions are accurately regulated along the body axis (Fig. 1).

Hydra also has the capacity to reproduce asexually by exporting surplus cells into *buds*; again, the position along the body axis where budding occurs is precisely regulated at about two-thirds of the distance from the head to the foot (Schiliro et al., 1999). A number of genes are involved in regulation of the foot region and the budding zone; for example, both *Pedibin* and *CN-NK2* are only expressed in the foot region and turned off approximately in the budding region (Thomsen et al., 2004). While the *CN-NK2* expression domain exhibits a rather graded decay in the budding region (Grens et al., 1996), it has been observed that, for example, *Hedgehog (Hh)* is turned off *precisely* just below the budding region with a sharp boundary (Kaloulis, 2000). The relative position of the budding region and of the gene expression domains below it is almost independent of the animal's size, i.e. the ratio $\alpha/(1 - \alpha)$ (as denoted in Fig. 1) is almost invariant under changes of body size. As the *Pedibin/CN-NK2* system presumably plays an important role in determining the foot region, this invariance appears to be an essential prerequisite for maintaining the correct body proportions (proportion regulation) and to establish the head-foot polarity. Very precise regulation over a 10-fold size range has also been reported for the head-body proportion in *Hydra*, with a value close to 1/3 (Bode and Bode, 1980). Such precise regulation of position information and body proportions is a quite general problem in biological development (Wolpert, 1969).

An interesting problem is how the specific properties of this regulation can be achieved by a small network of regulatory genes and if so, whether local communication between the cells (networks) is sufficient. This basic question is the central motivation for the present study. In particular, we consider the simplified problem of regulating one domain as, for example, the foot region versus the rest of the body. We consider this as a one dimensional problem as first approximation to the well-defined head-foot-axis in *Hydra*. We should note, however, that we do not intend to model in detail the regulatory mechanisms

underlying *Hydra* pattern formation, and rather take the observations made for this basic metazoan as an inspiration to introduce and study a simple, generic model of pattern formation.

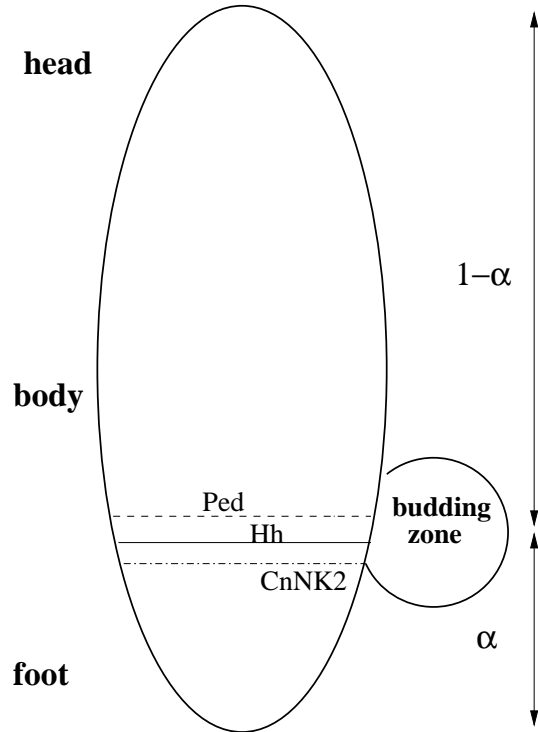

Figure 1: Gene expression domains in *Hydra*, here for the example of the “foot” genes Pedibin (Ped) and Cn-NK2, and Hedgehog (Hh). Ped and Hh expression are bounded towards the body region of the animal; while Ped exhibits a graded decay in the budding region, Hh exhibits a sharp boundary. The relative position of the budding region and the associated expression boundaries, given by the ratio $\alpha/(1 - \alpha)$, is independent of the absolute size of the animal (proportion regulation). Details are explained in the text.

Developmental processes exhibit an astonishing robustness. This often includes the ability of de novo pattern formation, e.g., to regenerate a *Hydra* even after complete dissociation of the cell ensemble in a centrifuge (Gierer et al., 1972). Further, they are robust in the face of a steady cell flux: *Hydra* cells constantly move from the central body region along the body axis towards the top and bottom, where they differentiate into the respective cell types according to their position on the head-foot axis. The global pattern of gene activity is maintained in this dynamic environment. Let us take these observations as a starting point for a detailed study how the interplay of noise-induced regulatory dynamics and cell flow may stabilize a developmental system.

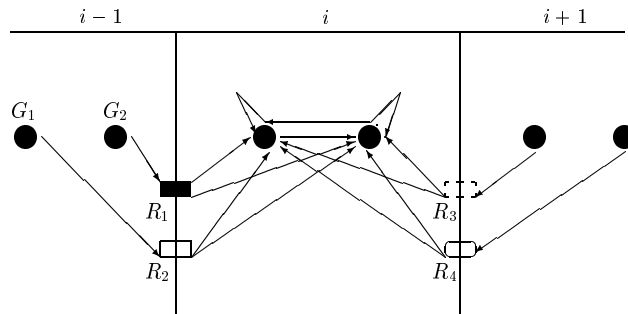

Figure 2: Diagram showing the interaction structure of the minimal network needed to solve the asymmetric expression task. For the sake of clarity, intracellular interactions between the two genes G_1 and G_2 are shown only for cell i , and likewise outgoing intercellular signals from the two genes two the neighbor cells $i - 1$ and $i + 1$ were left out. The transcription factors produced by gene G_1 and G_2 in cell $i - 1$ couple to the receptor systems R_1 and R_2 , respectively, whereas in cell $i + 1$ the transcription factors produced by these genes couple to the receptor systems R_3 and R_4 (biased signaling). In cell i , the receptors release factors which regulate the activity of G_1 and G_2 .

2.2. One dimensional cellular automata: Definitions

We here undertake a three-step approach to find a genetic network model that solves the pattern formation problem outlined above. In the first step, we summarize the properties of the cellular automata model introduced in (Rohlf and Bornholdt, 2005). Cellular automata as dynamical systems discrete in time and state space are known to display a wide variety of complex patterns (Wolfram, 1983, 1984a,b) and are capable of solving complex computational tasks, including universal computation. We searched for solutions (i.e. rule tables which solve the problem) by aid of a genetic algorithm (for details, see Appendix). Candidate solutions have to fulfill four demands: Their update dynamics has to generate a spatial pattern which 1) obeys a predefined scaling ratio $\alpha/(1 - \alpha)$, 2) is independent of the initial condition chosen at random, 3) is independent of the system size (i.e. the number of cells N_C) and 4) is stationary (a fixed point). In the second step, this cellular automata rule table is translated into (spatially coupled) Boolean networks, using binary coding of the cellular automata states. The logical structure of the obtained network is reduced to a minimal form, and then, in step three, translated into a threshold network.

To define a model system that performs the pattern formation task of domain self-organization (Rohlf and Bornholdt, 2005), consider a one-dimensional cellular automaton with parallel update (Wolfram, 1984a). N_C cells are arranged on a one-dimensional lattice, and each cell is labeled uniquely with an index $i \in \{0, 1, \dots, N_C - 1\}$. Each cell can take n possible states $\sigma_i \in \{0, 1, \dots, n\}$. The state $\sigma_i(t)$ of cell i is a function of its own state $\sigma_i(t - 1)$ and of its neighbor's

states $\sigma_{i-1}(t-1)$ and $\sigma_{i+1}(t-1)$ at time $t-1$, i.e.

$$\sigma_i(t) = f[\sigma_{i-1}(t-1), \sigma_i(t-1), \sigma_{i+1}(t-1)] \quad (1)$$

with $f : \{0, 1, \dots, n\}^3 \mapsto \{0, 1, \dots, n\}$ (a cellular automaton with *neighborhood 3*). At the system boundaries, we set $\sigma_{-1} = \sigma_{N_C} = \text{const.} = 0$. Other choices, e.g. asymmetric boundaries with cell update depending only on the inner neighbor cell, lead to similar results. The state evolution of course strongly depends on the choice of f : for a three-state cellular automaton ($n = 3$), there are $3^{27} \approx 7.626 \cdot 10^{12}$ possible update rules, each of which has a unique set of dynamical attractors. As we will show in the results section, $n = 3$ is the minimal number of states necessary to solve the pattern formation problem formulated above.

Now we can formulate the problem we intend to solve as follows: Find a set \mathcal{F} of functions (update rules) which, given an initial vector $\vec{\sigma} = (\sigma_0, \dots, \sigma_{N_C-1})$ sampled randomly from the set of all possible state vectors, within T update steps evolves the system's dynamics to a fixed point attractor with the property:

$$\vec{\sigma}^* := \begin{cases} \sigma_i = 2 & \text{if } i < [\alpha \cdot N_C] \\ \sigma_i \neq 2 & \text{if } i \geq [\alpha \cdot N_C] \end{cases} \quad (2)$$

where $[x]$ yields the largest integer value smaller or equal to the argument x (this is needed since the product $\alpha \cdot N_C$ may lead to non-integer values). The scaling parameter α may take any value $0 < \alpha < 1$. For simplicity, it is fixed here to $\alpha = 0.3$. Notice that α does not depend on N_C , i.e. we are looking for a set of solutions where the ratio of the domain sizes $r := \alpha/(1-\alpha)$ is *constant under changes of the system size*, as motivated in section 2.1 by similar observations of *proportion regulation* in developing multi-cellular organisms. This clearly is a non-trivial task when only local information transfer is allowed. The ratio r is a *global property* of the system, which has to emerge from purely local (next neighbor) interactions between the cell's states.

2.3. Pattern formation by locally coupled Boolean networks

One can now take a step further towards biological systems, by transferring the dynamics we found for a cellular automata chain onto cells in a line that communicate with each other, similar to biological cells. Identifying different dynamical states with (differentiated) cell types (Kauffman, 1969) and assuming that all model cells have an identical network of regulators inside, each of them capable to reproduce the rules of a cellular automaton by means of a dynamical coupling between subsets of regulators in direct neighbor cells, we obtain a model mimicking basic properties of a biological genetic network in development.

Cellular automata rule tables can easily be formalized as logical (Boolean) update tables, e.g., for $n = 3$, two internal nodes with states $\sigma_1^i, \sigma_2^i \in \{0, 1\}$ can be used for binary coding of the cell states (where i labels the cell position). One then has

$$(\sigma_{1,2}^i(t), \sigma_2^i(t)) = f_{1,2} \sigma_{1,2}^{i-1}(t-1), \sigma_{1,2}^i(t-1), \sigma_{1,2}^{i+1}(t-1) \quad (3)$$

with $f_{1,2} : \{0, 1\}^6 \mapsto \{0, 1\}^2$. The so obtained rule tables are, by application of Boolean logic, transformed into a minimized *conjunctive normal form*, which only makes use of the three logical operators NOT, AND and OR with a minimal number of AND operations. This is a rather realistic approximation for gene regulatory networks, as the AND operation is more difficult to realize on the basis of interactions between transcription factors. Other logical functions as, e.g., XOR, are even harder to realize biochemically (Davidson, 2001). However, we should notice again that it is not our intention to develop a specific or detailed biochemical model for the proposed pattern formation problem, but rather to find the simplest possible network model that reproduces the basic phenomenology. Nonetheless, a model of this type may well serve as a starting point for subsequent, more sophisticated models. The basic structure of the constructed network and a possible biological interpretation is shown in Fig. 2. Concordant with the spirit we followed so far, we assume that symmetry of signal transmission is broken on a *local-cell scale*, without specifying this in detail; several self-organizing mechanisms are conceivable in cellular systems, e.g., local chemical gradients (Gurdon and Bourillot, 2001) or anisotropic distribution of receptors on cell membranes (Galle et al., 2002). In Fig. 2, for the sake of simplicity, the specific example of a biased distribution of signal-transmitting receptors was chosen.

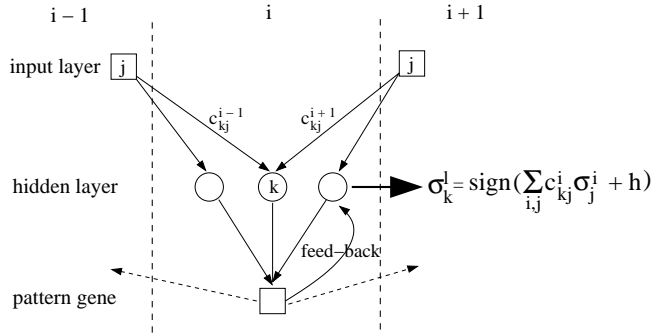

Figure 3: Schematic sketch of a threshold network controlling spatial gene activity patterns. Signals from genes in direct neighbor cells constitute the *input layer* of the network. In the *hidden layer*, this information is processed, with logical functions implemented as weighted sums of the inputs. The output of the genes in this layer then controls the *pattern genes*. Notice that there is feed-back to the hidden layer, as well as to the neighbor cells (dashed arrows).

2.4. The simplest dynamics: locally coupled threshold networks

Perhaps the simplest dynamical model for transcriptional regulation networks are threshold networks, a subset of Boolean networks, where logical functions are modeled by weighted sums of the nodes' input states plus a

threshold h (Kürten, 1988). They have proven to be valuable tools to address questions associated to the dynamics and evolution of gene regulatory networks (Wagner, 1994; Bornholdt and Sneppen, 2000; Bornholdt and Rohlf, 2000; Rohlf and Bornholdt, 2002, 2004a).

Any Boolean network can be coded as a dynamical threshold network with suitable thresholds assigned to each network node. For the system of coupled networks discussed in this paper, this network contains minimally three hierarchies of information processing (“input layer”: signals from the genes in the neighbor cells at time $t - 1$, “hidden layer”: logical processing of these signals, “output layer”: states of the two “pattern genes” σ_1^i and σ_2^i in cell i at time t (see Fig. 3 for a schematic sketch of the system structure)¹. The genes’ states now may take values $\sigma_i = \pm 1$, and likewise for the interaction weights one has $c_{ij}^l = \pm 1$ for activating and inhibiting regulation, respectively, and $c_{ij}^l = 0$ if gene i does not receive an input from gene j in cell l . The dynamics then is defined as

$$\sigma_j^i(t) = \text{sign}(f_j(t-1)) \quad (4)$$

with

$$f_j(t) = \sum_{k=1}^2 \sum_{l=i-1}^{i+1} c_{kj}^l \sigma_k^l + h_j \quad (5)$$

for the “hidden” genes (compare Fig. 3), where σ_k^l , $k \in \{1, 2\}$ is the state of the k th pattern gene in cell l (there are no couplings between the genes in the “hidden” layer). The threshold h_j is given by

$$h_j = \sum_{k=1}^2 \sum_{l=i-1}^{i+1} |c_{kj}^l| - 2, \quad (6)$$

which implements a logical OR operation. For the “output” (pattern) genes G_1 and G_2 in cell i , one simply has

$$f_k(t) = \sum_{l=1}^{k_{in}^k} \sigma_l - k_{in}^k, \quad (7)$$

i.e. the weights are all set to one, and the (negative) threshold equals the number of inputs k_{in}^k that gene G_k , $k \in \{1, 2\}$ receives from the hidden layer genes (logical AND).

3. Results for deterministic dynamics

Let us briefly summarize the dynamics of the simple stochastic cellular automata model of spatial pattern formation based on local information transfer

¹Notice that this structure is quite similar to a feed-forward neural network, however, in our system there is regulatory feed-back from the output-layer to the ‘hidden’ layer.

(Rohlf and Bornholdt, 2005), and its de novo pattern formation by generating and regulating a domain boundary. Subsequently, we will discuss in detail how this very general mechanism can emerge as a result of interacting nodes in coupled identical networks, as a model for gene regulation networks in interacting cells.

3.1. Cellular Automata Model

The first major outcome of the cellular automata model is that a number of $n = 3$ different states is necessary and sufficient for this class of systems to solve the given pattern formation task ². The update table of the fittest solution found during optimization runs, which solves the problem independent of system size for about 98 percent of (randomly chosen) initial conditions (i.e. has fitness $\Phi = 0.98$), is shown in Table I.

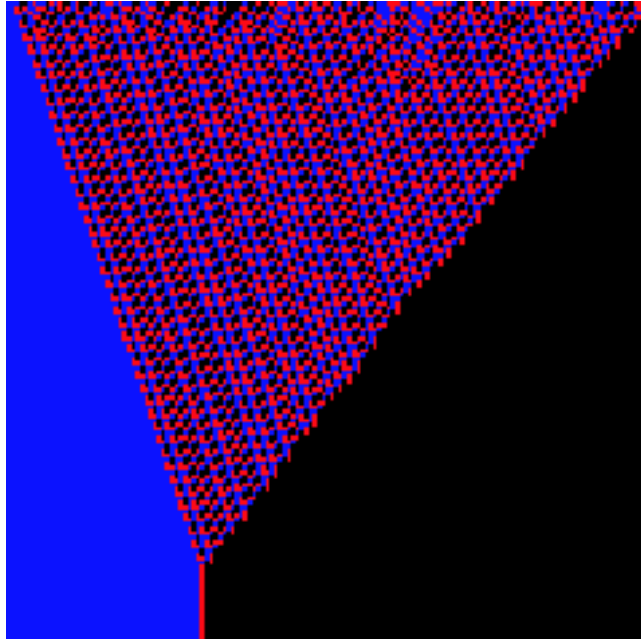

Figure 4: A typical dynamical run for the automata as defined in Table I, here for a system of size $N_C = 250$ cells (deterministic dynamics, no noise), starting from a random initial configuration. Time is running on the y -axis from top to bottom. Cells with state $\sigma_i = 0$ are depicted in black color, cells with $\sigma_i = 1$ in red and cells with $\sigma_i = 2$ in blue.

²The case $n = 2$ corresponds to the class of elementary (Wolfram) cellular automata with a very restricted set of 256 possible update rules. In our extensive genetic algorithm runs, no solution for the here considered problem was found for $n = 2$, even under diverse variations of the boundary conditions

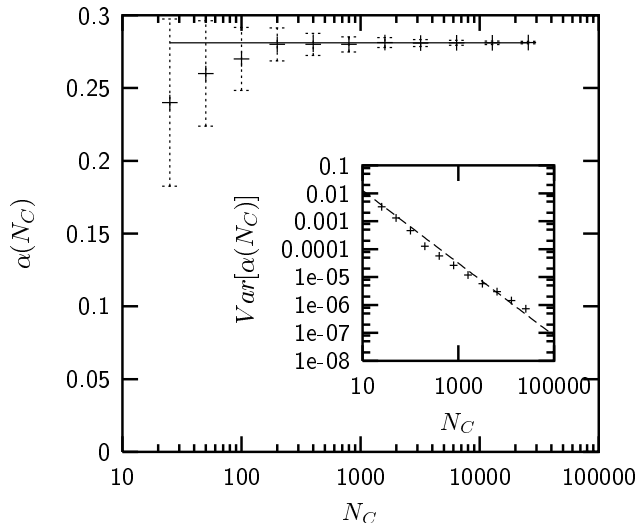

Figure 5: Finite size scaling of the self-organized relative domain size α as a function of the total number of cells N_C . In the limit of large system sizes, α converges towards a fixed value $\alpha_\infty = 0.281 \pm 0.001$ (as denoted by the straight line fit). The inset shows the finite size scaling of the variance $Var[\alpha(N_C)]$; the straight line in this log-log plot has slope -1.3 and indicates that fluctuations vanish with a power of the system size.

Fig. 4 shows the typical update dynamics of this solution. The finite size scaling of the self-organized relative domain size α as a function of the number of cells N_C is shown in Fig. 5. In the limit of large system sizes, α converges towards

$$\alpha_\infty = 0.281 \pm 0.001. \quad (8)$$

The variance of α vanishes with a power of N_C , i.e. the relative size of fluctuations induced by different initial conditions becomes arbitrarily small with increasing system size. Hence, the pattern self-organization in this system exhibits considerable robustness against fluctuations in the initial conditions. The main mechanism leading to stabilization at $\alpha_\infty = 0.281$ is a modulation of the traveling velocity v_r of the right phase boundary in Fig. 4 such that the boundary on average moves slightly less than one cell to the left per update step, whereas the left boundary moves one cell to the right exactly every third update step ($v_l = 1/3$). The modulation of the right boundary can be seen as the result of interacting phase boundaries reminiscent of particle interactions. This picture of “particle computation” is a useful concept also in various other contexts (Crutchfield and Mitchell, 1995).

From the fact that cells interact only with nearest neighbors one might conclude that three cells in a row in principle would be sufficient to generate a pattern, which would be in clear contradiction with a substantially larger minimum size of aggregates that was found, for example, in the case of Hydra (Technau et al., 2000). The results summarized in Fig. 5, however, indicate

index	σ_{i-1}	σ_i	σ_{i+1}	σ_i	index	σ_{i-1}	σ_i	σ_{i+1}	σ_i
0	0	0	0	0	14	1	1	2	2
1	0	0	1	2	15	1	2	0	0
2	0	0	2	1	16	1	2	1	0
3	0	1	0	0	17	1	2	2	1
4	0	1	1	2	18	2	0	0	0
5	0	1	2	2	19	2	0	1	0
6	0	2	0	1	20	2	0	2	0
7	0	2	1	2	21	2	1	0	1
8	0	2	2	2	22	2	1	1	2
9	1	0	0	0	23	2	1	2	2
10	1	0	1	1	24	2	2	0	1
11	1	0	2	1	25	2	2	1	2
12	1	1	0	0	26	2	2	2	2
13	1	1	1	1					

Table 1: Rule table of most successful cellular automata solution found during genetic algorithm search. In the left column, the rule table index is shown, running from 0 to 26, in the middle column the three input states at time t are shown, the right column shows the corresponding output states at time $t + 1$.

that pattern formation becomes very imprecise for systems smaller than 100 cells and typically fails for $N < 25$. Hence, the proposed mechanism is compatible with a required minimum system size that substantially exceeds the range of local communication. While in reaction-diffusion based models of pattern formation a certain extension of the field is required in order that the different diffusion rates come into play, in our model the differential propagation of phase boundaries leads to a similar effect.

Let us now derive a quantitative model that approximates the system dynamics. Since the left phase boundary travels at a constant speed of $v_l = 1/3$, we only have to derive a (stochastic) model for the absolute value $|\langle v_r \rangle|$ of the

configuration	p_{ij0}	$\langle v \rangle_{ij0}$
(2, 1, 0)	0.1646	0.257
(0, 2, 0)	0.1852	0.591
(2, 2, 0)	0.2058	0.167
(1, 2, 0)	0.1646	0.862
(1, 1, 0)	0.1317	0.778
(0, 1, 0)	0.1482	2.629

Table 2: The six possible configurations at the right phase boundary with their respective probabilities p_{ij0} and velocity contributions $\langle v \rangle_{ij0}$ of the corresponding transition trees (compare Fig. 6).

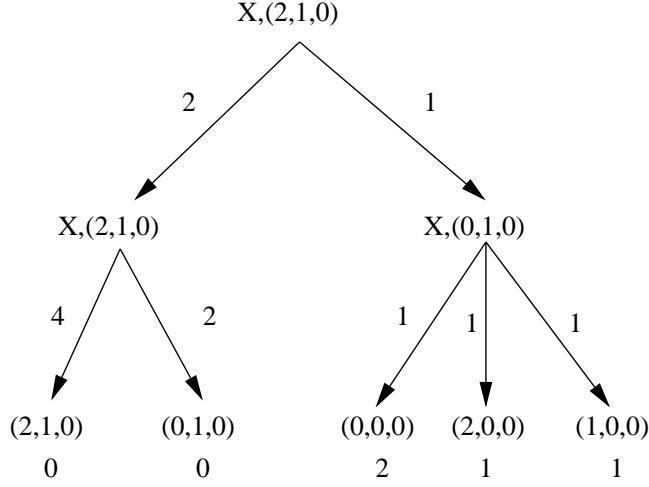

Figure 6: Transition tree for the boundary configuration $(2, 1, 0)$. Depending on the state of the left cell X , transition to different configurations occur. Numbers on arrows indicate the total number of the respective branches, the numbers at the bottom are the velocity (boundary readjustment) contributions of the respective branches. For details, see text.

average traveling speed of the right phase boundary; the equilibrium boundary position then follows as

$$\alpha = \frac{v_l}{|\langle v_r \rangle| + v_l}. \quad (9)$$

At the right phase boundary, there are three configurations (local update neighborhoods) that do not lead to a readjustment of the boundary (namely, $(0, 2, 0)$, $(2, 1, 0)$ and $(2, 2, 0)$, the zero on the right marks the boundary). The configurations $(1, 2, 0)$ and $(1, 1, 0)$ readjust the boundary one cell to the left, whereas the (extended) configurations $(x_1, x_2, 0, 1, 0)$ move the boundary either two or three cells leftward, depending on the states x_1 and x_2 . Using a Markovian approximation (i.e., a one-step master equation neglecting transition correlations between the six boundary configurations), $|\langle v_r \rangle|$ is approximated by

$$|\langle v_r \rangle| = 0 \cdot p_0 + 1 \cdot p_1 + 2 \cdot p_2 + 3 \cdot p_3, \quad (10)$$

where p_i are the respective probabilities to have a configuration that leads to boundary readjustment i cells at the left at the next time step. We neglect the slight asymmetries in the rule table and assume that each state $\sigma \in \{0, 1, 2\}$ appears with probability $1/3$, hence it is straight-forward to derive $p_0 = 1/2$ and $p_1 = 1/3$. A slightly more detailed analysis yields $p_2 = 1/18$ and $p_3 = 1/9$, leading to

$$|\langle v_r \rangle_1| \approx 0.78, \quad (11)$$

which is about 9% below the true value $|\langle v_r \rangle| \approx 0.852$ measured in model simulations.

To improve the approximation, we now take into account transition correlations between different configurations and the slightly asymmetric state distribution in the rule table. For each of the six boundary configurations, a transition tree similar to Fig. 6 is derived (for the last configuration, this tree consists of only one time step and one transition, i.e. collapses on the Markovian approximation). Taking the average over the velocity contributions v_{2i} of all branches of the second time step (where i numbers the branches), the contribution of the whole tree to the average phase boundary velocity per time step is

$$\langle v \rangle_{tree} = \frac{1}{2n_2} \sum_{i=1}^{n_2} v_{2i}, \quad (12)$$

where n_2 is the number of branches (here, $n_2 = 9$). The start configurations with their respective probabilities p_{ij0} and velocity contributions $\langle v \rangle_{ij0}$ of the corresponding transition trees are listed in table 1. The phase boundary velocity now is calculated as the weighted average

$$|\langle v_r \rangle| = \sum_{i=0, j=1}^2 p_{ij0} \cdot |\langle v \rangle_{ij0}|. \quad (13)$$

Inserting the values of table 2, one finds

$$|\langle v_r \rangle_2| \approx 0.82. \quad (14)$$

Obviously, this value is a much better estimate than the zero-order approximation $\langle v_r \rangle_1$, but still 4% below the value $|\langle v_r \rangle| \approx 0.852$ measured in simulations. We conclude that this difference is an effect of higher order correlations not included in our analysis.

3.2. Interaction topology of the minimal network

In this section, let us derive the structure of a minimal Boolean network that solves the pattern formation problem, based on the previously discussed results for cellular automata. We will see that this network has biologically realistic properties regarding the number of genes necessary for information processing and the complexity of interaction structure, making it well conceivable that similar “developmental modules” exist in biological systems.

3.2.1. Boolean network model

Let us now undertake the first step from the previous, coarse-grained model of pattern formation to a detailed model that takes into account the information processing capacity of cell-internal regulatory networks, that can communicate locally with neighboring cells. The rule table summarized in Table 1 is easily formalized in binary coding, i.e $0 \rightarrow 00$, $1 \rightarrow 01$ and $2 \rightarrow 10$, this corresponds to two “genes” G_1 and G_2 one of which (G_1) is active only in a domain at the

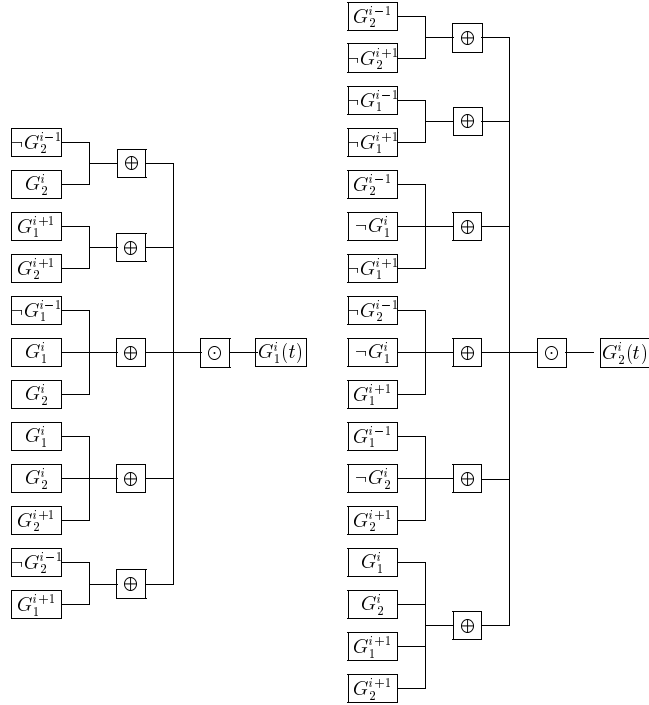

Figure 7: Boolean representation of the minimal network, minimized conjunctive normal form. G_a^b with $a \in \{1, 2\}$ and $b \in \{i-1, i, i+1\}$ denotes gene a in cell number b . The inputs in the left branches of the trees are given by the genes' states at time $t-1$. \neg denotes NOT, \odot denotes logical AND and \oplus logical OR.

left side of the cell chain. The so obtained Boolean update table is reduced to its minimized conjunctive normal form, using a Quine-McCluskey algorithm (McCluskey, 1956). For the construction of the network topology we use the conjunctive normal form, as it is a somewhat biologically plausible solution with a minimal number of logical AND operations. In principle, other network topologies, e.g. with more levels of hierarchy, are possible and biologically plausible, however, they involve a higher number of logical sub-processing steps, i.e. a higher number of genes, hence we will not discuss them here.

Considering the huge number of possible input configurations which the outputs theoretically could depend on, the complexity of the resulting network is surprisingly low. As shown in Fig. 7, the output state of gene G_1 only depends on five different input configurations of at maximum four different inputs, gene number two on six different input configurations of at maximum four different inputs. This indicates that the spatial information flowing into that network is strongly reduced by internal information processing (only a small number of input states leads to output “1”), as expected for the simple stationary target

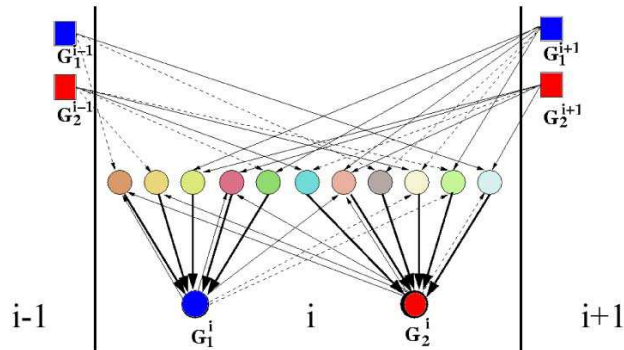

Figure 8: Threshold network realization of the pattern formation system. Solid line arrows denote links with $w_{ij} = +1$, dashed arrows denote links with $w_{ij} = -1$. The inputs from the genes in the neighbor cells ($G_1^{i-1}, G_2^{i-1}, G_1^{i+1}$ and G_2^{i+1}) are processed by a layer of “hidden genes” (colored circles in the middle of the scheme) with different thresholds h implementing a logical OR operation on the inputs. The processed signals then are propagated to the two pattern genes G_1 and G_2 . The threshold of gene G_1 is $h_1 = -5$, for gene G_2 one has $h_2 = -6$ (logical AND). Notice several feed-back connections from genes G_1^i and G_2^i to the hidden layer.

pattern. Nevertheless, this information processing is sufficient to solve the non-trivial task of domain size scaling.

3.2.2. Coupled threshold network model

Threshold dependence of the states of regulatory elements constitutes a biochemically simpler paradigm of switching behavior; information processing dynamics is encoded in activating and inhibiting interactions only, without the need for complex Boolean update tables. The simpler switching dynamics comes at the expense of an increased network size, hence the formalization as a threshold network gives us an estimate for the upper limit of regulatory network size needed to solve the pattern formation problem. The coupled threshold network system, that was derived according to the method outlined in section 2.4, is shown in Fig. 8. The states of the genes G_1 and G_2 at time t in a cell i and its two neighbor cells $i - 1$ and $i + 1$ serve as inputs of 11 information-processing genes (“hidden” layer). The state of these genes then defines the state of G_1 and G_2 in cell i at time $t + 2$ (output layer). Additionally, there is some feed-back from G_1 and G_2 to the information processing layer, as expected for the dependence on cell-internal dynamics already present in the cellular automata implementation of the model.

The resulting stationary spatial patterns of the information-processing ‘hidden’ genes and of genes G_1 (the “domain gene”) and G_2 (active only at the domain boundary) are shown in Fig. 9 (snapshots of five different update time steps for a system of 70 cells). Starting from a random initialization of the

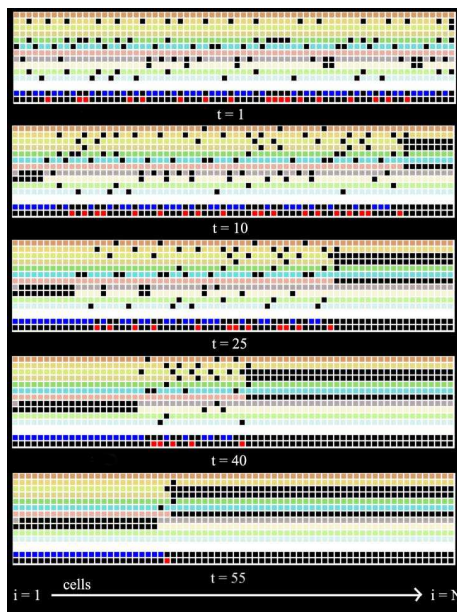

Figure 9: Snapshots of spatial gene activity patterns of the network shown in Fig. 6., for a system of 80 coupled networks (cells) at different update times t . Each row shows the state of one network gene, color coding is the same as in Fig. 8; if the respective gene is not active in the cell at time t , the cell is shown in black color. The two bottom rows show the states of the two target (pattern) genes. After 55 update time steps, the target pattern (compare Fig. 4) has self-organized.

two pattern genes G_1 and G_2 , due to the high-level genetic information processing in the hidden layer the target pattern self-organizes robustly within 55 update time steps. The network we construct here, regarded as a “developmental module” defining the head-foot polarity through spatially asymmetric gene expression, has a size similar to comparable biological modules (compare, for example, the segment polarity network in *Drosophila* (von Dassow et al., 2000; Albert and Othmer, 2003)) as well as similar complexity (e.g., average connectivity $\bar{K} \approx 3$).

4. Dynamics under noise and cell flow

In the following we will study dynamics and robustness of the model with respect to noise. Two kinds of perturbations frequently occur: Stochastic update errors and external forces induced by a directed *cell flow* due to cell proliferations. Both types of perturbations are very common during animal development, e.g., in *Hydra* cells continuously move from the central body region along the body axis towards the top and bottom, and differentiate into the respective cell

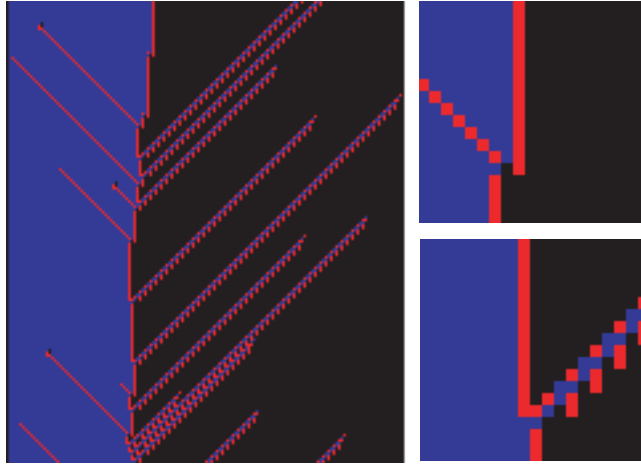

Figure 10: Quasi-particles, started by stochastic update errors, lead to control of the boundary position under noise (left panel). The Γ particle (top right) leads to readjustment of the boundary two cells to the left, the Δ particle (bottom right) leads to readjustment of the boundary one cell to the right.

types along the way according to their position on the head-foot axis. However, similar problems of reliable pattern formation in noisy and highly dynamical environments occur in tissues with a high turnover. High proliferation rates and/or movement of cells occur, for example, in skin tissues and when stochastic phenomena of cell (re-)differentiation, e.g. stochastic stem cell production, are found. In our model, we abstract stochastic changes in differentiation states by stochastic update errors, and consider directed cell movements in the form of a steady cell flow.

Let us define stochastic update errors with probability p per cell, leading to an average error rate $r_e = pN_C$. Interestingly, this stochastic noise starts moving “particle” excitations in the cellular automaton which, as a result indeed

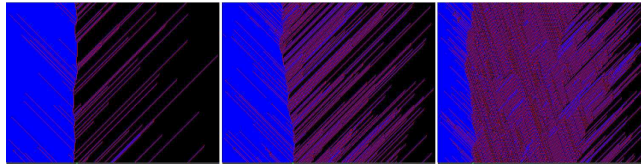

Figure 11: For moderate error rates r_e , the domain boundary is stabilized at an average position $\alpha^* = 1/3$ (left panel, $r_e = 0.1$). Around $r_e \approx 0.2$, there is a crossover to a domain size vanishing with r_e^{-1} (middle panel). In the right panel, the high noise limit is shown, with a considerably shrunk blue domain due to strong particle interference ($r_e = 2.0$).

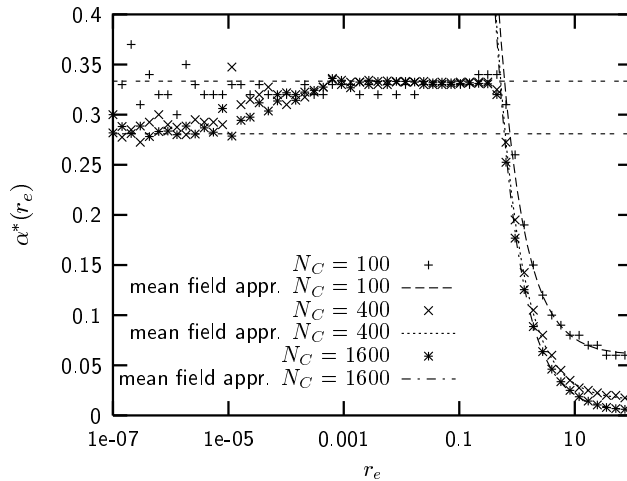

Figure 12: Average boundary position α^* as a function of the error rate r_e for system sizes $N_C = 100$, $N_C = 400$, and $N_C = 1600$. The abscissa is logarithmic. Numerical data are averaged over 200 different initial conditions with $2 \cdot 10^6$ updates each. The dashed curves show the mean field approximation given by Eqn. (35), the straight dashed lines mark the unperturbed solution $\alpha^* = 0.281$ and the solution under noise, $\alpha^* = 1/3$.

stabilize the developmental structure of the system. To prepare for the details of these effects, define first how we measure the boundary position properly in the presence of noise. Let us use a statistical method to measure the boundary position in order to get conclusive results also for high p : Starting at $i = 0$, we put a “measuring frame” of size w over cell i and the next $w - 1$ cells, move this frame to the right and, for each i , measure the fraction z of cells with state $\sigma = 2$ within the frame. The algorithm stops when z drops below $1/2$ and the boundary position is defined to be $i + w/2$.

One can show that, for not too high p , there are only two different quasi-particles (i.e. state perturbations moving through the homogeneous phases), as shown in Fig. 10. In the following, these particles are called Γ and Δ . The Γ particle is started in the σ_2 phase by a stochastic error $\sigma_i = 2 \rightarrow \sigma_i \neq 2$ at some $i < \alpha N_C$, moves to the right and, when reaching the domain boundary, readjusts it two cells to the left of its original position. The Δ particle is started in the σ_0 phase by a stochastic error $\sigma_i = 0 \rightarrow \sigma_i \neq 0$ at some $i > \alpha N_C$ and moves to the left. Interaction with the domain boundary readjusts it one cell to the right. Thus we find that the average position α^* of the boundary is given by the rate equation

$$2\alpha^* r_e = (1 - \alpha^*) r_e, \quad (15)$$

i.e. $\alpha^* = 1/3$. Interestingly, for not too high error rates r_e , α^* is independent from r_e and thus from p . If we consider the average boundary position α^* as a

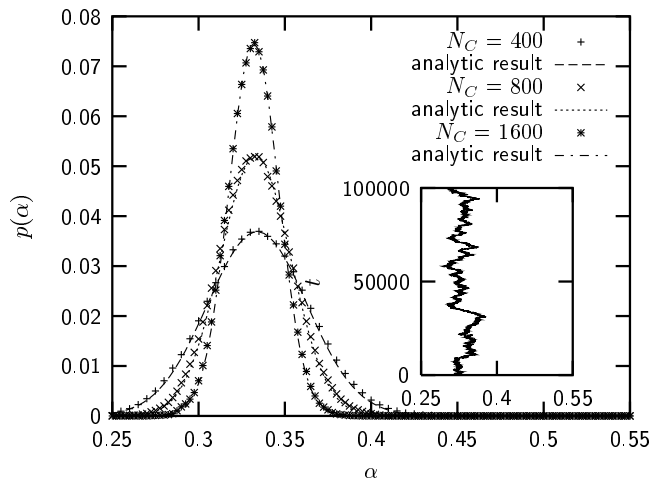

Figure 13: For the system with stochastic update errors, fluctuations of the boundary position α around the average position $\alpha^* = 1/3$ are Gaussian distributed. The figure compares the numerically obtained stationary probability distribution with the analytic result of Eqn. (23) for three different system sizes. All data are gained for $r_e = 0.1$ and averaged over 100 different initial conditions with $2 \cdot 10^6$ updates each. The inset shows a typical timeseries of the boundary position.

system-specific *order parameter* which is controlled by the two quasi-particles, then comparing the solution of Eqn. (35) to the equilibrium position in the noiseless case indicates that the system undergoes a step-like discontinuity with respect to α^* at $p = r_e = 0$. This conclusion is supported by a numerical analysis of the finite size scaling of this transition (cf. appendix C).

The solution $\alpha^* = 1/3$ is stable only for $0 < r_e \leq 1/2$. As shown in Fig. 10, the interaction of a Γ particle with the boundary needs only one update time step, whereas the boundary readjustment following a Δ particle interaction takes three update time steps. Hence, we conclude that the term on the right hand side of Eqn. (35), which gives the flow rate of Δ particles at the boundary, for large r_e will saturate at $1/3$, leading to

$$2\alpha^* r_e = \frac{1}{3} \quad (16)$$

with the solution

$$\alpha^* = \frac{1}{6} r_e^{-1} + \Theta(N_C) \quad (17)$$

for $r_e > 1/2$. Hence, there is a crossover from the solution $\alpha^* = 1/3$ to another solution vanishing with r_e^{-1} around $r_e = 1/2$. The finite size scaling term $\Theta(N_C)$ can be estimated from the following consideration: for $p \rightarrow 1$, the average domain size created by “pure chance” is given by $\alpha^* = N_C^{-1} \sum_{n=0}^{N_C} (1/3)^n \cdot n \approx (3/4) N_C^{-1}$. If the measuring window has size w , we obtain $\Theta(N_C) \approx$

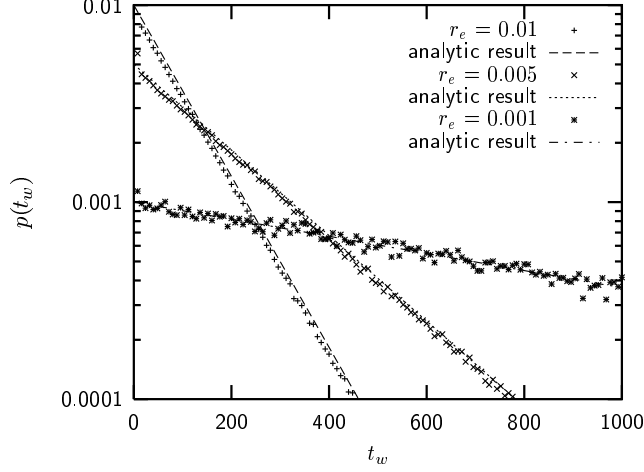

Figure 14: Probability distribution $p(t)$ of waiting times for boundary readjustments in the model with stochastic update errors for three different values of r_e , semi-log plot. As expected for a Poisson process, $p(t)$ is an exponential.

$(3/4)wN_C^{-1}$. To summarize, we find that the self-organized boundary position is given by

$$\alpha^* = \begin{cases} 0.281 \pm 0.001 & \text{if } r_e = 0 \\ 1/3 & \text{if } 0 < r_e \leq 1/2 \\ (1/6)r_e^{-1} + \Theta(N_C) & \text{if } r_e > 1/2 \end{cases} \quad (18)$$

with a step-like discontinuity at $r_e = 0$ and a crossover around $r_e = 1/2$.

Now let us consider the fluctuations of α around α^* given by the master equation

$$\begin{aligned} p^\tau(\alpha) &= 2\alpha r_e p^{\tau-1}(\alpha + 2\delta) + (1 - \alpha) r_e p^{\tau-1}(\alpha - \delta) \\ &+ (N_C - r_e) p^{\tau-1}(\alpha) - 2\alpha r_e p^{\tau-1}(\alpha) \\ &- (1 - \alpha) r_e p^{\tau-1}(\alpha) \end{aligned} \quad (19)$$

with $\delta = 1/N_C$. Eqn. (19) determines the probability $p^\tau(\alpha)$ to find the boundary at position α at update time step τ , given its position at time $\tau - 1$. This equation can be simplified as we are interested only in the *stationary probability distribution* of α . It is easy to see that the error rate r_e just provides a time scale for relaxation towards the stationary distribution and has no effect on the stationary distribution itself. Therefore, we may consider the limit $r_e \rightarrow r_e^{max} := N_C$, divide through r_e and neglect the last three terms on the right handside of Eqn. (19) (which become zero in this limit). We obtain

$$p^\tau(\alpha) = 2\alpha p^{\tau-1}(\alpha + 2\delta) + (1 - \alpha) p^{\tau-1}(\alpha - \delta). \quad (20)$$

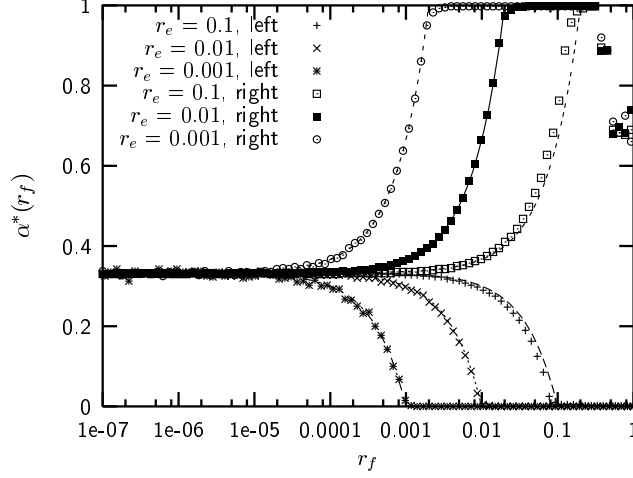

Figure 15: Average domain size α^* as a function of the the cell flow rate r_f for three different error rates r_e ; numerical data (crosses and points) were sampled over 10 different initial conditions and $1e6$ updates for each data point. “Left” indicates cell flow directed to the left system boundary, “right” to the right system boundary, respectively. The dashed lines are the corresponding solutions of Eqn. (25).

To study this equation, we consider the continuum limit $N_C \rightarrow \infty$. Let us introduce the scaling variables $x = (\alpha - \alpha^*)\sqrt{N_C}$, $t = \tau/N_C$ and the probability density $f(x, t) = N_C p^\tau(\alpha N_C)$. Inserting these definitions into Eqn. (20) and ignoring all subdominant powers $\mathcal{O}(1/N_C)$, we obtain a Fokker-Planck equation:

$$\frac{\partial f(x, t)}{\partial t} = \left(\frac{\partial^2}{\partial x^2} + 3 \frac{\partial}{\partial x} x \right) f(x, t). \quad (21)$$

The stationary solution of this equation is given by

$$f(x) = \sqrt{\frac{3}{2\pi}} \exp \left[-\frac{3}{2} x^2 \right], \quad (22)$$

i.e. in the long time limit $t \rightarrow \infty$, the probability density for the boundary position α is a Gaussian with mean α^* :

$$p(\alpha, N_C) = \sqrt{\frac{3 N_C}{2\pi}} \exp \left[-\frac{3 N_C}{2} (\alpha - \alpha^*)^2 \right]. \quad (23)$$

From Eqn. (23) we see that the variance of α vanishes $\sim 1/N_C$ and the relative boundary position becomes sharp in the limit of large system sizes. Fig. 13 shows that this continuum approximation for $N_C \geq 400$ provides very good correspondence with the numerically obtained probability distributions.

The stochastic nature of boundary stabilization under noise is also reflected by the probability distribution of *waiting times* t for boundary readjustments

due to particle interactions: the particle production is a Poisson process with the parameter $\lambda = r_e$ and the waiting time distribution is given by

$$p_{wait}(t) = r_e \exp(-r_e t) \quad (24)$$

with an average waiting time $\langle t \rangle = r_e^{-1}$. Fig. 14 shows the waiting time distributions for different error rates r_e .

In a biological organism, a pattern has to be robust not only with respect to dynamical noise, but also with respect, e.g., to “mechanical” perturbations. In *Hydra*, e.g., there is a steady flow of cells directed towards the animal’s head and foot, due to continued proliferation of stem cells (David and Campbell, 1972); the stationary pattern of gene activity is maintained in spite of this cell flow. Let us now study the robustness of the model with respect to this type of perturbation. Let us consider a constant cell flow with rate r_f , which is directed towards the left or the right system boundary. In Eqn. (9), we now get an additional drift term r_f on the left hand side:

$$2\alpha^* r_e \pm r_f = r_e(1 - \alpha^*), \quad (25)$$

with the solution

$$\alpha^* = \begin{cases} \frac{1}{3} \left(1 - \frac{r_f}{r_e}\right) & \text{if } r_e \geq r_f \\ 0 & \text{if } r_e < r_f \end{cases} \quad (26)$$

for the case of cell flow directed towards the left system boundary (plus sign in eqn. (25)). One observes that α^* undergoes a second order phase transition at the critical value $r_e^{crit} = r_f$. Below r_e^{crit} , the domain size α^* vanishes, and above r_e^{crit} it grows until it reaches the value $\alpha_{max}^* = 1/3$ of the system without cell flow. For cell flow directed towards the right system boundary (minus sign in eqn. (25)), we obtain

$$\alpha^* = \begin{cases} \frac{1}{3} \left(1 + \frac{r_f}{r_e}\right) & \text{if } r_f \leq 2r_e \\ 1 & \text{if } r_f > 2r_e. \end{cases} \quad (27)$$

In this case, the critical cell flow rate is given by $r_f = 2r_e$, for cell flow rates larger than this value the σ_2 -domain extends over the whole system, i.e. $\alpha^* = 1$.

Fig. 15 compares the results of numerical simulations with the mean field approximation of Eqn. (25). In numerical simulations, cell flow is realized by application of the translation operator $\Theta \sigma_i := \sigma_{i+1}$ to all cells with $0 \leq i < N_C - 1$ every r_f^{-1} time steps and leaving σ_{N_C-1} unchanged. In case of cell flow directed to the right system boundary, in the limit $r_f \rightarrow 1$ the boundary position α^* detected in numerical simulations deviates from the mean field prediction, due to a boundary effect at the left system boundary (stochastic production of finite lifetime stationary oscillators, leading to intermittent flows of Γ particles through the system).

To summarize this part, we see that in the model stochastic errors in dynamical updates for $r_e > r_f$ indeed *stabilize* the global pattern against the mechanical stress of directed cell flow.

5. Proportion regulation in a growing system

So far, we assumed that the system size N (the number of cells) is constant, which is a good approximation for an adult organism; in a developing organism, however, proportion regulation has to work under the condition of a steadily growing system size. Here, we study this problem for two simplified settings: first, for symmetric growth, i.e., new cells are added with probability $1/2$ on either side of the chain of cells, and the growth rate r_g is constant on average; second, for homogeneous cell proliferation with probability p_d per cell, assuming that daughter cells inherit the state of the mother cell.

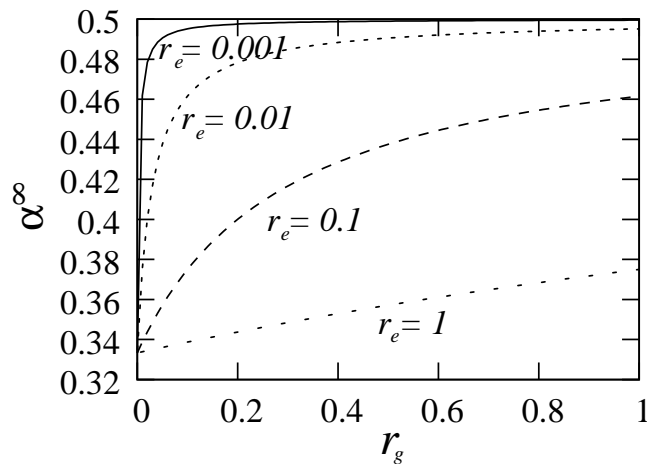

Figure 16: Asymptotic boundary position $\alpha^\infty(r_g)$ in the case of unlimited symmetric growth at the boundaries of the cellular array, for four different error rates r_e .

5.1. Symmetric growth at the system boundaries

Let us assume we start with a system of N_0 cells, with an initial boundary position at cell N_1 . In the deterministic case $r_e = 0$, it is straight-forward to see that the asymptotic boundary position in the limit of large times t is given by

$$\alpha^\infty = \lim_{t \rightarrow \infty} \alpha^*(t) = \frac{1}{2} \quad (28)$$

(for details, see appendix D.1). This means that in the limit $r_e = 0$, proportion regulation cannot be maintained under the condition of a steady system growth. In the case $r_e > 0$ and assuming infinite growth, the asymptotic boundary position is given by

$$\alpha^\infty = \lim_{t \rightarrow \infty} \alpha^*(t) = \frac{\frac{1}{2}r_g + r_e}{r_g + 3r_e} \quad (29)$$

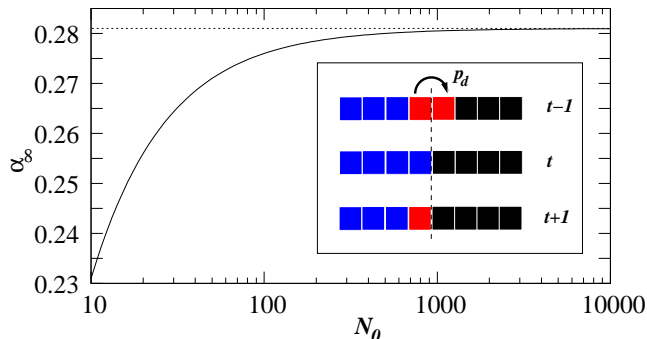

Figure 17: Asymptotic domain boundary position α_∞ (lined curve) as a function of the initial system size N_0 , for homogeneous growth, as explained in the text. One has $\alpha_\infty = \alpha_0 - 1/N_0$, where $\alpha_0 = 0.281$ is the boundary position of the constant-size system (dashed line). *Inset*: Proliferation of the boundary cell (red) at time $t - 1$ leads to readjustment of the boundary at its original position (indicated by the dashed line) at time $t + 1$, thereby increasing the black domain by one cell and hence slightly reducing α .

(a derivation can be found in appendix D.1). Fig. 16 shows $\alpha^\infty(r_g)$ for four different values of r_e ; it becomes evident that an approximately 'correct' proportion regulation requires r_e to be at the order of r_g or larger, i.e. $r_e/r_g \geq 1$. While r_e (the rate of regulatory signals) may not be increased significantly above the growth rate r_g , due to metabolic constraints, in later stages of development the steady decrease of r_g will ensure that the condition $r_e/r_g \geq 1$ is fulfilled and proportion regulation approaches the steady state of the adult organism.

5.2. Homogeneous cell proliferation

Another simple case is system growth by *homogeneous cell proliferation*. Assuming that daughter cells inherit the state of their mother cell, one can show that proportion regulation is maintained even in the case of zero noise, under the simplifying assumption that initial pattern formation takes place in a system of size N_0 , and that system growth does not start before pattern formation has converged to its attractor. Due to an instability induced by proliferation events directly at the boundary cell with $\sigma_b = 1$ (compare inset of Fig. 17), slight deviations asymptotic boundary position α_0 of non-growing systems are found for finite N_0 (Fig. 17, for details, cf. appendix D.2):

$$\alpha_\infty = \lim_{t \rightarrow \infty} \alpha(t) = \alpha_0 - \frac{1}{2N_0} \quad (30)$$

For the case when noise is present, it is not possible to find a general solution since proliferation can affect both the velocity and the type of particles travelling through the domains in intricate ways (in the case of symmetric growth at the system boundaries, as discussed in the previous subsection, this problem is

avoided). If p_d is very small, however, we can assume that proliferation events and particle propagation are essentially decoupled and that the system has enough time to relax to a stationary state between proliferation events. In this limit, one can show that the asymptotic boundary position converges to the value $\alpha = 1/3$ of the stationary size system as discussed in section 4 (for a derivation cf. appendix D.2).

6. Regeneration in a simulated cut experiment

Simple multi-cellular organisms as, e.g., *Hydra* exhibit remarkable regeneration capacities, which include, as already discussed, proportion regulation and de-novo pattern formation after complete dissociation of the body tissue. Similarly, it was already observed in the late 19th century that polyps can be cut in half, leading to regeneration of two new, intact animals (). Without going into the more intricate details of these experiments, we now demonstrate that, given minimum level of noise in the system, our model in principle can reproduce this type of observation. Fig. 18 illustrates a simulated cut experiment, where, after 300 initial system updates, the cellular array was cut into two equal-sized halves. After just 500 subsequent updates, both new sub-systems have self-organized again into the target pattern with $\alpha = 1/3$.

7. Robustness under noisy direction recognition

While asymmetries in receptor distribution on cell membranes, asymmetric distribution of cell factors in the cell or an external gradient might provide some information about the asymmetry (the direction) of the spatial pattern along the body axis, which then can be processed by a cell-internal gene regulatory network, a substantial amount of noise can be expected to be present in this process. In particular, in the system discussed in this paper, this type of information can be assessed only locally, hence we expect that local errors in 'direction recognition' can substantially disrupt the emergence of the global pattern.

We now test the robustness of our model with respect to this type of errors. Let $(\sigma_{i-1}(t), \sigma_i(t), \sigma_{i+1}(t))$ be the state of the neighborhood of cell i at time t , then the state of cell i at time $t + 1$ is given by

$$\sigma_i(t+1) = \begin{cases} f(\sigma_{i-1}(t), \sigma_i(t), \sigma_{i+1}(t)) & \text{with prob. } 1 - p_{dir} \\ f(\sigma_{i+1}(t), \sigma_i(t), \sigma_{i-1}(t)) & \text{with prob. } p_{dir} \end{cases}, \quad (31)$$

where p_{dir} is the probability of false direction recognition, and $f(\cdot)$ is the corresponding rule table entry associated to the state $(\sigma_{i-1}(t), \sigma_i(t), \sigma_{i+1}(t))$ and its locally inverted state $(\sigma_{i+1}(t), \sigma_i(t), \sigma_{i-1}(t))$, respectively.

Our first finding is that the dynamics of the original system (deterministic dynamics, i.e. $r_e = 0$), is indeed disrupted, due to a destabilization of the boundary state. For $p_{dir} < 0.2$, α always goes to zero, while at $p_{dir} \approx 0.2$,

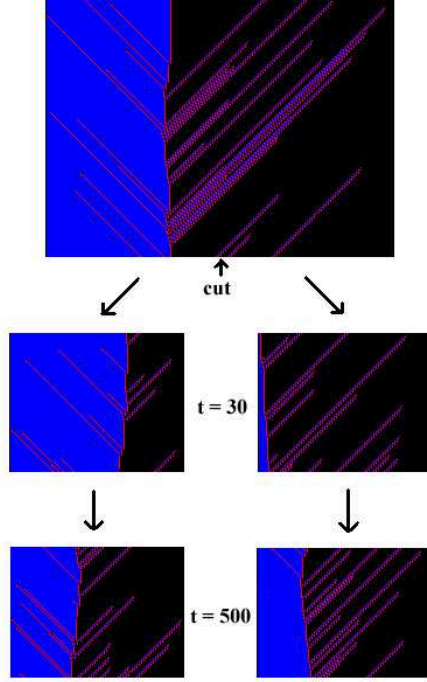

Figure 18: A simulated cut experiment. After 300 updates, a system of 500 cells was cut into two sub-systems of 250 cells each (upper panel). After only 30 updates, in both sub-systems reorganization of the boundary position starts (middle panels). After about 500 system updates, both sub-systems have self-organized into the target pattern with $\alpha = 1/3$ (bottom panels). In the simulation, $r_e = 0.01$ was applied.

there is an abrupt jump to $\alpha \approx 0.95$ (Fig. 20, top left panel). However, the situation changes substantially in the much more realistic case of a finite error rate in dynamical updates, i.e. $r_e > 0$. Fig. 19 demonstrates that in this case initial pattern formation (left panel), as well as control of the boundary position by noise induced particles (right panel) work, although the trajectory of the information-transmitting particles is blurred out and broadened by the stochastic errors in direction recognition. The latter effect is reflected by an increase in fluctuation size (an increase of the variance) of the boundary position α with increasing p_{dir} , in particular in the limit of high dynamical error rate r_e (Fig. 20, bottom panels). Remarkably, the *average* boundary position α is stabilized over a wide range of the new control parameter p_{dir} , both in the limit of small r_e (Fig. 20, left upper panel) and large r_e (Fig. 20, right upper panel). While there is some dependence on both p_{dir} and r_e , as reflected by the fact that the curves $\alpha(p_{dir}, r_e)$ for different values of r_e do not collapse, the principal pattern formation mechanism still works, given we stay at reasonable values $p_{dir} < 0.2$. Hence, the system exhibits remarkable robustness also with respect

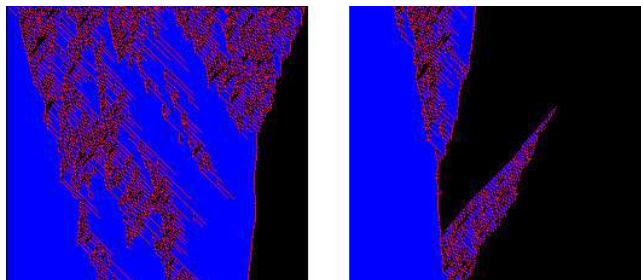

Figure 19: Dynamics of pattern formation under noisy direction recognition; parameters in the simulation shown here were $p_{dir} = 0.1$ and $r_e = 0.003$. Initial pattern formation (left panel) as well as control of the boundary by quasi-particles (right panel) still work, though particle trajectories become broadened and blurred.

to errors in direction recognition. Notice that this robustness was *not selected for* in GA runs, i.e., it is a truly emergent property of the system dynamics. In a real system of coupled gene regulatory networks, additional mechanisms for error correction might be present, that, for example, process information not only from direct neighbor cells, or exploit the *2D or 3D geometry* of a real tissue (Rohlf and Bornholdt, 2004b).

8. Summary and Discussion

In this paper we considered the dynamics of pattern formation motivated by animal morphogenesis and the largely observed participation of complex gene regulation networks in their coordination and control. We therefore chose a simple developmental problem to study toy models of interacting networks that control pattern formation and morphogenesis in a multicellular setting. In particular, the goal was to explore how networks can offer additional mechanisms beyond the standard diffusion based process of the Turing instability. Our results suggest that main functions of morphogenesis can be performed by dynamical networks without relying on diffusive biochemical signals, but using local signaling between neighboring cells. This includes solving the problem of generating global position information from purely local interactions, but also it goes beyond diffusion based models as it offers solutions to developmental problems that are difficult for such models and avoids their inherent problem of fine tuned model parameters. Indeed, it has been shown in case studies that this paradigm applies well to development, as for example for the segment polarity network of *Drosophila*, which exhibits robustness against parameter variations by several orders of magnitude (von Dassow et al., 2000), and where spatial gene expression patterns can be predicted reliably from the topology of regulatory interactions alone in a Boolean network model (Albert and Othmer, 2003). In many cases, developmental processes as, e.g., the establishment of positional information, may rely on this type of internal information processing rather than

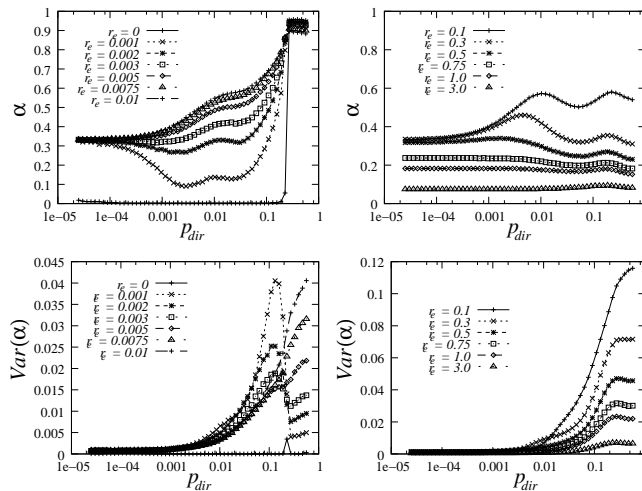

Figure 20: *Upper panels*: average boundary position α as a function of p_{dir} , for different values of r_e . Left panel: low noise limit ($r_e \rightarrow 0$), right panel: high noise limit. *Lower panels*: Fluctuations (temporal variance) of the boundary position as a function of p_{dir} .

on interpretation of global chemical gradients. In this type of local information processing, several ways how spatial symmetry of morphogenetic signals could be broken are conceivable. Cells potentially could exploit local anisotropies in receptor localization (Galle et al., 2002), as well as gradients produced by local propagation of morphogens (Kasatkin et al., 2007) or juxtacrine signaling (Monk, 1998). In either case, the mechanism proposed in our model would exhibit considerable robustness, since only a rough estimate on the direction of the receptor anisotropy or the gradient is needed (compare section 7 on robustness under noisy direction recognition).

The network model derived here performs accurate regulation of position information and robust *de novo* pattern formation from random conditions, with a mechanism based on local information transfer rather than the Turing instability. Non-local information is transmitted through soliton-like quasi-particles instead of long-range gradients. Two realizations as discrete dynamical networks, Boolean networks and threshold networks, have been developed. The resulting networks have size and complexity comparable to developmental gene regulation modules as observed in animals, e.g., *Drosophila* (von Dassow et al., 2000; Albert and Othmer, 2003) or *Hydra* (Bosch, 2003). The threshold networks (as models for transcriptional regulation networks) process position information in a hierarchical manner; in the present study, hierarchy levels were limited to three, but realizations with more levels of hierarchy, i.e. more “pre-processing” of information are also possible. Similar hierarchical and modular organization are typical signatures of gene regulatory networks in organisms (Davidson, 2001).

Robustness of the model was studied in detail for two types of perturbations, stochastic update errors (noise) and directed cell flow. A first order phase transition is observed for vanishing noise and a second order phase transition at increasing cell flow. Fluctuations of the noise-controlled boundary position were studied numerically for finite size systems and analytically in the continuum limit. We find that the relative size of fluctuations vanishes with $1/N_C$, which means that the boundary position becomes sharp in the limit of large system sizes. This means that, based on the proposed local mechanism of coupled regulatory networks, positional information can be reliably controlled also in large tissues, which is problematic in the alternative case of morphogenetic gradients that are typically limited to relatively small spatial domains. Dynamics under cell flow was studied in detail numerically and analytically by a mean field approximation. A basic observation is that noise-induced perturbations act as quasi-particles that stabilize the pattern against the directed force of cell flow. Hence, we make the interesting observation that noise in local gene expression states (over several orders of magnitude in the relevant dynamical parameters) contributes to robustness of the global developmental dynamics; furthermore, this is a truly emergent property of the spatial system, which was not selected during simulated evolution. At a critical cell flow rate, there is a second order phase transition towards a vanishing domain size or a domain extending over the whole system, depending on the direction of cell flow, respectively. The proposed local mechanism of developmental pattern control also works in growing tissues, reproduces pattern regeneration after cutting a tissue in half, and is robust against noise in the recognition of the body axis direction.

Let us briefly compare the prospects and limitations our model with respect to other recent models suggested for pattern formation, and with experimental evidence. "Local" models of pattern formation, in contrast to older models that require long-range diffusion (which is problematic in multi-cellular environments in a number of regards), have been suggested in the context of juxtacrine signalling (JS, Monk (1998); Owen et al. (2000)) and homeoprotein intercellular transfer (HIT, Kasatkin et al. (2007); Holcman et al. (2007)). Similar to JS models with relay, traveling waves/excitations emerge in our model as a means to provide long range communication. Sharpness and precision of boundary regulation is shared with HIT models, where, however, this property arises from a different mechanism (meeting of morphogenetic gradients). While in HIT models noise can substantially affect boundary regulation, an essential property of the model analyzed in our study is its astonishing robustness against noise. When cell movement is present, noise in fact considerably contributes to pattern regulation and -stabilization. An evident limitation of the model arises from the fact that it accounts for regulation of sharp expression boundaries, but not for graded expression patterns. Sharp boundaries are indeed found for many genes in development (examples in Hydra are Hedgehog (Kaloulis, 2000) and the sharp basal border of HyBMP5-8b (Reinhardt et al., 2004)), while other genes such as CnNK2 (Grens et al., 1996) and Dkk (Augustin et al., 2006) exhibit more graded expression patterns along the body axis. It seems quite natural to assume that, in addition to local mechanisms as proposed in our model, other

mechanisms of pattern formation are present in developing organisms that work on other scales and in different functional contexts, involving regulatory processes based on graded expression profiles. The hierarchical interplay of such diverse regulatory mechanisms might substantially contribute to the astonishing robustness of developmental processes. Going beyond basal metazoa such as *Hydra*, other interesting applications of our model are conceivable. For instance, local communication systems between adjacent cells as, for example, the Delta/Notch systems, play a decisive role in vertebrate development, with traveling waves providing long-range synchronization of developmental processes (Ozbudak and Pourquie, 2008).

Several extensions of the model as described in this paper are conceivable. In the present model, the cell flow rate r_f is considered as a free parameter, the global pattern, however, can be controlled easily by an appropriate choice of the error rate r_e . This may suggest to extend the model by introduction of some kind of dynamical coupling between r_e and r_f , treating r_f as a function of r_e . Interestingly, similar approaches have been studied by Hogeweg (Hogeweg, 2000) and Furusawa and Kaneko (Furusawa, 2000; Furusawa and Kaneko, 2003): In both models of morphogenesis, the rate of cell divisions is controlled by cell differentiation and cell-to-cell signaling. Dynamics in both models, however, is deterministic. An extension of our model as outlined above may open up for interesting studies how *stochastic* signaling events could control and stabilize a global expression pattern and cell flow as an integrated system. Other possible extensions of the model concern the dimensionality: In two or three dimensions other mechanisms of symmetry breaking might be present, possibly leading to new, interesting dynamical effects.

A Java applet simulation of the model can be found at <http://www.theo-physik.uni-kiel.de/~rohlf/development.html>.

9. Acknowledgements

We thank T.C.G. Bosch, T.W. Holstein, and U. Technau for pointing us to current questions in Hydra development. T.R. acknowledges financial support from the Studienstiftung des deutschen Volkes (German National Academic Foundation).

A. Genetic algorithm searches

Let us briefly recapitulate here how the rule table of the model has been obtained by the aid of a genetic algorithm.

A.1. Definition of the GA

In order to find a set \mathcal{F} of update rules that solve the problem as formulated in section II, cellular automata have been evolved using genetic algorithms (Mitchell et al., 1994). Genetic algorithms are population-based search algorithms, which are inspired by the interplay of random mutations and selection

as observed in biological evolution (Holland, 1975). Starting from a randomly generated population of P rule tables f_n , the algorithm optimizes possible solutions by evaluating the fitness function

$$\Phi(f_n) = \frac{1}{(T_u - T) \cdot N_C} \sum_{t=T_u-T}^{T_u} \left(\sum_{i=0}^{[\alpha \cdot N_C]-1} \delta_{\sigma_i^n(t),2} + \sum_{i=[\alpha \cdot N_C]}^{N_C-1} \{1 - \delta_{\sigma_i^n(t),2}\} \right). \quad (32)$$

The optimization algorithm then is defined as follows:

1. Generate a random initial population $\mathcal{F} = \{f_1, \dots, f_P\}$ of rule tables.
2. Randomly assign system sizes $N_C^{min} \leq N_C^n \leq N_C^{max}$ to all rule tables.
3. For each rule table, generate a random initial state vector.
4. Randomly mutate one entry of each rule table (generating a population \mathcal{F}^* of mutants).
5. Iterate dynamics over T_u time steps for \mathcal{F} and \mathcal{F}^* .
6. Evaluate $\Phi(f_n)$ and $\Phi(f_n^*)$ for all rule tables $0 < n \leq P$, averaging over the past $T_u - T$ update steps (with an additional penalty term if f_n does not converge to a fixed point).
7. For each n , replace f_n with f_n^* , if $\Phi(f_n) \leq \Phi(f_n^*)$.
8. Replace the least fit solution by a duplicate of the fittest one.
9. Go back to step 2 and iterate.

The outcome of this search algorithm is a set of rule tables, which then can be “translated” into (spatially coupled) Boolean networks or threshold networks with suitable thresholds. This yields a set of (minimal) dynamical networks which solve the pattern formation task by means of internal information processing.

A.2. Evolution of cellular automata

The genetic algorithm sketched above is run with the following parameter choices: $15 \leq N_C \leq 150$, i.e. during GA runs the system size is varied randomly between 15 and 150 cells, and the population size is set to $P = 100$. Fig. 21 shows the fitness of the highest fitness mutant and the average fitness of the population as a function of the number of successive mutation steps during optimization. A useful solution is found rather quickly (after about 200 updates), with further optimization observed during further 10000 generations. At time step 10000 mutations are turned off, thus now the average fitness of the established population under random initial conditions and random fluctuations of the system size N_C is tested. The average fitness $\Phi \approx 0.98$ indicates a surprisingly high robustness against fluctuations in the initial start pattern, indicating that the system is capable of *de novo pattern formation*. In the “fitness picture”, Fig. 22 confirms that the dynamically regulated domain size ratio $\alpha/(1 - \alpha)$

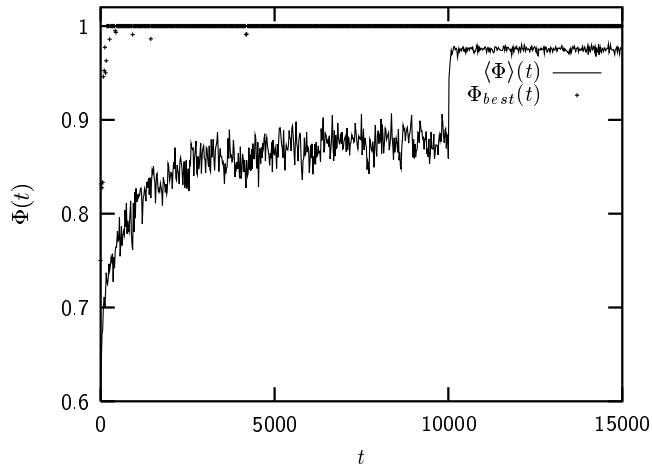

Figure 21: Average fitness $\langle \Phi \rangle(t)$ of the mutant population \mathcal{F}^* and fitness of the highest fitness mutant $\Phi_{best}(t)$ as a function of simulation time during the genetic algorithm run that lead to the high fitness solution used in this paper. At time step 10000 mutations were turned off, in order to test the established population of optimized rule tables under different initial conditions (this corresponds to the sharp increase of $\langle \Phi \rangle(t)$ at time step 10000). The evolved population of rule tables has an average fitness of about 0.98, independent from the initial conditions and system size N_C (in the tested range, i.e. $15 \leq N_C \leq 150$).

indeed is independent of system size (proportion regulation), there is only a weak decay of the fitness at small values of N_C . Interestingly, one also observes that for regeneration of Hydra polyps from random cell aggregates a minimum number of cells is required (Technau et al., 2000). The model suggests that this observation might be explained by the dynamics of an underlying pattern generating mechanism, i.e. that there has to be a minimum diversity in the initial condition for successful de novo pattern formation.

B. Statistical analysis of solutions

An interesting question is how “difficult” it would be for an evolutionary process driven by random mutations and selection to find solutions for the pattern formation problem based on neighbor interactions between cells. As we showed above, the genetic algorithm finds the correct solution fast, however, this does not necessarily mean that biological evolution could access the same solution as fast. If there is only one, singular solution, evolution may never succeed finding it, as the genotype which already exists cannot be modified in an arbitrary way without possibly destroying function of the organism (*developmental constraints*). To illustrate this point, we generated an ensemble of $N_E = 80$ different solutions with $\Phi \geq 0.96$ and performed a statistical analysis of the rule table structure.

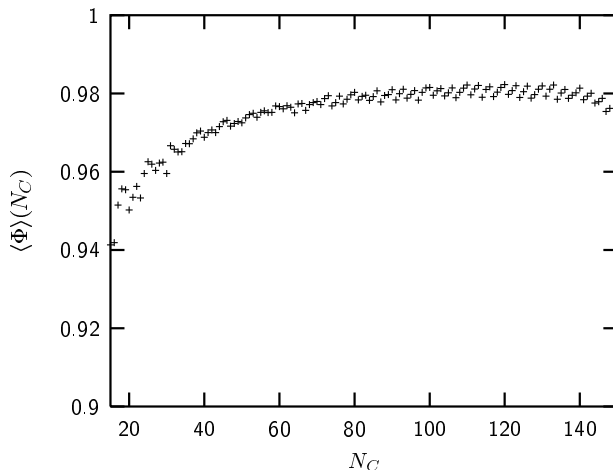

Figure 22: Average fitness of the highest fitness rule table as a function of the system size N_C . For system sizes $N_C \geq 80$ the fitness is almost constant at about 0.98. Notice that the decrease of the fitness for small N_C is an effect of the *dynamics*, not of the genetic algorithm implementation (all N_C in the range $15 \leq N_C \leq 150$ were tested with equal probability), hence the dynamics of pattern formation may impose a lower boundary on the range of system (animal) sizes tolerated by natural selection.

As one can see in Fig. 23, some positions in the rule table are quite fixed, i.e., there is not much variety in the outputs, whereas other positions are more variable. We note that a number of rule table positions are *a priori* fixed due to the constraints imposed on dynamics. For example, to support a stable boundary ...2221000... as for the model described, five rules become fixed: $222 \rightarrow 2$, $221 \rightarrow 2$, $210 \rightarrow 1$, $100 \rightarrow 0$ and $000 \rightarrow 0$ (these rules can be clearly distinguished as pronounced peaks in Fig. 23). Consistency with boundary conditions fixes more rules. For the model as described in this manuscript, i.e. boundary conditions $\sigma_{-1} = \sigma_{N_C} = 0$, the rule $022 \rightarrow 2$ becomes fixed, too.

However, the output frequency distribution alone does not allow to really judge the “evolvability” of the solutions: if there are strong correlations between most of the rule table entries, evolutionary transitions from one solution to another would be almost impossible. To check this point, we studied statistical two point correlations between the rule table entries. The probability for finding state σ at position a and state σ' at rule table position b is given by

$$p^{ab}(\sigma, \sigma') = \frac{1}{N_E} \sum_{n=1}^{N_E} \delta_{\sigma^n(a), \sigma} \cdot \delta_{\sigma^n(b), \sigma'}, \quad (33)$$

where δ is the Kronecker symbol and n runs over the statistical ensemble of size

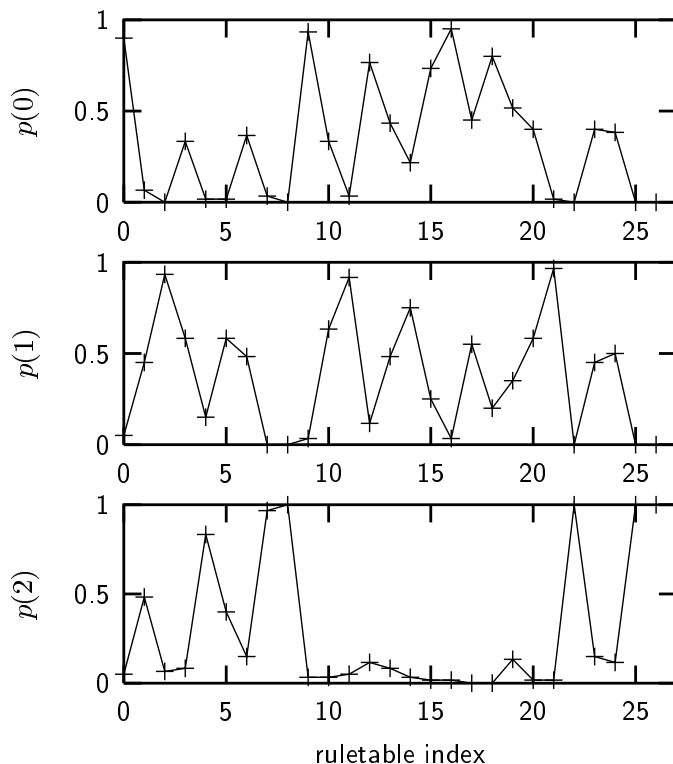

Figure 23: Frequency distribution $p(\sigma_i)$ of outputs as a function of the rule table index as denoted in table 1. Ensemble statistics is taken over 80 different solutions with $\Phi \geq 0.96$. The upper panel shows the distribution for $\sigma_i = 0$, the middle panel the distribution for $\sigma_i = 1$ and the lower panel the distribution for $\sigma_i = 2$.

N_E . The two point correlation between a and b then is defined as

$$C^{ab} = c_1 \left(\max_{(\sigma, \sigma')} p^{ab}(\sigma, \sigma') - c_2 \right) \quad (34)$$

with $c_1 = 9/8$ and $c_2 = 1/9$ to obtain a proper normalization with respect to the two limiting cases of equal probabilities ($p^{ab}(\sigma, \sigma') = 1/9 \quad \forall(\sigma, \sigma')$) and $p^{ab}(\sigma, \sigma') = 1$ for $\sigma = \tilde{\sigma}, \quad \sigma' = \tilde{\sigma}'$ and $p^{ab}(\sigma, \sigma') = 0$ for all other (σ, σ') . Fig. 24 shows the frequency distribution of $C^{ab}(\sigma, \sigma')$, averaged over all possible pairs (a, b) . About 65% of rule table positions are strongly correlated ($C^{ab} = 1.0$), the rest shows correlation values between 0.3 and 1.0. Hence, we find that the space of solutions is restricted, nevertheless there is variability in several rule table positions. To summarize this aspect, the pattern formation mechanism studied in this paper shows considerable robustness against rule mutations, however, a “core module” of rules is always fixed. Interestingly, a similar phenomenon is observed in developmental biology: Regulatory modules involved in develop-

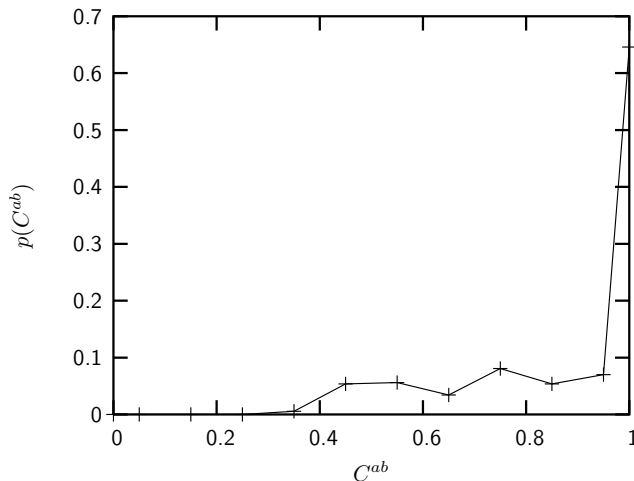

Figure 24: Frequency distribution $p(C^{ab})$ of two point correlations $C^{ab}(\sigma, \sigma')$ of rule table entries, as defined in Eqn. (B2), averaged over all possible pairs of rule table entries. About 65% of rule table entries have correlation 1.0, for the rest the correlation is lower.

mental processes often are evolutionarily very conservative, i.e., they are shared by almost all animal phyla (Davidson, 2001), while morphological variety is created by (few) taxon specific genes (Bosch, 2003) and rewiring of existing developmental modules.

C. Numerical analysis of the dynamical transition at $r_e = 0$

The rate equation of the pattern formation system in the presence of noise with error rate r_e is given by

$$2\alpha^* r_e = (1 - \alpha^*) r_e, \quad (35)$$

i.e. $\alpha^* = 1/3$. Comparison to the equilibrium position in the noiseless case indicates that the system undergoes a step-like discontinuity with respect to α^* at $r_e = 0$. A numerical analysis that considers small variations of r_e close to zero and averages over time windows of variable length s_w can be applied for supporting numerical evidence and *finite size scaling*.

Figs. 25 and 26 show noise dependence and finite size scaling of the transition from the unperturbed solution to the solution under noise. Considering update time windows of different length s_w , in case of a discontinuity (i.e., a step-like 'jump' of the order parameter) at $r_e = 0$ we would expect a shift of the transition point $r_e^{trans}(s_w)$ towards $r_e = 0$ which is proportional to s_w^{-1} as well as a divergence of the slope at the transition point when s_w is increased, i.e. $d\alpha^*/dr_e(r_e^{trans}) \rightarrow \infty$ when $s_w \rightarrow \infty$.

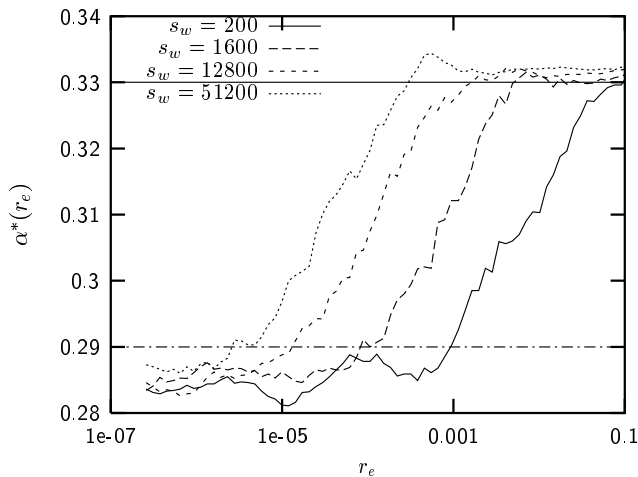

Figure 25: Average domain boundary position α^* as a function of the error rate r_e , sampled over update windows of different lengths s_w (ensemble statistics, 400 different initial conditions for each data point). The abscissa is logarithmic. With increasing s_w , the transition from the solution $\alpha_{det}^* = 0.281$ under deterministic dynamics to $\alpha^* = 1/3$ under noise is shifted towards $r_e = 0$. The two straight lines define a lower boundary α_{low}^* and an upper boundary α_{up}^* , as explained in the text.

The shift of $r_e^{trans}(s_w)$ is most easily measured by defining a lower and an upper boundary α_{low}^* and α_{up}^* , respectively (Fig. 25); when α^* crosses these boundaries, two transition points r_e^{up} and r_e^{low} are obtained. We find that $r_e^{up} \approx c_{up}s_w^{-1}$ and $r_e^{low} \approx c_{low}s_w^{-1}$ with $c_{up} > c_{low}$ as expected (Fig. 26), which implies that the difference $\Delta r_e^{trans}(s_w) := r_e^{up} - r_e^{low}$ scales as

$$\Delta r_e^{trans}(s_w) = (c_{up} - c_{low}) s_w^{-1}, \quad (36)$$

hence, because $\Delta \alpha^*(r_e^{trans}) = const. = \alpha_{up}^* - \alpha_{low}^*$, indeed $d\alpha^*/dr_e(r_e^{trans})$ diverges when the sampling window size goes to infinity.

D. Derivation of stability conditions for growing systems

D.1. Symmetric growth at the system boundaries

Let us assume we start with a system of N_0 cells, with an initial boundary position at cell N_1 . In the deterministic case $r_e = 0$, it is straight-forward to see that the time dependence of the average boundary position is given by

$$\alpha^*(t) = \frac{N_1 + \frac{1}{2}r_g t}{N_0 + r_g t}, \quad (37)$$

hence we have

$$\alpha^\infty = \lim_{t \rightarrow \infty} \alpha^*(t) = \frac{1}{2}. \quad (38)$$

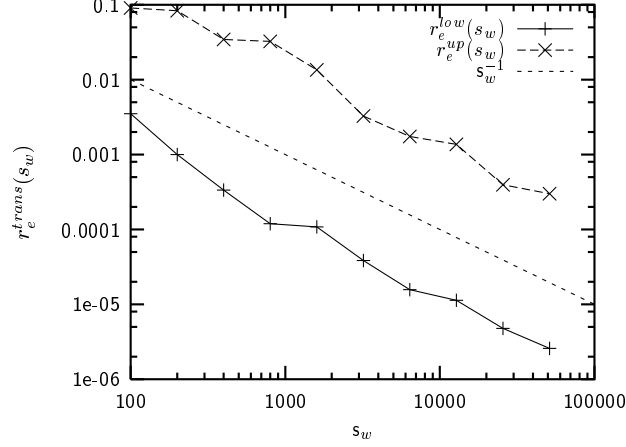

Figure 26: Finite size scaling of the upper and lower transition points r_e^{up} and r_e^{low} , i.e. the points where α^* crosses α_{low}^* and α_{up}^* , respectively (Fig. 25), as a function of the sampling window length s_w . Both r_e^{up} and r_e^{low} vanish $\propto s_w^{-1}$, as indicated by the line with slope -1 in this log-log-plot.

In the case $r_e > 0$, the time dependence of the average boundary position is given by

$$\alpha^*(t) = \frac{N_1 + \frac{1}{2}r_g t - 2\alpha^*(t)r_e t + (1 - \alpha^*(t))r_e t}{N_0 + r_g t}, \quad (39)$$

which simplifies to

$$\alpha^*(t) = \frac{N_1 + \frac{1}{2}r_g t + r_e t}{N_0 + r_g t + 3r_e t}. \quad (40)$$

Assuming infinite growth, this leads to the asymptotic boundary position

$$\alpha^\infty = \lim_{t \rightarrow \infty} \alpha^*(t) = \frac{\frac{1}{2}r_g + r_e}{r_g + 3r_e}. \quad (41)$$

Fig. 16 shows $\alpha^\infty(r_g)$ for four different values of r_e ; it becomes evident that an approximately 'correct' proportion regulation requires r_e to be at the order of r_g or larger, i.e. $r_e/r_g \geq 1$. While r_e (the rate of regulatory signals) may not be increased significantly above the growth rate r_g , due to metabolic constraints, in later stages of development the steady decrease of r_g will ensure that the condition $r_e/r_g \geq 1$ is fulfilled and proportion regulation approaches the steady state of the adult organism.

D.2. Growth by homogeneous cell proliferation

We require that de-novo pattern formation has taken place in a system of stationary size N_0 and has converged to its final pattern.

Assuming homogeneous cell proliferation with a probability p_d per cell, it is easy to see that proliferation of "blue" ($\sigma_i = 2$) and "black" ($\sigma_i = 0$) cells conserves pattern proportions, proliferation of the "red" boundary cell ($\sigma_i = 1$), however, leads to readjustment of the boundary at its original position before proliferation, and hence slightly reduces α (see inset of Fig.17). Since, in this case, boundary readjustment needs two update time steps and occurs with probability p_d , $\alpha(t)$ is given by

$$\alpha(t) = \frac{N_1(t-1)(1+p_d) - p_d/2}{N(t)}. \quad (42)$$

System size grows geometrically, i.e. $N(t) = N_0(1+p_d)^t$. Inserting this dependence into Eq. (42) and using $N_1(t-1) = \alpha(t-1)N(t-1)$, it follows that

$$\alpha(t) = \alpha(t-1) - \frac{p_d}{2N_0(1+p_d)^t}. \quad (43)$$

Recursively inserting for $\alpha(t-\tau)$ for $\tau \in \{1, \dots, t-1\}$, we conclude that $\alpha(t)$ is given by

$$\alpha(t) = \alpha_0 - \frac{p_d}{2N_0} \sum_{\tau=1}^t (1+p_d)^{-\tau} = \alpha_0 - \frac{1}{2N_0} \{1 - (1+p_d)^{-t}\} \quad (44)$$

This implies that the asymptotic boundary position in the limit $t \rightarrow \infty$ is independent from p_d :

$$\alpha_\infty = \alpha_0 - \frac{1}{2N_0} \quad (45)$$

Hence deviations at the order of $1/N_0$ from the boundary position $\alpha_0 = 0.281$ of non-growing systems are found.

For the case when noise is present, it is not possible to find a general solution since proliferation can affect both the velocity and the type of particles travelling through the domains in intricate ways (in the case of symmetric growth at the system boundaries, as discussed in the previous subsection, this problem is avoided). If p_d is very small, however, we can assume that proliferation events and particle propagation are essentially decoupled and that the system has enough time to relax to a stationary state between proliferation events³. In this limit, we can generalize Eqn. (35) in a straight-forward way:

$$2\alpha r_e + p_d = (1-\alpha)r_e, \quad (46)$$

leading to

$$\alpha = \frac{1}{3} \left(1 - \frac{p_d}{r_e} \right). \quad (47)$$

³Furthermore, one can show that single proliferation events that occur in or near quasi-particles have the same effect as certain subclasses of one-site errors as discussed in section 4. From this we conclude that - for moderate p_d - the statistics of boundary readjustments remains unchanged, just as it was found in section 4 for error rates $r_e < 1/2$.

$r_e = pN$ is a monotonously growing function in time for fixed error probability p , hence it follows that, for large t , the boundary position converges to the same value $\alpha = 1/3$ as for constant size systems.

References

- Albert, R., Othmer, H., 2003. The topology of the regulatory interactions predicts the expression pattern of the segment polarity genes in drosophila melanogaster. *J. Theor. Biol.* 223, 1–18.
- Augustin, R., Franke, A., Khalturin, K., Kiko, R., Hemmrich, S. S. G., Bosch, T. C., 2006. Dickkopf related genes are components of the positional value gradient in hydra. *Dev. Biol.* 296, 62–70.
- Bode, P. M., Bode, H. R., 1980. Formation of pattern in regenerating tissue pieces of hydra attenuata *1: I. head-body proportion regulation. *Dev. Biol.* 78, 484–496.
- Bornholdt, S., Rohlf, T., 2000. Topological evolution of dynamical networks: Global criticality from local dynamics. *Phys. Rev. Lett.* 84, 6114–6117.
- Bornholdt, S., Sneppen, K., 2000. Robustness as an evolutionary principle. *Proc. R. Soc. Lond. B* 267, 2281–2286.
- Bosch, T., 2003. Ancient signals: peptides and the interpretation of positional information in ancestral metazoans. *Comp. Biochem. and Physiol.* 136, 185.
- Bosch, T., Khalturin, K., 2002. Patterning and cell differentiation in hydra: novel genes and the limits to conservation. *Canadian Journal of Zoology* 80, 1670–1677.
- Crutchfield, J., Mitchell, M., 1995. The evolution of emergent computation. *Proc. Natl. Acad. Sci.* 92, 10742.
- David, C., Campbell, R., 1972. Cell cycle kinetics and development of hydra-attenuata. 1. epithelial cells. *J. Cell. Sci.* 11, 557.
- Davidich, M. I., Bornholdt, S., 2007. Boolean network model predicts cell cycle sequence of fission yeast. [arXiv:0704.2200v1](https://arxiv.org/abs/0704.2200v1).
- Davidson, E., 2001. *Genomic Regulatory Systems. Development and Evolution.* Academic Press.
- Furusawa, C., Kaneko, K., 2003. Robust development as a consequence of generated positional information. *J. Theor. Biol.* 224, 413–435.
- Furusawa, C. und Kaneko, K., 2000. Origin of complexity in multicellular organisms. *Phys. Rev. Lett.* 84, 6130–6133.

- Galle, J., Reibiger, I., Westermann, M., Richter, W., Lffler, S., 2002. Local cell membrane deformations due to receptor-ligand bonding as seen by reflection microscopy. *Cell Commun. Adhes.* 9, 161–172.
- Gierer, A., Berking, S., David, C., Flick, K., Hansman, G., Schaller, C., Trenkner, E., 1972. Regeneration of hydra from reaggregated cells. *Nature* 239, 98–101.
- Gierer, A., Meinhardt, H., 1972. A theory of biological pattern formation. *Kybernetik* 12, 30–39.
- Glass, L., 1973. The logical analysis of continuous, non-linear biochemical control networks. *J. Theor. Biol.* 39, 103–129.
- Grens, A., Gee, L., Fisher, D. A., Bode, H. R., 1996. Cnnk-2, an nk-2 homeobox gene, has a role in patterning the basal end of the axis in hydra. *Dev. Biol.* 180, 473–488.
- Gurdon, J., Bourillot, P., 2001. Morphogen gradient interpretation. *Nature* 413, 797–803.
- Hogeweg, P., 2000. Evolving mechanisms of morphogenesis: on the interplay between differential adhesion and cell differentiation. *J. Theor. Biol.* 203, 317–333.
- Holcman, D., Kasatkin, V., Prochiantz, A., 2007. Modeling homeoprotein intercellular transfer unveils a parsimonious mechanism for gradient and boundary formation in early brain development. *J. Theor. Biol.* 249, 503–517.
- Holland, J., 1975. *Adaptation in natural and artificial systems.* University of Michigan Press, Ann Arbor.
- Jackson, E., Johnson, D., Nash, W., 1986. Gene networks in development. *J. Theor. Biol.* 119, 379–396.
- Kaloulis, K., 2000. Molecular basis of morphogenetic events in hydra: Study of the creb and hedgehog pathways during budding and regeneration. Ph. d. thesis, Facult des sciences de l’Universit de Genve.
- Kasatkin, V., Prochiantz, A., Holcman, D., 2007. Morphogenetic gradients and the stability of boundaries between neighboring morphogenetic regions. *Bull. Math. Biol.* 70, 156–178.
- Kauffman, S., 1969. Metabolic stability and epigenesis in randomly constructed genetic nets. *J. Theor. Biol.* 22, 437–467.
- Kauffman, S., 1993. *The Origins of Order: Self-Organization and Selection in Evolution.* Oxford University Press.
- Kürten, K., 1988. Critical phenomena in model neural networks. *Phys. Lett. A* 129, 156–160.

- Li, F., Long, T., Lu, Y., Quyang, Q., Tang, C., 2004. The yeast cell-cycle network is robustly designed. *Proc. Natl. Acad. Sci. USA* 101(14), 4781–4786.
- McCluskey, E., 1956. Minimization of boolean functions. *Bell Syst. Techn. J.* 35, 1417–1444.
- Meinhardt, H., Gierer, A., 2000. Pattern formation by local self-activation and lateral inhibition. *BioEssays* 22, 753–760.
- Mitchell, M., Hraber, P., Crutchfield, J., 1994. Evolving cellular automata to perform computations: Mechanisms and impediments. *Physica D* 75, 361–391.
- Monk, N. A. M., 1998. Restricted-range gradients and travelling fronts in a model of juxtacrine cell relay. *Bull. Math. Biol.* 60, 901–918.
- Owen, M., Sherratt, J., Wearing, H., 2000. Lateral induction by juxtacrine signaling is a new mechanism for pattern formation. *Dev. Biol.* 217, 54–61.
- Ozbudak, Pourquie, 2008. The vertebrate segmentation clock: the tip of the iceberg. *Curr. Opin. Genet. Dev.* 18, 317–323.
- Reilly, K. M., Melton, D. A., 1996. Short-range signaling by candidate morphogens of the $\text{tgf-}\beta$ family and evidence for a relay mechanism of induction. *Cell* 86, 743–754.
- Reinhardt, B., Brouna, M., Blitz, I. L., Bode, H. R., 2004. *Hybmp5-8b*, a *bmp5-8* orthologue, acts during axial patterning and tentacle formation in hydra. *Dev. Biol.* 267, 43–59.
- Rohlf, T., Bornholdt, S., 2002. Criticality in random threshold networks: Annealed approximation and beyond. *Physica A* 310, 245–259.
- Rohlf, T., Bornholdt, S., 2004a. Gene regulatory networks: A discrete model of dynamics and topological evolution. In: Deutsch, A., Howard, J., Falcke, M., Zimmermann, W. (Eds.), *Function and regulation of cellular systems: experiments and models*. Birkhäuser Basel.
- Rohlf, T., Bornholdt, S., 2004b. Self-organization of position information in a 2d cellular automata model of morphogenesis. In: Schaub, H., Detje, F., Brgemann, U. (Eds.), *The Logic of Artificial Life: Abstracting and Synthesizing the Principles of Living Systems (Proceedings of GWAL 2004, Bamberg, 14-16 April 2004)*. Akademische Verlagsgesellschaft, Berlin, pp. 104–110.
- Rohlf, T., Bornholdt, S., 2005. Self-organized pattern formation and noise-induced control from particle computation. *J. Stat. Mech.* 1, L12001.
- Salazar-Ciudad, I., Garcia-Fernandez, J., Sole, R., 2000. Gene networks capable of pattern formation: From induction to reaction-diffusion. *J. Theor. Biol.* 205.

- Schiliro, F., Forman, B., Javois, L., 1999. Interactions between the foot and bud patterning systems in *hydra vulgaris*. *Dev. Biol.* 209, 399–408.
- Slack, J., 1993. Embryonic induction. *Mech. Devel.* 41, 9100–9107.
- Sole, R., Salazar-Ciudad, I., Garcia-Fernandez, J., 2002. Common pattern formation, modularity and phase transitions in a gene network model of morphogenesis. *Physica A* 305, 640–654.
- Technau, U., Cramer, von Laue, C., Rentzsch, F., Luft, S., Hobmayer, B., Bode, H. R., Holstein, T. W., 2000. Parameters of self-organization in hydra aggregates. *Proc. Natl. Acad. Sci. U.S.A.* 97, 12127–12131.
- Thomsen, S. and Till, A., Beetz, C., Wittlieb, J., Khalturin, K., Bosch, T. C. G., 2004. Control of foot differentiation in hydra: in vitro evidence that the nk-2 homeobox factor *cnk-2* autoregulates its own expression and uses *pedibin* as target gene. *Mech. Dev.* 121(2), 195–204.
- Turing, A., 1952. The chemical basis of morphogenesis. *Phil. Trans. Roy. Soc. Lond. B* 237, 37–72.
- von Dassow, G., Meir, E., Muro, E., Odell, G., 2000. The segment polarity network is a robust developmental module. *Nature* 406, 188–192.
- Wagner, A., 1994. Evolution of gene networks by gene duplications: A mathematical model and its implications on genome organization. *Proc. Natl. Acad. Sci.* 91, 4387–4391.
- Wearing, H., Owen, M. R., Sherratt, J. A., 2000. Mathematical modelling of juxtacrine patterning. *Bull. Math. Biol.* 62, 293–320.
- Wolfram, S., 1983. Statistical mechanics of cellular automata. *Rev. Mod. Phys.* 55, 601.
- Wolfram, S., 1984a. Cellular automata as models of complexity. *Nature* 311, 419.
- Wolfram, S., 1984b. Universality and complexity in cellular automata. *Physica D* 10, 1.
- Wolpert, L., 1969. Positional information and the spatial pattern of cellular differentiation. *J. Theor. Biol.* 25, 1–47.