

Toolbox

Karl Schlechta

June 22, 2021

Contents

1	Algebraic part	11
1.0.1	ToolBase1-Alg	11
1.0.2	Definition Alg-Base	11
1.0.3	Definition Rel-Base	11
1.0.4	Definition Tree-Base	12
1.0.5	Definition Seq-Base	12
1.0.6	Lemma Abs-Rel-Ext	12
1.0.7	Lemma Abs-Rel-Ext Proof	13
2	Logical rules	14
2.0.8	ToolBase1-Log	14
2.1	Logics: Base	14
2.1.1	ToolBase1-Log-Base	14
2.1.2	Definition Log-Base	14
2.1.3	Fact Log-Base	15
2.1.4	Fact Th-Union	15
2.1.5	Fact Th-Union Proof	15
2.1.6	Fact Log-Form	16
2.1.7	Fact Log-Form Proof	16
2.2	Logics: Definability	17
2.2.1	ToolBase1-Log-Dp	17
2.2.2	Fact Dp-Base	17
2.2.3	Fact Dp-Base Proof	17
2.2.4	Example Not-Def	18
2.2.5	Definition Def-Clos	18
2.2.6	Fact Def-Clos	18
2.2.7	Fact Def-Clos Proof	19
2.2.8	Fact Mod-Int	20
2.2.9	Fact Mod-Int Proof	20
2.3	Logics: Rules	21
2.3.1	ToolBase1-Log-Rules	21
2.3.2	Definition Log-Cond	21

2.3.3	Definition Log-Cond-Ref-Size	24
2.3.4	Definition Log-Cond-Ref	27
2.3.5	Fact Mu-Base	28
2.3.6	Fact Mu-Base Proof	29
2.3.7	Example Mu-Cum-Cd	32
2.3.8	Example Need-Pr	32
2.3.9	Example Mu-Barbar	32
2.3.10	Example Mu-Equal	33
2.3.11	Example Mu-Epsilon	34
2.3.12	Fact Mwor	35
2.3.13	Fact Mwor Proof	35
2.3.14	Proposition Alg-Log	35
2.3.15	Proposition Alg-Log Proof	37
2.3.16	Example Rank-Dp	40
2.3.17	Fact Cut-Pr	41
2.3.18	Fact Cut-Pr Proof	41
3	General and smooth preferential structures	43
3.0.19	ToolBase1-Pref	43
3.0.20	ToolBase1-Pref-Base	43
3.1	General and smooth: Basics	43
3.1.1	Definition Pref-Str	43
3.1.2	Definition Pref-Log	44
3.1.3	Example NeedCopies	45
3.1.4	Definition Smooth	45
3.1.5	ToolBase1-Rank-Base	46
3.1.6	Fact Rank-Base	46
3.1.7	Definition Rank-Rel	46
3.2	General and smooth: Summary	47
3.2.1	ToolBase1-Pref-ReprSumm	47
3.2.2	Proposition Pref-Representation-With-Ref	47
3.2.3	Proposition Pref-Representation-Without-Ref	48
3.2.4	Fact Pref-Sound	49
3.2.5	Fact Pref-Sound Proof	50
3.2.6	Fact Smooth-Sound	50
3.2.7	Fact Smooth-Sound Proof	50
3.2.8	Example Pref-Dp	50
3.3	General: Representation	52
3.3.1	ToolBase1-Pref-ReprGen	52
3.3.2	Proposition Pref-Complete	52
3.3.3	Proposition Pref-Complete Proof	52
3.3.4	Definition Y-Pi-x	52

3.3.5	Claim Mu-f	53
3.3.6	Claim Mu-f Proof	53
3.3.7	Construction Pref-Base	53
3.3.8	Claim Pref-Rep-Base	53
3.3.9	Claim Pref-Rep-Base Proof	54
3.3.10	Proposition Pref-Complete-Trans	55
3.3.11	Proposition Pref-Complete-Trans Proof	55
3.3.12	Discussion Pref-Trans	55
3.3.12.1	Discussion Pref-Trans	55
3.3.13	Example Trans-1	56
3.3.14	Construction Pref-Trees	57
3.3.15	Fact Pref-Trees	57
3.3.16	Claim Tree-Repres-1	58
3.3.17	Claim Tree-Repres-1 Proof	58
3.3.18	Claim Tree-Repres-2	59
3.3.19	Claim Tree-Repres-2 Proof	59
3.3.20	Proposition Equiv-Trans	59
3.3.21	Proposition Equiv-Trans Proof	60
3.4	Smooth: Representation	61
3.4.1	ToolBase1-Pref-ReprSmooth	61
3.4.2	Proposition Smooth-Complete	61
3.4.3	Proposition Smooth-Complete Proof	61
3.4.4	Comment Smooth-Complete Proof	61
3.4.5	Comment HU	62
3.4.5.1	The constructions	62
3.4.6	Definition HU	62
3.4.7	Definition K	62
3.4.8	Fact HU-1	63
3.4.9	Fact HU-1 Proof	63
3.4.10	Fact HU-2	63
3.4.11	Fact HU-2 Proof	64
3.4.12	Definition Gamma-x	64
3.4.13	Remark Gamma-x	65
3.4.14	Remark Gamma-x Proof	65
3.4.15	Claim Cum-Mu-f	65
3.4.16	Claim Cum-Mu-f Proof	66
3.4.17	Construction Smooth-Base	66
3.4.18	Claim Smooth-Base	67
3.4.19	Claim Smooth-Base Proof	67
3.4.20	Construction Smooth-Admiss	67
3.4.21	Claim Smooth-Admiss-1	68
3.4.22	Claim Smooth-Admiss-1 Proof	68

3.4.23	Claim Smooth-Admiss-2	69
3.4.24	Claim Smooth-Admiss-2 Proof	69
3.4.25	Proposition Smooth-Complete-Trans	71
3.4.26	Proposition Smooth-Complete-Trans Proof	71
3.4.27	Discussion Smooth-Trans	71
	3.4.27.1 Discussion Smooth-Trans	71
3.4.28	Definition Tree-TC	72
3.4.29	Construction Smooth-Tree	73
3.4.30	Fact Smooth-Tree	73
3.4.31	Fact Smooth-Tree Proof	74
3.4.32	Proposition No-Norm	75
4	Ranked structures	76
	4.0.33 ToolBase1-Rank	76
4.1	Ranked: Basics	76
	4.1.1 Fact Rank-Trans	76
	4.1.2 Fact Rank-Trans Proof	76
	4.1.3 Fact Rank-Auxil	76
	4.1.4 Fact Rank-Auxil Proof	77
	4.1.5 Remark RatM=	77
	4.1.6 Fact Rank-Hold	77
	4.1.7 Fact Rank-Hold Proof	78
4.2	Ranked: Representation	79
	4.2.1 ToolBase1-Rank-Repr	79
	4.2.1.1 (1) Results for structures without copies	79
	4.2.2 Proposition Rank-Rep1	79
	4.2.2.1 (2) Results for structures possibly with copies	79
	4.2.3 Definition 1-infin	79
	4.2.4 Lemma 1-infin	80
	4.2.5 Lemma 1-infin Proof	80
	4.2.6 Fact Rank-No-Rep	81
	4.2.7 Fact Rank-No-Rep Proof	81
	4.2.8 Example Rank-Copies	81
	4.2.9 Proposition Rank-Rep2	82
	4.2.10 Proposition Rank-Rep3	82
	4.2.11 Proposition Rank-Rep3 Proof	83
5	Theory revision	84
	5.0.12 ToolBase1-TR	84
5.1	AGM revision	84
	5.1.1 ToolBase1-TR-AGM	84
	5.1.2 Definition AGM	84
	5.1.3 Remark TR-Rank	85

5.1.4	Proposition AGM-Equiv	86
5.1.5	Intuit-Entrench	86
5.2	Distance based revision: Basics	88
5.2.1	ToolBase1-TR-DistBase	88
5.2.2	Definition Distance	88
5.2.3	Definition Dist-Indiv-Coll	88
5.2.4	Definition Dist-Repr	89
5.2.5	Definition TR*d	89
5.3	Distance based revision: Representation	89
5.3.1	ToolBase1-TR-DistRepr	89
5.3.2	Fact AGM-In-Dist	90
5.3.3	Fact AGM-In-Dist Proof	90
5.3.4	Definition TR-Umgeb	91
5.3.5	Fact TR-Umgeb	91
5.3.6	Fact TR-Umgeb Proof	91
5.3.7	Definition TR-Dist	92
5.3.8	Definition TR-Dist-Rotate	92
5.3.9	Proposition TR-Alg-Log	93
5.3.10	Proposition TR-Alg-Log Proof	94
5.3.11	Proposition TR-Representation-With-Ref	95
5.3.12	Example TR-Dp	95
5.3.13	Proposition TR-Alg-Repr	96
5.3.14	Proposition TR-Log-Repr	96
5.3.15	Example WeakTR	97
5.3.16	Proposition Hamster	98
6	Size	100
6.1	100
6.1.1	ToolBase1-Size	100
6.1.2	Definition Filter	100
6.1.3	Definition Filter2	101
6.1.4	New notations:	103
6.1.5	Algebra of size:	104
6.1.6	Remarks:	104
6.1.7	Remark Ref-Class	105
6.1.8	Fact R-down	106
6.1.9	Fact R-down Proof	106
6.1.10	Proposition Ref-Class-Mu	106
6.1.11	Proposition Ref-Class-Mu Proof	107
6.1.12	Definition Nabla	108
6.1.13	Definition N-Model	109
6.1.14	Definition NablaAxioms	109

6.1.15	Proposition NablaRepr	109
6.1.15.1	Extension to normal defaults with prerequisites	110
6.1.16	Definition Nabla-System	110
6.1.17	Definition N-Model-System	110
6.1.18	Definition NablaAxioms-System	110
6.1.19	Proposition NablaRepr-System	111
6.1.20	Size-Bib	111
7	IBRS	112
7.1	112
7.1.1	ToolBase1-IBRS	112
7.1.2	Motivation IBRS	112
7.1.3	Definition IBRS	113
7.1.4	Comment IBRS	114
7.2	IBRS as abstraction	114
7.2.1	IBRS as abstraction	114
7.2.2	Reac-Sem	116
7.3	Introduction	116
7.3.1	Reac-Sem-Intro	116
7.4	Formal definition	117
7.4.1	Reac-Sem-Def	117
7.5	A circuit semantics for simple IBRS without labels	118
7.5.1	Reac-Sem-Circuit	118
8	Generalized preferential structures	122
8.1	122
8.1.1	ToolBase1-HigherPref	122
8.1.2	Comment Gen-Pref	122
8.1.3	Definition Generalized preferential structure	122
8.1.4	Definition Level-n-Arrow	122
8.1.5	Example Inf-Level	123
8.1.6	Definition Valid-Arrow	123
8.1.7	Fact Higher-Validity	124
8.1.8	Fact Higher-Validity Proof	124
8.1.8.1	Proof Fact Higher-Validity	124
8.1.9	Definition Higher-Mu	125
8.1.10	Comment Smooth-Gen	125
8.1.11	Definition X-Sub-X'	126
8.1.12	Remark X-Sub-X'	126
8.1.13	Fact X-Sub-X'	128
8.1.14	Fact X-Sub-X' Proof	128
8.1.14.1	Proof Fact $X - Sub - X'$	128
8.1.15	Definition Totally-Smooth	129

8.1.16	Example Totally-Smooth	130
8.1.17	Example Need-Smooth	130
8.1.18	Definition Essentially-Smooth	130
8.1.19	Example Total-vs-Essential	131
9	New remarks	131
10	Main table	132
11	Comments	134
11.1	Regularities	134
11.2	The position of RatMon:	134
12	Coherent systems	134
13	Ideals, filters, and logical rules	136
13.1	There are infinitely many new rules	136
14	Facts about \mathcal{M}	137
14.0.1	Fact R-down-neu	137
14.0.2	Fact R-down-neu Proof	137
15	Equivalences between size and logic	138
15.0.3	Proposition Ref-Class-Mu-neu	138
15.0.4	Proposition Ref-Class-Mu-neu Proof	138
16	Strength of (AND)	140
17	Div.	144
17.0.5	Plausibility Logic	144
17.1	Plausibility Logic	144
17.1.0.1	Discussion of plausibility logic	144
17.1.0.2	The details:	144
17.1.1	Arieli-Avron	146
17.2	A comment on work by Arieli and Avron	146
17.2.1	Comment Cum-Union	147
17.2.2	Definition Cum-Alpha	147
17.2.3	Note Cum-Alpha	148
17.2.3.1	Note	148
17.2.4	Definition HU-All	149
17.2.5	Definition St-Tree	149
17.2.6	Example Inf-Cum-Alpha	150
17.2.6.1	The base set and the relation \prec :	150
17.2.6.2	The generators:	151
17.2.6.3	Intersections:	151

17.2.6.4	Validity of (μCUM):	152
17.2.6.5	($\mu Cumt\alpha$) hold for $\alpha < \kappa$:	152
17.2.6.6	($\mu Cum\kappa$) fails:	153
17.2.7	Fact Cum-Alpha	153
17.2.8	Fact Cum-Alpha Proof	154
17.2.9	Fact Cum-Alpha-HU	156
17.2.10	Fact Cum-Alpha-HU Proof	156
17.2.11	Fact HU	157
17.2.12	Fact HU Proof	158

18 Validity 159

18.0.13	Introduction Path-Validity	159
18.0.13.1	Introduction to Path-Validity	159
18.0.14	Definition Gen-Path	159
18.0.15	Definition Arrow-Origin	160
18.0.16	Definition Path-Validity	160
18.0.17	Remark Path-Validity	162
18.0.18	Diagram I-U-reac-x	163
18.0.19	Diagram I-U-reac-x	163
18.0.20	Diagram I-U-reac-c	164
18.0.21	Diagram I-U-reac-c	164
18.0.22	Diagram U-D-reactive	165
18.0.23	Diagram U-D-reactive	165
18.0.24	Diagram Dov-Is-2	166
18.0.25	Diagram Dov-Is-2	166
18.0.26	Diagram Dov-Is-1	167
18.0.27	Diagram Dov-Is-1	167
18.0.28	Diagram CJ-O2	168
18.0.29	Diagram CJ-O2	168
18.0.30	Diagram CJ-O1	169
18.0.31	Diagram CJ-O1	169
18.0.32	Diagram FunnyRule	170
18.0.33	Diagram FunnyRule	170
18.0.34	Diagram External2	171
18.0.35	Diagram External2	171
18.0.36	Diagram External	172
18.0.37	Diagram External	172
18.0.38	Diagram Internal	173
18.0.39	Diagram Internal	173
18.0.40	Diagram InherUniv	174
18.0.41	Diagram InherUniv	174
18.0.42	Diagram Now-1	175

18.0.43	Diagram Now-1	175
18.0.44	Diagram Now-2	176
18.0.45	Diagram Now-2	176
18.0.46	Diagram IBRS	177
18.0.47	Diagram IBRS	177
18.0.48	Diagram Pischinger	178
18.0.49	Diagram Pischinger	178
18.0.50	Diagram ReacA	179
18.0.51	Diagram ReacA	179
18.0.52	Diagram ReacB	180
18.0.53	Diagram ReacB	180
18.0.54	Diagram CumSem	181
18.0.55	Diagram CumSem	181
18.0.56	Diagram Eta-Rho-1	182
18.0.57	Diagram Eta-Rho-1	182
18.0.58	Diagram Structure-rho-eta	183
18.0.59	Diagram Structure-rho-eta	183
18.0.60	Diagram Gate-Sem	184
18.0.61	Diagram Gate Semantics	184
18.0.62	Diagram A-Ranked	186
18.0.63	Diagram A-Ranked	186
18.0.64	Diagram C-Validity	187
18.0.65	Diagram C-Validity	187
18.0.66	Diagram IBRS-Base	188
18.0.67	Diagram IBRS-Base	188
18.0.68	Diagram Essential-Smooth-Repr	190
18.0.69	Diagram Essential Smooth Repr	190
18.0.70	Diagram Essential-Smooth-2-1-2	192
18.0.71	Diagram Essential Smooth 2-1-2	192
18.0.72	Diagram Essential-Smooth-3-1-2	193
18.0.73	Diagram Essential Smooth 3-1-2	193
18.0.74	Diagram Essential-Smooth-3-2	194
18.0.75	Diagram Essential Smooth 3-2	194
18.0.76	Diagram Essential-Smooth-2-2	195
18.0.77	Diagram Essential Smooth 2-2	195
18.0.78	Diagram Condition-rho-eta	196
18.0.79	Diagram Condition rho-eta	196
18.0.80	Diagram Struc-old-rho-eta	197
18.0.81	Diagram Struc-old-rho-eta	197
18.0.82	Diagram Smooth-Level-3	198
18.0.83	Diagram Smooth Level-3	198
18.0.84	Diagram Tweety	199

18.0.85	Diagram Tweety	199
18.0.86	Diagram Nixon Diamond	200
18.0.87	Diagram Nixon Diamond	200
18.0.88	Diagram The complicated case	201
18.0.89	Diagram The complicated case	201
18.0.90	Diagram Upward vs. downward chaining	202
18.0.91	Diagram Upward vs. downward chaining	202
18.0.92	Diagram Split vs. total validity preclusion	203
18.0.93	Diagram Split vs. total validity preclusion	203
18.0.94	Diagram Information transfer	204
18.0.95	Diagram Information transfer	204
18.0.96	Diagram Multiple and conflicting information	205
18.0.97	Diagram Multiple and conflicting information	205
18.0.98	Diagram Valid paths vs. valid conclusions	206
18.0.99	Diagram Valid paths vs. valid conclusions	206
18.0.100	Diagram WeakTR	207
18.0.101	Diagram WeakTR	207
18.0.102	Diagram CumSmall	208
18.0.103	Diagram CumSmall	208

References

209

1 Algebraic part

1.0.1 ToolBase1-Alg

karl-search= Start ToolBase1-Alg

LABEL: Section Toolbase1-Alg

1.0.2 Definition Alg-Base

karl-search= Start Definition Alg-Base

Definition 1.1

(+++ Orig. No.: Definition Alg-Base +++)

LABEL: Definition Alg-Base

We use \mathcal{P} to denote the power set operator, $\Pi\{X_i : i \in I\} := \{g : g : I \rightarrow \bigcup\{X_i : i \in I\}, \forall i \in I. g(i) \in X_i\}$ is the general cartesian product, $card(X)$ shall denote the cardinality of X , and V the set-theoretic universe we work in - the class of all sets. Given a set of pairs \mathcal{X} , and a set X , we denote by $\mathcal{X}[X := \{ \langle x, i \rangle \in \mathcal{X} : x \in X \}$. When the context is clear, we will sometime simply write X for $\mathcal{X}[X$. (The intended use is for preferential structures, where x will be a point (intention: a classical propositional model), and i an index, permitting copies of logically identical points.)

$A \subseteq B$ will denote that A is a subset of B or equal to B , and $A \subset B$ that A is a proper subset of B , likewise for $A \supseteq B$ and $A \supset B$.

Given some fixed set U we work in, and $X \subseteq U$, then $C(X) := U - X$.

If $\mathcal{Y} \subseteq \mathcal{P}(X)$ for some X , we say that \mathcal{Y} satisfies

- (\cap) iff it is closed under finite intersections,
- (\bigcap) iff it is closed under arbitrary intersections,
- (\cup) iff it is closed under finite unions,
- (\bigcup) iff it is closed under arbitrary unions,
- (\mathcal{C}) iff it is closed under complementation,
- ($-$) iff it is closed under set difference.

We will sometimes write $A = B \parallel C$ for: $A = B$, or $A = C$, or $A = B \cup C$.

We make ample and tacit use of the Axiom of Choice.

karl-search= End Definition Alg-Base

1.0.3 Definition Rel-Base

karl-search= Start Definition Rel-Base

Definition 1.2

(+++ Orig. No.: Definition Rel-Base +++)

LABEL: Definition Rel-Base

\prec^* will denote the transitive closure of the relation \prec . If a relation $<$, \prec , or similar is given, $a \perp b$ will express that a and b are $< -$ (or $\prec -$) incomparable - context will tell. Given any relation $<$, \leq will stand for $<$ or $=$, conversely, given \leq , $<$ will stand for \leq , but not $=$, similarly for \prec etc.

karl-search= End Definition Rel-Base

1.0.4 Definition Tree-Base

karl-search= Start Definition Tree-Base

Definition 1.3

(+++ Orig. No.: Definition Tree-Base +++)

LABEL: Definition Tree-Base

A child (or successor) of an element x in a tree t will be a direct child in t . A child of a child, etc. will be called an indirect child. Trees will be supposed to grow downwards, so the root is the top element.

karl-search= End Definition Tree-Base

1.0.5 Definition Seq-Base

karl-search= Start Definition Seq-Base

Definition 1.4

(+++ Orig. No.: Definition Seq-Base +++)

LABEL: Definition Seq-Base

A subsequence $\sigma_i : i \in I \subseteq \mu$ of a sequence $\sigma_i : i \in \mu$ is called cofinal, iff for all $i \in \mu$ there is $i' \in I$ $i \leq i'$.

Given two sequences σ_i and τ_i of the same length, then their Hamming distance is the quantity of i where they differ.

karl-search= End Definition Seq-Base

karl-search= End ToolBase1-Alg

1.0.6 Lemma Abs-Rel-Ext

karl-search= Start Lemma Abs-Rel-Ext

We give a generalized abstract nonsense result, taken from [LMS01], which must be part of the folklore:

Lemma 1.1

(+++ Orig. No.: Lemma Abs-Rel-Ext +++)

LABEL: Lemma Abs-Rel-Ext

Given a set X and a binary relation R on X , there exists a total preorder (i.e. a total, reflexive, transitive relation) S on X that extends R such that

$$\forall x, y \in X (xSy, ySx \Rightarrow xR^*y)$$

where R^* is the reflexive and transitive closure of R .

karl-search= End Lemma Abs-Rel-Ext

1.0.7 Lemma Abs-Rel-Ext Proof

karl-search= Start Lemma Abs-Rel-Ext Proof

Proof

(+++*** Orig.: Proof)

Define $x \equiv y$ iff xR^*y and yR^*x . The relation \equiv is an equivalence relation. Let $[x]$ be the equivalence class of x under \equiv . Define $[x] \preceq [y]$ iff xR^*y . The definition of \preceq does not depend on the representatives x and y chosen. The relation \preceq on equivalence classes is a partial order. Let \leq be any total order on these equivalence classes that extends \preceq . Define xSy iff $[x] \leq [y]$. The relation S is total (since \leq is total) and transitive (since \leq is transitive) and is therefore a total preorder. It extends R by the definition of \preceq and the fact that \leq extends \preceq . Suppose now xSy and ySx . We have $[x] \leq [y]$ and $[y] \leq [x]$ and therefore $[x] = [y]$ by antisymmetry. Therefore $x \equiv y$ and xR^*y . \square

karl-search= End Lemma Abs-Rel-Ext Proof

2 Logical rules

2.0.8 ToolBase1-Log

karl-search= Start ToolBase1-Log

LABEL: Section Toolbase1-Log

2.1 Logics: Base

2.1.1 ToolBase1-Log-Base

karl-search= Start ToolBase1-Log-Base

LABEL: Section Toolbase1-Log-Base

2.1.2 Definition Log-Base

karl-search= Start Definition Log-Base

Definition 2.1

(+++ Orig. No.: Definition Log-Base +++)

LABEL: Definition Log-Base

We work here in a classical propositional language \mathcal{L} , a theory T will be an arbitrary set of formulas. Formulas will often be named ϕ, ψ , etc., theories T, S , etc.

$v(\mathcal{L})$ will be the set of propositional variables of \mathcal{L} .

$M_{\mathcal{L}}$ will be the set of (classical) models for \mathcal{L} , $M(T)$ or M_T is the set of models of T , likewise $M(\phi)$ for a formula ϕ .

$\mathbf{D}_{\mathcal{L}} := \{M(T) : T \text{ a theory in } \mathcal{L}\}$, the set of definable model sets.

Note that, in classical propositional logic, $\emptyset, M_{\mathcal{L}} \in \mathbf{D}_{\mathcal{L}}$, $\mathbf{D}_{\mathcal{L}}$ contains singletons, is closed under arbitrary intersections and finite unions.

An operation $f : \mathcal{Y} \rightarrow \mathcal{P}(M_{\mathcal{L}})$ for $\mathcal{Y} \subseteq \mathcal{P}(M_{\mathcal{L}})$ is called definability preserving, (dp) or (μdp) in short, iff for all $X \in \mathbf{D}_{\mathcal{L}} \cap \mathcal{Y}$ $f(X) \in \mathbf{D}_{\mathcal{L}}$.

We will also use (μdp) for binary functions $f : \mathcal{Y} \times \mathcal{Y} \rightarrow \mathcal{P}(M_{\mathcal{L}})$ - as needed for theory revision - with the obvious meaning.

\vdash will be classical derivability, and

$\overline{T} := \{\phi : T \vdash \phi\}$, the closure of T under \vdash .

$Con(\cdot)$ will stand for classical consistency, so $Con(\phi)$ will mean that ϕ is classical consistent, likewise for $Con(T)$. $Con(T, T')$ will stand for $Con(T \cup T')$, etc.

Given a consequence relation \vdash , we define

$\overline{\overline{T}} := \{\phi : T \vdash \phi\}$.

(There is no fear of confusion with \overline{T} , as it just is not useful to close twice under classical logic.)

$T \vee T' := \{\phi \vee \phi' : \phi \in T, \phi' \in T'\}$.

If $X \subseteq M_{\mathcal{L}}$, then $Th(X) := \{\phi : X \models \phi\}$, likewise for $Th(m)$, $m \in M_{\mathcal{L}}$. (\models will usually be classical validity.)

karl-search= End Definition Log-Base

2.1.3 Fact Log-Base

karl-search= Start Fact Log-Base

We recollect and note:

Fact 2.1

(+++ Orig. No.: Fact Log-Base +++)

LABEL: Fact Log-Base

Let \mathcal{L} be a fixed propositional language, $D_{\mathcal{L}} \subseteq X$, $\mu : X \rightarrow \mathcal{P}(M_{\mathcal{L}})$, for a \mathcal{L} -theory T $\overline{\overline{T}} := Th(\mu(M_T))$, let T, T' be arbitrary theories, then:

- (1) $\mu(M_T) \subseteq M_{\overline{\overline{T}}}$,
- (2) $M_T \cup M_{T'} = M_{T \vee T'}$ and $M_{T \cup T'} = M_T \cap M_{T'}$,
- (3) $\mu(M_T) = \emptyset \leftrightarrow \perp \in \overline{\overline{T}}$.

If μ is definability preserving or $\mu(M_T)$ is finite, then the following also hold:

- (4) $\mu(M_T) = M_{\overline{\overline{T}}}$,
- (5) $T' \vdash \overline{\overline{T}} \leftrightarrow M_{T'} \subseteq \mu(M_T)$,
- (6) $\mu(M_T) = M_{T'} \leftrightarrow \overline{\overline{T'}} = \overline{\overline{T}}$. \square

karl-search= End Fact Log-Base

2.1.4 Fact Th-Union

karl-search= Start Fact Th-Union

Fact 2.2

(+++ Orig. No.: Fact Th-Union +++)

LABEL: Fact Th-Union

Let $A, B \subseteq M_{\mathcal{L}}$.

Then $Th(A \cup B) = Th(A) \cap Th(B)$.

karl-search= End Fact Th-Union

2.1.5 Fact Th-Union Proof

karl-search= Start Fact Th-Union Proof

Proof

(+++*** Orig.: Proof)

$\phi \in Th(A \cup B) \Leftrightarrow A \cup B \models \phi \Leftrightarrow A \models \phi$ and $B \models \phi \Leftrightarrow \phi \in Th(A)$ and $\phi \in Th(B)$.

□

karl-search= End Fact Th-Union Proof

karl-search= End Log-Base

2.1.6 Fact Log-Form

karl-search= Start Fact Log-Form

Fact 2.3

(+++ Orig. No.: Fact Log-Form +++)

LABEL: Fact Log-Form

Let $X \subseteq M_{\mathcal{L}}$, ϕ, ψ formulas.

- (1) $X \cap M(\phi) \models \psi$ iff $X \models \phi \rightarrow \psi$.
- (2) $X \cap M(\phi) \models \psi$ iff $M(Th(X)) \cap M(\phi) \models \psi$.
- (3) $Th(X \cap M(\phi)) = \overline{Th(X) \cup \{\phi\}}$
- (4) $X \cap M(\phi) = \emptyset \Leftrightarrow M(Th(X)) \cap M(\phi) = \emptyset$
- (5) $Th(M(T) \cap M(T')) = \overline{T \cup T'}$.

karl-search= End Fact Log-Form

2.1.7 Fact Log-Form Proof

karl-search= Start Fact Log-Form Proof

Proof

(+++*** Orig.: Proof)

- (1) “ \Rightarrow ”: $X = (X \cap M(\phi)) \cup (X \cap M(\neg\phi))$. In both parts holds $\neg\phi \vee \psi$, so $X \models \phi \rightarrow \psi$. “ \Leftarrow ”: Trivial.
- (2) $X \cap M(\phi) \models \psi$ (by (1)) iff $X \models \phi \rightarrow \psi$ iff $M(Th(X)) \models \phi \rightarrow \psi$ iff (again by (1)) $M(Th(X)) \cap M(\phi) \models \psi$.
- (3) $\psi \in Th(X \cap M(\phi)) \Leftrightarrow X \cap M(\phi) \models \psi \Leftrightarrow_{(2)} M(Th(X) \cup \{\phi\}) = M(Th(X)) \cap M(\phi) \models \psi \Leftrightarrow Th(X) \cup \{\phi\} \vdash \psi$.
- (4) $X \cap M(\phi) = \emptyset \Leftrightarrow X \models \neg\phi \Leftrightarrow M(Th(X)) \models \neg\phi \Leftrightarrow M(Th(X)) \cap M(\phi) = \emptyset$.
- (5) $M(T) \cap M(T') = M(T \cup T')$.

□

karl-search= End Fact Log-Form Proof

karl-search= End ToolBase1-Log-Base

2.2 Logics: Definability

2.2.1 ToolBase1-Log-Dp

karl-search= Start ToolBase1-Log-Dp

LABEL: Section Toolbase1-Log-Dp

2.2.2 Fact Dp-Base

karl-search= Start Fact Dp-Base

Fact 2.4

(+++ Orig. No.: Fact Dp-Base +++)

LABEL: Fact Dp-Base

If $X = M(T)$, then $M(Th(X)) = X$.

karl-search= End Fact Dp-Base

2.2.3 Fact Dp-Base Proof

karl-search= Start Fact Dp-Base Proof

Proof

(+++*** Orig.: Proof)

$X \subseteq M(Th(X))$ is trivial. $Th(M(T)) = \overline{T}$ is trivial by classical soundness and completeness. So $M(Th(M(T))) = M(\overline{T}) = M(T) = X$. \square

karl-search= End Fact Dp-Base Proof

2.2.4 Example Not-Def

karl-search= Start Example Not-Def

Example 2.1

(+++ Orig. No.: Example Not-Def +++)

LABEL: Example Not-Def

If $v(\mathcal{L})$ is infinite, and m any model for \mathcal{L} , then $M := M_{\mathcal{L}} - \{m\}$ is not definable by any theory T . (Proof: Suppose it were, and let ϕ hold in M , but not in m , so in $m \neg\phi$ holds, but as ϕ is finite, there is a model m' in M which coincides on all propositional variables of ϕ with m , so in $m' \neg\phi$ holds, too, a contradiction.) Thus, in the infinite case, $\mathcal{P}(M_{\mathcal{L}}) \neq \mathbf{D}_{\mathcal{L}}$.

(There is also a simple cardinality argument, which shows that almost no model sets are definable, but it is not constructive and thus less instructive than above argument. We give it nonetheless: Let $\kappa := \text{card}(v(\mathcal{L}))$. Then there are κ many formulas, so 2^κ many theories, and thus 2^κ many definable model sets. But there are 2^κ many models, so $(2^\kappa)^\kappa$ many model sets.)

□

karl-search= End Example Not-Def

2.2.5 Definition Def-Clos

karl-search= Start Definition Def-Clos

Definition 2.2

(+++ Orig. No.: Definition Def-Clos +++)

LABEL: Definition Def-Clos

Let $\mathcal{Y} \subseteq \mathcal{P}(Z)$ be given and closed under arbitrary intersections.

For $A \subseteq Z$, let $\widehat{A} := \bigcap \{X \in \mathcal{Y} : A \subseteq X\}$.

Intuitively, Z is the set of all models for \mathcal{L} , \mathcal{Y} is $\mathbf{D}_{\mathcal{L}}$, and $\widehat{A} = M(\text{Th}(A))$, this is the intended application.

Note that then $\widehat{\emptyset} = \emptyset$.

karl-search= End Definition Def-Clos

2.2.6 Fact Def-Clos

karl-search= Start Fact Def-Clos

Fact 2.5

(+++ Orig. No.: Fact Def-Clos +++)

LABEL: Fact Def-Clos

(1) If $\mathcal{Y} \subseteq \mathcal{P}(Z)$ is closed under arbitrary intersections and finite unions, $Z \in \mathcal{Y}$, $X, Y \subseteq Z$, then the following hold:

$$(Cl \cup) \widehat{X \cup Y} = \widehat{X} \cup \widehat{Y}$$

$$(Cl \cap) \widehat{X \cap Y} \subseteq \widehat{X} \cap \widehat{Y}, \text{ but usually not conversely,}$$

$$(Cl -) \widehat{A - B} \subseteq \widehat{A - B},$$

$$(Cl =) X = Y \rightarrow \widehat{X} = \widehat{Y}, \text{ but not conversely,}$$

$$(Cl \subseteq 1) \widehat{X} \subseteq Y \rightarrow X \subseteq Y, \text{ but not conversely,}$$

$$(Cl \subseteq 2) X \subseteq \widehat{Y} \rightarrow \widehat{X} \subseteq \widehat{Y}.$$

(2) If, in addition, $X \in \mathcal{Y}$ and $\mathbf{C}X := Z - X \in \mathcal{Y}$, then the following two properties hold, too:

$$(Cl \cap +) \widehat{A} \cap X = \widehat{A \cap X},$$

$$(Cl - +) \widehat{A} - X = \widehat{A - X}.$$

(3) In the intended application, i.e. $\widehat{A} = M(Th(A))$, the following hold:

$$(3.1) Th(X) = Th(\widehat{X}),$$

$$(3.2) \text{ Even if } A = \widehat{A}, B = \widehat{B}, \text{ it is not necessarily true that } \widehat{A - B} \subseteq \widehat{A} - \widehat{B}.$$

karl-search= End Fact Def-Clos

2.2.7 Fact Def-Clos Proof

karl-search= Start Fact Def-Clos Proof

Proof

(+++*** Orig.: Proof)

$(Cl =)$, $(Cl \subseteq 1)$, $(Cl \subseteq 2)$, (3.1) are trivial.

$(Cl \cup)$ Let $\mathcal{Y}(U) := \{X \in \mathcal{Y} : U \subseteq X\}$. If $A \in \mathcal{Y}(X \cup Y)$, then $A \in \mathcal{Y}(X)$ and $A \in \mathcal{Y}(Y)$, so $\widehat{X \cup Y} \supseteq \widehat{X} \cup \widehat{Y}$.

If $A \in \mathcal{Y}(X)$ and $B \in \mathcal{Y}(Y)$, then $A \cup B \in \mathcal{Y}(X \cup Y)$, so $\widehat{X \cup Y} \subseteq \widehat{A \cup B} \subseteq \widehat{X} \cup \widehat{B}$.

$(Cl \cap)$ Let $X', Y' \in \mathcal{Y}$, $X \subseteq X'$, $Y \subseteq Y'$, then $X \cap Y \subseteq X' \cap Y'$, so $\widehat{X \cap Y} \subseteq \widehat{X' \cap Y'}$. For the converse, set $X := M_{\mathcal{L}} - \{m\}$, $Y := \{m\}$ in Example 2.1 (page 18).

$(Cl -)$ Let $A - B \subseteq X \in \mathcal{Y}$, $B \subseteq Y \in \mathcal{Y}$, so $A \subseteq X \cup Y \in \mathcal{Y}$. Let $x \notin \widehat{B} \Rightarrow \exists Y \in \mathcal{Y}(B \subseteq Y, x \notin Y)$, $x \notin \widehat{A - B} \Rightarrow \exists X \in \mathcal{Y}(A - B \subseteq X, x \notin X)$, so $x \notin X \cup Y$, $A \subseteq X \cup Y$, so $x \notin \widehat{A}$. Thus, $x \notin \widehat{B}$, $x \notin \widehat{A - B} \Rightarrow x \notin \widehat{A}$, or $x \in \widehat{A} - \widehat{B} \Rightarrow x \in \widehat{A - B}$.

$(Cl \cap +)$ $\widehat{A} \cap X \supseteq \widehat{A \cap X}$ by $(Cl \cap)$. For " \subseteq ": Let $A \cap X \subseteq A' \in \mathcal{Y}$, then by closure under (\cup) , $A \subseteq A' \cup \mathbf{C}X \in \mathcal{Y}$, $(A' \cup \mathbf{C}X) \cap X \subseteq A'$. So $\widehat{A} \cap X \subseteq \widehat{A \cap X}$.

$(Cl - +)$ $\widehat{A - X} = \widehat{A \cap \mathbf{C}X} = \widehat{A} \cap \mathbf{C}X = \widehat{A} - X$ by $(Cl \cap +)$.

(3.2) Set $A := M_{\mathcal{L}}$, $B := \{m\}$ for $m \in M_{\mathcal{L}}$ arbitrary, \mathcal{L} infinite. So $A = \widehat{A}$, $B = \widehat{B}$, but $\widehat{A - B} = A \neq A - B$.

□

karl-search= End Fact Def-Clos Proof

2.2.8 Fact Mod-Int

karl-search= Start Fact Mod-Int

Fact 2.6

(+++ Orig. No.: Fact Mod-Int +++)

LABEL: Fact Mod-Int

Let $X, Y, Z \in M_{\mathcal{L}}$.

(1) $X \subseteq Y \cap Z \Rightarrow \overline{Th(Y) \cup Th(Z)} \subseteq Th(X)$

(2) If $X = Y \cap Z$ and $Y = M(T), Z = M(T')$, then $\overline{Th(Y) \cup Th(Z)} = Th(X)$.

karl-search= End Fact Mod-Int

2.2.9 Fact Mod-Int Proof

karl-search= Start Fact Mod-Int Proof

Proof

(+++*** Orig.: Proof)

Let $\widehat{X} := M(Th(X))$.

(1) $X \subseteq Y \cap Z \Rightarrow \widehat{X} \subseteq \widehat{Y \cap Z} \subseteq \widehat{Y} \cap \widehat{Z}$ by Fact 2.5 (page 18) (Cl \cap). So $M(Th(X)) \subseteq M(Th(Y)) \cap M(Th(Z)) = M(\overline{Th(Y) \cup Th(Z)})$, so $\overline{Th(Y) \cup Th(Z)} \subseteq \overline{Th(X)} = Th(X)$.

(2) $\widehat{Y \cap Z} = \widehat{M(T) \cap M(T')} = \widehat{M(T \cup T')} = M(T \cup T') = M(T) \cap M(T') = \widehat{M(T)} \cap \widehat{M(T')} = \widehat{Y} \cap \widehat{Z}$.
Finish as for (1).

□

karl-search= End Fact Mod-Int Proof

karl-search= End ToolBase1-Log-Dp

2.3 Logics: Rules

2.3.1 ToolBase1-Log-Rules

karl-search= Start ToolBase1-Log-Rules

LABEL: Section Toolbase1-Log-Rules

2.3.2 Definition Log-Cond

karl-search= Start Definition Log-Cond

Definition 2.3

(+++ Orig. No.: Definition Log-Cond +++)

LABEL: Definition Log-Cond

We introduce here formally a list of properties of set functions on the algebraic side, and their corresponding logical rules on the other side.

Recall that $\overline{T} := \{\phi : T \vdash \phi\}$, $\overline{\overline{T}} := \{\phi : T \vdash \sim \phi\}$, where \vdash is classical consequence, and $\vdash \sim$ any other consequence.

We show, wherever adequate, in parallel the formula version in the left column, the theory version in the middle column, and the semantical or algebraic counterpart in the right column. The algebraic counterpart gives conditions for a function $f : \mathcal{Y} \rightarrow \mathcal{P}(U)$, where U is some set, and $\mathcal{Y} \subseteq \mathcal{P}(U)$.

Precise connections between the columns are given in Proposition 2.9 (page 35)

When the formula version is not commonly used, we omit it, as we normally work only with the theory version.

A and B in the right hand side column stand for $M(\phi)$ for some formula ϕ , whereas X, Y stand for $M(T)$ for some theory T .

Basics		
(AND) $\phi \vdash \psi, \phi \vdash \psi' \Rightarrow$ $\phi \vdash \psi \wedge \psi'$	(AND) $T \vdash \psi, T \vdash \psi' \Rightarrow$ $T \vdash \psi \wedge \psi'$	Closure under finite intersection
(OR) $\phi \vdash \psi, \phi' \vdash \psi \Rightarrow$ $\phi \vee \phi' \vdash \psi$	(OR) $\overline{\overline{T}} \cap \overline{\overline{T'}} \subseteq \overline{\overline{T \vee T'}}$	(μ OR) $f(X \cup Y) \subseteq f(X) \cup f(Y)$
(wOR) $\phi \vdash \psi, \phi' \vdash \psi \Rightarrow$ $\phi \vee \phi' \vdash \psi$	(wOR) $\overline{\overline{T}} \cap \overline{\overline{T'}} \subseteq \overline{\overline{T \vee T'}}$	(μ wOR) $f(X \cup Y) \subseteq f(X) \cup Y$
(disjOR) $\phi \vdash \neg \phi', \phi \vdash \psi,$ $\phi' \vdash \psi \Rightarrow \phi \vee \phi' \vdash \psi$	(disjOR) $\neg \text{Con}(T \cup T') \Rightarrow$ $\overline{\overline{T}} \cap \overline{\overline{T'}} \subseteq \overline{\overline{T \vee T'}}$	(μ disjOR) $X \cap Y = \emptyset \Rightarrow$ $f(X \cup Y) \subseteq f(X) \cup f(Y)$
(LLE) Left Logical Equivalence $\vdash \phi \leftrightarrow \phi', \phi \vdash \psi \Rightarrow$ $\phi' \vdash \psi$	(LLE) $\overline{\overline{T}} = \overline{\overline{T'}} \Rightarrow \overline{\overline{T}} = \overline{\overline{T'}}$	trivially true
(RW) Right Weakening $\phi \vdash \psi, \vdash \psi \rightarrow \psi' \Rightarrow$ $\phi \vdash \psi'$	(RW) $T \vdash \psi, \vdash \psi \rightarrow \psi' \Rightarrow$ $T \vdash \psi'$	upward closure
(CCL) Classical Closure	(CCL) $\overline{\overline{T}}$ is classically closed	trivially true
(SC) Supraclassicality $\phi \vdash \psi \Rightarrow \phi \vdash \psi$	(SC) $\overline{\overline{T}} \subseteq \overline{\overline{T}}$	($\mu \subseteq$) $f(X) \subseteq X$
(REF) Reflexivity $T \cup \{\alpha\} \vdash \alpha$		
(CP) Consistency Preservation $\phi \vdash \perp \Rightarrow \phi \vdash \perp$	(CP) $T \vdash \perp \Rightarrow T \vdash \perp$	($\mu \emptyset$) $f(X) = \emptyset \Rightarrow X = \emptyset$
		($\mu \emptyset \text{fin}$) $X \neq \emptyset \Rightarrow f(X) \neq \emptyset$ for finite X
$\overline{\overline{\phi \wedge \phi'}} \subseteq \overline{\overline{\phi}} \cup \overline{\overline{\phi'}}$	(PR) $\overline{\overline{T \cup T'}} \subseteq \overline{\overline{\overline{\overline{T}} \cup \overline{\overline{T'}}}}$	(μ PR) $X \subseteq Y \Rightarrow$ $f(Y) \cap X \subseteq f(X)$
		(μ PR') $f(X) \cap Y \subseteq f(X \cap Y)$
(CUT) $T \vdash \alpha; T \cup \{\alpha\} \vdash \beta \Rightarrow$ $T \vdash \beta$	(CUT) $T \subseteq \overline{\overline{T'}} \subseteq \overline{\overline{T}} \Rightarrow$ $\overline{\overline{T'}} \subseteq \overline{\overline{T}}$	(μ CUT) $f(X) \subseteq Y \subseteq X \Rightarrow$ $f(X) \subseteq f(Y)$

Cumulativity		
(<i>CM</i>) Cautious Monotony $\phi \vdash \psi, \phi \vdash \psi' \Rightarrow$ $\phi \wedge \psi \vdash \psi'$	(<i>CM</i>) $T \subseteq \overline{T'} \subseteq \overline{\overline{T}} \Rightarrow$ $\overline{\overline{T}} \subseteq \overline{\overline{T'}}$	(μ <i>CM</i>) $f(X) \subseteq Y \subseteq X \Rightarrow$ $f(Y) \subseteq f(X)$
or (<i>ResM</i>) Restricted Monotony $T \vdash \alpha, \beta \Rightarrow T \cup \{\alpha\} \vdash \beta$		(μ <i>ResM</i>) $f(X) \subseteq A \cap B \Rightarrow f(X \cap A) \subseteq B$
(<i>CUM</i>) Cumulativity $\phi \vdash \psi \Rightarrow$ $(\phi \vdash \psi' \Leftrightarrow \phi \wedge \psi \vdash \psi')$	(<i>CUM</i>) $T \subseteq \overline{T'} \subseteq \overline{\overline{T}} \Rightarrow$ $\overline{\overline{T}} = \overline{\overline{T'}}$	(μ <i>CUM</i>) $f(X) \subseteq Y \subseteq X \Rightarrow$ $f(Y) = f(X)$
	($\subseteq \supseteq$) $T \subseteq \overline{\overline{T'}}, T' \subseteq \overline{\overline{T}} \Rightarrow$ $\overline{\overline{T'}} = \overline{\overline{T}}$	($\mu \subseteq \supseteq$) $f(X) \subseteq Y, f(Y) \subseteq X \Rightarrow$ $f(X) = f(Y)$
Rationality		
(<i>RatM</i>) Rational Monotony $\phi \vdash \psi, \phi \not\vdash \neg\psi' \Rightarrow$ $\phi \wedge \psi' \vdash \psi$	(<i>RatM</i>) $Con(T \cup \overline{\overline{T'}}), T \vdash T' \Rightarrow$ $\overline{\overline{T}} \supseteq \overline{\overline{T'}} \cup T$	(μ <i>RatM</i>) $X \subseteq Y, X \cap f(Y) \neq \emptyset \Rightarrow$ $f(X) \subseteq f(Y) \cap X$
	(<i>RatM</i> =) $Con(T \cup \overline{\overline{T'}}), T \vdash T' \Rightarrow$ $\overline{\overline{T}} = \overline{\overline{T'}} \cup T$	(μ =) $X \subseteq Y, X \cap f(Y) \neq \emptyset \Rightarrow$ $f(X) = f(Y) \cap X$
	(<i>Log</i> =') $Con(\overline{\overline{T'}} \cup T) \Rightarrow$ $\overline{\overline{T}} \cup \overline{\overline{T'}} = \overline{\overline{T'}} \cup T$	(μ =') $f(Y) \cap X \neq \emptyset \Rightarrow$ $f(Y \cap X) = f(Y) \cap X$
	(<i>Log</i>) $\overline{\overline{T}} \cup \overline{\overline{T'}}$ is one of $\overline{\overline{T}},$ or $\overline{\overline{T'}}$, or $\overline{\overline{T}} \cap \overline{\overline{T'}}$ (by (CCL))	(μ) $f(X \cup Y)$ is one of $f(X), f(Y)$ or $f(X) \cup f(Y)$
	(<i>Log</i> \cup) $Con(\overline{\overline{T'}} \cup T), \neg Con(\overline{\overline{T'}} \cup \overline{\overline{T}}) \Rightarrow$ $\neg Con(\overline{\overline{T}} \cup \overline{\overline{T'}})$	($\mu \cup$) $f(Y) \cap (X - f(X)) \neq \emptyset \Rightarrow$ $f(X \cup Y) \cap Y = \emptyset$
	(<i>Log</i> \cup') $Con(\overline{\overline{T'}} \cup T), \neg Con(\overline{\overline{T'}} \cup \overline{\overline{T}}) \Rightarrow$ $\overline{\overline{T}} \cup \overline{\overline{T'}} = \overline{\overline{T}}$	($\mu \cup'$) $f(Y) \cap (X - f(X)) \neq \emptyset \Rightarrow$ $f(X \cup Y) = f(X)$
		($\mu \in$) $a \in X - f(X) \Rightarrow$ $\exists b \in X. a \notin f(\{a, b\})$

(*PR*) is also called infinite conditionalization - we choose the name for its central role for preferential structures (*PR*) or (μ *PR*).

The system of rules (*AND*) (*OR*) (*LLE*) (*RW*) (*SC*) (*CP*) (*CM*) (*CUM*) is also called system *P* (for preferential), adding (*RatM*) gives the system *R* (for rationality or rankedness).

Roughly: Smooth preferential structures generate logics satisfying system *P*, ranked structures logics satisfying system *R*.

A logic satisfying (*REF*), (*ResM*), and (*CUT*) is called a consequence relation.

(*LLE*) and (*CCL*) will hold automatically, whenever we work with model sets.

(*AND*) is obviously closely related to filters, and corresponds to closure under finite intersections. (*RW*) corresponds to upward closure of filters.

More precisely, validity of both depend on the definition, and the direction we consider.

Given f and ($\mu \subseteq$), $f(X) \subseteq X$ generates a principal filter: $\{X' \subseteq X : f(X) \subseteq X'\}$, with the definition: If $X = M(T)$, then $T \vdash \phi$ iff $f(X) \subseteq M(\phi)$. Validity of (*AND*) and (*RW*) are then trivial.

Conversely, we can define for $X = M(T)$

$$\mathcal{X} := \{X' \subseteq X : \exists \phi (X' = X \cap M(\phi) \text{ and } T \vdash \phi)\}.$$

(*AND*) then makes \mathcal{X} closed under finite intersections, (*RW*) makes \mathcal{X} upward closed. This is in the infinite case usually not yet a filter, as not all subsets of X need to be definable this way. In this case, we complete \mathcal{X} by adding all X'' such that there is $X' \subseteq X'' \subseteq X$, $X' \in \mathcal{X}$.

Alternatively, we can define

$$\mathcal{X} := \{X' \subseteq X : \bigcap \{X \cap M(\phi) : T \vdash \phi\} \subseteq X'\}.$$

(*SC*) corresponds to the choice of a subset.

(*CP*) is somewhat delicate, as it presupposes that the chosen model set is non-empty. This might fail in the presence of ever better choices, without ideal ones; the problem is addressed by the limit versions.

(*PR*) is an infinitary version of one half of the deduction theorem: Let T stand for ϕ , T' for ψ , and $\phi \wedge \psi \vdash \sigma$, so $\phi \vdash \psi \rightarrow \sigma$, but $(\psi \rightarrow \sigma) \wedge \psi \vdash \sigma$.

(*CUM*) (whose more interesting half in our context is (*CM*)) may best be seen as normal use of lemmas: We have worked hard and found some lemmas. Now we can take a rest, and come back again with our new lemmas. Adding them to the axioms will neither add new theorems, nor prevent old ones to hold.

karl-search= End Definition Log-Cond

2.3.3 Definition Log-Cond-Ref-Size

karl-search= Start Definition Log-Cond-Ref-Size

LABEL: Definition Log-Cond-Ref-Size

The numbers refer to Proposition 2.9 (page 35) .

Logical rule		Correspondence	Model set	Correspondence	Size	Size-Rule
Basics						
(SC) Supraclassicality $\phi \vdash \psi \Rightarrow \phi \sim \psi$	(SC) $\overline{T} \subseteq \overline{\overline{T}}$	\Rightarrow (4.1) \Leftarrow (4.2)	($\mu \subseteq$) $f(X) \subseteq X$			(Opt)
(REF) Reflexivity $T \cup \{\alpha\} \sim \alpha$						
(LLE) Left Logical Equivalence $\vdash \phi \leftrightarrow \phi', \phi \sim \psi \Rightarrow \phi' \sim \psi$	(LLE) $\overline{T} = \overline{T'} \Rightarrow \overline{\overline{T}} = \overline{\overline{T'}}$					
(RW) Right Weakening $\phi \sim \psi, \vdash \psi \rightarrow \psi' \Rightarrow \phi \sim \psi'$	(RW) $T \sim \psi, \vdash \psi \rightarrow \psi' \Rightarrow T \sim \psi'$				+	(iM)
(wOR) $\phi \sim \psi, \phi' \vdash \psi \Rightarrow \phi \vee \phi' \sim \psi$	(wOR) $\overline{\overline{T}} \cap \overline{\overline{T'}} \subseteq \overline{\overline{T \vee T'}}$	\Rightarrow (3.1) \Leftarrow (3.2)	(μwOR) $f(X \cup Y) \subseteq f(X) \cup Y$		+	(eMT)
(disjOR) $\phi \vdash \neg \phi', \phi \sim \psi, \phi' \sim \psi \Rightarrow \phi \vee \phi' \sim \psi$	(disjOR) $\neg Con(T \cup T') \Rightarrow \overline{\overline{T}} \cap \overline{\overline{T'}} \subseteq \overline{\overline{T \vee T'}}$	\Rightarrow (2.1) \Leftarrow (2.2)	($\mu disjOR$) $X \cap Y = \emptyset \Rightarrow f(X \cup Y) \subseteq f(X) \cup f(Y)$		\approx	(I \cup disj)
(CP) Consistency Preservation $\phi \sim \perp \Rightarrow \phi \vdash \perp$	(CP) $T \sim \perp \Rightarrow T \vdash \perp$	\Rightarrow (5.1) \Leftarrow (5.2)	($\mu \emptyset$) $f(X) = \emptyset \Rightarrow X = \emptyset$ ($\mu \emptyset fin$) $X \neq \emptyset \Rightarrow f(X) \neq \emptyset$ for finite X		1 * s	(I ₁)
					1 * s	(I ₁)
	(AND ₁) $\alpha \sim \beta \Rightarrow \alpha \not\sim \neg \beta$				2 * s	(I ₂)
	(AND _n) $\alpha \sim \beta_1, \dots, \alpha \sim \beta_{n-1} \Rightarrow \alpha \not\sim (\neg \beta_1 \vee \dots \vee \neg \beta_{n-1})$				n * s	(I _n)
(AND) $\phi \sim \psi, \phi \sim \psi' \Rightarrow \phi \sim \psi \wedge \psi'$	(AND) $T \sim \psi, T \sim \psi' \Rightarrow T \sim \psi \wedge \psi'$				ω * s	(I _{ω})
(CCL) Classical Closure	(CCL) $\overline{\overline{T}}$ classically closed				ω * s	(iM) + (I _{ω})
(OR) $\phi \sim \psi, \phi' \sim \psi \Rightarrow \phi \vee \phi' \sim \psi$	(OR) $\overline{\overline{T}} \cap \overline{\overline{T'}} \subseteq \overline{\overline{T \vee T'}}$	\Rightarrow (1.1) \Leftarrow (1.2)	(μOR) $f(X \cup Y) \subseteq f(X) \cup f(Y)$		ω * s	(eMT) + (I _{ω})
$\overline{\overline{\phi \wedge \phi'}} \subseteq \overline{\overline{\phi \cup \{\phi'\}}}$	$\overline{\overline{T \cup T'}} \subseteq \overline{\overline{T \cup T'}}$	\Rightarrow (6.1)	(μPR) $X \subseteq Y \Rightarrow f(Y) \cap X \subseteq f(X)$		ω * s	(eMT) + (I _{ω})
		\Leftarrow (μdp) + (μ ⊆) (6.2)				
		\neq without (μdp) (6.3)				
		\Leftarrow (μ ⊆) (6.4) T' a formula				
		\Leftarrow (6.5) T' a formula				
(CUT) $T \sim \alpha; T \cup \{\alpha\} \sim \beta \Rightarrow T \sim \beta$	(CUT) $T \subseteq \overline{\overline{T'}} \subseteq \overline{\overline{T}} \Rightarrow \overline{\overline{T'}} \subseteq \overline{\overline{T}}$	\Rightarrow (7.1) \Leftarrow (7.2)	(μCUT) $f(X) \cap Y \subseteq f(X \cap Y)$ $f(X) \subseteq Y \subseteq X \Rightarrow f(X) \subseteq f(Y)$		ω * s	(eMT) + (I _{ω})

Logical rule	Correspondence	Model set	Correspondence	Size	Size-Rule
Cumulativity					
(wCM) $\alpha \sim \beta, \alpha \vdash \beta' \Rightarrow \alpha \wedge \beta' \sim \beta$					(eMF)
(CM_2) $\alpha \sim \beta, \alpha \sim \beta' \Rightarrow \alpha \wedge \beta \not\sim \neg\beta'$				$2 * s$	(I_2)
(CM_n) $\alpha \sim \beta_1, \dots, \alpha \sim \beta_n \Rightarrow$ $\alpha \wedge \beta_1 \wedge \dots \wedge \beta_{n-1} \not\sim \neg\beta_n$				$n * s$	(I_n)
(CM) Cautious Monotony $\phi \sim \psi, \phi \vdash \psi' \Rightarrow$ $\phi \wedge \psi \sim \psi'$	(CM) $T \subseteq \overline{T'} \subseteq \overline{\overline{T}} \Rightarrow$ $\overline{\overline{T}} \subseteq \overline{\overline{T}}$	\Rightarrow (8.1) \Leftarrow (8.2)	(μCM) $f(X) \subseteq Y \subseteq X \Rightarrow$ $f(Y) \subseteq f(X)$	$\omega * s$	(I_ω)
or $(ResM)$ Restricted Monotony $T \vdash \alpha, \beta \Rightarrow T \cup \{\alpha\} \vdash \beta$		\Rightarrow (9.1) \Leftarrow (9.2)	$(\mu ResM)$ $f(X) \subseteq A \cap B \Rightarrow f(X \cap A) \subseteq B$		
(CUM) Cumulativity $\phi \sim \psi \Rightarrow$ $(\phi \sim \psi' \Leftrightarrow \phi \wedge \psi \sim \psi')$	(CUM) $T \subseteq \overline{T'} \subseteq \overline{\overline{T}} \Rightarrow$ $\overline{\overline{T}} = \overline{\overline{T'}}$	\Rightarrow (11.1) \Leftarrow (11.2)	(μCUM) $f(X) \subseteq Y \subseteq X \Rightarrow$ $f(Y) = f(X)$		
	$(\subseteq \supseteq)$ $T \subseteq \overline{\overline{T'}}, T' \subseteq \overline{\overline{T}} \Rightarrow$ $\overline{\overline{T}} = \overline{\overline{T'}}$	\Rightarrow (10.1) \Leftarrow (10.2)	$(\mu \subseteq \supseteq)$ $f(X) \subseteq Y, f(Y) \subseteq X \Rightarrow$ $f(X) = f(Y)$		
Rationality					
$(RatM)$ Rational Monotony $\phi \sim \psi, \phi \not\sim \neg\psi' \Rightarrow$ $\phi \wedge \psi' \sim \psi$	$(RatM)$ $Con(T \cup \overline{\overline{T'}}), T \vdash T' \Rightarrow$ $\overline{\overline{T}} \supseteq \overline{\overline{T'}} \cup T$	\Rightarrow (12.1) \Leftarrow (μdp) (12.2) \neq without (μdp) (12.3) $\Leftarrow T$ a formula (12.4)	$(\mu RatM)$ $X \subseteq Y, X \cap f(Y) \neq \emptyset \Rightarrow$ $f(X) \subseteq f(Y) \cap X$		(\mathcal{M}^{++})
	$(RatM =)$ $Con(T \cup \overline{\overline{T'}}), T \vdash T' \Rightarrow$ $\overline{\overline{T}} = \overline{\overline{T'}} \cup T$	\Rightarrow (13.1) \Leftarrow (μdp) (13.2) \neq without (μdp) (13.3) $\Leftarrow T$ a formula (13.4)	$(\mu =)$ $X \subseteq Y, X \cap f(Y) \neq \emptyset \Rightarrow$ $f(X) = f(Y) \cap X$		
	$(Log =')$ $Con(\overline{\overline{T'}} \cup T) \Rightarrow$ $\overline{\overline{T}} \cup \overline{\overline{T'}} = \overline{\overline{T}} \cup T$	\Rightarrow (14.1) \Leftarrow (μdp) (14.2) \neq without (μdp) (14.3) $\Leftarrow T$ a formula (14.4)	$(\mu =')$ $f(Y) \cap X \neq \emptyset \Rightarrow$ $f(Y \cap X) = f(Y) \cap X$		
	$(Log \parallel)$ $\overline{\overline{T}} \vee \overline{\overline{T'}}$ is one of $\overline{\overline{T}},$ or $\overline{\overline{T'}}$, or $\overline{\overline{T}} \cap \overline{\overline{T'}}$ (by (CCL))	\Rightarrow (15.1) \Leftarrow (15.2)	$(\mu \parallel)$ $f(X \cup Y)$ is one of $f(X), f(Y)$ or $f(X) \cup f(Y)$		
	$(Log \cup)$ $Con(\overline{\overline{T'}} \cup T), \neg Con(\overline{\overline{T'}} \cup \overline{\overline{T}}) \Rightarrow$ $\neg Con(\overline{\overline{T}} \vee \overline{\overline{T'}} \cup T')$	\Rightarrow $(\mu \subseteq) + (\mu =)$ (16.1) \Leftarrow (μdp) (16.2) \neq without (μdp) (16.3)	$(\mu \cup)$ $f(Y) \cap (X - f(X)) \neq \emptyset \Rightarrow$ $f(X \cup Y) \cap Y = \emptyset$		
	$(Log \cup')$ $Con(\overline{\overline{T'}} \cup T), \neg Con(\overline{\overline{T'}} \cup \overline{\overline{T}}) \Rightarrow$ $\overline{\overline{T}} \vee \overline{\overline{T'}} = \overline{\overline{T}}$	\Rightarrow $(\mu \subseteq) + (\mu =)$ (17.1) \Leftarrow (μdp) (17.2) \neq without (μdp) (17.3)	$(\mu \cup')$ $f(Y) \cap (X - f(X)) \neq \emptyset \Rightarrow$ $f(X \cup Y) = f(X)$		
			$(\mu \in)$ $a \in X - f(X) \Rightarrow$ $\exists b \in X. a \notin f(\{a, b\})$		

2.3.4 Definition Log-Cond-Ref

karl-search= Start Definition Log-Cond-Ref

LABEL: Definition Log-Cond-Ref

The numbers refer to Proposition 2.9 (page 35) .

Basics			
(AND) $\phi \vdash \psi, \phi \vdash \psi' \Rightarrow$ $\phi \vdash \psi \wedge \psi'$	(AND) $T \vdash \psi, T \vdash \psi' \Rightarrow$ $T \vdash \psi \wedge \psi'$		Closure under finite intersection
(OR) $\phi \vdash \psi, \phi' \vdash \psi \Rightarrow$ $\phi \vee \phi' \vdash \psi$	(OR) $\overline{\overline{T}} \cap \overline{\overline{T'}} \subseteq \overline{\overline{T \vee T'}}$	\Rightarrow (1.1) \Leftarrow (1.2)	(μOR) $f(X \cup Y) \subseteq f(X) \cup f(Y)$
(wOR) $\phi \vdash \psi, \phi' \vdash \psi \Rightarrow$ $\phi \vee \phi' \vdash \psi$	(wOR) $\overline{\overline{T}} \cap \overline{\overline{T'}} \subseteq \overline{\overline{T \vee T'}}$	\Rightarrow (3.1) \Leftarrow (3.2)	(μwOR) $f(X \cup Y) \subseteq f(X) \cup Y$
$(disjOR)$ $\phi \vdash \neg \phi', \phi \vdash \psi,$ $\phi' \vdash \psi \Rightarrow \phi \vee \phi' \vdash \psi$	$(disjOR)$ $\neg Con(T \cup T') \Rightarrow$ $\overline{\overline{T}} \cap \overline{\overline{T'}} \subseteq \overline{\overline{T \vee T'}}$	\Rightarrow (2.1) \Leftarrow (2.2)	$(\mu disjOR)$ $X \cap Y = \emptyset \Rightarrow$ $f(X \cup Y) \subseteq f(X) \cup f(Y)$
(LLE) Left Logical Equivalence $\vdash \phi \leftrightarrow \phi', \phi \vdash \psi \Rightarrow$ $\phi' \vdash \psi$	(LLE) $\overline{\overline{T}} = \overline{\overline{T'}} \Rightarrow \overline{\overline{T}} = \overline{\overline{T'}}$		trivially true
(RW) Right Weakening $\phi \vdash \psi, \vdash \psi \rightarrow \psi' \Rightarrow$ $\phi \vdash \psi'$	(RW) $T \vdash \psi, \vdash \psi \rightarrow \psi' \Rightarrow$ $T \vdash \psi'$		upward closure
(CCL) Classical Closure	(CCL) $\overline{\overline{T}}$ is classically closed		trivially true
(SC) Supraclassicality $\phi \vdash \psi \Rightarrow \phi \vdash \psi$	(SC) $\overline{\overline{T}} \subseteq \overline{\overline{T}}$	\Rightarrow (4.1) \Leftarrow (4.2)	$(\mu \subseteq)$ $f(X) \subseteq X$
(REF) Reflexivity $T \cup \{\alpha\} \vdash \alpha$			
(CP) Consistency Preservation $\phi \vdash \perp \Rightarrow \phi \vdash \perp$	(CP) $T \vdash \perp \Rightarrow T \vdash \perp$	\Rightarrow (5.1) \Leftarrow (5.2)	$(\mu \emptyset)$ $f(X) = \emptyset \Rightarrow X = \emptyset$
			$(\mu \emptyset fin)$ $X \neq \emptyset \Rightarrow f(X) \neq \emptyset$ for finite X
$\overline{\overline{\phi \wedge \phi'}} \subseteq \overline{\overline{\phi \cup \{\phi'\}}}$	(PR) $\overline{\overline{T \cup T'}} \subseteq \overline{\overline{T \cup T'}}$	\Rightarrow (6.1) $\Leftarrow (\mu dp) + (\mu \subseteq)$ (6.2) \neq without (μdp) (6.3) $\Leftarrow (\mu \subseteq)$ (6.4) T' a formula \Leftarrow (6.5) T' a formula	(μPR) $X \subseteq Y \Rightarrow$ $f(Y) \cap X \subseteq f(X)$
(CUT) $T \vdash \alpha; T \cup \{\alpha\} \vdash \beta \Rightarrow$ $T \vdash \beta$	(CUT) $T \subseteq \overline{\overline{T'}} \subseteq \overline{\overline{T}} \Rightarrow$ $\overline{\overline{T'}} \subseteq \overline{\overline{T}}$	\Rightarrow (7.1) \Leftarrow (7.2)	$(\mu PR')$ $f(X) \cap Y \subseteq f(X \cap Y)$ (μCUT) $f(X) \subseteq Y \subseteq X \Rightarrow$ $f(X) \subseteq f(Y)$

Cumulativity		
(CM) Cautious Monotony $\phi \vdash \psi, \phi \vdash \psi' \Rightarrow$ $\phi \wedge \psi \vdash \psi'$	(CM) $T \subseteq \overline{T'} \subseteq \overline{\overline{T}} \Rightarrow$ $\overline{\overline{T}} \subseteq \overline{\overline{T'}}$	\Rightarrow (8.1)
		\Leftarrow (8.2)
or (ResM) Restricted Monotony $T \vdash \alpha, \beta \Rightarrow T \cup \{\alpha\} \vdash \beta$		\Rightarrow (9.1)
		\Leftarrow (9.2)
(CUM) Cumulativity $\phi \vdash \psi \Rightarrow$ $(\phi \vdash \psi' \Leftrightarrow \phi \wedge \psi \vdash \psi')$	(CUM) $T \subseteq \overline{T'} \subseteq \overline{\overline{T}} \Rightarrow$ $\overline{\overline{T}} = \overline{\overline{T'}}$	\Rightarrow (11.1)
		\Leftarrow (11.2)
	$(\subseteq \supseteq)$ $T \subseteq \overline{\overline{T'}}, T' \subseteq \overline{\overline{T}} \Rightarrow$ $\overline{\overline{T'}} = \overline{\overline{T}}$	\Rightarrow (10.1)
		\Leftarrow (10.2)
Rationality		
(RatM) Rational Monotony $\phi \vdash \psi, \phi \not\vdash \neg\psi' \Rightarrow$ $\phi \wedge \psi' \vdash \psi$	(RatM) $Con(T \cup \overline{\overline{T'}}), T \vdash T' \Rightarrow$ $\overline{\overline{T}} \supseteq \overline{\overline{T'}} \cup T$	\Rightarrow (12.1)
		\Leftarrow (μdp) (12.2)
		\neq without (μdp) (12.3)
		$\Leftarrow T$ a formula (12.4)
	(RatM =) $Con(T \cup \overline{\overline{T'}}), T \vdash T' \Rightarrow$ $\overline{\overline{T}} = \overline{\overline{T'}} \cup T$	\Rightarrow (13.1)
		\Leftarrow (μdp) (13.2)
		\neq without (μdp) (13.3)
		$\Leftarrow T$ a formula (13.4)
	(Log =') $Con(\overline{\overline{T'}} \cup T) \Rightarrow$ $\overline{\overline{T}} \cup \overline{\overline{T'}} = \overline{\overline{T'}} \cup T$	\Rightarrow (14.1)
		\Leftarrow (μdp) (14.2)
		\neq without (μdp) (14.3)
		$\Leftarrow T$ a formula (14.4)
	(Log) $\overline{\overline{T}} \vee \overline{\overline{T'}}$ is one of $\overline{\overline{T}},$ or $\overline{\overline{T'}}$, or $\overline{\overline{T}} \cap \overline{\overline{T'}}$ (by (CCL))	\Rightarrow (15.1)
		\Leftarrow (15.2)
	(Log \cup) $Con(\overline{\overline{T'}} \cup T), \neg Con(\overline{\overline{T'}} \cup \overline{\overline{T}}) \Rightarrow$ $\neg Con(\overline{\overline{T}} \vee \overline{\overline{T'}} \cup T')$	\Rightarrow ($\mu \subseteq$) + ($\mu =$) (16.1)
		\Leftarrow (μdp) (16.2)
		\neq without (μdp) (16.3)
	(Log \cup') $Con(\overline{\overline{T'}} \cup T), \neg Con(\overline{\overline{T'}} \cup \overline{\overline{T}}) \Rightarrow$ $\overline{\overline{T}} \vee \overline{\overline{T'}} = \overline{\overline{T}}$	\Rightarrow ($\mu \subseteq$) + ($\mu =$) (17.1)
		\Leftarrow (μdp) (17.2)
		\neq without (μdp) (17.3)
		$(\mu \in)$ $a \in X - f(X) \Rightarrow$ $\exists b \in X. a \notin f(\{a, b\})$

karl-search= End Definition Log-Cond-Ref

2.3.5 Fact Mu-Base

karl-search= Start Fact Mu-Base

Fact 2.7

(+++ Orig. No.: Fact Mu-Base +++)

LABEL: Fact Mu-Base

The following table is to be read as follows: If the left hand side holds for some function $f : \mathcal{Y} \rightarrow \mathcal{P}(U)$, and the auxiliary properties noted in the middle also hold for f or \mathcal{Y} , then the right hand side will hold, too - and conversely.

Basics			
(1.1)	(μPR)	$\Rightarrow (\cap) + (\mu \subseteq)$	$(\mu PR')$
(1.2)		\Leftarrow	
(2.1)	(μPR)	$\Rightarrow (\mu \subseteq)$	(μOR)
(2.2)		$\Leftarrow (\mu \subseteq) + (-)$	
(2.3)		$\Rightarrow (\mu \subseteq)$	(μwOR)
(2.4)		$\Leftarrow (\mu \subseteq) + (-)$	
(3)	(μPR)	\Rightarrow	(μCUT)
(4)	$(\mu \subseteq) + (\mu \subseteq \supseteq) + (\mu CUM) + (\mu RatM) + (\cap)$	$\not\Rightarrow$	(μPR)
Cumulativity			
(5.1)	(μCM)	$\Rightarrow (\cap) + (\mu \subseteq)$	$(\mu ResM)$
(5.2)		$\Leftarrow (\text{infin.})$	
(6)	$(\mu CM) + (\mu CUT)$	\Leftrightarrow	(μCUM)
(7)	$(\mu \subseteq) + (\mu \subseteq \supseteq)$	\Rightarrow	(μCUM)
(8)	$(\mu \subseteq) + (\mu CUM) + (\cap)$	\Rightarrow	$(\mu \subseteq \supseteq)$
(9)	$(\mu \subseteq) + (\mu CUM)$	$\not\Rightarrow$	$(\mu \subseteq \supseteq)$
Rationality			
(10)	$(\mu RatM) + (\mu PR)$	\Rightarrow	$(\mu =)$
(11)	$(\mu =)$	\Rightarrow	$(\mu PR),$
(12.1)	$(\mu =)$	$\Rightarrow (\cap) + (\mu \subseteq)$	$(\mu =')$,
(12.2)		\Leftarrow	
(13)	$(\mu \subseteq), (\mu =)$	$\Rightarrow (\cup)$	$(\mu \cup),$
(14)	$(\mu \subseteq), (\mu \emptyset), (\mu =)$	$\Rightarrow (\cup)$	$(\mu \parallel), (\mu \cup'), (\mu CUM),$
(15)	$(\mu \subseteq) + (\mu \parallel)$	$\Rightarrow (-)$ of \mathcal{Y}	$(\mu =),$
(16)	$(\mu \parallel) + (\mu \in) + (\mu PR) + (\mu \subseteq)$	$\Rightarrow (\cup) + \mathcal{Y}$ contains singletons	$(\mu =),$
(17)	$(\mu CUM) + (\mu =)$	$\Rightarrow (\cup) + \mathcal{Y}$ contains singletons	$(\mu \in),$
(18)	$(\mu CUM) + (\mu =) + (\mu \subseteq)$	$\Rightarrow (\cup)$	$(\mu \parallel),$
(19)	$(\mu PR) + (\mu CUM) + (\mu \parallel)$	\Rightarrow sufficient, e.g. true in $\mathbf{D}_{\mathcal{L}}$	$(\mu =).$
(20)	$(\mu \subseteq) + (\mu PR) + (\mu =)$	$\not\Rightarrow$	$(\mu \parallel),$
(21)	$(\mu \subseteq) + (\mu PR) + (\mu \parallel)$	$\not\Rightarrow$ (without $(-)$)	$(\mu =)$
(22)	$(\mu \subseteq) + (\mu PR) + (\mu \parallel) + (\mu =) + (\mu \cup)$	$\not\Rightarrow$	$(\mu \in)$ (thus not representability by ranked structures)

karl-search= End Fact Mu-Base

2.3.6 Fact Mu-Base Proof

karl-search= Start Fact Mu-Base Proof

Proof

(+++*** Orig.: Proof)

All sets are to be in \mathcal{Y} .

(1.1) $(\mu PR) + (\cap) + (\mu \subseteq) \Rightarrow (\mu PR')$:

By $X \cap Y \subseteq X$ and (μPR) , $f(X) \cap X \cap Y \subseteq f(X \cap Y)$. By $(\mu \subseteq)$ $f(X) \cap Y = f(X) \cap X \cap Y$.

(1.2) $(\mu PR') \Rightarrow (\mu PR)$:

Let $X \subseteq Y$, so $X = X \cap Y$, so by $(\mu PR')$ $f(Y) \cap X \subseteq f(X \cap Y) = f(X)$.

(2.1) $(\mu PR) + (\mu \subseteq) \Rightarrow (\mu OR)$:

$f(X \cup Y) \subseteq X \cup Y$ by $(\mu \subseteq)$, so $f(X \cup Y) = (f(X \cup Y) \cap X) \cup (f(X \cup Y) \cap Y) \subseteq f(X) \cup f(Y)$.

(2.2) $(\mu OR) + (\mu \subseteq) + (-) \Rightarrow (\mu PR)$:

Let $X \subseteq Y$, $X' := Y - X$. $f(Y) \subseteq f(X) \cup f(X')$ by (μOR) , so $f(Y) \cap X \subseteq (f(X) \cap X) \cup (f(X') \cap X) =_{(\mu \subseteq)} f(X) \cup \emptyset = f(X)$.

(2.3) $(\mu PR) + (\mu \subseteq) \Rightarrow (\mu wOR)$:

Trivial by (2.1).

(2.4) $(\mu wOR) + (\mu \subseteq) + (-) \Rightarrow (\mu PR)$:

Let $X \subseteq Y$, $X' := Y - X$. $f(Y) \subseteq f(X) \cup X'$ by (μwOR) , so $f(Y) \cap X \subseteq (f(X) \cap X) \cup (X' \cap X) =_{(\mu \subseteq)} f(X) \cup \emptyset = f(X)$.

(3) $(\mu PR) \Rightarrow (\mu CUT)$:

$f(X) \subseteq Y \subseteq X \Rightarrow f(X) \subseteq f(X) \cap Y \subseteq f(Y)$ by (μPR) .

(4) $(\mu \subseteq) + (\mu \subseteq \supseteq) + (\mu CUM) + (\mu RatM) + (\cap) \not\Rightarrow (\mu PR)$:

This is shown in Example 2.3 (page 32) .

(5.1) $(\mu CM) + (\cap) + (\mu \subseteq) \Rightarrow (\mu ResM)$:

Let $f(X) \subseteq A \cap B$, so $f(X) \subseteq A$, so by $(\mu \subseteq)$ $f(X) \subseteq A \cap X \subseteq X$, so by (μCM) $f(A \cap X) \subseteq f(X) \subseteq B$.

(5.2) $(\mu ResM) \Rightarrow (\mu CM)$:

We consider here the infinitary version, where all sets can be model sets of infinite theories. Let $f(X) \subseteq Y \subseteq X$, so $f(X) \subseteq Y \cap f(X)$, so by $(\mu ResM)$ $f(Y) = f(X \cap Y) \subseteq f(X)$.

(6) $(\mu CM) + (\mu CUT) \Leftrightarrow (\mu CUM)$:

Trivial.

(7) $(\mu \subseteq) + (\mu \subseteq \supseteq) \Rightarrow (\mu CUM)$:

Suppose $f(D) \subseteq E \subseteq D$. So by $(\mu \subseteq)$ $f(E) \subseteq E \subseteq D$, so by $(\mu \subseteq \supseteq)$ $f(D) = f(E)$.

(8) $(\mu \subseteq) + (\mu CUM) + (\cap) \Rightarrow (\mu \subseteq \supseteq)$:

Let $f(D) \subseteq E$, $f(E) \subseteq D$, so by $(\mu \subseteq)$ $f(D) \subseteq D \cap E \subseteq D$, $f(E) \subseteq D \cap E \subseteq E$. As $f(D \cap E)$ is defined, so $f(D) = f(D \cap E) = f(E)$ by (μCUM) .

(9) $(\mu \subseteq) + (\mu CUM) \not\Rightarrow (\mu \subseteq \supseteq)$:

This is shown in Example 2.2 (page 32) .

(10) $(\mu RatM) + (\mu PR) \Rightarrow (\mu =)$:

Trivial.

(11) $(\mu =)$ entails (μPR) :

Trivial.

(12.1) $(\mu =) \rightarrow (\mu =')$:

Let $f(Y) \cap X \neq \emptyset$, we have to show $f(X \cap Y) = f(Y) \cap X$. By $(\mu \subseteq)$ $f(Y) \subseteq Y$, so $f(Y) \cap X = f(Y) \cap (X \cap Y)$, so by $(\mu =)$ $f(Y) \cap X = f(Y) \cap (X \cap Y) = f(X \cap Y)$.

(12.2) $(\mu =') \rightarrow (\mu =)$:

Let $X \subseteq Y$, $f(Y) \cap X \neq \emptyset$, then $f(X) = f(Y \cap X) = f(Y) \cap X$.

(13) $(\mu \subseteq), (\mu =) \rightarrow (\mu \cup)$:

If not, $f(X \cup Y) \cap Y \neq \emptyset$, but $f(Y) \cap (X - f(X)) \neq \emptyset$. By (11), (μPR) holds, so $f(X \cup Y) \cap X \subseteq f(X)$, so $\emptyset \neq f(Y) \cap (X - f(X)) \subseteq f(Y) \cap (X - f(X \cup Y))$, so $f(Y) - f(X \cup Y) \neq \emptyset$, so by $(\mu \subseteq)$ $f(Y) \subseteq Y$ and $f(Y) \neq f(X \cup Y) \cap Y$. But by $(\mu =)$ $f(Y) = f(X \cup Y) \cap Y$, a contradiction.

(14)

$(\mu \subseteq), (\mu \emptyset), (\mu =) \Rightarrow (\mu \parallel)$:

If X or Y or both are empty, then this is trivial. Assume then $X \cup Y \neq \emptyset$, so by $(\mu \emptyset)$ $f(X \cup Y) \neq \emptyset$. By $(\mu \subseteq)$ $f(X \cup Y) \subseteq X \cup Y$, so $f(X \cup Y) \cap X = \emptyset$ and $f(X \cup Y) \cap Y = \emptyset$ together are impossible. Case 1, $f(X \cup Y) \cap X \neq \emptyset$ and $f(X \cup Y) \cap Y \neq \emptyset$: By $(\mu =)$ $f(X \cup Y) \cap X = f(X)$ and $f(X \cup Y) \cap Y = f(Y)$,

so by $(\mu \subseteq) f(X \cup Y) = f(X) \cup f(Y)$. Case 2, $f(X \cup Y) \cap X \neq \emptyset$ and $f(X \cup Y) \cap Y = \emptyset$: So by $(\mu =)$ $f(X \cup Y) = f(X \cup Y) \cap X = f(X)$. Case 3, $f(X \cup Y) \cap X = \emptyset$ and $f(X \cup Y) \cap Y \neq \emptyset$: Symmetrical.

$(\mu \subseteq), (\mu \emptyset), (\mu =) \Rightarrow (\mu \cup) :$

Let $f(Y) \cap (X - f(X)) \neq \emptyset$. If $X \cup Y = \emptyset$, then $f(X \cup Y) = f(X) = \emptyset$ by $(\mu \subseteq)$. So suppose $X \cup Y \neq \emptyset$. By (13), $f(X \cup Y) \cap Y = \emptyset$, so $f(X \cup Y) \subseteq X$ by $(\mu \subseteq)$. By $(\mu \emptyset)$, $f(X \cup Y) \neq \emptyset$, so $f(X \cup Y) \cap X \neq \emptyset$, and $f(X \cup Y) = f(X)$ by $(\mu =)$.

$(\mu \subseteq), (\mu \emptyset), (\mu =) \Rightarrow (\mu CUM) :$

Let $f(Y) \subseteq X \subseteq Y$. If $Y = \emptyset$, this is trivial by $(\mu \subseteq)$. If $Y \neq \emptyset$, then by $(\mu \emptyset)$ - which is crucial here - $f(Y) \neq \emptyset$, so by $f(Y) \subseteq X$ $f(Y) \cap X \neq \emptyset$, so by $(\mu =)$ $f(Y) = f(Y) \cap X = f(X)$.

(15) $(\mu \subseteq) + (\mu \parallel) \rightarrow (\mu =) :$

Let $X \subseteq Y$, $X \cap f(Y) \neq \emptyset$, and consider $Y = X \cup (Y - X)$. Then $f(Y) = f(X) \parallel f(Y - X)$. As $f(Y) \cap X \neq \emptyset$, $f(Y) = f(Y - X)$ is impossible. Otherwise, $f(X) = f(Y) \cap X$, and we are done.

(16) $(\mu \parallel) + (\mu \in) + (\mu PR) + (\mu \subseteq) \rightarrow (\mu =) :$

Suppose $X \subseteq Y$, $x \in f(Y) \cap X$, we have to show $f(Y) \cap X = f(X)$. " \subseteq " is trivial by (μPR) . " \supseteq ": Assume $a \notin f(Y)$ (by $(\mu \subseteq)$), but $a \in f(X)$. By $(\mu \in) \exists b \in Y. a \notin f(\{a, b\})$. As $a \in f(X)$, by (μPR) , $a \in f(\{a, x\})$. By $(\mu \parallel)$, $f(\{a, b, x\}) = f(\{a, x\}) \parallel f(\{b\})$. As $a \notin f(\{a, b, x\})$, $f(\{a, b, x\}) = f(\{b\})$, so $x \notin f(\{a, b, x\})$, contradicting (μPR) , as $a, b, x \in Y$.

(17) $(\mu CUM) + (\mu =) \rightarrow (\mu \in) :$

Let $a \in X - f(X)$. If $f(X) = \emptyset$, then $f(\{a\}) = \emptyset$ by (μCUM) . If not: Let $b \in f(X)$, then $a \notin f(\{a, b\})$ by $(\mu =)$.

(18) $(\mu CUM) + (\mu =) + (\mu \subseteq) \rightarrow (\mu \parallel) :$

By (μCUM) , $f(X \cup Y) \subseteq X \subseteq X \cup Y \rightarrow f(X) = f(X \cup Y)$, and $f(X \cup Y) \subseteq Y \subseteq X \cup Y \rightarrow f(Y) = f(X \cup Y)$. Thus, if $(\mu \parallel)$ were to fail, $f(X \cup Y) \not\subseteq X$, $f(X \cup Y) \not\subseteq Y$, but then by $(\mu \subseteq)$ $f(X \cup Y) \cap X \neq \emptyset$, so $f(X) = f(X \cup Y) \cap X$, and $f(X \cup Y) \cap Y \neq \emptyset$, so $f(Y) = f(X \cup Y) \cap Y$ by $(\mu =)$. Thus, $f(X \cup Y) = (f(X \cup Y) \cap X) \cup (f(X \cup Y) \cap Y) = f(X) \cup f(Y)$.

(19) $(\mu PR) + (\mu CUM) + (\mu \parallel) \rightarrow (\mu =) :$

Suppose $(\mu =)$ does not hold. So, by (μPR) , there are X, Y, y s.t. $X \subseteq Y$, $X \cap f(Y) \neq \emptyset$, $y \in Y - f(Y)$, $y \in f(X)$. Let $a \in X \cap f(Y)$. If $f(Y) = \{a\}$, then by (μCUM) $f(Y) = f(X)$, so there must be $b \in f(Y)$, $b \neq a$. Take now Y', Y'' s.t. $Y = Y' \cup Y''$, $a \in Y'$, $a \notin Y''$, $b \in Y''$, $b \notin Y'$, $y \in Y' \cap Y''$. Assume now $(\mu \parallel)$ to hold, we show a contradiction. If $y \notin f(Y'')$, then by (μPR) $y \notin f(Y'' \cup \{a\})$. But $f(Y'' \cup \{a\}) = f(Y'') \parallel f(\{a, y\})$, so $f(Y'' \cup \{a\}) = f(Y'')$, contradicting $a \in f(Y)$. If $y \in f(Y'')$, then by $f(Y) = f(Y') \parallel f(Y'')$, $f(Y) = f(Y')$, contradiction as $b \notin f(Y')$.

(20) $(\mu \subseteq) + (\mu PR) + (\mu =) \not\Rightarrow (\mu \parallel) :$

See Example 2.4 (page 33) .

(21) $(\mu \subseteq) + (\mu PR) + (\mu \parallel) \not\Rightarrow (\mu =) :$

See Example 2.5 (page 33) .

(22) $(\mu \subseteq) + (\mu PR) + (\mu \parallel) + (\mu =) + (\mu \cup) \not\Rightarrow (\mu \in) :$

See Example 2.6 (page 34) .

Thus, by Fact 4.4 (page 77) , the conditions do not assure representability by ranked structures.

□

karl-search= End Fact Mu-Base Proof

2.3.7 Example Mu-Cum-Cd

karl-search= Start Example Mu-Cum-Cd

Example 2.2

(+++ Orig. No.: Example Mu-Cum-Cd +++)

LABEL: Example Mu-Cum-Cd

We show here $(\mu \subseteq) + (\mu CUM) \not\Rightarrow (\mu \subseteq \supseteq)$.

Consider $X := \{a, b, c\}$, $Y := \{a, b, d\}$, $f(X) := \{a\}$, $f(Y) := \{a, b\}$, $\mathcal{Y} := \{X, Y\}$. (If $f(\{a, b\})$ were defined, we would have $f(X) = f(\{a, b\}) = f(Y)$, *contradiction.*)

Obviously, $(\mu \subseteq)$ and (μCUM) hold, but not $(\mu \subseteq \supseteq)$.

□

karl-search= End Example Mu-Cum-Cd

2.3.8 Example Need-Pr

karl-search= Start Example Need-Pr

Example 2.3

(+++ Orig. No.: Example Need-Pr +++)

LABEL: Example Need-Pr

We show here $(\mu \subseteq) + (\mu \subseteq \supseteq) + (\mu CUM) + (\mu RatM) + (\cap) \not\Rightarrow (\mu PR)$.

Let $U := \{a, b, c\}$. Let $\mathcal{Y} = \mathcal{P}(U)$. So (\cap) is trivially satisfied. Set $f(X) := X$ for all $X \subseteq U$ except for $f(\{a, b\}) = \{b\}$. Obviously, this cannot be represented by a preferential structure and (μPR) is false for U and $\{a, b\}$. But it satisfies $(\mu \subseteq)$, (μCUM) , $(\mu RatM)$. $(\mu \subseteq)$ is trivial. (μCUM) : Let $f(X) \subseteq Y \subseteq X$. If $f(X) = X$, we are done. Consider $f(\{a, b\}) = \{b\}$. If $\{b\} \subseteq Y \subseteq \{a, b\}$, then $f(Y) = \{b\}$, so we are done again. It is shown in Fact 2.7 (page 28), (8) that $(\mu \subseteq \supseteq)$ follows. $(\mu RatM)$: Suppose $X \subseteq Y$, $X \cap f(Y) \neq \emptyset$, we have to show $f(X) \subseteq f(Y) \cap X$. If $f(Y) = Y$, the result holds by $X \subseteq Y$, so it does if $X = Y$. The only remaining case is $Y = \{a, b\}$, $X = \{b\}$, and the result holds again.

□

karl-search= End Example Need-Pr

2.3.9 Example Mu-Barbar

karl-search= Start Example Mu-Barbar

Example 2.4

(+++ Orig. No.: Example Mu-Barbar +++)

LABEL: Example Mu-Barbar

The example shows that $(\mu \subseteq) + (\mu PR) + (\mu =) \not\Rightarrow (\mu \parallel)$.

Consider the following structure without transitivity: $U := \{a, b, c, d\}$, c and d have ω many copies in descending order $c_1 \succeq c_2 \dots$, etc. a, b have one single copy each. $a \succeq b$, $a \succeq d_1$, $b \succeq a$, $b \succeq c_1$. $(\mu \parallel)$ does not hold: $f(U) = \emptyset$, but $f(\{a, c\}) = \{a\}$, $f(\{b, d\}) = \{b\}$. (μPR) holds as in all preferential structures. $(\mu =)$ holds: If it were to fail, then for some $A \subseteq B$, $f(B) \cap A \neq \emptyset$, so $f(B) \neq \emptyset$. But the only possible cases for B are now: $(a \in B, b, d \notin B)$ or $(b \in B, a, c \notin B)$. Thus, B can be $\{a\}$, $\{a, c\}$, $\{b\}$, $\{b, d\}$ with $f(B) = \{a\}$, $\{a\}$, $\{b\}$, $\{b\}$. If $A = B$, then the result will hold trivially. Moreover, A has to be $\neq \emptyset$. So the remaining cases of B where it might fail are $B = \{a, c\}$ and $\{b, d\}$, and by $f(B) \cap A \neq \emptyset$, the only cases of A where it might fail, are $A = \{a\}$ or $\{b\}$ respectively. So the only cases remaining are: $B = \{a, c\}$, $A = \{a\}$ and $B = \{b, d\}$, $A = \{b\}$. In the first case, $f(A) = f(B) = \{a\}$, in the second $f(A) = f(B) = \{b\}$, but $(\mu =)$ holds in both.

□

karl-search= End Example Mu-Barbar

2.3.10 Example Mu-Equal

karl-search= Start Example Mu-Equal

Example 2.5

(+++ Orig. No.: Example Mu-Equal +++)

LABEL: Example Mu-Equal

The example shows that $(\mu \subseteq) + (\mu PR) + (\mu \parallel) \not\Rightarrow (\mu =)$.

Work in the set of theory definable model sets of an infinite propositional language. Note that this is not closed under set difference, and closure properties will play a crucial role in the argumentation. Let $U := \{y, a, x_{i < \omega}\}$, where $x_i \rightarrow a$ in the standard topology. For the order, arrange s.t. y is minimized by any set iff this set contains a cofinal subsequence of the x_i , this can be done by the standard construction. Moreover, let the x_i all kill themselves, i.e. with ω many copies $x_i^1 \succeq x_i^2 \succeq \dots$. There are no other elements in the relation. Note that if $a \notin \mu(X)$, then $a \notin X$, and X cannot contain a cofinal subsequence of the x_i , as X is closed in the standard topology. (A short argument: suppose X contains such a subsequence, but $a \notin X$. Then the theory of a $Th(a)$ is inconsistent with $Th(X)$, so already a finite subset of $Th(a)$ is inconsistent with $Th(X)$, but such a finite subset will finally hold in a cofinal sequence converging to a .) Likewise, if $y \in \mu(X)$, then X cannot contain a cofinal subsequence of the x_i .

Obviously, $(\mu \subseteq)$ and (μPR) hold, but $(\mu =)$ does not hold: Set $B := U$, $A := \{a, y\}$. Then $\mu(B) = \{a\}$, $\mu(A) = \{a, y\}$, contradicting $(\mu =)$.

It remains to show that $(\mu \parallel)$ holds.

$\mu(X)$ can only be \emptyset , $\{a\}$, $\{y\}$, $\{a, y\}$. As $\mu(A \cup B) \subseteq \mu(A) \cup \mu(B)$ by (μPR) ,

Case 1, $\mu(A \cup B) = \{a, y\}$ is settled.

Note that if $y \in X - \mu(X)$, then X will contain a cofinal subsequence, and thus $a \in \mu(X)$.

Case 2: $\mu(A \cup B) = \{a\}$.

Case 2.1: $\mu(A) = \{a\}$ - we are done.

Case 2.2: $\mu(A) = \{y\}$: A does not contain a , nor a cofinal subsequence. If $\mu(B) = \emptyset$, then $a \notin B$, so $a \notin A \cup B$, a contradiction. If $\mu(B) = \{a\}$, we are done. If $y \in \mu(B)$, then $y \in B$, but B does not contain a cofinal

subsequence, so $A \cup B$ does not either, so $y \in \mu(A \cup B)$, *contradiction*.

Case 2.3: $\mu(A) = \emptyset$: A cannot contain a cofinal subsequence. If $\mu(B) = \{a\}$, we are done. $a \in \mu(B)$ does have to hold, so $\mu(B) = \{a, y\}$ is the only remaining possibility. But then B does not contain a cofinal subsequence, and neither does $A \cup B$, so $y \in \mu(A \cup B)$, *contradiction*.

Case 2.4: $\mu(A) = \{a, y\}$: A does not contain a cofinal subsequence. If $\mu(B) = \{a\}$, we are done. If $\mu(B) = \emptyset$, B does not contain a cofinal subsequence (as $a \notin B$), so neither does $A \cup B$, so $y \in \mu(A \cup B)$, *contradiction*. If $y \in \mu(B)$, B does not contain a cofinal subsequence, and we are done again.

Case 3: $\mu(A \cup B) = \{y\}$: To obtain a contradiction, we need $a \in \mu(A)$ or $a \in \mu(B)$. But in both cases $a \in \mu(A \cup B)$.

Case 4: $\mu(A \cup B) = \emptyset$: Thus, $A \cup B$ contains no cofinal subsequence. If, e.g. $y \in \mu(A)$, then $y \in \mu(A \cup B)$, if $a \in \mu(A)$, then $a \in \mu(A \cup B)$, so $\mu(A) = \emptyset$.

□

karl-search= End Example Mu-Equal

2.3.11 Example Mu-Epsilon

karl-search= Start Example Mu-Epsilon

Example 2.6

(+++ Orig. No.: Example Mu-Epsilon +++)

LABEL: Example Mu-Epsilon

The example show that $(\mu \subseteq) + (\mu PR) + (\mu \parallel) + (\mu =) + (\mu \cup) \not\Rightarrow (\mu \in)$.

Let $U := \{y, x_{i < \omega}\}$, x_i a sequence, each x_i kills itself, $x_i^1 \succeq x_i^2 \succeq \dots$ and y is killed by all cofinal subsequences of the x_i . Then for any $X \subseteq U$ $\mu(X) = \emptyset$ or $\mu(X) = \{y\}$.

$(\mu \subseteq)$ and (μPR) hold obviously.

$(\mu \parallel)$: Let $A \cup B$ be given. If $y \notin X$, then for all $Y \subseteq X$ $\mu(Y) = \emptyset$. So, if $y \notin A \cup B$, we are done. If $y \in A \cup B$, if $\mu(A \cup B) = \emptyset$, one of A, B must contain a cofinal sequence, it will have $\mu = \emptyset$. If not, then $\mu(A \cup B) = \{y\}$, and this will also hold for the one y is in.

$(\mu =)$: Let $A \subseteq B$, $\mu(B) \cap A \neq \emptyset$, show $\mu(A) = \mu(B) \cap A$. But now $\mu(B) = \{y\}$, $y \in A$, so B does not contain a cofinal subsequence, neither does A , so $\mu(A) = \{y\}$.

$(\mu \cup)$: $(A - \mu(A)) \cap \mu(A') \neq \emptyset$, so $\mu(A') = \{y\}$, so $\mu(A \cup A') = \emptyset$, as $y \in A - \mu(A)$.

But $(\mu \in)$ does not hold: $y \in U - \mu(U)$, but there is no x s.t. $y \notin \mu(\{x, y\})$.

□

karl-search= End Example Mu-Epsilon

2.3.12 Fact Mwor

karl-search= Start Fact Mwor

Fact 2.8

(+++ Orig. No.: Fact Mwor +++)

LABEL: Fact Mwor

$$(\mu wOR) + (\mu \subseteq) \Rightarrow f(X \cup Y) \subseteq f(X) \cup f(Y) \cup (X \cap Y)$$

karl-search= End Fact Mwor

2.3.13 Fact Mwor Proof

karl-search= Start Fact Mwor Proof

Proof

(+++*** Orig.: Proof)

$$f(X \cup Y) \subseteq f(X) \cup Y, f(X \cup Y) \subseteq X \cup f(Y), \text{ so } f(X \cup Y) \subseteq (f(X) \cup Y) \cap (X \cup f(Y)) = f(X) \cup f(Y) \cup (X \cap Y)$$

□

karl-search= End Fact Mwor Proof

2.3.14 Proposition Alg-Log

karl-search= Start Proposition Alg-Log

Proposition 2.9

(+++ Orig. No.: Proposition Alg-Log +++)

LABEL: Proposition Alg-Log

The following table is to be read as follows:

Let a logic \sim satisfy (*LLE*) and (*CCL*), and define a function $f : \mathbf{D}_{\mathcal{L}} \rightarrow \mathbf{D}_{\mathcal{L}}$ by $f(M(T)) := M(\overline{\overline{T}})$. Then f is well defined, satisfies (μdp), and $\overline{\overline{T}} = Th(f(M(T)))$.

If \sim satisfies a rule in the left hand side, then - provided the additional properties noted in the middle for \Rightarrow hold, too - f will satisfy the property in the right hand side.

Conversely, if $f : \mathcal{Y} \rightarrow \mathcal{P}(M_{\mathcal{L}})$ is a function, with $\mathbf{D}_{\mathcal{L}} \subseteq \mathcal{Y}$, and we define a logic \sim by $\overline{\overline{T}} := Th(f(M(T)))$, then \sim satisfies (*LLE*) and (*CCL*). If f satisfies (μdp), then $f(M(T)) = M(\overline{\overline{T}})$.

If f satisfies a property in the right hand side, then - provided the additional properties noted in the middle for \Leftarrow hold, too - \sim will satisfy the property in the left hand side.

If “formula” is noted in the table, this means that, if one of the theories (the one named the same way in Definition 2.3 (page 21)) is equivalent to a formula, we do not need (μdp).

Basics			
(1.1)	(OR)	\Rightarrow	(μOR)
(1.2)		\Leftarrow	
(2.1)	(disjOR)	\Rightarrow	$(\mu disjOR)$
(2.2)		\Leftarrow	
(3.1)	(wOR)	\Rightarrow	(μwOR)
(3.2)		\Leftarrow	
(4.1)	(SC)	\Rightarrow	$(\mu \subseteq)$
(4.2)		\Leftarrow	
(5.1)	(CP)	\Rightarrow	$(\mu \emptyset)$
(5.2)		\Leftarrow	
(6.1)	(PR)	\Rightarrow	(μPR)
(6.2)		$\Leftarrow (\mu dp) + (\mu \subseteq)$	
(6.3)		$\not\Leftarrow$ without (μdp)	
(6.4)		$\Leftarrow (\mu \subseteq)$ T' a formula	
(6.5)	(PR)	\Leftarrow T' a formula	$(\mu PR')$
(7.1)	(CUT)	\Rightarrow	(μCUT)
(7.2)		\Leftarrow	
Cumulativity			
(8.1)	(CM)	\Rightarrow	(μCM)
(8.2)		\Leftarrow	
(9.1)	(ResM)	\Rightarrow	$(\mu ResM)$
(9.2)		\Leftarrow	
(10.1)	$(\subseteq \supseteq)$	\Rightarrow	$(\mu \subseteq \supseteq)$
(10.2)		\Leftarrow	
(11.1)	(CUM)	\Rightarrow	(μCUM)
(11.2)		\Leftarrow	
Rationality			
(12.1)	(RatM)	\Rightarrow	$(\mu RatM)$
(12.2)		$\Leftarrow (\mu dp)$	
(12.3)		$\not\Leftarrow$ without (μdp)	
(12.4)		\Leftarrow T a formula	
(13.1)	(RatM =)	\Rightarrow	$(\mu =)$
(13.2)		$\Leftarrow (\mu dp)$	
(13.3)		$\not\Leftarrow$ without (μdp)	
(13.4)		\Leftarrow T a formula	
(14.1)	(Log =')	\Rightarrow	$(\mu =')$
(14.2)		$\Leftarrow (\mu dp)$	
(14.3)		$\not\Leftarrow$ without (μdp)	
(14.4)		$\Leftarrow T$ a formula	
(15.1)	(Log)	\Rightarrow	(μ)
(15.2)		\Leftarrow	
(16.1)	(Log \cup)	$\Rightarrow (\mu \subseteq) + (\mu =)$	$(\mu \cup)$
(16.2)		$\Leftarrow (\mu dp)$	
(16.3)		$\not\Leftarrow$ without (μdp)	
(17.1)	(Log \cup')	$\Rightarrow (\mu \subseteq) + (\mu =)$	$(\mu \cup')$
(17.2)		$\Leftarrow (\mu dp)$	
(17.3)		$\not\Leftarrow$ without (μdp)	

karl-search= End Proposition Alg-Log

2.3.15 Proposition Alg-Log Proof

karl-search= Start Proposition Alg-Log Proof

Proof

(+++*** Orig.: Proof)

Set $f(T) := f(M(T))$, note that $f(T \cup T') := f(M(T \cup T')) = f(M(T) \cap M(T'))$.

We show first the general framework.

Let \sim satisfy *(LLE)* and *(CCL)*. Let $f : \mathbf{D}_{\mathcal{L}} \rightarrow \mathbf{D}_{\mathcal{L}}$ be defined by $f(M(T)) := M(\overline{\overline{T}})$. If $M(T) = M(T')$, then $\overline{\overline{T}} = \overline{\overline{T'}}$, so by *(LLE)* $\overline{\overline{T}} = \overline{\overline{T'}}$, so $f(M(T)) = f(M(T'))$, so f is well defined and satisfies *(μdp)*. By *(CCL)* $Th(M(\overline{\overline{T}})) = \overline{\overline{T}}$.

Let f be given, and \sim be defined by $\overline{\overline{T}} := Th(f(M(T)))$. Obviously, \sim satisfies *(LLE)* and *(CCL)* (and thus *(RW)*). If f satisfies *(μdp)*, then $f(M(T)) = M(T')$ for some T' , and $f(M(T)) = M(Th(f(M(T)))) = M(\overline{\overline{T}})$ by Fact 2.4 (page 17) . (We will use Fact 2.4 (page 17) now without further mentioning.)

Next we show the following fact:

(a) If f satisfies *(μdp)*, or T' is equivalent to a formula, then $Th(f(T) \cap M(T')) = \overline{\overline{\overline{T} \cup T'}}$.

Case 1, f satisfies *(μdp)*. $Th(f(M(T)) \cap M(T')) = Th(M(\overline{\overline{T}}) \cap M(T')) = \overline{\overline{\overline{T} \cup T'}}$ by Fact 2.3 (page 16) (5).

Case 2, T' is equivalent to ϕ' . $Th(f(M(T)) \cap M(\phi')) = \overline{\overline{Th(f(M(T))) \cup \{\phi'\}}} = \overline{\overline{\overline{T} \cup \{\phi'\}}}$ by Fact 2.3 (page 16) (3).

We now prove the individual properties.

(1.1) *(OR)* \Rightarrow *(μOR)*

Let $X = M(T)$, $Y = M(T')$. $f(X \cup Y) = f(M(T) \cup M(T')) = f(M(T \vee T')) := M(\overline{\overline{\overline{T \vee T'}}}) \subseteq_{(OR)} M(\overline{\overline{\overline{T} \cap \overline{\overline{T'}}.$

(1.2) *(μOR)* \Rightarrow *(OR)*

$\overline{\overline{\overline{T \vee T'}}} := Th(f(M(T \vee T'))) = Th(f(M(T) \cup M(T'))) \supseteq_{(\mu OR)} Th(f(M(T)) \cup f(M(T'))) =$ (by Fact 2.2 (page 15)) $Th(f(M(T))) \cap Th(f(M(T'))) =: \overline{\overline{\overline{T} \cap \overline{\overline{T'}}}}$.

(2) By $\neg Con(T, T') \Leftrightarrow M(T) \cap M(T') = \emptyset$, we can use directly the proofs for 1.

(3.1) *(wOR)* \Rightarrow *(μwOR)*

Let $X = M(T)$, $Y = M(T')$. $f(X \cup Y) = f(M(T) \cup M(T')) = f(M(T \vee T')) := M(\overline{\overline{\overline{T \vee T'}}}) \subseteq_{(wOR)} M(\overline{\overline{\overline{T} \cap \overline{\overline{T'}}.$

(3.2) *(μwOR)* \Rightarrow *(wOR)*

$\overline{\overline{\overline{T \vee T'}}} := Th(f(M(T \vee T'))) = Th(f(M(T) \cup M(T'))) \supseteq_{(\mu wOR)} Th(f(M(T)) \cup M(T')) =$ (by Fact 2.2 (page 15)) $Th(f(M(T))) \cap Th(M(T')) =: \overline{\overline{\overline{T} \cap \overline{\overline{T'}}}}$.

(4.1) *(SC)* \Rightarrow *($\mu \subseteq$)*

Trivial.

(4.2) *($\mu \subseteq$)* \Rightarrow *(SC)*

Trivial.

(5.1) *(CP)* \Rightarrow *($\mu \emptyset$)*

Trivial.

(5.2) *($\mu \emptyset$)* \Rightarrow *(CP)*

Trivial.

(6.1) *(PR)* \Rightarrow *(μPR)* :

Suppose $X := M(T)$, $Y := M(T')$, $X \subseteq Y$, we have to show $f(Y) \cap X \subseteq f(X)$. By prerequisite, $\overline{T'} \subseteq \overline{T}$, so $\overline{T \cup T'} = \overline{T}$, so $\overline{\overline{T \cup T'}} = \overline{\overline{T}}$ by (LLE). By (PR) $\overline{\overline{T \cup T'}} \subseteq \overline{\overline{T'} \cup T}$, so $f(Y) \cap X = f(T') \cap M(T) = M(\overline{\overline{T'} \cup T}) \subseteq M(\overline{\overline{T \cup T'}}) = M(\overline{\overline{T}}) = f(X)$.

(6.2) $(\mu PR) + (\mu dp) + (\mu \subseteq) \Rightarrow (PR)$:

$f(T) \cap M(T') =_{(\mu \subseteq)} f(T) \cap M(T) \cap M(T') = f(T) \cap M(T \cup T') \subseteq_{(\mu PR)} f(T \cup T')$, so $\overline{\overline{\overline{T \cup T'}}} = Th(f(T \cup T')) \subseteq Th(f(T) \cap M(T')) = \overline{\overline{T \cup T'}}$ by (a) above and (μdp) .

(6.3) $(\mu PR) \not\Rightarrow (PR)$ without (μdp) :

(μPR) holds in all preferential structures (see Definition 3.1 (page 43)) by Fact 3.2 (page 49) . Example 3.2 (page 51) shows that (DP) may fail in the resulting logic.

(6.4) $(\mu PR) + (\mu \subseteq) \Rightarrow (PR)$ if T' is classically equivalent to a formula:

It was shown in the proof of (6.2) that $f(T) \cap M(\phi') \subseteq f(T \cup \{\phi'\})$, so $\overline{\overline{\overline{T \cup \{\phi'\}}}} = Th(f(T \cup \{\phi'\})) \subseteq Th(f(T) \cap M(\phi')) = \overline{\overline{T \cup \{\phi'\}}}$ by (a) above.

(6.5) $(\mu PR')$ \Rightarrow (PR), if T' is classically equivalent to a formula:

$f(M(T)) \cap M(\phi') \subseteq_{(\mu PR')} f(M(T) \cap M(\phi')) = f(M(T \cup \{\phi'\}))$. So again $\overline{\overline{\overline{T \cup \{\phi'\}}}} = Th(f(T \cup \{\phi'\})) \subseteq Th(f(T) \cap M(\phi')) = \overline{\overline{T \cup \{\phi'\}}}$ by (a) above.

(7.1) (CUT) \Rightarrow (μCUT)

So let $X = M(T)$, $Y = M(T')$, and $f(T) := M(\overline{\overline{T}}) \subseteq M(T') \subseteq M(T) \rightarrow \overline{T} \subseteq \overline{T'} \subseteq \overline{\overline{T}} =_{(LLE)} \overline{\overline{\overline{T}}} \rightarrow$ (by (CUT)) $\overline{\overline{T}} = \overline{\overline{\overline{T}}} \supseteq \overline{\overline{\overline{T'}}} = \overline{\overline{T'}} \rightarrow f(T) = M(\overline{\overline{T}}) \subseteq M(\overline{\overline{T'}}) = f(T')$, thus $f(X) \subseteq f(Y)$.

(7.2) $(\mu CUT) \Rightarrow$ (CUT)

Let $T \subseteq \overline{T'} \subseteq \overline{\overline{T}}$. Thus $f(T) \subseteq M(\overline{\overline{T}}) \subseteq M(T') \subseteq M(T)$, so by (μCUT) $f(T) \subseteq f(T')$, so $\overline{\overline{T}} = Th(f(T)) \supseteq Th(f(T')) = \overline{\overline{T'}}$.

(8.1) (CM) \Rightarrow (μCM)

So let $X = M(T)$, $Y = M(T')$, and $f(T) := M(\overline{\overline{T}}) \subseteq M(T') \subseteq M(T) \rightarrow \overline{T} \subseteq \overline{T'} \subseteq \overline{\overline{T}} =_{(LLE)} \overline{\overline{\overline{T}}} \rightarrow$ (by (LLE), (CM)) $\overline{\overline{T}} = \overline{\overline{\overline{T}}} \subseteq \overline{\overline{\overline{T'}}} = \overline{\overline{T'}} \rightarrow f(T) = M(\overline{\overline{T}}) \supseteq M(\overline{\overline{T'}}) = f(T')$, thus $f(X) \supseteq f(Y)$.

(8.2) $(\mu CM) \Rightarrow$ (CM)

Let $T \subseteq \overline{T'} \subseteq \overline{\overline{T}}$. Thus by (μCM) and $f(T) \subseteq M(\overline{\overline{T}}) \subseteq M(T') \subseteq M(T)$, so $f(T) \supseteq f(T')$ by (μCM) , so $\overline{\overline{T}} = Th(f(T)) \subseteq Th(f(T')) = \overline{\overline{T'}}$.

(9.1) (ResM) \Rightarrow $(\mu ResM)$

Let $f(X) := M(\overline{\overline{\Delta}})$, $A := M(\alpha)$, $B := M(\beta)$. So $f(X) \subseteq A \cap B \Rightarrow \Delta \vdash \alpha, \beta \Rightarrow_{(ResM)} \Delta, \alpha \vdash \beta \Rightarrow M(\overline{\overline{\Delta}}, \alpha) \subseteq M(\beta) \Rightarrow f(X \cap A) \subseteq B$.

(9.2) $(\mu ResM) \Rightarrow$ (ResM)

Let $f(X) := M(\overline{\overline{\Delta}})$, $A := M(\alpha)$, $B := M(\beta)$. So $\Delta \vdash \alpha, \beta \Rightarrow f(X) \subseteq A \cap B \Rightarrow_{(\mu ResM)} f(X \cap A) \subseteq B \Rightarrow \Delta, \alpha \vdash \beta$.

(10.1) $(\subseteq \supseteq) \Rightarrow$ $(\mu \subseteq \supseteq)$

Let $f(T) \subseteq M(T')$, $f(T') \subseteq M(T)$. So $Th(M(T')) \subseteq Th(f(T))$, $Th(M(T)) \subseteq Th(f(T'))$, so $T' \subseteq \overline{T'} \subseteq \overline{\overline{T}}$, $T \subseteq \overline{T} \subseteq \overline{\overline{T'}}$, so by $(\subseteq \supseteq)$ $\overline{\overline{T}} = \overline{\overline{\overline{T'}}}$, so $f(T) := M(\overline{\overline{T}}) = M(\overline{\overline{\overline{T'}}}) =: f(T')$.

(10.2) $(\mu \subseteq \supseteq) \Rightarrow$ $(\subseteq \supseteq)$

Let $T \subseteq \overline{\overline{T'}}$ and $T' \subseteq \overline{\overline{T}}$. So by (CCL) $Th(M(T)) = \overline{T} \subseteq \overline{\overline{T'}} = Th(f(T'))$. But $Th(M(T)) \subseteq Th(X) \Rightarrow X \subseteq M(T) : X \subseteq M(Th(X)) \subseteq M(Th(M(T))) = M(T)$. So $f(T') \subseteq M(T)$, likewise $f(T) \subseteq M(T')$, so by $(\mu \subseteq \supseteq)$ $f(T) = f(T')$, so $\overline{\overline{T}} = \overline{\overline{T'}}$.

(11.1) (CUM) \Rightarrow (μCUM) :

So let $X = M(T)$, $Y = M(T')$, and $f(T) := M(\overline{\overline{T}}) \subseteq M(T') \subseteq M(T) \rightarrow \overline{\overline{T}} \subseteq \overline{\overline{T'}} \subseteq \overline{\overline{T}} =_{(LLE)} \overline{\overline{\overline{T}}} \rightarrow \overline{\overline{T}} = \overline{\overline{\overline{T}}} = \overline{\overline{\overline{T'}}} = \overline{\overline{T'}} \rightarrow f(T) = M(\overline{\overline{T}}) = M(\overline{\overline{\overline{T'}}}) = f(T')$, thus $f(X) = f(Y)$.

(11.2) $(\mu CUM) \Rightarrow (CUM)$:

Let $T \subseteq \overline{\overline{T'}} \subseteq \overline{\overline{T}}$. Thus by (μCUM) and $f(T) \subseteq M(\overline{\overline{T}}) \subseteq M(T') \subseteq M(T)$, so $f(T) = f(T')$, so $\overline{\overline{T}} = Th(f(T)) = Th(f(T')) = \overline{\overline{T'}}$.

(12.1) $(RatM) \Rightarrow (\mu RatM)$

Let $X = M(T)$, $Y = M(T')$, and $X \subseteq Y$, $X \cap f(Y) \neq \emptyset$, so $T \vdash T'$ and $M(T) \cap f(M(T')) \neq \emptyset$, so $Con(T, \overline{\overline{T'}})$, so $\overline{\overline{T'}} \cup T \subseteq \overline{\overline{T}}$ by $(RatM)$, so $f(X) = f(M(T)) = M(\overline{\overline{T}}) \subseteq M(\overline{\overline{T'}} \cup T) = M(\overline{\overline{T'}}) \cap M(T) = f(Y) \cap X$.

(12.2) $(\mu RatM) + (\mu dp) \Rightarrow (RatM)$:

Let $X = M(T)$, $Y = M(T')$, $T \vdash T'$, $Con(T, \overline{\overline{T'}})$, so $X \subseteq Y$ and by (μdp) $X \cap f(Y) \neq \emptyset$, so by $(\mu RatM)$ $f(X) \subseteq f(Y) \cap X$, so $\overline{\overline{T}} = \overline{\overline{\overline{T'}}} = Th(f(T \cup T')) \supseteq Th(f(T') \cap M(T)) = \overline{\overline{\overline{T'}}} \cup T$ by (a) above and (μdp) .

(12.3) $(\mu RatM) \not\Rightarrow (RatM)$ without (μdp) :

$(\mu RatM)$ holds in all ranked preferential structures (see Definition 3.4 (page 46)) by Fact 4.4 (page 77) . Example 2.7 (page 40) (2) shows that $(RatM)$ may fail in the resulting logic.

(12.4) $(\mu RatM) \Rightarrow (RatM)$ if T is classically equivalent to a formula:

$\phi \vdash T' \Rightarrow M(\phi) \subseteq M(T')$. $Con(\phi, \overline{\overline{T'}}) \Leftrightarrow M(\overline{\overline{T'}}) \cap M(\phi) \neq \emptyset \Leftrightarrow f(T') \cap M(\phi) \neq \emptyset$ by Fact 2.3 (page 16) (4). Thus $f(M(\phi)) \subseteq f(M(T')) \cap M(\phi)$ by $(\mu RatM)$. Thus by (a) above $\overline{\overline{\overline{T'}}} \cup \{\phi\} \subseteq \overline{\overline{\phi}}$.

(13.1) $(RatM =) \Rightarrow (\mu =)$

Let $X = M(T)$, $Y = M(T')$, and $X \subseteq Y$, $X \cap f(Y) \neq \emptyset$, so $T \vdash T'$ and $M(T) \cap f(M(T')) \neq \emptyset$, so $Con(T, \overline{\overline{T'}})$, so $\overline{\overline{T'}} \cup T = \overline{\overline{T}}$ by $(RatM =)$, so $f(X) = f(M(T)) = M(\overline{\overline{T}}) = M(\overline{\overline{\overline{T'}}} \cup T) = M(\overline{\overline{\overline{T'}}}) \cap M(T) = f(Y) \cap X$.

(13.2) $(\mu =) + (\mu dp) \Rightarrow (RatM =)$

Let $X = M(T)$, $Y = M(T')$, $T \vdash T'$, $Con(T, \overline{\overline{T'}})$, so $X \subseteq Y$ and by (μdp) $X \cap f(Y) \neq \emptyset$, so by $(\mu =)$ $f(X) = f(Y) \cap X$. So $\overline{\overline{\overline{T'}}} \cup T = \overline{\overline{T}}$ (a) above and (μdp) .

(13.3) $(\mu =) \not\Rightarrow (RatM =)$ without (μdp) :

$(\mu =)$ holds in all ranked preferential structures (see Definition 3.4 (page 46)) by Fact 4.4 (page 77) . Example 2.7 (page 40) (1) shows that $(RatM =)$ may fail in the resulting logic.

(13.4) $(\mu =) \Rightarrow (RatM =)$ if T is classically equivalent to a formula:

The proof is almost identical to the one for (12.4). Again, the prerequisites of $(\mu =)$ are satisfied, so $f(M(\phi)) = f(M(T')) \cap M(\phi)$. Thus, $\overline{\overline{\overline{T'}}} \cup \{\phi\} = \overline{\overline{\phi}}$ by (a) above.

Of the last four, we show (14), (15), (17), the proof for (16) is similar to the one for (17).

(14.1) $(Log =') \Rightarrow (\mu =')$:

$f(M(T')) \cap M(T) \neq \emptyset \Rightarrow Con(\overline{\overline{\overline{T'}}} \cup T) \Rightarrow_{(Log =')} \overline{\overline{\overline{\overline{T'}}}} = \overline{\overline{\overline{\overline{T'}}}} \cup T \Rightarrow f(M(T \cup T')) = f(M(T')) \cap M(T)$.

(14.2) $(\mu =') + (\mu dp) \Rightarrow (Log =')$:

$Con(\overline{\overline{\overline{T'}}} \cup T) \Rightarrow_{(\mu dp)} f(M(T')) \cap M(T) \neq \emptyset \Rightarrow f(M(T' \cup T)) = f(M(T') \cap M(T)) =_{(\mu =')} f(M(T')) \cap M(T)$, so $\overline{\overline{\overline{\overline{T'}}}} = \overline{\overline{\overline{\overline{T'}}}} \cup T$ by (a) above and (μdp) .

(14.3) $(\mu =') \not\Rightarrow (Log =')$ without (μdp) :

By Fact 4.4 (page 77) $(\mu =')$ holds in ranked structures. Consider Example 2.7 (page 40) (2). There, $Con(T, \overline{\overline{T'}})$, $T = T \cup T'$, and it was shown that $\overline{\overline{\overline{\overline{T'}}}} \not\subseteq \overline{\overline{T}} = \overline{\overline{\overline{\overline{T'}}}}$

(14.4) $(\mu =') \Rightarrow (Log =')$ if T is classically equivalent to a formula:

$Con(\overline{\overline{\overline{T'}}} \cup \{\phi\}) \Rightarrow \emptyset \neq M(\overline{\overline{\overline{T'}}}) \cap M(\phi) \Rightarrow f(T') \cap M(\phi) \neq \emptyset$ by Fact 2.3 (page 16) (4). So $f(M(T' \cup \{\phi\})) = f(M(T') \cap M(\phi)) = f(M(T')) \cap M(\phi)$ by $(\mu =')$, so $\overline{\overline{\overline{\overline{\overline{T'}}}}} = \overline{\overline{\overline{\overline{\overline{T'}}}}} \cup \{\phi\}$ by (a) above.

(15.1) $(Log \parallel) \Rightarrow (\mu \parallel) :$

Trivial.

(15.2) $(\mu \parallel) \Rightarrow (Log \parallel) :$

Trivial.

(16) $(Log \cup) \Leftrightarrow (\mu \cup) :$ Analogous to the proof of (17).

(17.1) $(Log \cup') + (\mu \subseteq) + (\mu =) \Rightarrow (\mu \cup') :$

$f(M(T')) \cap (M(T) - f(M(T))) \neq \emptyset \Rightarrow$ (by $(\mu \subseteq)$, $(\mu =)$, Fact 4.2 (page 76)) $f(M(T')) \cap M(T) \neq \emptyset$, $f(M(T')) \cap f(M(T)) = \emptyset \Rightarrow Con(\overline{T'}, T)$, $\neg Con(\overline{T'}, \overline{T}) \Rightarrow \overline{T' \vee T'} = \overline{T} \Rightarrow f(M(T)) = f(M(T \vee T')) = f(M(T) \cup M(T'))$.

(17.2) $(\mu \cup') + (\mu dp) \Rightarrow (Log \cup') :$

$Con(\overline{T'} \cup T)$, $\neg Con(\overline{T'} \cup \overline{T}) \Rightarrow_{(\mu dp)} f(T') \cap M(T) \neq \emptyset$, $f(T') \cap f(T) = \emptyset \Rightarrow f(M(T')) \cap (M(T) - f(M(T))) \neq \emptyset \Rightarrow f(M(T)) = f(M(T) \cup M(T')) = f(M(T \vee T'))$. So $\overline{T} = \overline{T' \vee T'}$.

(17.3) and (16.3) are solved by Example 2.7 (page 40) (3).

□

karl-search= End Proposition Alg-Log Proof

2.3.16 Example Rank-Dp

karl-search= Start Example Rank-Dp

Example 2.7

(+++ Orig. No.: Example Rank-Dp +++)

LABEL: Example Rank-Dp

(1) $(\mu =)$ without (μdp) does not imply $(RatM =) :$

Take $\{p_i : i \in \omega\}$ and put $m := m_{\wedge p_i}$, the model which makes all p_i true, in the top layer, all the other in the bottom layer. Let $m' \neq m$, $T' := \emptyset$, $T := Th(m, m')$. Then $\overline{T'} = T'$, so $Con(\overline{T'}, T)$, $\overline{T} = Th(m')$, $\overline{T'} \cup T = T$.

So $(RatM =)$ fails, but $(\mu =)$ holds in all ranked structures.

(2) $(\mu RatM)$ without (μdp) does not imply $(RatM) :$

Take $\{p_i : i \in \omega\}$ and let $m := m_{\wedge p_i}$, the model which makes all p_i true.

Let $X := M(\neg p_0) \cup \{m\}$ be the top layer, put the rest of $M_{\mathcal{L}}$ in the bottom layer. Let $Y := M_{\mathcal{L}}$. The structure is ranked, as shown in Fact 4.4 (page 77) , $(\mu RatM)$ holds.

Let $T' := \emptyset$, $T := Th(X)$. We have to show that $Con(T, \overline{T'})$, $T \vdash T'$, but $\overline{\overline{T'} \cup T} \not\subseteq \overline{T}$. $\overline{T'} = Th(M(p_0) - \{m\}) = \overline{p_0}$. $T = \overline{\{\neg p_0\} \vee Th(m)}$, $\overline{T} = T$. So $Con(T, \overline{T'})$. $M(\overline{T'}) = M(p_0)$, $M(T) = X$, $M(\overline{T'} \cup T) = M(\overline{T'}) \cap M(T) = \{m\}$, $m \models p_1$, so $p_1 \in \overline{\overline{T'} \cup T}$, but $X \not\models p_1$.

(3) This example shows that we need (μdp) to go from $(\mu \cup)$ to $(Log \cup)$ and from $(\mu \cup')$ to $(Log \cup')$.

Let $v(\mathcal{L}) := \{p, q\} \cup \{p_i : i < \omega\}$. Let m make all variables true.

Put all models of $\neg p$, and m , in the upper layer, all other models in the lower layer. This is ranked, so by Fact 4.4 (page 77) $(\mu \cup)$ and $(\mu \cup')$ hold. Set $X := M(\neg q) \cup \{m\}$, $X' := M(q) - \{m\}$, $T := Th(X) = \neg q \vee Th(m)$, $T' := Th(X') = \overline{q}$. Then $\overline{T} = \overline{p \wedge \neg q}$, $\overline{T'} = \overline{p \wedge q}$. We have $Con(\overline{T'}, T)$, $\neg Con(\overline{T'}, \overline{T})$. But $\overline{\overline{T' \vee T'}} = \overline{p} \neq \overline{T} =$

$\overline{p \wedge \neg q}$ and $Con(\overline{\overline{T \vee T'}}, T')$, so $(Log \cup)$ and $(Log \cup')$ fail.

□

karl-search= End Example Rank-Dp

2.3.17 Fact Cut-Pr

karl-search= Start Fact Cut-Pr

Fact 2.10

(+++ Orig. No.: Fact Cut-Pr +++)

LABEL: Fact Cut-Pr

$(CUT) \not\Rightarrow (PR)$

karl-search= End Fact Cut-Pr

2.3.18 Fact Cut-Pr Proof

karl-search= Start Fact Cut-Pr Proof

Proof

(+++*** Orig.: Proof)

We give two proofs:

(1) If $(CUT) \Rightarrow (PR)$, then by $(\mu PR) \Rightarrow$ (by Fact 2.7 (page 28) (3)) $(\mu CUT) \Rightarrow$ (by Proposition 2.9 (page 35) (7.2) $(CUT) \Rightarrow (PR)$ we would have a proof of $(\mu PR) \Rightarrow (PR)$ without (μdp) , which is impossible, as shown by Example 3.2 (page 51) .

(2) Reconsider Example 2.3 (page 32) , and say $a \models p \wedge q$, $b \models p \wedge \neg q$, $c \models \neg p \wedge q$. It is shown there that (μCUM) holds, so (μCUT) holds, so by Proposition 2.9 (page 35) (7.2) (CUT) holds, if we define $\overline{\overline{T}} := Th(f(M(T)))$. Set $T := \{p \vee (\neg p \wedge q)\}$, $T' := \{p\}$, then $\overline{\overline{T \cup T'}} = \overline{\overline{T'}} = \overline{\overline{\{p \wedge \neg q\}}}$, $\overline{\overline{T}} = \overline{\overline{T}}$, $\overline{\overline{T \cup T'}} = \overline{\overline{T'}} = \overline{\overline{\{p\}}}$, so (PR) fails.

□

karl-search= End Fact Cut-Pr Proof

karl-search= End ToolBase1-Log-Rules

karl-search= End ToolBase1-Log

3 General and smooth preferential structures

LABEL: General and smooth preferential structures

3.0.19 ToolBase1-Pref

karl-search= Start ToolBase1-Pref

LABEL: Section Toolbase1-Pref

3.0.20 ToolBase1-Pref-Base

karl-search= Start ToolBase1-Pref-Base

LABEL: Section Toolbase1-Pref-Base

3.1 General and smooth: Basics

LABEL: General and smooth: Basics

3.1.1 Definition Pref-Str

karl-search= Start Definition Pref-Str

Definition 3.1

(+++ Orig. No.: Definition Pref-Str +++)

LABEL: Definition Pref-Str

Fix $U \neq \emptyset$, and consider arbitrary X . Note that this X has not necessarily anything to do with U , or \mathcal{U} below. Thus, the functions $\mu_{\mathcal{M}}$ below are in principle functions from V to V - where V is the set theoretical universe we work in.

(A) Preferential models or structures.

(1) The version without copies:

A pair $\mathcal{M} := \langle U, \prec \rangle$ with U an arbitrary set, and \prec an arbitrary binary relation on U is called a preferential model or structure.

(2) The version with copies:

A pair $\mathcal{M} := \langle \mathcal{U}, \prec \rangle$ with \mathcal{U} an arbitrary set of pairs, and \prec an arbitrary binary relation on \mathcal{U} is called a preferential model or structure.

If $\langle x, i \rangle \in \mathcal{U}$, then x is intended to be an element of U , and i the index of the copy.

We sometimes also need copies of the relation \prec , we will then replace \prec by one or several arrows α attacking non-minimal elements, e.g. $x \prec y$ will be written $\alpha : x \rightarrow y$, $\langle x, i \rangle \prec \langle y, i \rangle$ will be written $\alpha : \langle x, i \rangle \rightarrow \langle y, i \rangle$, and finally we might have $\langle \alpha, k \rangle : x \rightarrow y$ and $\langle \alpha, k \rangle : \langle x, i \rangle \rightarrow \langle y, i \rangle$, etc.

(B) Minimal elements, the functions $\mu_{\mathcal{M}}$

(1) The version without copies:

Let $\mathcal{M} := \langle U, \prec \rangle$, and define

$$\mu_{\mathcal{M}}(X) := \{x \in X : x \in U \wedge \neg \exists x' \in X \cap U. x' \prec x\}.$$

$\mu_{\mathcal{M}}(X)$ is called the set of minimal elements of X (in \mathcal{M}).

Thus, $\mu_{\mathcal{M}}(X)$ is the set of elements such that there is no smaller one in X .

(2) The version with copies:

Let $\mathcal{M} := \langle \mathcal{U}, \prec \rangle$ be as above. Define

$\mu_{\mathcal{M}}(X) := \{x \in X : \exists \langle x, i \rangle \in \mathcal{U}. \neg \exists \langle x', i' \rangle \in \mathcal{U} (x' \in X \wedge \langle x', i' \rangle \prec \langle x, i \rangle)\}$.

Thus, $\mu_{\mathcal{M}}(X)$ is the projection on the first coordinate of the set of elements such that there is no smaller one in X .

Again, by abuse of language, we say that $\mu_{\mathcal{M}}(X)$ is the set of minimal elements of X in the structure. If the context is clear, we will also write just μ .

We sometimes say that $\langle x, i \rangle$ “kills” or “minimizes” $\langle y, j \rangle$ if $\langle x, i \rangle \prec \langle y, j \rangle$. By abuse of language we also say a set X kills or minimizes a set Y if for all $\langle y, j \rangle \in \mathcal{U}$, $y \in Y$ there is $\langle x, i \rangle \in \mathcal{U}$, $x \in X$ s.t. $\langle x, i \rangle \prec \langle y, j \rangle$.

\mathcal{M} is also called injective or 1-copy, iff there is always at most one copy $\langle x, i \rangle$ for each x . Note that the existence of copies corresponds to a non-injective labelling function - as is often used in nonclassical logic, e.g. modal logic.

We say that \mathcal{M} is transitive, irreflexive, etc., iff \prec is.

Note that $\mu(X)$ might well be empty, even if X is not.

karl-search= End Definition Pref-Str

3.1.2 Definition Pref-Log

karl-search= Start Definition Pref-Log

Definition 3.2

(+++ Orig. No.: Definition Pref-Log +++)

LABEL: Definition Pref-Log

We define the consequence relation of a preferential structure for a given propositional language \mathcal{L} .

(A)

(1) If m is a classical model of a language \mathcal{L} , we say by abuse of language

$\langle m, i \rangle \models \phi$ iff $m \models \phi$,

and if X is a set of such pairs, that

$X \models \phi$ iff for all $\langle m, i \rangle \in X$ $m \models \phi$.

(2) If \mathcal{M} is a preferential structure, and X is a set of \mathcal{L} -models for a classical propositional language \mathcal{L} , or a set of pairs $\langle m, i \rangle$, where the m are such models, we call \mathcal{M} a classical preferential structure or model.

(B)

Validity in a preferential structure, or the semantical consequence relation defined by such a structure:

Let \mathcal{M} be as above.

We define:

$T \models_{\mathcal{M}} \phi$ iff $\mu_{\mathcal{M}}(M(T)) \models \phi$, i.e. $\mu_{\mathcal{M}}(M(T)) \subseteq M(\phi)$.

\mathcal{M} will be called definability preserving iff for all $X \in \mathbf{D}_{\mathcal{L}}$ $\mu_{\mathcal{M}}(X) \in \mathbf{D}_{\mathcal{L}}$.

As $\mu_{\mathcal{M}}$ is defined on $\mathbf{D}_{\mathcal{L}}$, but need by no means always result in some new definable set, this is (and reveals itself as a quite strong) additional property.

karl-search= End Definition Pref-Log

3.1.3 Example NeedCopies

karl-search= Start Example NeedCopies

Example 3.1

(+++ Orig. No.: Example NeedCopies +++)

LABEL: Example NeedCopies

This simple example illustrates the importance of copies. Such examples seem to have appeared for the first time in print in [KLM90], but can probably be attributed to folklore.

Consider the propositional language \mathcal{L} of two propositional variables p, q , and the classical preferential model \mathcal{M} defined by

$m \models p \wedge q, m' \models p \wedge q, m_2 \models \neg p \wedge q, m_3 \models \neg p \wedge \neg q$, with $m_2 \prec m, m_3 \prec m'$, and let $\models_{\mathcal{M}}$ be its consequence relation. (m and m' are logically identical.)

Obviously, $Th(m) \vee \{\neg p\} \models_{\mathcal{M}} \neg p$, but there is no complete theory T' s.t. $Th(m) \vee T' \models_{\mathcal{M}} \neg p$. (If there were one, T' would correspond to m, m_2, m_3 , or the missing $m_4 \models p \wedge \neg q$, but we need two models to kill all copies of m .) On the other hand, if there were just one copy of m , then one other model, i.e. a complete theory would suffice. More formally, if we admit at most one copy of each model in a structure \mathcal{M} , $m \not\models T$, and $Th(m) \vee T \models_{\mathcal{M}} \phi$ for some ϕ s.t. $m \models \neg \phi$ - i.e. m is not minimal in the models of $Th(m) \vee T$ - then there is a complete T' with $T' \vdash T$ and $Th(m) \vee T' \models_{\mathcal{M}} \phi$, i.e. there is m'' with $m'' \models T'$ and $m'' \prec m$. \square

karl-search= End Example NeedCopies

3.1.4 Definition Smooth

karl-search= Start Definition Smooth

Definition 3.3

(+++ Orig. No.: Definition Smooth +++)

LABEL: Definition Smooth

Let $\mathcal{Y} \subseteq \mathcal{P}(U)$. (In applications to logic, \mathcal{Y} will be $\mathbf{D}_{\mathcal{L}}$.)

A preferential structure \mathcal{M} is called \mathcal{Y} -smooth iff for every $X \in \mathcal{Y}$ every element $x \in X$ is either minimal in X or above an element, which is minimal in X . More precisely:

(1) The version without copies:

If $x \in X \in \mathcal{Y}$, then either $x \in \mu(X)$ or there is $x' \in \mu(X).x' \prec x$.

(2) The version with copies:

If $x \in X \in \mathcal{Y}$, and $\langle x, i \rangle \in \mathcal{U}$, then either there is no $\langle x', i' \rangle \in \mathcal{U}, x' \in X, \langle x', i' \rangle \prec \langle x, i \rangle$ or there is $\langle x', i' \rangle \in \mathcal{U}, \langle x', i' \rangle \prec \langle x, i \rangle, x' \in X$, s.t. there is no $\langle x'', i'' \rangle \in \mathcal{U}, x'' \in X$, with $\langle x'', i'' \rangle \prec \langle x', i' \rangle$.

When considering the models of a language \mathcal{L} , \mathcal{M} will be called smooth iff it is $\mathbf{D}_{\mathcal{L}}$ -smooth; $\mathbf{D}_{\mathcal{L}}$ is the default.

Obviously, the richer the set \mathcal{Y} is, the stronger the condition \mathcal{Y} -smoothness will be.

karl-search= End Definition Smooth

3.1.5 ToolBase1-Rank-Base

karl-search= Start ToolBase1-Rank-Base

LABEL: Section Toolbase1-Rank-Base

3.1.6 Fact Rank-Base

karl-search= Start Fact Rank-Base

Fact 3.1

(+++ Orig. No.: Fact Rank-Base +++)

LABEL: Fact Rank-Base

Let \prec be an irreflexive, binary relation on X , then the following two conditions are equivalent:

(1) There is Ω and an irreflexive, total, binary relation \prec' on Ω and a function $f : X \rightarrow \Omega$ s.t. $x \prec y \leftrightarrow f(x) \prec' f(y)$ for all $x, y \in X$.

(2) Let $x, y, z \in X$ and $x \perp y$ wrt. \prec (i.e. neither $x \prec y$ nor $y \prec x$), then $z \prec x \rightarrow z \prec y$ and $x \prec z \rightarrow y \prec z$.

□

karl-search= End Fact Rank-Base

3.1.7 Definition Rank-Rel

karl-search= Start Definition Rank-Rel

Definition 3.4

(+++ Orig. No.: Definition Rank-Rel +++)

LABEL: Definition Rank-Rel

We call an irreflexive, binary relation \prec on X , which satisfies (1) (equivalently (2)) of Fact 3.1 (page 46) , ranked. By abuse of language, we also call a preferential structure $\langle X, \prec \rangle$ ranked, iff \prec is.

karl-search= End Definition Rank-Rel

karl-search= End ToolBase1-Pref-Base

3.2 General and smooth: Summary

3.2.1 ToolBase1-Pref-ReprSumm

karl-search= Start ToolBase1-Pref-ReprSumm

LABEL: Section Toolbase1-Pref-ReprSumm

3.2.2 Proposition Pref-Representation-With-Ref

karl-search= Start Proposition Pref-Representation-With-Ref

The following table summarizes representation by preferential structures. The positive implications on the right are shown in Proposition 2.9 (page 35) (going via the μ -functions), those on the left are shown in the respective representation theorems.

“singletons” means that the domain must contain all singletons, “1 copy” or “ ≥ 1 copy” means that the structure may contain only 1 copy for each point, or several, “ $(\mu\emptyset)$ ” etc. for the preferential structure mean that the μ -function of the structure has to satisfy this property. LABEL: Proposition Pref-Representation-With-Ref

μ - function ($\mu \subseteq$) + (μPR)		Pref.Structure general	$\Rightarrow (\mu dp)$	Logic (LLE) + (RW) + (SC) + (PR)
	\Leftarrow Fact 3.2 page 49		\Leftarrow	
	\Rightarrow Proposition 3.4 page 52		$\not\Leftarrow$ without (μdp) Example 3.2 page 51	
			$\not\Leftarrow$ without (μdp) Proposition 3.22 (1) page 75	any "normal" characterization of any size
($\mu \subseteq$) + (μPR)	\Leftarrow Fact 3.2 page 49	transitive	$\Rightarrow (\mu dp)$	(LLE) + (RW) + (SC) + (PR)
	\Rightarrow Proposition 3.7 page 55		\Leftarrow	
			$\not\Leftarrow$ without (μdp) Example 3.2 page 51	
			\Leftrightarrow without (μdp) See [Sch04]	using "small" exception sets
($\mu \subseteq$) + (μPR) + (μCUM)	\Leftarrow Fact 3.3 page 50	smooth	$\Rightarrow (\mu dp)$	(LLE) + (RW) + (SC) + (PR) + (CUM)
	$\Rightarrow (U)$ Proposition 3.12 page 61		$\Leftarrow (U)$	
	$\not\Leftarrow$ without (U) See [Sch04]		$\not\Leftarrow$ without (μdp) Example 3.2 page 51	
($\mu \subseteq$) + (μPR) + (μCUM)	\Leftarrow Fact 3.3 page 50	smooth+transitive	$\Rightarrow (\mu dp)$	(LLE) + (RW) + (SC) + (PR) + (CUM)
	$\Rightarrow (U)$ Proposition 3.20 page 71		$\Leftarrow (U)$	
			$\not\Leftarrow$ without (μdp) Example 3.2 page 51	
			\Leftrightarrow without (μdp) See [Sch04]	using "small" exception sets
($\mu \subseteq$) + ($\mu =$) + (μPR) + ($\mu ='$) + ($\mu \parallel$) + ($\mu \cup$) + ($\mu \cup'$) + ($\mu \in$) + ($\mu RatM$)	\Leftarrow Fact 4.4 page 77	ranked, ≥ 1 copy		
($\mu \subseteq$) + ($\mu =$) + (μPR) + ($\mu \cup$) + ($\mu \in$)	$\not\Leftarrow$ Example 4.1 page 82	ranked		
($\mu \subseteq$) + ($\mu =$) + ($\mu \emptyset$)	$\Leftrightarrow, (U)$ Proposition 4.5 (1) page 79	ranked, 1 copy + ($\mu \emptyset$)		
($\mu \subseteq$) + ($\mu =$) + ($\mu \emptyset$)	$\Leftrightarrow, (U)$ Proposition 4.5 (1) page 79	ranked, smooth, 1 copy + ($\mu \emptyset$)		
($\mu \subseteq$) + ($\mu =$) + ($\mu \emptyset fin$) + ($\mu \in$)	$\Leftrightarrow, (U)$, singletons Proposition 4.5 (2) page 79	ranked, smooth, ≥ 1 copy + ($\mu \emptyset fin$)		
($\mu \subseteq$) + (μPR) + ($\mu \parallel$) + ($\mu \cup$) + ($\mu \in$)	$\Leftrightarrow, (U)$, singletons Proposition 4.8 page 82	ranked ≥ 1 copy	$\not\Leftarrow$ without (μdp) Example 2.7 page 40	($RatM$), ($RatM =$), ($Log \cup$), ($Log \cup'$)
			$\not\Leftarrow$ without (μdp) Proposition 3.22 (2) page 75	any "normal" characterization of any size

karl-search= End Proposition Pref-Representation-With-Ref

3.2.3 Proposition Pref-Representation-Without-Ref

karl-search= Start Proposition Pref-Representation-Without-Ref

The following table summarizes representation by preferential structures.

"singletons" means that the domain must contain all singletons, "1 copy" or " ≥ 1 copy" means that the

structure may contain only 1 copy for each point, or several, " $(\mu\emptyset)$ " etc. for the preferential structure mean that the μ -function of the structure has to satisfy this property. LABEL: Proposition Pref-Representation-Without-Ref

μ -function		Pref.Structure		Logic
$(\mu \subseteq) + (\mu PR)$	\Leftarrow	general	$\Rightarrow (\mu dp)$	$(LLE) + (RW) + (SC) + (PR)$
	\Rightarrow		\Leftarrow	
			$\not\Leftarrow$ without (μdp) $\not\Leftarrow$ without (μdp)	
$(\mu \subseteq) + (\mu PR)$	\Leftarrow	transitive	$\Rightarrow (\mu dp)$	$(LLE) + (RW) + (SC) + (PR)$
	\Rightarrow		\Leftarrow	
			$\not\Leftarrow$ without (μdp) \Leftrightarrow without (μdp)	
$(\mu \subseteq) + (\mu PR) + (\mu CUM)$	\Leftarrow	smooth	$\Rightarrow (\mu dp)$	$(LLE) + (RW) + (SC) + (PR) + (CUM)$
	$\Rightarrow (\cup)$		$\Leftarrow (\cup)$	
			$\not\Leftarrow$ without (μdp)	
$(\mu \subseteq) + (\mu PR) + (\mu CUM)$	\Leftarrow	smooth+transitive	$\Rightarrow (\mu dp)$	$(LLE) + (RW) + (SC) + (PR) + (CUM)$
	$\Rightarrow (\cup)$		$\Leftarrow (\cup)$	
			$\not\Leftarrow$ without (μdp) \Leftrightarrow without (μdp)	
$(\mu \subseteq) + (\mu =) + (\mu PR) + (\mu =') + (\mu \parallel) + (\mu \cup) + (\mu \cup') + (\mu \in) + (\mu RatM)$	\Leftarrow	ranked, ≥ 1 copy		
$(\mu \subseteq) + (\mu =) + (\mu PR) + (\mu \cup) + (\mu \in)$	$\not\Leftarrow$	ranked		
$(\mu \subseteq) + (\mu =) + (\mu \emptyset)$	$\Leftrightarrow, (\cup)$	ranked, 1 copy + $(\mu \emptyset)$		
$(\mu \subseteq) + (\mu =) + (\mu \emptyset)$	$\Leftrightarrow, (\cup)$	ranked, smooth, 1 copy + $(\mu \emptyset)$		
$(\mu \subseteq) + (\mu =) + (\mu \emptyset fin) + (\mu \in)$	$\Leftrightarrow, (\cup)$, singletons	ranked, smooth, ≥ 1 copy + $(\mu \emptyset fin)$		
$(\mu \subseteq) + (\mu PR) + (\mu \parallel) + (\mu \cup) + (\mu \in)$	$\Leftrightarrow, (\cup)$, singletons	ranked ≥ 1 copy	$\not\Leftarrow$ without (μdp)	$(RatM), (RatM =), (Log\cup), (Log\cup')$
			$\not\Leftarrow$ without (μdp)	any "normal" characterization of any size

karl-search= End Proposition Pref-Representation-Without-Ref

3.2.4 Fact Pref-Sound

karl-search= Start Fact Pref-Sound

Fact 3.2

(+++ Orig. No.: Fact Pref-Sound +++)

LABEL: Fact Pref-Sound

$(\mu \subseteq)$ and (μPR) hold in all preferential structures.

karl-search= End Fact Pref-Sound

3.2.5 Fact Pref-Sound Proof

karl-search= Start Fact Pref-Sound Proof

Proof

(+++*** Orig.: Proof)

Trivial. The central argument is: if $x, y \in X \subseteq Y$, and $x \prec y$ in X , then also $x \prec y$ in Y .

□

karl-search= End Fact Pref-Sound Proof

3.2.6 Fact Smooth-Sound

karl-search= Start Fact Smooth-Sound

Fact 3.3

(+++ Orig. No.: Fact Smooth-Sound +++)

LABEL: Fact Smooth-Sound

$(\mu \subseteq)$, (μPR) , and (μCUM) hold in all smooth preferential structures.

karl-search= End Fact Smooth-Sound

3.2.7 Fact Smooth-Sound Proof

karl-search= Start Fact Smooth-Sound Proof

Proof

(+++*** Orig.: Proof)

By Fact 3.2 (page 49) , we only have to show (μCUM) . By Fact 2.7 (page 28) , (μCUT) follows from (μPR) , so it remains to show (μCM) . So suppose $\mu(X) \subseteq Y \subseteq X$, we have to show $\mu(Y) \subseteq \mu(X)$. Let $x \in X - \mu(X)$, so there is $x' \in X$, $x' \prec x$, by smoothness, there must be $x'' \in \mu(X)$, $x'' \prec x$, so $x'' \in Y$, and $x \notin \mu(Y)$. The proof for the case with copies is analogous.

karl-search= End Fact Smooth-Sound Proof

3.2.8 Example Pref-Dp

karl-search= Start Example Pref-Dp

Example 3.2

(+++ Orig. No.: Example Pref-Dp +++)

LABEL: Example Pref-Dp

This example was first given in [Sch92]. It shows that condition (PR) may fail in preferential structures which are not definability preserving.

Let $v(\mathcal{L}) := \{p_i : i \in \omega\}$, $n, n' \in M_{\mathcal{L}}$ be defined by $n \models \{p_i : i \in \omega\}$, $n' \models \{\neg p_0\} \cup \{p_i : 0 < i < \omega\}$.

Let $\mathcal{M} := \langle M_{\mathcal{L}}, \prec \rangle$ where only $n \prec n'$, i.e. just two models are comparable. Note that the structure is transitive and smooth. Thus, by Fact 3.3 (page 50) $(\mu \subseteq)$, (μPR) , (μCUM) hold.

Let $\mu := \mu_{\mathcal{M}}$, and \vdash be defined as usual by μ .

Set $T := \emptyset$, $T' := \{p_i : 0 < i < \omega\}$. We have $M_T = M_{\mathcal{L}}$, $f(M_T) = M_{\mathcal{L}} - \{n'\}$, $M_{T'} = \{n, n'\}$, $f(M_{T'}) = \{n\}$.

So by the result of Example 2.1 (page 18) , f is not definability preserving, and, furthermore, $\overline{\overline{T}} = \overline{\overline{T}}$, $\overline{\overline{T'}} = \overline{\overline{\{p_i : i < \omega\}}}$, so $p_0 \in \overline{\overline{T \cup T'}}$, but $\overline{\overline{T}} \cup T' = \overline{\overline{T}} \cup T' = \overline{\overline{T'}}$, so $p_0 \notin \overline{\overline{T}} \cup T'$, contradicting (PR), which holds in all definability preserving preferential structures \square

karl-search= End Example Pref-Dp

karl-search= End ToolBase1-Pref-ReprSumm

3.3 General: Representation

3.3.1 ToolBase1-Pref-ReprGen

karl-search= Start ToolBase1-Pref-ReprGen

LABEL: Section Toolbase1-Pref-ReprGen

3.3.2 Proposition Pref-Complete

karl-search= Start Proposition Pref-Complete

Proposition 3.4

(+++ Orig. No.: Proposition Pref-Complete +++)

LABEL: Proposition Pref-Complete

Let $\mu : \mathcal{Y} \rightarrow \mathcal{P}(U)$ satisfy $(\mu \sqsubseteq)$ and (μPR) . Then there is a preferential structure \mathcal{X} s.t. $\mu = \mu_{\mathcal{X}}$. See e.g. [Sch04].

karl-search= End Proposition Pref-Complete

3.3.3 Proposition Pref-Complete Proof

karl-search= Start Proposition Pref-Complete Proof

Proof

(+++** Orig.: Proof)

The preferential structure is defined in Construction 3.1 (page 53) , Claim 3.6 (page 54) shows representation. The construction is basic for much of the rest of the material on non-ranked structures.

3.3.4 Definition Y-Pi-x

karl-search= Start Definition Y-Pi-x

Definition 3.5

(+++ Orig. No.: Definition Y-Pi-x +++)

LABEL: Definition Y-Pi-x

For $x \in Z$, let $\mathcal{Y}_x := \{Y \in \mathcal{Y} : x \in Y - \mu(Y)\}$, $\Pi_x := \Pi \mathcal{Y}_x$.

Note that $\emptyset \notin \mathcal{Y}_x$, $\Pi_x \neq \emptyset$, and that $\Pi_x = \{\emptyset\}$ iff $\mathcal{Y}_x = \emptyset$.

karl-search= End Definition Y-Pi-x

3.3.5 Claim Mu-f

karl-search= Start Claim Mu-f

Claim 3.5

(+++ Orig. No.: Claim Mu-f +++)

LABEL: Claim Mu-f

Let $\mu : \mathcal{Y} \rightarrow \mathcal{P}(Z)$ satisfy $(\mu \subseteq)$ and (μPR) , and let $U \in \mathcal{Y}$. Then $x \in \mu(U) \leftrightarrow x \in U \wedge \exists f \in \Pi_x.ran(f) \cap U = \emptyset$.

karl-search= End Claim Mu-f

3.3.6 Claim Mu-f Proof

karl-search= Start Claim Mu-f Proof

Proof

(+++*** Orig.: Proof)

Case 1: $\mathcal{Y}_x = \emptyset$, thus $\Pi_x = \{\emptyset\}$. “ \rightarrow ”: Take $f := \emptyset$. “ \leftarrow ”: $x \in U \in \mathcal{Y}$, $\mathcal{Y}_x = \emptyset \rightarrow x \in \mu(U)$ by definition of \mathcal{Y}_x .

Case 2: $\mathcal{Y}_x \neq \emptyset$. “ \rightarrow ”: Let $x \in \mu(U) \subseteq U$. It suffices to show $Y \in \mathcal{Y}_x \rightarrow Y - U \neq \emptyset$. But if $Y \subseteq U$ and $Y \in \mathcal{Y}_x$, then $x \in Y - \mu(Y)$, contradicting (μPR) . “ \leftarrow ”: If $x \in U - \mu(U)$, then $U \in \mathcal{Y}_x$, so $\forall f \in \Pi_x.ran(f) \cap U \neq \emptyset$. \square

karl-search= End Claim Mu-f Proof

3.3.7 Construction Pref-Base

karl-search= Start Construction Pref-Base

Construction 3.1

(+++ Orig. No.: Construction Pref-Base +++)

LABEL: Construction Pref-Base

Let $\mathcal{X} := \{ \langle x, f \rangle : x \in Z \wedge f \in \Pi_x \}$, and $\langle x', f' \rangle \prec \langle x, f \rangle :\leftrightarrow x' \in ran(f)$. Let $\mathcal{Z} := \langle \mathcal{X}, \prec \rangle$.

karl-search= End Construction Pref-Base

3.3.8 Claim Pref-Rep-Base

karl-search= Start Claim Pref-Rep-Base

Claim 3.6

(+++ Orig. No.: Claim Pref-Rep-Base +++)

LABEL: Claim Pref-Rep-Base

For $U \in \mathcal{Y}$, $\mu(U) = \mu_Z(U)$.

karl-search= End Claim Pref-Rep-Base

3.3.9 Claim Pref-Rep-Base Proof

karl-search= Start Claim Pref-Rep-Base Proof

Proof

(+++*** Orig.: Proof)

By Claim 3.5 (page 53) , it suffices to show that for all $U \in \mathcal{Y}$ $x \in \mu_Z(U) \leftrightarrow x \in U$ and $\exists f \in \Pi_x.ran(f) \cap U = \emptyset$. So let $U \in \mathcal{Y}$. “ \rightarrow ”: If $x \in \mu_Z(U)$, then there is $\langle x, f \rangle$ minimal in $\mathcal{X}[U]$ (recall from Definition 1.1 (page 11) that $\mathcal{X}[U] := \{ \langle x, i \rangle \in \mathcal{X} : x \in U \}$), so $x \in U$, and there is no $\langle x', f' \rangle \prec \langle x, f \rangle$, $x' \in U$, so by $\Pi_{x'} \neq \emptyset$ there is no $x' \in ran(f)$, $x' \in U$, but then $ran(f) \cap U = \emptyset$. “ \leftarrow ”: If $x \in U$, and there is $f \in \Pi_x, ran(f) \cap U = \emptyset$, then $\langle x, f \rangle$ is minimal in $\mathcal{X}[U]$. \square (Claim 3.6 (page 54) and Proposition 3.4 (page 52))

karl-search= End Claim Pref-Rep-Base Proof

karl-search= End Proposition Pref-Complete Proof

3.3.10 Proposition Pref-Complete-Trans

karl-search= Start Proposition Pref-Complete-Trans

Proposition 3.7

(+++ Orig. No.: Proposition Pref-Complete-Trans +++)

LABEL: Proposition Pref-Complete-Trans

Let $\mu : \mathcal{Y} \rightarrow \mathcal{P}(U)$ satisfy $(\mu \subseteq)$ and (μPR) . Then there is a transitive preferential structure \mathcal{X} s.t. $\mu = \mu_{\mathcal{X}}$. See e.g. [Sch04].

karl-search= End Proposition Pref-Complete-Trans

3.3.11 Proposition Pref-Complete-Trans Proof

karl-search= Start Proposition Pref-Complete-Trans Proof

Proof

(+++*** Orig.: Proof)

3.3.12 Discussion Pref-Trans

karl-search= Start Discussion Pref-Trans

3.3.12.1 Discussion Pref-Trans

(+++*** Orig.: Discussion Pref-Trans)

LABEL: Section Discussion Pref-Trans

The Construction 3.1 (page 53) (also used in [Sch92]) cannot be made transitive as it is, this will be shown below in Example 3.3 (page 56) . The second construction in [Sch92] is a special one, which is transitive, but uses heavily lack of smoothness. (For completeness' sake, we give a similar proof in Proposition 3.11 (page 60) .) We present here a more flexibel and more adequate construction, which avoids a certain excess in the relation \prec of the construction in Proposition 3.11 (page 60) : There, too many elements $\langle y, g \rangle$ are smaller than some $\langle x, f \rangle$, as the relation is independent from g . This excess prevents transitivity.

We refine now the construction of the relation, to have better control over successors.

Recall that a tree of height $\leq \omega$ seems the right way to encode the successors of an element, as far as transitivity is concerned (which speaks only about finite chains). Now, in the basic construction, different copies have different successors, chosen by different functions (elements of the cartesian product). As it suffices to make one copy of the successor smaller than the element to be minimized, we do the following: Let $\langle x, g \rangle$, with $g \in \Pi\{X : x \in X - f(X)\}$ be one of the elements of the standard construction. Let $\langle x', g' \rangle$ be s.t. $x' \in \text{ran}(g)$, then we make again copies $\langle x, g, g' \rangle$, etc. for each such x' and g' , and make only $\langle x', g' \rangle$, but not some other $\langle x', g'' \rangle$ smaller than $\langle x, g, g' \rangle$, for some other $g'' \in \Pi\{X' : x' \in X' - f(X')\}$. Thus, we have a much more restricted relation, and much better control over it. More precisely, we make trees, where we mark all direct and indirect successors, and each time the choice is made by the appropriate choice functions of the cartesian product. An element with its tree is a successor of another element with its tree, iff the former is an initial segment of the latter - see the definition in Construction 3.2 (page 57) .

Recall also that transitivity is for free as we can use the element itself to minimize it. This is made precise by the use of the trees tf_x for a given element x and choice function f_x . But they also serve another purpose. The trees tf_x are constructed as follows: The root is x , the first branching is done according to f_x , and then

we continue with constant choice. Let, e.g. $x' \in \text{ran}(f_x)$, we can now always choose x' , as it will be a legal successor of x' itself, being present in all X' s.t. $x' \in X' - f(X')$. So we have a tree which branches once, directly above the root, and is then constant without branching. Obviously, this is essentially equivalent to the old construction in the not necessarily transitive case. This shows two things: first, the construction with trees gives the same μ as the old construction with simple choice functions. Second, even if we consider successors of successors, nothing changes: we are still with the old x' . Consequently, considering the transitive closure will not change matters, an element $\langle x, tf_x \rangle$ will be minimized by its direct successors iff it will be minimized by direct and indirect successors. If you like, the trees tf_x are the mathematical construction expressing the intuition that we know so little about minimization that we have to consider suicide a serious possibility - the intuitive reason why transitivity imposes no new conditions.

To summarize: Trees seem the right way to encode all the information needed for full control over successors for the transitive case. The special trees tf_x show that we have not changed things substantially, i.e. the new μ -functions in the simple case and for the transitive closure stay the same. We hope that this construction will show its usefulness in other contexts, its naturalness and generality seem to be a good promise.

We give below the example which shows that the old construction is too brutal for transitivity to hold.

Recall that transitivity permits substitution in the following sense: If (the two copies of) x is killed by y_1 and y_2 together, and y_1 is killed by z_1 and z_2 together, then x should be killed by z_1, z_2 , and y_2 together.

But the old construction substitutes too much: In the old construction, we considered elements $\langle x, f \rangle$, where $f \in \Pi_x$, with $\langle y, g \rangle < \langle x, f \rangle$ iff $y \in \text{ran}(f)$, independent of g . This construction can, in general, not be made transitive, as Example 3.3 (page 56) below shows.

The new construction avoids this, as it “looks ahead”, and not all elements $\langle y_1, t_{y_1} \rangle$ are smaller than $\langle x, t_x \rangle$, where y_1 is a child of x in t_x (or $y_1 \in \text{ran}(f)$). The new construction is basically the same as Construction 3.1 (page 53) , but avoids to make too many copies smaller than the copy to be killed.

Recall that we need no new properties of μ to achieve transitivity here, as a killed element x might (partially) “commit suicide”, i.e. for some $i, i' < x, i \rangle < \langle x, i' \rangle$, so we cannot substitute x by any set which does not contain x : In this simple situation, if $x \in X - \mu(X)$, we cannot find out whether all copies of x are killed by some $y \neq x, y \in X$. We can assume without loss of generality that there is an infinite descending chain of x -copies, which are not killed by other elements. Thus, we cannot replace any y_i as above by any set which does not contain y_i , but then substitution becomes trivial, as any set substituting y_i has to contain y_i . Thus, we need no new properties to achieve transitivity.

karl-search= End Discussion Pref-Trans

3.3.13 Example Trans-1

karl-search= Start Example Trans-1

Example 3.3

(+++ Orig. No.: Example Trans-1 +++)

LABEL: Example Trans-1

As we consider only one set in each case, we can index with elements, instead of with functions. So suppose $x, y_1, y_2 \in X, y_1, z_1, z_2 \in Y, x \notin \mu(X), y_1 \notin \mu(Y)$, and that we need y_1 and y_2 to minimize x , so there are two copies $\langle x, y_1 \rangle, \langle x, y_2 \rangle$, likewise we need z_1 and z_2 to minimize y_1 , thus we have $\langle x, y_1 \rangle \succ \langle y_1, z_1 \rangle, \langle x, y_1 \rangle \succ \langle y_1, z_2 \rangle, \langle x, y_2 \rangle \succ y_2, \langle y_1, z_1 \rangle \succ z_1, \langle y_1, z_2 \rangle \succ z_2$ (the z_i and y_2 are not killed). If we take the transitive closure, we have $\langle x, y_1 \rangle \succ z_k$ for any i, k , so for any $z_k \{z_k, y_2\}$ will minimize all of x , which is not intended. □

karl-search= End Example Trans-1

The preferential structure is defined in Construction 3.2 (page 57) , Claim 3.9 (page 58) shows representation for the simple structure, Claim 3.10 (page 59) representation for the transitive closure of the structure.

The main idea is to use the trees tf_x , whose elements are exactly the elements of the range of the choice function f . This makes Construction 3.1 (page 53) and Construction 3.2 (page 57) basically equivalent, and shows that the transitive case is characterized by the same conditions as the general case. These trees are defined below in Fact 3.8 (page 57) , (3), and used in the proofs of Claim 3.9 (page 58) and Claim 3.10 (page 59) .

Again, Construction 3.2 (page 57) contains the basic idea for the treatment of the transitive case. It can certainly be re-used in other contexts.

3.3.14 Construction Pref-Trees

karl-search= Start Construction Pref-Trees

Construction 3.2

(+++ Orig. No.: Construction Pref-Trees +++)

LABEL: Construction Pref-Trees

- (1) For $x \in Z$, let T_x be the set of trees t_x s.t.
 - (a) all nodes are elements of Z ,
 - (b) the root of t_x is x ,
 - (c) $height(t_x) \leq \omega$,
 - (d) if y is an element in t_x , then there is $f \in \Pi_y := \Pi\{Y \in \mathcal{Y}: y \in Y - \mu(Y)\}$ s.t. the set of children of y is $ran(f)$.
- (2) For $x, y \in Z$, $t_x \in T_x$, $t_y \in T_y$, set $t_x \triangleright t_y$ iff y is a (direct) child of the root x in t_x , and t_y is the subtree of t_x beginning at y .
- (3) Let $\mathcal{Z} := \langle \langle x, t_x \rangle: x \in Z, t_x \in T_x \rangle, \langle x, t_x \rangle \succ \langle y, t_y \rangle$ iff $t_x \triangleright t_y \rangle$.

karl-search= End Construction Pref-Trees

3.3.15 Fact Pref-Trees

karl-search= Start Fact Pref-Trees

Fact 3.8

(+++ Orig. No.: Fact Pref-Trees +++)

LABEL: Fact Pref-Trees

- (1) The construction ends at some y iff $\mathcal{Y}_y = \emptyset$, consequently $T_x = \{x\}$ iff $\mathcal{Y}_x = \emptyset$. (We identify the tree of height 1 with its root.)
- (2) If $\mathcal{Y}_x \neq \emptyset$, tc_x , the totally ordered tree of height ω , branching with $card = 1$, and with all elements equal to x is an element of T_x . Thus, with (1), $T_x \neq \emptyset$ for any x .

- (3) If $f \in \Pi_x$, $f \neq \emptyset$, then the tree tf_x with root x and otherwise composed of the subtrees t_y for $y \in \text{ran}(f)$, where $t_y := y$ iff $\mathcal{Y}_y = \emptyset$, and $t_y := tc_y$ iff $\mathcal{Y}_y \neq \emptyset$, is an element of T_x . (Level 0 of tf_x has x as element, the t'_y s begin at level 1.)
- (4) If y is an element in t_x and t_y the subtree of t_x starting at y , then $t_y \in T_y$.
- (5) $\langle x, t_x \rangle \succ \langle y, t_y \rangle$ implies $y \in \text{ran}(f)$ for some $f \in \Pi_x$. \square

karl-search= End Fact Pref-Trees

3.3.16 Claim Tree-Repres-1

karl-search= Start Claim Tree-Repres-1

Claim 3.9 (page 58) shows basic representation.

Claim 3.9

(+++ Orig. No.: Claim Tree-Repres-1 +++)

LABEL: Claim Tree-Repres-1

$\forall U \in \mathcal{Y}. \mu(U) = \mu_{\mathcal{Z}}(U)$

karl-search= End Claim Tree-Repres-1

3.3.17 Claim Tree-Repres-1 Proof

karl-search= Start Claim Tree-Repres-1 Proof

Proof

(+++*** Orig.: Proof)

By Claim 3.5 (page 53), it suffices to show that for all $U \in \mathcal{Y}$ $x \in \mu_{\mathcal{Z}}(U) \leftrightarrow x \in U \wedge \exists f \in \Pi_x. \text{ran}(f) \cap U = \emptyset$. Fix $U \in \mathcal{Y}$. “ \rightarrow ”: $x \in \mu_{\mathcal{Z}}(U) \rightarrow$ ex. $\langle x, t_x \rangle$ minimal in $\mathcal{Z}[U]$, thus $x \in U$ and there is no $\langle y, t_y \rangle \in \mathcal{Z}$, $\langle y, t_y \rangle \prec \langle x, t_x \rangle$, $y \in U$. Let f define the set of children of the root x in t_x . If $\text{ran}(f) \cap U \neq \emptyset$, if $y \in U$ is a child of x in t_x , and if t_y is the subtree of t_x starting at y , then $t_y \in T_y$ and $\langle y, t_y \rangle \prec \langle x, t_x \rangle$, contradicting minimality of $\langle x, t_x \rangle$ in $\mathcal{Z}[U]$. So $\text{ran}(f) \cap U = \emptyset$. “ \leftarrow ”: Let $x \in U$. If $\mathcal{Y}_x = \emptyset$, then the tree x has no \triangleright -successors, and $\langle x, x \rangle$ is \succ -minimal in \mathcal{Z} . If $\mathcal{Y}_x \neq \emptyset$ and $f \in \Pi_x$ s.t. $\text{ran}(f) \cap U = \emptyset$, then $\langle x, tf_x \rangle$ is \succ -minimal in $\mathcal{Z}[U]$. \square

karl-search= End Claim Tree-Repres-1 Proof

3.3.18 Claim Tree-Repres-2

karl-search= Start Claim Tree-Repres-2

We consider now the transitive closure of \mathcal{Z} . (Recall that \prec^* denotes the transitive closure of \prec .) Claim 3.10 (page 59) shows that transitivity does not destroy what we have achieved. The trees tf_x will play a crucial role in the demonstration.

Claim 3.10

(+++ Orig. No.: Claim Tree-Repres-2 +++)

LABEL: Claim Tree-Repres-2

Let $\mathcal{Z}' := \langle \{ \langle x, t_x \rangle : x \in Z, t_x \in T_x \}, \langle x, t_x \rangle \prec \langle y, t_y \rangle \text{ iff } t_x \triangleright^* t_y \rangle$. Then $\mu_{\mathcal{Z}} = \mu_{\mathcal{Z}'}$.

karl-search= End Claim Tree-Repres-2

3.3.19 Claim Tree-Repres-2 Proof

karl-search= Start Claim Tree-Repres-2 Proof

Proof

(+++*** Orig.: Proof)

Suppose there is $U \in \mathcal{Y}$, $x \in U$, $x \in \mu_{\mathcal{Z}}(U)$, $x \notin \mu_{\mathcal{Z}'}(U)$. Then there must be an element $\langle x, t_x \rangle \in \mathcal{Z}$ with no $\langle x, t_x \rangle \succ \langle y, t_y \rangle$ for any $y \in U$. Let $f \in \Pi_x$ determine the set of children of x in t_x , then $\text{ran}(f) \cap U = \emptyset$, consider tf_x . As all elements $\neq x$ of tf_x are already in $\text{ran}(f)$, no element of tf_x is in U . Thus there is no $\langle z, t_z \rangle \prec^* \langle x, tf_x \rangle$ in \mathcal{Z} with $z \in U$, so $\langle x, tf_x \rangle$ is minimal in $\mathcal{Z}' \upharpoonright U$, contradiction. \square (Claim 3.10 (page 59) and Proposition 3.7 (page 55))

karl-search= End Claim Tree-Repres-2 Proof

karl-search= End Proposition Pref-Complete-Trans Proof

3.3.20 Proposition Equiv-Trans

karl-search= Start Proposition Equiv-Trans

We give now the direct proof, which we cannot adapt to the smooth case. Such easy results must be part of the folklore, but we give them for completeness' sake.

Proposition 3.11

(+++ Orig. No.: Proposition Equiv-Trans +++)

LABEL: Proposition Equiv-Trans

In the general case, every preferential structure is equivalent to a transitive one - i.e. they have the same μ -functions.

karl-search= End Proposition Equiv-Trans

3.3.21 Proposition Equiv-Trans Proof

karl-search= Start Proposition Equiv-Trans Proof

Proof

(+++*** Orig.: Proof)

If $\langle a, i \rangle \succ \langle b, j \rangle$, we create an infinite descending chain of new copies $\langle b, \langle j, a, i, n \rangle \rangle$, $n \in \omega$, where $\langle b, \langle j, a, i, n \rangle \rangle \succ \langle b, \langle j, a, i, n' \rangle \rangle$ if $n' > n$, and make $\langle a, i \rangle \succ \langle b, \langle j, a, i, n \rangle \rangle$ for all $n \in \omega$, but cancel the pair $\langle a, i \rangle \succ \langle b, j \rangle$ from the relation (otherwise, we would not have achieved anything), but $\langle b, j \rangle$ stays as element in the set. Now, the relation is trivially transitive, and all these $\langle b, \langle j, a, i, n \rangle \rangle$ just kill themselves, there is no need to minimize them by anything else. We just continued $\langle a, i \rangle \succ \langle b, j \rangle$ in a way it cannot bother us. For the $\langle b, j \rangle$, we do of course the same thing again. So, we have full equivalence, i.e. the μ -functions of both structures are identical (this is trivial to see). \square

karl-search= End Proposition Equiv-Trans Proof

karl-search= End ToolBase1-Pref-ReprGen

3.4 Smooth: Representation

3.4.1 ToolBase1-Pref-ReprSmooth

karl-search= Start ToolBase1-Pref-ReprSmooth

LABEL: Section Toolbase1-Pref-ReprSmooth

3.4.2 Proposition Smooth-Complete

karl-search= Start Proposition Smooth-Complete

Proposition 3.12

(+++ Orig. No.: Proposition Smooth-Complete +++)

LABEL: Proposition Smooth-Complete

Let $\mu : \mathcal{Y} \rightarrow \mathcal{P}(U)$ satisfy $(\mu \subseteq)$, (μPR) , and (μCUM) , and the domain $\mathcal{Y} (\cup)$.

Then there is a \mathcal{Y} -smooth preferential structure \mathcal{X} s.t. $\mu = \mu_{\mathcal{X}}$. See e.g. [Sch04].

karl-search= End Proposition Smooth-Complete

3.4.3 Proposition Smooth-Complete Proof

karl-search= Start Proposition Smooth-Complete Proof

Proof

(+++*** Orig.: Proof)

3.4.4 Comment Smooth-Complete Proof

karl-search= Start Comment Smooth-Complete Proof

Outline: We first define a structure \mathcal{Z} (in a way very similar to Construction 3.1 (page 53)) which represents μ , but is not necessarily \mathcal{Y} -smooth, refine it to \mathcal{Z}' and show that \mathcal{Z}' represents μ too, and that \mathcal{Z}' is \mathcal{Y} -smooth.

In the structure \mathcal{Z}' , all pairs destroying smoothness in \mathcal{Z} are successively repaired, by adding minimal elements: If $\langle y, j \rangle$ is not minimal, and has no minimal $\langle x, i \rangle$ below it, we just add one such $\langle x, i \rangle$. As the repair process might itself generate such “bad” pairs, the process may have to be repeated infinitely often. Of course, one has to take care that the representation property is preserved.

The proof given is close to the minimum one has to show (except that we avoid $H(U)$, instead of U - as was done in the old proof of [Sch96-1]). We could simplify further, we do not, in order to stay closer to the construction that is really needed. The reader will find the simplification as building block of the proof of the transitive case. (In the simplified proof, we would consider for x, U s.t. $x \in \mu(U)$ the pairs $\langle x, g_U \rangle$ with $g_U \in \Pi\{\mu(U \cup Y) : x \in Y \not\subseteq H(U)\}$, giving minimal elements. For the U s.t. $x \in U - \mu(U)$, we would choose $\langle x, g \rangle$ s.t. $g \in \Pi\{\mu(Y) : x \in Y \in \mathcal{Y}\}$ with $\langle x', g'_U \rangle \prec \langle x, g \rangle$ for $\langle x', g'_U \rangle$ as above.)

Construction 3.3 (page 66) represents μ . The structure will not yet be smooth, we will mend it afterwards in Construction 3.4 (page 68) .

karl-search= End Comment Smooth-Complete Proof

3.4.5 Comment HU

karl-search= Start Comment HU

3.4.5.1 The constructions

(+++*** Orig.: The constructions)

LABEL: Section The constructions

Y will be closed under finite unions throughout this Section. We first define H(U), and show some facts about it. H(U) has an important role, for the following reason: If u in mu(U), but u in X - mu(X), then there is x in mu(X) - H(U). Consequently, to kill minimality of u in X, we can choose x in mu(X) - H(U), x < u, without interfering with u's minimality in U. Moreover, if x in Y - mu(Y), then, by x not in H(U), mu(Y) not subset H(U), so we can kill minimality of x in Y by choosing some y not in H(U). Thus, even in the transitive case, we can leave U to destroy minimality of u in some X, without ever having to come back into U, it suffices to choose sufficiently far from U, i.e. outside H(U). H(U) is the right notion of "neighborhood".

Note: Not all z in Z have to occur in our structure, therefore it is quite possible that X in Y, X not empty, but mu_Z(X) = empty. This is why we have introduced the set K in Definition 3.7 (page 62) and such X will be subsets of Z-K.

Let now mu : Y -> P(Z).

karl-search= End Comment HU

3.4.6 Definition HU

karl-search= Start Definition HU

Definition 3.6

(+++ Orig. No.: Definition HU +++)

LABEL: Definition HU

Define H(U) := union{X : mu(X) subset U}.

karl-search= End Definition HU

3.4.7 Definition K

karl-search= Start Definition K

Definition 3.7

(+++ Orig. No.: Definition K +++)

LABEL: Definition K

Let K := {x in Z : exists X in Y. x in mu(X)}

karl-search= End Definition K

3.4.8 Fact HU-1

karl-search= Start Fact HU-1

Fact 3.13

(+++ Orig. No.: Fact HU-1 +++)

LABEL: Fact HU-1

$(\mu \subseteq) + (\mu PR) + (\mu CUM) + (\cup)$ entail:

- (1) $\mu(A) \subseteq B \rightarrow \mu(A \cup B) = \mu(B)$
- (2) $\mu(X) \subseteq U, U \subseteq Y \rightarrow \mu(Y \cup X) = \mu(Y)$
- (3) $\mu(X) \subseteq U, U \subseteq Y \rightarrow \mu(Y) \cap X \subseteq \mu(U)$
- (4) $\mu(X) \subseteq U \rightarrow \mu(U) \cap X \subseteq \mu(X)$
- (5) $U \subseteq A, \mu(A) \subseteq H(U) \rightarrow \mu(A) \subseteq U$
- (6) Let $x \in K, Y \in \mathcal{Y}, x \in Y - \mu(Y)$, then $\mu(Y) \neq \emptyset$.

karl-search= End Fact HU-1

3.4.9 Fact HU-1 Proof

karl-search= Start Fact HU-1 Proof

Proof

(+++*** Orig.: Proof)

- (1) $\mu(A) \subseteq B \rightarrow \mu(A \cup B) \subseteq \mu(A) \cup \mu(B) \subseteq B \xrightarrow{(\mu CUM)} \mu(B) = \mu(A \cup B)$.
- (2) trivial by (1).
- (3) $\mu(Y) \cap X = (\text{by (2)}) \mu(Y \cup X) \cap X \subseteq \mu(Y \cup X) \cap (X \cup U) \subseteq (\text{by } (\mu PR)) \mu(X \cup U) = (\text{by (1)}) \mu(U)$.
- (4) $\mu(U) \cap X = \mu(X \cup U) \cap X$ by (1) $\subseteq \mu(X)$ by (μPR)
- (5) Let $U \subseteq A, \mu(A) \subseteq H(U)$. So $\mu(A) = \bigcup \{ \mu(A) \cap Y : \mu(Y) \subseteq U \} \subseteq \mu(U) \subseteq U$ by (3).
- (6) Suppose $x \in \mu(X), \mu(Y) = \emptyset \rightarrow \mu(Y) \subseteq X$, so by (4) $Y \cap \mu(X) \subseteq \mu(Y)$, so $x \in \mu(Y)$.

□

karl-search= End Fact HU-1 Proof

3.4.10 Fact HU-2

karl-search= Start Fact HU-2

The following Fact 3.14 (page 64) contains the basic properties of μ and $H(U)$ which we will need for the representation construction.

Fact 3.14

(+++ Orig. No.: Fact HU-2 +++)

LABEL: Fact HU-2

Let A, U, U', Y and all A_i be in \mathcal{Y} . Let $(\mu \subseteq) + (\mu PR) + (\cup)$ hold.

- (1) $A = \bigcup\{A_i : i \in I\} \rightarrow \mu(A) \subseteq \bigcup\{\mu(A_i) : i \in I\}$,
- (2) $U \subseteq H(U)$, and $U \subseteq U' \rightarrow H(U) \subseteq H(U')$,
- (3) $\mu(U \cup Y) - H(U) \subseteq \mu(Y)$.

If, in addition, (μCUM) holds, then we also have:

- (4) $U \subseteq A, \mu(A) \subseteq H(U) \rightarrow \mu(A) \subseteq U$,
- (5) $\mu(Y) \subseteq H(U) \rightarrow Y \subseteq H(U)$ and $\mu(U \cup Y) = \mu(U)$,
- (6) $x \in \mu(U), x \in Y - \mu(Y) \rightarrow Y \not\subseteq H(U)$,
- (7) $Y \not\subseteq H(U) \rightarrow \mu(U \cup Y) \not\subseteq H(U)$.

karl-search= End Fact HU-2

3.4.11 Fact HU-2 Proof

karl-search= Start Fact HU-2 Proof

Proof

(+++*** Orig.: Proof)

- (1) $\mu(A) \cap A_j \subseteq \mu(A_j) \subseteq \bigcup \mu(A_i)$, so by $\mu(A) \subseteq A = \bigcup A_i \mu(A) \subseteq \bigcup \mu(A_i)$.
- (2) trivial.
- (3) $\mu(U \cup Y) - H(U) \subseteq_{(2)} \mu(U \cup Y) - U \subseteq_{(\mu \subseteq)} \mu(U \cup Y) \cap Y \subseteq_{(\mu PR)} \mu(Y)$.
- (4) This is Fact 3.13 (page 63) (5).
- (5) Let $\mu(Y) \subseteq H(U)$, then by $\mu(U) \subseteq H(U)$ and (1) $\mu(U \cup Y) \subseteq \mu(U) \cup \mu(Y) \subseteq H(U)$, so by (4) $\mu(U \cup Y) \subseteq U$ and $U \cup Y \subseteq H(U)$. Moreover, $\mu(U \cup Y) \subseteq U \subseteq U \cup Y \rightarrow_{(\mu CUM)} \mu(U \cup Y) = \mu(U)$.
- (6) If not, $Y \subseteq H(U)$, so $\mu(Y) \subseteq H(U)$, so $\mu(U \cup Y) = \mu(U)$ by (5), but $x \in Y - \mu(Y) \rightarrow_{(\mu PR)} x \notin \mu(U \cup Y) = \mu(U)$, *contradiction*.
- (7) $\mu(U \cup Y) \subseteq H(U) \rightarrow_{(5)} U \cup Y \subseteq H(U)$. \square

karl-search= End Fact HU-2 Proof

3.4.12 Definition Gamma-x

karl-search= Start Definition Gamma-x

Definition 3.8

(+++ Orig. No.: Definition Gamma-x +++)

LABEL: Definition Gamma-x

For $x \in Z$, let $\mathcal{W}_x := \{\mu(Y) : Y \in \mathcal{Y} \wedge x \in Y - \mu(Y)\}$, $\Gamma_x := \Pi\mathcal{W}_x$, and $K := \{x \in Z : \exists X \in \mathcal{Y}. x \in \mu(X)\}$.

Note that we consider here now $\mu(Y)$ in \mathcal{W}_x , and not Y as in \mathcal{Y}_x in Definition 3.5 (page 52) .

karl-search= End Definition Gamma-x

3.4.13 Remark Gamma-x

karl-search= Start Remark Gamma-x

Remark 3.15

(+++ Orig. No.: Remark Gamma-x +++)

LABEL: Remark Gamma-x

Assume now $(\mu \subseteq)$, (μPR) , (μCUM) , (\cup) to hold.

- (1) $x \in K \rightarrow \Gamma_x \neq \emptyset$,
- (2) $g \in \Gamma_x \rightarrow \text{ran}(g) \subseteq K$.

karl-search= End Remark Gamma-x

3.4.14 Remark Gamma-x Proof

karl-search= Start Remark Gamma-x Proof

Proof

(+++*** Orig.: Proof)

- (1) We have to show that $Y \in \mathcal{Y}$, $x \in Y - \mu(Y) \rightarrow \mu(Y) \neq \emptyset$. This was shown in Fact 3.13 (page 63) (6).
- (2) By definition, $\mu(Y) \subseteq K$ for all $Y \in \mathcal{Y}$. \square

karl-search= End Remark Gamma-x Proof

3.4.15 Claim Cum-Mu-f

karl-search= Start Claim Cum-Mu-f

The following claim is the analogue of Claim 3.5 (page 53) above.

Claim 3.16

(+++ Orig. No.: Claim Cum-Mu-f +++)

LABEL: Claim Cum-Mu-f

Assume now $(\mu \subseteq)$, (μPR) , (μCUM) , (\cup) to hold.

Let $U \in \mathcal{Y}$, $x \in K$. Then

- (1) $x \in \mu(U) \leftrightarrow x \in U \wedge \exists f \in \Gamma_x.ran(f) \cap U = \emptyset$,
- (2) $x \in \mu(U) \leftrightarrow x \in U \wedge \exists f \in \Gamma_x.ran(f) \cap H(U) = \emptyset$.

karl-search= End Claim Cum-Mu-f

3.4.16 Claim Cum-Mu-f Proof

karl-search= Start Claim Cum-Mu-f Proof

Proof

(+++*** Orig.: Proof)

(1) Case 1: $\mathcal{W}_x = \emptyset$, thus $\Gamma_x = \{\emptyset\}$. “ \rightarrow ”: Take $f := \emptyset$. “ \leftarrow ”: $x \in U \in \mathcal{Y}$, $\mathcal{W}_x = \emptyset \rightarrow x \in \mu(U)$ by definition of \mathcal{W}_x .

Case 2: $\mathcal{W}_x \neq \emptyset$. “ \rightarrow ”: Let $x \in \mu(U) \subseteq U$. It suffices to show $Y \in \mathcal{W}_x \rightarrow \mu(Y) - H(U) \neq \emptyset$. But $Y \in \mathcal{W}_x \rightarrow x \in Y - \mu(Y) \rightarrow$ (by Fact 3.14 (page 64) , (6)) $Y \not\subseteq H(U) \rightarrow$ (by Fact 3.14 (page 64) , (5)) $\mu(Y) \not\subseteq H(U)$. “ \leftarrow ”: If $x \in U - \mu(U)$, $U \in \mathcal{W}_x$, moreover $\Gamma_x \neq \emptyset$ by Remark 3.15 (page 65) , (1) and thus (or by the same argument) $\mu(U) \neq \emptyset$, so $\forall f \in \Gamma_x.ran(f) \cap U \neq \emptyset$.

(2): The proof is verbatim the same as for (1). \square

karl-search= End Claim Cum-Mu-f Proof

Proof: (Prop. 6.14)

(+++*** Orig.: Proof: (Prop. 6.14))

LABEL: Section Proof: (Prop. 6.14)

3.4.17 Construction Smooth-Base

karl-search= Start Construction Smooth-Base

Construction 3.3

(+++ Orig. No.: Construction Smooth-Base +++)

LABEL: Construction Smooth-Base

(Construction of \mathcal{Z}) Let $\mathcal{X} := \{ \langle x, g \rangle : x \in K, g \in \Gamma_x \}$, $\langle x', g' \rangle \prec \langle x, g \rangle :\leftrightarrow x' \in ran(g)$, $\mathcal{Z} := \langle \mathcal{X}, \prec \rangle$.

karl-search= End Construction Smooth-Base

3.4.18 Claim Smooth-Base

karl-search= Start Claim Smooth-Base

Claim 3.17

(+++ Orig. No.: Claim Smooth-Base +++)

LABEL: Claim Smooth-Base

$$\forall U \in \mathcal{Y}. \mu(U) = \mu_{\mathcal{Z}}(U)$$

karl-search= End Claim Smooth-Base

3.4.19 Claim Smooth-Base Proof

karl-search= Start Claim Smooth-Base Proof

Proof

(+++*** Orig.: Proof)

Case 1: $x \notin K$. Then $x \notin \mu(U)$ and $x \notin \mu_{\mathcal{Z}}(U)$.

Case 2: $x \in K$. By Claim 3.16 (page 66) , (1) it suffices to show that for all $U \in \mathcal{Y}$ $x \in \mu_{\mathcal{Z}}(U) \leftrightarrow x \in U \wedge \exists f \in \Gamma_x. \text{ran}(f) \cap U = \emptyset$. Fix $U \in \mathcal{Y}$. “ \rightarrow ”: $x \in \mu_{\mathcal{Z}}(U) \rightarrow$ ex. $\langle x, f \rangle$ minimal in $\mathcal{X}[U]$, thus $x \in U$ and there is no $\langle x', f' \rangle \prec \langle x, f \rangle$, $x' \in U$, $x' \in K$. But if $x' \in K$, then by Remark 3.15 (page 65) , (1), $\Gamma_{x'} \neq \emptyset$, so we find suitable f' . Thus, $\forall x' \in \text{ran}(f). x' \notin U$ or $x' \notin K$. But $\text{ran}(f) \subseteq K$, so $\text{ran}(f) \cap U = \emptyset$. “ \leftarrow ”: If $x \in U$, $f \in \Gamma_x$ s.t. $\text{ran}(f) \cap U = \emptyset$, then $\langle x, f \rangle$ is minimal in $\mathcal{X}[U]$.

□

karl-search= End Claim Smooth-Base Proof

3.4.20 Construction Smooth-Admiss

karl-search= Start Construction Smooth-Admiss

We now construct the refined structure \mathcal{Z}' .

Construction 3.4

(+++ Orig. No.: Construction Smooth-Admiss +++)

LABEL: Construction Smooth-Admiss

(Construction of \mathcal{Z}')

σ is called x -admissible sequence iff

1. σ is a sequence of length $\leq \omega$, $\sigma = \{\sigma_i : i \in \omega\}$,
2. $\sigma_0 \in \Pi\{\mu(Y) : Y \in \mathcal{Y} \wedge x \in Y - \mu(Y)\}$,
3. $\sigma_{i+1} \in \Pi\{\mu(X) : X \in \mathcal{Y} \wedge x \in \mu(X) \wedge \text{ran}(\sigma_i) \cap X \neq \emptyset\}$.

By 2., σ_0 minimizes x , and by 3., if $x \in \mu(X)$, and $\text{ran}(\sigma_i) \cap X \neq \emptyset$, i.e. we have destroyed minimality of x in X , x will be above some y minimal in X to preserve smoothness.

Let Σ_x be the set of x -admissible sequences, for $\sigma \in \Sigma_x$ let $\widehat{\sigma} := \bigcup\{\text{ran}(\sigma_i) : i \in \omega\}$. Note that by the argument in the proof of Remark 3.15 (page 65), (1), $\Sigma_x \neq \emptyset$, if $x \in K$.

Let $\mathcal{X}' := \{\langle x, \sigma \rangle : x \in K \wedge \sigma \in \Sigma_x\}$ and $\langle x', \sigma' \rangle \prec' \langle x, \sigma \rangle := x' \in \widehat{\sigma}$. Finally, let $\mathcal{Z}' := \langle \mathcal{X}', \prec' \rangle$, and $\mu' := \mu_{\mathcal{Z}'}$.

It is now easy to show that \mathcal{Z}' represents μ , and that \mathcal{Z}' is smooth. For $x \in \mu(U)$, we construct a special x -admissible sequence $\sigma^{x,U}$ using the properties of $H(U)$.

karl-search= End Construction Smooth-Admiss

3.4.21 Claim Smooth-Admiss-1

karl-search= Start Claim Smooth-Admiss-1

Claim 3.18

(+++ Orig. No.: Claim Smooth-Admiss-1 +++)

LABEL: Claim Smooth-Admiss-1

For all $U \in \mathcal{Y}$ $\mu(U) = \mu_{\mathcal{Z}}(U) = \mu'(U)$.

karl-search= End Claim Smooth-Admiss-1

3.4.22 Claim Smooth-Admiss-1 Proof

karl-search= Start Claim Smooth-Admiss-1 Proof

Proof

(+++*** Orig.: Proof)

If $x \notin K$, then $x \notin \mu_{\mathcal{Z}}(U)$, and $x \notin \mu'(U)$ for any U . So assume $x \in K$. If $x \in U$ and $x \notin \mu_{\mathcal{Z}}(U)$, then for all $\langle x, f \rangle \in \mathcal{X}$, there is $\langle x', f' \rangle \in \mathcal{X}$ with $\langle x', f' \rangle \prec \langle x, f \rangle$ and $x' \in U$. Let now $\langle x, \sigma \rangle \in \mathcal{X}'$, then $\langle x, \sigma_0 \rangle \in \mathcal{X}$, and let $\langle x', f' \rangle \prec \langle x, \sigma_0 \rangle$ in \mathcal{Z} with $x' \in U$. As $x' \in K$, $\Sigma_{x'} \neq \emptyset$, let $\sigma' \in \Sigma_{x'}$. Then $\langle x', \sigma' \rangle \prec' \langle x, \sigma \rangle$ in \mathcal{Z}' . Thus $x \notin \mu'(U)$. Thus, for all $U \in \mathcal{Y}$, $\mu'(U) \subseteq \mu_{\mathcal{Z}}(U) = \mu(U)$.

It remains to show $x \in \mu(U) \rightarrow x \in \mu'(U)$.

Assume $x \in \mu(U)$ (so $x \in K$), $U \in \mathcal{Y}$, we will construct minimal σ , i.e. show that there is $\sigma^{x,U} \in \Sigma_x$ s.t. $\widehat{\sigma^{x,U}} \cap U = \emptyset$. We construct this $\sigma^{x,U}$ inductively, with the stronger property that $\text{ran}(\sigma_i^{x,U}) \cap H(U) = \emptyset$ for all $i \in \omega$.

$\sigma_0^{x,U} : x \in \mu(U), x \in Y - \mu(Y) \rightarrow \mu(Y) - H(U) \neq \emptyset$ by Fact 3.14 (page 64), (6)+(5). Let $\sigma_0^{x,U} \in \Pi\{\mu(Y) - H(U) : Y \in \mathcal{Y}, x \in Y - \mu(Y)\}$, so $\text{ran}(\sigma_0^{x,U}) \cap H(U) = \emptyset$.

$\sigma_i^{x,U} \rightarrow \sigma_{i+1}^{x,U}$: By induction hypothesis, $\text{ran}(\sigma_i^{x,U}) \cap H(U) = \emptyset$. Let $X \in \mathcal{Y}$ be s.t. $x \in \mu(X), \text{ran}(\sigma_i^{x,U}) \cap X \neq \emptyset$. Thus $X \not\subseteq H(U)$, so $\mu(U \cup X) - H(U) \neq \emptyset$ by Fact 3.14 (page 64), (7). Let $\sigma_{i+1}^{x,U} \in \Pi\{\mu(U \cup X) - H(U) : X \in \mathcal{Y}, x \in \mu(X), \text{ran}(\sigma_i^{x,U}) \cap X \neq \emptyset\}$, so $\text{ran}(\sigma_{i+1}^{x,U}) \cap H(U) = \emptyset$. As $\mu(U \cup X) - H(U) \subseteq \mu(X)$ by Fact 3.14 (page 64), (3), the construction satisfies the x -admissibility condition. \square

karl-search= End Claim Smooth-Admiss-1 Proof

3.4.23 Claim Smooth-Admiss-2

karl-search= Start Claim Smooth-Admiss-2

We now show:

Claim 3.19

(+++ Orig. No.: Claim Smooth-Admiss-2 +++)

LABEL: Claim Smooth-Admiss-2

\mathcal{Z}' is \mathcal{Y} -smooth.

karl-search= End Claim Smooth-Admiss-2

3.4.24 Claim Smooth-Admiss-2 Proof

karl-search= Start Claim Smooth-Admiss-2 Proof

Proof

(+++*** Orig.: Proof)

Let $X \in \mathcal{Y}, \langle x, \sigma \rangle \in \mathcal{X}' \upharpoonright X$.

Case 1, $x \in X - \mu(X)$: Then $\text{ran}(\sigma_0) \cap \mu(X) \neq \emptyset$, let $x' \in \text{ran}(\sigma_0) \cap \mu(X)$. Moreover, $\mu(X) \subseteq K$. Then for all $\langle x', \sigma' \rangle \in \mathcal{X}' \langle x', \sigma' \rangle \prec \langle x, \sigma \rangle$. But $\langle x', \sigma^{x',X} \rangle$ as constructed in the proof of Claim 3.18 (page 68) is minimal in $\mathcal{X}' \upharpoonright X$.

Case 2, $x \in \mu(X) = \mu_{\mathcal{Z}}(X) = \mu'(X)$: If $\langle x, \sigma \rangle$ is minimal in $\mathcal{X}' \upharpoonright X$, we are done. So suppose there is $\langle x', \sigma' \rangle \prec \langle x, \sigma \rangle, x' \in X$. Thus $x' \in \widehat{\sigma}$. Let $x' \in \text{ran}(\sigma_i)$. So $x \in \mu(X)$ and $\text{ran}(\sigma_i) \cap X \neq \emptyset$. But $\sigma_{i+1} \in \Pi\{\mu(X') : X' \in \mathcal{Y} \wedge x \in \mu(X') \wedge \text{ran}(\sigma_i) \cap X' \neq \emptyset\}$, so X is one of the X' , moreover $\mu(X) \subseteq K$, so there is $x'' \in \mu(X) \cap \text{ran}(\sigma_{i+1}) \cap K$, so for all $\langle x'', \sigma'' \rangle \in \mathcal{X}' \langle x'', \sigma'' \rangle \prec \langle x, \sigma \rangle$. But again $\langle x'', \sigma^{x'',X} \rangle$ as constructed in the proof of Claim 3.18 (page 68) is minimal in $\mathcal{X}' \upharpoonright X$.

\square

karl-search= End Claim Smooth-Admiss-2 Proof

karl-search= End Proposition Smooth-Complete Proof

3.4.25 Proposition Smooth-Complete-Trans

karl-search= Start Proposition Smooth-Complete-Trans

Proposition 3.20

(+++ Orig. No.: Proposition Smooth-Complete-Trans +++)

LABEL: Proposition Smooth-Complete-Trans

Let $\mu : \mathcal{Y} \rightarrow \mathcal{P}(U)$ satisfy $(\mu \subseteq)$, (μPR) , and (μCUM) , and the domain $\mathcal{Y} (U)$.

Then there is a transitive \mathcal{Y} -smooth preferential structure \mathcal{X} s.t. $\mu = \mu_{\mathcal{X}}$. See e.g. [Sch04].

karl-search= End Proposition Smooth-Complete-Trans

3.4.26 Proposition Smooth-Complete-Trans Proof

karl-search= Start Proposition Smooth-Complete-Trans Proof

Proof

(+++*** Orig.: Proof)

3.4.27 Discussion Smooth-Trans

karl-search= Start Discussion Smooth-Trans

3.4.27.1 Discussion Smooth-Trans

(+++*** Orig.: Discussion Smooth-Trans)

LABEL: Section Discussion Smooth-Trans

In a certain way, it is not surprising that transitivity does not impose stronger conditions in the smooth case either. Smoothness is itself a weak kind of transitivity: If an element is not minimal, then there is a minimal element below it, i.e., $x \succ y$ with y not minimal is possible, there is $z' \prec y$, but then there is z minimal with $x \succ z$. This is “almost” $x \succ z'$, transitivity.

To obtain representation, we will combine here the ideas of the smooth, but not necessarily transitive case with those of the general transitive case - as the reader will have suspected. Thus, we will index again with trees, and work with (suitably adapted) admissible sequences for the construction of the trees. In the construction of the admissible sequences, we were careful to repair all damage done in previous steps. We have to add now reparation of all damage done by using transitivity, i.e., the transitivity of the relation might destroy minimality, and we have to construct minimal elements below all elements for which we thus destroyed minimality. Both cases are combined by considering immediately all Y s.t. $x \in Y - H(U)$. Of course, the properties described in Fact 3.14 (page 64) play again a central role.

The (somewhat complicated) construction will be commented on in more detail below.

Note that even beyond Fact 3.14 (page 64) , closure of the domain under finite unions is used in the construction of the trees. This - or something like it - is necessary, as we have to respect the hulls of all elements treated so far (the predecessors), and not only of the first element, because of transitivity. For the same reason, we need more bookkeeping, to annotate all the hulls (or the union of the respective U 's) of all predecessors to be respected.

To summarize: we combine the ideas from the transitive general case and the simple smooth case, using the crucial Fact 3.14 (page 64) to show that the construction goes through. The construction leaves still some

freedom, and modifications are possible as indicated below in the course of the proof.

Recall that \mathcal{Y} will be closed under finite unions in this section, and let again $\mu : \mathcal{Y} \rightarrow \mathcal{P}(Z)$.

We have to adapt Construction 3.4 (page 68) (x-admissible sequences) to the transitive situation, and to our construction with trees. If $\langle \emptyset, x \rangle$ is the root, $\sigma_0 \in \Pi\{\mu(Y) : x \in Y - \mu(Y)\}$ determines some children of the root. To preserve smoothness, we have to compensate and add other children by the $\sigma_{i+1} : \sigma_{i+1} \in \Pi\{\mu(X) : x \in \mu(X), \text{ran}(\sigma_i) \cap X \neq \emptyset\}$. On the other hand, we have to pursue the same construction for the children so constructed. Moreover, these indirect children have to be added to those children of the root, which have to be compensated (as the first children are compensated by σ_1) to preserve smoothness. Thus, we build the tree in a simultaneous vertical and horizontal induction.

This construction can be simplified, by considering immediately all $Y \in \mathcal{Y}$ s.t. $x \in Y \not\subseteq H(U)$ - independent of whether $x \notin \mu(Y)$ (as done in σ_0), or whether $x \in \mu(Y)$, and some child y constructed before is in Y (as done in the σ_{i+1}), or whether $x \in \mu(Y)$, and some indirect child y of x is in Y (to take care of transitivity, as indicated above). We make this simplified construction.

There are two ways to proceed. First, we can take as \triangleleft^* in the trees the transitive closure of \triangleleft . Second, we can deviate from the idea that children are chosen by selection functions f , and take nonempty subsets of elements instead, making more elements children than in the first case. We take the first alternative, as it is more in the spirit of the construction.

We will suppose for simplicity that $Z = K$ - the general case is easy to obtain, but complicates the picture.

For each $x \in Z$, we construct trees t_x , which will be used to index different copies of x , and control the relation \triangleleft .

These trees t_x will have the following form:

- (a) the root of t is $\langle \emptyset, x \rangle$ or $\langle U, x \rangle$ with $U \in \mathcal{Y}$ and $x \in \mu(U)$,
- (b) all other nodes are pairs $\langle Y, y \rangle$, $Y \in \mathcal{Y}$, $y \in \mu(Y)$,
- (c) $ht(t) \leq \omega$,
- (d) if $\langle Y, y \rangle$ is an element in t_x , then there is some $\mathcal{Y}(y) \subseteq \{W \in \mathcal{Y} : y \in W\}$, and $f \in \Pi\{\mu(W) : W \in \mathcal{Y}(y)\}$ s.t. the set of children of $\langle Y, y \rangle$ is $\{\langle Y \cup W, f(W) \rangle : W \in \mathcal{Y}(y)\}$.

The first coordinate is used for bookkeeping when constructing children, in particular for condition (d).

The relation \triangleleft will essentially be determined by the subtree relation.

We first construct the trees t_x for those sets U where $x \in \mu(U)$, and then take care of the others. In the construction for the minimal elements, at each level $n > 0$, we may have several ways to choose a selection function f_n , and each such choice leads to the construction of a different tree - we construct all these trees. (We could also construct only one tree, but then the choice would have to be made coherently for different x, U . It is simpler to construct more trees than necessary.)

We control the relation by indexing with trees, just as it was done in the not necessarily smooth case before.

karl-search= End Discussion Smooth-Trans

3.4.28 Definition Tree-TC

karl-search= Start Definition Tree-TC

Definition 3.9

(+++ Orig. No.: Definition Tree-TC +++)

LABEL: Definition Tree-TC

If t is a tree with root $\langle a, b \rangle$, then t/c will be the same tree, only with the root $\langle c, b \rangle$.

karl-search= End Definition Tree-TC

3.4.29 Construction Smooth-Tree

karl-search= Start Construction Smooth-Tree

Construction 3.5

(+++ Orig. No.: Construction Smooth-Tree +++)

LABEL: Construction Smooth-Tree

(A) The set T_x of trees t for fixed x :

(1) Construction of the set $T\mu_x$ of trees for those sets $U \in \mathcal{Y}$, where $x \in \mu(U)$:

Let $U \in \mathcal{Y}$, $x \in \mu(U)$. The trees $t_{U,x} \in T\mu_x$ are constructed inductively, observing simultaneously:

If $\langle U_{n+1}, x_{n+1} \rangle$ is a child of $\langle U_n, x_n \rangle$, then (a) $x_{n+1} \in \mu(U_{n+1}) - H(U_n)$, and (b) $U_n \subseteq U_{n+1}$.

Set $U_0 := U$, $x_0 := x$.

Level 0: $\langle U_0, x_0 \rangle$.

Level $n \rightarrow n + 1$: Let $\langle U_n, x_n \rangle$ be in level n . Suppose $Y_{n+1} \in \mathcal{Y}$, $x_n \in Y_{n+1}$, and $Y_{n+1} \not\subseteq H(U_n)$. Note that $\mu(U_n \cup Y_{n+1}) - H(U_n) \neq \emptyset$ by Fact 3.14 (page 64) , (7), and $\mu(U_n \cup Y_{n+1}) - H(U_n) \subseteq \mu(Y_{n+1})$ by Fact 3.14 (page 64) , (3). Choose $f_{n+1} \in \Pi\{\mu(U_n \cup Y_{n+1}) - H(U_n) : Y_{n+1} \in \mathcal{Y}, x_n \in Y_{n+1} \not\subseteq H(U_n)\}$ (for the construction of this tree, at this element), and let the set of children of $\langle U_n, x_n \rangle$ be $\{\langle U_n \cup Y_{n+1}, f_{n+1}(Y_{n+1}) \rangle : Y_{n+1} \in \mathcal{Y}, x_n \in Y_{n+1} \not\subseteq H(U_n)\}$. (If there is no such Y_{n+1} , $\langle U_n, x_n \rangle$ has no children.) Obviously, (a) and (b) hold.

We call such trees U, x -trees.

(2) Construction of the set T'_x of trees for the nonminimal elements. Let $x \in Z$. Construct the tree t_x as follows (here, one tree per x suffices for all U):

Level 0: $\langle \emptyset, x \rangle$

Level 1: Choose arbitrary $f \in \Pi\{\mu(U) : x \in U \in \mathcal{Y}\}$. Note that $U \neq \emptyset \rightarrow \mu(U) \neq \emptyset$ by $Z = K$ (by Remark 3.15 (page 65) , (1)). Let $\{\langle U, f(U) \rangle : x \in U \in \mathcal{Y}\}$ be the set of children of $\langle \emptyset, x \rangle$. This assures that the element will be nonminimal.

Level > 1 : Let $\langle U, f(U) \rangle$ be an element of level 1, as $f(U) \in \mu(U)$, there is a $t_{U,f(U)} \in T\mu_{f(U)}$. Graft one of these trees $t_{U,f(U)} \in T\mu_{f(U)}$ at $\langle U, f(U) \rangle$ on the level 1. This assures that a minimal element will be below it to guarantee smoothness.

Finally, let $T_x := T\mu_x \cup T'_x$.

(B) The relation \triangleleft between trees: For $x, y \in Z$, $t \in T_x$, $t' \in T_y$, set $t \triangleright t'$ iff for some $Y \langle Y, y \rangle$ is a child of the root $\langle X, x \rangle$ in t , and t' is the subtree of t beginning at this $\langle Y, y \rangle$.

(C) The structure \mathcal{Z} : Let $\mathcal{Z} := \langle \{\langle x, t_x \rangle : x \in Z, t_x \in T_x\}, \langle x, t_x \rangle \triangleright \langle y, t_y \rangle \text{ iff } t_x \triangleright^* t_y \rangle$.

karl-search= End Construction Smooth-Tree

3.4.30 Fact Smooth-Tree

karl-search= Start Fact Smooth-Tree

The rest of the proof are simple observations.

Fact 3.21

(+++ Orig. No.: Fact Smooth-Tree +++)

LABEL: Fact Smooth-Tree

- (1) If $t_{U,x}$ is an U, x -tree, $\langle U_n, x_n \rangle$ an element of $t_{U,x}$, $\langle U_m, x_m \rangle$ a direct or indirect child of $\langle U_n, x_n \rangle$, then $x_m \notin H(U_n)$.
- (2) Let $\langle Y_n, y_n \rangle$ be an element in $t_{U,x} \in T\mu_x$, t' the subtree starting at $\langle Y_n, y_n \rangle$, then t' is a Y_n, y_n -tree.
- (3) \prec is free from cycles.
- (4) If $t_{U,x}$ is an U, x -tree, then $\langle x, t_{U,x} \rangle$ is \prec -minimal in $\mathcal{Z}[U]$.
- (5) No $\langle x, t_x \rangle$, $t_x \in T'_x$ is minimal in any $\mathcal{Z}[U, U \in \mathcal{Y}]$.
- (6) Smoothness is respected for the elements of the form $\langle x, t_{U,x} \rangle$.
- (7) Smoothness is respected for the elements of the form $\langle x, t_x \rangle$ with $t_x \in T'_x$.
- (8) $\mu = \mu_{\mathcal{Z}}$.

karl-search= End Fact Smooth-Tree

3.4.31 Fact Smooth-Tree Proof

karl-search= Start Fact Smooth-Tree Proof

Proof

(+++*** Orig.: Proof)

- (1) trivial by (a) and (b).
- (2) trivial by (a).
- (3) Note that no $\langle x, t_x \rangle$, $t_x \in T'_x$ can be smaller than any other element (smaller elements require $U \neq \emptyset$ at the root). So no cycle involves any such $\langle x, t_x \rangle$. Consider now $\langle x, t_{U,x} \rangle$, $t_{U,x} \in T\mu_x$. For any $\langle y, t_{V,y} \rangle$, $\langle x, t_{U,x} \rangle$, $y \notin H(U)$ by (1), but $x \in \mu(U) \subseteq H(U)$, so $x \neq y$.
- (4) This is trivial by (1).
- (5) Let $x \in U \in \mathcal{Y}$, then f as used in the construction of level 1 of t_x chooses $y \in \mu(U) \neq \emptyset$, and some $\langle y, t_{U,y} \rangle$ is in $\mathcal{Z}[U]$ and below $\langle x, t_x \rangle$.
- (6) Let $x \in A \in \mathcal{Y}$, we have to show that either $\langle x, t_{U,x} \rangle$ is minimal in $\mathcal{Z}[A]$, or that there is $\langle y, t_y \rangle$ \prec $\langle x, t_{U,x} \rangle$ minimal in $\mathcal{Z}[A]$. Case 1, $A \subseteq H(U)$: Then $\langle x, t_{U,x} \rangle$ is minimal in $\mathcal{Z}[A]$, again by (1). Case 2, $A \not\subseteq H(U)$: Then A is one of the Y_1 considered for level 1. So there is $\langle U \cup A, f_1(A) \rangle$ in level 1 with $f_1(A) \in \mu(A) \subseteq A$ by Fact 3.14 (page 64), (3). But note that by (1) all elements below $\langle U \cup A, f_1(A) \rangle$ avoid $H(U \cup A)$. Let t be the subtree of $t_{U,x}$ beginning at $\langle U \cup A, f_1(A) \rangle$, then by (2) t is one of the $U \cup A, f_1(A)$ -trees, and $\langle f_1(A), t \rangle$ is minimal in $\mathcal{Z}[U \cup A]$ by (4), so in $\mathcal{Z}[A]$, and $\langle f_1(A), t \rangle$ \prec $\langle x, t_{U,x} \rangle$.
- (7) Let $x \in A \in \mathcal{Y}$, $\langle x, t_x \rangle$, $t_x \in T'_x$, and consider the subtree t beginning at $\langle A, f(A) \rangle$, then t is one of the $A, f(A)$ -trees, and $\langle f(A), t \rangle$ is minimal in $\mathcal{Z}[A]$ by (4).
- (8) Let $x \in \mu(U)$. Then any $\langle x, t_{U,x} \rangle$ is \prec -minimal in $\mathcal{Z}[U]$ by (4), so $x \in \mu_{\mathcal{Z}}(U)$. Conversely, let $x \in U - \mu(U)$. By (5), no $\langle x, t_x \rangle$ is minimal in U . Consider now some $\langle x, t_{V,x} \rangle \in \mathcal{Z}$, so $x \in \mu(V)$. As $x \in U - \mu(U)$, $U \not\subseteq H(V)$ by Fact 3.14 (page 64), (6). Thus U was considered in the construction of level 1 of $t_{V,x}$. Let t be the subtree of $t_{V,x}$ beginning at $\langle V \cup U, f_1(U) \rangle$, by $\mu(V \cup U) - H(V) \subseteq \mu(U)$ (Fact 3.14 (page 64), (3)), $f_1(U) \in \mu(U) \subseteq U$, and $\langle f_1(U), t \rangle$ \prec $\langle x, t_{V,x} \rangle$.

□

karl-search= End Fact Smooth-Tree Proof

karl-search= End Proposition Smooth-Complete-Trans Proof

3.4.32 Proposition No-Norm

karl-search= Start Proposition No-Norm

Proposition 3.22

(+++ Orig. No.: Proposition No-Norm +++)

LABEL: Proposition No-Norm

We call a characterization “normal” iff it is a universally quantified boolean combination (of any fixed, but perhaps infinite, length) of rules of the usual form. (We do not go into details here.)

(1) There is no “normal” characterization of any fixed size of not necessarily definability preserving preferential structures.

(2) There is no “normal” characterization of any fixed size of not necessarily definability preserving ranked preferential structures.

See [Sch04].

karl-search= End Proposition No-Norm

karl-search= End ToolBase1-Pref-ReprSmooth

karl-search= End ToolBase1-Pref

4 Ranked structures

4.0.33 ToolBase1-Rank

karl-search= Start ToolBase1-Rank

LABEL: Section Toolbase1-Rank

4.1 Ranked: Basics

4.1.1 Fact Rank-Trans

karl-search= Start Fact Rank-Trans

Fact 4.1

(+++ Orig. No.: Fact Rank-Trans +++)

LABEL: Fact Rank-Trans

If \prec on X is ranked, and free of cycles, then \prec is transitive.

karl-search= End Fact Rank-Trans

4.1.2 Fact Rank-Trans Proof

karl-search= Start Fact Rank-Trans Proof

Proof

(+++*** Orig.: Proof)

Let $x \prec y \prec z$. If $x \perp z$, then $y \succ z$, resulting in a cycle of length 2. If $z \prec x$, then we have a cycle of length 3. So $x \prec z$. \square

karl-search= End Fact Rank-Trans Proof

4.1.3 Fact Rank-Auxil

karl-search= Start Fact Rank-Auxil

Fact 4.2

(+++ Orig. No.: Fact Rank-Auxil +++)

LABEL: Fact Rank-Auxil

$M(T) - M(T')$ is normally not definable.

In the presence of $(\mu =)$ and $(\mu \subseteq)$, $f(Y) \cap (X - f(X)) \neq \emptyset$ is equivalent to $f(Y) \cap X \neq \emptyset$ and $f(Y) \cap f(X) = \emptyset$.

karl-search= End Fact Rank-Auxil

4.1.4 Fact Rank-Auxil Proof

karl-search= Start Fact Rank-Auxil Proof

Proof

(+++*** Orig.: Proof)

$$f(Y) \cap (X - f(X)) = (f(Y) \cap X) - (f(Y) \cap f(X)).$$

“ \Leftarrow ”: Let $f(Y) \cap X \neq \emptyset$, $f(Y) \cap f(X) = \emptyset$, so $f(Y) \cap (X - f(X)) \neq \emptyset$.

“ \Rightarrow ”: Suppose $f(Y) \cap (X - f(X)) \neq \emptyset$, so $f(Y) \cap X \neq \emptyset$. Suppose $f(Y) \cap f(X) \neq \emptyset$, so by $(\mu \subseteq)$ $f(Y) \cap X \cap Y \neq \emptyset$, so by $(\mu =)$ $f(Y) \cap X \cap Y = f(X \cap Y)$, and $f(X) \cap X \cap Y \neq \emptyset$, so by $(\mu =)$ $f(X) \cap X \cap Y = f(X \cap Y)$, so $f(X) \cap Y = f(Y) \cap X$ and $f(Y) \cap (X - f(X)) = \emptyset$.

□

karl-search= End Fact Rank-Auxil Proof

4.1.5 Remark RatM=

karl-search= Start Remark RatM=

Remark 4.3

(+++ Orig. No.: Remark RatM= +++)

LABEL: Remark RatM=

Note that $(\mu =')$ is very close to $(RatM)$: $(RatM)$ says: $\alpha \vdash \beta$, $\alpha \not\vdash \neg\gamma \Rightarrow \alpha \wedge \gamma \vdash \beta$. Or, $f(A) \subseteq B$, $f(A) \cap C \neq \emptyset \rightarrow f(A \cap C) \subseteq B$ for all A, B, C . This is not quite, but almost: $f(A \cap C) \subseteq f(A) \cap C$ (it depends how many B there are, if $f(A)$ is some such B , the fit is perfect).

karl-search= End Remark RatM=

4.1.6 Fact Rank-Hold

karl-search= Start Fact Rank-Hold

Fact 4.4

(+++ Orig. No.: Fact Rank-Hold +++)

LABEL: Fact Rank-Hold

In all ranked structures, $(\mu \subseteq)$, $(\mu =)$, (μPR) , $(\mu =')$, $(\mu \parallel)$, $(\mu \cup)$, $(\mu \cup')$, $(\mu \in)$, $(\mu RatM)$ will hold, if the corresponding closure conditions are satisfied.

karl-search= End Fact Rank-Hold

4.1.7 Fact Rank-Hold Proof

karl-search= Start Fact Rank-Hold Proof

Proof

(+++*** Orig.: Proof)

$(\mu \subseteq)$ and (μPR) hold in all preferential structures.

$(\mu =)$ and $(\mu =')$ are trivial.

$(\mu \cup)$ and $(\mu \cup')$: All minimal copies of elements in $f(Y)$ have the same rank. If some $y \in f(Y)$ has all its minimal copies killed by an element $x \in X$, by rankedness, x kills the rest, too.

$(\mu \in)$: If $f(\{a\}) = \emptyset$, we are done. Take the minimal copies of a in $\{a\}$, they are all killed by one element in X .

$(\mu \parallel)$: Case $f(X) = \emptyset$: If below every copy of $y \in Y$ there is a copy of some $x \in X$, then $f(X \cup Y) = \emptyset$. Otherwise $f(X \cup Y) = f(Y)$. Suppose now $f(X) \neq \emptyset$, $f(Y) \neq \emptyset$, then the minimal ranks decide: if they are equal, $f(X \cup Y) = f(X) \cup f(Y)$, etc.

$(\mu RatM)$: Let $X \subseteq Y$, $y \in X \cap f(Y) \neq \emptyset$, $x \in f(X)$. By rankedness, $y \prec x$, or $y \perp x$, $y \prec x$ is impossible, as $y \in X$, so $y \perp x$, and $x \in f(Y)$.

□

karl-search= End Fact Rank-Hold Proof

karl-search= End ToolBase1-Rank-Base

4.2 Ranked: Representation

4.2.1 ToolBase1-Rank-Repr

karl-search= Start ToolBase1-Rank-Repr

LABEL: Section Toolbase1-Rank-Repr

4.2.1.1 (1) Results for structures without copies

(+++*** Orig.: (1) Results for structures without copies)

LABEL: Section (1) Results for structures without copies

4.2.2 Proposition Rank-Rep1

karl-search= Start Proposition Rank-Rep1

Proposition 4.5

(+++ Orig. No.: Proposition Rank-Rep1 +++)

LABEL: Proposition Rank-Rep1

The first result applies for structures without copies of elements.

(1) Let $\mathcal{Y} \subseteq \mathcal{P}(U)$ be closed under finite unions. Then $(\mu \subseteq), (\mu \emptyset), (\mu =)$ characterize ranked structures for which for all $X \in \mathcal{Y} X \neq \emptyset \rightarrow \mu_{<}(X) \neq \emptyset$ hold, i.e. $(\mu \subseteq), (\mu \emptyset), (\mu =)$ hold in such structures for $\mu_{<}$, and if they hold for some μ , we can find a ranked relation $<$ on U s.t. $\mu = \mu_{<}$. Moreover, the structure can be chosen \mathcal{Y} -smooth.

(2) Let $\mathcal{Y} \subseteq \mathcal{P}(U)$ be closed under finite unions, and contain singletons. Then $(\mu \subseteq), (\mu \emptyset fin), (\mu =), (\mu \in)$ characterize ranked structures for which for all finite $X \in \mathcal{Y} X \neq \emptyset \rightarrow \mu_{<}(X) \neq \emptyset$ hold, i.e. $(\mu \subseteq), (\mu \emptyset fin), (\mu =), (\mu \in)$ hold in such structures for $\mu_{<}$, and if they hold for some μ , we can find a ranked relation $<$ on U s.t. $\mu = \mu_{<}$.

Note that the prerequisites of (2) hold in particular in the case of ranked structures without copies, where all elements of U are present in the structure - we need infinite descending chains to have $\mu(X) = \emptyset$ for $X \neq \emptyset$.

See [Sch04].

karl-search= End Proposition Rank-Rep1

4.2.2.1 (2) Results for structures possibly with copies

(+++*** Orig.: (2) Results for structures possibly with copies)

LABEL: Section (2) Results for structures possibly with copies

4.2.3 Definition 1-infin

karl-search= Start Definition 1-infin

Definition 4.1

(+++ Orig. No.: Definition 1-infin +++)

LABEL: Definition 1-infin

Let $\mathcal{Z} = \langle \mathcal{X}, \prec \rangle$ be a preferential structure. Call \mathcal{Z} $1 - \infty$ over Z , iff for all $x \in Z$ there are exactly one or infinitely many copies of x , i.e. for all $x \in Z$ $\{u \in \mathcal{X} : u = \langle x, i \rangle \text{ for some } i\}$ has cardinality 1 or $\geq \omega$.

karl-search= End Definition 1-infin

4.2.4 Lemma 1-infin

karl-search= Start Lemma 1-infin

Lemma 4.6

(+++ Orig. No.: Lemma 1-infin +++)

LABEL: Lemma 1-infin

Let $\mathcal{Z} = \langle \mathcal{X}, \prec \rangle$ be a preferential structure and $f : \mathcal{Y} \rightarrow \mathcal{P}(Z)$ with $\mathcal{Y} \subseteq \mathcal{P}(Z)$ be represented by \mathcal{Z} , i.e. for $X \in \mathcal{Y}$ $f(X) = \mu_{\mathcal{Z}}(X)$, and \mathcal{Z} be ranked and free of cycles. Then there is a structure \mathcal{Z}' , $1 - \infty$ over Z , ranked and free of cycles, which also represents f .

karl-search= End Lemma 1-infin

4.2.5 Lemma 1-infin Proof

karl-search= Start Lemma 1-infin Proof

Proof

(+++*** Orig.: Proof)

We construct $\mathcal{Z}' = \langle \mathcal{X}', \prec' \rangle$.

Let $A := \{x \in Z : \text{there is some } \langle x, i \rangle \in \mathcal{X}, \text{ but for all } \langle x, i \rangle \in \mathcal{X} \text{ there is } \langle x, j \rangle \in \mathcal{X} \text{ with } \langle x, j \rangle \prec \langle x, i \rangle\}$,

let $B := \{x \in Z : \text{there is some } \langle x, i \rangle \in \mathcal{X}, \text{ s.t. for no } \langle x, j \rangle \in \mathcal{X} \langle x, j \rangle \prec \langle x, i \rangle\}$,

let $C := \{x \in Z : \text{there is no } \langle x, i \rangle \in \mathcal{X}\}$.

Let $c_i : i < \kappa$ be an enumeration of C . We introduce for each such c_i ω many copies $\langle c_i, n \rangle : n < \omega$ into \mathcal{X}' , put all $\langle c_i, n \rangle$ above all elements in \mathcal{X} , and order the $\langle c_i, n \rangle$ by $\langle c_i, n \rangle \prec' \langle c_{i'}, n' \rangle : \Leftrightarrow (i = i' \text{ and } n > n') \text{ or } i > i'$. Thus, all $\langle c_i, n \rangle$ are comparable.

If $a \in A$, then there are infinitely many copies of a in \mathcal{X} , as \mathcal{X} was cycle-free, we put them all into \mathcal{X}' . If $b \in B$, we choose exactly one such minimal element $\langle b, m \rangle$ (i.e. there is no $\langle b, n \rangle \prec \langle b, m \rangle$) into \mathcal{X}' , and omit all other elements. (For definiteness, assume in all applications $m = 0$.) For all elements from A and B , we take the restriction of the order \prec of \mathcal{X} . This is the new structure \mathcal{Z}' .

Obviously, adding the $\langle c_i, n \rangle$ does not introduce cycles, irreflexivity and rankedness are preserved. Moreover, any substructure of a cycle-free, irreflexive, ranked structure also has these properties, so \mathcal{Z}' is $1 - \infty$ over Z , ranked and free of cycles.

We show that \mathcal{Z} and \mathcal{Z}' are equivalent. Let then $X \subseteq Z$, we have to prove $\mu(X) = \mu'(X)$ ($\mu := \mu_{\mathcal{Z}}$, $\mu' := \mu_{\mathcal{Z}'}$).

Let $z \in X - \mu(X)$. If $z \in C$ or $z \in A$, then $z \notin \mu'(X)$. If $z \in B$, let $\langle z, m \rangle$ be the chosen element. As $z \notin \mu(X)$, there is $x \in X$ s.t. some $\langle x, j \rangle \prec \langle z, m \rangle$. x cannot be in C . If $x \in A$, then also $\langle x, j \rangle \prec' \langle z, m \rangle$. If $x \in B$, then there is some $\langle x, k \rangle$ also in \mathcal{X}' . $\langle x, j \rangle \prec \langle x, k \rangle$ is impossible. If $\langle x, k \rangle \prec \langle x, j \rangle$, then

$\langle z, m \rangle \succ \langle x, k \rangle$ by transitivity. If $\langle x, k \rangle \perp \langle x, j \rangle$, then also $\langle z, m \rangle \succ \langle x, k \rangle$ by rankedness. In any case, $\langle z, m \rangle \succ' \langle x, k \rangle$, and thus $z \notin \mu'(X)$.

Let $z \in X - \mu'(X)$. If $z \in C$ or $z \in A$, then $z \notin \mu(X)$. Let $z \in B$, and some $\langle x, j \rangle \prec' \langle z, m \rangle$. x cannot be in C , as they were sorted on top, so $\langle x, j \rangle$ exists in \mathcal{X} too and $\langle x, j \rangle \prec \langle z, m \rangle$. But if any other $\langle z, i \rangle$ is also minimal in \mathcal{Z} among the $\langle z, k \rangle$, then by rankedness also $\langle x, j \rangle \prec \langle z, i \rangle$, as $\langle z, i \rangle \perp \langle z, m \rangle$, so $z \notin \mu(X)$. \square

karl-search= End Lemma 1-infin Proof

4.2.6 Fact Rank-No-Rep

karl-search= Start Fact Rank-No-Rep

Fact 4.7

(+++ Orig. No.: Fact Rank-No-Rep +++)

LABEL: Fact Rank-No-Rep

$(\mu \subseteq) + (\mu PR) + (\mu =) + (\mu \cup) + (\mu \in)$ do not imply representation by a ranked structure.

karl-search= End Fact Rank-No-Rep

4.2.7 Fact Rank-No-Rep Proof

karl-search= Start Fact Rank-No-Rep Proof

Proof

(+++** Orig.: Proof)

See Example 4.1 (page 82) . \square

karl-search= End Fact Rank-No-Rep Proof

4.2.8 Example Rank-Copies

karl-search= Start Example Rank-Copies

Example 4.1

(+++ Orig. No.: Example Rank-Copies +++)

LABEL: Example Rank-Copies

This example shows that the conditions $(\mu \subseteq) + (\mu PR) + (\mu =) + (\mu \cup) + (\mu \in)$ can be satisfied, and still representation by a ranked structure is impossible.

Consider $\mu(\{a, b\}) = \emptyset$, $\mu(\{a\}) = \{a\}$, $\mu(\{b\}) = \{b\}$. The conditions $(\mu \subseteq) + (\mu PR) + (\mu =) + (\mu \cup) + (\mu \in)$ hold trivially. This is representable, e.g. by $a_1 \succeq b_1 \succeq a_2 \succeq b_2 \dots$ without transitivity. (Note that rankedness implies transitivity, $a \preceq b \preceq c$, but not for $a = c$.) But this cannot be represented by a ranked structure: As $\mu(\{a\}) \neq \emptyset$, there must be a copy a_i of minimal rank, likewise for b and some b_i . If they have the same rank, $\mu(\{a, b\}) = \{a, b\}$, otherwise it will be $\{a\}$ or $\{b\}$.

□

karl-search= End Example Rank-Copies

4.2.9 Proposition Rank-Rep2

karl-search= Start Proposition Rank-Rep2

Proposition 4.8

(+++ Orig. No.: Proposition Rank-Rep2 +++)

LABEL: Proposition Rank-Rep2

Let \mathcal{Y} be closed under finite unions and contain singletons. Then $(\mu \subseteq) + (\mu PR) + (\mu \parallel) + (\mu \cup) + (\mu \in)$ characterize ranked structures, where elements may appear in several copies.

See [Sch04].

karl-search= End Proposition Rank-Rep2

karl-search= End ToolBase1-Rank-Repr

karl-search= End ToolBase1-Rank

4.2.10 Proposition Rank-Rep3

karl-search= Start Proposition Rank-Rep3

Proposition 4.9

(+++ Orig. No.: Proposition Rank-Rep3 +++)

LABEL: Proposition Rank-Rep3

Let $\mathcal{Y} \subseteq \mathcal{P}(U)$ be closed under finite unions. Then $(\mu \subseteq), (\mu \emptyset), (\mu =)$ characterize ranked structures for which for all $X \in \mathcal{Y} X \neq \emptyset \rightarrow \mu_{<}(X) \neq \emptyset$ hold, i.e. $(\mu \subseteq), (\mu \emptyset), (\mu =)$ hold in such structures for $\mu_{<}$, and if they hold for some μ , we can find a ranked relation $<$ on U s.t. $\mu = \mu_{<}$. Moreover, the structure can be chosen \mathcal{Y} -smooth.

karl-search= End Proposition Rank-Rep3

4.2.11 Proposition Rank-Rep3 Proof

karl-search= Start Proposition Rank-Rep3 Proof

Proof

(+++*** Orig.: Proof)

Completeness:

Note that by Fact 2.7 (page 28) (3) + (4) $(\mu \parallel), (\mu \cup), (\mu \cup')$ hold.

Define aRb iff $\exists A \in \mathcal{Y}(a \in \mu(A), b \in A)$ or $a = b$. R is reflexive and transitive: Suppose aRb, bRc , let $a \in \mu(A), b \in A, b \in \mu(B), c \in B$. We show $a \in \mu(A \cup B)$. By $(\mu \parallel)$ $a \in \mu(A \cup B)$ or $b \in \mu(A \cup B)$. Suppose $b \in \mu(A \cup B)$, then $\mu(A \cup B) \cap A \neq \emptyset$, so by $(\mu =)$ $\mu(A \cup B) \cap A = \mu(A)$, so $a \in \mu(A \cup B)$.

Moreover, $a \in \mu(A), b \in A - \mu(A) \rightarrow \neg(bRa)$: Suppose there is B s.t. $b \in \mu(B), a \in B$. Then by $(\mu \cup)$ $\mu(A \cup B) \cap B = \emptyset$, and by $(\mu \cup')$ $\mu(A \cup B) = \mu(A)$, but $a \in \mu(A) \cap B$, *contradiction*.

Let by Lemma 1.1 (page 13) S be a total, transitive, reflexive relation on U which extends R s.t. $xSy, ySx \rightarrow xRy$ (recall that R is transitive and reflexive). Define $a < b$ iff aSb , but not bSa . If $a \perp b$ (i.e. neither $a < b$ nor $b < a$), then, by totality of S , aSb and bSa . $<$ is ranked: If $c < a \perp b$, then by transitivity of S cSb , but if bSc , then again by transitivity of S aSc . Similarly for $c > a \perp b$.

$<$ represents μ and is \mathcal{Y} -smooth: Let $a \in A - \mu(A)$. By $(\mu \emptyset), \exists b \in \mu(A)$, so bRa , but (by above argument) not aRb , so bSa , but not aSb , so $b < a$, so $a \in A - \mu_{<}(A)$, and, as b will then be $<$ -minimal (see the next sentence), $<$ is \mathcal{Y} -smooth. Let $a \in \mu(A)$, then for all $a' \in A$ aRa' , so aSa' , so there is no $a' \in A$ $a' < a$, so $a \in \mu_{<}(A)$.

□

karl-search= End Proposition Rank-Rep3 Proof

5 Theory revision

5.0.12 ToolBase1-TR

karl-search= Start ToolBase1-TR

LABEL: Section Toolbase1-TR

5.1 AGM revision

5.1.1 ToolBase1-TR-AGM

karl-search= Start ToolBase1-TR-AGM

LABEL: Section Toolbase1-TR-AGM LABEL: Section AGM-revision

All material in this Section 5.1.1 (page 84) is due verbatim or in essence to AGM - AGM for Alchourron, Gardenfors, Makinson, see e.g. [AGM85].

5.1.2 Definition AGM

karl-search= Start Definition AGM

Definition 5.1

(+++ Orig. No.: Definition AGM +++)

LABEL: Definition AGM

We present in parallel the logical and the semantic (or purely algebraic) side. For the latter, we work in some fixed universe U , and the intuition is $U = M_{\mathcal{L}}$, $X = M(K)$, etc., so, e.g. $A \in K$ becomes $X \subseteq B$, etc.

(For reasons of readability, we omit most caveats about definability.)

K_{\perp} will denote the inconsistent theory.

We consider two functions, $-$ and $*$, taking a deductively closed theory and a formula as arguments, and returning a (deductively closed) theory on the logics side. The algebraic counterparts work on definable model sets. It is obvious that $(K - 1)$, $(K * 1)$, $(K - 6)$, $(K * 6)$ have vacuously true counterparts on the semantical side. Note that $K(X)$ will never change, everything is relative to fixed $K(X)$. $K * \phi$ is the result of revising K with ϕ . $K - \phi$ is the result of subtracting enough from K to be able to add $\neg\phi$ in a reasonable way, called contraction.

Moreover, let \leq_K be a relation on the formulas relative to a deductively closed theory K on the formulas of \mathcal{L} , and \leq_X a relation on $\mathcal{P}(U)$ or a suitable subset of $\mathcal{P}(U)$ relative to fixed X . When the context is clear, we simply write \leq . \leq_K (\leq_X) is called a relation of epistemic entrenchment for $K(X)$.

The following table presents the “rationality postulates” for contraction ($-$), revision ($*$) and epistemic entrenchment. In AGM tradition, K will be a deductively closed theory, ϕ, ψ formulas. Accordingly, X will be the set of models of a theory, A, B the model sets of formulas.

In the further development, formulas ϕ etc. may sometimes also be full theories. As the transcription to this case is evident, we will not go into details.

Contraction, $K - \phi$			
(K-1)	$K - \phi$ is deductively closed		
(K-2)	$K - \phi \subseteq K$	(X \ominus 2)	$X \subseteq X \ominus A$
(K-3)	$\phi \notin K \Rightarrow K - \phi = K$	(X \ominus 3)	$X \not\subseteq A \Rightarrow X \ominus A = X$
(K-4)	$\nabla \phi \Rightarrow \phi \notin K - \phi$	(X \ominus 4)	$A \neq U \Rightarrow X \ominus A \not\subseteq A$
(K-5)	$K \subseteq \overline{(K - \phi) \cup \{\phi\}}$	(X \ominus 5)	$(X \ominus A) \cap A \subseteq X$
(K-6)	$\vdash \phi \leftrightarrow \psi \Rightarrow K - \phi = K - \psi$		
(K-7)	$(K - \phi) \cap (K - \psi) \subseteq$ $K - (\phi \wedge \psi)$	(X \ominus 7)	$X \ominus (A \cap B) \subseteq$ $(X \ominus A) \cup (X \ominus B)$
(K-8)	$\phi \notin K - (\phi \wedge \psi) \Rightarrow$ $K - (\phi \wedge \psi) \subseteq K - \phi$	(X \ominus 8)	$X \ominus (A \cap B) \not\subseteq A \Rightarrow$ $X \ominus A \subseteq X \ominus (A \cap B)$
Revision, $K * \phi$			
(K*1)	$K * \phi$ is deductively closed	-	
(K*2)	$\phi \in K * \phi$	(X 2)	$X A \subseteq A$
(K*3)	$K * \phi \subseteq \overline{K \cup \{\phi\}}$	(X 3)	$X \cap A \subseteq X A$
(K*4)	$\neg \phi \notin K \Rightarrow$ $\overline{K \cup \{\phi\}} \subseteq K * \phi$	(X 4)	$X \cap A \neq \emptyset \Rightarrow$ $X A \subseteq X \cap A$
(K*5)	$K * \phi = K_{\perp} \Rightarrow \vdash \neg \phi$	(X 5)	$X A = \emptyset \Rightarrow A = \emptyset$
(K*6)	$\vdash \phi \leftrightarrow \psi \Rightarrow K * \phi = K * \psi$	-	
(K*7)	$K * (\phi \wedge \psi) \subseteq$ $\overline{(K * \phi) \cup \{\psi\}}$	(X 7)	$(X A) \cap B \subseteq$ $X (A \cap B)$
(K*8)	$\neg \psi \notin K * \phi \Rightarrow$ $\overline{(K * \phi) \cup \{\psi\}} \subseteq K * (\phi \wedge \psi)$	(X 8)	$(X A) \cap B \neq \emptyset \Rightarrow$ $X (A \cap B) \subseteq (X A) \cap B$
Epistemic entrenchment			
(EE1)	\leq_K is transitive	(EE1)	\leq_X is transitive
(EE2)	$\phi \vdash \psi \Rightarrow \phi \leq_K \psi$	(EE2)	$A \subseteq B \Rightarrow A \leq_X B$
(EE3)	$\forall \phi, \psi$ $(\phi \leq_K \phi \wedge \psi \text{ or } \psi \leq_K \phi \wedge \psi)$	(EE3)	$\forall A, B$ $(A \leq_X A \cap B \text{ or } B \leq_X A \cap B)$
(EE4)	$K \neq K_{\perp} \Rightarrow$ $(\phi \notin K \text{ iff } \forall \psi. \phi \leq_K \psi)$	(EE4)	$X \neq \emptyset \Rightarrow$ $(X \not\subseteq A \text{ iff } \forall B. A \leq_X B)$
(EE5)	$\forall \psi. \psi \leq_K \phi \Rightarrow \vdash \phi$	(EE5)	$\forall B. B \leq_X A \Rightarrow A = U$

karl-search= End Definition AGM

5.1.3 Remark TR-Rank

karl-search= Start Remark TR-Rank

Remark 5.1

(+++ Orig. No.: Remark TR-Rank +++)

LABEL: Remark TR-Rank

(1) Note that (X|7) and (X|8) express a central condition for ranked structures, see Section 3.10: If we note $X | \cdot$ by $f_X(\cdot)$, we then have: $f_X(A) \cap B \neq \emptyset \Rightarrow f_X(A \cap B) = f_X(A) \cap B$.

(2) It is trivial to see that AGM revision cannot be defined by an individual distance (see Definition 2.3.5 below): Suppose $X | Y := \{y \in Y : \exists x_y \in X (\forall y' \in Y. d(x_y, y) \leq d(x_y, y'))\}$. Consider a, b, c . $\{a, b\} | \{b, c\} = \{b\}$ by (X|3) and (X|4), so $d(a, b) < d(a, c)$. But on the other hand $\{a, c\} | \{b, c\} = \{c\}$, so $d(a, b) > d(a, c)$,

contradiction.

karl-search= End Remark TR-Rank

5.1.4 Proposition AGM-Equiv

karl-search= Start Proposition AGM-Equiv

Proposition 5.2

(+++ Orig. No.: Proposition AGM-Equiv +++)

LABEL: Proposition AGM-Equiv

Contraction, revision, and epistemic entrenchment are interdefinable by the following equations, i.e., if the defining side has the respective properties, so will the defined side.

$K * \phi := \overline{(K - \neg\phi)} \cup \phi$	$X A := (X \ominus \mathcal{C}A) \cap A$
$K - \phi := K \cap (K * \neg\phi)$	$X \ominus A := X \cup (X \mathcal{C}A)$
$K - \phi := \{\psi \in K : (\phi <_K \phi \vee \psi \text{ or } \vdash \phi)\}$	$X \ominus A := \begin{cases} X & \text{iff } A = U, \\ \bigcap \{B : X \subseteq B \subseteq U, A <_X A \cup B\} & \text{otherwise} \end{cases}$
$\phi \leq_K \psi \Leftrightarrow \begin{cases} \vdash \phi \wedge \psi \\ \text{or} \\ \phi \notin K - (\phi \wedge \psi) \end{cases}$	$A \leq_X B \Leftrightarrow \begin{cases} A, B = U \\ \text{or} \\ X \ominus (A \cap B) \not\subseteq A \end{cases}$

karl-search= End Proposition AGM-Equiv

5.1.5 Intuit-Entrench

karl-search= Start Intuit-Entrench

The idea of epistemic entrenchment is that ϕ is more entrenched than ψ (relative to K) iff $M(\neg\psi)$ is closer to $M(K)$ than $M(\neg\phi)$ is to $M(K)$. In shorthand, the more we can twiddle K without reaching $\neg\phi$, the more ϕ is entrenched. Truth is maximally entrenched - no twiggling whatever will reach falsity. The more ϕ is entrenched, the more we are certain about it. Seen this way, the properties of epistemic entrenchment relations are very natural (and trivial): As only the closest points of $M(\neg\phi)$ count (seen from $M(K)$), ϕ or ψ will be as entrenched as $\phi \wedge \psi$, and there is a logically strongest ϕ' which is as entrenched as ϕ - this is just the sphere around $M(K)$ with radius $d(M(K), M(\neg\phi))$.

karl-search= End Intuit-Entrench

karl-search= End ToolBase1-TR-AGM

5.2 Distance based revision: Basics

5.2.1 ToolBase1-TR-DistBase

karl-search= Start ToolBase1-TR-DistBase

LABEL: Section Toolbase1-TR-DistBase

5.2.2 Definition Distance

karl-search= Start Definition Distance

Definition 5.2

(+++ Orig. No.: Definition Distance +++)

LABEL: Definition Distance

$d : U \times U \rightarrow Z$ is called a pseudo-distance on U iff (d1) holds:

(d1) Z is totally ordered by a relation $<$.

If, in addition, Z has a $<$ -smallest element 0 , and (d2) holds, we say that d respects identity:

(d2) $d(a, b) = 0$ iff $a = b$.

If, in addition, (d3) holds, then d is called symmetric:

(d3) $d(a, b) = d(b, a)$.

(For any $a, b \in U$.)

Note that we can force the triangle inequality to hold trivially (if we can choose the values in the real numbers): It suffices to choose the values in the set $\{0\} \cup [0.5, 1]$, i.e. in the interval from 0.5 to 1, or as 0.

karl-search= End Definition Distance

5.2.3 Definition Dist-Indiv-Coll

karl-search= Start Definition Dist-Indiv-Coll

Definition 5.3

(+++ Orig. No.: Definition Dist-Indiv-Coll +++)

LABEL: Definition Dist-Indiv-Coll

We define the collective and the individual variant of choosing the closest elements in the second operand by two operators, $|, \uparrow : \mathcal{P}(U) \times \mathcal{P}(U) \rightarrow \mathcal{P}(U)$:

Let d be a distance or pseudo-distance.

$X | Y := \{y \in Y : \exists x_y \in X. \forall x' \in X, \forall y' \in Y (d(x_y, y) \leq d(x', y'))\}$

(the collective variant, used in theory revision)

and

$X \uparrow Y := \{y \in Y : \exists x_y \in X. \forall y' \in Y (d(x_y, y) \leq d(x_y, y'))\}$

(the individual variant, used for counterfactual conditionals and theory update).

Thus, $A |_d B$ is the subset of B consisting of all $b \in B$ that are closest to A . Note that, if A or B is infinite, $A |_d B$ may be empty, even if A and B are not empty. A condition assuring nonemptiness will be imposed when necessary.

karl-search= End Definition Dist-Indiv-Coll

5.2.4 Definition Dist-Repr

karl-search= Start Definition Dist-Repr

Definition 5.4

(+++ Orig. No.: Definition Dist-Repr +++)

LABEL: Definition Dist-Repr

An operation $|: \mathcal{P}(U) \times \mathcal{P}(U) \rightarrow \mathcal{P}(U)$ is representable iff there is a pseudo-distance $d: U \times U \rightarrow Z$ such that $A | B = A |_d B := \{b \in B : \exists a_b \in A \forall a' \in A \forall b' \in B (d(a_b, b) \leq d(a', b'))\}$.

karl-search= End Definition Dist-Repr

5.2.5 Definition TR*d

karl-search= Start Definition TR*d

The following is the central definition, it describes the way a revision $*_d$ is attached to a pseudo-distance d on the set of models.

Definition 5.5

(+++ Orig. No.: Definition TR*d +++)

LABEL: Definition TR*d

$T *_d T' := Th(M(T) |_d M(T'))$.

$*$ is called representable iff there is a pseudo-distance d on the set of models s.t. $T * T' = Th(M(T) |_d M(T'))$.

karl-search= End Definition TR*d

karl-search= End ToolBase1-TR-DistBase

5.3 Distance based revision: Representation

5.3.1 ToolBase1-TR-DistRepr

karl-search= Start ToolBase1-TR-DistRepr

5.3.2 Fact AGM-In-Dist

karl-search= Start Fact AGM-In-Dist

Fact 5.3

(+++ Orig. No.: Fact AGM-In-Dist +++)

LABEL: Fact AGM-In-Dist

A distance based revision satisfies the AGM postulates provided:

- (1) it respects identity, i.e. $d(a, a) < d(a, b)$ for all $a \neq b$,
- (2) it satisfies a limit condition: minima exist,
- (3) it is definability preserving.

(It is trivial to see that the first two are necessary, and Example 5.1 (page 95) (2) below shows the necessity of (3). In particular, (2) and (3) will hold for finite languages.)

karl-search= End Fact AGM-In-Dist

5.3.3 Fact AGM-In-Dist Proof

karl-search= Start Fact AGM-In-Dist Proof

Proof

(+++*** Orig.: Proof)

We use $|$ to abbreviate $|_d$. As a matter of fact, we show slightly more, as we admit also full theories on the right of $*$.

$(K * 1)$, $(K * 2)$, $(K * 6)$ hold by definition, $(K * 3)$ and $(K * 4)$ as d respects identity, $(K * 5)$ by existence of minima.

It remains to show $(K * 7)$ and $(K * 8)$, we do them together, and show: If $T * T'$ is consistent with T'' , then $T * (T' \cup T'') = \overline{(T * T') \cup T''}$.

Note that $M(S \cup S') = M(S) \cap M(S')$, and that $M(S * S') = M(S) | M(S')$. (The latter is only true if $|$ is definability preserving.) By prerequisite, $M(T * T') \cap M(T'') \neq \emptyset$, so $(M(T) | M(T')) \cap M(T'') \neq \emptyset$. Let $A := M(T)$, $B := M(T')$, $C := M(T'')$. “ \subseteq ”: Let $b \in A | (B \cap C)$. By prerequisite, there is $b' \in (A | B) \cap C$. Thus $d(A, b') \geq d(A, B \cap C) = d(A, b)$. As $b \in B$, $b \in A | B$, but $b \in C$, too. “ \supseteq ”: Let $b' \in (A | B) \cap C$. Thus $d(A, b') = d(A, B) \leq d(A, B \cap C)$, so by $b' \in B \cap C$ $b' \in A | (B \cap C)$. We conclude $M(T) | (M(T') \cap M(T'')) = (M(T) | M(T')) \cap M(T'')$, thus that $T * (T' \cup T'') = \overline{(T * T') \cup T''}$.

□

karl-search= End Fact AGM-In-Dist Proof

5.3.4 Definition TR-Umgeb

karl-search= Start Definition TR-Umgeb

Definition 5.6

(+++ Orig. No.: Definition TR-Umgeb +++)

LABEL: Definition TR-Umgeb

For $X, Y \neq \emptyset$, set $U_Y(X) := \{z : d(X, z) \leq d(X, Y)\}$.

karl-search= End Definition TR-Umgeb

5.3.5 Fact TR-Umgeb

karl-search= Start Fact TR-Umgeb

Fact 5.4

(+++ Orig. No.: Fact Tr-Umgeb +++)

LABEL: Fact Tr-Umgeb

Let $X, Y, Z \neq \emptyset$. Then

(1) $U_Y(X) \cap Z \neq \emptyset$ iff $(X \mid (Y \cup Z)) \cap Z \neq \emptyset$,

(2) $U_Y(X) \cap Z \neq \emptyset$ iff $\mathbf{C}Z \leq_X \mathbf{C}Y$ - where \leq_X is epistemic entrenchment relative to X .

karl-search= End Fact TR-Umgeb

5.3.6 Fact TR-Umgeb Proof

karl-search= Start Fact TR-Umgeb Proof

Proof

(+++*** Orig.: Proof)

(1) Trivial.

(2) $\mathbf{C}Z \leq_X \mathbf{C}Y$ iff $X \ominus (\mathbf{C}Z \cap \mathbf{C}Y) \not\subseteq \mathbf{C}Z$. $X \ominus (\mathbf{C}Z \cap \mathbf{C}Y) = X \cup (X \mid \mathbf{C}(\mathbf{C}Z \cap \mathbf{C}Y)) = X \cup (X \mid (Z \cup Y))$.
So $X \ominus (\mathbf{C}Z \cap \mathbf{C}Y) \not\subseteq \mathbf{C}Z \Leftrightarrow (X \cup (X \mid (Z \cup Y))) \cap Z \neq \emptyset \Leftrightarrow X \cap Z \neq \emptyset$ or $(X \mid (Z \cup Y)) \cap Z \neq \emptyset \Leftrightarrow d(X, Z) \leq d(X, Y)$.

□

karl-search= End Fact TR-Umgeb Proof

5.3.7 Definition TR-Dist

karl-search= Start Definition TR-Dist

Definition 5.7

(+++ Orig. No.: Definition TR-Dist +++)

LABEL: Definition TR-Dist

Let $U \neq \emptyset$, $\mathcal{Y} \subseteq \mathcal{P}(U)$ satisfy (\cap) , (\cup) , $\emptyset \notin \mathcal{Y}$.

Let $A, B, X_i \in \mathcal{Y}$, $|\cdot|: \mathcal{Y} \times \mathcal{Y} \rightarrow \mathcal{P}(U)$.

Let $*$ be a revision function defined for arbitrary consistent theories on both sides. (This is thus a slight extension of the AGM framework, as AGM work with formulas only on the right of $*$.)

		$\models T \leftrightarrow S, \models T' \leftrightarrow S', \Rightarrow T * T' = S * S'$,
		$T * T'$ is a consistent, deductively closed theory,
	$(Succ)$ $A B \subseteq B$	$T' \subseteq T * T'$,
	(Con) $A \cap B \neq \emptyset \Rightarrow A B = A \cap B$	$Con(T \cup T') \Rightarrow T * T' = \overline{T \cup T'}$,
	$(Loop)$	
Intuitively, Using symmetry $d(X_0, X_1) \leq d(X_1, X_2)$, $d(X_1, X_2) \leq d(X_2, X_3)$, $d(X_2, X_3) \leq d(X_3, X_4)$... $d(X_{k-1}, X_k) \leq d(X_0, X_k)$ \Rightarrow $d(X_0, X_1) \leq d(X_0, X_k)$, i.e. transitivity, or absence of loops involving $<$	$(X_1 (X_0 \cup X_2)) \cap X_0 \neq \emptyset$, $(X_2 (X_1 \cup X_3)) \cap X_1 \neq \emptyset$, $(X_3 (X_2 \cup X_4)) \cap X_2 \neq \emptyset$, ... $(X_k (X_{k-1} \cup X_0)) \cap X_{k-1} \neq \emptyset$ \Rightarrow $(X_0 (X_k \cup X_1)) \cap X_1 \neq \emptyset$	$Con(T_0, T_1 * (T_0 \vee T_2))$, $Con(T_1, T_2 * (T_1 \vee T_3))$, $Con(T_2, T_3 * (T_2 \vee T_4))$... $Con(T_{k-1}, T_k * (T_{k-1} \vee T_0))$ \Rightarrow $Con(T_1, T_0 * (T_k \vee T_1))$

karl-search= End Definition TR-Dist

5.3.8 Definition TR-Dist-Rotate

karl-search= Start Definition TR-Dist-Rotate

Definition 5.8

(+++ Orig. No.: Definition TR-Dist-Rotate +++)

LABEL: Definition TR-Dist-Rotate

Let $U \neq \emptyset$, $\mathcal{Y} \subseteq \mathcal{P}(U)$ satisfy (\cap) , (\cup) , $\emptyset \notin \mathcal{Y}$.

Let $A, B, X_i \in \mathcal{Y}$, $|\cdot|: \mathcal{Y} \times \mathcal{Y} \rightarrow \mathcal{P}(U)$.

Let $*$ be a revision function defined for arbitrary consistent theories on both sides. (This is thus a slight extension of the AGM framework, as AGM work with formulas only on the right of $*$.)

		$\frac{(*Equiv)}{\models T \leftrightarrow S, \models T' \leftrightarrow S' \Rightarrow T * T' = S * S'},$
		$\frac{(*CCL)}{T * T' \text{ is a consistent, deductively closed theory,}}$
	$\frac{(Succ)}{A \mid B \subseteq B}$	$\frac{(*Succ)}{T' \subseteq T * T'},$
	$\frac{(Con)}{A \cap B \neq \emptyset \Rightarrow A \mid B = A \cap B}$	$\frac{(*Con)}{Con(T \cup T') \Rightarrow T * T' = \overline{T \cup T'}},$
	$\frac{(Loop)}{\text{Intuitively,}} \Rightarrow$	$\frac{(*Loop)}{\text{Con}(T_0, T_1 * (T_0 \vee T_2)),}$
Using symmetry	$(X_1 \mid (X_0 \cup X_2)) \cap X_0 \neq \emptyset,$	$\text{Con}(T_1, T_2 * (T_1 \vee T_3)),$
$d(X_0, X_1) < d(X_1, X_2),$	$(X_2 \mid (X_1 \cup X_3)) \cap X_1 \neq \emptyset,$	$\text{Con}(T_2, T_3 * (T_2 \vee T_4))$
$d(X_1, X_2) \leq d(X_2, X_3),$	$(X_3 \mid (X_2 \cup X_4)) \cap X_2 \neq \emptyset,$	\dots
$d(X_2, X_3) \leq d(X_3, X_4)$	\dots	$\text{Con}(T_{k-1}, T_k * (T_{k-1} \vee T_0))$
\dots	$(X_k \mid (X_{k-1} \cup X_0)) \cap X_{k-1} \neq \emptyset$	\Rightarrow
$d(X_{k-1}, X_k) \leq d(X_0, X_k)$	\Rightarrow	$\text{Con}(T_1, T_0 * (T_k \vee T_1))$
$d(X_0, X_1) \leq d(X_0, X_k),$	$(X_0 \mid (X_k \cup X_1)) \cap X_1 \neq \emptyset$	
i.e. transitivity, or absence of loops involving <		

karl-search= End Definition TR-Dist-Rotate

5.3.9 Proposition TR-Alg-Log

karl-search= Start Proposition TR-Alg-Log

Proposition 5.5

(+++ Orig. No.: Proposition TR-Alg-Log +++)

LABEL: Proposition TR-Alg-Log

The following connections between the logical and the algebraic side might be the most interesting ones. We will consider in all cases also the variant with full theories.

Given * which respects logical equivalence, let $M(T) \mid M(T') := M(T * T')$, conversely, given \mid , let $T * T' := Th(M(T) \mid M(T'))$. We then have:

(1.1)	$(K * 7)$	\Rightarrow	$(X 7)$
(1.2)		$\Leftarrow (\mu dp)$	
(1.3)		$\Leftarrow B$ is the model set for some ϕ	
(1.4)		\neq in general	
(2.1)	$(*Loop)$	\Rightarrow	$(Loop)$
(2.2)		$\Leftarrow (\mu dp)$	
(2.3)		\Leftarrow all X_i are the model sets for some ϕ_i	
(2.4)		\neq in general	

karl-search= End Proposition TR-Alg-Log

5.3.10 Proposition TR-Alg-Log Proof

karl-search= Start Proposition TR-Alg-Log Proof

Proof

(+++*** Orig.: Proof)

(1)

We consider the equivalence of $T * (T' \cup T'') \subseteq \overline{(T * T') \cup T''}$ and $(M(T) | M(T')) \cap M(T'') \subseteq M(T) | (M(T') \cap M(T''))$.

(1.1)

$$(M(T) | M(T')) \cap M(T'') = M(T * T') \cap M(T'') = M((T * T') \cup T'') \subseteq_{(K * 7)} M(T * (T' \cup T'')) = M(T) | M(T' \cup T'')$$

$$= M(T) | (M(T') \cap M(T'')).$$

(1.2)

$$T * (T' \cup T'') = Th(M(T) | M(T' \cup T'')) = Th(M(T) | (M(T') \cap M(T''))) \subseteq_{(X | 7)} Th((M(T) | M(T')) \cap M(T''))$$

$$=_{(\mu dp)} \overline{Th(M(T) | M(T')) \cup T''} = \overline{Th(M(T * T') \cup T'')} = \overline{(T * T') \cup T''}.$$

(1.3)

Let T'' be equivalent to ϕ'' . We can then replace the use of (μdp) in the proof of (1.2) by Fact 2.3 (page 16) (3).

(1.4)

By Example 5.1 (page 95) (2), $(K * 7)$ may fail, though $(X | 7)$ holds.

(2.1) and (2.2):

$$Con(T_0, T_1 * (T_0 \vee T_2)) \Leftrightarrow M(T_0) \cap M(T_1 * (T_0 \vee T_2)) \neq \emptyset.$$

$$M(T_1 * (T_0 \vee T_2)) = M(Th(M(T_1) | M(T_0 \vee T_2))) = M(Th(M(T_1) | (M(T_0) \cup M(T_2)))) =_{(\mu dp)} M(T_1) | (M(T_0) \cup M(T_2)),$$

so $Con(T_0, T_1 * (T_0 \vee T_2)) \Leftrightarrow M(T_0) \cap (M(T_1) | (M(T_0) \cup M(T_2))) \neq \emptyset$.

Thus, all conditions translate one-to-one, and we use $(| Loop)$ and $(*Loop)$ to go back and forth.

(2.3):

Let $A := M(Th(M(T_1) | (M(T_0) \cup M(T_2))))$, $A' := M(T_1) | (M(T_0) \cup M(T_2))$, then we do not need $A = A'$, it suffices to have $M(T_0) \cap A \neq \emptyset \Leftrightarrow M(T_0) \cap A' \neq \emptyset$. $A = \widehat{A'}$, so we can use Fact 2.3 (page 16) (4), if T_0 is equivalent to some ϕ_0 .

This has to hold for all T_i , so all T_i have to be equivalent to some ϕ_i .

(2.4):

By Proposition 5.6 (page 96) , all distance defined $|$ satisfy $(| Loop)$. By Example 5.1 (page 95) (1), $(*Loop)$ may fail.

□

karl-search= End Proposition TR-Alg-Log Proof

5.3.11 Proposition TR-Representation-With-Ref

karl-search= Start Proposition TR-Representation-With-Ref

The following table summarizes representation of theory revision functions by structures with a distance.

By “pseudo-distance” we mean here a pseudo-distance which respects identity, and is symmetrical.

($\mid \emptyset$) means that if $X, Y \neq \emptyset$, then $X \mid_d Y \neq \emptyset$. LABEL: Proposition TR-Representation-With-Ref

- function		Distance Structure		*- function
($\mid Succ$) + ($\mid Con$) + ($\mid Loop$)	\Leftrightarrow , (\cup) + (\cap) Proposition 5.6 page 96	pseudo-distance	\Leftrightarrow (μdp) + ($\mid \emptyset$) Proposition 5.7 page 96	($\ast Equiv$) + ($\ast CCL$) + ($\ast Succ$) + ($\ast Con$) + ($\ast Loop$)
any finite characterization	$\not\Leftrightarrow$ Proposition 5.8 page 98		$\not\Leftrightarrow$ without (μdp) Example 5.1 page 95	

karl-search= End Proposition TR-Representation-With-Ref

5.3.12 Example TR-Dp

karl-search= Start Example TR-Dp

The following Example 5.1 (page 95) shows that, in general, a revision operation defined on models via a pseudo-distance by $T \ast T' := Th(M(T) \mid_d M(T'))$ might not satisfy ($\ast Loop$) or ($K \ast 7$), unless we require \mid_d to preserve definability.

Example 5.1

(+++ Orig. No.: Example TR-Dp +++)

LABEL: Example TR-Dp

Consider an infinite propositional language \mathcal{L} .

Let X be an infinite set of models, m, m_1, m_2 be models for \mathcal{L} . Arrange the models of \mathcal{L} in the real plane s.t. all $x \in X$ have the same distance < 2 (in the real plane) from m , m_2 has distance 2 from m , and m_1 has distance 3 from m .

Let T, T_1, T_2 be complete (consistent) theories, T' a theory with infinitely many models, $M(T) = \{m\}$, $M(T_1) = \{m_1\}$, $M(T_2) = \{m_2\}$. The two variants diverge now slightly:

- (1) $M(T') = X \cup \{m_1\}$. T, T', T_2 will be pairwise inconsistent.
- (2) $M(T') = X \cup \{m_1, m_2\}$, $M(T'') = \{m_1, m_2\}$.

Assume in both cases $Th(X) = T'$, so X will not be definable by a theory.

Now for the results:

Then $M(T) \mid M(T') = X$, but $T \ast T' = Th(X) = T'$.

(1) We easily verify $Con(T, T_2 \ast (T \vee T))$, $Con(T_2, T \ast (T_2 \vee T_1))$, $Con(T, T_1 \ast (T \vee T))$, $Con(T_1, T \ast (T_1 \vee T'))$, $Con(T, T' \ast (T \vee T))$, and conclude by Loop (i.e. ($\ast Loop$)) $Con(T_2, T \ast (T' \vee T_2))$, which is wrong.

(2) So $T * T'$ is consistent with T'' , and $\overline{(T * T') \cup T''} = T''$. But $T' \cup T'' = T''$, and $T * (T' \cup T'') = T_2 \neq T''$, contradicting $(K * 7)$.

□

karl-search= End Example TR-Dp

5.3.13 Proposition TR-Alg-Repr

karl-search= Start Proposition TR-Alg-Repr

Proposition 5.6

(+++ Orig. No.: Proposition TR-Alg-Repr +++)

LABEL: Proposition TR-Alg-Repr

Let $U \neq \emptyset$, $\mathcal{Y} \subseteq \mathcal{P}(U)$ be closed under finite \cap and finite \cup , $\emptyset \notin \mathcal{Y}$.

(a) $|$ is representable by a symmetric pseudo-distance $d : U \times U \rightarrow Z$ iff $|$ satisfies ($| Succ$) and ($| Loop$) in Definition 5.7 (page 92) .

(b) $|$ is representable by an identity respecting symmetric pseudo-distance $d : U \times U \rightarrow Z$ iff $|$ satisfies ($| Succ$), ($| Con$), and ($| Loop$) in Definition 5.7 (page 92) .

See [LMS01] or [Sch04].

karl-search= End Proposition TR-Alg-Repr

5.3.14 Proposition TR-Log-Repr

karl-search= Start Proposition TR-Log-Repr

Proposition 5.7

(+++ Orig. No.: Proposition TR-Log-Repr +++)

LABEL: Proposition TR-Log-Repr

Let \mathcal{L} be a propositional language.

(a) A revision operation $*$ is representable by a symmetric consistency and definability preserving pseudo-distance iff $*$ satisfies ($*Equiv$), ($*CCL$), ($*Succ$), ($*Loop$).

(b) A revision operation $*$ is representable by a symmetric consistency and definability preserving, identity respecting pseudo-distance iff $*$ satisfies ($*Equiv$), ($*CCL$), ($*Succ$), ($*Con$), ($*Loop$).

See [LMS01] or [Sch04].

karl-search= End Proposition TR-Log-Repr

5.3.15 Example WeakTR

karl-search= Start Example WeakTR

Example 5.2

(+++ Orig. No.: Example WeakTR +++)

LABEL: Example WeakTR

This example shows the expressive weakness of revision based on distance: not all distance relations can be reconstructed from the revision operator. Thus, a revision operator does not allow to “observe” all distances relations, so transitivity of \leq cannot necessarily be captured in a short condition, requiring arbitrarily long conditions, see Proposition 5.8 (page 98) .

Note that even when the pseudo-distance is a real distance, the resulting revision operator $|_d$ does not always permit to reconstruct the relations of the distances: revision is a coarse instrument to investigate distances.

Distances with common start (or end, by symmetry) can always be compared by looking at the result of revision:

$$a |_d \{b, b'\} = b \text{ iff } d(a, b) < d(a, b'),$$

$$a |_d \{b, b'\} = b' \text{ iff } d(a, b) > d(a, b'),$$

$$a |_d \{b, b'\} = \{b, b'\} \text{ iff } d(a, b) = d(a, b').$$

This is not the case with arbitrary distances $d(x, y)$ and $d(a, b)$, as this example will show.

We work in the real plane, with the standard distance, the angles have 120 degrees. a' is closer to y than x is to y , a is closer to b than x is to y , but a' is farther away from b' than x is from y . Similarly for b, b' . But we cannot distinguish the situation $\{a, b, x, y\}$ and the situation $\{a', b', x, y\}$ through $|_d$. (See Diagram 5.1 (page 97)):

Seen from a , the distances are in that order: y, b, x .

Seen from a' , the distances are in that order: y, b', x .

Seen from b , the distances are in that order: y, a, x .

Seen from b' , the distances are in that order: y, a', x .

Seen from y , the distances are in that order: $a/b, x$.

Seen from y , the distances are in that order: $a'/b', x$.

Seen from x , the distances are in that order: $y, a/b$.

Seen from x , the distances are in that order: $y, a'/b'$.

Thus, any $c |_d C$ will be the same in both situations (with a interchanged with a' , b with b'). The same holds for any $X |_d C$ where X has two elements.

Thus, any $C |_d D$ will be the same in both situations, when we interchange a with a' , and b with b' . So we cannot determine by $|_d$ whether $d(x, y) > d(a, b)$ or not. \square

Diagram 5.1 LABEL: Diagram WeakTR

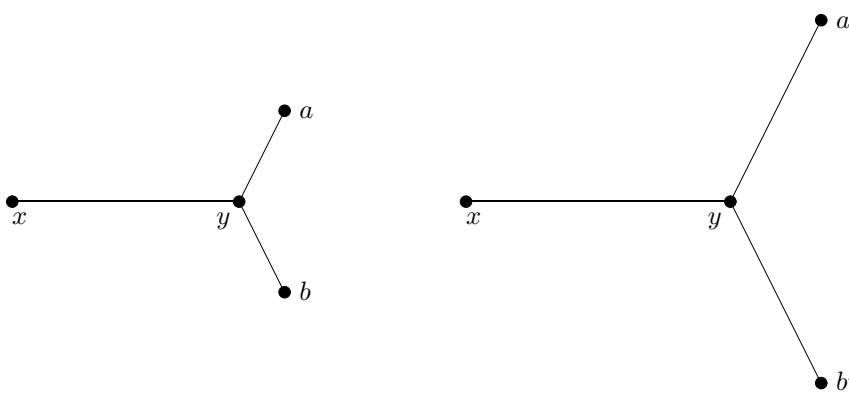

Indiscernible by revision

karl-search= End Example WeakTR

5.3.16 Proposition Hamster

karl-search= Start Proposition Hamster

Proposition 5.8

(+++ Orig. No.: Proposition Hamster +++)

LABEL: Proposition Hamster

There is no finite characterization of distance based $|$ $-$ operators.

(Attention: this is, of course, false when we fix the left hand side: the AGM axioms give a finite characterization. So this also shows the strength of being able to change the left hand side.)

See [Sch04].

karl-search= End Proposition Hamster

karl-search= End ToolBase1-TR-DistRepr

karl-search= End ToolBase1-TR

6 Size

6.1

6.1.1 ToolBase1-Size

karl-search= Start ToolBase1-Size

LABEL: Section Toolbase1-Size

6.1.2 Definition Filter

karl-search= Start Definition Filter

Definition 6.1

(+++ Orig. No.: Definition Filter +++)

LABEL: Definition Filter

A filter is an abstract notion of size, elements of a filter $\mathcal{F}(X)$ on X are called big subsets of X , their complements are called small, and the rest have medium size. The dual applies to ideals $\mathcal{I}(X)$, this is justified by the trivial fact that $\{X - A : A \in \mathcal{F}(X)\}$ is an ideal iff $\mathcal{F}(X)$ is a filter.

In both definitions, the first two conditions (i.e. $(FAll)$, $(I\emptyset)$, and $(F\uparrow)$, $(I\downarrow)$) should hold if the notions shall have anything to do with usual intuition, and there are reasons to consider only the weaker, less idealistic, version of the third.

At the same time, we introduce - in rough parallel - coherence conditions which describe what might happen when we change the reference or base set X . $(R\uparrow)$ is very natural, $(R\downarrow)$ is more daring, and $(R\downarrow\downarrow)$ even more so. $(R\cup disj)$ is a cautious combination of $(R\uparrow)$ and $(R\cup)$, as we avoid using the same big set several times in comparison, so $(R\cup)$ is used more cautiously here. See Remark 6.1 (page 105) for more details.

Finally, we give a generalized first order quantifier corresponding to a (weak) filter. The precise connection is formulated in Definition 6.3 (page 108), Definition 6.4 (page 109), Definition 6.5 (page 109), and Proposition 6.4 (page 109), respectively their relativized versions.

Fix now a base set $X \neq \emptyset$.

A (weak) filter on or over X is a set $\mathcal{F}(X) \subseteq \mathcal{P}(X)$, s.t. $(FAll)$, $(F\uparrow)$, $(F\cap)$ ($(FAll)$, $(F\uparrow)$, $(F\cap')$ respectively) hold.

A filter is called a principal filter iff there is $X' \subseteq X$ s.t. $\mathcal{F} = \{A : X' \subseteq A \subseteq X\}$.

A filter is called an ultrafilter iff for all $X' \subseteq X$ $X' \in \mathcal{F}(X)$ or $X - X' \in \mathcal{F}(X)$.

A (weak) ideal on or over X is a set $\mathcal{I}(X) \subseteq \mathcal{P}(X)$, s.t. $(I\emptyset)$, $(I\downarrow)$, $(I\cup)$ ($(I\emptyset)$, $(I\downarrow)$, $(I\cup')$ respectively) hold.

Finally, we set $\mathcal{M}(X) := \{A \subseteq X : A \notin \mathcal{I}(X), A \notin \mathcal{F}(X)\}$, the “medium size” sets, and $\mathcal{M}^+(X) := \mathcal{M}(X) \cup \mathcal{F}(X)$, $\mathcal{M}^+(X)$ is the set of subsets of X , which are not small, i.e. have medium or large size.

For $(R\downarrow)$ and $(R\downarrow\downarrow)$ $(-)$ is assumed in the following table.

Optimum			
$(FAll)$ $X \in \mathcal{F}(X)$	$(I\emptyset)$ $\emptyset \in \mathcal{I}(X)$		$\forall x\phi(x) \rightarrow \nabla x\phi(x)$
Improvement			
$(F\uparrow)$ $A \subseteq B \subseteq X,$ $A \in \mathcal{F}(X) \Rightarrow$ $B \in \mathcal{F}(X)$	$(I\downarrow)$ $A \subseteq B \subseteq X,$ $B \in \mathcal{I}(X) \Rightarrow$ $A \in \mathcal{I}(X)$	$(R\uparrow)$ $X \subseteq Y \Rightarrow \mathcal{I}(X) \subseteq \mathcal{I}(Y)$	$\nabla x\phi(x) \wedge$ $\forall x(\phi(x) \rightarrow \psi(x)) \rightarrow$ $\nabla x\psi(x)$
Adding small sets			
$(F\cap)$ $A, B \in \mathcal{F}(X) \Rightarrow$ $A \cap B \in \mathcal{F}(X)$	$(I\cup)$ $A, B \in \mathcal{I}(X) \Rightarrow$ $A \cup B \in \mathcal{I}(X)$	$(R\downarrow)$ $A, B \in \mathcal{I}(X) \Rightarrow$ $A - B \in \mathcal{I}(X - B)$ or: $A \in \mathcal{F}(X), B \in \mathcal{I}(X) \Rightarrow$ $A - B \in \mathcal{F}(X - B)$	$\nabla x\phi(x) \wedge \nabla x\psi(x) \rightarrow$ $\nabla x(\phi(x) \wedge \psi(x))$
Cautious addition			
$(F\cap')$ $A, B \in \mathcal{F}(X) \Rightarrow$ $A \cap B \neq \emptyset.$	$(I\cup')$ $A, B \in \mathcal{I}(X) \Rightarrow$ $A \cup B \neq X.$	$(R\cup disj)$ $A \in \mathcal{I}(X), B \in \mathcal{I}(Y), X \cap Y = \emptyset \Rightarrow$ $A \cup B \in \mathcal{I}(X \cup Y)$	$\nabla x\phi(x) \rightarrow \neg \nabla x\neg\phi(x)$ and $\nabla x\phi(x) \rightarrow \exists x\phi(x)$
Bold addition			
Ultrafilter	(Dual of) Ultrafilter	$(R\downarrow\downarrow)$ $A \in \mathcal{I}(X), B \notin \mathcal{F}(X) \Rightarrow$ $A - B \in \mathcal{I}(X - B)$ or: $A \in \mathcal{F}(X), B \notin \mathcal{F}(X) \Rightarrow$ $A - B \in \mathcal{F}(X - B)$ or: $A \in \mathcal{M}^+(X), X \in \mathcal{M}^+(Y) \Rightarrow$ $A \in \mathcal{M}^+(Y)$ - Transitivity of \mathcal{M}^+	$\neg \nabla x\phi(x) \rightarrow \nabla x\neg\phi(x)$

These notions are related to nonmonotonic logics as follows:

We can say that, normally, ϕ implies ψ iff in a big subset of all ϕ -cases, ψ holds. In preferential terms, ϕ implies ψ iff ψ holds in all minimal ϕ -models. If μ is the model choice function of a preferential structure, i.e. $\mu(\phi)$ is the set of minimal ϕ -models, then $\mu(\phi)$ will be a (the smallest) big subset of the set of ϕ -models, and the filter over the ϕ -models is the principal filter generated by $\mu(\phi)$.

Due to the finite intersection property, filters and ideals work well with logics: If ϕ holds normally, as it holds in a big subset, and so does ϕ' , then $\phi \wedge \phi'$ will normally hold, too, as the intersection of two big subsets is big again. This is a nice property, but not justified in all situations, consider e.g. simple counting of a finite subset. (The question has a name, "lottery paradox": normally no single participant wins, but someone wins in the end.) This motivates the weak versions.

Normality defined by (weak or not) filters is a local concept: the filter defined on X and the one defined on X' might be totally independent.

Seen more abstractly, set properties like e.g. $(R\uparrow)$ allow the transfer of big (or small) subsets from one to another base set (and the conclusions drawn on this basis), and we call them "coherence properties". They are very important, not only for working with a logic which respects them, but also for soundness and completeness questions, often they are at the core of such problems.

karl-search= End Definition Filter

6.1.3 Definition Filter2

karl-search= Start Definition Filter2

Definition 6.2

(+++ Orig. No.: Definition Filter2 +++)

LABEL: Definition Filter2

A filter is an abstract notion of size, elements of a filter $\mathcal{F}(X)$ on X are called big subsets of X , their complements are called small, and the rest have medium size. The dual applies to ideals $\mathcal{I}(X)$, this is justified by the trivial fact that $\{X - A : A \in \mathcal{F}(X)\}$ is an ideal iff $\mathcal{F}(X)$ is a filter.

In both definitions, the first two conditions (i.e. $(FAll)$, $(I\emptyset)$, and $(F\uparrow)$, $(I\downarrow)$) should hold if the notions shall have anything to do with usual intuition, and there are reasons to consider only the weaker, less idealistic, version of the third.

At the same time, we introduce - in rough parallel - coherence conditions which describe what might happen when we change the reference or base set X . $(R\uparrow)$ is very natural, $(R\downarrow)$ is more daring, and $(R\downarrow\downarrow)$ even more so. $(R\cup disj)$ is a cautious combination of $(R\uparrow)$ and $(R\cup)$, as we avoid using the same big set several times in comparison, so $(R\cup)$ is used more cautiously here. See Remark 6.1 (page 105) for more details.

Finally, we give a generalized first order quantifier corresponding to a (weak) filter. The precise connection is formulated in Definition 6.3 (page 108) , Definition 6.4 (page 109) , Definition 6.5 (page 109) , and Proposition 6.4 (page 109) , respectively their relativized versions.

Fix now a base set $X \neq \emptyset$.

A (weak) filter on or over X is a set $\mathcal{F}(X) \subseteq \mathcal{P}(X)$, s.t. $(FAll)$, $(F\uparrow)$, $(F\cap)$ ($(FAll)$, $(F\uparrow)$, $(F\cap')$ respectively) hold.

A filter is called a principal filter iff there is $X' \subseteq X$ s.t. $\mathcal{F} = \{A : X' \subseteq A \subseteq X\}$.

A filter is called an ultrafilter iff for all $X' \subseteq X$ $X' \in \mathcal{F}(X)$ or $X - X' \in \mathcal{F}(X)$.

A (weak) ideal on or over X is a set $\mathcal{I}(X) \subseteq \mathcal{P}(X)$, s.t. $(I\emptyset)$, $(I\downarrow)$, $(I\cup)$ ($(I\emptyset)$, $(I\downarrow)$, $(I\cup')$ respectively) hold.

Finally, we set $\mathcal{M}(X) := \{A \subseteq X : A \notin \mathcal{I}(X), A \notin \mathcal{F}(X)\}$, the “medium size” sets, and $\mathcal{M}^+(X) := \mathcal{M}(X) \cup \mathcal{F}(X)$, $\mathcal{M}^+(X)$ is the set of subsets of X , which are not small, i.e. have medium or large size.

For $(R\downarrow)$ and $(R\downarrow\downarrow)$ $(-)$ is assumed in the following table.

Filter	Ideal	Coherence	∇
Not trivial			
$(F\emptyset)$ $\emptyset \notin \mathcal{F}(X)$	$(IAll)$ $X \notin \mathcal{I}(X)$		$(\nabla\exists)$ $\nabla x\phi(x) \rightarrow \exists x\phi(x)$
Optimal proportion			
$(FAll)$ $X \in \mathcal{F}(X)$	$(I\emptyset)$ $\emptyset \in \mathcal{I}(X)$		(∇All) $\forall x\phi(x) \rightarrow \nabla x\phi(x)$
Improving proportions			
$(F\uparrow)$ $A \subseteq B \subseteq X,$ $A \in \mathcal{F}(X) \Rightarrow$ $B \in \mathcal{F}(X)$	$(I\downarrow)$ $A \subseteq B \subseteq X,$ $B \in \mathcal{I}(X) \Rightarrow$ $A \in \mathcal{I}(X)$	$(R\uparrow)$ $X \subset Y \Rightarrow \mathcal{I}(X) \subseteq \mathcal{I}(Y)$	$(\nabla\uparrow)$ $\nabla x\phi(x) \wedge$ $\forall x(\phi(x) \rightarrow \psi(x)) \rightarrow$ $\nabla x\psi(x)$
Improving or keeping proportions			
		$(R \cup disj+)$ $A \in \mathcal{I}(X), B \in \mathcal{I}(Y),$ $(X - A) \cap (Y - B) = \emptyset \Rightarrow$ $A \cup B \in \mathcal{I}(X \cup Y)$	
Keeping proportions			
		$(R \cup disj)$ $A \in \mathcal{I}(X), B \in \mathcal{I}(Y),$ $X \cap Y = \emptyset \Rightarrow$ $A \cup B \in \mathcal{I}(X \cup Y)$	
2-Robustness of proportions (small+small \neq all)			
$(F\cap 2)$ $A, B \in \mathcal{F}(X) \Rightarrow$ $A \cap B \neq \emptyset.$	$(I\cup 2)$ $A, B \in \mathcal{I}(X) \Rightarrow$ $A \cup B \neq X.$	$(R\downarrow 2)$ $A \in \mathcal{F}(X), X \in \mathcal{F}(Y) \Rightarrow$ $A \in \mathcal{M}^+(Y)$	$(\nabla\downarrow 2)$ $\nabla x\phi(x) \rightarrow \nabla x\neg\phi(x)$ New rules: (1) $\alpha \sim \beta \Rightarrow \alpha \not\sim \neg\beta$ (2) $\alpha \sim \beta, \alpha \sim \beta' \Rightarrow \alpha \wedge \beta \not\sim \neg\beta'$
n -Robustness of proportions (n *small \neq all)			
$(F\cap n)$ $X_1, \dots, X_n \in \mathcal{F}(X) \Rightarrow$ $X_1 \cap \dots \cap X_n \neq \emptyset.$	$(I\cup n)$ $X_1, \dots, X_n \in \mathcal{I}(X) \Rightarrow$ $X_1 \cup \dots \cup X_n \neq X.$	$(R\downarrow n)$ $X_1 \in \mathcal{F}(X_2), \dots, X_{n-1} \in \mathcal{F}(X_n) \Rightarrow$ $X_1 \in \mathcal{M}^+(X_n)$	$(\nabla\downarrow n)$ $\nabla x\phi_1(x) \wedge \dots \wedge \nabla x\phi_{n-1}(x) \rightarrow$ $\neg\nabla x(\neg\phi_1 \vee \dots \vee \neg\phi_{n-1})(x)$ New rules: (1) $\alpha \sim \beta_1, \dots, \alpha \sim \beta_{n-1} \Rightarrow$ $\alpha \not\sim (\neg\beta_1 \vee \dots \vee \neg\beta_{n-1})$ (2) $\alpha \sim \beta_1, \dots, \alpha \sim \beta_n \Rightarrow$ $\alpha \wedge \beta_1 \wedge \dots \wedge \beta_{n-1} \not\sim \neg\beta_n$
ω -Robustness of proportions (small+small=small)			
$(F\cap \omega)$ $A, B \in \mathcal{F}(X) \Rightarrow$ $A \cap B \in \mathcal{F}(X)$	$(I\cup \omega)$ $A, B \in \mathcal{I}(X) \Rightarrow$ $A \cup B \in \mathcal{I}(X)$	$(R\downarrow \omega)$ (1) $A, B \in \mathcal{I}(X) \Rightarrow$ $A - B \in \mathcal{I}(X - B)$ or: (2) $A \in \mathcal{F}(X), B \in \mathcal{I}(X) \Rightarrow$ $A - B \in \mathcal{F}(X - B)$ or: (3) $A \in \mathcal{F}(X), X \in \mathcal{M}^+(Y) \Rightarrow$ $A \in \mathcal{M}^+(Y)$ or: (4) $A \in \mathcal{M}^+(X), X \in \mathcal{F}(Y) \Rightarrow$ $A \in \mathcal{M}^+(Y)$	$(\nabla\omega)$ $\nabla x\phi(x) \wedge \nabla x\psi(x) \rightarrow$ $\nabla x(\phi(x) \wedge \psi(x))$
Strong robustness of proportions			
		$(R\downarrow\downarrow)$ (1) $A \in \mathcal{I}(X), B \notin \mathcal{F}(X) \Rightarrow$ $A - B \in \mathcal{I}(X - B)$ or: (2) $A \in \mathcal{F}(X), B \notin \mathcal{F}(X) \Rightarrow$ $A - B \in \mathcal{F}(X - B)$ or: (3) $A \in \mathcal{M}^+(X), X \in \mathcal{M}^+(Y) \Rightarrow$ $A \in \mathcal{M}^+(Y)$ (Transitivity of \mathcal{M}^+)	
Ultrafilter			
Ultrafilter	(Dual of) Ultrafilter		$\neg\nabla x\phi(x) \rightarrow \nabla x\neg\phi(x)$

6.1.4 New notations:

$$(F\cap') \rightarrow (F\cap 2), (I\cap') \rightarrow (I\cap 2), (R\downarrow -) \rightarrow (R\downarrow 2),$$

$(F \cap) \rightarrow (F \cap \omega), (I \cap) \rightarrow (I \cap \omega), (R \downarrow) \rightarrow (R \downarrow \omega),$

6.1.5 Algebra of size:

(1) internal:

(1.1) $n * small = medium \Rightarrow 2n * small = all$

(1.2) $n * small = big \Rightarrow (n + 1) * small = all$

(1.3) $medium + small \neq big?$

(1.4) $n * small = all$

So, for (1) the number of “small” which can be all seems to be the decisive measure.

(2) downward:

(2.1) small in $X \Rightarrow$ small in $(X - n * small)$

(2.2) small in $X \Rightarrow$ small in $(X\text{-medium})$

(3) upward:

(3.1) big in X, X big in $Y \Rightarrow$ big in Y , oder wenigstens \mathcal{M}^+

(3.2) big in $X, Y = X + n * small$ (in Y) $\Rightarrow big/\mathcal{M}^+$ in Y

(3.3) big in X, X big in Y, Y big in $Z \dots \Rightarrow big/\mathcal{M}^+$ in \dots

(3.4) Analogue for starting with medium in X , instead of big in X .

Is upward already induction?

What about representativity (true induction), which replaces size?

Is this logical similarity, whereas the others are size similarities?

6.1.6 Remarks:

Note that $\alpha \sim \beta \Rightarrow \alpha \not\sim \neg\beta$ is less than $\alpha \not\sim \perp$

From $\alpha \sim \beta, \alpha \sim \beta' \Rightarrow \alpha \wedge \beta \not\sim \neg\beta'$ to $(R \rightarrow) : A = \neg\beta', X = \alpha \wedge \beta, Y = \alpha$, go backwards.

Is $(R \downarrow) X \in \mathcal{F}(Y), Y \in \mathcal{M}^+(Z) \Rightarrow X \in \mathcal{M}^+(Z)$ or similar? Yes, still prove!

Other rules:

(1) For $(R \cup disj) A \cap B = \emptyset$ not needed, even better without

(2) For $(R(\downarrow))$ 2. also $\alpha \sim \beta, \alpha \sim \beta' \Rightarrow \alpha \not\sim \neg\beta \vee \neg\beta'$

(3) $small + small + small \neq all$ multitude of such rules,

$A \in \mathcal{F}(X), X \in \mathcal{F}(Y), Y \in \mathcal{F}(Z) \Rightarrow A \in \mathcal{M}^+(Z)$ etc.

These notions are related to nonmonotonic logics as follows:

We can say that, normally, ϕ implies ψ iff in a big subset of all ϕ -cases, ψ holds. In preferential terms, ϕ implies ψ iff ψ holds in all minimal ϕ -models. If μ is the model choice function of a preferential structure, i.e. $\mu(\phi)$ is the set of minimal ϕ -models, then $\mu(\phi)$ will be a (the smallest) big subset of the set of ϕ -models, and the filter over the ϕ -models is the principal filter generated by $\mu(\phi)$.

Due to the finite intersection property, filters and ideals work well with logics: If ϕ holds normally, as it holds in a big subset, and so does ϕ' , then $\phi \wedge \phi'$ will normally hold, too, as the intersection of two big subsets is big again. This is a nice property, but not justified in all situations, consider e.g. simple counting of a finite subset. (The question has a name, “lottery paradox”: normally no single participant wins, but someone wins in the end.) This motivates the weak versions.

Normality defined by (weak or not) filters is a local concept: the filter defined on X and the one defined on X' might be totally independent.

Seen more abstractly, set properties like e.g. $(R \uparrow)$ allow the transfer of big (or small) subsets from one to another base set (and the conclusions drawn on this basis), and we call them “coherence properties”. They are very important, not only for working with a logic which respects them, but also for soundness and completeness

questions, often they are at the core of such problems.

karl-search= End Definition Filter2

6.1.7 Remark Ref-Class

karl-search= Start Remark Ref-Class

Remark 6.1

(+++ Orig. No.: Remark Ref-Class +++)

LABEL: Remark Ref-Class

$(R \uparrow)$ corresponds to $(I \downarrow)$ and $(F \uparrow)$: If A is small in $X \subseteq Y$, then it will a fortiori be small in the bigger Y .

$(R \downarrow)$ says that diminishing base sets by a small amount will keep small subsets small. This goes in the wrong direction, so we have to be careful. We cannot diminish arbitrarily, e.g., if A is a small subset of B , A should not be a small subset of $B - (B - A) = A$. It still seems quite safe, if “small” is a robust notion, i.e. defined in an abstract way, and not anew for each set, and, if “small” is sufficiently far from “big”, as, for example in a filter.

There is, however, an important conceptual distinction to make here. Filters express “size” in an abstract way, in the context of nonmonotonic logics, $\alpha \sim \beta$ iff the set of $\alpha \wedge \neg \beta$ is small in α . But here, we were interested in “small” changes in the reference set X (or α in our example). So we have two quite different uses of “size”, one for nonmonotonic logics, abstractly expressed by a filter, the other for coherence conditions. It is possible, but not necessary, to consider both essentially the same notions. But we should not forget that we have two conceptually different uses of size here.

$(R \downarrow\downarrow)$ is obviously a stronger variant of $(R \downarrow)$.

It and its strength is perhaps best understood as transitivity of the relation $xSy : \Leftrightarrow x \in \mathcal{M}^+(y)$.

Now, (in comparison to $(R \downarrow)$) A' can be a medium size subset of B . As a matter of fact, $(R \downarrow\downarrow)$ is a very big strengthening of $(R \downarrow)$: Consider a principal filter $\mathcal{F} := \{X \subseteq B : B' \subseteq X\}$, $b \in B'$. Then $\{b\}$ has at least medium size, so any small set $A \subseteq B$ is smaller than $\{b\}$ - and this is, of course, just rankedness. If we only have $(R \downarrow)$, then we need the whole generating set B' to see that A is small. This is the strong substitution property of rankedness: any b as above will show that A is small.

The more we see size as an abstract notion, and the more we see “small” different from “big” (or “medium”), the more we can go from one base set to another and find the same sizes - the more we have coherence when we reason with small and big subsets. $(R \downarrow)$ works with iterated use of “small”, just as do filters, but not weak filters. So it is not surprising that weak filters and $(R \downarrow)$ do not cooperate well: Let A, B, C be small subsets of X - pairwise disjoint, and $A \cup B \cup C = X$, this is possible. By $(R \downarrow)$ B and C will be small in $X - A$, so again by $(R \downarrow)$ C will be small in $(X - A) - B = C$, but this is absurd.

If we think that filters are too strong, but we still want some coherence, i.e. abstract size, we can consider $(R \cup disj)$: If A is a small subset of B , and A' of B' , and B and B' are disjoint, then $A \cup A'$ is a small subset of $B \cup B'$. It expresses a uniform approach to size, or distributivity, if you like. It holds, e.g. when we consider a set to be small iff it is smaller than a certain fraction. The important point is here that by disjointness, the big subsets do not get “used up”. (This property generalizes in a straightforward way to the infinite case.)

karl-search= End Remark Ref-Class

6.1.8 Fact R-down

karl-search= Start Fact R-down

Fact 6.2

(+++ Orig. No.: Fact R-down +++)

LABEL: Fact R-down

The two versions of $(R \downarrow)$ and the three versions of $(R \downarrow\downarrow)$ are each equivalent. For the third version of $(R \downarrow\downarrow)$ we use $(I \downarrow)$.

karl-search= End Fact R-down

6.1.9 Fact R-down Proof

karl-search= Start Fact R-down Proof

Proof

(+++*** Orig.: Proof)

For $A, B \subseteq X$, $(X - B) - ((X - A) - B) = A - B$.

“ \Rightarrow ”: Let $A \in \mathcal{F}(X)$, $B \in \mathcal{I}(X)$, so $X - A \in \mathcal{I}(X)$, so by prerequisite $(X - A) - B \in \mathcal{I}(X - B)$, so $A - B = (X - B) - ((X - A) - B) \in \mathcal{F}(X - B)$.

“ \Leftarrow ”: Let $A, B \in \mathcal{I}(X)$, so $X - A \in \mathcal{F}(X)$, so by prerequisite $(X - A) - B \in \mathcal{F}(X - B)$, so $A - B = (X - B) - ((X - A) - B) \in \mathcal{I}(X - B)$.

The proof for $(R \downarrow\downarrow)$ is the same for the first two cases.

It remains to show equivalence with the last one. We assume closure under set difference and union.

(1) \Rightarrow (3) :

Suppose $A \notin \mathcal{M}^+(Y)$, but $X \in \mathcal{M}^+(Y)$, we show $A \notin \mathcal{M}^+(X)$. So $A \in \mathcal{I}(Y)$, $Y - X \notin \mathcal{F}(Y)$, so $A = A - (Y - X) \in \mathcal{I}(Y - (Y - X)) = \mathcal{I}(X)$.

(3) \Rightarrow (1) :

Suppose $A - B \notin \mathcal{I}(X - B)$, $B \notin \mathcal{F}(X)$, we show $A \notin \mathcal{I}(X)$. By prerequisite $A - B \in \mathcal{M}^+(X - B)$, $X - B \in \mathcal{M}^+(X)$, so $A - B \in \mathcal{M}^+(X)$, so by $(I \downarrow)$ $A \in \mathcal{M}^+(X)$, so $A \notin \mathcal{I}(X)$.

□

karl-search= End Fact R-down Proof

6.1.10 Proposition Ref-Class-Mu

karl-search= Start Proposition Ref-Class-Mu

Proposition 6.3

(+++ Orig. No.: Proposition Ref-Class-Mu +++)

LABEL: Proposition Ref-Class-Mu

If $f(X)$ is the smallest A s.t. $A \in \mathcal{F}(X)$, then, given the property on the left, the one on the right follows.

Conversely, when we define $\mathcal{F}(X) := \{X' : f(X) \subseteq X' \subseteq X\}$, given the property on the right, the one on the left follows. For this direction, we assume that we can use the full powerset of some base set U - as is the case for the model sets of a finite language. This is perhaps not too bold, as we mainly want to stress here the intuitive connections, without putting too much weight on definability questions.

(1.1)	$(R \uparrow)$	\Rightarrow	(μwOR)
(1.2)		\Leftarrow	
(2.1)	$(R \uparrow) + (IU)$	\Rightarrow	(μOR)
(2.2)		\Leftarrow	
(3.1)	$(R \uparrow) + (IU)$	\Rightarrow	(μPR)
(3.2)		\Leftarrow	
(4.1)	$(R \cup disj)$	\Rightarrow	$(\mu disjOR)$
(4.2)		\Leftarrow	
(5.1)	$(R \downarrow)$	\Rightarrow	(μCM)
(5.2)		\Leftarrow	
(6.1)	$(R \downarrow\downarrow)$	\Rightarrow	$(\mu RatM)$
(6.2)		\Leftarrow	

karl-search= End Proposition Ref-Class-Mu

6.1.11 Proposition Ref-Class-Mu Proof

karl-search= Start Proposition Ref-Class-Mu Proof

Proof

(+++*** Orig.: Proof)

(1.1) $(R \uparrow) \Rightarrow (\mu wOR)$:

$X - f(X)$ is small in X , so it is small in $X \cup Y$ by $(R \uparrow)$, so $A := X \cup Y - (X - f(X)) \in \mathcal{F}(X \cup Y)$, but $A \subseteq f(X) \cup Y$, and $f(X \cup Y)$ is the smallest element of $\mathcal{F}(X \cup Y)$, so $f(X \cup Y) \subseteq A \subseteq f(X) \cup Y$.

(1.2) $(\mu wOR) \Rightarrow (R \uparrow)$:

Let $X \subseteq Y$, $X' := Y - X$. Let $A \in \mathcal{I}(X)$, so $X - A \in \mathcal{F}(X)$, so $f(X) \subseteq X - A$, so $f(X \cup X') \subseteq f(X) \cup X' \subseteq (X - A) \cup X'$ by prerequisite, so $(X \cup X') - ((X - A) \cup X') = A \in \mathcal{I}(X \cup X')$.

(2.1) $(R \uparrow) + (IU) \Rightarrow (\mu OR)$:

$X - f(X)$ is small in X , $Y - f(Y)$ is small in Y , so both are small in $X \cup Y$ by $(R \uparrow)$, so $A := (X - f(X)) \cup (Y - f(Y))$ is small in $X \cup Y$ by (IU) , but $X \cup Y - (f(X) \cup f(Y)) \subseteq A$, so $f(X) \cup f(Y) \in \mathcal{F}(X \cup Y)$, so, as $f(X \cup Y)$ is the smallest element of $\mathcal{F}(X \cup Y)$, $f(X \cup Y) \subseteq f(X) \cup f(Y)$.

(2.2) $(\mu OR) \Rightarrow (R \uparrow) + (IU)$:

Let again $X \subseteq Y$, $X' := Y - X$. Let $A \in \mathcal{I}(X)$, so $X - A \in \mathcal{F}(X)$, so $f(X) \subseteq X - A$. $f(X') \subseteq X'$, so $f(X \cup X') \subseteq f(X) \cup f(X') \subseteq (X - A) \cup X'$ by prerequisite, so $(X \cup X') - ((X - A) \cup X') = A \in \mathcal{I}(X \cup X')$.

(IU) holds by definition.

(3.1) $(R \uparrow) + (IU) \Rightarrow (\mu PR)$:

Let $X \subseteq Y$. $Y - f(Y)$ is the largest element of $\mathcal{I}(Y)$, $X - f(X) \in \mathcal{I}(X) \subseteq \mathcal{I}(Y)$ by $(R \uparrow)$, so $(X - f(X)) \cup (Y - f(Y)) \in \mathcal{I}(Y)$ by (IU) , so by "largest" $X - f(X) \subseteq Y - f(Y)$, so $f(Y) \cap X \subseteq f(X)$.

(3.2) $(\mu PR) \Rightarrow (R \uparrow) + (IU)$

Let again $X \subseteq Y$, $X' := Y - X$. Let $A \in \mathcal{I}(X)$, so $X - A \in \mathcal{F}(X)$, so $f(X) \subseteq X - A$, so by prerequisite

$f(Y) \cap X \subseteq X - A$, so $f(Y) \subseteq X' \cup (X - A)$, so $(X \cup X') - (X' \cup (X - A)) = A \in \mathcal{I}(Y)$.

Again, (IU) holds by definition.

(4.1) $(R \cup disj) \Rightarrow (\mu disj OR)$:

If $X \cap Y = \emptyset$, then (1) $A \in \mathcal{I}(X), B \in \mathcal{I}(Y) \Rightarrow A \cup B \in \mathcal{I}(X \cup Y)$ and (2) $A \in \mathcal{F}(X), B \in \mathcal{F}(Y) \Rightarrow A \cup B \in \mathcal{F}(X \cup Y)$ are equivalent. (By $X \cap Y = \emptyset, (X - A) \cup (Y - B) = (X \cup Y) - (A \cup B)$.) So $f(X) \in \mathcal{F}(X), f(Y) \in \mathcal{F}(Y) \Rightarrow$ (by prerequisite) $f(X) \cup f(Y) \in \mathcal{F}(X \cup Y)$. $f(X \cup Y)$ is the smallest element of $\mathcal{F}(X \cup Y)$, so $f(X \cup Y) \subseteq f(X) \cup f(Y)$.

(4.2) $(\mu disj OR) \Rightarrow (R \cup disj)$:

Let $X \subseteq Y, X' := Y - X$. Let $A \in \mathcal{I}(X), A' \in \mathcal{I}(X')$, so $X - A \in \mathcal{F}(X), X' - A' \in \mathcal{F}(X')$, so $f(X) \subseteq X - A, f(X') \subseteq X' - A'$, so $f(X \cup X') \subseteq f(X) \cup f(X') \subseteq (X - A) \cup (X' - A')$ by prerequisite, so $(X \cup X') - ((X - A) \cup (X' - A')) = A \cup A' \in \mathcal{I}(X \cup X')$.

(5.1) $(R \downarrow) \Rightarrow (\mu CM)$:

$f(X) \subseteq Y \subseteq X \Rightarrow X - Y \in \mathcal{I}(X), X - f(X) \in \mathcal{I}(X) \Rightarrow_{(R \downarrow)} A := (X - f(X)) - (X - Y) \in \mathcal{I}(Y) \Rightarrow Y - A = f(X) - (X - Y) \in \mathcal{F}(Y) \Rightarrow f(Y) \subseteq f(X) - (X - Y) \subseteq f(X)$.

(5.2) $(\mu CM) \Rightarrow (R \downarrow)$

Let $A \in \mathcal{F}(X), B \in \mathcal{I}(X)$, so $f(X) \subseteq X - B \subseteq X$, so by prerequisite $f(X - B) \subseteq f(X)$. As $A \in \mathcal{F}(X), f(X) \subseteq A$, so $f(X - B) \subseteq f(X) \subseteq A \cap (X - B) = A - B$, and $A - B \in \mathcal{F}(X - B)$.

(6.1) $(R \downarrow \downarrow) \Rightarrow (\mu RatM)$:

Let $X \subseteq Y, X \cap f(Y) \neq \emptyset$. If $Y - X \in \mathcal{F}(Y)$, then $A := (Y - X) \cap f(Y) \in \mathcal{F}(Y)$, but by $X \cap f(Y) \neq \emptyset, A \subset f(Y)$, contradicting "smallest" of $f(Y)$. So $Y - X \notin \mathcal{F}(Y)$, and by $(R \downarrow \downarrow) X - f(Y) = (Y - f(Y)) - (Y - X) \in \mathcal{I}(X)$, so $X \cap f(Y) \in \mathcal{F}(X)$, so $f(X) \subseteq f(Y) \cap X$.

(6.2) $(\mu RatM) \Rightarrow (R \downarrow \downarrow)$

Let $A \in \mathcal{F}(Y), B \notin \mathcal{F}(Y)$. $B \notin \mathcal{F}(Y) \Rightarrow Y - B \notin \mathcal{I}(Y) \Rightarrow (Y - B) \cap f(Y) \neq \emptyset$. Set $X := Y - B$, so $X \cap f(Y) \neq \emptyset, X \subseteq Y$, so $f(X) \subseteq f(Y) \cap X$ by prerequisite. $f(Y) \subseteq A \Rightarrow f(X) \subseteq f(Y) \cap X = f(Y) - B \subseteq A - B$.

□

karl-search= End Proposition Ref-Class-Mu Proof

6.1.12 Definition Nabla

karl-search= Start Definition Nabla

Definition 6.3

(+++ Orig. No.: Definition Nabla +++)

LABEL: Definition Nabla

Augment the language of first order logic by the new quantifier: If ϕ and ψ are formulas, then so are $\nabla x \phi(x), \nabla x \phi(x) : \psi(x)$, for any variable x . The:-versions are the restricted variants. We call any formula of \mathcal{L} , possibly containing ∇ a $\nabla - \mathcal{L}$ -formula.

karl-search= End Definition Nabla

6.1.13 Definition N-Model

karl-search= Start Definition N-Model

Definition 6.4

(+++ Orig. No.: Definition N-Model +++)

LABEL: Definition N-Model

(\mathcal{N} -Model)

Let \mathcal{L} be a first order language, and M be a \mathcal{L} -structure. Let $\mathcal{N}(M)$ be a weak filter, or \mathcal{N} -system - \mathcal{N} for normal - over M . Define $\langle M, \mathcal{N}(M) \rangle \models \phi$ for any ∇ - \mathcal{L} -formula inductively as usual, with one additional induction step:

$\langle M, \mathcal{N}(M) \rangle \models \nabla x\phi(x)$ iff there is $A \in \mathcal{N}(M)$ s.t. $\forall a \in A (\langle M, \mathcal{N}(M) \rangle \models \phi[a])$.

karl-search= End Definition N-Model

6.1.14 Definition NablaAxioms

karl-search= Start Definition NablaAxioms

Definition 6.5

(+++ Orig. No.: Definition NablaAxioms +++)

LABEL: Definition NablaAxioms

Let any axiomatization of predicate calculus be given. Augment this with the axiom schemata

(1) $\nabla x\phi(x) \wedge \forall x(\phi(x) \rightarrow \psi(x)) \rightarrow \nabla x\psi(x)$,

(2) $\nabla x\phi(x) \rightarrow \neg\nabla x\neg\phi(x)$,

(3) $\forall x\phi(x) \rightarrow \nabla x\phi(x)$ and $\nabla x\phi(x) \rightarrow \exists x\phi(x)$,

(4) $\nabla x\phi(x) \leftrightarrow \nabla y\phi(y)$ if x does not occur free in $\phi(y)$ and y does not occur free in $\phi(x)$.

(for all ϕ, ψ).

karl-search= End Definition NablaAxioms

6.1.15 Proposition NablaRepr

karl-search= Start Proposition NablaRepr

Proposition 6.4

(+++ Orig. No.: Proposition NablaRepr +++)

LABEL: Proposition NablaRepr

The axioms given in Definition 6.5 (page 109) are sound and complete for the semantics of Definition 6.4 (page 109)

See [Sch95-1] or [Sch04].

karl-search= End Proposition NablaRepr

6.1.15.1 Extension to normal defaults with prerequisites

(+++*** Orig.: Extension to normal defaults with prerequisites)

LABEL: Section Extension to normal defaults with prerequisites

6.1.16 Definition Nabla-System

karl-search= Start Definition Nabla-System

Definition 6.6

(+++ Orig. No.: Definition Nabla-System +++)

LABEL: Definition Nabla-System

Call $\mathcal{N}^+(M) = \langle \mathcal{N}(N) : N \subseteq M \rangle$ a \mathcal{N}^+ -system or system of weak filters over M iff for each $N \subseteq M$ $\mathcal{N}(N)$ is a weak filter or \mathcal{N} -system over N . (It suffices to consider the definable subsets of M .)

karl-search= End Definition Nabla-System

6.1.17 Definition N-Model-System

karl-search= Start Definition N-Model-System

Definition 6.7

(+++ Orig. No.: Definition N-Model-System +++)

LABEL: Definition N-Model-System

Let \mathcal{L} be a first order language, and M a \mathcal{L} -structure. Let $\mathcal{N}^+(M)$ be a \mathcal{N}^+ -system over M .

Define $\langle M, \mathcal{N}^+(M) \rangle \models \phi$ for any formula inductively as usual, with the additional induction steps:

1. $\langle M, \mathcal{N}^+(M) \rangle \models \nabla x \phi(x)$ iff there is $A \in \mathcal{N}(M)$ s.t. $\forall a \in A (\langle M, \mathcal{N}^+(M) \rangle \models \phi[a])$,
2. $\langle M, \mathcal{N}^+(M) \rangle \models \nabla x \phi(x) : \psi(x)$ iff there is $A \in \mathcal{N}(\{x : \langle M, \mathcal{N}^+(M) \rangle \models \phi(x)\})$ s.t. $\forall a \in A (\langle M, \mathcal{N}^+(M) \rangle \models \psi[a])$.

karl-search= End Definition N-Model-System

6.1.18 Definition NablaAxioms-System

karl-search= Start Definition NablaAxioms-System

Definition 6.8

(+++ Orig. No.: Definition NablaAxioms-System +++)

LABEL: Definition NablaAxioms-System

Extend the logic of first order predicate calculus by adding the axiom schemata

- (1) a. $\nabla x\phi(x) \leftrightarrow \nabla x(x = x) : \phi(x)$, b. $\forall x(\sigma(x) \leftrightarrow \tau(x)) \wedge \nabla x\sigma(x) : \phi(x) \rightarrow \nabla x\tau(x) : \phi(x)$,
- (2) $\nabla x\phi(x) : \psi(x) \wedge \forall x(\phi(x) \wedge \psi(x) \rightarrow \vartheta(x)) \rightarrow \nabla x\phi(x) : \vartheta(x)$,
- (3) $\exists x\phi(x) \wedge \nabla x\phi(x) : \psi(x) \rightarrow \neg\nabla x\phi(x) : \neg\psi(x)$,
- (4) $\forall x(\phi(x) \rightarrow \psi(x)) \rightarrow \nabla x\phi(x) : \psi(x)$ and $\nabla x\phi(x) : \psi(x) \rightarrow [\exists x\phi(x) \rightarrow \exists x(\phi(x) \wedge \psi(x))]$,
- (5) $\nabla x\phi(x) : \psi(x) \leftrightarrow \nabla y\phi(y) : \psi(y)$ (under the usual caveat for substitution).

(for all $\phi, \psi, \vartheta, \sigma, \tau$).

karl-search= End Definition NablaAxioms-System

6.1.19 Proposition NablaRepr-System

karl-search= Start Proposition NablaRepr-System

Proposition 6.5

(+++ Orig. No.: Proposition NablaRepr-System +++)

LABEL: Proposition NablaRepr-System

The axioms of Definition 6.8 (page 111) are sound and complete for the \mathcal{N}^+ – semantics of ∇ as defined in Definition 6.7 (page 110) .

See [Sch95-1] or [Sch04].

karl-search= End Proposition NablaRepr-System

6.1.20 Size-Bib

karl-search= Start Size-Bib

More on different abstract coherent systems based on size,

- the system of *S. Ben-David* and *R. Ben-Eliyahu* (see [BB94]),
- the system of the author,
- the system of *N. Friedman* and *J. Halpern* (see [FH98]).

can be found in [Sch04].

karl-search= End Size-Bib

karl-search= End ToolBase1-Size

7 IBRS

7.1

7.1.1 ToolBase1-IBRS

karl-search= Start ToolBase1-IBRS

LABEL: Section Toolbase1-IBRS

7.1.2 Motivation IBRS

karl-search= Start Motivation IBRS

The human agent in his daily activity has to deal with many situations involving change. Chief among them are the following

- (1) Common sense reasoning from available data. This involves predication of what unavailable data is supposed to be (nonmonotonic deduction) but it is a defeasible prediction, geared towards immediate change. This is formally known as nonmonotonic reasoning and is studied by the nonmonotonic community.
- (2) Belief revision, studied by a very large community. The agent is unhappy with the totality of his beliefs which he finds internally unacceptable (usually logically inconsistent but not necessarily so) and needs to change/revise it.
- (3) Receiving and updating his data, studied by the update community.
- (4) Making morally correct decisions, studied by the deontic logic community.
- (5) Dealing with hypothetical and counterfactual situations. This is studied by a large community of philosophers and AI researchers.
- (6) Considering temporal future possibilities, this is covered by modal and temporal logic.
- (7) Dealing with properties that persist through time in the near future and with reasoning that is constructive. This is covered by intuitionistic logic.

All the above types of reasoning exist in the human mind and are used continuously and coherently every hour of the day. The formal modelling of these types is done by diverse communities which are largely distinct with no significant communication or cooperation. The formal models they use are very similar and arise from a more general theory, what we might call:

“Reasoning with information bearing binary relations”.

karl-search= End Motivation IBRS

7.1.3 Definition IBRS

karl-search= Start Definition IBRS

Definition 7.1

(+++ Orig. No.: Definition IBRS +++)

LABEL: Definition IBRS

(1) An information bearing binary relation frame IBR, has the form (S, \mathfrak{R}) , where S is a non-empty set and \mathfrak{R} is a subset of S , where S is defined by induction as follows:

- (1.1) $S_0 = S$
- (1.2) $S_{n+1} = S_n \cup (S_n \times S_n)$.
- (1.3) $S = \bigcup \{S_n : n \in \omega\}$

We call elements from S points or nodes, and elements from \mathfrak{R} arrows. Given (S, \mathfrak{R}) , we also set $\mathbf{P}((S, \mathfrak{R})) := S$, and $\mathbf{A}((S, \mathfrak{R})) := \mathfrak{R}$.

If α is an arrow, the origin and destination of α are defined as usual, and we write $\alpha : x \rightarrow y$ when x is the origin, and y the destination of the arrow α . We also write $o(\alpha)$ and $d(\alpha)$ for the origin and destination of α .

- (2) Let Q be a set of atoms, and \mathbf{L} be a set of labels (usually $\{0, 1\}$ or $[0, 1]$). An information assignment h on (S, \mathfrak{R}) is a function $h : Q \times \mathfrak{R} \rightarrow \mathbf{L}$.
- (3) An information bearing system IBRS, has the form $(S, \mathfrak{R}, h, Q, \mathbf{L})$, where $S, \mathfrak{R}, h, Q, \mathbf{L}$ are as above.

See Diagram 18.15 (page 177) for an illustration.

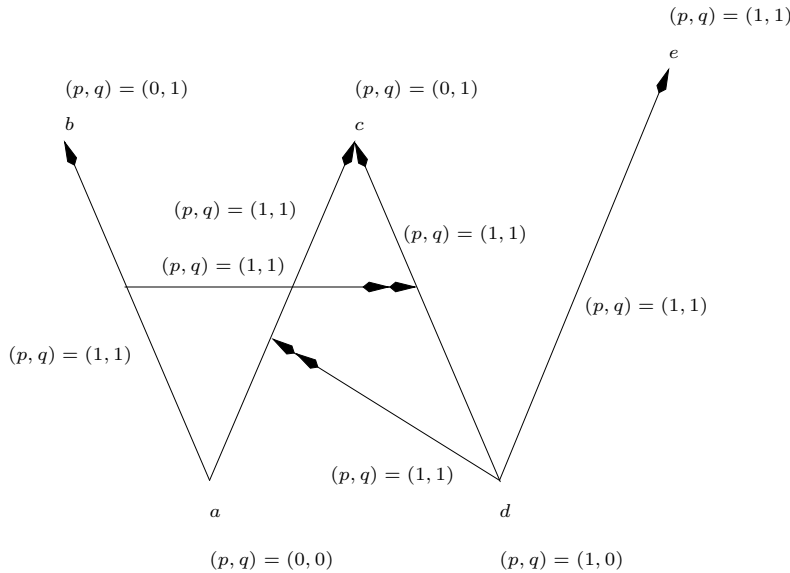

A simple example of an information bearing system.

Diagram 7.1

LABEL: Diagram IBRS-a

We have here:

$$\begin{aligned}
S &= \{a, b, c, d, e\}. \\
\mathfrak{R} &= S \cup \{(a, b), (a, c), (d, c), (d, e)\} \cup \{((a, b), (d, c)), (d, (a, c))\}. \\
Q &= \{p, q\}
\end{aligned}$$

The values of h for p and q are as indicated in the figure. For example $h(p, (d, (a, c))) = 1$.

karl-search= End Definition IBRS

7.1.4 Comment IBRS

karl-search= Start Comment IBRS

Comment 7.1

(+++ Orig. No.: Comment +++)

LABEL: Comment

LABEL: Comment IBRS

The elements in Figure Diagram 18.15 (page 177) can be interpreted in many ways, depending on the area of application.

- (1) The points in S can be interpreted as possible worlds, or as nodes in an argumentation network or nodes in a neural net or states, etc.
- (2) The direct arrows from nodes to nodes can be interpreted as accessibility relation, attack or support arrows in an argumentation networks, connection in a neural nets, a preferential ordering in a nonmonotonic model, etc.
- (3) The labels on the nodes and arrows can be interpreted as fuzzy values in the accessibility relation or weights in the neural net or strength of arguments and their attack in argumentation nets, or distances in a counterfactual model, etc.
- (4) The double arrows can be interpreted as feedback loops to nodes or to connections, or as reactive links changing the system which are activated as we pass between the nodes.

karl-search= End Comment IBRS

7.2 IBRS as abstraction

7.2.1 IBRS as abstraction

karl-search= Start IBRS as abstraction

LABEL: IBRS as abstraction

Thus, IBRS can be used as a source of information for various logics based on the atoms in Q . We now illustrate by listing several such logics.

Modal Logic

One can consider the figure as giving rise to two modal logic models. One with actual world a and one with d , these being the two minimal points of the relation. Consider a language with $\Box q$. how do we evaluate $a \models \Box q$? The modal logic will have to give an algorithm for calculating the values.

Say we choose algorithm \mathcal{A}_1 for $a \models \Box q$, namely:

[$\mathcal{A}_1(a, \Box q) = 1$] iff for all $x \in S$ such that $a = x$ or $(a, x) \in \mathfrak{R}$ we have $h(q, x) = 1$.

According to \mathcal{A}_1 we get that $\Box q$ is false at a . \mathcal{A}_1 gives rise to a T -modal logic. Note that the reflexivity is not anchored at the relation \mathfrak{R} of the network but in the algorithm \mathcal{A}_1 in the way we evaluate. We say $(S, \mathfrak{R}, \dots) \models \Box q$ iff $\Box q$ holds in all minimal points of (S, \mathfrak{R}) .

For orderings without minimal points we may choose a subset of distinguished points.

Nonmonotonic Deduction

We can ask whether $p \sim q$ according to algorithm \mathcal{A}_2 defined below. \mathcal{A}_2 says that $p \sim q$ holds iff q holds in all minimal models of p . Let us check the value of \mathcal{A}_2 in this case:

Let $S_p = \{s \in S \mid h(p, s) = 1\}$. Thus $S_p = \{d, e\}$.

The minimal points of S_p are $\{d\}$. Since $h(q, d) = 0$, we have that $p \not\sim q$.

Note that in the cases of modal logic and nonmonotonic logic we ignored the arrows $(d, (a, c))$ (i.e. the double arrow from d to the arc (a, c)) and the h values to arcs. These values do not play a part in the traditional modal or nonmonotonic logic. They do play a part in other logics. The attentive reader may already suspect that we have her an opportunity for generalisation of say nonmonotonic logic, by giving a role to arc annotations.

Argumentation Nets

Here the nodes of S are interpreted as arguments. The atoms $\{p, q\}$ can be interpreted as types of arguments and the arrows e.g. $(a, b) \in \mathfrak{R}$ as indicating that the argument a is attacking the argument b .

So, for example, let

a = we must win votes.

b = death sentence for murderers.

c = We must allow abortion for teenagers

d = Bible forbids taking of life.

q = the argument is a social argument

p = the argument is a religious argument.

$(d, (a, c))$ = there should be no connection between winning votes and abortion.

$((a, b), (d, c))$ = If we attack the death sentence in order to win votes then we must stress (attack) that there should be no connection between religion (Bible) and social issues.

Thus we have according to this model that supporting abortion can lose votes. The argument for abortion is a social one and the argument from the Bible against it is a religious one.

We can extract information from this IBRS using two algorithms. The modal logic one can check whether for example every social argument is attacked by a religious argument. The answer is no, since the social argument b is attacked only by a which is not a religious argument.

We can also use algorithm \mathcal{A}_3 (following Dung) to extract the winning arguments of this system. The arguments a and d are winning since they are not attacked. d attacks the connection between a and c (i.e. stops a attacking c).

The attack of a on b is successful and so b is out. However the arc (a, b) attacks the arc (d, c) . So c is not attacked at all as both arcs leading into it are successfully eliminated. So c is in. e is out because it is attacked by d .

So the winning arguments are $\{a, c, d\}$

In this model we ignore the annotations on arcs. To be consistent in our mathematics we need to say that h is a partial function on \mathfrak{R} . The best way is to give more specific definition on IBRS to make it suitable for each logic.

See also [Gab08b] and [BGW05].

Counterfactuals

The traditional semantics for counterfactuals involves closeness of worlds. The clauses $y \models p \leftrightarrow q$, where \leftrightarrow is a counterfactual implication is that q holds in all worlds y' “near enough” to y in which p holds. So if we interpret the annotation on arcs as distances then we can define “near” as distance ≤ 2 , we get: $a \models p \leftrightarrow q$ iff in all worlds of p -distance ≤ 2 if p holds so does q . Note that the distance depends on p .

In this case we get that $a \models p \leftrightarrow q$ holds. The distance function can also use the arrows from arcs to arcs, etc. There are many opportunities for generalisation in our IBRS set up.

Intuitionistic Persistence

We can get an intuitionistic Kripke model out of this IBRS by letting, for $t, s \in S, t\rho_0s$ iff $t = s$ or $[tRs \wedge \forall q \in Q(h(q, t) \leq h(q, s))]$. We get that

[$r_0 = \{(y, y) \mid y \in S\} \cup \{(a, b), (a, c), (d, e)\}$.]

Let ρ be the transitive closure of ρ_0 . Algorithm \mathcal{A}_4 evaluates $p \Rightarrow q$ in this model, where \Rightarrow is intuitionistic implication.

$\mathcal{A}_4 : p \Rightarrow q$ holds at the IBRS iff $p \Rightarrow q$ holds intuitionistically at every ρ -minimal point of $of(S, \rho)$.

karl-search= End IBRS as abstraction

7.2.2 Reac-Sem

karl-search= Start Reac-Sem

LABEL: Section Reac-Sem

7.3 Introduction

7.3.1 Reac-Sem-Intro

karl-search= Start Reac-Sem-Intro

LABEL: Section Reac-Sem-Intro

(1) Nodes and arrows

As we may have counterarguments not only against nodes, but also against arrows, they must be treated basically the same way, i.e. in some way there has to be a positive, but also a negative influence on both. So arrows cannot just be concatenation between the contents of nodes, or so.

We will differentiate between nodes and arrows by labelling arrows in addition with a time delay. We see nodes as situations, where the output is computed instantaneously from the input, whereas arrows describe some “force” or “mechanism” which may need some time to “compute” the result from the input.

Consequently, if α is an arrow, and β an arrow pointing to α , then it should point to the input of α , i.e. before the time lapse. Conversely, any arrow originating in α should originate after the time lapse.

Apart this distinction, we will treat nodes and arrows the same way, so the following discussion will apply to both - which we call just “objects”.

(2) Defeasibility

The general idea is to code each object, say X , by $I(X) : U(X) \rightarrow C(X)$: If $I(X)$ holds then, unless $U(X)$ holds, consequence $C(X)$ will hold. (We adopted Reiter’s notation for defaults, as IBRS have common points with the former.)

The situation is slightly more complicated, as there can be several counterarguments, so $U(X)$ really is an “or”. Likewise, there can be several supporting arguments, so $I(X)$ also is an “or”.

A counterargument must not always be an argument against a specific supporting argument, but it can be. Thus, we should admit both possibilities. As we can use arrows to arrows, the second case is easy to treat (as is the dual, a supporting argument can be against a specific counterargument). How do we treat the case of unspecific pro- and counterarguments? Probably the easiest way is to adopt Dung’s idea: an object is in, if it has at least one support, and no counterargument - see [Dun95]. Of course, other possibilities may be adopted, counting, use of labels, etc., but we just consider the simple case here.

(3) Labels

In the general case, objects stand for some kind of defeasible transmission. We may in some cases see labels as restricting this transmission to certain values. For instance, if the label is $p = 1$ and $q = 0$, then the p -part may be transmitted and the q -part not.

Thus, a transmission with a label can sometimes be considered as a family of transmissions, which ones are active is indicated by the label.

Example 7.1

(+++ Orig. No.: Example 2.1 +++)

LABEL: Example 2.1

In fuzzy Kripke models, labels are elements of $[0, 1]$. $p = 0.5$ as label for a node m' which stands for a fuzzy model means that the value of p is 0.5. $p = 0.5$ as label for an arrow from m to m' means that p is transmitted with value 0.5. Thus, when we look from m to m' , we see p with value $0.5 * 0.5 = 0.25$. So, we have $\diamond p$ with value 0.25 at m - if, e.g., m, m' are the only models.

(4) Putting things together

If an arrow leaves an object, the object’s output will be connected to the (only) positive input of the arrow. (An arrow has no negative inputs from objects it leaves.) If a positive arrow enters an object, it is connected to one of the positive inputs of the object, analogously for negative arrows and inputs.

When labels are present, they are transmitted through some operation.

karl-search= End Reac-Sem-Intro

7.4 Formal definition

7.4.1 Reac-Sem-Def

karl-search= Start Reac-Sem-Def

LABEL: Section Reac-Sem-Def

Definition 7.2

(+++ Orig. No.: Definition 2.1 +++)

LABEL: Definition 2.1

In the most general case, objects of IBRS have the form: $(\langle I_1, L_1 \rangle, \dots, \langle I_n, L_n \rangle) : (\langle U_1, L'_1 \rangle, \dots, \langle U_n, L'_n \rangle)$, where the L_i, L'_i are labels and the I_i, U_i might be just truth values, but can also be more complicated, a (possibly infinite) sequence of some values. Connected objects have, of course, to have corresponding such sequences. In addition, the object X has a criterion for each input, whether it is valid or not (in the simple case, this will just be the truth value "true"). If there is at least one positive valid input I_i , and no valid negative input U_i , then the output $C(X)$ and its label are calculated on the basis of the valid inputs and their labels. If the object is an arrow, this will take some time, t , otherwise, this is instantaneous.

Evaluating a diagram

An evaluation is relative to a fixed input, i.e. some objects will be given certain values, and the diagram is left to calculate the others. It may well be that it oscillates, i.e. shows a cyclic behaviour. This may be true for a subset of the diagram, or the whole diagram. If it is restricted to an unimportant part, we might neglect this. Whether it oscillates or not can also depend on the time delays of the arrows (see Example 7.2 (page 118)).

We therefore define for a diagram Δ

$\alpha \sim_{\Delta} \beta$ iff

- (a) α is a (perhaps partial) input - where the other values are set "not valid"
- (b) β is a (perhaps partial) output
- (c) after some time, β is stable, i.e. all still possible oscillations do not affect β
- (d) the other possible input values do not matter, i.e. whatever the input, the result is the same.

In the cases examined here more closely, all input values will be defined.

karl-search= End Reac-Sem-Def

7.5 A circuit semantics for simple IBRS without labels

7.5.1 Reac-Sem-Circuit

karl-search= Start Reac-Sem-Circuit

LABEL: Section Reac-Sem-Circuit

It is standard to implement the usual logical connectives by electronic circuits. These components are called gates. Circuits with feedback sometimes show undesirable behaviour when the initial conditions are not specified. (When we switch a circuit on, the outputs of the individual gates can have arbitrary values.) The technical realization of these initial values shows the way to treat defaults. The initial values are set via resistors (in the order of 1 kΩ) between the point in the circuit we want to initialize and the desired tension (say 0 Volt for false, 5 Volt for true). They are called pull-down or pull-up resistors (for default 0 or 5 Volt). When a "real" result comes in, it will override the tension applied via the resistor.

Closer inspection reveals that we have here a 3 level default situation: The initial value will be the weakest, which can be overridden by any "real" signal, but a positive argument can be overridden by a negative one. Thus, the biggest resistor will be for the initialization, the smaller one for the supporting arguments, and the negative arguments have full power.

Technical details will be left to the experts.

We give now an example which shows that the delays of the arrows can matter. In one situation, a stable state is reached, in another, the circuit begins to oscillate.

Example 7.2

(+++ Orig. No.: Example 2.2 +++)

LABEL: Example 2.2

(In engineering terms, this is a variant of a JK flip-flop with $R * S = 0$, a circuit with feedback.)

We have 8 measuring points.

$In1, In2$ are the overall input, $Out1, Out2$ the overall output, $A1, A2, A3, A4$ are auxiliary internal points. All points can be true or false.

The logical structure is as follows:

$$A1 = In1 \wedge Out1, A2 = In2 \wedge Out2,$$

$$A3 = A1 \vee Out2, A4 = A2 \vee Out1,$$

$$Out1 = \neg A3, Out2 = \neg A4.$$

Thus, the circuit is symmetrical, with $In1$ corresponding to $In2$, $A1$ to $A2$, $A3$ to $A4$, $Out1$ to $Out2$.

The input is held constant. See Diagram 18.22 (page 184) .

Diagram 7.2 LABEL: *Diagram Gate-Sem*

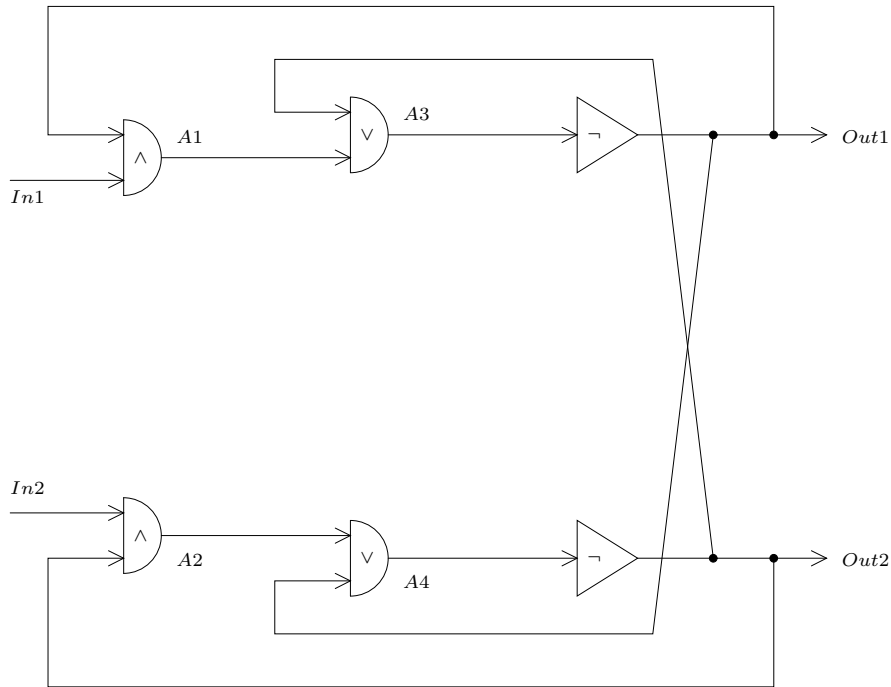

Gate Semantics

We suppose that the output of the individual gates is present n time slices after the input was present. n will in the first circuit be equal to 1 for all gates, in the second circuit equal to 1 for all but the AND gates, which will take 2 time slices. Thus, in both cases, e.g. $Out1$ at time t will be the negation of $A3$ at time $t - 1$. In the first case, $A1$ at time t will be the conjunction of $In1$ and $Out1$ at time $t - 1$, and in the second case the conjunction of $In1$ and $Out1$ at time $t - 2$.

We initialize $In1$ as true, all others as false. (The initial value of $A3$ and $A4$ does not matter, the behaviour is essentially the same for all such values.)

The first circuit will oscillate with a period of 4, the second circuit will go to a stable state.

We have the following transition tables (time slice shown at left):

Circuit 1, $delay = 1$ everywhere:

	In1	In2	A1	A2	A3	A4	Out1	Out2	
1:	T	F	F	F	F	F	F	F	
2:	T	F	F	F	F	F	T	T	
3:	T	F	T	F	T	T	T	T	
4:	T	F	T	F	T	T	F	F	
5:	T	F	F	F	T	F	F	F	oscillation starts
6:	T	F	F	F	F	F	F	T	
7:	T	F	F	F	T	F	T	T	
8:	T	F	T	F	T	T	F	T	
9:	T	F	F	F	T	F	F	F	back to start of oscillation

Circuit 2, *delay* = 1 everywhere, except for AND with *delay* = 2 :

(Thus, A1 and A2 are held at their initial value up to time 2, then they are calculated using the values of time $t - 2$.)

	In1	In2	A1	A2	A3	A4	Out1	Out2	
1:	T	F	F	F	F	F	F	F	
2:	T	F	F	F	F	F	T	T	
3:	T	F	F	F	T	T	T	T	
4:	T	F	T	F	T	T	F	F	
5:	T	F	T	F	T	F	F	F	
6:	T	F	F	F	T	F	F	T	stable state reached
7:	T	F	F	F	T	F	F	T	

Note that state 6 of circuit 2 is also stable in circuit 1, but it is never reached in that circuit.

karl-search= End Reac-Sem-Circuit

karl-search= End Reac-Sem

karl-search= End ToolBase1-IBRS

8 Generalized preferential structures

8.1

8.1.1 ToolBase1-HigherPref

karl-search= Start ToolBase1-HigherPref

LABEL: Section Toolbase1-HigherPref

8.1.2 Comment Gen-Pref

karl-search= Start Comment Gen-Pref

Comment 8.1

(+++ Orig. No.: Comment Gen-Pref +++)

LABEL: Comment Gen-Pref

A counterargument to α is NOT an argument for $\neg\alpha$ (this is asking for too much), but just showing one case where $\neg\alpha$ holds. In preferential structures, an argument for α is a set of level 1 arrows, eliminating $\neg\alpha$ -models. A counterargument is one level 2 arrow, attacking one such level 1 arrow.

Of course, when we have copies, we may need many successful attacks, on all copies, to achieve the goal. As we may have copies of level 1 arrows, we may need many level 2 arrows to destroy them all.

karl-search= End Comment Gen-Pref

8.1.3 Definition Generalized preferential structure

karl-search= Start Definition Generalized preferential structure

Definition 8.1

(+++ Orig. No.: Definition Generalized preferential structure +++)

LABEL: Definition Generalized preferential structure

An IBR is called a generalized preferential structure iff the origins of all arrows are points. We will usually write x, y etc. for points, α, β etc. for arrows.

karl-search= End Definition Generalized preferential structure

8.1.4 Definition Level-n-Arrow

karl-search= Start Definition Level-n-Arrow

Definition 8.2

(+++ Orig. No.: Definition Level-n-Arrow +++)

LABEL: Definition Level-n-Arrow

Consider a generalized preferential structure \mathcal{X} .

(1) Level n arrow:

Definition by upward induction.

If $\alpha : x \rightarrow y$, x, y are points, then α is a level 1 arrow.

If $\alpha : x \rightarrow \beta$, x is a point, β a level n arrow, then α is a level $n + 1$ arrow. ($o(\alpha)$ is the origin, $d(\alpha)$ is the destination of α .)

$\lambda(\alpha)$ will denote the level of α .

(2) Level n structure:

\mathcal{X} is a level n structure iff all arrows in \mathcal{X} are at most level n arrows.

We consider here only structures of some arbitrary but finite level n .

(3) We define for an arrow α by induction $O(\alpha)$ and $D(\alpha)$.

If $\lambda(\alpha) = 1$, then $O(\alpha) := \{o(\alpha)\}$, $D(\alpha) := \{d(\alpha)\}$.

If $\alpha : x \rightarrow \beta$, then $D(\alpha) := D(\beta)$, and $O(\alpha) := \{x\} \cup O(\beta)$.

Thus, for example, if $\alpha : x \rightarrow y$, $\beta : z \rightarrow \alpha$, then $O(\beta) := \{x, z\}$, $D(\beta) = \{y\}$.

karl-search= End Definition Level-n-Arrow

8.1.5 Example Inf-Level

karl-search= Start Example Inf-Level

We will not consider here diagrams with arbitrarily high levels. One reason is that diagrams like the following will have an unclear meaning:

Example 8.1

(+++ Orig. No.: Example Inf-Level +++)

LABEL: Example Inf-Level

$\langle \alpha, 1 \rangle : x \rightarrow y$,

$\langle \alpha, n + 1 \rangle : x \rightarrow \langle \alpha, n \rangle$ ($n \in \omega$).

Is $y \in \mu(X)$?

karl-search= End Example Inf-Level

8.1.6 Definition Valid-Arrow

karl-search= Start Definition Valid-Arrow

Definition 8.3

(+++ Orig. No.: Definition Valid-Arrow +++)

LABEL: Definition Valid-Arrow

Let \mathcal{X} be a generalized preferential structure of (finite) level n .

We define (by downward induction):

(1) Valid $X - to - Y$ arrow:

Let $X, Y \subseteq \mathbf{P}(\mathcal{X})$.

$\alpha \in \mathbf{A}(\mathcal{X})$ is a valid $X - to - Y$ arrow iff

(1.1) $O(\alpha) \subseteq X, D(\alpha) \subseteq Y$,

(1.2) $\forall \beta : x' \rightarrow \alpha. (x' \in X \Rightarrow \exists \gamma : x'' \rightarrow \beta. (\gamma \text{ is a valid } X - to - Y \text{ arrow}))$.

We will also say that α is a valid arrow in X , or just valid in X , iff α is a valid $X - to - X$ arrow.

(2) Valid $X \Rightarrow Y$ arrow:

Let $X \subseteq Y \subseteq \mathbf{P}(\mathcal{X})$.

$\alpha \in \mathbf{A}(\mathcal{X})$ is a valid $X \Rightarrow Y$ arrow iff

(2.1) $o(\alpha) \in X, O(\alpha) \subseteq Y, D(\alpha) \subseteq Y$,

(2.2) $\forall \beta : x' \rightarrow \alpha. (x' \in Y \Rightarrow \exists \gamma : x'' \rightarrow \beta. (\gamma \text{ is a valid } X \Rightarrow Y \text{ arrow}))$.

(Note that in particular $o(\gamma) \in X$, and that $o(\beta)$ need not be in X , but can be in the bigger Y .)

karl-search= End Definition Valid-Arrow

8.1.7 Fact Higher-Validity

karl-search= Start Fact Higher-Validity

Fact 8.1

(+++ Orig. No.: Fact Higher-Validity +++)

LABEL: Fact Higher-Validity

(1) If α is a valid $X \Rightarrow Y$ arrow, then α is a valid $Y - to - Y$ arrow.

(2) If $X \subseteq X' \subseteq Y' \subseteq Y \subseteq \mathbf{P}(\mathcal{X})$ and $\alpha \in \mathbf{A}(\mathcal{X})$ is a valid $X \Rightarrow Y$ arrow, and $O(\alpha) \subseteq Y', D(\alpha) \subseteq Y'$, then α is a valid $X' \Rightarrow Y'$ arrow.

karl-search= End Fact Higher-Validity

8.1.8 Fact Higher-Validity Proof

karl-search= Start Fact Higher-Validity Proof

8.1.8.1 Proof Fact Higher-Validity

(+++*** Orig.: Proof Fact Higher-Validity)

LABEL: Section Proof Fact Higher-Validity

Let α be a valid $X \Rightarrow Y$ arrow. We show (1) and (2) together by downward induction (both are trivial).

By prerequisite $o(\alpha) \in X \subseteq X', O(\alpha) \subseteq Y' \subseteq Y, D(\alpha) \subseteq Y' \subseteq Y$.

Case 1: $\lambda(\alpha) = n$. So α is a valid $X' \Rightarrow Y'$ arrow, and a valid $Y - to - Y$ arrow.

Case 2: $\lambda(\alpha) = n - 1$. So there is no $\beta : x' \rightarrow \alpha, y \in Y$, so α is a valid $Y - to - Y$ arrow. By $Y' \subseteq Y$ α is a valid $X' \Rightarrow Y'$ arrow.

Case 3: Let the result be shown down to $m, n > m > 1$, let $\lambda(\alpha) = m - 1$. So $\forall \beta : x' \rightarrow \alpha(x' \in Y \Rightarrow \exists \gamma : x'' \rightarrow \beta(x'' \in X \text{ and } \gamma \text{ is a valid } X \Rightarrow Y \text{ arrow}))$. By induction hypothesis γ is a valid $Y - to - Y$ arrow, and a valid $X' \Rightarrow Y'$ arrow. So α is a valid $Y - to - Y$ arrow, and by $Y' \subseteq Y$, α is a valid $X' \Rightarrow Y'$ arrow.

□

karl-search= End Fact Higher-Validity Proof

8.1.9 Definition Higher-Mu

karl-search= Start Definition Higher-Mu

Definition 8.4

(+++ Orig. No.: Definition Higher-Mu +++)

LABEL: Definition Higher-Mu

Let \mathcal{X} be a generalized preferential structure of level $n, X \subseteq \mathbf{P}(\mathcal{X})$.

$\mu(X) := \{x \in X : \exists \langle x, i \rangle . \neg \exists \text{ valid } X - to - X \text{ arrow } \alpha : x' \rightarrow \langle x, i \rangle\}$.

karl-search= End Definition Higher-Mu

8.1.10 Comment Smooth-Gen

karl-search= Start Comment Smooth-Gen

Comment 8.2

(+++ Orig. No.: Comment Smooth-Gen +++)

LABEL: Comment Smooth-Gen

The purpose of smoothness is to guarantee cumulativity. Smoothness achieves Cumulativity by mirroring all information present in X also in $\mu(X)$. Closer inspection shows that smoothness does more than necessary. This is visible when there are copies (or, equivalently, non-injective labelling functions). Suppose we have two copies of $x \in X, \langle x, i \rangle$ and $\langle x, i' \rangle$, and there is $y \in X, \alpha : \langle y, j \rangle \rightarrow \langle x, i \rangle$, but there is no $\alpha' : \langle y', j' \rangle \rightarrow \langle x, i' \rangle, y' \in X$. Then $\alpha : \langle y, j \rangle \rightarrow \langle x, i \rangle$ is irrelevant, as $x \in \mu(X)$ anyhow. So mirroring $\alpha : \langle y, j \rangle \rightarrow \langle x, i \rangle$ in $\mu(X)$ is not necessary, i.e. it is not necessary to have some $\alpha' : \langle y', j' \rangle \rightarrow \langle x, i \rangle, y' \in \mu(X)$.

On the other hand, Example 8.3 (page 130) shows that, if we want smooth structures to correspond to the property (μCUM), we need at least some valid arrows from $\mu(X)$ also for higher level arrows. This “some” is made precise (essentially) in Definition 8.5 (page 126) .

From a more philosophical point of view, when we see the (inverted) arrows of preferential structures as attacks on non-minimal elements, then we should see smooth structures as always having attacks also from valid (min-

imal) elements. So, in general structures, also attacks from non-valid elements are valid, in smooth structures we always also have attacks from valid elements.

The analogon to usual smooth structures, on level 2, is then that any successfully attacked level 1 arrow is also attacked from a minimal point.

karl-search= End Comment Smooth-Gen

8.1.11 Definition X-Sub-X'

karl-search= Start Definition X-Sub-X'

Definition 8.5

(+++ Orig. No.: Definition X-Sub-X' +++)

LABEL: Definition X-Sub-X'

Let \mathcal{X} be a generalized preferential structure.

$X \sqsubseteq X'$ iff

- (1) $X \subseteq X' \subseteq \mathbf{P}(\mathcal{X})$,
- (2) $\forall x \in X' - X \forall \langle x, i \rangle \exists \alpha : x' \rightarrow \langle x, i \rangle$ (α is a valid $X \Rightarrow X'$ arrow),
- (3) $\forall x \in X \exists \langle x, i \rangle$
 $(\forall \alpha : x' \rightarrow \langle x, i \rangle (x' \in X' \Rightarrow \exists \beta : x'' \rightarrow \alpha. (\beta \text{ is a valid } X \Rightarrow X' \text{ arrow})))$.

Note that (3) is not simply the negation of (2):

Consider a level 1 structure. Thus all level 1 arrows are valid, but the source of the arrows must not be neglected.

(2) reads now: $\forall x \in X' - X \forall \langle x, i \rangle \exists \alpha : x' \rightarrow \langle x, i \rangle . x' \in X$

(3) reads: $\forall x \in X \exists \langle x, i \rangle \neg \exists \alpha : x' \rightarrow \langle x, i \rangle . x' \in X'$

This is intended: intuitively, $X = \mu(X')$, and minimal elements must not be attacked at all, but non-minimals must be attacked from X - which is a modified version of smoothness.

karl-search= End Definition X-Sub-X'

8.1.12 Remark X-Sub-X'

karl-search= Start Remark X-Sub-X'

Remark 8.2

(+++ Orig. No.: Remark X-Sub-X' +++)

LABEL: Remark X-Sub-X'

We note the special case of Definition 8.5 (page 126) for level 3 structures, as it will be used later. We also write it immediately for the intended case $\mu(X) \sqsubseteq X$, and explicitly with copies.

$x \in \mu(X)$ iff

- (1) $\exists \langle x, i \rangle \forall \langle \alpha, k \rangle : \langle y, j \rangle \rightarrow \langle x, i \rangle$
 $(y \in X \rightarrow \exists \langle \beta', l' \rangle : \langle z', m' \rangle \rightarrow \langle \alpha, k \rangle .$

$$(z' \in \mu(X) \wedge \neg \exists \langle \gamma', n' \rangle : \langle u', p' \rangle \rightarrow \langle \beta', l' \rangle . u' \in X))$$

See Diagram 18.28 (page 193) .

$x \in X - \mu(X)$ iff

$$(2) \forall \langle x, i \rangle \exists \langle \alpha', k' \rangle : \langle y', j' \rangle \rightarrow \langle x, i \rangle$$

$$(y' \in \mu(X) \wedge$$

$$(a) \neg \exists \langle \beta', l' \rangle : \langle z', m' \rangle \rightarrow \langle \alpha', k' \rangle . z' \in X$$

or

$$(b) \forall \langle \beta', l' \rangle : \langle z', m' \rangle \rightarrow \langle \alpha', k' \rangle$$

$$(z' \in X \rightarrow \exists \langle \gamma', n' \rangle : \langle u', p' \rangle \rightarrow \langle \beta', l' \rangle . u' \in \mu(X)))$$

See Diagram 18.29 (page 194) .

karl-search= End Remark X-Sub-X'

Diagram 8.1 LABEL: Diagram Essential-Smooth-3-1-2

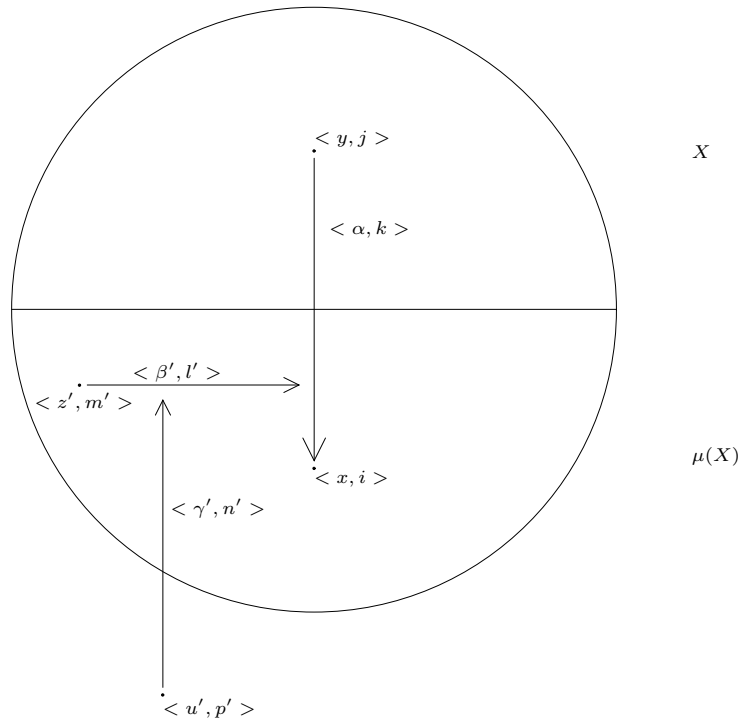

Case 3-1-2

Diagram 8.2 LABEL: Diagram Essential-Smooth-3-2

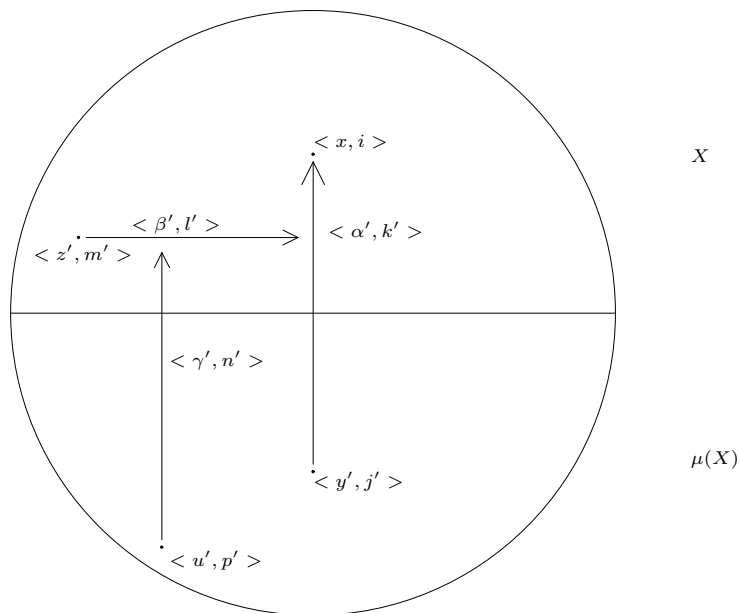

Case 3-2

8.1.13 Fact X-Sub-X'

karl-search= Start Fact X-Sub-X'

Fact 8.3

(+++ Orig. No.: Fact X-Sub-X' +++)

LABEL: Fact X-Sub-X'

- (1) If $X \sqsubseteq X'$, then $X = \mu(X')$,
- (2) $X \sqsubseteq X'$, $X \subseteq X'' \subseteq X' \Rightarrow X \sqsubseteq X''$. (This corresponds to (μCUM) .)
- (3) $X \sqsubseteq X'$, $X \subseteq Y'$, $Y \sqsubseteq Y'$, $Y \subseteq X' \Rightarrow X = Y$. (This corresponds to $(\mu \subseteq \supseteq)$.)

karl-search= End Fact X-Sub-X'

8.1.14 Fact X-Sub-X' Proof

karl-search= Start Fact X-Sub-X' Proof

8.1.14.1 Proof Fact X - Sub - X'

(+++*** Orig.: Proof Fact X-Sub-X')

Proof

(+++*** Orig.: Proof)

(1) Trivial by Fact 8.1 (page 124) (1).

(2)

We have to show

(a) $\forall x \in X'' - X \forall \langle x, i \rangle \exists \alpha : x' \rightarrow \langle x, i \rangle$ (α is a valid $X \Rightarrow X''$ arrow), and

(b) $\forall x \in X \exists \langle x, i \rangle (\forall \alpha : x' \rightarrow \langle x, i \rangle (x' \in X'' \Rightarrow \exists \beta : x'' \rightarrow \alpha. (\beta \text{ is a valid } X \Rightarrow X'' \text{ arrow})))$.

Both follow from the corresponding condition for $X \Rightarrow X'$, the restriction of the universal quantifier, and Fact 8.1 (page 124) (2).

(3)

Let $x \in X - Y$.

(a) By $x \in X \sqsubseteq X'$, $\exists \langle x, i \rangle$ s.t. $(\forall \alpha : x' \rightarrow \langle x, i \rangle (x' \in X' \Rightarrow \exists \beta : x'' \rightarrow \alpha. (\beta \text{ is a valid } X \Rightarrow X' \text{ arrow})))$.

(b) By $x \notin Y \sqsubseteq \exists \alpha_1 : x' \rightarrow \langle x, i \rangle \alpha_1$ is a valid $Y \Rightarrow Y'$ arrow, in particular $x' \in Y \subseteq X'$. Moreover, $\lambda(\alpha_1) = 1$.

So by (a) $\exists \beta_2 : x'' \rightarrow \alpha_1. (\beta_2 \text{ is a valid } X \Rightarrow X' \text{ arrow})$, in particular $x'' \in X \subseteq Y'$, moreover $\lambda(\beta_2) = 2$.

It follows by induction from the definition of valid $A \Rightarrow B$ arrows that

$\forall n \exists \alpha_{2m+1}, \lambda(\alpha_{2m+1}) = 2m + 1, \alpha_{2m+1}$ a valid $Y \Rightarrow Y'$ arrow and

$\forall n \exists \beta_{2m+2}, \lambda(\beta_{2m+2}) = 2m + 2, \beta_{2m+2}$ a valid $X \Rightarrow X'$ arrow,

which is impossible, as \mathcal{X} is a structure of finite level.

□

karl-search= End Fact X-Sub-X' Proof

8.1.15 Definition Totally-Smooth

karl-search= Start Definition Totally-Smooth

Definition 8.6

(+++ Orig. No.: Definition Totally-Smooth +++)

LABEL: Definition Totally-Smooth

Let \mathcal{X} be a generalized preferential structure, $X \subseteq \mathbf{P}(\mathcal{X})$.

\mathcal{X} is called totally smooth for X iff

(1) $\forall \alpha : x \rightarrow y \in \mathbf{A}(\mathcal{X})(O(\alpha) \cup D(\alpha) \subseteq X \Rightarrow \exists \alpha' : x' \rightarrow y. x' \in \mu(X))$

(2) if α is valid, then there must also exist such α' which is valid.

(y a point or an arrow).

If $\mathcal{Y} \subseteq \mathbf{P}(\mathcal{X})$, then \mathcal{X} is called \mathcal{Y} -totally smooth iff for all $X \in \mathcal{Y}$ \mathcal{X} is totally smooth for X .

karl-search= End Definition Totally-Smooth

8.1.16 Example Totally-Smooth

karl-search= Start Example Totally-Smooth

Example 8.2

(+++ Orig. No.: Example Totally-Smooth +++)

LABEL: Example Totally-Smooth

$X := \{\alpha : a \rightarrow b, \alpha' : b \rightarrow c, \alpha'' : a \rightarrow c, \beta : b \rightarrow \alpha'\}$ is not totally smooth,

$X := \{\alpha : a \rightarrow b, \alpha' : b \rightarrow c, \alpha'' : a \rightarrow c, \beta : b \rightarrow \alpha', \beta' : a \rightarrow \alpha'\}$ is totally smooth.

karl-search= End Example Totally-Smooth

8.1.17 Example Need-Smooth

karl-search= Start Example Need-Smooth

Example 8.3

(+++ Orig. No.: Example Need-Smooth +++)

LABEL: Example Need-Smooth

Consider $\alpha' : a \rightarrow b, \alpha'' : b \rightarrow c, \alpha : a \rightarrow c, \beta : a \rightarrow \alpha$.

Then $\mu(\{a, b, c\}) = \{a\}, \mu(\{a, c\}) = \{a, c\}$. Thus, (μCUM) does not hold in this structure. Note that there is no valid arrow from $\mu(\{a, b, c\})$ to c .

karl-search= End Example Need-Smooth

8.1.18 Definition Essentially-Smooth

karl-search= Start Definition Essentially-Smooth

Definition 8.7

(+++ Orig. No.: Definition Essentially-Smooth +++)

LABEL: Definition Essentially-Smooth

Let \mathcal{X} be a generalized preferential structure, $X \subseteq \mathbf{P}(\mathcal{X})$.

\mathcal{X} is called essentially smooth for X iff $\mu(X) \sqsubseteq X$.

If $\mathcal{Y} \subseteq \mathbf{P}(\mathcal{X})$, then \mathcal{X} is called \mathcal{Y} -essentially smooth iff for all $X \in \mathcal{Y}$ $\mu(X) \sqsubseteq X$.

karl-search= End Definition Essentially-Smooth

8.1.19 Example Total-vs-Essential

karl-search= Start Example Total-vs-Essential

Example 8.4

(+++ Orig. No.: Example Total-vs-Essential +++)

LABEL: Example Total-vs-Essential

It is easy to see that we can distinguish total and essential smoothness in richer structures, as the following Example shows:

We add an accessibility relation R , and consider only those models which are accessible.

Let e.g. $a \rightarrow b \rightarrow \langle c, 0 \rangle, \langle c, 1 \rangle$, without transitivity. Thus, only c has two copies. This structure is essentially smooth, but of course not totally so.

Let now $mRa, mRb, mR \langle c, 0 \rangle, mR \langle c, 1 \rangle, m'Ra, m'Rb, m'R \langle c, 0 \rangle$.

Thus, seen from m , $\mu(\{a, b, c\}) = \{a, c\}$, but seen from m' , $\mu(\{a, b, c\}) = \{a\}$, but $\mu(\{a, c\}) = \{a, c\}$, contradicting (CUM).

□

karl-search= End Example Total-vs-Essential

karl-search= End ToolBase1-HigherPref

9 New remarks

- (1) eMF_1 entails: $\mu(Y) \subseteq X \subseteq Y \Rightarrow \mu(X) \subseteq \mu(Y)$
- (2) Let $X \subseteq Y \subseteq Z$.
 - $eMI_1 : X \in \mathcal{I}(Y) \Rightarrow X \in \mathcal{I}(Z)$
 - $eMI_2 : X \in \mathcal{M}^-(Y) \Rightarrow X \in \mathcal{M}^-(Z)$
 - $eMF_1 : X \in \mathcal{F}(Z) \Rightarrow X \in \mathcal{F}(Y)$
 - $eMF_2 : X \in \mathcal{M}^+(Z) \Rightarrow X \in \mathcal{M}^+(Y)$
- (3) We have: $eMI_1 \Leftrightarrow eMF_2, eMI_2 \Leftrightarrow eMF_1$.
- (4) We can represent the semantics for $n * s$ by reactive structures: the choice of one big subset disables the other choices.
- (5) Some such structures can be represented by permutations (sometimes not all) of elements chosen.

- (6) (iM) is done automatically, we have basically a preferential structure, but one which is switched on/off. The basic preferential idea is in the fact that small sets are upward small. And Big sets are downward big, this corresponds to Cautious Monotony.
- (7) Was genau entspricht (eMI) , (eMF) ?
 As the versions (1) suffice, we work with them only.
 (eMI) without any domain prerequisites for \sim :
 (CUT') $\alpha \sim \beta, \alpha \vdash \alpha', \alpha' \wedge \neg\beta \vdash \alpha \Rightarrow \alpha' \sim \beta$
 (eMI) with (\cup) :
 (wOR) $\alpha \sim \beta, \alpha' \vdash \beta \Rightarrow \alpha \vee \alpha' \sim \beta$
 (eMF) without any domain prerequisites for \sim :
 (CM') $\alpha \sim \beta, \alpha' \vdash \alpha, \alpha \wedge \beta \vdash \alpha' \Rightarrow \alpha' \sim \beta$.
- (8) $(LLE) + (SC) + (RW) + (CUT') + (CM')$ characterize basic systems.
 (iM) holds by (RW).
 (eMI) : Let $A \subseteq X \subseteq Y$, A be small in X , $A := M(\alpha \wedge \neg\beta) = M(\alpha' \wedge \neg\beta) \Rightarrow \alpha' \sim \beta \Rightarrow M(\alpha' \wedge \neg\beta)$ is small in Y .
 (eMF) analogously.
- (9) subideal situations and size: Optimum: smallest big subset, subideal: bigger big set, least ideal: all. This is ordered by logical strength.

10 Main table

I should translate all logical rules into algebraic rules.

E.g.

$\alpha \sim \beta$ corresponds to $A - B \in \mathcal{I}(A)$

$\alpha \not\sim \beta$ to $A - B \in \mathcal{M}^+(A)$

$\alpha \vdash \beta$ to $A - B = \emptyset$

And then give only the algebraic versions of the rules (AND_x) , (OR_x) , (CM_x) .

Define \mathcal{M}^+ , \mathcal{M}^- .

	Ideal	Filter	\mathcal{M}^+	∇	div. rules	AND	OR	CM/Rat.Mon.
Optimal proportion								
(Opt)	$\emptyset \in \mathcal{I}(X)$	$X \in \mathcal{F}(X)$		$\nabla x\phi \rightarrow \nabla x\phi$	(SC) $\alpha \vdash \beta \Rightarrow \alpha \vdash \beta$			
Monotony: Improving proportions								
(iM)	$A \subseteq B \in \mathcal{I}(X) \Rightarrow$ $A \in \mathcal{I}(X)$	$A \subseteq B$ $\Rightarrow B \in \mathcal{F}(X)$		$\nabla x\phi \wedge \nabla(\phi \rightarrow \phi')$ $\rightarrow \nabla x\phi'$	(RW) $\alpha \vdash \beta, \beta \vdash \beta' \Rightarrow$ $\alpha \vdash \beta'$			
(eMI)	Let $X \subseteq Y$ (1) $\mathcal{I}(X) \subseteq \mathcal{I}(Y)$ (2) $\mathcal{M}^-(X) \subseteq \mathcal{M}^-(Y)$			$\nabla x(\phi : \psi) \wedge$ $\forall x(\phi' \rightarrow \psi) \rightarrow$ $\nabla x(\phi \vee \phi' : \psi)$			(wOR) $\alpha \vdash \beta, \alpha' \vdash \beta \Rightarrow$ $\alpha \vee \alpha' \vdash \beta$	
(eMF)		Let $X \subseteq Y$ (1) $\mathcal{F}(Y) \cap \mathcal{P}(X) \subseteq \mathcal{F}(X)$ (2) $\mathcal{M}^+(Y) \cap \mathcal{P}(X) \subseteq$ $\mathcal{M}^+(X)$		$\nabla x(\phi : \psi) \wedge$ $\forall x(\psi \rightarrow \psi') \rightarrow$ $\nabla x(\phi \wedge \psi' : \psi)$				(wCM) $\alpha \vdash \beta, \beta \vdash \beta' \Rightarrow$ $\alpha \wedge \beta' \vdash \beta$
Keeping proportions								
(\approx)	($\mathcal{I} \cup \text{disj}$) $A \in \mathcal{I}(X), B \in \mathcal{I}(Y),$ $X \cap Y = \emptyset \Rightarrow$ $A \cup B \in \mathcal{I}(X \cup Y)$	($\mathcal{F} \cup \text{disj}$) $A \in \mathcal{F}(X), B \in \mathcal{F}(Y),$ $X \cap Y = \emptyset \Rightarrow$ $A \cup B \in \mathcal{F}(X \cup Y)$					(disjOR) $\phi \vdash \psi, \phi' \vdash \psi$ $\phi \vdash \neg\phi', \Rightarrow$ $\phi \vee \phi' \vdash \psi$	
Robustness of proportions: $n * \text{small} \neq \text{All}$								
(1 * s)	(\mathcal{I}_1) $X \notin \mathcal{I}(X)$	(\mathcal{F}_1) $\emptyset \notin \mathcal{F}(X)$		(∇_1) $\nabla x\phi \rightarrow \exists x\phi$	(CP) $\phi \vdash \perp \Rightarrow \phi \vdash \perp$	(AND ₁) $\alpha \vdash \beta \Rightarrow \alpha \wedge \neg\beta$		
(2 * s)	(\mathcal{I}_2) $A, B \in \mathcal{I}(X) \Rightarrow$ $A \cup B \neq X$	(\mathcal{F}_2) $A, B \in \mathcal{F}(X) \Rightarrow$ $A \cap B \neq \emptyset$		(∇_2) (1) $\nabla x\phi \wedge \nabla x\psi$ $\rightarrow \exists x(\phi \wedge \psi)$ (2) $\nabla x\phi(x) \rightarrow \neg\nabla x\neg\phi(x)$		(AND ₂) (1) $\alpha \vdash \beta, \alpha \vdash \beta' \Rightarrow$ $\alpha \wedge \neg\beta \vee \neg\beta'$ (2) $\alpha \vdash \beta \Rightarrow \alpha \wedge \neg\beta$		(CM ₂) $\alpha \vdash \beta, \alpha \vdash \beta' \Rightarrow$ $\alpha \wedge \beta \wedge \neg\beta'$
(3 * s)	(\mathcal{I}_3) $A, B, C \in \mathcal{I}(X) \Rightarrow$ $A \cup B \cup C \neq X$	(\mathcal{F}_3) $A, B, C \in \mathcal{F}(X) \Rightarrow$ $A \cap B \cap C \neq \emptyset$	(\mathcal{M}_3^+) $A \in \mathcal{F}(X), X \in \mathcal{F}(Y)$ $Y \in \mathcal{F}(Z)$ $\Rightarrow A \in \mathcal{M}^+(Z)$	(∇_3) $\nabla x\phi \wedge \nabla x\psi \wedge \nabla x\sigma$ \rightarrow $\exists x(\phi \wedge \psi \wedge \sigma)$	(\mathcal{L}_3^+) $\gamma \vdash \beta, \gamma \wedge \beta \vdash \alpha$ $\Rightarrow \gamma \not\vdash \neg\alpha$	(AND ₃) (1) $\alpha \vdash \beta, \alpha \vdash \beta', \alpha \vdash \beta''$ $\Rightarrow \alpha \wedge \neg\beta \vee \neg\beta' \vee \neg\beta''$ (2) $\alpha \vdash \beta, \alpha \vdash \beta' \Rightarrow$ $\alpha \not\vdash \neg\beta \vee \neg\beta'$	(OR ₃) $\alpha \vdash \beta, \alpha' \vdash \beta \Rightarrow$ $\alpha \vee \alpha' \not\vdash \neg\beta$	(CM ₃) (1) $\alpha \vdash \beta, \alpha \vdash \beta', \alpha \vdash \beta''$ $\Rightarrow \alpha \wedge \beta \wedge \beta' \wedge \neg\beta''$ (2) $\alpha \vdash \beta, \alpha \vdash \beta' \Rightarrow$ $\alpha \wedge \beta \not\vdash \neg\beta'$
(n * s)	(\mathcal{I}_n) $A_1, \dots, A_n \in \mathcal{I}(X)$ \Rightarrow $A_1 \cup \dots \cup A_n \neq X$	(\mathcal{F}_n) $A_1, \dots, A_n \in \mathcal{I}(X)$ \Rightarrow $A_1 \cap \dots \cap A_n \neq \emptyset$	(\mathcal{M}_n^+) $X_1 \in \mathcal{F}(X_2), \dots,$ $X_{n-1} \in \mathcal{F}(X_n) \Rightarrow$ $X_1 \in \mathcal{M}^+(X_n)$	(∇_n) $\nabla x\phi_1 \wedge \dots \wedge \nabla x\phi_n$ \rightarrow $\exists x(\phi_1 \wedge \dots \wedge \phi_n)$	(\mathcal{L}_n^+) $\alpha_n \vdash \alpha_{n-1},$ $\alpha_n \wedge \alpha_{n-1} \vdash \alpha_{n-2}$ \dots $\alpha_n \wedge \dots \wedge \alpha_2 \vdash \alpha_1$ $\Rightarrow \alpha_n \not\vdash \neg\alpha_1$	(AND _n) (1) $\alpha \vdash \beta_1, \dots, \alpha \vdash \beta_n \Rightarrow$ $\alpha \wedge \neg\beta_1 \vee \dots \vee \neg\beta_n$ (2) $\alpha \vdash \beta_1, \dots, \alpha \vdash \beta_{n-1} \Rightarrow$ $\alpha \not\vdash \neg\beta_1 \vee \dots \vee \neg\beta_{n-1}$	(OR _n) $\alpha_1 \vdash \beta, \dots, \alpha_{n-1} \vdash \beta$ \Rightarrow $\alpha_1 \vee \dots \vee \alpha_{n-1} \not\vdash$ $\neg\beta$	(CM _n) (1) $\alpha \vdash \beta_1, \dots, \alpha \vdash \beta_n \Rightarrow$ $\alpha \wedge \beta_1 \wedge \dots \wedge \beta_{n-1} \wedge \neg\beta_n$ (2) $\alpha \vdash \beta_1, \dots, \alpha \vdash \beta_{n-1} \Rightarrow$ $\alpha \wedge \beta_1 \wedge \dots \wedge \beta_{n-2} \not\vdash$ $\neg\beta_{n-1}$
(< ω * s)	(\mathcal{I}_ω) $A, B \in \mathcal{I}(X) \Rightarrow$ $A \cup B \in \mathcal{I}(X)$	(\mathcal{F}_ω) $A, B \in \mathcal{F}(X) \Rightarrow$ $A \cap B \in \mathcal{F}(X)$	(\mathcal{M}_ω^+) (1) $A \in \mathcal{F}(X), X \in \mathcal{M}^+(Y)$ $\Rightarrow A \in \mathcal{M}^+(Y)$ (2) $A \in \mathcal{M}^+(X), X \in \mathcal{F}(Y)$ $\Rightarrow A \in \mathcal{M}^+(Y)$ (3) $A \in \mathcal{F}(X), X \in \mathcal{F}(Y)$ $\Rightarrow A \in \mathcal{F}(Y)$ (4) $A, B \in \mathcal{I}(X) \Rightarrow$ $A - B \in \mathcal{I}(X - B)$ (5) $A \in \mathcal{F}(X), B \in \mathcal{I}(X)$ $\Rightarrow A - B \in \mathcal{F}(X - B)$	(∇_ω) $\nabla x\phi \wedge \nabla x\psi \rightarrow$ $\nabla x(\phi \wedge \psi)$	(\mathcal{L}_ω^+) (1) $\gamma \not\vdash \neg\beta, \gamma \wedge \beta \vdash \alpha$ $\Rightarrow \gamma \not\vdash \neg\alpha$ (2) $\gamma \vdash \beta, \gamma \wedge \beta \not\vdash \neg\alpha$ $\Rightarrow \gamma \not\vdash \neg\alpha$ (3) $\gamma \wedge \beta \vdash \alpha, \gamma \vdash \beta$ $\Rightarrow \gamma \vdash \alpha$	(AND _{ω}) $\alpha \vdash \beta, \alpha \vdash \beta' \Rightarrow$ $\alpha \vdash \beta \wedge \beta'$	(OR _{ω}) $\alpha \vdash \beta, \alpha' \vdash \beta \Rightarrow$ $\alpha \vee \alpha' \vdash \beta$	(CM _{ω}) $\alpha \vdash \beta, \alpha \vdash \beta' \Rightarrow$ $\alpha \wedge \beta \vdash \beta'$
Robustness of \mathcal{M}^+								
(\mathcal{M}^{++})			(\mathcal{M}^+) (1) $A \in \mathcal{I}(X), B \notin \mathcal{F}(X)$ $\Rightarrow A - B \in \mathcal{I}(X - B)$ (2) $A \in \mathcal{F}(X), B \notin \mathcal{F}(X)$ $\Rightarrow A - B \in \mathcal{F}(X - B)$ (3) $A \in \mathcal{M}^+(X),$ $X \in \mathcal{M}^+(Y)$ $\Rightarrow A \in \mathcal{M}^+(Y)$		analogue (\mathcal{L}_ω^+)			(RatM) $\phi \vdash \psi, \phi \not\vdash \neg\psi' \Rightarrow$ $\phi \wedge \psi' \vdash \psi$

11 Comments

The usual rules (*AND*) etc. are named here (*AND*_ω), as they are in a natural ascending line of similar rules, based on strengthening of the filter/ideal properties.

$$\alpha \vdash \beta :\Leftrightarrow M(\alpha \wedge \beta) \in \mathcal{F}(M(\alpha)) \Leftrightarrow M(\alpha \wedge \neg\beta) \in \mathcal{I}(M(\alpha)).$$

$$\text{Thus } \alpha \not\vdash \beta \Leftrightarrow M(\alpha \wedge \neg\beta) \in \mathcal{M}^+(M(\alpha)).$$

$$\alpha \vdash \beta \Leftrightarrow M(\alpha \wedge \beta) = M(\alpha).$$

11.1 Regularities

The rules are divided into 5 groups:

- (1) (*Opt*), which says that All is optimal - i.e. when there are no exceptions, then a rule holds.
- (2) 3 monotony rules:
 - (2.1) (*iM*) is inner monotony, a subset of a small set is small
 - (2.2) (*eMI*) external monotony for ideals: enlarging the base set keeps small sets small
 - (2.3) (*emF*) external monotony for filters: a big subset stays big when the base set shrinks.

These three rules are very natural if “size” is anything coherent over change of base sets. In particular, they can be seen as weakening.
- (3) (\approx) keeps proportions, it is here mainly to point the possibility out.
- (4) a group of rules $x * s$, which say how many small sets will not yet add to the base set.
- (5) Rational monotony, which can best be understood as robustness of \mathcal{M}^+ - where \mathcal{M}^+ is the set of subsets, which are not small, i.e. big or medium size.

There are more regularities in the table:

Starting at $3 * s$, the properties can be expressed nicely by ever stronger conditions \mathcal{M}^+ .

The conditions \mathcal{I}_x (or, equivalently, \mathcal{F}_x) correspond directly to the conditions $(AND)_x$. The other logical and algebraic conditions in the same line can be obtained using the weakening rules (monotony). Thus, $(AND)_x$, somewhat surprisingly, reveals itself as, in this sense, the strongest rule of the line x .

See below.

Thus, we can summarize:

We can obtain all rules except (*RatM*) from (*Opt*), the monotony rules, and $x * s$.

11.2 The position of RatMon:

RatM does not fit into adding small sets. We have exhausted the combination of small sets by $(< \omega * s)$, unless we go to languages with infinitary formulas.

The next idea would be to add medium size sets. But, by definition, $2 * medium$ can be all. Adding small and medium sets would not help either: Suppose we have a rule $medium + n * small \neq all$. Taking the complement of the first medium set, which is again medium, we have the rule $2 * n * small \neq all$. So we do not see any meaningful new internal rule. i.e. without changing the base set.

12 Coherent systems

Definition 12.1

(+++ Orig. No.: Definition CoherentSystem +++)

LABEL: Definition CoherentSystem

A coherent system of sizes \mathcal{CS} consists of a universe U , $\emptyset \notin \mathcal{Y} \subseteq \mathcal{P}(U)$, and for all $X \in \mathcal{Y}$ $\mathcal{I}(X)$ (dually $\mathcal{F}(X)$). We say that \mathcal{CS} satisfies a certain property iff all $X, Y \in \mathcal{Y}$ satisfy this property.

\mathcal{CS} is called basic or level 1 iff it satisfies (iM), (eMI), (eMF), (1 * s).

\mathcal{CS} is level n iff it satisfies (iM), (eMI), (eMF), ($n * s$).

Fact 12.1

(+++ Orig. No.: Fact Not-2*s +++)

LABEL: Fact Not-2*s

Let a \mathcal{CS} be given s.t. $\mathcal{Y} = \mathcal{P}(U)$. If $X \in \mathcal{Y}$ satisfies \mathcal{M}^{++} , but not ($< \omega * s$), then there is $Y \in \mathcal{Y}$ which does not satisfy ($2 * s$).

Proof

(+++*** Orig.: Proof)

As X does not satisfy ($< \omega * s$), there are small $A, B \subseteq X$ s.t. $A \cup B \in \mathcal{M}^+$. Consider now $A \cup B$ as base set Y . By (\mathcal{M}^{++}) for X , $A, B \notin \mathcal{M}^+(A \cup B)$, so $A, B \in \mathcal{I}(A \cup B)$, so ($2 * s$) does not hold for $A \cup B$. \square

Fact 12.2

(+++ Orig. No.: Fact Independence-eM +++)

LABEL: Fact Independence-eM

(1) (eMI) and (eMF) (1) are formally independent, though intuitively equivalent.

(2) (eMF) (1) + (2) \Rightarrow (eMI).

Proof

(+++*** Orig.: Proof)

(1) Let $U := \{x, y, z\}$, $X := \{x, z\}$, $\mathcal{Y} := \{U, X\}$.

(1.1) Let $\mathcal{F}(U) := \{A \subseteq U : z \in A\}$, $\mathcal{F}(X) := \{X\}$. (eMI) holds for X and U , but $\{z\} \in \mathcal{F}(U)$, $\{z\} \subseteq X$, $\{z\} \notin \mathcal{F}(X)$, so (eMF) fails.

(1.2) Let $\mathcal{F}(U) := \{U\}$, $\mathcal{F}(X) := \{A \subseteq X : z \in A\}$. (eMF) holds trivially, but (eMI) fails, as $\{x\} \in \mathcal{I}(X)$, but $\{x\} \notin \mathcal{I}(U)$.

(2) Let $A \subseteq X \subseteq Y$ $A \in \mathcal{I}(X)$. If $A \in \mathcal{M}(Y)$, then $A \in \mathcal{M}(X)$, likewise if $A \in \mathcal{F}(Y)$, so $A \in \mathcal{I}(Y)$.

\square

Fact 12.3

(+++ Orig. No.: Fact Level-n-n+1 +++)

LABEL: Fact Level-n-n+1

A level n system is strictly weaker than a level $n + 1$ system.

Proof

(+++*** Orig.: Proof)

Consider $U := \{1, \dots, n + 1\}$, $\mathcal{Y} := \mathcal{P}(U) - \{\emptyset\}$. Let $\mathcal{I}(U) := \{\emptyset\} \cup \{\{x\} : x \in U\}$, $\mathcal{I}(X) := \{\emptyset\}$ for $X \neq U$. (iM), (eMI), (eMF) hold trivially, so does ($1 * s$). ($n * s$) holds trivially for $X \neq U$, but also for U . ($(n * 1) * s$)

does not hold for U . \square

13 Ideals, filters, and logical rules

(\mathcal{I}_n) says $A_1, \dots, A_n \in \mathcal{I}(X) \Rightarrow A_1 \cup \dots \cup A_n \neq X$.

The proofs for $(< \omega * s)$ are analogous.

13.1 There are infinitely many new rules

Note that our schemata allow us to generate infinitely many new rules, here is an example:

Start with A , add $s_{1,1}, s_{1,2}$ two sets small in $A \cup s_{1,1}$ ($A \cup s_{1,2}$ respectively). Consider now $A \cup s_{1,1} \cup s_{1,2}$ and s_2 s.t. s_2 is small in $A \cup s_{1,1} \cup s_{1,2} \cup s_2$. Continue with $s_{3,1}, s_{3,2}$ small in $A \cup s_{1,1} \cup s_{1,2} \cup s_2 \cup s_{3,1}$ etc.

Without additional properties, this system creates a new rule, which is not equivalent to any usual rules.

14 Facts about \mathcal{M}

14.0.1 Fact R-down-neu

karl-search= Start Fact R-down-neu

Fact 14.1

(+++ Orig. No.: Fact R-down-neu +++)

LABEL: Fact R-down-neu

(\mathcal{M}_ω^+) (4) and (5) and the three versions of (\mathcal{M}^{++}) are each equivalent.

For the third version of (\mathcal{M}^{++}) we use (eMI) and (eMF) .

karl-search= End Fact R-down-neu

14.0.2 Fact R-down-neu Proof

karl-search= Start Fact R-down-neu Proof

Proof

(+++*** Orig.: Proof)

For $A, B \subseteq X$, $(X - B) - ((X - A) - B) = A - B$.

“ \Rightarrow ”: Let $A \in \mathcal{F}(X)$, $B \in \mathcal{I}(X)$, so $X - A \in \mathcal{I}(X)$, so by prerequisite $(X - A) - B \in \mathcal{I}(X - B)$, so $A - B = (X - B) - ((X - A) - B) \in \mathcal{F}(X - B)$.

“ \Leftarrow ”: Let $A, B \in \mathcal{I}(X)$, so $X - A \in \mathcal{F}(X)$, so by prerequisite $(X - A) - B \in \mathcal{F}(X - B)$, so $A - B = (X - B) - ((X - A) - B) \in \mathcal{I}(X - B)$.

The proof for (\mathcal{M}^{++}) is the same for the first two cases.

It remains to show equivalence with the last one. We assume closure under set difference and union.

(1) \Rightarrow (3) :

Suppose $A \notin \mathcal{M}^+(Y)$, but $X \in \mathcal{M}^+(Y)$, we show $A \notin \mathcal{M}^+(X)$. So $A \in \mathcal{I}(Y)$, $Y - X \notin \mathcal{F}(Y)$, so $A = A - (Y - X) \in \mathcal{I}(Y - (Y - X)) = \mathcal{I}(X)$.

(3) \Rightarrow (1) :

Suppose $A - B \notin \mathcal{I}(X - B)$, $B \notin \mathcal{F}(X)$, we show $A \notin \mathcal{I}(X)$. By prerequisite $A - B \in \mathcal{M}^+(X - B)$, $X - B \in \mathcal{M}^+(X)$, so $A - B \in \mathcal{M}^+(X)$, so by (eMI) and (eMF) $A \in \mathcal{M}^+(X)$, so $A \notin \mathcal{I}(X)$.

□

karl-search= End Fact R-down-neu Proof

Fact 14.2

(+++ Orig. No.: Fact 3- ι 1-3- ι 2 +++)

LABEL: Fact 3- ι 1-3- ι 2

(3) \Rightarrow (1) of (\mathcal{M}_ω^+) , (3) \Rightarrow (2) of (\mathcal{M}_ω^+) .

Proof

(+++*** Orig.: Proof)

$A \in \mathcal{I}(Y) \Rightarrow X = (X - A) \cup A \in \mathcal{I}(Y)$. The other implication is analogous. \square

15 Equivalences between size and logic

15.0.3 Proposition Ref-Class-Mu-neu

karl-search= Start Proposition Ref-Class-Mu-neu

Proposition 15.1

(+++ Orig. No.: Proposition Ref-Class-Mu-neu +++)

LABEL: Proposition Ref-Class-Mu-neu

If $f(X)$ is the smallest A s.t. $A \in \mathcal{F}(X)$, then, given the property on the left, the one on the right follows.

Conversely, when we define $\mathcal{F}(X) := \{X' : f(X) \subseteq X' \subseteq X\}$, given the property on the right, the one on the left follows. For this direction, we assume that we can use the full powerset of some base set U - as is the case for the model sets of a finite language. This is perhaps not too bold, as we mainly want to stress here the intuitive connections, without putting too much weight on definability questions.

We assume (iM) to hold.

(1.1)	(eMT)	\Rightarrow	(μwOR)
(1.2)		\Leftarrow	
(2.1)	$(eMT) + (I_\omega)$	\Rightarrow	(μOR)
(2.2)		\Leftarrow	
(3.1)	$(eMT) + (I_\omega)$	\Rightarrow	(μPR)
(3.2)		\Leftarrow	
(4.1)	$(I \cup disj)$	\Rightarrow	$(\mu disjOR)$
(4.2)		\Leftarrow	
(5.1)	(\mathcal{M}_ω^+)	\Rightarrow	(μCM)
(5.2)		\Leftarrow	
(6.1)	(\mathcal{M}^{++})	\Rightarrow	$(\mu RatM)$
(6.2)		\Leftarrow	
(7.1)	(I_ω)	\Rightarrow	(μAND)
(7.2)		\Leftarrow	

karl-search= End Proposition Ref-Class-Mu-neu

15.0.4 Proposition Ref-Class-Mu-neu Proof

karl-search= Start Proposition Ref-Class-Mu-neu Proof

Proof

(+++*** Orig.: Proof)

(1.1) $(eMT) \Rightarrow (\mu wOR)$:

$X - f(X)$ is small in X , so it is small in $X \cup Y$ by (eMT) , so $A := X \cup Y - (X - f(X)) \in \mathcal{F}(X \cup Y)$, but $A \subseteq f(X) \cup Y$, and $f(X \cup Y)$ is the smallest element of $\mathcal{F}(X \cup Y)$, so $f(X \cup Y) \subseteq A \subseteq f(X) \cup Y$.

(1.2) $(\mu wOR) \Rightarrow (eMT)$:

Let $X \subseteq Y$, $X' := Y - X$. Let $A \in \mathcal{I}(X)$, so $X - A \in \mathcal{F}(X)$, so $f(X) \subseteq X - A$, so $f(X \cup X') \subseteq f(X) \cup X' \subseteq (X - A) \cup X'$ by prerequisite, so $(X \cup X') - ((X - A) \cup X') = A \in \mathcal{I}(X \cup X')$.

(2.1) $(eMT) + (I_\omega) \Rightarrow (\mu OR)$:

$X - f(X)$ is small in X , $Y - f(Y)$ is small in Y , so both are small in $X \cup Y$ by (eMT) , so $A := (X - f(X)) \cup (Y - f(Y))$ is small in $X \cup Y$ by (I_ω) , but $X \cup Y - (f(X) \cup f(Y)) \subseteq A$, so $f(X) \cup f(Y) \in \mathcal{F}(X \cup Y)$, so, as $f(X \cup Y)$ is the smallest element of $\mathcal{F}(X \cup Y)$, $f(X \cup Y) \subseteq f(X) \cup f(Y)$.

(2.2) $(\mu OR) \Rightarrow (eMT) + (I_\omega)$:

Let again $X \subseteq Y$, $X' := Y - X$. Let $A \in \mathcal{I}(X)$, so $X - A \in \mathcal{F}(X)$, so $f(X) \subseteq X - A$. $f(X') \subseteq X'$, so $f(X \cup X') \subseteq f(X) \cup f(X') \subseteq (X - A) \cup X'$ by prerequisite, so $(X \cup X') - ((X - A) \cup X') = A \in \mathcal{I}(X \cup X')$.

(I_ω) holds by definition.

(3.1) $(eMT) + (I_\omega) \Rightarrow (\mu PR)$:

Let $X \subseteq Y$. $Y - f(Y)$ is the largest element of $\mathcal{I}(Y)$, $X - f(X) \in \mathcal{I}(X) \subseteq \mathcal{I}(Y)$ by (eMT) , so $(X - f(X)) \cup (Y - f(Y)) \in \mathcal{I}(Y)$ by (I_ω) , so by "largest" $X - f(X) \subseteq Y - f(Y)$, so $f(Y) \cap X \subseteq f(X)$.

(3.2) $(\mu PR) \Rightarrow (eMT) + (I_\omega)$

Let again $X \subseteq Y$, $X' := Y - X$. Let $A \in \mathcal{I}(X)$, so $X - A \in \mathcal{F}(X)$, so $f(X) \subseteq X - A$, so by prerequisite $f(Y) \cap X \subseteq X - A$, so $f(Y) \subseteq X' \cup (X - A)$, so $(X \cup X') - (X' \cup (X - A)) = A \in \mathcal{I}(Y)$.

Again, (I_ω) holds by definition.

(4.1) $(I \cup disj) \Rightarrow (\mu disjOR)$:

If $X \cap Y = \emptyset$, then (1) $A \in \mathcal{I}(X), B \in \mathcal{I}(Y) \Rightarrow A \cup B \in \mathcal{I}(X \cup Y)$ and (2) $A \in \mathcal{F}(X), B \in \mathcal{F}(Y) \Rightarrow A \cup B \in \mathcal{F}(X \cup Y)$ are equivalent. (By $X \cap Y = \emptyset$, $(X - A) \cup (Y - B) = (X \cup Y) - (A \cup B)$.) So $f(X) \in \mathcal{F}(X)$, $f(Y) \in \mathcal{F}(Y) \Rightarrow$ (by prerequisite) $f(X) \cup f(Y) \in \mathcal{F}(X \cup Y)$. $f(X \cup Y)$ is the smallest element of $\mathcal{F}(X \cup Y)$, so $f(X \cup Y) \subseteq f(X) \cup f(Y)$.

(4.2) $(\mu disjOR) \Rightarrow (I \cup disj)$:

Let $X \subseteq Y$, $X' := Y - X$. Let $A \in \mathcal{I}(X)$, $A' \in \mathcal{I}(X')$, so $X - A \in \mathcal{F}(X)$, $X' - A' \in \mathcal{F}(X')$, so $f(X) \subseteq X - A$, $f(X') \subseteq X' - A'$, so $f(X \cup X') \subseteq f(X) \cup f(X') \subseteq (X - A) \cup (X' - A')$ by prerequisite, so $(X \cup X') - ((X - A) \cup (X' - A')) = A \cup A' \in \mathcal{I}(X \cup X')$.

(5.1) $(\mathcal{M}_\omega^+) \Rightarrow (\mu CM)$:

$f(X) \subseteq Y \subseteq X \Rightarrow X - Y \in \mathcal{I}(X)$, $X - f(X) \in \mathcal{I}(X) \Rightarrow$ (by (\mathcal{M}_ω^+) , (4)) $A := (X - f(X)) - (X - Y) \in \mathcal{I}(Y) \Rightarrow Y - A = f(X) - (X - Y) \in \mathcal{F}(Y) \Rightarrow f(Y) \subseteq f(X) - (X - Y) \subseteq f(X)$.

(5.2) $(\mu CM) \Rightarrow (\mathcal{M}_\omega^+)$

Let $A \in \mathcal{F}(X)$, $B \in \mathcal{I}(X)$, so $f(X) \subseteq X - B \subseteq X$, so by prerequisite $f(X - B) \subseteq f(X)$. As $A \in \mathcal{F}(X)$, $f(X) \subseteq A$, so $f(X - B) \subseteq f(X) \subseteq A \cap (X - B) = A - B$, and $A - B \in \mathcal{F}(X - B)$, so (\mathcal{M}_ω^+) , (5) holds.

(6.1) $(\mathcal{M}^{++}) \Rightarrow (\mu RatM)$:

Let $X \subseteq Y$, $X \cap f(Y) \neq \emptyset$. If $Y - X \in \mathcal{F}(Y)$, then $A := (Y - X) \cap f(Y) \in \mathcal{F}(Y)$, but by $X \cap f(Y) \neq \emptyset$ $A \subset f(Y)$, contradicting "smallest" of $f(Y)$. So $Y - X \notin \mathcal{F}(Y)$, and by (\mathcal{M}^{++}) $X - f(Y) = (Y - f(Y)) - (Y - X) \in \mathcal{I}(X)$, so $X \cap f(Y) \in \mathcal{F}(X)$, so $f(X) \subseteq f(Y) \cap X$.

(6.2) $(\mu RatM) \Rightarrow (\mathcal{M}^{++})$

Let $A \in \mathcal{F}(Y)$, $B \notin \mathcal{F}(Y)$. $B \notin \mathcal{F}(Y) \Rightarrow Y - B \notin \mathcal{I}(Y) \Rightarrow (Y - B) \cap f(Y) \neq \emptyset$. Set $X := Y - B$, so $X \cap f(Y) \neq \emptyset$, $X \subseteq Y$, so $f(X) \subseteq f(Y) \cap X$ by prerequisite. $f(Y) \subseteq A \Rightarrow f(X) \subseteq f(Y) \cap X = f(Y) - B \subseteq A - B$.

(7.1) $(\mathcal{I}_\omega) \Rightarrow (\mu AND)$

Trivial.

(7.2) $(\mu AND) \Rightarrow (\mathcal{I}_\omega)$

Trivial.

□

karl-search= End Proposition Ref-Class-Mu-neu Proof

Fact 15.2

(+++ Orig. No.: Fact i-Rule +++)

LABEL: Fact i-Rule

So (\mathcal{I}_n) is equivalent to the rule:

$$\alpha \sim \beta_1, \dots, \alpha \sim \beta_n \Rightarrow \alpha \not\sim \neg\beta_1 \vee \dots \vee \neg\beta_n.$$

Proof

(+++*** Orig.: Proof)

Let $\alpha \sim \beta_1, \dots, \alpha \sim \beta_n$, so $M(\alpha \wedge (\neg\beta_1 \vee \dots \vee \neg\beta_n)) = M(\alpha \wedge \neg\beta_1) \cup \dots \cup M(\alpha \wedge \neg\beta_n) \neq M(\alpha)$, or $\alpha \not\sim \neg\beta_1 \vee \dots \vee \neg\beta_n$.

The converse is analogue.

□

Fact 15.3

(+++ Orig. No.: Fact i-Reformulation +++)

LABEL: Fact i-Reformulation

(\mathcal{I}_n) can be reformulated to $A_1, \dots, A_{n-1} \in \mathcal{I}(X) \Rightarrow X - (A_1 \cup \dots \cup A_{n-1}) \notin \mathcal{I}(X)$.

This translates then to $\alpha \sim \beta_1, \dots, \alpha \sim \beta_{n-1} \Rightarrow \alpha \not\sim \neg\beta_1 \vee \dots \vee \neg\beta_{n-1}$.

□

16 Strength of (AND)

Fact 16.1

(+++ Orig. No.: Fact i+eM- \mathcal{I} m +++)

LABEL: Fact i+eM- \mathcal{I} m

$(\mathcal{I}_n) + (eMI)$ entail \mathcal{M}_n^+

Proof

(+++*** Orig.: Proof)

By prerequisite, $X_1 \subseteq \dots \subseteq X_n$, and $X_2 - X_1 \in \mathcal{I}(X_2), \dots, X_n - X_{n-1} \in \mathcal{I}(X_n)$, so by (eMI) $X_2 - X_1, \dots, X_n - X_{n-1} \in \mathcal{I}(X_n)$. By (\mathcal{I}_n) $X_n - ((X_n - X_{n-1}) \cup \dots \cup (X_2 - X_1)) = X_1 \in \mathcal{M}^+(X_n)$.

□

Fact 16.2(+++ Orig. No.: Fact i+eM- \mathcal{I} m(3) +++)LABEL: Fact i+eM- \mathcal{I} m $(\mathcal{I}_\omega) + (eMI)$ entail \mathcal{M}_ω^+ (3)**Proof**

(+++*** Orig.: Proof)

 $A \in \mathcal{F}(X) \Rightarrow X - A \in \mathcal{I}(X) \subseteq \mathcal{I}(Y), Y - X \in \mathcal{I}(Y) \Rightarrow Y - A = (Y - X) \cup (X - A) \in \mathcal{I}(Y) \Rightarrow A \in \mathcal{F}(Y). \square$ **Fact 16.3**(+++ Orig. No.: Fact i+em- \mathcal{I} m(4) +++)LABEL: Fact i+em- \mathcal{I} m $(\mathcal{I}_\omega) + (eMF)$ entail \mathcal{M}_ω^+ (4)**Proof**

(+++*** Orig.: Proof)

 $A, B \in \mathcal{I}(X) \Rightarrow A \cup B \in \mathcal{I}(X) \Rightarrow X - (A \cup B) \in \mathcal{F}(X) \Rightarrow (\text{by } (eMF)) X - (A \cup B) \in \mathcal{F}(X-B) \Rightarrow (X - B) - (X - (A \cup B)) = A - B \in \mathcal{I}(X-B). \square$ **Fact 16.4**

(+++ Orig. No.: Fact on omega +++)

LABEL: Fact on omega

First, all versions (\cdot_n) for all $n \in \omega$ hold.

Note that in the following conditions, transitivity is “built in”, so repetition is implicit.

Prove \mathcal{M}_ω^+ from (CUM_ω) and (AND_ω) :(a) (6.1) is equivalent to: $A \in \mathcal{F}(X) \Rightarrow (A \in \mathcal{I}(Y) \Rightarrow X \in \mathcal{I}(Y))$, follows from: $X - A$ is small in X , so in Y , A small in Y , so $X = (X - A) \cup A$ small in Y .(6.2) $B \in \mathcal{I}(X) \Rightarrow (A \in \mathcal{I}(X) \Rightarrow A \in \mathcal{I}(X-B))$ or $B \in \mathcal{I}(X) \Rightarrow (A \in \mathcal{M}^+(X - B) \Rightarrow A \in \mathcal{M}^+(X))$, but $B \in \mathcal{I}(X) \Leftrightarrow X - B \in \mathcal{F}(X)$.**Fact 16.5**

(+++ Orig. No.: Fact em+i +++)

LABEL: Fact em+i

Using (eMI) , we conclude from (\mathcal{I}_n) : $X_1 - B \in \mathcal{I}(X_1), \dots, X_{n-1} - B \in \mathcal{I}(X_{n-1}) \Rightarrow (X_1 - B) \cup \dots \cup (X_{n-1} - B) \notin \mathcal{I}(X_1 \cup \dots \cup X_{n-1})$.This is equivalent to $\alpha_1 \vdash \beta, \dots, \alpha_{n-1} \vdash \beta \Rightarrow \alpha_1 \vee \dots \vee \alpha_{n-1} \not\vdash \neg\beta$. \square **Fact 16.6**

(+++ Orig. No.: Fact Reformulation +++)

LABEL: Fact Reformulation

We reformulate

$(\mathcal{F}_n) : B_1 \in \mathcal{F}(X), \dots, B_n \in \mathcal{F}(X) \Rightarrow B_1 \cap \dots \cap B_n \neq \emptyset$ or $B_1 \cap \dots \cap B_{n-1} \not\subseteq X - B_n$, thus

$\alpha \sim \beta_1, \dots, \alpha \sim \beta_n \Rightarrow \alpha \wedge \beta_1 \wedge \dots \wedge \beta_{n-1} \not\vdash \neg \beta_n$.

Or: $A_1 \in \mathcal{I}(X), \dots, A_{n-1} \in \mathcal{I}(X) \Rightarrow X - (A_1 \cup \dots \cup A_{n-1}) \notin \mathcal{I}(X)$, so by (eMF) (2) $X - (A_1 \cup \dots \cup A_{n-1}) \notin \mathcal{I}(X - (A_1 \cup \dots \cup A_{n-2}))$, thus

$\alpha \sim \beta_1, \dots, \alpha \sim \beta_{n-1} \Rightarrow \alpha \wedge \beta_1 \wedge \dots \wedge \beta_{n-2} \not\vdash \neg \beta_{n-1}$.

(This seems to be the only time we use (2) of (eMF) . Check all proofs of (eMF) if (2) holds, too.)

□

Fact 16.7

(+++ Orig. No.: Fact i+eM- \mathcal{I} Rules +++)

LABEL: Fact i+eM- \mathcal{I} Rules

Let $n \geq 3$.

(1) In the presence of (iM), (eMT) , (eMF) , (AND_n) implies (OR_n) and (CM_n) .

(2) (iM), (eMT) , (eMF) , (OR_n) do not imply (AND_n) .

(3) (iM), (eMT) , (eMF) , (CM_n) do not imply (AND_n) .

Proof

(+++*** Orig.: Proof)

(1)

(2)

Consider

$U := \{1, \dots, n+1\}$, $\mathcal{I}(U) := \{\emptyset\} \cup \{\{i\} : 1 \leq i \leq n\}$,

$X := \{1, \dots, n\}$, $\mathcal{I}(X) := \{\emptyset\} \cup \{\{i\} : 1 \leq i \leq n\}$,

$\mathcal{I}(Y) := \{\emptyset\}$ for all other $Y \subseteq U$.

(AND_n) fails for X , (iM), (eMT) , (eMF) , (OR_n) hold:

(AND_n) fails: trivial.

(iM) holds: trivial.

(eMT) holds: trivial

(eMF) (1) holds: trivial as all big subsets of any Y are either Y or $Y - \{x\}$ for some $x \in Y$, so if $Y - \{x\} \subseteq Y' \subseteq Y$, then $Y - \{x\} = Y'$.

(eMF) (2) holds: If $Y = X$ or $Y = U$, then for $A \subseteq Y$ $A \in \mathcal{M}^+(Y)$ iff A contains at least 2 elements. If $Y \neq X$, $Y \neq U$, then for $A \subseteq Y$ $A \in \mathcal{M}^+(Y)$ iff A is not empty. These properties are inherited downward.

(OR_n) holds: Let $\alpha_1 \sim \beta, \dots, \alpha_{n-1} \sim \beta$, we have to show $\alpha_1 \vee \dots \vee \alpha_{n-1} \not\vdash \neg \beta$. If α_i is neither X nor U , $\alpha_i \sim \beta$ is $\alpha_i \vdash \beta$. So the only exceptions to $\alpha_i \vdash \beta$ can be some $\{i\} : 1 \leq i \leq n$, but there can be only one such i , as otherwise $\alpha_i \wedge \neg \beta$ would be $\{i, i'\}$, which is not small. But α_i contains at least 2 j, j' s.t. $j, j' \in \alpha_i \wedge \beta$, and 2-element sets are not small, so $\alpha_1 \vee \dots \vee \alpha_{n-1} \not\vdash \neg \beta$.

It seems that even (OR_ω) holds.

(3)

Consider

$U := \{1, \dots, n+1\}$, $\mathcal{F}(U) := \{A \subseteq U : n+1 \in A\}$,

$X := \{1, \dots, n\}$, $\mathcal{I}(X) := \{\emptyset\} \cup \{\{i\} : 1 \leq i \leq n\}$,

for all other $Y \subseteq U$ let

$\mathcal{F}(Y) := \{A \subseteq Y : n+1 \in A\}$ if $n+1 \in Y$, and

$\mathcal{F}(Y) := \{Y\}$ if $n+1 \notin Y$.

Thus, (AND_n) fails in X , for all $Y \subseteq U$, $Y \neq X$ ($< \omega * s$) holds, and (iM), (eMT) , (eMF) hold. (CM_n) (2) holds, too:

(AND_n) fails: trivial.

(im) holds: trivial.

(eMT) holds: trivial

(eMF) (1) holds: If $A \subseteq Y' \subseteq Y$ is big in Y , $n+1 \in Y$, then $n+1 \in A$, so $n+1 \in Y'$, and $A \subseteq Y'$ is big. If $A \subseteq Y' \subseteq Y$ is big in Y , $n+1 \notin Y$, then $A = Y'$.

(eMF) (2) holds: If $n+1 \in Y$, then there are no medium size sets. If $Y = X$, then for $A \subseteq Y$ $A \in \mathcal{M}^+(Y)$ iff A contains at least 2 elements. Otherwise, $A \in \mathcal{M}^+(Y)$ iff A is not empty. These properties inherit downwards.

(CM_n) (2) holds:

((CM_n) version (1) fails here.)

Let $\alpha \sim \beta_1, \dots, \alpha \sim \beta_{n-1}$, we have to show $\alpha \wedge \beta_1 \wedge \dots \wedge \beta_{n-2} \not\sim \neg\beta_{n-1}$.

Let α correspond to Y with $n+1 \in Y$. Then $n+1 \in \alpha \wedge \beta_i$ for all i , so $\alpha \wedge \beta_1 \wedge \dots \wedge \beta_{n-2} \sim \beta_{n-1}$.

Let α correspond to $Y \neq X$ with $n+1 \notin Y$. Then $\alpha \sim \beta_i$ is $\alpha \vdash \beta_i$.

Let α correspond to X .

If $\alpha \wedge \beta_1 \wedge \dots \wedge \beta_{n-2}$ still corresponds to $X = \alpha$, then $\alpha \sim \beta_{n-1}$.

If not, $\alpha \wedge \beta_1 \wedge \dots \wedge \beta_{n-2} \sim \neg\beta_{n-1}$ is $\alpha \wedge \beta_1 \wedge \dots \wedge \beta_{n-2} \vdash \neg\beta_{n-1}$. $\alpha \wedge \beta_1 \wedge \dots \wedge \beta_{n-2}$ contains at least 2 elements, and $\alpha \wedge \neg\beta_{n-1}$ at most one element, so $\alpha \wedge \beta_1 \wedge \dots \wedge \beta_{n-2} \vdash \neg\beta_{n-1}$ cannot be.

Does (CM_ω) hold here?

□

Fact 16.8

(+++ Orig. No.: Fact More-Rules +++)

LABEL: Fact More-Rules

(1) In the presence of (iM), (eMT) , (eMF) (AND_ω) imply (OR_ω) , (CM_ω) , (\mathcal{M}_ω^+) .

(2) (iM), (eMT) , (eMF) , (OR_ω) do not imply (AND_ω) .

(3) (iM), (eMT) , (eMF) , (CM_ω) do not imply (AND_ω) .

(4) (iM), (eMT) , (eMF) , (\mathcal{M}_ω^+) do not imply (AND_ω) .

(5) (iM), (eMT) , (eMF) , (OR_ω) , (CM_ω) imply (AND_ω) .

Proof

(+++*** Orig.: Proof)

(5): Let $A, B \subseteq X$ small, then A small in $X-B$, B small in $X-A$, so $A \cup B$ small in $(X-B) \cup (X-A)$.

(CUM_ω) : By (AND_ω) is $\neg\beta \vee \neg\beta'$ small, so $X - (\neg\beta \vee \neg\beta')$ is big in X , thus a fortiori big in $X - (\neg\beta)$. (The argument does not work properly with small sets!)

(OR_ω) : $\alpha \wedge \neg\beta$ is small in α , $\alpha' \wedge \neg\beta$ is small in α' , so a fortiori small in $\alpha \vee \alpha'$. (The argument does not work properly with big sets!)

$A \in \mathcal{F}(X)$, $X \in \mathcal{F}(Y) \Rightarrow A \in \mathcal{M}^+(Y)$ is also weaker, as first small is “diluted”

(\mathcal{M}_ω^+) (6.3): $X - A$ is small in X , so a fortiori in Y .

17 Div.

+++++

17.0.5 Plausibility Logic

karl-search= Start Plausibility Logic

17.1 Plausibility Logic

LABEL: Section Plausibility Logic

17.1.0.1 Discussion of plausibility logic

(+++*** Orig.: Discussion of plausibility logic)

LABEL: Section Discussion of plausibility logic

Plausibility logic was introduced by *D. Lehmann* [Leh92a], [Leh92b] as a sequent calculus in a propositional language without connectives. Thus, a plausibility logic language \mathcal{L} is just a set, whose elements correspond to propositional variables, and a sequent has the form $X \sim Y$, where X, Y are *finite* subsets of \mathcal{L} , thus, in the intuitive reading, $\bigwedge X \sim \bigvee Y$. (We use \sim instead of the \vdash used in [Leh92a], [Leh92b] and continue to reserve \vdash for classical logic.)

17.1.0.2 The details:

(+++*** Orig.: The details:)

LABEL: Section The details:

Notation 17.1

(+++ Orig. No.: Notation Plausi-1 +++)

LABEL: Notation Plausi-1

We abuse notation, and write $X \sim a$ for $X \sim \{a\}$, $X, a \sim Y$ for $X \cup \{a\} \sim Y$, $ab \sim Y$ for $\{a, b\} \sim Y$, etc. When discussing plausibility logic, X, Y , etc. will denote finite subsets of \mathcal{L} , a, b , etc. elements of \mathcal{L} .

We first define the logical properties we will examine.

Definition 17.1

(+++ Orig. No.: Definition Plausi-1 +++)

LABEL: Definition Plausi-1

X and Y will be finite subsets of \mathcal{L} , a , etc. elements of \mathcal{L} . The base axiom and rules of plausibility logic are (we use the prefix “PI” to differentiate them from the usual ones):

(PII) (Inclusion): $X \sim a$ for all $a \in X$,

(PIRM) (Right Monotony): $X \sim Y \Rightarrow X \sim a, Y$,

(PICLM) (Cautious Left Monotony): $X \sim a, X \sim Y \Rightarrow X, a \sim Y$,

(PICC) (Cautious Cut): $X, a_1 \dots a_n \sim Y$, and for all $1 \leq i \leq n$ $X \sim a_i, Y \Rightarrow X \sim Y$,

and as a special case of (PICC):

(PIUCC) (Unit Cautious Cut): $X, a \sim Y, X \sim a, Y \Rightarrow X \sim Y$.

and we denote by PL, for plausibility logic, the full system, i.e. (PII) + (PIRM) + (PICLM) + (PICC).

We now adapt the definition of a preferential model to plausibility logic. This is the central definition on the semantic side.

Definition 17.2

(+++ Orig. No.: Definition Plausi-2 +++)

LABEL: Definition Plausi-2

Fix a plausibility logic language \mathcal{L} . A model for \mathcal{L} is then just an arbitrary subset of \mathcal{L} .

If $\mathcal{M} := \langle M, \prec \rangle$ is a preferential model s.t. M is a set of (indexed) \mathcal{L} -models, then for a finite set $X \subseteq \mathcal{L}$ (to be imagined on the left hand side of $\vdash!$), we define

- (a) $m \models X$ iff $X \subseteq m$
- (b) $M(X) := \{m: \langle m, i \rangle \in M \text{ for some } i \text{ and } m \models X\}$
- (c) $\mu(X) := \{m \in M(X): \exists \langle m, i \rangle \in M. \neg \exists \langle m', i' \rangle \in M (m' \in M(X) \wedge \langle m', i' \rangle \prec \langle m, i \rangle)\}$
- (d) $X \models_{\mathcal{M}} Y$ iff $\forall m \in \mu(X). m \cap Y \neq \emptyset$.

(a) reflects the intuitive reading of X as $\bigwedge X$, and (d) that of Y as $\bigvee Y$ in $X \sim Y$. Note that X is a set of “formulas”, and $\mu(X) = \mu_{\mathcal{M}}(M(X))$.

We note as trivial consequences of the definition.

Fact 17.1

(+++ Orig. No.: Fact Plausi-1 +++)

LABEL: Fact Plausi-1

- (a) $a \models_{\mathcal{M}} b$ iff for all $m \in \mu(a). b \in m$
- (b) $X \models_{\mathcal{M}} Y$ iff $\mu(X) \subseteq \bigcup \{M(b) : b \in Y\}$
- (c) $m \in \mu(X) \wedge X \subseteq X' \wedge m \in M(X') \rightarrow m \in \mu(X')$.

We note without proof: $(PLI) + (PLRM) + (PLCC)$ is complete (and sound) for preferential models

We note the following fact for smooth preferential models:

Fact 17.2

(+++ Orig. No.: Fact Plausi-2 +++)

LABEL: Fact Plausi-2

Let U, X, Y be any sets, \mathcal{M} be smooth for at least $\{Y, X\}$ and let $\mu(Y) \subseteq U \cup X$, $\mu(X) \subseteq U$, then $X \cap Y \cap \mu(U) \subseteq \mu(Y)$. (This is, of course, a special case of $(\mu Cum1)$, see Definition 17.4 (page 148) .

Example 17.1

(+++ Orig. No.: Example Plausi-1 +++)

LABEL: Example Plausi-1

Let $\mathcal{L} := \{a, b, c, d, e, f\}$, and $\mathcal{X} := \{a \sim b, b \sim a, a \sim c, a \sim fd, dc \sim ba, dc \sim e, fcb a \sim e\}$. (fd stands for f, d etc.) Note that, intuitively, left of \sim stands a conjunction, right of \sim a disjunction - in the tradition of sequent calculus notation. We show that \mathcal{X} does not have a smooth representation.

Fact 17.3

(+++ Orig. No.: Fact Plausi-3 +++)

LABEL: Fact Plausi-3

\mathcal{X} does not entail $a \sim e$.

See [Sch96-3] for a proof.

Suppose now that there is a smooth preferential model $\mathcal{M} = \langle M, \prec \rangle$ for plausibility logic which represents \sim , i.e. for all X, Y finite subsets of \mathcal{L} $X \sim Y$ iff $X \models_{\mathcal{M}} Y$. (See Definition 17.2 (page 145) and Fact 17.1 (page 145) .)

$a \vdash a$, $a \vdash b$, $a \vdash c$ implies for $m \in \mu(a)$ $a, b, c \in m$. Moreover, as $a \vdash df$, then also $d \in m$ or $f \in m$. As $a \not\vdash e$, there must be $m \in \mu(a)$ s.t. $e \notin m$. Suppose now $m \in \mu(a)$ with $f \in m$. So $a, b, c, f \in m$, thus by $m \in \mu(a)$ and Fact 17.1 (page 145) , $m \in \mu(a, b, c, f)$. But $fcb a \vdash e$, so $e \in m$. We thus have shown that $m \in \mu(a)$ and $f \in m$ implies $e \in m$. Consequently, there must be $m \in \mu(a)$ s.t. $d \in m$, $e \notin m$. Thus, in particular, as $cd \vdash e$, there is $m \in \mu(a)$, $a, b, c, d \in m$, $m \notin \mu(cd)$. But by $cd \vdash ab$, and $b \vdash a$, $\mu(cd) \subseteq M(a) \cup M(b)$ and $\mu(b) \subseteq M(a)$ by Fact 17.1 (page 145) . Let now $T := M(cd)$, $R := M(a)$, $S := M(b)$, and $\mu_{\mathcal{M}}$ be the choice function of the minimal elements in the structure \mathcal{M} , we then have by $\mu(S) = \mu_{\mathcal{M}}(M(S))$:

1. $\mu_{\mathcal{M}}(T) \subseteq R \cup S$,
2. $\mu_{\mathcal{M}}(S) \subseteq R$,
3. there is $m \in S \cap T \cap \mu_{\mathcal{M}}(R)$, but $m \notin \mu_{\mathcal{M}}(T)$,

but this contradicts above Fact 17.2 (page 145) .

karl-search= End Plausibility Logic

17.1.1 Arieli-Avron

karl-search= Start Arieli-Avron

17.2 A comment on work by Arieli and Avron

LABEL: Section Arieli-Avron

We turn to a similar case, published in [AA00]. Definitions are due to [AA00], for motivation the reader is referred there.

We follow here the convention of Arieli and Avron and use upper-case Greek letters for sets of formulae. At the same time this different notation should remind the reader that sets of formulae are read as conjunctions on the left of \vdash , and as disjunctions on the right of \vdash .

Definition 17.3

(+++ Orig. No.: Definition Arieli-Avron-1 +++)

LABEL: Definition Arieli-Avron-1

(1) A Scott consequence relation, abbreviated scr, is a binary relation \vdash between sets of formulae, that satisfies the following conditions:

(s-R) if $\Gamma \cap \Delta \neq \emptyset$, the $\Gamma \vdash \Delta$ (M) if $\Gamma \vdash \Delta$ and $\Gamma \subseteq \Gamma'$, $\Delta \subseteq \Delta'$, then $\Gamma' \vdash \Delta'$ (C) if $\Gamma \vdash \psi, \Delta$ and $\Gamma', \psi \vdash \Delta'$, then $\Gamma, \Gamma' \vdash \Delta, \Delta'$

(2) A Scott cautious consequence relation, abbreviated sscr, is a binary relation \vdash between nonempty sets of formulae, that satisfies the following conditions:

(s-R) if $\Gamma \cap \Delta \neq \emptyset$, the $\Gamma \vdash \Delta$ (CM) if $\Gamma \vdash \Delta$ and $\Gamma \vdash \psi$, then $\Gamma, \psi \vdash \Delta$ (CC) if $\Gamma \vdash \psi$ and $\Gamma, \psi \vdash \Delta$, then $\Gamma \vdash \Delta$.

Example 17.2

(+++ Orig. No.: Example Arieli-Avron-1 +++)

LABEL: Example Arieli-Avron-1

We have two consequence relations, \vdash and \vdash .

The rules to consider are

$$LCC^n \frac{\Gamma \sim \psi_1, \Delta \dots \Gamma \sim \psi_n, \Delta \Gamma, \psi_1, \dots, \psi_n \sim \Delta}{\Gamma \sim \Delta}$$

$$RW^n \frac{\Gamma \sim \psi_i, \Delta_i=1 \dots n \Gamma, \psi_1, \dots, \psi_n \vdash \phi}{\Gamma \sim \phi, \Delta}$$

Cum $\Gamma, \Delta \neq \emptyset, \Gamma \vdash \Delta \rightarrow \Gamma \sim \Delta$

RM $\Gamma \sim \Delta \rightarrow \Gamma \sim \psi, \Delta$

$$CM \frac{\Gamma \sim \psi \Gamma \sim \Delta}{\Gamma, \psi \sim \Delta}$$

$s-R$ $\Gamma \cap \Delta \neq \emptyset \rightarrow \Gamma \sim \Delta$

M $\Gamma \vdash \Delta, \Gamma \subseteq \Gamma', \Delta \subseteq \Delta' \rightarrow \Gamma' \vdash \Delta'$

$$C \frac{\Gamma_1 \vdash \psi, \Delta_1 \Gamma_2, \psi \vdash \Delta_2}{\Gamma_1, \Gamma_2 \vdash \Delta_1, \Delta_2}$$

Let \mathcal{L} be any set. Define now $\Gamma \vdash \Delta$ iff $\Gamma \cap \Delta \neq \emptyset$. Then $s-R$ and M for \vdash are trivial. For C : If $\Gamma_1 \cap \Delta_1 \neq \emptyset$ or $\Gamma_1 \cap \Delta_1 \neq \emptyset$, the result is trivial. If not, $\psi \in \Gamma_1$ and $\psi \in \Delta_2$, which implies the result. So \vdash is a scr.

Consider now the rules for a sscr which is \vdash -plausible for this \vdash . Cum is equivalent to $s-R$, which is essentially (PII) of Plausibility Logic. Consider RW^n . If ϕ is one of the ψ_i , then the consequence $\Gamma \sim \phi, \Delta$ is a case of one of the other hypotheses. If not, $\phi \in \Gamma$, so $\Gamma \sim \phi$ by $s-R$, so $\Gamma \sim \phi, \Delta$ by RM (if Δ is finite). So, for this \vdash , RW^n is a consequence of $s-R + RM$.

We are left with LCC^n , RM, CM, $s-R$, it was shown in [Sch04] and [Sch96-3] that this does not suffice to guarantee smooth representability, by failure of ($\mu Cum1$) - see Definition 17.4 (page 148) .

karl-search= End Arieli-Avron

+++++

17.2.1 Comment Cum-Union

karl-search= Start Comment Cum-Union

Comment 17.1

(+++ Orig. No.: Comment Cum-Union +++)

LABEL: Comment Cum-Union

We show here that, without sufficient closure properties, there is an infinity of versions of cumulativity, which collapse to usual cumulativity when the domain is closed under finite unions. Closure properties thus reveal themselves as a powerful tool to show independence of properties.

We work in some fixed arbitrary set Z , all sets considered will be subsets of Z .

Unless said otherwise, we use without further mentioning (μPR) and ($\mu \subseteq$).

karl-search= End Comment Cum-Union

17.2.2 Definition Cum-Alpha

karl-search= Start Definition Cum-Alpha

Definition 17.4

(+++ Orig. No.: Definition Cum-Alpha +++)

LABEL: Definition Cum-Alpha

For any ordinal α , we define

$(\mu Cum \alpha)$:

If for all $\beta \leq \alpha$ $\mu(X_\beta) \subseteq U \cup \bigcup \{X_\gamma : \gamma < \beta\}$ hold, then so does $\bigcap \{X_\gamma : \gamma \leq \alpha\} \cap \mu(U) \subseteq \mu(X_\alpha)$.

$(\mu Cumt \alpha)$:

If for all $\beta \leq \alpha$ $\mu(X_\beta) \subseteq U \cup \bigcup \{X_\gamma : \gamma < \beta\}$ hold, then so does $X_\alpha \cap \mu(U) \subseteq \mu(X_\alpha)$.

(“ t ” stands for transitive, see Fact 17.4 (page 153) , (2.2) below.)

$(\mu Cum \infty)$ and $(\mu Cumt \infty)$ will be the class of all $(\mu Cum \alpha)$ or $(\mu Cumt \alpha)$ - read their “conjunction”, i.e. if we say that $(\mu Cum \infty)$ holds, we mean that all $(\mu Cum \alpha)$ hold.

karl-search= End Definition Cum-Alpha

17.2.3 Note Cum-Alpha

karl-search= Start Note Cum-Alpha

17.2.3.1 Note

(+++*** Orig.: Note)

LABEL: Section Note

The first conditions thus have the form:

$(\mu Cum 0)$ $\mu(X_0) \subseteq U \rightarrow X_0 \cap \mu(U) \subseteq \mu(X_0)$,

$(\mu Cum 1)$ $\mu(X_0) \subseteq U, \mu(X_1) \subseteq U \cup X_0 \rightarrow X_0 \cap X_1 \cap \mu(U) \subseteq \mu(X_1)$,

$(\mu Cum 2)$ $\mu(X_0) \subseteq U, \mu(X_1) \subseteq U \cup X_0, \mu(X_2) \subseteq U \cup X_0 \cup X_1 \rightarrow X_0 \cap X_1 \cap X_2 \cap \mu(U) \subseteq \mu(X_2)$.

$(\mu Cumt \alpha)$ differs from $(\mu Cum \alpha)$ only in the consequence, the intersection contains only the last X_α - in particular, $(\mu Cum 0)$ and $(\mu Cumt 0)$ coincide.

Recall that condition $(\mu Cum 1)$ is the crucial condition in [Leh92a], which failed, despite (μCUM) , but which has to hold in all smooth models. This condition $(\mu Cum 1)$ was the starting point of the investigation.

We briefly mention some major results on above conditions, taken from Fact 17.4 (page 153) and shown there - we use the same numbering:

(1.1) $(\mu Cum \alpha) \rightarrow (\mu Cum \beta)$ for all $\beta \leq \alpha$

(1.2) $(\mu Cumt \alpha) \rightarrow (\mu Cumt \beta)$ for all $\beta \leq \alpha$

(2.1) All $(\mu Cum \alpha)$ hold in smooth preferential structures

(2.2) All $(\mu Cumt \alpha)$ hold in transitive smooth preferential structures

(3.1) $(\mu Cum \beta) + (\cup) \rightarrow (\mu Cum \alpha)$ for all $\beta \leq \alpha$

(3.2) $(\mu Cumt \beta) + (\cup) \rightarrow (\mu Cumt \alpha)$ for all $\beta \leq \alpha$

(5.2) $(\mu Cum \alpha) \rightarrow (\mu CUM)$ for all α

(5.3) $(\mu CUM) + (\cup) \rightarrow (\mu Cum \alpha)$ for all α

karl-search= End Note Cum-Alpha

17.2.4 Definition HU-All

karl-search= Start Definition HU-All

The following inductive definition of $H(U, u)$ and of the property (HU, u) concerns closure under $(\mu Cum \infty)$, its main property is formulated in Fact 17.7 (page 157) , its main interest is its use in the proof of Proposition D-4.4.6.

Definition 17.5

(+++ Orig. No.: Definition HU-All +++)

LABEL: Definition HU-All

$(H(U, u)_\alpha, H(U)_\alpha, (HU, u), (HU).)$

$H(U, u)_0 := U,$

$H(U, u)_{\alpha+1} := H(U, u)_\alpha \cup \bigcup \{X : u \in X \wedge \mu(X) \subseteq H(U, u)_\alpha\},$

$H(U, u)_\lambda := \bigcup \{H(U, u)_\alpha : \alpha < \lambda\}$ for $limit(\lambda),$

$H(U, u) := \bigcup \{H(U, u)_\alpha : \alpha < \kappa\}$ for κ sufficiently big ($card(Z)$ suffices, as the procedure trivializes, when we cannot add any new elements).

(HU, u) is the property:

$u \in \mu(U), u \in Y - \mu(Y) \rightarrow \mu(Y) \not\subseteq H(U, u)$ - of course for all u and $U. (U, Y \in \mathcal{Y}).$

For the case with $(\cup),$ we further define, independent of $u,$

$H(U)_0 := U,$

$H(U)_{\alpha+1} := H(U)_\alpha \cup \bigcup \{X : \mu(X) \subseteq H(U)_\alpha\},$

$H(U)_\lambda := \bigcup \{H(U)_\alpha : \alpha < \lambda\}$ for $limit(\lambda),$

$H(U) := \bigcup \{H(U)_\alpha : \alpha < \kappa\}$ again for κ sufficiently big

(HU) is the property:

$u \in \mu(U), u \in Y - \mu(Y) \rightarrow \mu(Y) \not\subseteq H(U)$ - of course for all $U. (U, Y \in \mathcal{Y}).$

Obviously, $H(U, u) \subseteq H(U),$ so $(HU) \rightarrow (HU, u).$

karl-search= End Definition HU-All

17.2.5 Definition St-Tree

karl-search= Start Definition St-Tree

Definition 17.6

(+++ Orig. No.: Definition St-Tree +++)

LABEL: Definition St-Tree

$(ST\text{-trees and } (\mu ST))$

Let $u \in \mu(U).$

A tree t (of height $\leq \omega$) is an ST-tree for $\langle u, U \rangle$ iff

(1) the nodes are pairs $\langle x, X \rangle$ s.t. $x \in \mu(X)$

(2) Level 0:

$\langle u, U \rangle$ is the root.

(3) Level $n \rightarrow n + 1$

Let $\langle x_n, X_n \rangle$ be at level n (so $x_n \in \mu(X_n)$).

(3.1) For all $X_{n+1} \in \mathcal{Y}$ s.t. $x_n \in X_{n+1} - \mu(X_{n+1})$ there is a successor $\langle x_{n+1}, X_{n+1} \rangle$ of $\langle x_n, X_n \rangle$ in t with $x_{n+1} \in \mu(X_{n+1})$ and $x_{n+1} \notin H(X_n, x_n)$ and for all predecessors $\langle x', X' \rangle$ of $\langle x_n, X_n \rangle$ also $x_{n+1} \notin H(X', x')$.

(3.2) For all $X_{n+1} \in \mathcal{Y}$ s.t. $x_n \in \mu(X_{n+1})$ and s.t. there is a successor $\langle x'_{n+1}, X'_{n+1} \rangle$ of $\langle x_n, X_n \rangle$ in t with $x'_{n+1} \in X_{n+1} - \mu(X_{n+1})$ there is a successor $\langle x_{n+1}, X_{n+1} \rangle$ of $\langle x_n, X_n \rangle$ in t with $x_{n+1} \in \mu(X_{n+1})$ and $x_{n+1} \notin H(X_n, x_n)$ and for all predecessors $\langle x', X' \rangle$ of $\langle x_n, X_n \rangle$ also $x_{n+1} \notin H(X', x')$.

Finally (μST) is the condition:

For all $U \in \mathcal{Y}$, $u \in \mu(U)$ there is an ST-tree for $\langle u, U \rangle$.

karl-search= End Definition St-Tree

17.2.6 Example Inf-Cum-Alpha

karl-search= Start Example Inf-Cum-Alpha

Example 17.3

(+++ Orig. No.: Example Inf-Cum-Alpha +++)

LABEL: Example Inf-Cum-Alpha

This important example shows that the conditions $(\mu Cum\alpha)$ and $(\mu Cumt\alpha)$ defined in Definition 17.4 (page 148) are all different in the absence of (\cup) , in its presence they all collapse (see Fact 17.4 (page 153) below). More precisely, the following (class of) examples shows that the $(\mu Cum\alpha)$ increase in strength. For any finite or infinite ordinal $\kappa > 0$ we construct an example s.t.

- (a) (μPR) and $(\mu \subseteq)$ hold
- (b) (μCUM) holds
- (c) (\cap) holds
- (d) $(\mu Cumt\alpha)$ holds for $\alpha < \kappa$
- (e) $(\mu Cum\kappa)$ fails.

Proof

(+++*** Orig.: Proof)

We define a suitable base set and a non-transitive binary relation \prec on this set, as well as a suitable set \mathcal{X} of subsets, closed under arbitrary intersections, but not under finite unions, and define μ on these subsets as usual in preferential structures by \prec . Thus, (μPR) and $(\mu \subseteq)$ will hold. It will be immediate that $(\mu Cum\kappa)$ fails, and we will show that (μCUM) and $(\mu Cumt\alpha)$ for $\alpha < \kappa$ hold by examining the cases.

For simplicity, we first define a set of generators for \mathcal{X} , and close under (\cap) afterwards. The set U will have a special position, it is the “useful” starting point to construct chains corresponding to above definitions of $(\mu Cum\alpha)$ and $(\mu Cumt\alpha)$.

In the sequel, i, j will be successor ordinals, λ etc. limit ordinals, α, β, κ any ordinals, thus e.g. $\lambda \leq \kappa$ will imply that λ is a limit ordinal $\leq \kappa$, etc.

17.2.6.1 The base set and the relation \prec :

(+++*** Orig.: The base set and the relation b:)

LABEL: Section The base set and the relation b:

$\kappa > 0$ is fixed, but arbitrary. We go up to $\kappa > 0$.

The base set is $\{a, b, c\} \cup \{d_\lambda : \lambda \leq \kappa\} \cup \{x_\alpha : \alpha \leq \kappa + 1\} \cup \{x'_\alpha : \alpha \leq \kappa\}$. $a \prec b \prec c$, $x_\alpha \prec x_{\alpha+1}$, $x_\alpha \prec x'_\alpha$, $x'_0 \prec x_\lambda$ (for any λ) - \prec is NOT transitive.

17.2.6.2 The generators:

(+++*** Orig.: The generators:)

LABEL: Section The generators:

$U := \{a, c, x_0\} \cup \{d_\lambda : \lambda \leq \kappa\}$ - i.e. $\dots \{d_\lambda : \text{lim}(\lambda) \wedge \lambda \leq \kappa\}$,

$X_i := \{c, x_i, x'_i, x_{i+1}\}$ ($i < \kappa$),

$X_\lambda := \{c, d_\lambda, x_\lambda, x'_\lambda, x_{\lambda+1}\} \cup \{x'_\alpha : \alpha < \lambda\}$ ($\lambda < \kappa$),

$X'_\kappa := \{a, b, c, x_\kappa, x'_\kappa, x_{\kappa+1}\}$ if κ is a successor,

$X'_\kappa := \{a, b, c, d_\kappa, x_\kappa, x'_\kappa, x_{\kappa+1}\} \cup \{x'_\alpha : \alpha < \kappa\}$ if κ is a limit.

Thus, $X'_\kappa = X_\kappa \cup \{a, b\}$ if X_κ were defined.

Note that there is only one X'_κ , and X_α is defined only for $\alpha < \kappa$, so we will not have X_α and X'_α at the same time.

Thus, the values of the generators under μ are:

$\mu(U) = U$,

$\mu(X_i) = \{c, x_i\}$,

$\mu(X_\lambda) = \{c, d_\lambda\} \cup \{x'_\alpha : \alpha < \lambda\}$,

$\mu(X'_i) = \{a, x_i\}$ ($i > 0$, i has to be a successor),

$\mu(X'_\lambda) = \{a, d_\lambda\} \cup \{x'_\alpha : \alpha < \lambda\}$.

(We do not assume that the domain is closed under μ .)

17.2.6.3 Intersections:

(+++*** Orig.: Intersections:)

LABEL: Section Intersections:

We consider first pairwise intersections:

(1) $U \cap X_0 = \{c, x_0\}$,

(2) $U \cap X_i = \{c\}$, $i > 0$,

(3) $U \cap X_\lambda = \{c, d_\lambda\}$,

(4) $U \cap X'_i = \{a, c\}$ ($i > 0$),

(5) $U \cap X'_\lambda = \{a, c, d_\lambda\}$,

(6) $X_i \cap X_j$:

(6.1) $j = i + 1$ $\{c, x_{i+1}\}$,

(6.2) else $\{c\}$,

(7) $X_i \cap X_\lambda$:

(7.1) $i < \lambda$ $\{c, x'_i\}$,

(7.2) $i = \lambda + 1$ $\{c, x_{\lambda+1}\}$,

(7.3) $i > \lambda + 1$ $\{c\}$,

(8) $X_\lambda \cap X_{\lambda'}$: $\{c\} \cup \{x'_\alpha : \alpha \leq \min(\lambda, \lambda')\}$.

As X'_κ occurs only once, $X_\alpha \cap X'_\kappa$ etc. give no new results.

Note that μ is constant on all these pairwise intersections.

Iterated intersections:

As c is an element of all sets, sets of the type $\{c, z\}$ do not give any new results. The possible subsets of $\{a, c, d_\lambda\} : \{c\}, \{a, c\}, \{c, d_\lambda\}$ exist already. Thus, the only source of new sets via iterated intersections is $X_\lambda \cap X_{\lambda'} = \{c\} \cup \{x'_\alpha : \alpha \leq \min(\lambda, \lambda')\}$. But, to intersect them, or with some old sets, will not generate any new sets either. Consequently, the example satisfies (\cap) for \mathcal{X} defined by $U, X_i (i < \kappa), X_\lambda (\lambda < \kappa), X'_\kappa$, and above pairwise intersections.

We will now verify the positive properties. This is tedious, but straightforward, we have to check the different cases.

17.2.6.4 Validity of (μCUM) :

(+++*** Orig.: Validity of (mCUM):)

LABEL: Section Validity of (mCUM):

Consider the prerequisite $\mu(X) \subseteq Y \subseteq X$. If $\mu(X) = X$ or if $X - \mu(X)$ is a singleton, X cannot give a violation of (μCUM) . So we are left with the following candidates for X :

$$(1) X_i := \{c, x_i, x'_i, x_{i+1}\}, \mu(X_i) = \{c, x_i\}$$

Interesting candidates for Y will have 3 elements, but they will all contain a. (If $\kappa < \omega : U = \{a, c, x_0\}$.)

$$(2) X_\lambda := \{c, d_\lambda, x_\lambda, x'_\lambda, x_{\lambda+1}\} \cup \{x'_\alpha : \alpha < \lambda\}, \mu(X_\lambda) = \{c, d_\lambda\} \cup \{x'_\alpha : \alpha < \lambda\}$$

The only sets to contain d_λ are $X_\lambda, U, U \cap X_\lambda$. But $a \in U$, and $U \cap X_\lambda$ is finite. (X_λ and X'_λ cannot be present at the same time.)

$$(3) X'_i := \{a, b, c, x_i, x'_i, x_{i+1}\}, \mu(X'_i) = \{a, x_i\}$$

a is only in $U, X'_i, U \cap X'_i = \{a, c\}$, but $x_i \notin U$, as $i > 0$.

$$(4) X'_\lambda := \{a, b, c, d_\lambda, x_\lambda, x'_\lambda, x_{\lambda+1}\} \cup \{x'_\alpha : \alpha < \lambda\}, \mu(X'_\lambda) = \{a, d_\lambda\} \cup \{x'_\alpha : \alpha < \lambda\}$$

d_λ is only in X'_λ and U , but U contains no x'_α .

Thus, (μCUM) holds trivially.

17.2.6.5 $(\mu Cumt\alpha)$ hold for $\alpha < \kappa$:

(+++*** Orig.: (mCumt a) hold for a_j k:)

LABEL: Section (mCumt a) hold for a_j k:

To simplify language, we say that we reach Y from X iff $X \neq Y$ and there is a sequence $X_\beta, \beta \leq \alpha$ and $\mu(X_\beta) \subseteq X \cup \bigcup \{X_\gamma : \gamma < \beta\}$, and $X_\alpha = Y, X_0 = X$. Failure of $(\mu Cumt\alpha)$ would then mean that there are X and Y , we can reach Y from X , and $x \in (\mu(X) \cap Y) - \mu(Y)$. Thus, in a counterexample, $Y = \mu(Y)$ is impossible, so none of the intersections can be such Y .

To reach Y from X , we have to get started from X , i.e. there must be Z s.t. $\mu(Z) \subseteq X, Z \not\subseteq X$ (so $\mu(Z) \neq Z$). Inspection of the different cases shows that we cannot reach any set Y from any case of the intersections, except from (1), (6.1), (7.2).

If Y contains a globally minimal element (i.e. there is no smaller element in any set), it can only be reached from any X which already contains this element. The globally minimal elements are a, x_0 , and the $d_\lambda, \lambda \leq \kappa$.

By these observations, we see that X_λ and X'_κ can only be reached from U . From no X_α U can be reached, as the globally minimal a is missing. But U cannot be reached from X'_κ either, as the globally minimal x_0 is missing.

When we look at the relation \prec defining μ , we see that we can reach Y from X only by going upwards, adding bigger elements. Thus, from X_α , we cannot reach any $X_\beta, \beta < \alpha$, the same holds for X'_κ and $X_\beta, \beta < \kappa$. Thus, from X'_κ , we cannot go anywhere interesting (recall that the intersections are not candidates for a Y giving a contradiction).

Consider now X_α . We can go up to any $X_{\alpha+n}$, but not to any $X_\lambda, \alpha < \lambda$, as d_λ is missing, neither to X'_κ , as a is missing. And we will be stopped by the first $\lambda > \alpha$, as x_λ will be missing to go beyond X_λ . Analogous observations hold for the remaining intersections (1), (6.1), (7.2). But in all these sets we can reach, we will not destroy minimality of any element of X_α (or of the intersections).

Consequently, the only candidates for failure will all start with U . As the only element of U not globally minimal

is c , such failure has to have $c \in Y - \mu(Y)$, so Y has to be X'_κ . Suppose we omit one of the X_α in the sequence going up to X'_κ . If $\kappa \geq \lambda > \alpha$, we cannot reach X_λ and beyond, as x'_α will be missing. But we cannot go to $X_{\alpha+n}$ either, as $x_{\alpha+1}$ is missing. So we will be stopped at X_α . Thus, to see failure, we need the full sequence $U = X_0, X'_\kappa = Y_\kappa, Y_\alpha = X_\alpha$ for $0 < \alpha < \kappa$.

17.2.6.6 ($\mu Cum \kappa$) fails:

(+++*** Orig.: (mCum k) fails:)

LABEL: Section (mCum k) fails:

The full sequence $U = X_0, X'_\kappa = Y_\kappa, Y_\alpha = X_\alpha$ for $0 < \alpha < \kappa$ shows this, as $c \in \mu(U) \cap X'_\kappa$, but $c \notin \mu(X'_\kappa)$.

Consequently, the example satisfies (\bigcap) , (μCUM) , $(\mu Cumt\alpha)$ for $\alpha < \kappa$, and $(\mu Cum \kappa)$ fails.

□

karl-search= End Example Inf-Cum-Alpha

17.2.7 Fact Cum-Alpha

karl-search= Start Fact Cum-Alpha

Fact 17.4

(+++ Orig. No.: Fact Cum-Alpha +++)

LABEL: Fact Cum-Alpha

We summarize some properties of $(\mu Cum\alpha)$ and $(\mu Cumt\alpha)$ - sometimes with some redundancy. Unless said otherwise, α, β etc. will be arbitrary ordinals.

For (1) to (6) (μPR) and $(\mu \subseteq)$ are assumed to hold, for (7) only $(\mu \subseteq)$.

(1) Downward:

(1.1) $(\mu Cum\alpha) \rightarrow (\mu Cum\beta)$ for all $\beta \leq \alpha$

(1.2) $(\mu Cumt\alpha) \rightarrow (\mu Cumt\beta)$ for all $\beta \leq \alpha$

(2) Validity of $(\mu Cum\alpha)$ and $(\mu Cumt\alpha)$:

(2.1) All $(\mu Cum\alpha)$ hold in smooth preferential structures

(2.2) All $(\mu Cumt\alpha)$ hold in transitive smooth preferential structures

(2.3) $(\mu Cumt\alpha)$ for $0 < \alpha$ do not necessarily hold in smooth structures without transitivity, even in the presence of (\bigcap)

(3) Upward:

(3.1) $(\mu Cum\beta) + (\cup) \rightarrow (\mu Cum\alpha)$ for all $\beta \leq \alpha$

(3.2) $(\mu Cumt\beta) + (\cup) \rightarrow (\mu Cumt\alpha)$ for all $\beta \leq \alpha$

(3.3) $\{(\mu Cumt\beta) : \beta < \alpha\} + (\mu CUM) + (\bigcap) \not\rightarrow (\mu Cum\alpha)$ for $\alpha > 0$.

(4) Connection $(\mu Cum\alpha)/(\mu Cumt\alpha)$:

(4.1) $(\mu Cumt\alpha) \rightarrow (\mu Cum\alpha)$

(4.2) $(\mu Cum\alpha) + (\bigcap) \not\rightarrow (\mu Cumt\alpha)$

(4.3) $(\mu Cum\alpha) + (\cup) \rightarrow (\mu Cumt\alpha)$

(5) (μCUM) and $(\mu Cum i)$:

(5.1) $(\mu CUM) + (\cup)$ entail:

(5.1.1) $\mu(A) \subseteq B \rightarrow \mu(A \cup B) = \mu(B)$

(5.1.2) $\mu(X) \subseteq U, U \subseteq Y \rightarrow \mu(Y \cup X) = \mu(Y)$

(5.1.3) $\mu(X) \subseteq U, U \subseteq Y \rightarrow \mu(Y) \cap X \subseteq \mu(U)$

(5.2) $(\mu Cum\alpha) \rightarrow (\mu CUM)$ for all α

(5.3) $(\mu CUM) + (\cup) \rightarrow (\mu Cum\alpha)$ for all α

(5.4) $(\mu CUM) + (\cap) \rightarrow (\mu Cum0)$

(6) (μCUM) and $(\mu Cumt\alpha)$:

(6.1) $(\mu Cumt\alpha) \rightarrow (\mu CUM)$ for all α

(6.2) $(\mu CUM) + (\cup) \rightarrow (\mu Cumt\alpha)$ for all α

(6.3) $(\mu CUM) \not\rightarrow (\mu Cumt\alpha)$ for all $\alpha > 0$

(7) $(\mu Cum0) \rightarrow (\mu PR)$

karl-search= End Fact Cum-Alpha

17.2.8 Fact Cum-Alpha Proof

karl-search= Start Fact Cum-Alpha Proof

Proof

(+++*** Orig.: Proof)

We prove these facts in a different order: (1), (2), (5.1), (5.2), (4.1), (6.1), (6.2), (5.3), (3.1), (3.2), (4.2), (4.3), (5.4), (3.3), (6.3), (7).

(1.1)

For $\beta < \gamma \leq \alpha$ set $X_\gamma := X_\beta$. Let the prerequisites of $(\mu Cum\beta)$ hold. Then for γ with $\beta < \gamma \leq \alpha$ $\mu(X_\gamma) \subseteq X_\beta$ by $(\mu \subseteq)$, so the prerequisites of $(\mu Cum\alpha)$ hold, too, so by $(\mu Cum\alpha) \cap \{X_\delta : \delta \leq \beta\} \cap \mu(U) = \cap \{X_\delta : \delta \leq \alpha\} \cap \mu(U) \subseteq \mu(X_\alpha) = \mu(X_\beta)$.

(1.2)

Analogous.

(2.1)

Proof by induction.

$(\mu Cum0)$ Let $\mu(X_0) \subseteq U$, suppose there is $x \in \mu(U) \cap (X_0 - \mu(X_0))$. By smoothness, there is $y \prec x$, $y \in \mu(X_0) \subseteq U$, *contradiction* (The same arguments works for copies: all copies of x must be minimized by some $y \in \mu(X_0)$, but at least one copy of x has to be minimal in U .)

Suppose $(\mu Cum\beta)$ hold for all $\beta < \alpha$. We show $(\mu Cum\alpha)$. Let the prerequisites of $(\mu Cum\alpha)$ hold, then those for $(\mu Cum\beta)$, $\beta < \alpha$ hold, too. Suppose there is $x \in \mu(U) \cap \cap \{X_\gamma : \gamma \leq \alpha\} - \mu(X_\alpha)$. So by $(\mu Cum\beta)$ for $\beta < \alpha$ $x \in \mu(X_\beta)$ moreover $x \in \mu(U)$. By smoothness, there is $y \in \mu(X_\alpha) \subseteq U \cup \cup \{X_\beta : \beta < \alpha\}$, $y \prec x$, but this is a contradiction. The same argument works again for copies.

(2.2)

We use the following Fact: Let, in a smooth transitive structure, $\mu(X_\beta) \subseteq U \cup \cup \{X_\gamma : \gamma < \beta\}$ for all $\beta \leq \alpha$, and let $x \in \mu(U)$. Then there is no $y \prec x$, $y \in U \cup \cup \{X_\gamma : \gamma \leq \alpha\}$.

Proof of the Fact by induction: $\alpha = 0$: $y \in U$ is impossible: if $y \in X_0$, then if $y \in \mu(X_0) \subseteq U$, which is impossible, or there is $z \in \mu(X_0)$, $z \prec y$, so $z \prec x$ by transitivity, but $\mu(X_0) \subseteq U$. Let the result hold for all

$\beta < \alpha$, but fail for α , so $\neg \exists y \prec x.y \in U \cup \bigcup \{X_\gamma : \gamma < \alpha\}$, but $\exists y \prec x.y \in U \cup \bigcup \{X_\gamma : \gamma \leq \alpha\}$, so $y \in X_\alpha$. If $y \in \mu(X_\alpha)$, then $y \in U \cup \bigcup \{X_\gamma : \gamma < \alpha\}$, but this is impossible, so $y \in X_\alpha - \mu(X_\alpha)$, let by smoothness $z \prec y$, $z \in \mu(X_\alpha)$, so by transitivity $z \prec x$, *contradiction*. The result is easily modified for the case with copies.

Let the prerequisites of $(\mu Cumt\alpha)$ hold, then those of the Fact will hold, too. Let now $x \in \mu(U) \cap (X_\alpha - \mu(X_\alpha))$, by smoothness, there must be $y \prec x$, $y \in \mu(X_\alpha) \subseteq U \cup \bigcup \{X_\gamma : \gamma < \alpha\}$, contradicting the Fact.

(2.3)

Let $\alpha > 0$, and consider the following structure over $\{a, b, c\} : U := \{a, c\}$, $X_0 := \{b, c\}$, $X_\alpha := \dots := X_1 := \{a, b\}$, and their intersections, $\{a\}$, $\{b\}$, $\{c\}$, \emptyset with the order $c \prec b \prec a$ (without transitivity). This is preferential, so (μPR) and $(\mu \subseteq)$ hold. The structure is smooth for U , all X_β , and their intersections. We have $\mu(X_0) \subseteq U$, $\mu(X_\beta) \subseteq U \cup X_0$ for all $\beta \leq \alpha$, so $\mu(X_\beta) \subseteq U \cup \bigcup \{X_\gamma : \gamma < \beta\}$ for all $\beta \leq \alpha$ but $X_\alpha \cap \mu(U) = \{a\} \not\subseteq \{b\} = \mu(X_\alpha)$ for $\alpha > 0$.

(5.1)

$$(5.1.1) \quad \mu(A) \subseteq B \rightarrow \mu(A \cup B) \subseteq \mu(A) \cup \mu(B) \subseteq B \rightarrow_{(\mu CUM)} \mu(B) = \mu(A \cup B).$$

$$(5.1.2) \quad \mu(X) \subseteq U \subseteq Y \rightarrow (\text{by (1)}) \quad \mu(Y \cup X) = \mu(Y).$$

$$(5.1.3) \quad \mu(Y) \cap X = (\text{by (2)}) \quad \mu(Y \cup X) \cap X \subseteq \mu(Y \cup X) \cap (X \cup U) \subseteq (\text{by } (\mu PR)) \quad \mu(X \cup U) = (\text{by (1)}) \quad \mu(U).$$

(5.2)

Using (1.1), it suffices to show $(\mu Cum0) \rightarrow (\mu CUM)$. Let $\mu(X) \subseteq U \subseteq X$. By $(\mu Cum0)$ $X \cap \mu(U) \subseteq \mu(X)$, so by $\mu(U) \subseteq U \subseteq X \rightarrow \mu(U) \subseteq \mu(X)$. $U \subseteq X \rightarrow \mu(X) \cap U \subseteq \mu(U)$, but also $\mu(X) \subseteq U$, so $\mu(X) \subseteq \mu(U)$.

(4.1)

Trivial.

(6.1)

Follows from (4.1) and (5.2).

(6.2)

Let the prerequisites of $(\mu Cumt\alpha)$ hold.

We first show by induction $\mu(X_\alpha \cup U) \subseteq \mu(U)$.

Proof:

$\alpha = 0 : \mu(X_0) \subseteq U \rightarrow \mu(X_0 \cup U) = \mu(U)$ by (5.1.1). Let for all $\beta < \alpha$ $\mu(X_\beta \cup U) \subseteq \mu(U) \subseteq U$. By prerequisite, $\mu(X_\alpha) \subseteq U \cup \bigcup \{X_\beta : \beta < \alpha\}$, thus $\mu(X_\alpha \cup U) \subseteq \mu(X_\alpha) \cup \mu(U) \subseteq \bigcup \{U \cup X_\beta : \beta < \alpha\}$,

so $\forall \beta < \alpha$ $\mu(X_\alpha \cup U) \cap (U \cup X_\beta) \subseteq \mu(U)$ by (5.1.3), thus $\mu(X_\alpha \cup U) \subseteq \mu(U)$.

Consequently, under the above prerequisites, we have $\mu(X_\alpha \cup U) \subseteq \mu(U) \subseteq U \subseteq U \cup X_\alpha$, so by (μCUM) $\mu(U) = \mu(X_\alpha \cup U)$, and, finally, $\mu(U) \cap X_\alpha = \mu(X_\alpha \cup U) \cap X_\alpha \subseteq \mu(X_\alpha)$ by (μPR) .

Note that finite unions take us over the limit step, essentially, as all steps collapse, and $\mu(X_\alpha \cup U)$ will always be $\mu(U)$, so there are no real changes.

(5.3)

Follows from (6.2) and (4.1).

(3.1)

Follows from (5.2) and (5.3).

(3.2)

Follows from (6.1) and (6.2).

(4.2)

Follows from (2.3) and (2.1).

(4.3)

Follows from (5.2) and (6.2).

(5.4)

$$\mu(X) \subseteq U \rightarrow \mu(X) \subseteq U \cap X \subseteq X \rightarrow \mu(X \cap U) = \mu(X) \rightarrow X \cap \mu(U) = (X \cap U) \cap \mu(U) \subseteq \mu(X \cap U) = \mu(X)$$

(3.3)

See Example 17.3 (page 150) .

(6.3)

This is a consequence of (3.3).

(7)

Trivial. Let $X \subseteq Y$, so by $(\mu \subseteq) \mu(X) \subseteq X \subseteq Y$, so by $(\mu Cum 0) X \cap \mu(Y) \subseteq \mu(X)$.

□

karl-search= End Fact Cum-Alpha Proof

17.2.9 Fact Cum-Alpha-HU

karl-search= Start Fact Cum-Alpha-HU

Fact 17.5

(+++ Orig. No.: Fact Cum-Alpha-HU +++)

LABEL: Fact Cum-Alpha-HU

Assume $(\mu \subseteq)$.

We have for $(\mu Cum \infty)$ and (HU, u) :

(1) $x \in \mu(Y), \mu(Y) \subseteq H(U, x) \rightarrow Y \subseteq H(U, x)$

(2) $(\mu Cum \infty) \rightarrow (HU, u)$

(3) $(HU, u) \rightarrow (\mu Cum \infty)$

karl-search= End Fact Cum-Alpha-HU

17.2.10 Fact Cum-Alpha-HU Proof

karl-search= Start Fact Cum-Alpha-HU Proof

Fact 17.6

(+++ Orig. No.: Fact Cum-Alpha-HU Proof +++)

LABEL: Fact Cum-Alpha-HU Proof

(1)

Trivial by definition of $H(U, x)$.

(2)

Let $x \in \mu(U), x \in Y, \mu(Y) \subseteq H(U, x)$ (and thus $Y \subseteq H(U, x)$ by definition). Thus, we have a sequence $X_0 := U, \mu(X_\beta) \subseteq U \cup \bigcup \{X_\gamma : \gamma < \beta\}$ and $Y = X_\alpha$ for some α (after X_0 , enumerate arbitrarily $H(U, x)_1$, then $H(U, x)_2$, etc., do nothing at limits). So $x \in \bigcap \{X_\gamma : \gamma \leq \alpha\} \cap \mu(U)$, and $x \in \mu(X_\alpha) = \mu(Y)$ by $(\mu Cum \infty)$. Remark:

The same argument shows that we can replace “ $x \in X$ ” equivalently by “ $x \in \mu(X)$ ” in the definition of $H(U, x)_{\alpha+1}$, as was done in Definition 3.7.5 in [Sch04].

(3)

Suppose $(\mu Cum\alpha)$ fails, we show that then so does (HUx) . As $(\mu Cum\alpha)$ fails, for all $\beta \leq \alpha$ $\mu(X_\beta) \subseteq U \cup \bigcup\{X_\gamma : \gamma < \beta\}$, but there is $x \in \bigcap\{X_\gamma : \gamma \leq \alpha\} \cap \mu(U)$, $x \notin \mu(X_\alpha)$. Thus for all $\beta \leq \alpha$ $\mu(X_\beta) \subseteq X_\beta \subseteq H(U, x)$, moreover $x \in \mu(U)$, $x \in X_\alpha - \mu(X_\alpha)$, but $\mu(X_\alpha) \subseteq H(U, x)$, so (HUx) fails.

□

karl-search= End Fact Cum-Alpha-HU Proof

17.2.11 Fact HU

karl-search= Start Fact HU

Fact 17.7

(+++ Orig. No.: Fact HU +++)

LABEL: Fact HU

We continue to show results for $H(U)$ and $H(U, u)$.

Let A, X, U, U', Y and all A_i be in \mathcal{Y} .

(0) $H(U)$ and $H(U, u)$

(0.1) $H(U, u) \subseteq H(U)$

(0.2) $(HU) \rightarrow (HU, u)$

(0.3) $(\cup) + (\mu PR)$ entail $H(U) \subseteq H(U, u)$

(0.4) $(\cup) + (\mu PR)$ entail $(HU, u) \rightarrow (HU)$

(1) $(\mu \subseteq)$ and (HU) entail:

(1.1) (μPR)

(1.2) (μCUM)

(2) $(HU) + (\cup) \rightarrow (HU, u)$

(3) $(\mu \subseteq)$ and (μPR) entail:

(3.1) $A = \bigcup\{A_i : i \in I\} \rightarrow \mu(A) \subseteq \bigcup\{\mu(A_i) : i \in I\}$,

(3.2) $U \subseteq H(U)$, and $U \subseteq U' \rightarrow H(U) \subseteq H(U')$,

(3.3) $\mu(U \cup Y) - H(U) \subseteq \mu(Y)$ - if $\mu(U \cup Y)$ is defined, in particular, if (\cup) holds.

(4) (\cup) , $(\mu \subseteq)$, (μPR) , (μCUM) entail:

(4.1) $H(U) = H_1(U)$

(4.2) $U \subseteq A$, $\mu(A) \subseteq H(U) \rightarrow \mu(A) \subseteq U$,

(4.3) $\mu(Y) \subseteq H(U) \rightarrow Y \subseteq H(U)$ and $\mu(U \cup Y) = \mu(U)$,

(4.4) $x \in \mu(U)$, $x \in Y - \mu(Y) \rightarrow Y \not\subseteq H(U)$ (and thus (HU)),

(4.5) $Y \not\subseteq H(U) \rightarrow \mu(U \cup Y) \not\subseteq H(U)$.

(5) (\cup) , $(\mu \subseteq)$, (HU) entail

(5.1) $H(U) = H_1(U)$

- (5.2) $U \subseteq A, \mu(A) \subseteq H(U) \rightarrow \mu(A) \subseteq U,$
(5.3) $\mu(Y) \subseteq H(U) \rightarrow Y \subseteq H(U)$ and $\mu(U \cup Y) = \mu(U),$
(5.4) $x \in \mu(U), x \in Y - \mu(Y) \rightarrow Y \not\subseteq H(U),$
(5.5) $Y \not\subseteq H(U) \rightarrow \mu(U \cup Y) \not\subseteq H(U).$

karl-search= End Fact HU

17.2.12 Fact HU Proof

karl-search= Start Fact HU Proof

Fact 17.8

(+++ Orig. No.: Fact HU Proof +++)

LABEL: Fact HU Proof

(0.1) and (0.2) trivial by definition.

(0.3) Proof by induction. Let $X \in \mathcal{Y}, \mu(X) \subseteq H(U)_\alpha,$ then $U \cup X \in \mathcal{Y}, \mu(U \cup X) \subseteq_{(\mu PR)} \mu(U) \cup \mu(X) \subseteq_{(\mu \subseteq)} H(U)_\alpha = H(U, u)_\alpha$ by induction hypothesis, and $u \in U \cup X.$

(0.4) Immediate by (0.3).

(1.1) By $(HU),$ if $\mu(Y) \subseteq H(U),$ then $\mu(U) \cap Y \subseteq \mu(Y).$ But, if $Y \subseteq U,$ then $\mu(Y) \subseteq H(U)$ by $(\mu \subseteq).$

(1.2) Let $\mu(U) \subseteq X \subseteq U.$ Then by (1.1) $\mu(U) = \mu(U) \cap X \subseteq \mu(X).$ By prerequisite, $\mu(U) \subseteq U \subseteq H(X),$ so $\mu(X) = \mu(X) \cap U \subseteq \mu(U)$ by $(\mu \subseteq).$

(2) By (1.2), (HU) entails $(\mu CUM),$ so by (\cup) and Fact 17.4 (page 153) , (5.2) $(\mu Cum\infty)$ holds, so by Fact 17.7 (page 157) , (2) (HUx) holds.

(3.1) $\mu(A) \cap A_j \subseteq \mu(A_j) \subseteq \bigcup \mu(A_i),$ so by $\mu(A) \subseteq A = \bigcup A_i$ $\mu(A) \subseteq \bigcup \mu(A_i).$

(3.2) trivial.

(3.3) $\mu(U \cup Y) - H(U) \subseteq_{(3.2)} \mu(U \cup Y) - U \subseteq$ (by $(\mu \subseteq)$ and (3.1)) $\mu(U \cup Y) \cap Y \subseteq_{(\mu PR)} \mu(Y).$

(4.1) We show that, if $X \subseteq H_2(U),$ then $X \subseteq H_1(U),$ more precisely, if $\mu(X) \subseteq H_1(U),$ then already $X \subseteq H_1(U),$ so the construction stops already at $H_1(U).$ Suppose then $\mu(X) \subseteq \bigcup \{Y : \mu(Y) \subseteq U\},$ and let $A := X \cup U.$ We show that $\mu(A) \subseteq U,$ so $X \subseteq A \subseteq H_1(U).$ Let $a \in \mu(A).$ By (3.1), $\mu(A) \subseteq \mu(X) \cup \mu(U).$ If $a \in \mu(U) \subseteq U,$ we are done. If $a \in \mu(X),$ there is Y s.t. $\mu(Y) \subseteq U$ and $a \in Y,$ so $a \in \mu(A) \cap Y.$ By Fact 17.4 (page 153) , (5.1.3), we have for Y s.t. $\mu(Y) \subseteq U$ and $U \subseteq A$ $\mu(A) \cap Y \subseteq \mu(U).$ Thus $a \in \mu(U),$ and we are done again.

(4.2) Let $U \subseteq A, \mu(A) \subseteq H(U) = H_1(U)$ by (4.1). So $\mu(A) = \bigcup \{\mu(A) \cap Y : \mu(Y) \subseteq U\} \subseteq \mu(U) \subseteq U,$ again by Fact 17.4 (page 153) , (5.1.3).

(4.3) Let $\mu(Y) \subseteq H(U),$ then by $\mu(U) \subseteq H(U)$ and (3.1) $\mu(U \cup Y) \subseteq \mu(U) \cup \mu(Y) \subseteq H(U),$ so by (4.2) $\mu(U \cup Y) \subseteq U$ and $U \cup Y \subseteq H(U).$ Moreover, $\mu(U \cup Y) \subseteq U \subseteq U \cup Y \rightarrow_{(\mu CUM)} \mu(U \cup Y) = \mu(U).$

(4.4) If not, $Y \subseteq H(U),$ so $\mu(Y) \subseteq H(U),$ so $\mu(U \cup Y) = \mu(U)$ by (4.3), but $x \in Y - \mu(Y) \rightarrow_{(\mu PR)} x \notin \mu(U \cup Y) = \mu(U),$ contradiction.

(4.5) $\mu(U \cup Y) \subseteq H(U) \rightarrow_{(4.3)} U \cup Y \subseteq H(U).$

(5) Trivial by (1) and (4).

□

karl-search= End Fact HU Proof

18 Validity

+++++

18.0.13 Introduction Path-Validity

karl-search= Start Introduction Path-Validity

18.0.13.1 Introduction to Path-Validity

(+++*** Orig.: Introduction to Path-Validity)

LABEL: Section Introduction to Path-Validity

All definitions are relative to a fixed diagram Γ .

For simplicity, we consider Γ to be just a set of points and arrows, thus e.g. $x \rightarrow y \in \Gamma$ and $x \in \Gamma$ are defined, when x is a point in Γ , and $x \rightarrow y$ an arrow in Γ .

Recall that we have two types of arrows, positive and negative ones.

We first define generalized and potential paths, and finally validity of paths, written $\Gamma \models \sigma$, if σ is a path, as well as $\Gamma \models xy$, if $\Gamma \models \sigma$ and $\sigma : x \dots \rightarrow y$.

karl-search= End Introduction Path-Validity

+++++

18.0.14 Definition Gen-Path

karl-search= Start Definition Gen-Path

Definition 18.1

(+++ Orig. No.: Definition Gen-Path +++)

LABEL: Definition Gen-Path

(1) Generalized paths:

A generalized path is an uninterrupted chain of positive or negative arrows pointing in the same direction, more precisely:

- (1.1) The empty path is a generalized path.
- (1.2) If $x \rightarrow p \in \Gamma$, then $x \rightarrow p$ is a generalized path,
- (1.3) if $x \nrightarrow p \in \Gamma$, then $x \nrightarrow p$ is a generalized path.
- (1.4) If $x \dots \rightarrow p$ is a generalized path, and $p \rightarrow q \in \Gamma$, then $x \dots \rightarrow p \rightarrow q$ is a generalized path,
- (1.5) if $x \dots \rightarrow p$ is a generalized path, and $p \nrightarrow q \in \Gamma$, then $x \dots \rightarrow p \nrightarrow q$ is a generalized path.
- (1.6) If the starting point of a generalized path σ is x , and y its endpoint, we say that σ is a generalized path from x to y , and write $\sigma : x \dots \rightarrow y$

(2) Concatenation:

If σ and τ are two generalized paths, and the end point of σ is the same as the starting point of τ , then $\sigma \circ \tau$ is the concatenation of σ and τ .

(3) Subpath:

If $\sigma = \tau \circ \tau' \circ \tau''$ is a generalized path, τ and τ'' are generalized paths (possibly empty), then τ' is a subpath of σ .

(4) $[x, y]$:

If x, y are nodes in Γ , then $[x, y]$ is the set of all subpaths of all generalized paths from x to y . Note that \subseteq is a well-founded relation on the set of $[x, y]$ of Γ , so we can do induction on $[x, y]$ and \subseteq .

(5) Potential paths (pp.):

A generalized path, which contains at most one negative arrow, and then at the end, is a potential path. If the last link is positive, it is a positive potential path, if not, a negative one.

karl-search= End Definition Gen-Path

+++++

18.0.15 Definition Arrow-Origin

karl-search= Start Definition Arrow-Origin

Definition 18.2

(+++ Orig. No.: Definition Arrow-Origin +++)

LABEL: Definition Arrow-Origin

This definition is for IBRS - otherwise it is trivial.

The definition is by recursion. Intuitively, we go back until we find a node.

If $\alpha : x \rightarrow y$ is an arrow from node to node or arrow, then $or(\alpha) := x$.

If $\beta : \alpha \rightarrow y$ is an arrow from arrow to node or arrow, then $or(\beta) := or(\alpha)$.

karl-search= End Definition Arrow-Origin

+++++

18.0.16 Definition Path-Validity

karl-search= Start Definition Path-Validity

Definition 18.3

(+++ Orig. No.: Definition Path-Validity +++)

LABEL: Definition Path-Validity

Inductive definition of $\Gamma \models \sigma$ or validity of path. At the same time, we construct dynamically an IBRS - which is just a reformulation of the same mechanism.

Let $\sigma : x \cdots \rightarrow y$ be a potential path, and let validity, as well as the construction of new arrows in the IBRS, be determined by induction for all $\sigma' : x' \cdots \rightarrow y'$ with $[x', y'] \subset [x, y]$.

(1) Case I, $\sigma : x \rightarrow y$ (or $x \not\rightarrow y$) is a direct link in Γ :

Then $\Gamma \models \sigma$, and we add the arrow $\alpha : x \rightarrow y$, with two labels: v for validity, and $+/-$ if $\sigma : x \rightarrow y$ or $\sigma : x \not\rightarrow y$ - we denote this arrow α_σ .

(Recall that we have no hard contradictions in Γ .)

(2) Case II, σ is a compound potential path:

(2.1) Case II.1, σ is a positive pp. $x \cdots \rightarrow u \rightarrow y$:

Let $\sigma' := x \cdots \rightarrow u$, so $\sigma = \sigma' \circ u \rightarrow y$.

Then, intuitively, $\Gamma \models \sigma$ iff

(2.1.1) σ is a candidate by upward chaining,

(2.1.2) σ is not precluded by more specific contradicting information,

(2.1.3) all potential contradictions are themselves precluded by information contradicting them.

Formally,

$\Gamma \models \sigma$ and we add an arrow $\alpha_\sigma : \alpha_{\sigma'} \rightarrow y$ with labels v and $+$

iff

(2.1.1) $\Gamma \models \sigma'$ and $u \rightarrow y \in \Gamma$.

For IBRS, the prerequisite is that there is an arrow $\alpha_{\sigma'}$ s.t. $or(\alpha) = x$, the destination of α is y , the labels of α are v and $+$.

(The initial segment must be a path, as we have an upward chaining approach. This is decided by the induction hypothesis.)

(2.1.2) There are no v, τ, τ' such that $v \not\rightarrow y \in \Gamma$ and $\Gamma \models \tau := x \cdots \rightarrow v$ and $\Gamma \models \tau' := v \cdots \rightarrow u$ - there are arrows α_τ with $or(\alpha_\tau) = x$, destination v and $\alpha_{\tau'}$ with $or(\alpha_{\tau'}) = v$, destination u for the IBRS (τ may be the empty path, i.e. $x = v$.)

(σ itself is not precluded by split validity preclusion and a contradictory link. Note that $\tau \circ v \not\rightarrow y$ need not be valid, it suffices that it is a better candidate (by τ' .)

(2.1.3) all potentially conflicting paths are precluded by information contradicting them:

For all v and τ such that $v \not\rightarrow y \in \Gamma$ and $\Gamma \models \tau := x \cdots \rightarrow v$ (i.e. for all potentially conflicting paths $\tau \circ v \not\rightarrow y$) - α_τ with $or(\alpha_\tau) = x$ and destination v - there is z such that $z \rightarrow y \in \Gamma$ and either

$z = x$

(the potentially conflicting pp. is itself precluded by a direct link, which is thus valid)

or

there are $\Gamma \models \rho := x \cdots \rightarrow z$ and $\Gamma \models \rho' := z \cdots \rightarrow v$ for suitable ρ and ρ' - α_ρ and $\alpha_{\rho'}$ with suitable origin and destination for IBRS.

(2.1.1) Case II.2, the negative case, i.e. σ a negative pp. $x \cdots \rightarrow u \not\rightarrow y$, $\sigma' := x \cdots \rightarrow u$, $\sigma = \sigma' \circ u \not\rightarrow y$ is entirely symmetrical.

Note that the new arrows α allow us to reconstruct the whole path, if needed.

karl-search= End Definition Path-Validity

+++++

18.0.17 Remark Path-Validity

karl-search= Start Remark Path-Validity

Remark 18.1

(+++ Orig. No.: Remark Path-Validity +++)

LABEL: Remark Path-Validity

The following remarks all concern preclusion.

(1) Thus, in the case of preclusion, there is a valid path from x to z , and z is more specific than v , so $\tau \circ v \not\rightarrow y$ is precluded. Again, $\rho \circ z \rightarrow y$ need not be a valid path, but it is a better candidate than $\tau \circ v \not\rightarrow y$ is, and as $\tau \circ v \not\rightarrow y$ is in simple contradiction, this suffices.

(2) Our definition is stricter than many usual ones, in the following sense: We require - according to our general picture to treat only direct links as information - that the preclusion "hits" the precluded path at the end, i.e. $v \not\rightarrow y \in \Gamma$, and ρ' hits $\tau \circ v \not\rightarrow y$ at v . In other definitions, it is possible that the preclusion hits at some v' , which is somewhere on the path τ , and not necessarily at its end. For instance, in the Tweety Diagram,

** Index unter Hauptteil **

see Diagram 18.34 (page 199) , if there were a node b' between b and d , we will need path $c \rightarrow b \rightarrow b'$ to be valid, (obvious) validity of the arrow $c \rightarrow b$ will not suffice.

(3) If we allow ρ to be the empty path, then the case $z = x$ is a subcase of the present one.

(4) Our conceptual analysis has led to a very important simplification of the definition of validity. If we adopt on-path preclusion, we have to remember all paths which led to the information source to be considered: In the Tweety diagram, we have to remember that there is an arrow $a \rightarrow b$, it is not sufficient to note that we somehow came from a to b by a valid path, as the path $a \rightarrow c \rightarrow b \rightarrow d$ is precluded, but not the path $a \rightarrow b \rightarrow d$. If we adopt total path preclusion, we have to remember the valid path $a \rightarrow c \rightarrow b$ to see that it precludes $a \rightarrow c \rightarrow d$. If we allow preclusion to "hit" below the last node, we also have to remember the entire path which is precluded. Thus, in all those cases, whole paths (which can be very long) have to be remembered, but NOT in our definition.

We only need to remember (consider the Tweety diagram):

- (a) we want to know if $a \rightarrow b \rightarrow d$ is valid, so we have to remember a, b, d . Note that the (valid) path from a to b can be composed and very long.
- (b) we look at possible preclusions, so we have to remember $a \rightarrow c \not\rightarrow d$, again the (valid) path from a to c can be very long.
- (c) we have to remember that the path from c to b is valid (this was decided by induction before).

So in all cases (the last one is even simpler), we need only remember the starting node, a (or c), the last node of the valid paths, b (or c), and the information $b \rightarrow d$ or $c \not\rightarrow d$ - i.e. the size of what has to be recalled is ≤ 3 . (Of course, there may be many possible preclusions, but in all cases we have to look at a very limited situation, and not arbitrarily long paths.)

□

karl-search= End Remark Path-Validity

18.0.18 Diagram I-U-reac-x

18.0.19 Diagram I-U-reac-x

karl-search= Start Diagram I-U-reac-x

Diagram 18.1 LABEL: Diagram I-U-reac-x

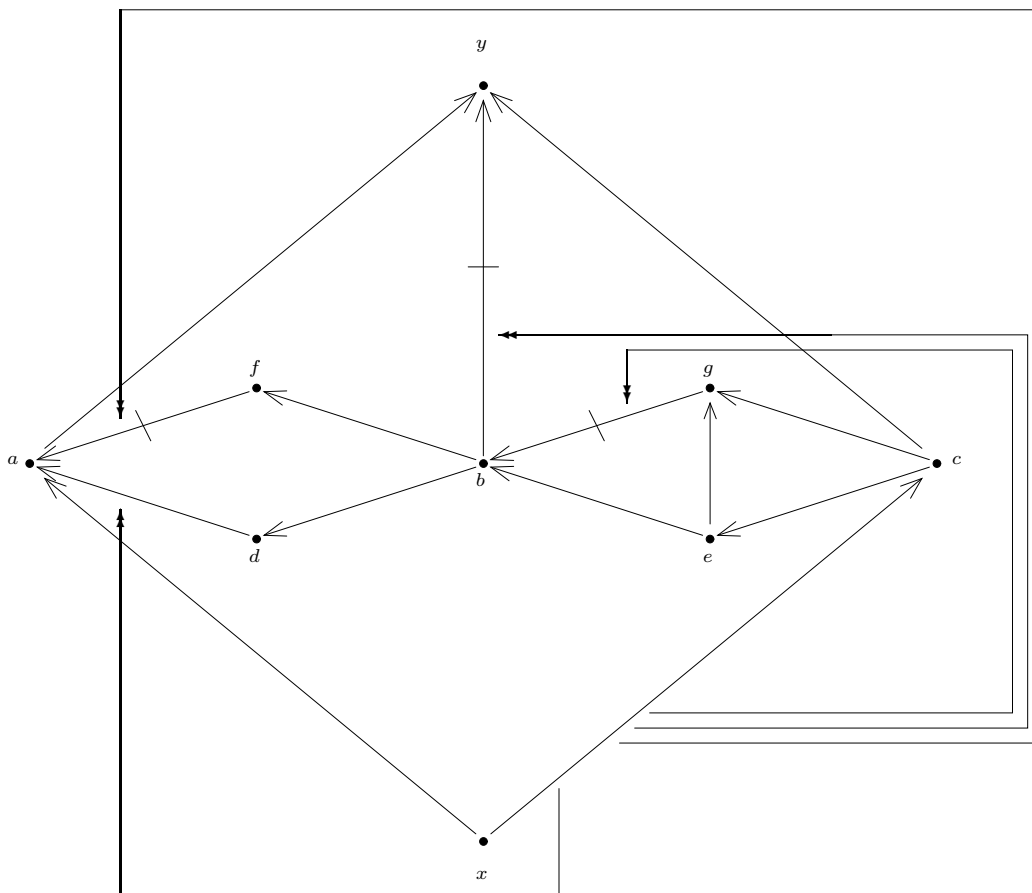

karl-search= End Diagram I-U-reac-x

+++++

18.0.20 Diagram I-U-reac-c

18.0.21 Diagram I-U-reac-c

karl-search= Start Diagram I-U-reac-c

Diagram 18.2 LABEL: Diagram I-U-reac-c

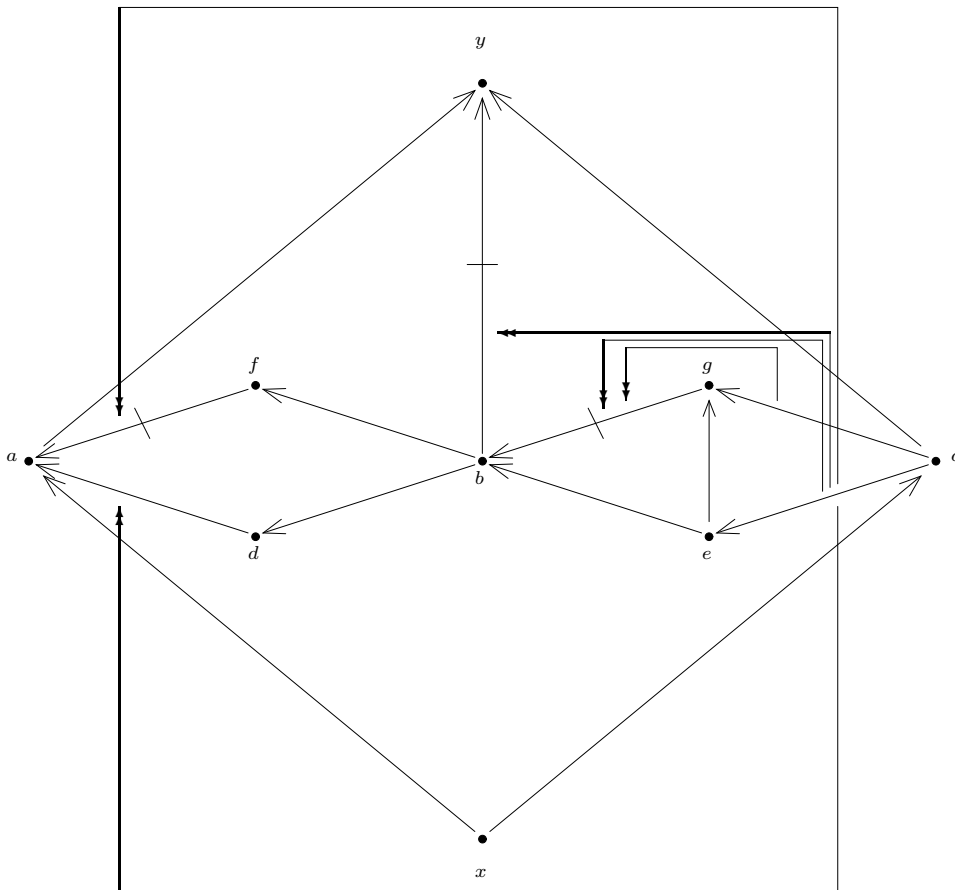

karl-search= End Diagram I-U-reac-c

+++++

18.0.22 Diagram U-D-reactive

18.0.23 Diagram U-D-reactive

karl-search= Start Diagram U-D-reactive

Diagram 18.3 LABEL: Diagram U-D-reactive

The problem of downward chaining - reactive

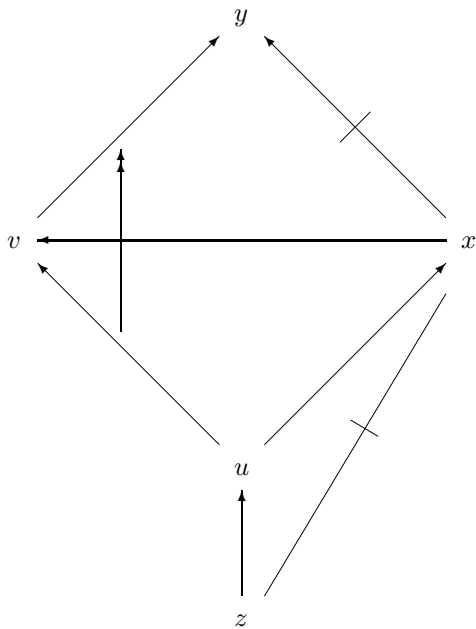

karl-search= End Diagram U-D-reactive

+++++

18.0.24 Diagram Dov-Is-2

18.0.25 Diagram Dov-Is-2

karl-search= Start Diagram Dov-Is-2

Diagram 18.4 LABEL: Diagram Dov-Is-2

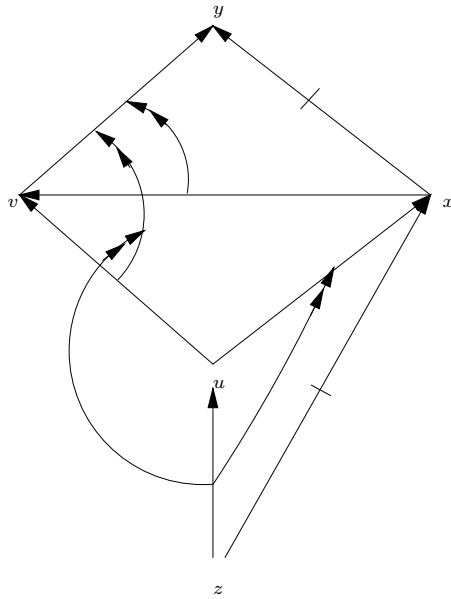

karl-search= End Diagram Dov-Is-2

+++++

18.0.26 Diagram Dov-Is-1

18.0.27 Diagram Dov-Is-1

karl-search= Start Diagram Dov-Is-1

Diagram 18.5 LABEL: Diagram Dov-Is-1

Reactive graph

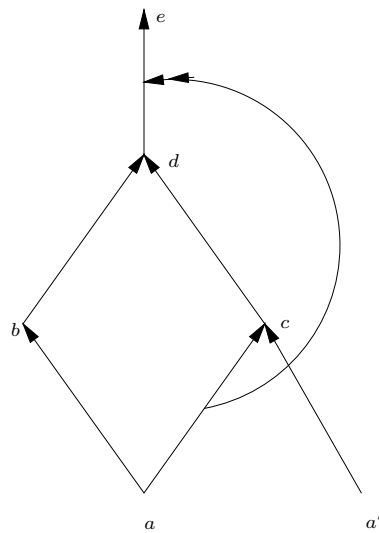

karl-search= End Diagram Dov-Is-1

+++++

18.0.28 Diagram CJ-O2

18.0.29 Diagram CJ-O2

karl-search= Start Diagram CJ-O2

Diagram 18.6 LABEL: Diagram CJ-O2

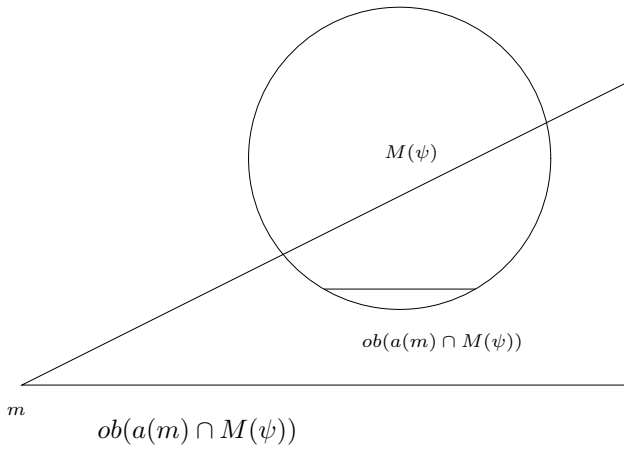

karl-search= End Diagram CJ-O2

+++++

18.0.30 Diagram CJ-O1

18.0.31 Diagram CJ-O1

karl-search= Start Diagram CJ-O1

Diagram 18.7 LABEL: Diagram CJ-O1

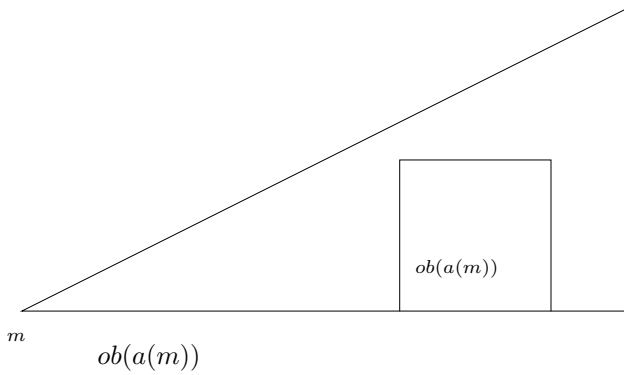

karl-search= End Diagram CJ-O1

+++++

18.0.32 Diagram FunnyRule

18.0.33 Diagram FunnyRule

karl-search= Start Diagram FunnyRule

Diagram 18.8 LABEL: Diagram FunnyRule

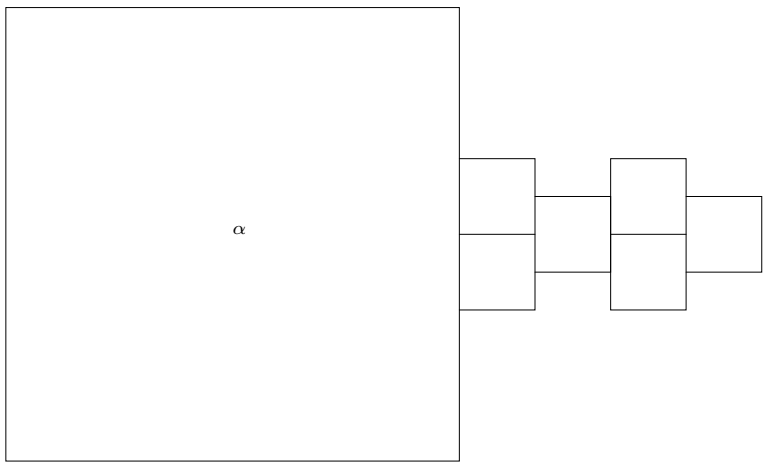

FunnyRule for ()

karl-search= End Diagram FunnyRule

+++++

18.0.34 Diagram External2

18.0.35 Diagram External2

karl-search= Start Diagram External2

Diagram 18.9 LABEL: Diagram External2

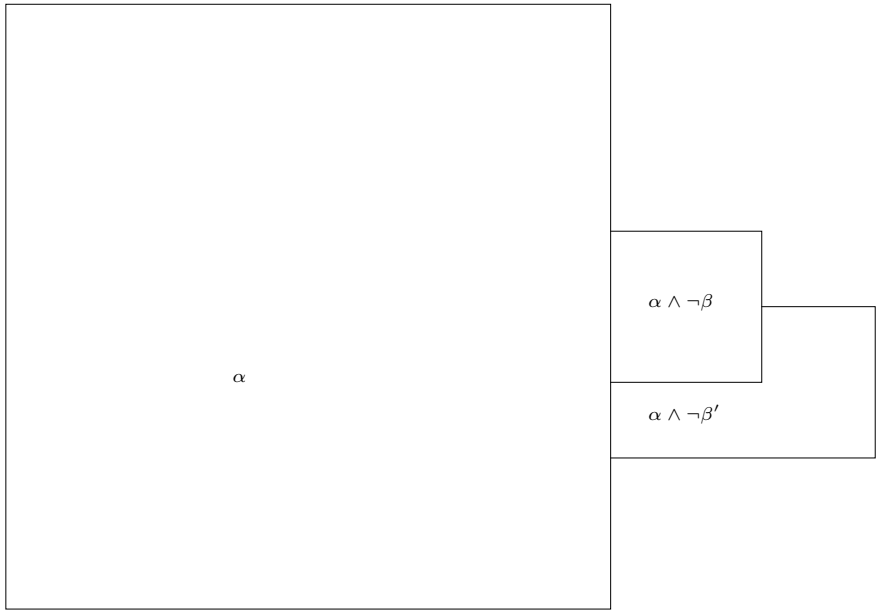

External2 for ()

karl-search= End Diagram External2

+++++

18.0.36 Diagram External

18.0.37 Diagram External

karl-search= Start Diagram External

Diagram 18.10 LABEL: Diagram External

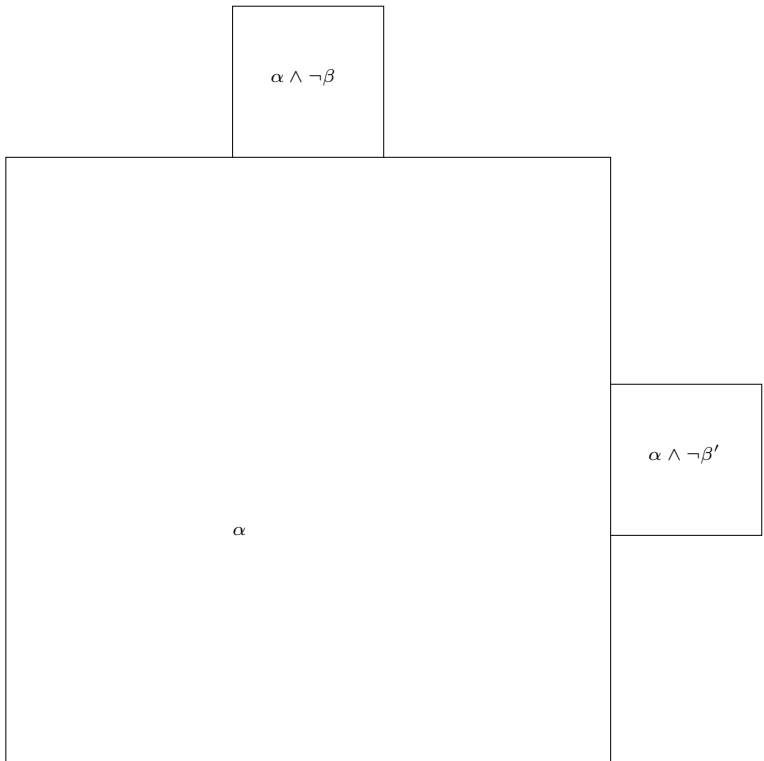

External for (OR)

karl-search= End Diagram External

+++++

18.0.38 Diagram Internal

18.0.39 Diagram Internal

karl-search= Start Diagram Internal

Diagram 18.11 LABEL: Diagram Internal

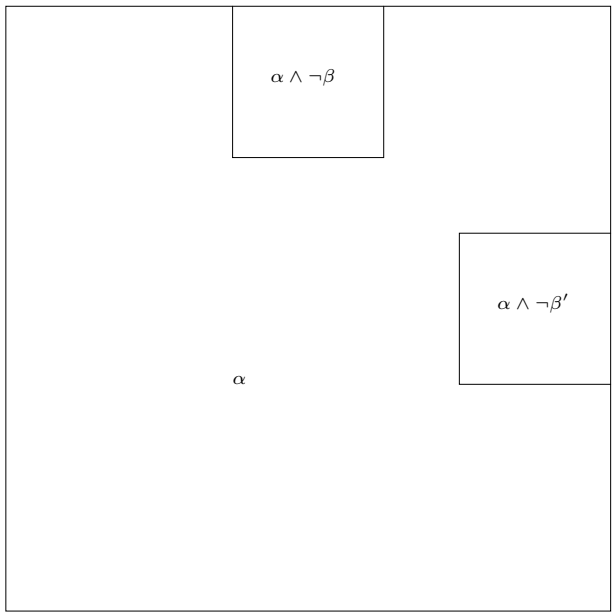

Internal for (CUM) and (AND)

karl-search= End Diagram Internal

+++++

18.0.40 Diagram InherUniv

18.0.41 Diagram InherUniv

karl-search= Start Diagram InherUniv

Diagram 18.12 LABEL: Diagram InherUniv

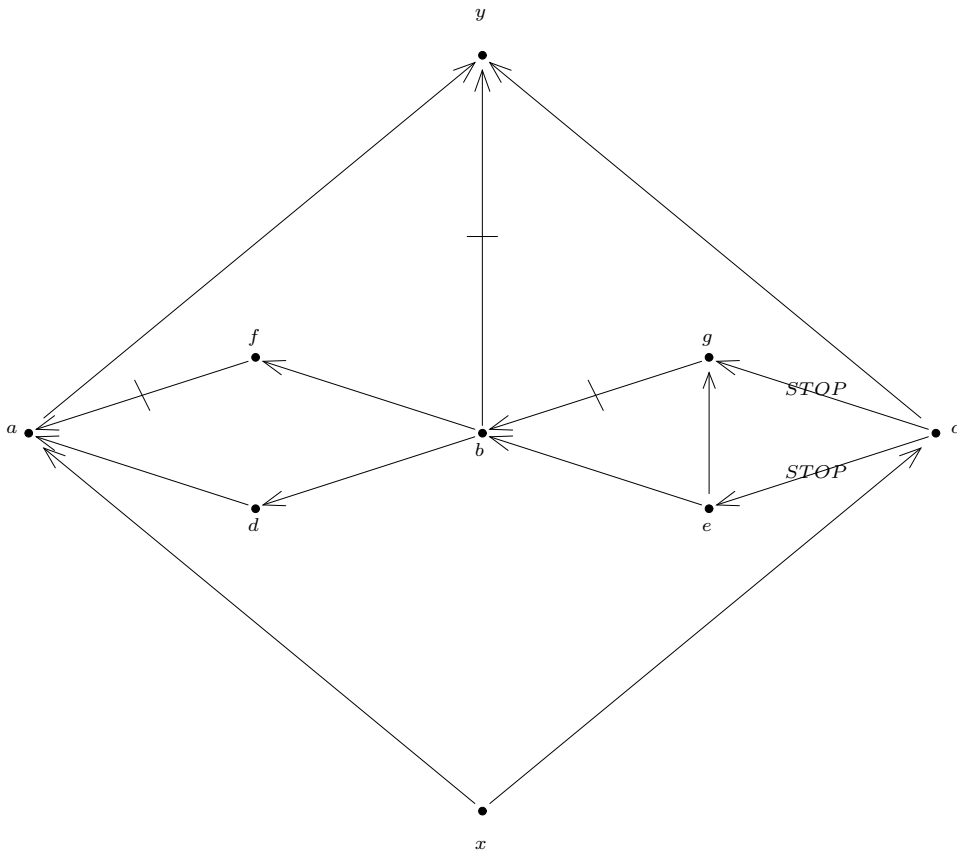

karl-search= End Diagram InherUniv

+++++

18.0.42 Diagram Now-1

18.0.43 Diagram Now-1

karl-search= Start Diagram Now-1

Diagram 18.13 LABEL: Diagram Now-1

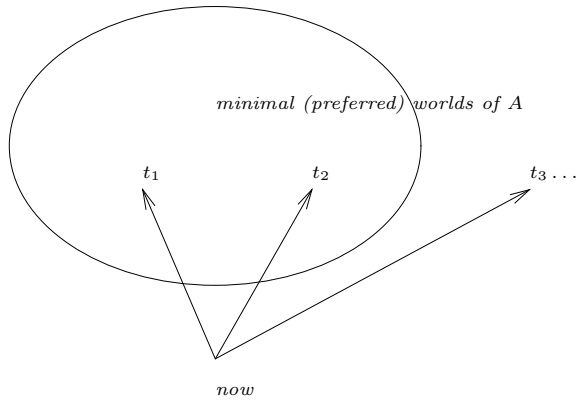

Diagram 1

karl-search= End Diagram Now-1

+++++

18.0.44 Diagram Now-2

18.0.45 Diagram Now-2

karl-search= Start Diagram Now-2

Diagram 18.14 LABEL: Diagram Now-2

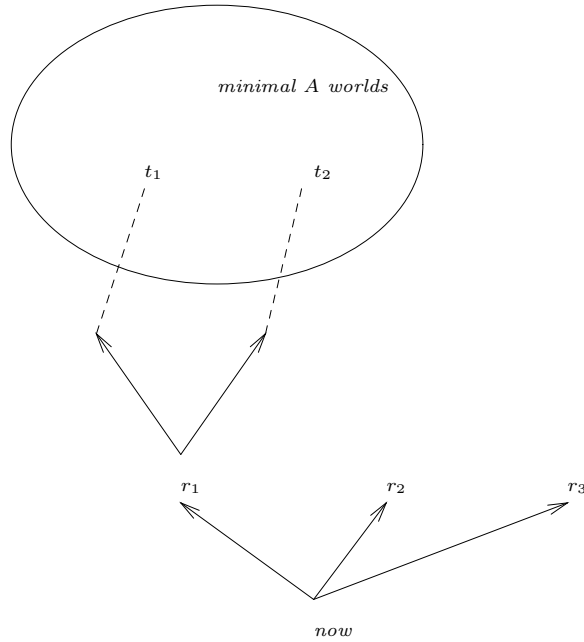

Diagram 2

karl-search= End Diagram Now-2

+++++

18.0.46 Diagram IBRS

18.0.47 Diagram IBRS

karl-search= Start Diagram IBRS

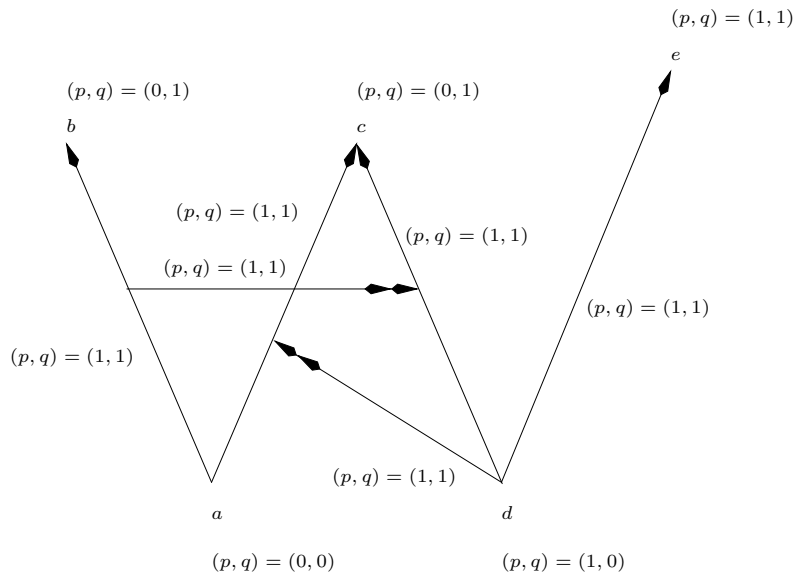

A simple example of an information bearing system.

Diagram 18.15

LABEL: Diagram IBRS

We have here:

$$\begin{aligned}
 S &= \{a, b, c, d, e\}. \\
 \mathfrak{R} &= S \cup \{(a, b), (a, c), (d, c), (d, e)\} \cup \{(a, b), (d, c), (d, (a, c))\}. \\
 Q &= \{p, q\}
 \end{aligned}$$

The values of h for p and q are as indicated in the figure. For example $h(p, (d, (a, c))) = 1$.

karl-search= End Diagram IBRS

+++++

18.0.48 Diagram Pischinger

18.0.49 Diagram Pischinger

karl-search= Start Diagram Pischinger

Diagram 18.16 LABEL: Diagram Pischinger

The overall structure is visible from t

Only the inside of the circle is visible from s

Half-circles are the sets of minimal elements of layers

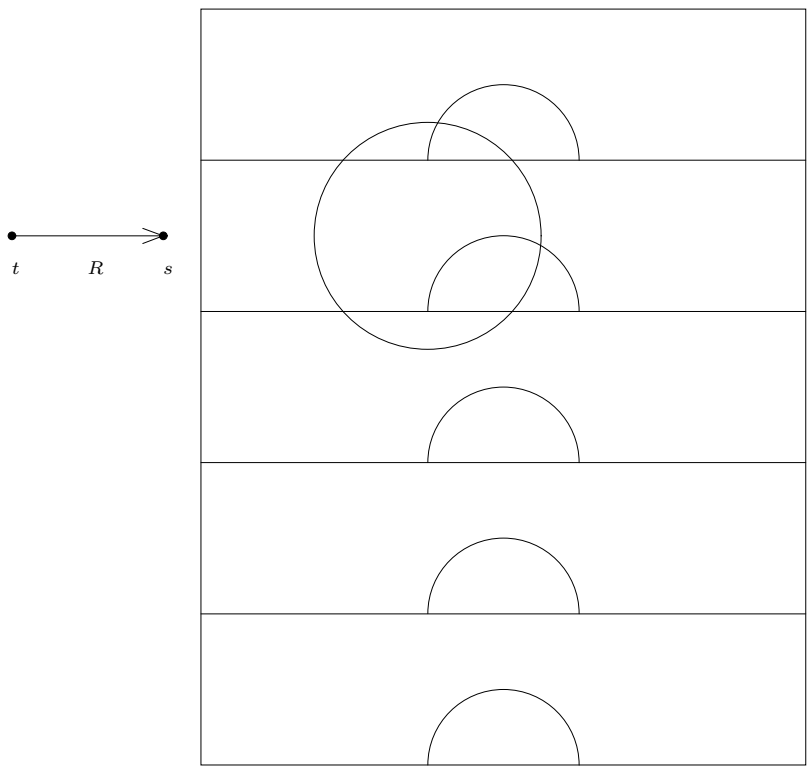

A- ranked structure and accessibility

karl-search= End Diagram Pischinger

+++++

18.0.50 Diagram ReacA

18.0.51 Diagram ReacA

karl-search= Start Diagram ReacA

Diagram 18.17 LABEL: Diagram ReacA

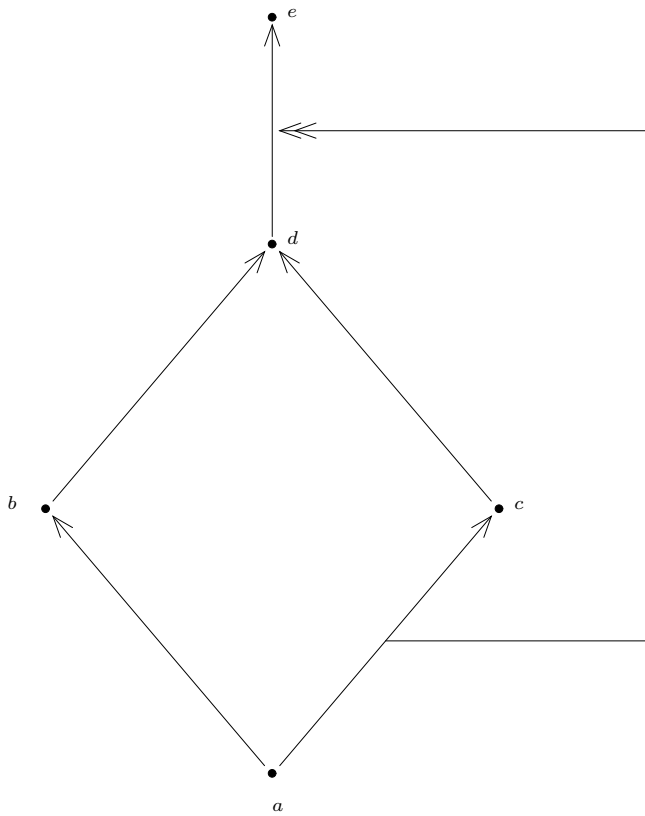

karl-search= End Diagram ReacA

+++++

18.0.52 Diagram ReacB

18.0.53 Diagram ReacB

karl-search= Start Diagram ReacB

Diagram 18.18 LABEL: Diagram ReacB

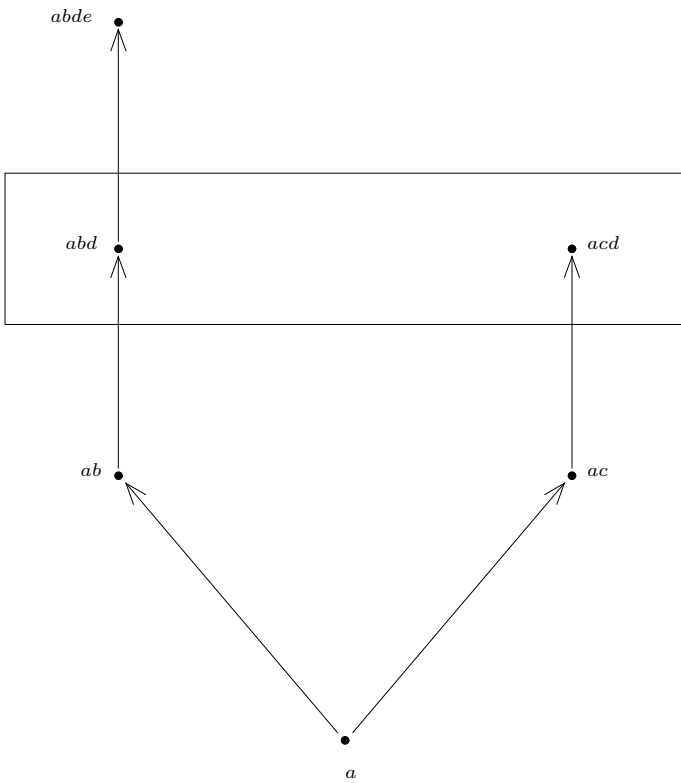

karl-search= End Diagram ReacB

+++++

18.0.54 Diagram CumSem

18.0.55 Diagram CumSem

karl-search= Start Diagram CumSem

Diagram 18.19 LABEL: Diagram CumSem

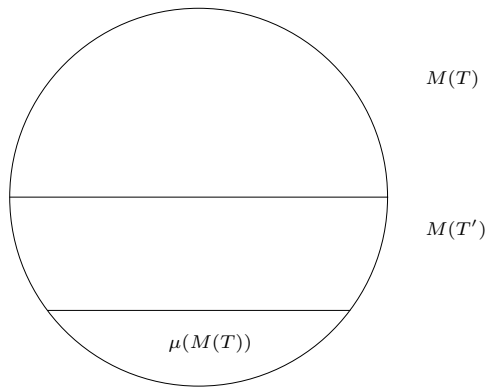

karl-search= End Diagram CumSem

+++++

18.0.56 Diagram Eta-Rho-1

18.0.57 Diagram Eta-Rho-1

karl-search= Start Diagram Eta-Rho-1

Diagram 18.20 LABEL: Diagram Eta-Rho-1

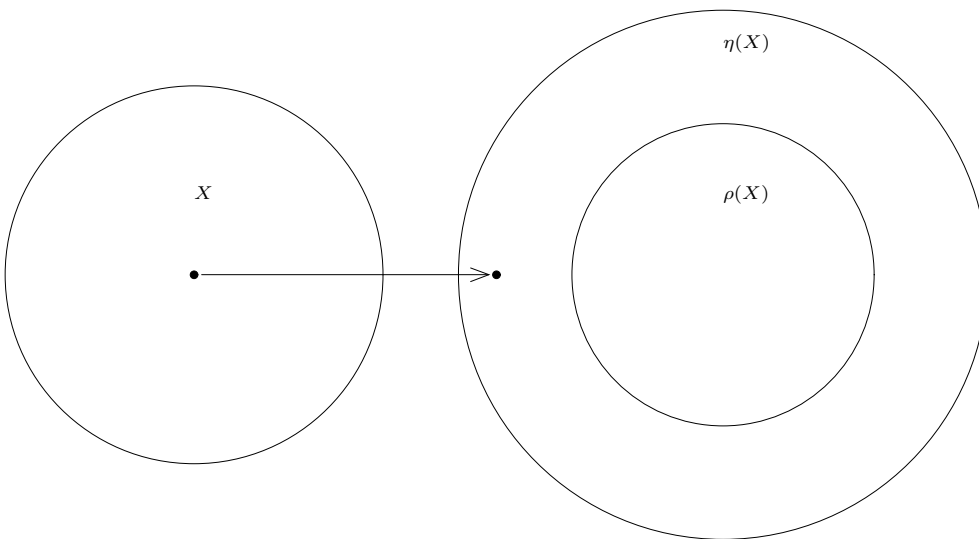

Attacking structure

karl-search= End Diagram Eta-Rho-1

+++++

18.0.58 Diagram Structure-rho-eta

18.0.59 Diagram Structure-rho-eta

karl-search= Start Diagram Structure-rho-eta

Diagram 18.21 LABEL: Diagram Structure-rho-eta

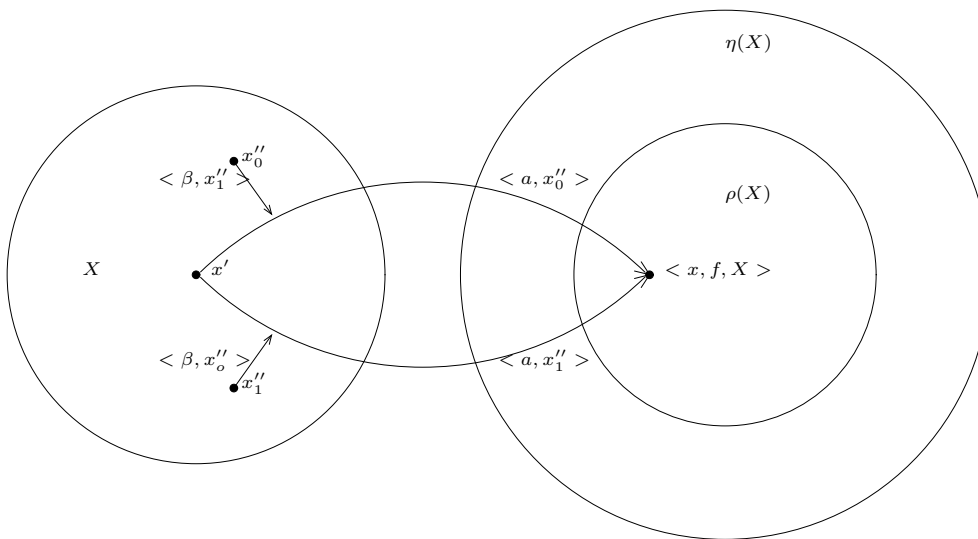

Attacking structure

karl-search= End Diagram Structure-rho-eta

+++++

18.0.60 Diagram Gate-Sem

18.0.61 Diagram Gate Semantics

karl-search= Start Diagram Gate Semantics

Diagram 18.22 LABEL: Diagram Gate-Sem

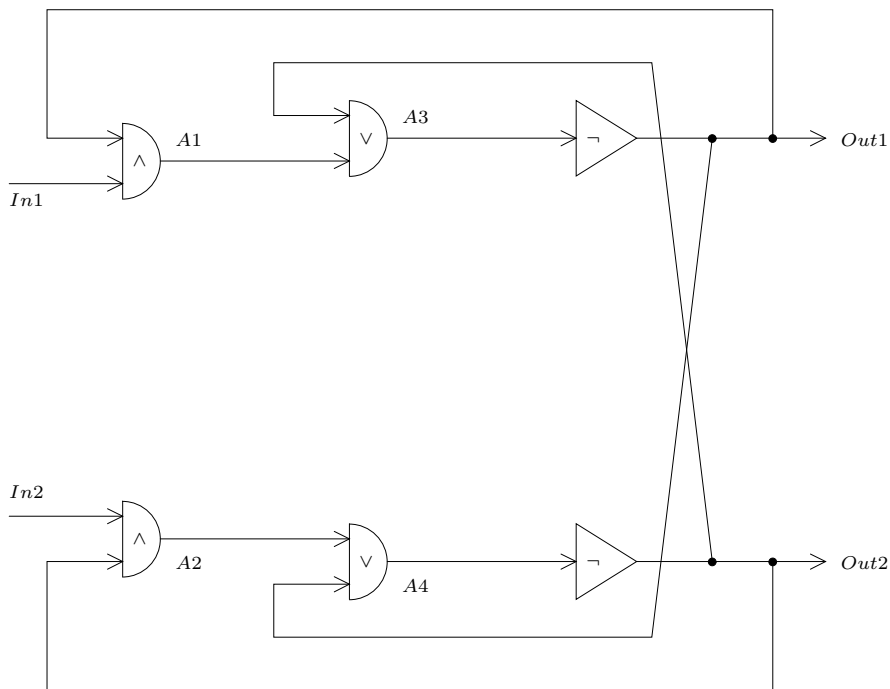

Gate Semantics

karl-search= End Diagram Gate Semantics

+++++

18.0.62 Diagram A-Ranked

18.0.63 Diagram A-Ranked

karl-search= Start Diagram A-Ranked

Diagram 18.23 LABEL: Diagram A-Ranked

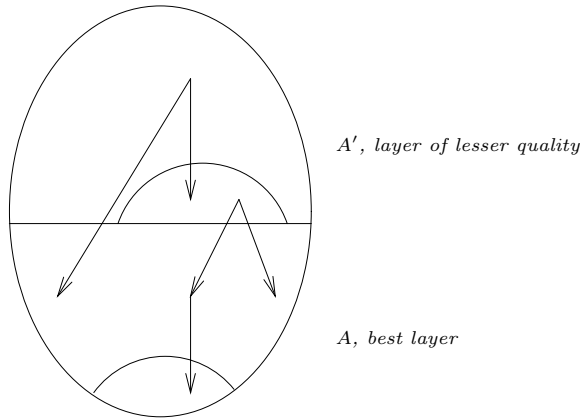

Each layer behaves inside like any preferential structure.
Amongst each other, layers behave like ranked structures.

A- ranked structure

karl-search= End Diagram A-Ranked

+++++

18.0.64 Diagram C-Validity

18.0.65 Diagram C-Validity

karl-search= Start Diagram C-Validity

Diagram 18.24 LABEL: Diagram C-Validity

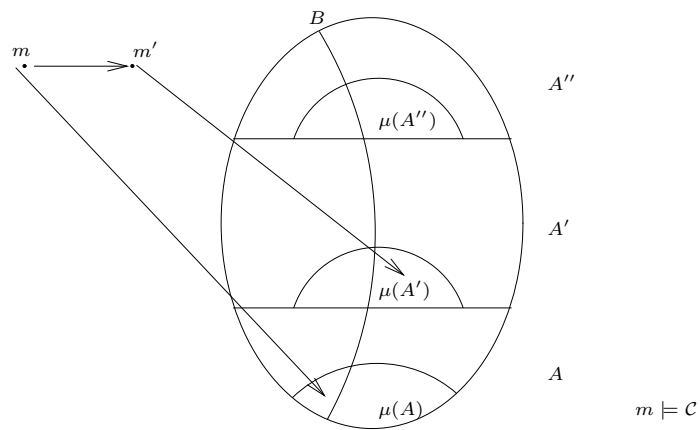

Here, the "best" element m sees is in B , so C holds in m .
 The "best" element m' sees is not in B , so C does not hold in m' .

Validity of C from m and m'

karl-search= End Diagram C-Validity

+++++

18.0.66 Diagram IBRS-Base

18.0.67 Diagram IBRS-Base

karl-search= Start Diagram IBRS-Base

Diagram 18.25 LABEL: Diagram IBRS-Base

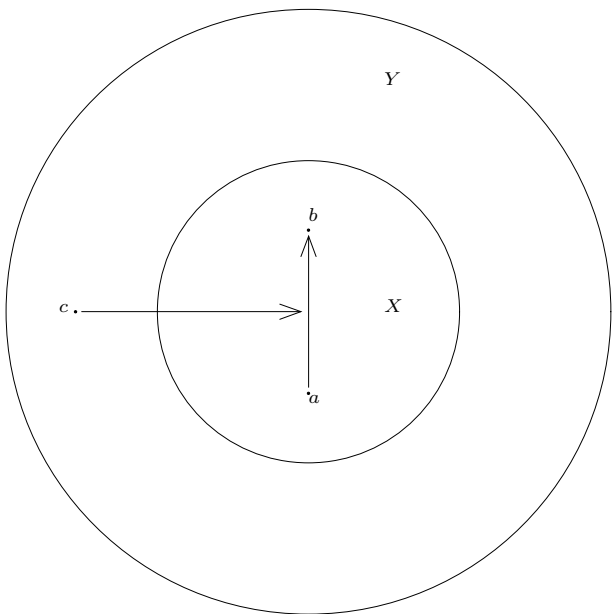

Attacking an arrow

karl-search= End Diagram IBRS-Base

+++++

18.0.68 Diagram Essential-Smooth-Repr

18.0.69 Diagram Essential Smooth Repr

karl-search= Start Diagram Essential Smooth Repr

Diagram 18.26 LABEL: Diagram Essential-Smooth-Repr

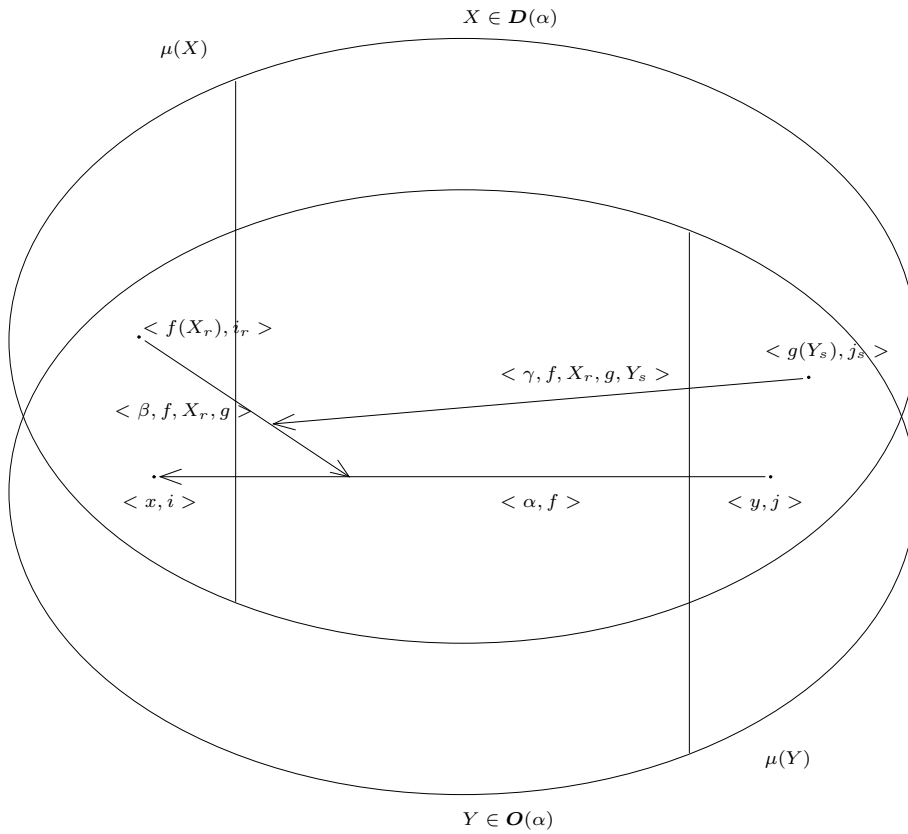

The construction

karl-search= End Diagram Essential Smooth Repr

+++++

18.0.70 Diagram Essential-Smooth-2-1-2

18.0.71 Diagram Essential Smooth 2-1-2

karl-search= Start Diagram Essential Smooth 2-1-2

Diagram 18.27 LABEL: Diagram Essential-Smooth-2-1-2

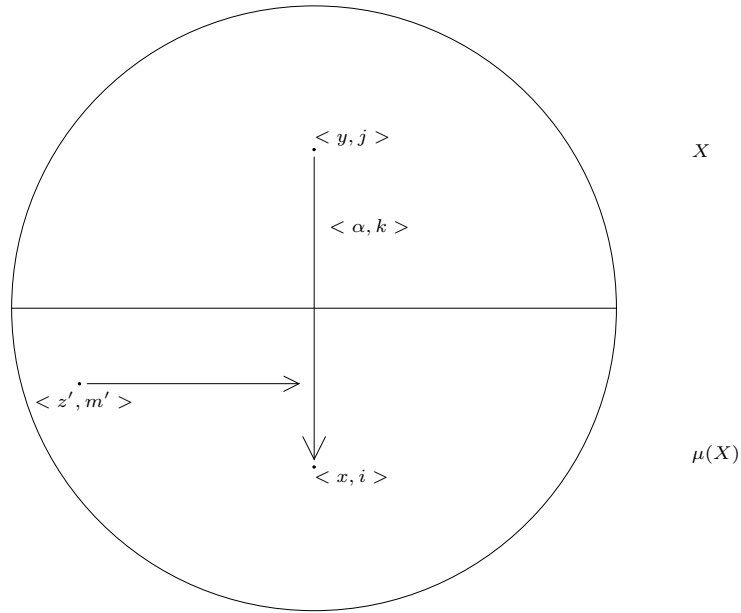

Case 2-1-2

karl-search= End Diagram Essential Smooth 2-1-2

+++++

18.0.72 Diagram Essential-Smooth-3-1-2

18.0.73 Diagram Essential Smooth 3-1-2

karl-search= Start Diagram Essential Smooth 3-1-2

Diagram 18.28 LABEL: Diagram Essential-Smooth-3-1-2

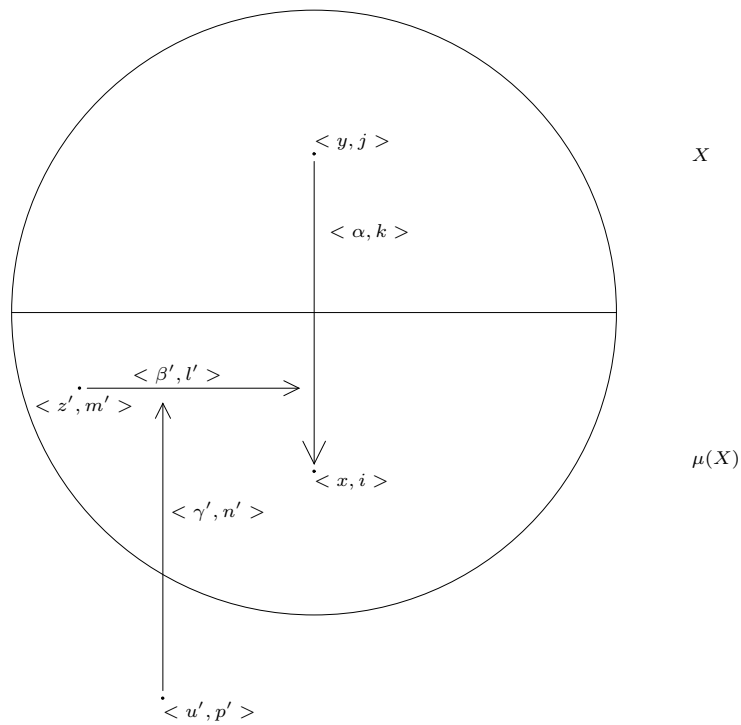

Case 3-1-2

karl-search= End Diagram Essential Smooth 3-1-2

+++++

18.0.74 Diagram Essential-Smooth-3-2

18.0.75 Diagram Essential Smooth 3-2

karl-search= Start Diagram Essential Smooth 3-2

Diagram 18.29 LABEL: Diagram Essential-Smooth-3-2

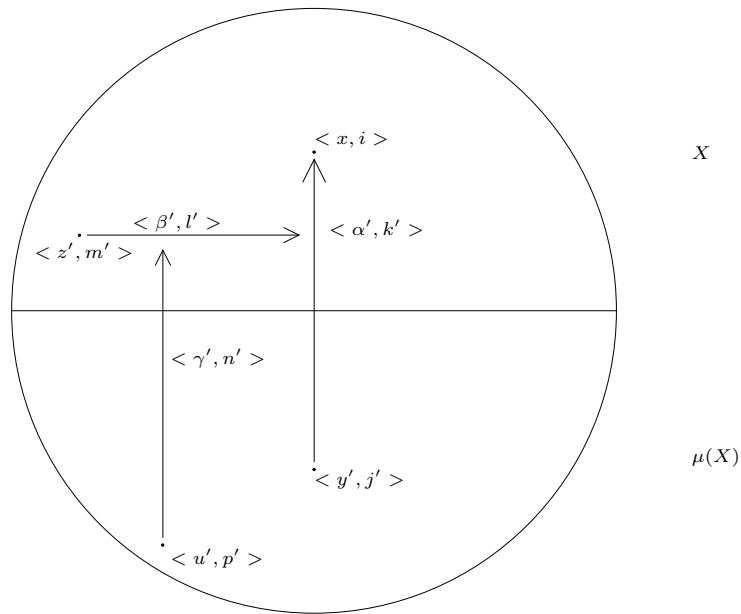

Case 3-2

karl-search= End Diagram Essential Smooth 3-2

+++++

18.0.76 Diagram Essential-Smooth-2-2

18.0.77 Diagram Essential Smooth 2-2

karl-search= Start Diagram Essential Smooth 2-2

Diagram 18.30 LABEL: Diagram Essential-Smooth-2-2

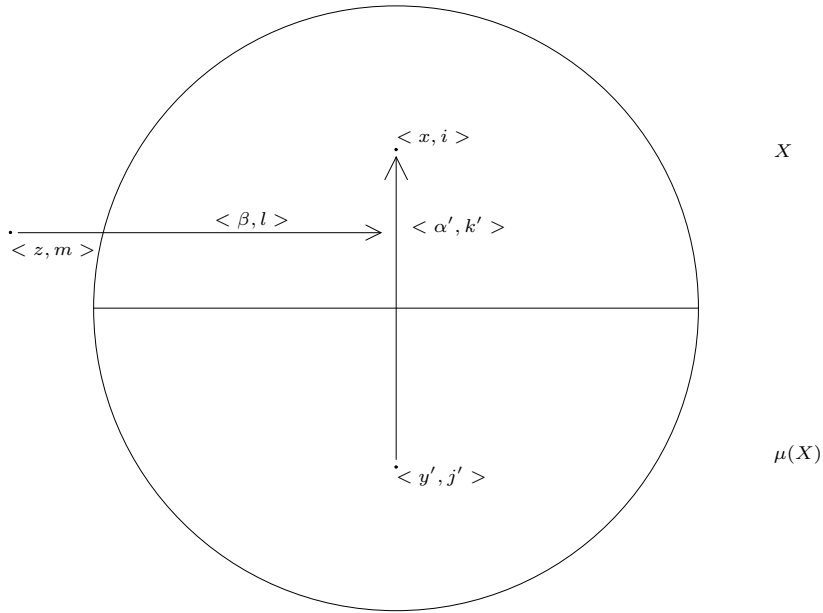

Case 2-2

karl-search= End Diagram Essential Smooth 2-2

+++++

18.0.78 Diagram Condition-rho-eta

18.0.79 Diagram Condition rho-eta

karl-search= Start Diagram Condition rho-eta

For simplicity, $\eta(X) = X$ here

Diagram 18.31 LABEL: Diagram Condition-rho-eta

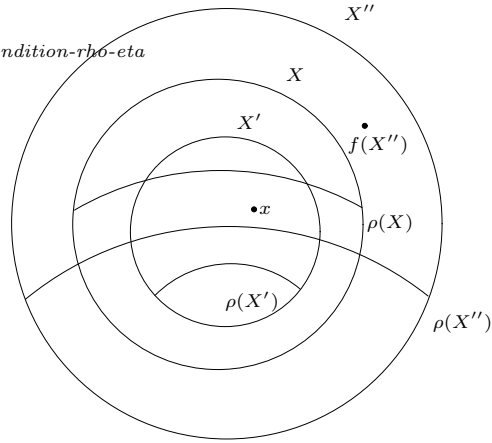

The complicated case

karl-search= End Diagram Condition rho-eta

+++++

18.0.80 Diagram Struc-old-rho-eta

18.0.81 Diagram Struc-old-rho-eta

karl-search= Start Diagram Struc-old-rho-eta

Diagram 18.32 LABEL: Diagram Struc-old-rho-eta

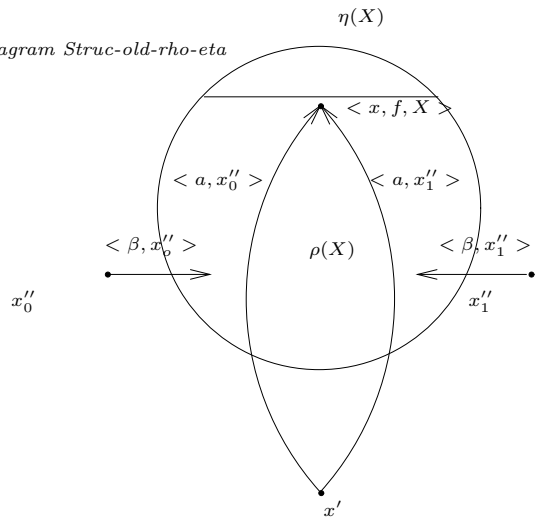

The full structure

karl-search= End Diagram Struc-old-rho-eta

+++++

18.0.82 Diagram Smooth-Level-3

18.0.83 Diagram Smooth Level-3

karl-search= Start Diagram Smooth Level-3

Diagram 18.33 LABEL: Diagram Smooth-Level-3

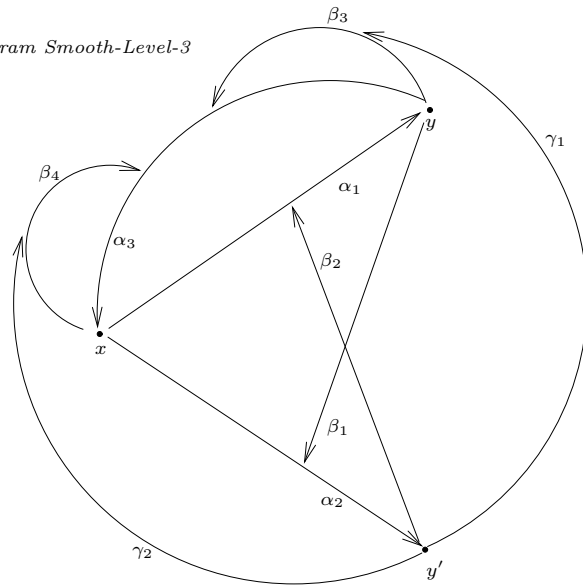

Solution by smooth level 3 structure

karl-search= End Diagram Smooth Level-3

+++++

18.0.84 Diagram Tweety

18.0.85 Diagram Tweety

karl-search= Start Diagram Tweety

Diagram 18.34 LABEL: Diagram Tweety

The Tweety diagram

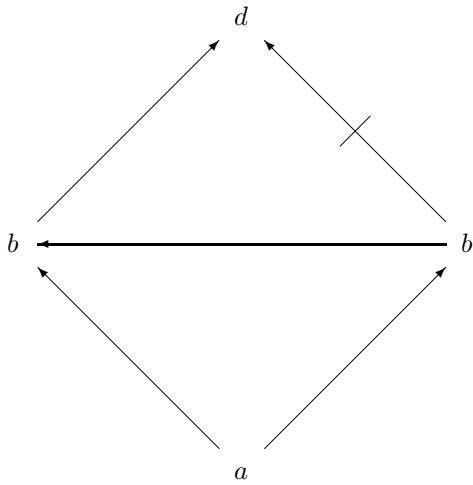

karl-search= End Diagram Tweety

+++++

18.0.86 Diagram Nixon Diamond

18.0.87 Diagram Nixon Diamond

karl-search= Start Diagram Nixon Diamond

Diagram 18.35 LABEL: Diagram Nixon-Diamond

The Nixon Diamond

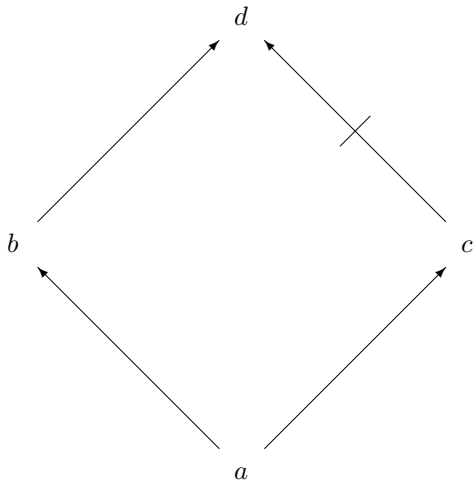

karl-search= End Diagram Nixon Diamond

+++++

18.0.88 Diagram The complicated case

18.0.89 Diagram The complicated case

karl-search= Start Diagram The complicated case

Diagram 18.36 LABEL: Diagram Complicated-Case

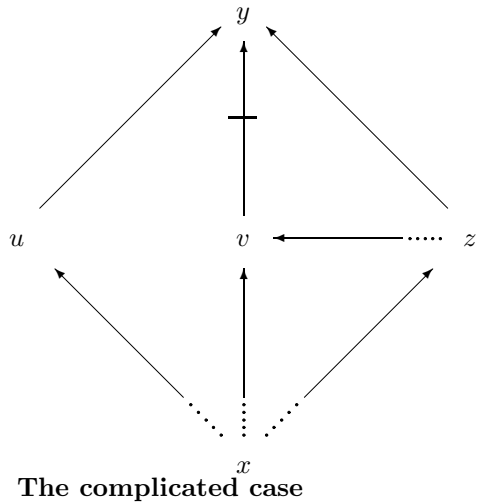

karl-search= End Diagram The complicated case

+++++

18.0.90 Diagram Upward vs. downward chaining

18.0.91 Diagram Upward vs. downward chaining

karl-search= Start Diagram Upward vs. downward chaining

Diagram 18.37 LABEL: Diagram Up-Down-Chaining

The problem of downward chaining

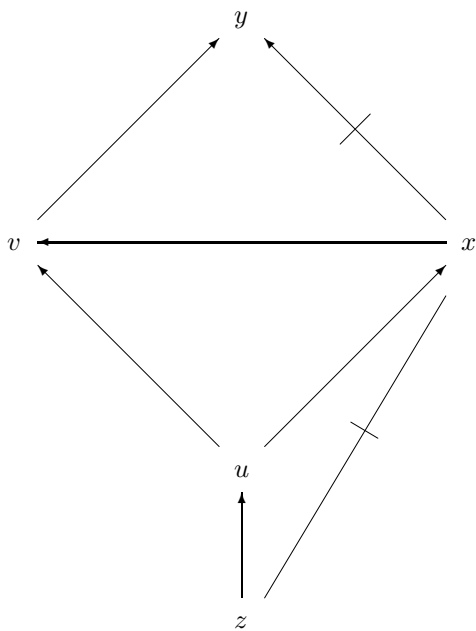

karl-search= End Diagram Upward vs. downward chaining

+++++

18.0.92 Diagram Split vs. total validity preclusion

18.0.93 Diagram Split vs. total validity preclusion

karl-search= Start Diagram Split vs. total validity preclusion

Diagram 18.38 LABEL: Diagram Split-Total-Preclusion

Split vs. total validity preclusion

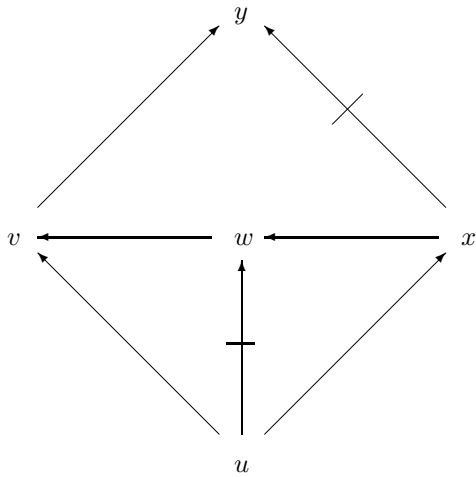

karl-search= End Diagram Split vs. total validity preclusion

+++++

18.0.94 Diagram Information transfer

18.0.95 Diagram Information transfer

karl-search= Start Diagram Information transfer

Diagram 18.39 LABEL: Diagram Information-Transfer

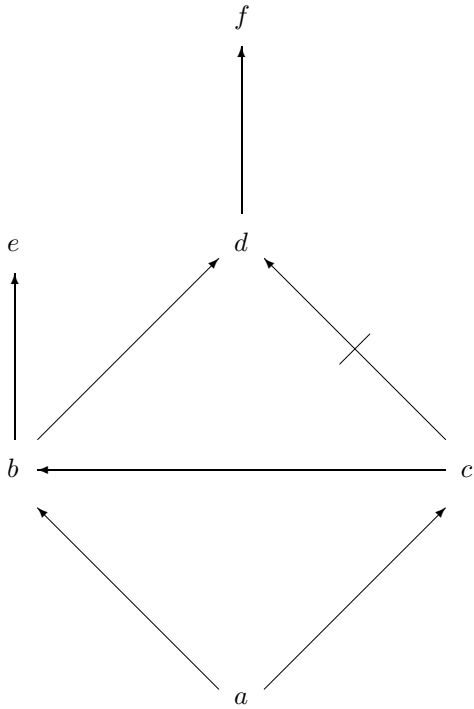

Information transfer

karl-search= End Diagram Information transfer

+++++

18.0.96 Diagram Multiple and conflicting information

18.0.97 Diagram Multiple and conflicting information

karl-search= Start Diagram Multiple and conflicting information

Diagram 18.40 LABEL: Diagram Multiple

Multiple and conflicting information

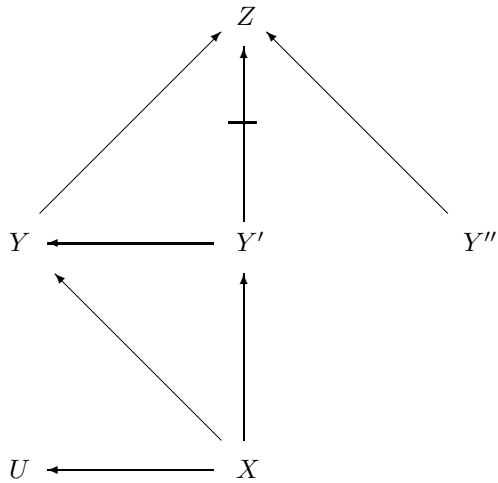

karl-search= End Diagram Multiple and conflicting information

+++++

18.0.98 Diagram Valid paths vs. valid conclusions

18.0.99 Diagram Valid paths vs. valid conclusions

karl-search= Start Diagram Valid paths vs. valid conclusions

Diagram 18.41 LABEL: Diagram Paths-Conclusions

Valid paths vs. valid conclusions

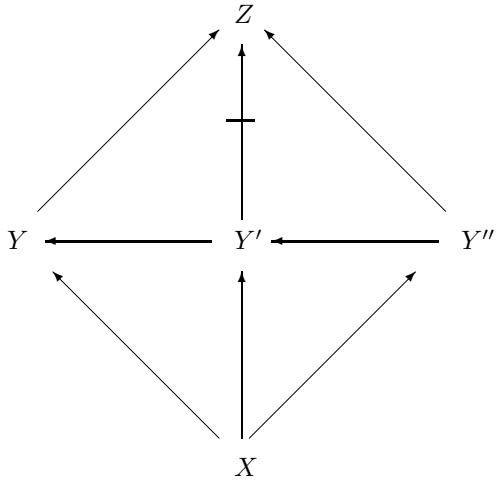

karl-search= End Diagram Valid paths vs. valid conclusions

+++++

18.0.100 Diagram WeakTR

18.0.101 Diagram WeakTR

karl-search= Start Diagram WeakTR

Diagram 18.42 LABEL: Diagram WeakTR

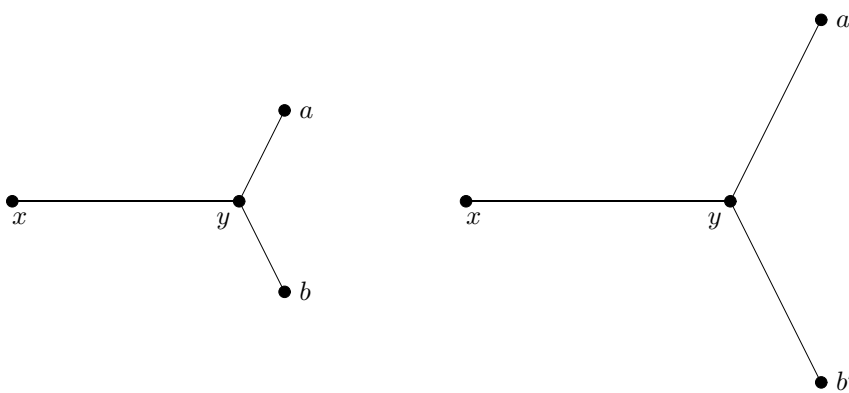

Indiscernible by revision

karl-search= End Diagram WeakTR

+++++

18.0.102 Diagram CumSmall

18.0.103 Diagram CumSmall

karl-search= Start Diagram CumSmall

Diagram 18.43 LABEL: Diagram CumSmall

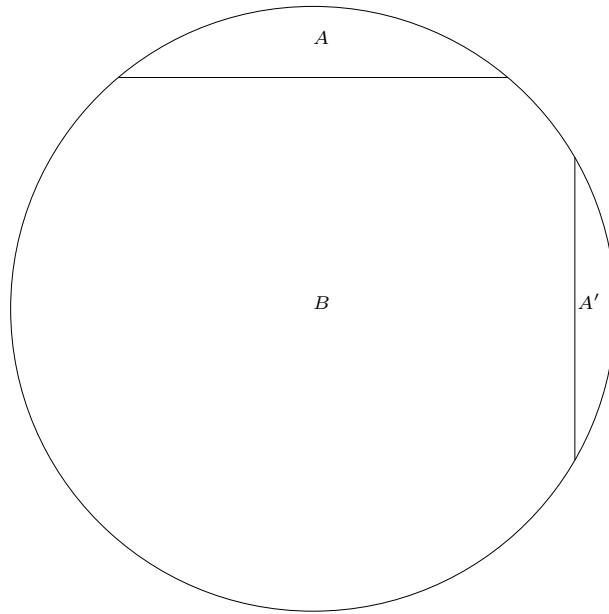

Cumulativity

karl-search= End Diagram CumSmall

References

- [AA00] O.Arieli, A.Avron, “General patterns for nonmonotonic reasoning: from basic entailment to plausible relations”, *Logic Journal of the Interest Group in Pure and Applied Logics*, Vol. 8, No. 2, pp. 119-148, 2000
- [AGM85] C.Alchourron, P.Gardenfors, D.Makinson, “On the Logic of Theory Change: partial meet contraction and revision functions”, *Journal of Symbolic Logic*, Vol. 50, pp. 510-530, 1985
- [BB94] Shai Ben-David, R.Ben-Eliyahu: “A modal logic for subjective default reasoning”, *Proceedings LICS-94*, 1994
- [BGW05] H.Barringer, D.M.Gabbay, J.Woods: Temporal dynamics of support and attack networks: From argumentation to zoology”, *Mechanizing Mathematical Reasoning*, Volume dedicated to Joerg Siekmann, D.Hutter, W.Stephan eds., Springer Lecture Notes in Computer Science 2605, 2005: pp 59-98
- [Dun95] P.M.Dung, “On the acceptability of arguments and its fundamental role in nonmonotonic reasoning, logic programming and n -person games”, *Artificial Intelligence* 77 (1995), p.321-357
- [FH98] N.Friedman, J.Halpern: “Plausibility measures and default reasoning”, IBM Almaden Research Center Tech.Rept. 1995, to appear in *Journal of the ACM*
- [Gab08b] D.M.Gabbay, “Reactive Kripke semantics and arc accessibility”, In *Pillars of Computer Science: Essays dedicated to Boris (Boaz) Trakhtenbrot on the occasion of his 85th birthday*, A.Avron, N.Dershowitz, A.Rabinovich eds., LNCS, vol. 4800, Springer, Berlin, 2008, pp. 292-341
- [KLM90] S.Kraus, D.Lehmann, M.Magidor, “Nonmonotonic reasoning, preferential models and cumulative logics”, *Artificial Intelligence*, 44 (1-2), p.167-207, July 1990
- [LMS01] D.Lehmann, M.Magidor, K.Schlechta: “Distance Semantics for Belief Revision”, *Journal of Symbolic Logic*, Vol.66, No. 1, March 2001, p. 295-317
- [Leh92a] D.Lehmann, “Plausibility logic”, In *Proceedings CSL91*, Boerger, Jaeger, Kleine-Buening, Richter eds., 1992, p.227-241
- [Leh92b] D.Lehmann, “Plausibility logic”, Tech.Rept. TR-92-3, Feb. 1992, Hebrew University, Jerusalem 91904, Israel
- [Sch04] K.Schlechta: “Coherent Systems”, Elsevier, Amsterdam, 2004
- [Sch92] K.Schlechta: “Some results on classical preferential models”, *Journal of Logic and Computation*, Oxford, Vol.2, No.6 (1992), p. 675-686
- [Sch95-1] K.Schlechta: “Defaults as generalized quantifiers”, *Journal of Logic and Computation*, Oxford, Vol.5, No.4, p.473-494, 1995
- [Sch96-1] K.Schlechta: “Some completeness results for stoppered and ranked classical preferential models”, *Journal of Logic and Computation*, Oxford, Vol. 6, No. 4, pp. 599-622, 1996
- [Sch96-3] K.Schlechta: “Completeness and incompleteness for plausibility logic”, *Journal of Logic, Language and Information*, 5:2, 1996, p.177-192, Kluwer, Dordrecht