

Feedforwarding Channel State Information in Relay Networks

Cenk M. Yetis*, *Student Member, IEEE*, and Ahmet H. Kayran, *Senior Member, IEEE*

Abstract

Channel estimation via training is a common method for providing imperfect channel state information (CSI) in a network. In a relay network, imperfect CSI can be efficiently provided at the relays by sending training signals from the source and the destination nodes to the relays. Providing imperfect CSI at the destination is more challenging since each relay is required to send training signals to the destination. We introduce the feedforwarding method, where each relay simply forwards the imperfect CSI to the destination in such a way that we benefit from the relay network structure to carry the information for us. This method significantly lowers the network resources spent on providing the imperfect CSI at the destination. In addition, we prove that the feedforwarding method provides better average effective signal to noise ratio (eSNR) compared to the training methods currently known in the literature. The eSNR is an important parameter in the channel capacity expressions. Therefore, the parameters of a network with training could be optimized in order to maximize the eSNR. In our setup, source, relay and destination nodes have M , N and M antennas, respectively. We use matched filtering at the relays and single antenna decoding at the destination, where each source antenna communicates to a separate destination antenna via K relays. We achieve our results at large K .

Index Terms

Relay networks, imperfect channel state information (CSI), channel estimation, effective SNR, capacity, training.

C. M. Yetis is with Informatics Institute, Satellite Remote Sensing and Communication, Istanbul Technical University, Maslak, Istanbul, 34469, TURKEY. Email: cenkmyetis@yahoo.com. The author is supported in part by The Scientific and Technological Research Council of Turkey (TUBITAK). The author is on leave at University of California, Irvine.

A. H. Kayran is with Department of Electronics and Communications Engineering, Istanbul Technical University, Maslak, Istanbul, 34469, TURKEY. Email: kayran@itu.edu.tr.

I. INTRODUCTION

Multiple-input multiple-output (MIMO) technology is the corner stone of next generation wireless networks, which is supported by IEEE 802.11n (WiFi) and 802.16e (WiMax) standards, due to its capacity, coverage and diversity advantages [1]. Future WiMax networks with additional type of nodes, relays, are currently being standardized under 802.16j. Relays increase capacity and coverage. In addition, relays are effective in dealing with the non line-of-sight problem. Furthermore, relays do not require backhaul resulting in less complex and cost efficient designs [2,3].

The signal to noise ratio (SNR) of the effective channel between the source and destination nodes is known as effective SNR (eSNR). The parameters of a point-to-point network (P2PN) with training could be optimized in order to maximize the eSNR [4,5]. The eSNR is also considered in industry including 802.16m [6,7]. The main purpose of this study is to introduce the feedforwarding method, which is more efficient and provides better average eSNR performance than the training methods currently known in the literature.

Most of the studies in relay networks assume that the destination has the perfect channel state information (CSI) [8]–[13], which may not necessarily be the best approach in practice. The perfect CSI assumption is suitable for a network with slow fading channels (i.e. Indoor environments). The innovative feedforwarding method efficiently provides the effective CSI at the destination. In [14]–[16], the effective CSI is estimated at the destination, where amplify and feedforwarding is applied at the relays. This method is suitable for nomadic relays and fixed destination [2]. Amplify and feedforwarding always perform poor than matched filtering (MF). We focus on relays, where MF is applied with imperfect CSI. Additionally, we feedforward CSI to the destination. This method is suitable for fixed relays and mobile destination. Imperfect CSI at the relays is only studied in [17]. In [17], they consider a single antenna relay network with deterministic equivalent channel model [9,11,12,17]. Whereas we consider multi-antenna relay network with ergodic channels [18]. To the best of our knowledge, the previously mentioned papers are the only studies on channel estimation via training in relay networks. However, there exists a vast literature on channel estimation via training in P2PNs (see [19,20] and the references therein). The reader is also directed to [21], which discusses the CSI effects on the channel capacity of P2PNs.

In our setup, we consider two-hop relay networks, where source node transmits data signals to the relays at the first hop and at the second hop, relays transmit their received signals to the destination as seen in Fig. 1(a). We also consider single antenna decoding at the destination, where designated

end node (source and destination nodes) antenna pairs communicate (each source antenna communicates to a separate destination antenna) through assigned relays as seen in Fig. 1(b). Assigning the relays (subgrouping the relays) is named relay partitioning [8].

A. Notation

Bold characters denote vectors. $E\{\cdot\}$, $(\cdot)^*$, $(\cdot)^T$ and $\text{Tr}\{\cdot\}$ denote expectation, Hermitian, transpose and trace operators, respectively. $CN(\mu, \sigma^2)$ stands for a complex Gaussian random variable with mean μ and variance σ^2 . $\text{var}\{\cdot\}$ denotes the power of a vector or a scalar.

B. Outline

In Section II, we introduce the main results. In Section III, we introduce the complementary results including the numerical results. In Section IV, we conclude.

II. MAIN RESULTS

A. Channel and Signal Models

We assume fixed number of antennas at each node. In addition, we assume that there is no direct link between source and destination layers. The relays use MF with either imperfect or perfect CSI. We assume independent data signals are sent from source antennas (spatial multiplexing). We use block fading channel model, where channel coefficients do not change in a coherence interval, T (symbols per channel use), and change independently in the consequent intervals. We denote the time spent on the data transmission phase with T_d . We focus on data transmission phase and assume other phases, including training and feedforwarding phases, are already accomplished. We do not consider path-loss and shadowing effects. We assume all channels, transmitted signals and noises are complex Gaussian random variables with zero means and generic variances. We assume half-duplex communication, where the nodes cannot transmit and receive simultaneously. Finally, we assume minimum mean square error (MMSE) channel estimation is used at the relays, which provides an unbiased estimate that is uncorrelated with the channel estimation error [22].

In single antenna decoding method, we assume x^{th} ($x = 1, 2, \dots, M$) source and x^{th} destination antennas are assigned to each other for notational simplicity. Each antenna pair is served by a subgroup of K relays, thus we have M subgroups (relay partitioning). The subgroup, which serves for the x^{th} antenna pair is denoted by \mathcal{L}^x ($x = 1, 2, \dots, M$). We use $M_{[1]} \times N_{[MK]} \times M_{[1]}$ notation to represent our network setup, which is shown in Fig. 2. $M \times N \times M$ denotes that each node in source, relay and

destination layer has M , N and M antennas, respectively. The numbers in the square brackets denote the number of the nodes at the respective layers. Therefore, $M_{[1]} \times N_{[MK]} \times M_{[1]}$ denotes that source layer has one node with M antennas, relay layer has MK nodes each with N antennas and destination layer has one node with M antennas.

Considering the communication between the i^{th} antenna pair, the received signal at the k^{th} relay in the i^{th} subgroup is given as:

$$\mathbf{r}_{ik} = \sqrt{\rho_S} \left(\mathbf{s}^i \mathbf{h}_{ik}^i + \sum_{\substack{j=1 \\ j \neq i}}^M \mathbf{s}^j \mathbf{h}_{ik}^j \right) + \mathbf{n}_{ik}, \quad i = 1, 2, \dots, M \text{ and } k = 1, 2, \dots, K, \quad (1)$$

where ρ_S is the power spent by source for data transmission and \mathbf{s}^y is the $T_d \times 1$ source signal vector transmitted from the y^{th} antenna with independent and identically distributed (i.i.d.) $CN(0, \sigma_{s^y}^2)$ entries. \mathbf{h}_{xk}^y is the backward channel, which is a $1 \times N$ vector and has i.i.d. $CN(0, \sigma_{h_{xk}^y}^2)$ entries, between the y^{th} source antenna and the k^{th} relay in the x^{th} subgroup. \mathbf{n}_{xk} is the noise at each relay of the x^{th} subgroup and has i.i.d. $CN(0, \sigma_{n_x}^2)$ entries. Note that the second term in the parenthesis of (1) is the interference.

After each relay applies MF, the received signal at the i^{th} destination antenna is given as:

$$\mathbf{y}^i = \sqrt{\frac{\rho_R}{N}} \left(\sum_{k, R_k \in \mathcal{L}^i} \mathbf{t}_{ik} \mathbf{g}_{ik}^i + \sum_{\substack{j=1 \\ j \neq i}}^M \left(\sum_{k, R_k \in \mathcal{L}^j} \mathbf{t}_{jk} \mathbf{g}_{jk}^j \right) \right) + \mathbf{z}^i, \quad i = 1, 2, \dots, M \text{ and } k = 1, 2, \dots, K, \quad (2)$$

where ρ_R is the power spent by each relay and \mathbf{t}_{xk} is the transmitted signal at the k^{th} relay in the x^{th} subgroup. The k^{th} relay is denoted by R_k ($k = 1, 2, \dots, K$). \mathbf{g}_{xk}^y is the forward channel, which is a $N \times 1$ vector and has i.i.d. $CN(0, \sigma_{g_{xk}^y}^2)$ entries, between the y^{th} destination antenna and the k^{th} relay in the x^{th} subgroup. \mathbf{z}^y is the noise at the y^{th} destination antenna and has i.i.d. $CN(0, \sigma_{z^y}^2)$ entries. The desired source signal is represented with i and the interfering signals are represented with j ($j = 1, 2, \dots, M$ and $j \neq i$) as also seen in Fig. 2.

Unlike [8], we do not assume that all backward and forward channel variances are equal and normalized to unity. Instead, we use a more generic scenario as seen in Fig. 2. As an example, consider a $2_{[1]} \times 1_{[4]} \times 2_{[1]}$ relay network with relay partitioning in Fig. 3. Here, we assume that the channel variances of the relays in a subgroup seen by each antenna are equal. i.e. The channel variances between source (destination) antenna of pair 1 and the relays in the subgroup \mathcal{L}^1 are $\sigma_{h_1}^2$ ($\sigma_{g_1}^2$). We normalize the channel variances to unity in only numerical analysis for convenience.

B. Methods and Schemes

We compare the feedforwarding method (M1) to the classical (M2) [4] and the new training methods (M3) [15]. Consider a noiseless single antenna relay network with K relays, where amplify and feedforwarding method with an amplification constant 1 is applied. Therefore, $y = \sqrt{\rho} \left(\sum_{k=1}^K h_k g_k \right) s$ is received at the destination, where ρ denotes the power normalization factor. h_k (g_k) denotes the backward (forward) channel between the source node and the k^{th} relay (between the k^{th} relay and the destination node). We assume that in M2, destinations knows the estimates of each h_k and g_k separately; whereas in M3, the estimates of each $h_k g_k$. On the other hand, in M1, the destination knows the estimate of $\left(\sum_{k=1}^K h_k g_k \right)$ directly.

After proving that M1 has higher average eSNR than M2 and M3, we compare M1 with challenging schemes shown in Fig. 4, where the lines between the layers denote the MF directions. Consider a single antenna relay network with K relays. In scheme C1a, each relay applies MF with h_k^* and g_k^* . Therefore, $\sqrt{\rho} \sum_{k=1}^K s |h_k|^2 |g_k|^2 + V$ is received at the destination, where s and V denote the source signal and the overall noise, respectively. We assume that the destination knows the effective CSI, $\sqrt{\rho} \sum_{k=1}^K |h_k|^2 |g_k|^2$. In scheme C1b, each relay applies MF with \hat{h}_k^* and \hat{g}_k^* , where \hat{h}_k and \hat{g}_k denote the MMSE estimates of the backward and forward channels. Therefore, $\sqrt{\rho} \sum_{k=1}^K s h_k \hat{h}_k^* \hat{g}_k^* g_k + V$ is received at the destination. We assume that the destination knows the effective CSI, $\sqrt{\rho} \sum_{k=1}^K h_k \hat{h}_k^* \hat{g}_k^* g_k$. In scheme C2, each relay applies the same MF with C1b and therefore, the same signal is received at the destination. Each relay feedforwards $A_k = \hat{h}_k \hat{h}_k^* \hat{g}_k^*$ to the destination. Therefore, the destination has the effective CSI, $\sqrt{\rho'_{R,f}} \sum_{k=1}^K \hat{h}_k \hat{h}_k^* \hat{g}_k^* g_k + z^f$, where $\rho'_{R,f}$ and z^f denote the power normalization factor and the zero mean complex Gaussian noise during the feedforwarding phase.

C. The eSNRs of C1a and C2 with Simplifications

We evaluate the eSNRs of C1a and C2 with and without simplifications in this sub-section and in Appendix V-A, respectively. Note that our main conclusions also hold for non-zero mean channels. However, the complicated expressions in (7) become more involved without zero mean channel assumption.

Theorem 1: For the scheme C1a with $M = N = T_d = 1$ and large K ,

$$\rho_{\text{eff}} = \frac{\rho S(K+3)}{2} \sigma_h^2 \frac{\sigma_s^2}{\sigma_n^2}.$$

Proof: The received signal at each relay is given as:

$$r_k = \sqrt{\rho_S} s h_k + n_k, \quad k = 1, 2, \dots, K.$$

Then, each relay applies MF with the perfect backward CSI, h_k^* :

$$u_k = r_k h_k^*.$$

The above signal is normalized to unit average power:

$$\mathbb{E} \left\{ |u_k|^2 \right\} = \rho_S \mathbb{E} \left\{ |s|^2 |h_k|^4 \right\} + \mathbb{E} \left\{ |n_k h_k|^2 \right\} = \rho_S 2 \sigma_s^2 \sigma_{h_k}^4 + \sigma_{n_k}^2 \sigma_{h_k}^2$$

by using the following equality from [23]:

$$\mathbb{E} \left\{ |h_k|^4 \right\} = 2 \sigma_{h_k}^4,$$

where $\sigma_{h_k}^4 = \sigma_{h_k}^2 \sigma_{h_k}^2$. Then, each relay applies MF with the perfect forward CSI, g_k^* . Considering the power constraint $\mathbb{E} \{ |t_k|^2 \} = 1$ at each relay, the transmitted signal from the k^{th} relay is given as:

$$t_k = \frac{r_k h_k^* g_k^*}{\sqrt{(\rho_S 2 \sigma_{h_k}^2 \sigma_s^2 + \sigma_{n_k}^2) \sigma_{h_k}^2 \sigma_{g_k}^2}}.$$

The received signal at the destination is given as:

$$y = y^{\text{sig}} + v,$$

where

$$y^{\text{sig}} = \sum_{k=1}^K \sqrt{\rho_k} s |h_k|^2 |g_k|^2, \quad v = \sum_{k=1}^K \sqrt{\frac{\rho_k}{\rho_S}} n_k h_k^* |g_k|^2 + z,$$

and

$$\rho_k = \frac{\rho_R \rho_S}{(\rho_S 2 \sigma_{h_k}^2 \sigma_s^2 + \sigma_{n_k}^2) \sigma_{h_k}^2 \sigma_{g_k}^2}.$$

y^{sig} and v are the received desired and noise signals at the destination, respectively.

Note that the effective channel and the overall noise, $\sum_{k=1}^K \sqrt{\rho_k} |h_k|^2 |g_k|^2$ and v , are not Gaussian due to the product of multiple Gaussian random variables [24]. However, we use central limit theorem due to large number of relays by observing that the effective CSI and the overall noise are composed of independent terms.

Then, eSNR is evaluated as follows:

$$\rho_{\text{eff}} = \frac{\mathbb{E} \left\{ |y^{\text{sig}}|^2 \right\}}{\mathbb{E} \left\{ |v|^2 \right\}}.$$

Now, we evaluate the numerator and denominator of the above equation step by step:

$$\begin{aligned}
\mathbb{E} \left\{ |y^{sig}|^2 \right\} &= \mathbb{E} \left\{ \sum_{k=1}^K \rho_k |s|^2 |h_k|^4 |g_k|^4 \right\} + \mathbb{E} \left\{ \sum_{\substack{k,m=1 \\ k \neq m}}^K \sqrt{\rho_k \rho_m} |s|^2 |h_k|^2 |h_m|^2 |g_k|^2 |g_m|^2 \right\} \\
&= 4K \rho \sigma_s^2 \sigma_h^4 \sigma_g^4 + K(K-1) \rho \sigma_s^2 \sigma_h^4 \sigma_g^4 \\
&= K(K+3) \rho \sigma_s^2 \sigma_h^4 \sigma_g^4. \\
\mathbb{E} \left\{ |v|^2 \right\} &= \mathbb{E} \left\{ \sum_{k=1}^K \frac{\rho_k}{\rho_S} |n_k|^2 |h_k|^2 |g_k|^4 \right\} + \mathbb{E} \left\{ \sum_{\substack{k,m=1 \\ k \neq m}}^K \sqrt{\frac{\rho_k \rho_m}{\rho_S^2}} n_k n_m^* h_k h_m^* |g_k|^2 |g_m|^2 \right\} + \sigma_z^2 \\
&= 2K \frac{\rho}{\rho_S} \sigma_n^2 \sigma_h^2 \sigma_g^4 + 0 + \sigma_z^2.
\end{aligned}$$

The third steps in the above evaluations are obtained by assuming all backward and forward channel variances are equal within themselves. That is, $\sigma_{h_k}^2 = \sigma_h^2$ and $\sigma_{g_k}^2 = \sigma_g^2$, which also leads to $\rho_k = \rho$ for $k = 1, 2, \dots, K$.

As a result, we obtain the following eSNR:

$$\rho_{\text{eff}} = \frac{K(K+3) \rho \sigma_s^2 \sigma_h^4 \sigma_g^4}{2K \frac{\rho}{\rho_S} \sigma_n^2 \sigma_h^2 \sigma_g^4 + \sigma_z^2} \approx \frac{\rho_S (K+3)}{2} \sigma_h^2 \frac{\sigma_s^2}{\sigma_n^2},$$

when K is large. ■

Theorem 2: For the scheme C2 with $M = N = T_d = 1$ and large K ,

$$\rho_{\text{eff}} = \frac{\sigma_s^2 \left(2\sigma_h^2 \left(\sigma_g^2 + \sigma_g^2 \right) + (K-1) \sigma_h^2 \sigma_g^2 \right)}{\left(\sigma_g^2 + \sigma_g^2 \right) \left(\sigma_s^2 \sigma_h^2 + \frac{\sigma_n^2}{\rho_S} \right)}. \quad (3)$$

Proof: In C2, each relay applies MF with the imperfect backward and forward CSI, \hat{h}_k^* and \hat{g}_k^* , respectively. Following the same approach in C1a, the received signal at the destination is given as:

$$y = \sum_{k=1}^K \sqrt{\rho_k} s h_k \hat{h}_k^* \hat{g}_k^* g_k + \sum_{k=1}^K \sqrt{\frac{\rho_k}{\rho_S}} n_k \hat{h}_k^* \hat{g}_k^* g_k + z, \quad (4)$$

where

$$\rho_k = \frac{\rho R \rho_S}{\left(\rho_S \left(2\sigma_{h_k}^2 + \sigma_{h_k}^2 \right) \sigma_s^2 + \sigma_{n_k}^2 \right) \sigma_{h_k}^2 \sigma_{g_k}^2}.$$

During the feedforwarding phase, each relay transmits $A_k = \hat{h}_k \hat{h}_k^* \hat{g}_k^*$ to the destination. Therefore, the received signal at the destination is given as:

$$\sum_{k=1}^K \sqrt{\rho'_{R,f}} \hat{h}_k \hat{h}_k^* \hat{g}_k^* g_k + z^f.$$

$\rho_{R,f}$ is the power spent by each relay and z^f is the noise during the feedforwarding phase. Then, $\rho'_{R,f}$ is the normalized power, where $\rho'_{R,f} = \frac{\rho_{R,f}}{\text{var}\{A_k g_k\}}$. Assuming that all backward and forward channel variances are equal within themselves and the destination knows $\rho'_{R,f}$ noiselessly, the destination has the following effective CSI:

$$\sqrt{\rho} \left(\sum_{k=1}^K \hat{h}_k \hat{h}_k^* \hat{g}_k^* g_k + \frac{z^f}{\sqrt{\rho'_{R,f}}} \right). \quad (5)$$

We rewrite the received signal (4) according to the noisy effective CSI (5) as follows:

$$\begin{aligned} y &= \sqrt{\rho} \left(\sum_{k=1}^K \hat{h}_k \hat{h}_k^* \hat{g}_k^* g_k + \frac{z^f}{\sqrt{\rho'_{R,f}}} \right) s \\ &+ \sqrt{\rho} \left(\sum_{k=1}^K \tilde{h}_k \hat{h}_k^* \hat{g}_k^* g_k - \frac{z^f}{\sqrt{\rho'_{R,f}}} \right) s + \sqrt{\frac{\rho}{\rho S}} \sum_{k=1}^K n_k \hat{h}_k^* \hat{g}_k^* g_k + z \end{aligned}$$

At this point, we use the worst-case noise theorem [25] by observing that the source signal and the overall noise are uncorrelated given CSI at the destination (see theorem 4.0.2 in [26] for the details). We prove the validity of this condition for the multiple antenna case in Appendix V-A.2. Following the same approach in C1a to evaluate eSNR, we obtain (3) when K is large. ■

Corollary 3: The feedforwarding method provides higher average eSNR than the classical [4] and the new [15] training methods.

Proof: Consider that relays apply MF with imperfect backward and forward CSI. Therefore, (4) is received at the destination. The overall noise at the destination in (4) is same for all of the methods. Therefore, we neglect this term in evaluating the eSNR.

In M1, both source and destination nodes send training signals to the relays. Then, relays estimate the channels and feedforward the channel estimations to the destination in such a way that the relay network carries the perfect forward CSI, g , to the destination for us. By neglecting the overall noise in (4), we rewrite (4) since destination knows $\sqrt{\rho} \sum_{k=1}^K \hat{h}_k \hat{h}_k^* \hat{g}_k^* g_k$ as follows:

$$y = \sqrt{\rho} \sum_{k=1}^K s \hat{h}_k \hat{h}_k^* \hat{g}_k^* g_k + \sqrt{\rho} \sum_{k=1}^K \tilde{s} \hat{h}_k \hat{h}_k^* \hat{g}_k^* g_k. \quad (6)$$

Since we have already presented the eSNR of the feedforwarding method in (3), we do not repeat the result.

In the classical training method (M2), classical P2PN training is applied for both backward and forward channels. For the backward channels, source node sends training signals to the relays. Then, relays estimate the backward channels and feedforward the backward channel estimations to the destination.

For the forward channels, relays send training signals to the destination and destination estimates the forward channels. By neglecting the overall noise in (4), we rewrite (4) since destination knows each \hat{h}_k and \hat{g}_k ($k = 1 \dots K$) as follows:

$$y = \sqrt{\rho} \sum_{k=1}^K s \hat{h}_k \hat{h}_k^* \hat{g}_k^* \hat{g}_k + \sqrt{\rho} \sum_{k=1}^K s \left(\hat{h}_k \hat{h}_k^* \hat{g}_k^* \tilde{g}_k + \tilde{h}_k \hat{h}_k^* \hat{g}_k^* g_k \right).$$

The eSNR of the classical training method is as follows:

$$\rho^{\text{eff}} = \frac{(K+3) \sigma_h^2 \sigma_g^2}{2\sigma_h^2 \sigma_g^2 + \sigma_h^2 \sigma_g^2 + \sigma_h^2 \sigma_g^2}.$$

In the new training method (M3) [15], the destination estimates the product of backward and forward channels, $a_k = h_k g_k$. In M3, only source nodes send training signals to the relays. Then, relays simply feedforward the training signals to the destination. As a result, they also benefit from the relay network structure to include the forward channel in the training signal. Finally, the destination estimates the product of backward and forward channels. By neglecting the overall noise in (4), we rewrite (4) since destination knows each \hat{a}_k ($k = 1 \dots K$) as follows:

$$y = \sqrt{\rho} \sum_{k=1}^K s \hat{a}_k \hat{a}_k^* + \sqrt{\rho} \sum_{k=1}^K s \tilde{a}_k \tilde{a}_k^*,$$

where we assume $\hat{a}_k = \hat{h}_k \hat{g}_k$. This assumption leads to $\tilde{a}_k = \hat{h}_k \tilde{g}_k + \tilde{h}_k g_k$ equality to hold.

The eSNR is evaluated as follows:

$$\rho^{\text{eff}} = \frac{\mathbb{E} \left\{ \sum_{k,m=1}^K |\hat{a}_k|^2 |\hat{a}_m|^2 \right\}}{\mathbb{E} \left\{ \sum_{k=1}^K |\tilde{a}_k \hat{a}_k|^2 \right\}} = \frac{K(K+1) \sigma_a^4}{K \sigma_a^2 \sigma_a^2} = \frac{(K+1) \sigma_h^2 \sigma_g^2}{\sigma_h^2 \sigma_g^2 + \sigma_h^2 \sigma_g^2}.$$

We use the results of [27] in order to determine the variances of a_k , \hat{a}_k and \tilde{a}_k , which we discuss in detail in Appendix V-B. The orthogonality of \hat{a}_k and \tilde{a}_k is still preserved by using the results of [27]. In addition, $\sigma_a^2 = \sigma_{\hat{a}}^2 + \sigma_{\tilde{a}}^2$ and $a_k = \hat{a}_k + \tilde{a}_k$ equalities are still satisfied.

We numerically analyze the results for $K = 20$ since this value is large when compared to $M = N = 1$. We evaluate the eSNRs by changing estimated backward and forward channel variances discretely from 0.1 to 0.9 by 0.1 increments. By averaging all eSNRs, we obtain 17.01, 6.14 and 10.29 for M1, M2 and M3, respectively. Therefore, the eSNR performances of the methods are $M1 > M3 > M2$. Without evaluating the eSNRs, we can also reach to the conclusion that the eSNR of M1 is higher than the eSNRs of both M2 and M3 by only observing that $\sqrt{\rho} \sum_{k=1}^K s \hat{h}_k \hat{h}_k^* \hat{g}_k^* \hat{g}_k$ has higher power than $\sqrt{\rho} \sum_{k=1}^K s \hat{h}_k \hat{h}_k^* \hat{g}_k^* \tilde{g}_k$. ■

Note that, for a time division duplexed training, the time spent between relays and destination to provide the required CSI at the destination is $2K$, K and 1 symbol durations for M2, M3 and M1, respectively. Therefore, M1 does not only provide higher average eSNR but also provides higher efficiency than M2 and M3 since it directly provides the CSI to the destination.

By the network training method introduced in [17], all relays are provided with imperfect CSI by training signals, which are sent from end nodes to the relays. By the feedforwarding method introduced in this study, the destination is provided with effective CSI by feedforwarding imperfect CSI, which is sent from each relay to the destination. Due to these two methods, scheme C2 significantly lowers the network resources spent on providing the imperfect CSI at the relays and destination.

D. Worst-case noise theorem

By using the worst-case noise theorem, the lower bounds of the channel capacities are as follows:

$$C_{M_i} \geq C_{M_i\text{-worst}} = \frac{1}{2} \mathbb{E}\{I_{M_i}\}, \quad i = 1, 2, 3$$

where

$$\begin{aligned} I_{M1} &= \log_2 \left(1 + \frac{\left| \sum_{k=1}^K \hat{h}_k \right|^2 \hat{g}_k^* g_k}{B \left(\sigma_h^2 \sigma_g^2 + \sigma_h^2 \sigma_g^2 + C \right)} \right), \\ I_{M2} &= \log_2 \left(1 + \frac{\left(\sum_{k=1}^K \hat{h}_k \right)^2 \left(\hat{g}_k \right)^2}{B \left(2\sigma_h^2 \sigma_g^2 + 2\sigma_h^2 \sigma_g^2 + \sigma_h^2 \sigma_g^2 + C \right)} \right) \text{ and} \\ I_{M3} &= \log_2 \left(1 + \frac{\left(\sum_{k=1}^K \hat{h}_k \right)^2 \left(\hat{g}_k \right)^2}{B \left(\sigma_h^2 \sigma_g^2 + \sigma_h^2 \sigma_g^2 + C \right)} \right) \end{aligned}$$

for M1, M2 and M3, respectively, and where $B = K\sigma_h^2\sigma_g^2$ and $C = \sigma_g^2\sigma_n^2$. Therefore, $C_{M1\text{-worst}} > C_{M3\text{-worst}} > C_{M2\text{-worst}}$. For the sake of brevity, we omit the simple proofs that the source signal and the overall noise are uncorrelated given CSI at the destination.

Throughout the study, we ignore that destination has CSI while evaluating the eSNRs. Considering the Jensen's inequality [28], this gives us an upper bound on the worst-case: $C_{M_i} \geq C_{M_i, \text{u-worst}} \geq C_{M_i\text{-worst}}$ ($i = 1, 2, 3$). This approach is convenient for the comparisons used in this study.

The general conclusion of this study is that feedforwarding method is superior in terms of efficiency and average eSNR compared to the currently known training methods due its ability of conveying perfect

forward CSI by using the relay network structure. In addition, learning the effective CSI at the destination as directly as possible is more efficient and provides better average eSNR performance. M3, where the products of the forward and backward channels are estimated at the destination, provides better average eSNR than M2, where each forward and backward channel is estimated at the destination.

III. COMPLEMENTARY RESULTS AND FURTHER INSIGHTS

A. Numerical Analysis

We numerically compare all of the schemes for $M = 2$ and $K = 20$ by using the following simplified versions of the results shown in (7) due to their conveniences:

For C1a:

$$\rho_{\text{eff}} = \frac{\frac{N+1}{M-1} + \frac{(K-1)N^2}{(N+1)(M-1)} + \frac{1}{N+1}}{2 + \frac{M-2}{N+1} + \frac{1}{\rho_S(M-1)} + \frac{1}{\rho_S(N+1)}},$$

For C1b:

$$\rho_{\text{eff}} = \frac{\frac{(N\sigma_h^2+1)(N\sigma_g^2+1)+(K-1)N^2}{(M-1)} + 1}{M + N(\sigma_h^2 + \sigma_g^2) + \frac{(N\sigma_g^2+1)}{\rho_S(M-1)} + \frac{1}{\rho_S}},$$

For C2:

$$\rho_{\text{eff}} = \frac{\frac{(N+1)\sigma_h^2(N\sigma_g^2+1)+(K-1)N^2\sigma_h^2\sigma_g^2}{(M-1)}}{M + N(\sigma_h^2 + \sigma_g^2) + 1 + \frac{\sigma_h^2(N\sigma_g^2+1)}{(M-1)} + \frac{(N\sigma_g^2+1)}{\rho_S(M-1)} + \frac{1}{\rho_S}},$$

where we assume that $\sigma_h^2 = \sigma_{h^y}^2$ ($x \in (i, j)$ and $y \in (i, j, m)$) and the channel variances have unit values. We choose $M = 2$ since this is the least number expected for the MIMO technology.

We present the results for $1 \leq N \leq 6$ in Fig. 5 and in Fig. 6. The results shown with the bold lines exist in both Fig. 5 and Fig. 6 in order to have a reference for the results shown with the thin lines. The continuous bold line presents the result for C1a. The dashed bold lines present the results for C1b and C2, when both backward and forward channel estimation variances are 0.9. For C1b and C2, we set backward (forward) channel estimation variance fixed at 0.9 and vary the forward (backward) channel estimation variance discretely at 0.5 and 0.1 as seen in Fig. 5 (Fig. 6). We show these results with the thin lines. Among the thin lines, the dashed and dotted styles notate 0.5 and 0.1 channel estimation variances, respectively.

Feedforwarding method: The feedforwarding method introduced in C2 has unsatisfactory performance due its simplicity when compared *directly* to its challenging competitors. As an example, when we compare C2 to C1b directly, the loss ranges from 20.1% to 7.8% as N increases from 1 to 6 for good backward and forward channel estimations, $\sigma_h^2 = 0.9$ and $\sigma_g^2 = 0.9$, as seen in Fig. 5. However, we can

achieve a better result even than C1a (the scheme without channel estimation error) at a cost of additional single antenna at each relay. As an example, the eSNR of C1a is 8.6 when $N = 2$. The eSNR of C2 is higher, 11.27, when $N = 3$ if good backward and good forward channel estimations are available as seen from the tick dashed lines in Fig. 5. The significant achievement of feedforwarding method is due to its ability of providing a perfect forward CSI at the destination as seen in (6).

In addition, for fixed relays, investing more at the relays is reasonable since relays could support a level of intelligence and a level of cost budget that are between mobile nodes and base stations regarding 802.16j.

MF options: We use \parallel and σ notations to denote MF option with and without instantaneous absolute channel values (i.e. $\frac{h_k^*}{|h_k|}$ and h_k^*), respectively. In addition, we use (a,b) notation, where $a, b \in \{\parallel, \sigma\}$, to denote that we apply MF with a and b options for backward and forward channels, respectively. Throughout the study, we use (σ, σ) option.

Applying σ option for the backward channel is preferable since there is a noise amplification problem at the first hop. Whereas, applying \parallel option for the forward channel is preferable when better forward channel variances are available since the amplification of the noise is not a problem at the second hop. Therefore, our schemes perform worse when we have better forward channel estimation variances as we observe by comparing Fig. 5 and Fig. 6. Note that \parallel option only changes the phase of the channel, which does not guarantee the average power spent at each relay. Whereas, σ option changes both amplitude and phase of the channel, which guarantees the average power spent at each relay. Our results can also be extended to (σ, \parallel) option. Further details on this issue are discussed in Appendix V-C, where we show that (σ, \parallel) option provides higher average eSNR than other options. In order to eliminate the noise amplification problem at the first hop, a better option is to include the power of the noise (i.e. $\frac{h_k^*}{\sqrt{|h_k|^2 + \sigma_n^2}}$) [14]. However, the main purpose of this study is to introduce the superiority of the feedforwarding method. For this purpose, we use (σ, σ) option, which significantly lowers the burden of the derivations.

Finally, note that a relay network with MF has unsymmetrical structure. For the forward channel, MF is a pre-filtering before the noise corruption; whereas, for the backward channel, MF is just a rough estimation of the source signal due to the post-filtering after the noise corruption. Therefore, the effects of backward and forward channels on eSNR are unsymmetrical.

A performance equivalent scheme of C1a: Consider a single antenna relay network with M source, M destination and K relay nodes, $1_{[M]} \times 1_{[K]} \times 1_{[M]}$. Each relay has perfect CSI of *all* channels from source antennas to destination antennas. This scheme has the same eSNR as C1a with generic M and $N = 1$, $M_{[1]} \times 1_{[MK]} \times M_{[1]}$. In fact, they have the same eSNR for $M = 1$ and $N = 1$ since both

schemes are exactly equivalent for this case. Therefore, in parallel to the conclusion in [11], this scheme achieves the same performance with C1a by less total number of relays but by more CSI *at each relay*. In *total*, they both need MK CSI; whereas, the total number of relays for this scheme and C1a are K and MK , respectively. We do not provide the proof of this scheme for the sake of brevity.

Better channel estimation and the number of antennas : By comparing the lines with different channel estimation variances in each figure, we observe the importance of better channel estimation. As an example, tick dashed and thin dashed lines of C1b when $N = 3$ are 12.66 and 8.99 as seen in Fig. 5. In addition, eSNR decreases with increasing M as seen in (7) since there is no interference mitigation in all of the schemes. Whereas, eSNR increases with increasing N .

B. Two-Way Relay Networks

Hereby, we specifically separate relay networks into one-way and two-way relay networks for the sake of clarity. For two-way relay networks, which have multiplexing gain benefit over one-way relay networks [10], end nodes transmit to the relays concurrently at the first hop. At the second hop, relays transmit their received signals to the end nodes as seen in Fig. 7(a). Lastly, each end node cancels its own signal, which is transmitted at the first hop. In two-way relay networks, the destination needs to know the effective CSI of the received self signal in order to successfully cancel its own transmitted signal. In this section, we discuss the effect of imperfect knowledge of this effective CSI at the destination, which could be due to unknown CSI of particular links. We assume a symmetrical two-way relay network; that is, the relay network seen by each end node has the same properties defined in the previous section. Therefore, we will only mention the differences from one-way relay networks.

We denote the end nodes by T_1 and T_2 as seen in Fig. 7(b). Each antenna pair is served by a subgroup of K relays in each direction, thus we have $2M$ subgroups. The subgroup, which serves for the x^{th} antenna pair is denoted by \mathcal{L}^x and \mathcal{U}^x ($x = 1, 2, \dots, M$) during the communication from T_1 to T_2 and T_2 to T_1 , respectively.

Considering the i^{th} antenna pair during the communication from T_1 to T_2 , the received signal at the k^{th} relay in the i^{th} subgroup is given as:

$$\mathbf{r}_{ik} = \sqrt{\rho_S} \left(\mathbf{s}^i \mathbf{h}_{ik}^i + \sum_{\substack{j=1 \\ j \neq i}}^M \mathbf{s}^j \mathbf{h}_{ik}^j + \mathbf{x}^i (\mathbf{g}_{ik}^i)^T + \sum_{\substack{j=1 \\ j \neq i}}^M \mathbf{x}^j (\mathbf{g}_{ik}^j)^T \right) + \mathbf{n}_{ik}, \quad i = 1, 2, \dots, M \text{ and } k = 1, 2, \dots, K,$$

where \mathbf{s}^y and \mathbf{x}^y are $T_d \times 1$ source signal vectors transmitted from the y^{th} antenna of T_1 and T_2 , respectively.

The general structure of the received signal at the i^{th} destination antenna is the same as in (2). Two-way multi-antenna relay network schemes used in this study, C3a and C3b, are the same as in C1a and C1b seen in Fig. 4, respectively. In deed, signalling in one-way and two-way relay networks is different as already mentioned (see Fig. 1(a) and Fig. 7(a)).

The simplified eSNRs of C3a and C3b is slightly different from C1a and C1b in the last term of denominator, which is $\frac{2}{\rho_s(N+1)\sigma_h^2}$ and $\frac{2}{\rho_s}$ for C3a and C3b, respectively. Therefore, eSNR decreases for both C3a and C3b since the received self signal cannot be canceled completely.

Although we assume only one term cannot be canceled, we clearly observe the importance of self signal cancellation. As an example, the loss ranges from 12.51% to 4.35% as N increases from 1 to 6 when C1a and C3a are compared. We do not include the results of C3a and C3b in the figures for the sake of clarity of the figures.

IV. CONCLUSION

The feedforwarding method introduced in this study along with the network training method introduced in [17] make scheme C2 distinctive for industrial applications since these methods together significantly lower the network resources spent on providing the imperfect CSI at the relays and destination. Moreover, we proved that the feedforwarding method is superior to the classical [4] and new [15] training methods regarding average eSNR since our method benefits from the relay network structure to carry the forward CSI to the destination for us.

In fact, there is only one generic eSNR result in this study. Once a generic eSNR is obtained for C1a, generic eSNRs for other schemes could be found without the derivations. As an example, C1a can be obtained from C1b by removing channel estimation errors (e.g. $\sigma_{h_i}^2 \rightarrow \sigma_{h_i}^2$) as seen in (7). Our results converge to the results in [8,10], which state that eSNR converges to K with probability 1 when $K \rightarrow \infty$. The results in [8,10] are achieved by rounding some of the terms in the effective and interference channels to zero on average when $K \rightarrow \infty$. On the other hand, our eSNR results include the effects of these terms.

Our results precisely show the number of the relays, multi-antenna and CSI effects on eSNR, which position us one step away from optimizing a relay network with training in order to maximize the eSNR. Future research would be achieving this optimization without large K assumption and with a proper MF option, which is not trivial due to significant amount of parameters to be optimized and due to the burden of MF options other than (σ, σ) option.

V. APPENDIX

A. Generic eSNR of Relay Networks:

$$\rho^{\text{eff}} = \frac{N1 + N2}{D1 + D2 + D3 + D4 + \{D5\}}, \quad (7)$$

where all of the terms are defined in the Table I. The terms in curly parenthesis should be additionally considered for two-way relay networks.

1) *The Received Signal at the Destination:* The generic form of the received signal at the i^{th} destination antenna for C1a, C1b and C2 is given as:

$$\mathbf{y}^i = \mathbf{y}^{i,\text{sig}} + \mathbf{y}^{i,\text{int}} + \mathbf{v}^i, \quad i = 1, 2, \dots, M, \quad (8)$$

where

$$\begin{aligned} \mathbf{y}^{i,\text{sig}} &= \mathbf{s}^i h^{i,\text{sig}}, \\ \mathbf{y}^{i,\text{int}} &= \sum_{\substack{j=1 \\ j \neq i}}^M \left(\mathbf{s}^j h_j^{i,\text{int}} + \sum_{\substack{m=1 \\ m \neq i \\ m \neq j}}^M \mathbf{s}^m h_{j,m}^{i,\text{int}} \right), \end{aligned}$$

where $h^{i,\text{sig}}$, $h_j^{i,\text{int}}$ and $h_{j,m}^{i,\text{int}}$, and \mathbf{v}^i are the effective channel, interference channels and noise, respectively.

$$\begin{aligned} h^{i,\text{sig}} &= \sum_{k, R_k \in \mathcal{L}^i} \sqrt{\frac{\rho_i}{N}} \mathbf{h}_{ik}^i \bar{\mathbf{h}}_{i^i} + \sum_{\substack{j=1 \\ j \neq i}}^M \left(\sum_{k, R_k \in \mathcal{L}^j} \sqrt{\frac{\rho_j}{N}} \mathbf{h}_{jk}^i \bar{\mathbf{h}}_{j^i} \right), \\ h_j^{i,\text{int}} &= \sqrt{\frac{\rho_i}{N}} \sum_{\substack{j=1 \\ j \neq i}}^M \left(\sum_{k, R_k \in \mathcal{L}^j} \mathbf{h}_{ik}^j \bar{\mathbf{h}}_{i^i} \right) + \sum_{\substack{j=1 \\ j \neq i}}^M \left(\sum_{k, R_k \in \mathcal{L}^j} \sqrt{\frac{\rho_j}{N}} \mathbf{h}_{jk}^j \bar{\mathbf{h}}_{j^i} \right), \\ h_{j,m}^{i,\text{int}} &= \sum_{\substack{j=1 \\ j \neq i}}^M \left(\sum_{k, R_k \in \mathcal{L}^j} \sum_{\substack{m=1 \\ m \neq i \\ m \neq j}}^M \sqrt{\frac{\rho_m}{N}} \mathbf{h}_{jk}^m \bar{\mathbf{h}}_{j^i} \right), \\ \mathbf{v}^i &= \sum_{k, R_k \in \mathcal{L}^i} \sqrt{\frac{\rho_i}{\rho_S N}} \mathbf{n}_{ik} \bar{\mathbf{h}}_{i^i} + \sum_{\substack{j=1 \\ j \neq i}}^M \left(\sum_{k, R_k \in \mathcal{L}^j} \sqrt{\frac{\rho_j}{\rho_S N}} \mathbf{n}_{jk} \bar{\mathbf{h}}_{j^i} \right) + \mathbf{z}^i \end{aligned}$$

and

$$\rho_i = \frac{\rho R \rho S}{\left[\rho S \left(\sigma_{i,1}^2 \sigma_{s^i}^2 + (M-1) \sigma_{\bar{h}_i^j}^2 \sigma_{s^j}^2 \right) + \sigma_{n_i}^2 \right] N \sigma_{i,2}^2},$$

$$\rho_j = \frac{\rho R \rho S}{\left[\rho S \left(\sigma_{\bar{h}_j^i}^2 \sigma_{s^i}^2 + \sigma_{j,1}^2 \sigma_{s^j}^2 + (M-2) \sigma_{\bar{h}_j^m}^2 \sigma_{s^m}^2 \right) + \sigma_{n_j}^2 \right] N \sigma_{j,2}^2},$$

where $\bar{\mathbf{h}}_{i^i}, \bar{\mathbf{h}}_{j^i}$ ($\bar{\mathbf{h}}_{x^i} \in \{\mathbf{h}_{x^i}, \hat{\mathbf{h}}_{x^i}\}$ and $x \in \{i, j\}$) and $\sigma_{x,y}^2$ ($x \in \{i, j\}$ and $y \in \{1, 2\}$) are determined for C1a, C1b and C2 in the following sub-sections.

$h^{i,sig}$ denotes the effective channel between the i^{th} source signal received at the i^{th} destination antenna via i^{th} and j^{th} assigned groups ($j = 1, 2, \dots, M$ and $j \neq i$). $h^{i,int}$ denotes the effective channel between the j^{th} source signal received at the i^{th} destination antenna via i^{th} and j^{th} assigned groups ($j = 1, 2, \dots, M$ and $j \neq i$). Finally, $h_{j,m}^{i,int}$ denotes the effective channel between the m^{th} source signal received at the i^{th} destination antenna via j^{th} assigned group ($j, m = 1, 2, \dots, M, j \neq i, m \neq i$ and $m \neq j$).

2) *Proofs for One-Way Relay Networks:* The following lemma is useful for the derivation of the results in (7). The proof of the lemma is straightforward by using moment theorems for complex Gaussian processes [23] but tedious.

Lemma 1: Let $\mathbf{s}, \mathbf{h}, \mathbf{g}$ and \mathbf{n} be source, backward channel, forward channel and noise vectors, respectively. Source signal is $T_d \times 1$ vector and has i.i.d. $CN(0, \sigma_s^2)$ entries. Backward and forward channels are $1 \times N$ and $N \times 1$ vectors and have i.i.d. $CN(0, \sigma_h^2)$ and $CN(0, \sigma_g^2)$ entries, respectively. Noise is $T_d \times N$ vector and has i.i.d. $CN(0, \sigma_n^2)$ entries. The bar, $\bar{\mathbf{x}}$, denotes either the vector itself, \mathbf{x} , estimation of the vector, $\hat{\mathbf{x}}$, or an independent same type vector, \mathbf{x}' . Then, we have

- $\text{var}\{\mathbf{s}\bar{\mathbf{h}}\mathbf{h}^* \mathbf{g}^* \bar{\mathbf{g}}\} = \text{var}\{\mathbf{s}\} \text{var}\{\bar{\mathbf{h}}\mathbf{h}^*\} \text{var}\{\mathbf{g}^* \bar{\mathbf{g}}\},$
- $\text{var}\{\mathbf{n}\mathbf{h}^* \mathbf{g}^* \bar{\mathbf{g}}\} = \text{var}\{\mathbf{n}\mathbf{h}^*\} \text{var}\{\mathbf{g}^* \bar{\mathbf{g}}\},$
- $\text{var}\{\mathbf{h}\mathbf{h}^*\} = N(N+1)\sigma_h^4,$
- $\text{var}\{\mathbf{h}\hat{\mathbf{h}}^*\} = N\sigma_h^2(N\sigma_h^2 + \sigma_h^2)$ and
- $\text{var}\{\mathbf{h}\mathbf{h}'^*\} = N\sigma_h^2\sigma_{h'}^2.$

Similar results can be obtained for the forward channel.

Generic eSNR derivation of C1a: Each relay applies MF with the perfect backward CSI, \mathbf{h}_{ik}^{i*} , after receiving the signal (1):

$$\mathbf{u}_{ik} = \mathbf{r}_{ik} \mathbf{h}_{ik}^{i*}.$$

The above signal is normalized to unit average power:

$$\begin{aligned} \text{var}\{\mathbf{u}_{ik}\} &= \rho_S \text{var}\{\mathbf{h}_{ik}^i \mathbf{h}_{ik}^{i*}\} \text{var}\{\mathbf{s}^i\} + \rho_S \sum_{\substack{j=1 \\ j \neq i}}^M \text{var}\{\mathbf{h}_{ik}^j \mathbf{h}_{ik}^{j*}\} \text{var}\{\mathbf{s}^j\} + \text{var}\{\mathbf{n}_{ik} \mathbf{h}_{ik}^{i*}\} \\ &= \left[\rho_S \left((N+1) \sigma_{h_i}^2 \sigma_{s^i}^2 + (M-1) \sigma_{h_i}^2 \sigma_{s^j}^2 \right) + \sigma_{n_i}^2 \right] NT_d \sigma_{h_i}^2 \end{aligned}$$

by using the following equalities obtained from Lemma 1:

$$\text{var}\{\mathbf{h}_{ik}^i \mathbf{h}_{ik}^{i*}\} = N(N+1) \sigma_{h_i}^2 \quad \text{and} \quad \text{var}\{\mathbf{h}_{ik}^j \mathbf{h}_{ik}^{j*}\} = N \sigma_{h_i}^2 \sigma_{h_j}^2.$$

Then, each relay applies MF with the forward CSI, \mathbf{g}_{ik}^{i*} . Considering the power constraint $\text{TrE}\{\mathbf{t}_{ik}^* \mathbf{t}_{ik}\} \leq NT_d$ at the relays, the transmitted signal from k^{th} relay in the i^{th} subgroup is given as:

$$\mathbf{t}_{ik} = \frac{\mathbf{u}_{ik} \mathbf{g}_{ik}^{i*}}{\sqrt{\left[\rho_S \left((N+1) \sigma_{h_i}^2 \sigma_{s^i}^2 + (M-1) \sigma_{h_i}^2 \sigma_{s^j}^2 \right) + \sigma_{n_i}^2 \right] N \sigma_{h_i}^2 \sigma_{g_i}^2}}.$$

Similar steps are followed for \mathbf{r}_{jk} ($j = 1, \dots, M$ and $j \neq i$), where the k^{th} relay in each j^{th} subgroup applies MF with perfect backward and forward CSI, \mathbf{g}_{jk}^j and \mathbf{h}_{jk}^j . The received signal at the destination is given in (8) with the following terms:

$$\mathbf{h}_{j^i} = \mathbf{h}_{ik}^{i*} \mathbf{g}_{ik}^{i*} \mathbf{g}_{ik}^i, \quad \mathbf{h}_{j^i} = \mathbf{h}_{jk}^{j*} \mathbf{g}_{jk}^{j*} \mathbf{g}_{jk}^i, \quad (9)$$

and

$$\sigma_{i,1}^2 = (N+1) \sigma_{h_i}^2, \quad \sigma_{i,2}^2 = \sigma_{h_i}^2 \sigma_{g_i}^2, \quad \sigma_{j,1}^2 = (N+1) \sigma_{h_j}^2 \quad \text{and} \quad \sigma_{j,2}^2 = \sigma_{h_j}^2 \sigma_{g_j}^2.$$

Note that $\mathbf{y}^{i,\text{sig}}$, $\mathbf{y}^{i,\text{int}}$ and \mathbf{v}^i are composed of independent terms. However, $\mathbf{y}^{i,\text{int}}$ and \mathbf{v}^i are dependent together. Therefore, we also have to assume that the destination knows the effective CSI of $\mathbf{y}^{i,\text{int}}$ along with the effective CSI of $\mathbf{y}^{i,\text{sig}}$ in order to use central limit theorem due to large number of relays. Note that the received desired signal and the overall noise, $\mathbf{y}^{i,\text{sig}}$ and $\mathbf{y}^{i,\text{int}} + \mathbf{v}^i$, are not Gaussian due to product of multiple complex Gaussian random variables [24].

From (8), eSNR is evaluated as follows:

$$\rho^{\text{eff}} = \frac{\text{var}\{\mathbf{y}^{i,\text{sig}}\}}{\text{var}\{\mathbf{y}^{i,\text{int}}\} + \text{var}\{\mathbf{v}^i\}},$$

where

$$\begin{aligned} \text{var}\{\mathbf{y}^{i,\text{sig}}\} &= KN \sigma_{s^i}^2 \left[\rho_i \left((N+1)^2 + (K-1)N^2 \right) \sigma_{h_i}^2 \sigma_{s^i}^2 + \rho_j (M-1) \sigma_{h_j}^2 \sigma_{s^j}^2 \right], \\ \text{var}\{\mathbf{y}^{i,\text{int}}\} &= K(M-1) \left[\rho_i (N+1) \sigma_{h_i}^2 \sigma_{s^i}^2 \sigma_{s^j}^2 + \rho_j \left((N+1) \sigma_{h_j}^2 \sigma_{s^j}^2 + (M-2) \sigma_{h_m}^2 \sigma_{s^m}^2 \right) N \sigma_{j^i}^2 \right], \\ \text{var}\{\mathbf{v}^i\} &= \frac{K}{\rho_S} \left[\rho_i (N+1) \sigma_{s^i}^2 \sigma_{n_i}^2 + \rho_j (M-1) N \sigma_{j^i}^2 \sigma_{n_j}^2 \right], \end{aligned}$$

where $\sigma_{i^i}^2 = \sigma_{h_i^i}^2 \sigma_{g_i^i}^4$ and $\sigma_{j^i}^2 = \sigma_{h_j^j}^2 \sigma_{g_j^j}^2 \sigma_{g_j^i}^2$.

Generic eSNR derivation of C1b: Each relay applies MF with the imperfect backward CSI, $\widehat{\mathbf{h}}_{ik}^{i*}$, after receiving the signal (1):

$$\mathbf{u}_{ik} = \mathbf{r}_{ik} \widehat{\mathbf{h}}_{ik}^{i*}.$$

The above signal is normalized to unit average power:

$$\begin{aligned} \text{var}\{\mathbf{u}_{ik}\} &= \rho_S \text{var}\{\mathbf{h}_{ik}^i \widehat{\mathbf{h}}_{ik}^{i*}\} \text{var}\{\mathbf{s}^i\} + \rho_S \sum_{\substack{j=1 \\ j \neq i}}^M \text{var}\{\mathbf{h}_{ik}^j \widehat{\mathbf{h}}_{ik}^{i*}\} \text{var}\{\mathbf{s}^j\} + \text{var}\{\mathbf{n}_{ik} \widehat{\mathbf{h}}_{ik}^{i*}\} \\ &= \left[\rho_S \left(\left(N \sigma_{h_i^i}^2 + \sigma_{h_i^i}^2 \right) \sigma_{s^i}^2 + (M-1) \sigma_{h_i^j}^2 \sigma_{s^j}^2 \right) + \sigma_{n_i}^2 \right] N T_d \sigma_{h_i^i}^2 \end{aligned}$$

by using the following equalities from Lemma 1:

$$\text{var}\{\mathbf{h}_{ik}^i \widehat{\mathbf{h}}_{ik}^{i*}\} = N \sigma_{h_i^i}^2 \left(N \sigma_{h_i^i}^2 + \sigma_{h_i^i}^2 \right) \quad \text{and} \quad \text{var}\{\mathbf{h}_{ik}^j \widehat{\mathbf{h}}_{ik}^{i*}\} = N \sigma_{h_i^j}^2 \sigma_{h_i^j}^2.$$

Then, each relay applies MF with the imperfect forward CSI, $\widehat{\mathbf{g}}_{ik}^{i*}$. Considering the power constraint $\text{TrE}\{\mathbf{t}_{ik}^* \mathbf{t}_{ik}\} \leq N T_d$ at the relays, the following signal is transmitted from the k^{th} relay in the i^{th} subgroup:

$$\mathbf{t}_{ik} = \frac{\mathbf{u}_{ik} \widehat{\mathbf{g}}_{ik}^{i*}}{\sqrt{\left[\rho_S \left(\left(N \sigma_{h_i^i}^2 + \sigma_{h_i^i}^2 \right) \sigma_{s^i}^2 + (M-1) \sigma_{h_i^j}^2 \sigma_{s^j}^2 \right) + \sigma_{n_i}^2 \right] N \sigma_{h_i^i}^2 \sigma_{g_i^i}^2}}.$$

Similar steps are followed for \mathbf{r}_{jk} ($j = 1, \dots, M$ and $j \neq i$), where the k^{th} relay in each j^{th} subgroup applies MF with the imperfect backward and forward CSI, $\widehat{\mathbf{g}}_{jk}^j$ and $\widehat{\mathbf{h}}_{jk}^j$, respectively. The received signal at the destination is given in (8) with the following terms:

$$\widehat{\mathbf{h}}_{i^i} = \widehat{\mathbf{h}}_{ik}^{i*} \widehat{\mathbf{g}}_{ik}^{i*} \sigma_{g_{ik}^i}^i, \quad \widehat{\mathbf{h}}_{j^i} = \widehat{\mathbf{h}}_{jk}^{j*} \widehat{\mathbf{g}}_{jk}^{j*} \sigma_{g_{jk}^i}^i, \quad (10)$$

and

$$\sigma_{i,1} = N \sigma_{h_i^i}^2 + \sigma_{h_i^i}^2, \quad \sigma_{i,2} = \sigma_{h_i^i}^2 \sigma_{g_i^i}^2, \quad \sigma_{j,1} = N \sigma_{h_j^j}^2 + \sigma_{h_j^j}^2 \quad \text{and} \quad \sigma_{j,2} = \sigma_{h_j^j}^2 \sigma_{g_j^j}^2.$$

Assuming that the destination knows the effective CSI of $\mathbf{y}^{i,int}$ along with the effective CSI of $\mathbf{y}^{i,sig}$, we obtain the generic eSNR in (7) by following the same approach in C1a.

Generic eSNR derivation of C2: During the feedforwarding phase, each relay in the subgroup \mathcal{L}^i ($i = 1, 2, \dots, M$) transmits $\mathbf{A}_{ik} = \widehat{\mathbf{h}}_{ik}^i \widehat{\mathbf{h}}_{ik}^{i*} \widehat{\mathbf{g}}_{ik}^{i*}$ to the destination. Therefore, by using the terms (10), the

¹The effective CSIs available at the destination are always scalar values in this study.

received signal at the destination is given as:

$$\sum_{k, R_k \in \mathcal{L}^i} \sqrt{\frac{\rho'_{R,f}}{N}} \widehat{\mathbf{h}}_{ik}^i \widehat{\mathbf{h}}_{i^i} + \mathbf{z}^{i,f}, \quad i = 1, 2, \dots, M.$$

$\rho_{R,f}$ is the power spent by each relay and $\mathbf{z}^{i,f}$ is the noise during the feedforwarding phase with zero mean complex Gaussian entries. Then, $\rho'_{R,f}$ is the normalized power, where $\rho'_{R,f} = \frac{\rho_{R,f}}{\text{var}\{\mathbf{A}_k \mathbf{g}_{ik}^i\}}$. Assuming that all backward and forward channel variances are equal within themselves and the destination knows $\rho'_{R,f}$ noiselessly, the destination has the following effective CSI:

$$\sqrt{\frac{\rho}{N}} \sum_{k, R_k \in \mathcal{L}^i} \widehat{\mathbf{h}}_{ik}^i \widehat{\mathbf{h}}_{i^i} + \sqrt{\frac{\rho}{\rho'_{R,f}}} \mathbf{z}^{i,f}.$$

We rearrange the received signal (8) with the terms (10) according to the above noisy effective CSI as follows:

$$\mathbf{y}^i = \mathbf{y}^{i,sig'} + \mathbf{y}^{i,int'} + \mathbf{y}^{i,int} + \mathbf{v}^i, \quad i = 1, 2, \dots, M, \quad (11)$$

where

$$\begin{aligned} \mathbf{y}^{i,sig'} &= \mathbf{s}^i h^{i,sig'}, \mathbf{y}^{i,int'} = \mathbf{s}^i h^{i,int'}, \\ h^{i,sig'} &= \left(\sqrt{\frac{\rho}{N}} \sum_{k, R_k \in \mathcal{L}^i} \widehat{\mathbf{h}}_{ik}^i \widehat{\mathbf{h}}_{i^i} + \sqrt{\frac{\rho}{\rho'_{R,f}}} \mathbf{z}^{i,f} \right), \\ h^{i,int'} &= \left(\sqrt{\frac{\rho}{N}} \sum_{k, R_k \in \mathcal{L}^i} \widetilde{\mathbf{h}}_{ik}^i \widehat{\mathbf{h}}_{i^i} - \sqrt{\frac{\rho}{\rho'_{R,f}}} \mathbf{z}^{i,f} \right) + \sqrt{\frac{\rho}{N}} \sum_{\substack{j=1 \\ j \neq i}}^M \left(\sum_{k, R_k \in \mathcal{L}^j} \mathbf{h}_{jk}^i \widehat{\mathbf{h}}_{j^i} \right), \end{aligned}$$

$\mathbf{y}^{i,int}$ and \mathbf{v}^i are the same as in (8).

At this point, we apply the worst-case noise theorem [25] for the overall noise, $\mathbf{y}^{i,int'} + \mathbf{y}^{i,int} + \mathbf{v}^i$ by showing that the source signal and the overall noise are uncorrelated given CSI at the destination. Let us rewrite (8) as follows:

$$\mathbf{y}^i = \mathbf{s}^i h^{i,sig'} + \mathbf{Z}^i, \quad i = 1, 2, \dots, M,$$

where $\mathbf{Z}^i = \mathbf{y}^{i,int} + \mathbf{v}^i$. Similarly, let us rewrite (11) as follows:

$$\mathbf{y}^i = \mathbf{s}^i h^{i,sig'} + \mathbf{V}^i,$$

where $\mathbf{V}^i = \mathbf{s}^i h^{i,int'} + \mathbf{Z}^i$. Note that $h^{i,sig} = h^{i,sig'} + h^{i,int'}$. In order to apply the worst-case noise theorem, we need to show that $\mathbb{E} \{ \mathbf{s}^{i*} \mathbf{V}^i | h^{i,sig'} \} = 0$.

$$\begin{aligned} \mathbb{E} \{ \mathbf{s}^{i*} \mathbf{V}^i | h^{i,sig'} \} &= \mathbb{E} \left\{ \mathbf{s}^{i*} \left(\mathbf{s}^i h^{i,int'} + \mathbf{Z}^i \right) | h^{i,sig'} \right\} \\ &= \mathbb{E} \left\{ \mathbf{s}^{i*} \mathbf{s}^i h^{i,int'} | h^{i,sig'} \right\} + \mathbb{E} \left\{ \mathbf{s}^{i*} \left(\sum_{\substack{j=1 \\ j \neq i}}^M \left(\mathbf{s}^j h_j^{i,int} + \sum_{\substack{m=1 \\ m \neq i \\ m \neq j}}^N \mathbf{s}^m h_{j,m}^{i,int} \right) \right) | h^{i,sig'} \right\} \\ &\quad + \mathbb{E} \left\{ \mathbf{s}^{i*} \mathbf{v}^i | h^{i,sig'} \right\}. \end{aligned}$$

The last term is zero since source signal has zero mean, and \mathbf{s}^i and \mathbf{v}^i are independent. The second term is also zero since \mathbf{s}^i , \mathbf{s}^j and \mathbf{s}^m are zero mean independent random variables. We rewrite the first term as follows since \mathbf{s}^i and $h^{i,int'}$ are independent: $\mathbb{E} \{ \mathbf{s}^{i*} \mathbf{s}^i h^{i,int'} | h^{i,sig'} \} = \mathbb{E} \{ \mathbf{s}^{i*} \mathbf{s}^i | h^{i,sig'} \} \mathbb{E} \{ h^{i,int'} | h^{i,sig'} \}$. The term is also zero by observing that $\mathbb{E} \{ (h^{i,sig} - h^{i,sig'}) | h^{i,sig'} \} = 0$.

We obtain the generic eSNR in (7) by following the same approach in C1a. Note that we use the following property explained in Lemma 1 for evaluating the generic eSNR:

$$\text{var} \left\{ \widehat{\mathbf{h}}_{ik}^i \widehat{\mathbf{h}}_{i^i} \right\} = \text{var} \left\{ \widehat{\mathbf{h}}_{ik}^i \widehat{\mathbf{h}}_{ik}^{i*} \right\} \text{var} \left\{ \widehat{\mathbf{g}}_{ik}^{i*} \widehat{\mathbf{g}}_{ik}^i \right\}.$$

3) *Proofs for Two-Way Relay Networks:* The following lemma along with the Lemma 1 are useful for the derivation of the results.

Lemma 2: Let the definitions introduced in the Lemma 1 hold for this Lemma. Then, we have

$$\text{var} \{ \mathbf{g}^T \mathbf{h}^* \mathbf{g}'^* \mathbf{g}'' \} = N^2 \sigma_g^2 \sigma_h^2 \sigma_{g'}^2 \sigma_{g''}^2,$$

where \mathbf{g} , \mathbf{g}' and \mathbf{g}'' are forward channel vectors independent from each other (i.e. Each of them is a channel between different relay and destination antenna).

Generic eSNR derivation of C3a <C3b>: Here, we use the $\langle \rangle$ notation to differentiate the comments and results of C3b from C3a for the sake of brevity. The received signal at the i^{th} destination antenna after each relay applies MF with the perfect backward and forward CSI, \mathbf{h}_{ik}^{i*} and \mathbf{g}_{ik}^{i*} , respectively, \langle with the imperfect backward and forward CSI, $\widehat{\mathbf{h}}_{ik}^{i*}$ and $\widehat{\mathbf{g}}_{ik}^{i*}$, respectively \rangle is given as:

$$\mathbf{y}^i = \mathbf{y}^{i,sig} + \mathbf{y}^{i,int} + \mathbf{y}^{i,self} + \mathbf{v}^i, \quad i = 1, 2, \dots, M, \quad (12)$$

where $\mathbf{y}^{i,sig}$, $\mathbf{y}^{i,int}$ and \mathbf{v}^i terms are the same as in (8) with the terms (9) $\langle(10)\rangle$.

$$\begin{aligned} \mathbf{y}^{i,self} &= \sum_{k,R_k \in \mathcal{L}^i} \left(\sqrt{\frac{\rho_i}{N}} \mathbf{x}^i (\mathbf{g}_{ik}^i)^T + \sum_{\substack{j=1 \\ j \neq i}}^M \sqrt{\frac{\rho_j}{N}} \mathbf{x}^j (\mathbf{g}_{ik}^j)^T \right) \mathbf{h}_{i^i} \\ &+ \sum_{\substack{j=1 \\ j \neq i}}^M \left(\sum_{k,R_k \in \mathcal{L}^j} \left(\sqrt{\frac{\rho_j}{N}} \mathbf{x}^j (\mathbf{g}_{jk}^j)^T + \sum_{\substack{m=1 \\ m \neq j}}^M \sqrt{\frac{\rho_m}{N}} \mathbf{x}^m (\mathbf{g}_{jk}^m)^T \right) \mathbf{h}_{j^i} \right) \\ \langle \mathbf{y}^{i,self} &= \sum_{k,R_k \in \mathcal{L}^i} \left(\sqrt{\frac{\rho_i}{N}} \mathbf{x}^i (\mathbf{g}_{ik}^i)^T + \sum_{\substack{j=1 \\ j \neq i}}^M \sqrt{\frac{\rho_j}{N}} \mathbf{x}^j (\mathbf{g}_{ik}^j)^T \right) \hat{\mathbf{h}}_{i^i} \\ &+ \sum_{\substack{j=1 \\ j \neq i}}^M \left(\sum_{k,R_k \in \mathcal{L}^j} \left(\sqrt{\frac{\rho_j}{N}} \mathbf{x}^j (\mathbf{g}_{jk}^j)^T + \sum_{\substack{m=1 \\ m \neq j}}^M \sqrt{\frac{\rho_m}{N}} \mathbf{x}^m (\mathbf{g}_{jk}^m)^T \right) \hat{\mathbf{h}}_{j^i} \right) \rangle \end{aligned}$$

and

$$\begin{aligned} \rho_i &= \frac{\rho_S \rho_R}{AN \sigma_{h_i}^2 \sigma_{g_i}^2} & \left\langle \rho_i &= \frac{\rho_S \rho_R}{A'N \sigma_{h_i}^2 \sigma_{g_i}^2} \right\rangle, \\ \rho_j &= \frac{\rho_S \rho_R}{BN \sigma_{h_j}^2 \sigma_{g_j}^2} & \left\langle \rho_j &= \frac{\rho_S \rho_R}{B'N \sigma_{h_j}^2 \sigma_{g_j}^2} \right\rangle, \end{aligned}$$

where A and B (A' and B') are defined in (7). For both C3a and C3b, we assume that the last term in $\mathbf{y}^{i,self}$ seen in (12) cannot be canceled. This could be due to the unknown \mathbf{g}_{jk}^m link. We specifically choose \mathbf{g}_{jk}^m since it does not appear in other terms. To avoid repetition, we directly state generic eSNR results in (7).

B. The Product of Two Gaussian Random Variables:

The product of two real Gaussian random variables, $N(\mu_1, \sigma_1^2)$ and $N(\mu_2, \sigma_2^2)$, is explained clearly in [27]. The product is Gaussian only if $\frac{\mu_1}{\sigma_1}$ and/or $\frac{\mu_2}{\sigma_2}$ approaches to infinity. On the other hand, the variance of the product approaches to $\sigma_1^2 \sigma_2^2$ if $\frac{\mu_1}{\sigma_1}$ and $\frac{\mu_2}{\sigma_2}$ approach to zero. Note that the last result also holds for two complex Gaussian random variables. Therefore, we obtain $\sigma_{a_k}^2 = \sigma_{h_k}^2 \sigma_{g_k}^2$ by assuming $a_k = h_k g_k$.

We proved that the eSNR performances of the methods are $M1 > M3 > M2$ for zero mean complex Gaussian channels. However, the superiority of M1 to training methods also holds for non-zero mean complex Gaussian channels since the known signal at the destination for M1 has always higher power than the known signals at the destination for both M2 and M3 as explained in Corollary 3.

C. MF Options:

For the sake of simplicity, we assume $M = N = T_d = 1$. For C1b with large K , the eSNRs for different MF options are as follows:

$(||, \sigma)$ option:

$$\rho_{eff} = \frac{\rho_s \sigma_s^2 \left(\sigma_h^2 (\sigma_g^2 + \sigma_g^2) + (K-1) \mathbf{E}^2 \{ |\hat{h}| \} \sigma_g^2 \right)}{\sigma_n^2 (\sigma_g^2 + \sigma_g^2)}.$$

$(||, ||)$ option:

$$\rho_{eff} = \frac{\rho_s \sigma_s^2 \left(\sigma_h^2 \sigma_g^2 + (K-1) \mathbf{E}^2 \{ |\hat{h}| \} \mathbf{E}^2 \{ |\hat{g}| \} \right)}{\sigma_n^2 \sigma_g^2}.$$

(σ, σ) option:

$$\rho_{eff} = \frac{\rho_s \sigma_s^2 \left((\sigma_h^2 + \sigma_h^2) (\sigma_g^2 + \sigma_g^2) + (K-1) \sigma_h^2 \sigma_g^2 \right)}{\sigma_n^2 (\sigma_g^2 + \sigma_g^2)}.$$

$(\sigma, ||)$ option:

$$\rho_{eff} = \frac{\rho_s \sigma_s^2 \left((\sigma_h^2 + \sigma_h^2) \sigma_g^2 + (K-1) \mathbf{E}^2 \{ |\hat{g}| \} \sigma_h^2 \right)}{\sigma_n^2 \sigma_g^2}.$$

By following the same approach in Corollary 3, we average the eSNRs and obtain 3.34, 3.93, 4.47 and 5.23 for the MF options, respectively as in the above order for $K = 20$.

In the following lines, by saying good (poor) channel variance, we mean that the channel variance is equal to 0.9 or 0.5 (0.1). The eSNR performance comparisons of the MF options for different backward and forward channel variances are as follows:

- 1) For both good backward and forward channel variances,
 $(\sigma, ||) > (||, ||) > (\sigma, \sigma) > (||, \sigma)$.
- 2) For good backward and poor forward channel conditions; as well as, for poor backward and poor forward channel conditions $(\sigma, \sigma) > (\sigma, ||) > (||, \sigma) > (||, ||)$.
- 3) For poor backward and good forward channel conditions,
 $(\sigma, ||) > (\sigma, \sigma) > (||, ||) > (||, \sigma)$.

VI. ACKNOWLEDGMENT

The first author would like to thank Ph.D. student S. Murugesan and Prof. P. Schniter of The Ohio State University for their efforts during early stages of this research. In addition, the first author would like to thank Ph.D. student E. Koyuncu, Ph.D. student V. R. Cadambe and Prof. S. A. Jafar of University of California, Irvine for their helpful comments and suggestions, which significantly improved the quality of the paper.

REFERENCES

- [1] H. Sampath, H. Talwar, J. Tellado, V. Erceg, and A. Paulraj, "A fourth-generation MIMO-OFDM broadband wireless system: Design, performance, and field trial results," *IEEE Commun. Mag.*, vol. 40, no. 9, pp. 143–149, Sep. 2002.
- [2] IEEE 802.16's Relay Task Group website. [Online]. Available: <http://wirelessman.org/relay/>.
- [3] Relay Based Wireless Network and Standard (REWIND) Project website. [Online]. Available: <http://www.rewindproject.eu/>.
- [4] B. Hassibi and B. M. Hochwald, "How much training is needed in multiple-antenna wireless links?" *IEEE Trans. Inf. Theory*, vol. 49, no. 4, pp. 951–963, Apr. 2003.
- [5] M. Coldrey (Tapio) and P. Bohlin, "Training-based MIMO systems-part i: Performance comparison," *IEEE Trans. Signal Process.*, vol. 55, no. 11, pp. 5464–5476, Nov. 2007.
- [6] IEEE 802.16 Task Group m (TGm) website. [Online]. Available: <http://wirelessman.org/tgm/>.
- [7] T. S. Wan, L. and M. Almgren, "A fading-insensitive performance metric for a unified link quality model," *IEEE Wireless Commun. Netw. Conf.*, pp. 2110–2114, Sep. 2006.
- [8] H. Bolcskei, R. Nabar, O. Oyman, and A. J. Paulraj, "Capacity scaling laws in MIMO relay networks," *IEEE Trans. Wireless Commun.*, vol. 5, no. 6, pp. 1433–1444, Jun. 2006.
- [9] V. I. Morgenshtern and H. Bolcskei, "Crystallization in large wireless networks," *IEEE Trans. Inf. Theory*, vol. 53, no. 10, pp. 3319–3349, Oct. 2007.
- [10] R. Vaze and R. W. Heath Jr., "Capacity scaling for MIMO two-way relaying," ArXiv pre-print cs.IT/0706.2906.
- [11] V. I. Morgenshtern, H. Bolcskei, and R. U. Nabar, "Distributed orthogonalization in large interference relay networks," *IEEE Int. Symp. on Inf. Theory Proceedings*, pp. 1211–1215, Sep. 4 - 9 2005.
- [12] A. F. Dana and H. Hassibi, "On the power efficiency of sensory and ad hoc wireless networks," *IEEE Trans. Inf. Theory*, vol. 52, no. 7, pp. 2890–2914, Jul. 2006.
- [13] N. Khajehnouri and A. H. Sayed, "Distributed MMSE relay strategies for wireless sensor networks," *IEEE Trans. Signal Process.*, vol. 55, no. 7, pp. 3336–3348, Jul. 2007.
- [14] C. S. Patel and G. L. Stuber, "Channel estimation for amplify and forward relay based cooperation diversity systems," *IEEE Trans. Wireless Commun.*, vol. 6, no. 6, pp. 2348–2356, Jun. 2007.
- [15] F. Gao, T. Cui, and A. Nallanathan, "On channel estimation and optimal training design for amplify and forward relay networks," *IEEE Trans. Wireless Commun.*, vol. 7, no. 5, pp. 1907–1916, May. 2008.
- [16] K. Yan, S. Ding, Y. Qiu, Y. Wang, and H. Liu, "A low-complexity LMMSE channel estimation method for OFDM-based cooperative diversity systems with multiple amplify-and-forward relays," *EURASIP J. Wireless Commun. Netw.*, vol. 2008, no. Article ID 149803, p. 9 Pages, May. 2008.
- [17] B. Wang, J. Zhang, and L. Zheng, "Achievable rates and scaling laws of power-constrained wireless sensory relay networks," *IEEE Trans. Inf. Theory*, vol. 52, no. 9, pp. 4084–4104, Sep. 2006.
- [18] S. A. Jafar and A. Goldsmith, "Multiple-antenna capacity in correlated Rayleigh fading with channel covariance information," *IEEE Trans. Wireless Commun.*, vol. 4, no. 3, pp. 990–997, May 2005.
- [19] M. Biguesh and A. B. Gershman, "Training-based MIMO channel estimation: A study of estimator tradeoffs and optimal training signals," *IEEE Trans. Signal Process.*, vol. 54, no. 3, pp. 884–893, Mar. 2006.
- [20] L. Tong, B. M. Sadler, and M. Dong, "Pilot-assisted wireless transmissions," *IEEE Signal Process. Mag.*, pp. 12–25, Nov. 2004.

- [21] A. Goldsmith, S. A. Jafar, N. Jindal, and S. Vishwanath, "Capacity limits of MIMO channels," *IEEE J. Sel. Areas Commun.*, vol. 21, no. 5, pp. 684–702, Jun. 2003.
- [22] S. M. Kay, *Fundamentals of Statistical Signal Processing: Estimation Theory*. New Jersey: Prentice-Hall, 1993.
- [23] I. S. Reed, "On a moment theorem for complex gaussian processes," *IEEE Trans. Inf. Theory*, vol. 8, no. 3, pp. 194–195, Apr. 1962.
- [24] C. S. Patel, G. L. Stuber, and T. G. Pratt, "Statistical properties of amplify and forward relay fading channels," *IEEE Trans. Veh. Technol.*, vol. 55, no. 1, pp. 1–9, Jan. 2006.
- [25] M. Medard, "The effect upon channel capacity in wireless communications of perfect and imperfect knowledge of the channel," *IEEE Trans. Inf. Theory*, vol. 46, no. 3, pp. 933–946, May 2000.
- [26] A. Lapidoth and S. S. Shamai, "Fading channels: How perfect need "perfect side information" be?" *IEEE Trans. Inf. Theory*, vol. 48, no. 5, pp. 1118–1134, May 2002.
- [27] R. Ware, "Three studies in numerical methods for statistical approximations." Ph.D. dissertation, University of Canterbury, 2003.
- [28] T. M. Cover and J. A. Thomas, *Elements of Information Theory*. New York: Wiley, 1991.

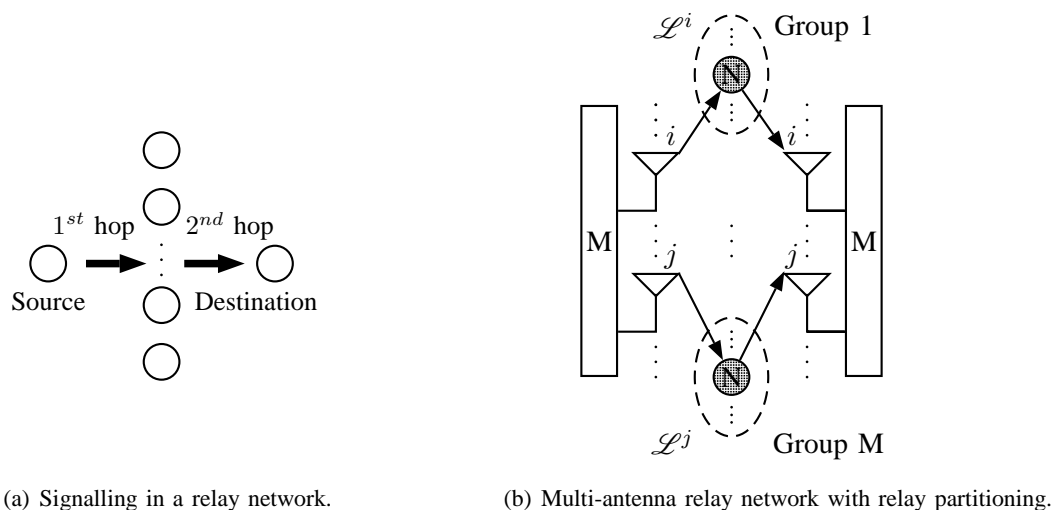

Fig. 1. Signalling and relay partitioning in a relay network.

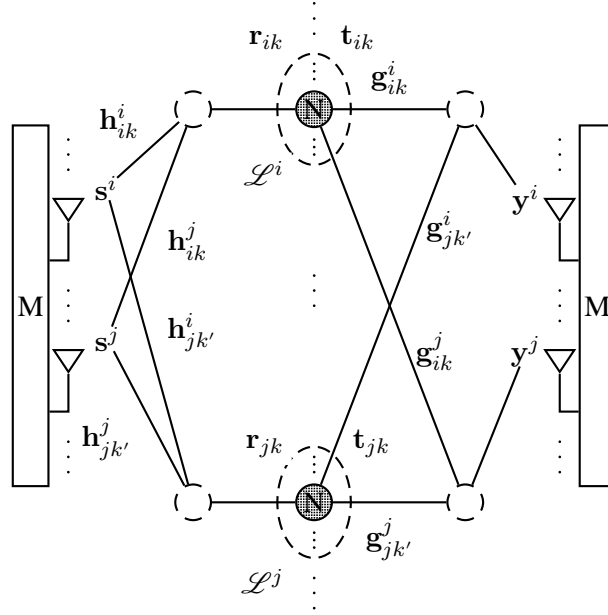

Fig. 2. Notations used in a $M_{[1]} \times N_{[MK]} \times M_{[1]}$ network with relay partitioning.

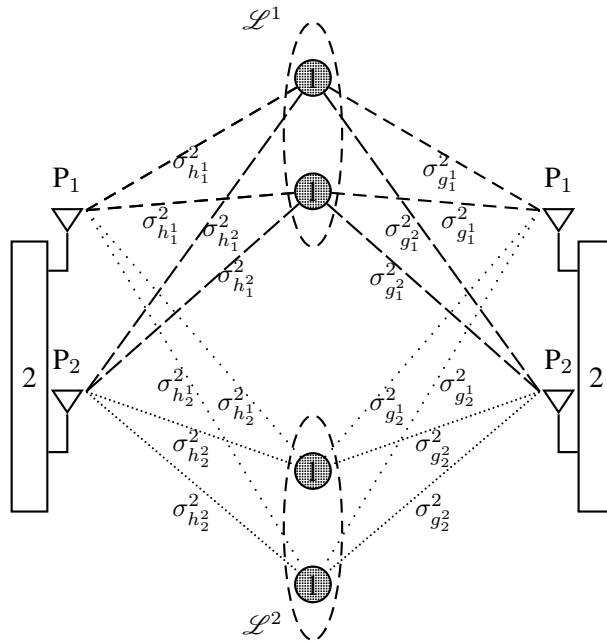

Fig. 3. A $2_{[1]} \times 1_{[4]} \times 2_{[1]}$ network with relay partitioning.

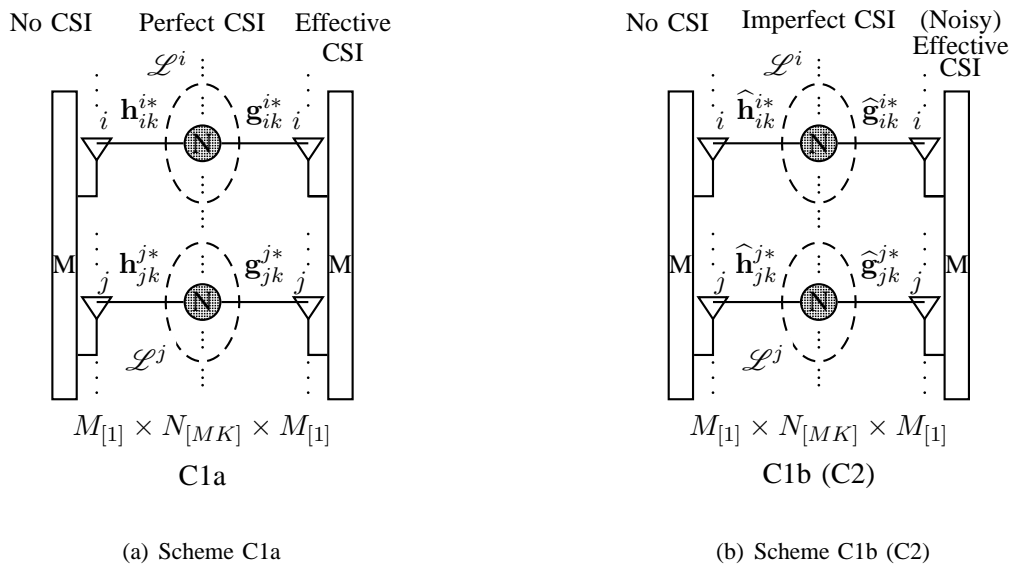

Fig. 4. Multi-antenna relay network schemes.

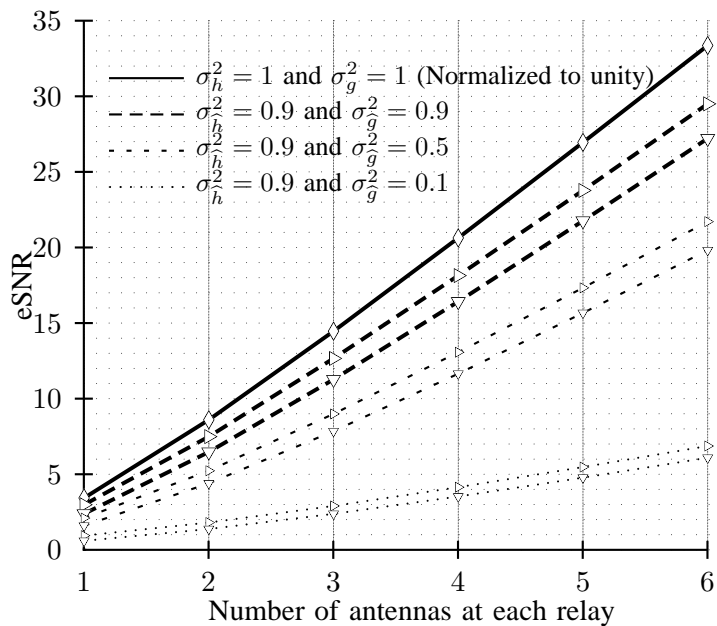

Fig. 5. eSNRs of the schemes with better backward channel estimation.

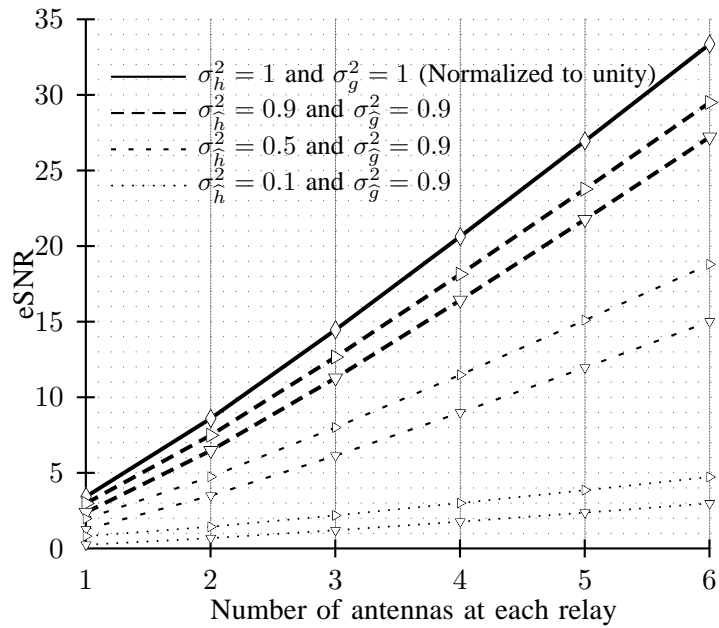
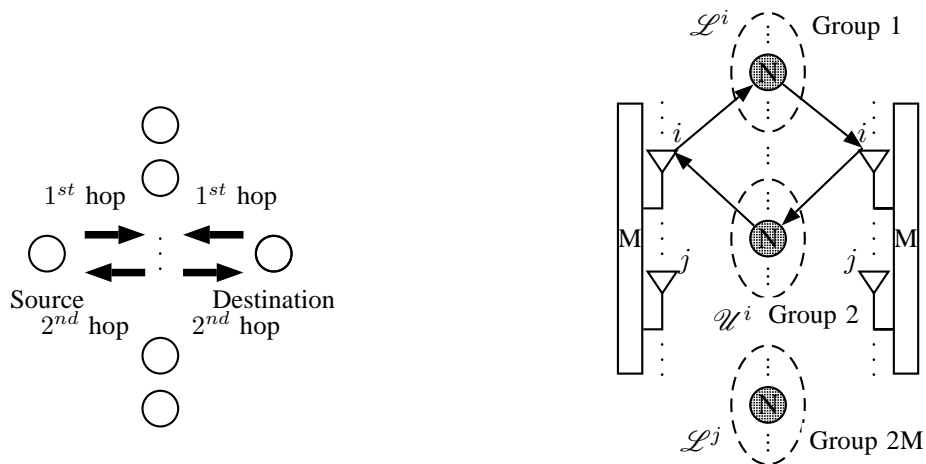

Fig. 6. eSNRs of the schemes with better forward channel estimation.



(a) Signalling in a two-way relay network.

(b) Two-way multi-antenna relay network with relay partitioning.

Fig. 7. Signalling and relay partitioning in a two-way relay network.

TABLE I
THE TERMS OF GENERIC ESNR

Schemes C1a and {C3a}:	Schemes C1b and {C3b}:
$N1 = \frac{\rho_S((N+1)^2+(K-1)N^2)\sigma_{h_i}^2\sigma_{g_i}^2\sigma_{s_i}^2}{A}$ $N2 = \frac{\rho_S(M-1)\sigma_{h_j}^2\sigma_{g_j}^2\sigma_{s_i}^2}{B}$ $D1 = \frac{\rho_S(M-1)(N+1)\sigma_{h_i}^2\sigma_{g_i}^2\sigma_{s_j}^2}{A}$ $D2 = \left[(N+1)\sigma_{h_j}^2\sigma_{s_j}^2 + (M-2)\sigma_{h_j}^2\sigma_{s_m}^2 \right]$ $D3 = \frac{\rho_S(M-1)\sigma_{g_j}^2}{B}$ $D4 = \frac{(M-1)\sigma_{g_j}^2\sigma_{s_j}^2}{B}$ $\left\{ D5 = \frac{(M-1)\sigma_{g_j}^2\sigma_{g_j}^2\sigma_{x_m}^2}{B} \right\}$	$N1 = \frac{\rho_S\left(\left(N\sigma_{h_i}^2+\sigma_{h_i}^2\right)\left(N\sigma_{g_i}^2+\sigma_{g_i}^2\right)+(K-1)N^2\sigma_{h_i}^2\sigma_{g_i}^2\right)\sigma_{s_i}^2}{A'}$ $N2 = \frac{\rho_S(M-1)\sigma_{h_j}^2\sigma_{g_j}^2\sigma_{s_i}^2}{B'}$ $D1 = \frac{\rho_S(M-1)\sigma_{h_j}^2\left(N\sigma_{g_i}^2+\sigma_{g_i}^2\right)\sigma_{s_j}^2}{A'}$ $D2 = \left[\left(N\sigma_{h_j}^2+\sigma_{h_j}^2\right)\sigma_{s_j}^2 + (M-2)\sigma_{h_j}^2\sigma_{s_m}^2 \right]$ $D3 = \frac{\left(N\sigma_{g_i}^2+\sigma_{g_i}^2\right)\sigma_{s_j}^2}{A'}$ $D4 = \frac{(M-1)\sigma_{g_j}^2\sigma_{s_j}^2}{B'}$ $\left\{ D5 = \frac{(M-1)\sigma_{g_j}^2\sigma_{g_j}^2\sigma_{x_m}^2}{B'} \right\}$
Scheme C2:	
$N1 = \frac{\rho_S\left((N+1)\sigma_{h_i}^2\left(N\sigma_{g_i}^2+\sigma_{g_i}^2\right)+(K-1)N^2\sigma_{h_i}^2\sigma_{g_i}^2\right)\sigma_{s_i}^2}{A'}$ $D1 = \frac{\rho_S\left(\sigma_{h_i}^2\left(N\sigma_{g_i}^2+\sigma_{g_i}^2\right)\sigma_{s_i}^2+(M-1)\sigma_{h_j}^2\left(N\sigma_{g_i}^2+\sigma_{g_i}^2\right)\sigma_{s_j}^2\right)}{A'}$ $D2 = \frac{\rho_S(M-1)\left[\left(N\sigma_{h_j}^2+\sigma_{h_j}^2\right)\sigma_{s_j}^2+(M-2)\sigma_{h_j}^2\sigma_{s_m}^2+\sigma_{h_j}^2\sigma_{s_i}^2\right]\sigma_{g_j}^2}{B'}$ $D3 = \frac{\left(N\sigma_{g_i}^2+\sigma_{g_i}^2\right)\sigma_{s_j}^2}{A'}$ $D4 = \frac{(M-1)\sigma_{g_j}^2\sigma_{s_j}^2}{B'}$	
$A = \rho_S\left((N+1)\left(\sigma_{h_i}^2\sigma_{s_i}^2+\left\{\frac{\sigma_{g_i}^2\sigma_{x_i}^2}{N}\right\}\right)+(M-1)\left(\sigma_{h_j}^2\sigma_{s_j}^2+\left\{\sigma_{g_j}^2\sigma_{x_j}^2\right\}\right)\right)+\sigma_{n_i}^2$ $B = \rho_S\left(\sigma_{h_j}^2\sigma_{s_i}^2+(N+1)\left(\sigma_{h_j}^2\sigma_{s_j}^2+\left\{\frac{\sigma_{g_j}^2\sigma_{x_j}^2}{N}\right\}\right)\right)+\sigma_{n_j}^2$ $A' = \rho_S\left(\left(N\sigma_{h_i}^2+\sigma_{h_i}^2\right)\sigma_{s_i}^2+\left\{\frac{1}{N}\left(\sigma_{g_i}^2+1+(N-1)\sigma_{g_i}^2\right)\sigma_{x_i}^2\right\}\right)+\sigma_{n_i}^2$ $B' = \rho_S\left(\sigma_{h_j}^2\sigma_{s_i}^2+\left(N\sigma_{h_j}^2+\sigma_{h_j}^2\right)\sigma_{s_j}^2+\left\{\frac{1}{N}\left(\sigma_{g_j}^2+1+(N-1)\sigma_{g_j}^2\right)\sigma_{x_j}^2\right\}\right)+\sigma_{n_j}^2$	