

# On the existence of the magnetic monopole and the non-existence of the Higgs particle

Engel Roza<sup>1</sup>

## Summary

In this paper the existence of the Higgs field is taken as an undeniable starting point. However, the origin of the field is challenged. Rather than ascribing the origin of it to a yet undiscovered phantom particle, the origin is ascribed directly to electromagnetic energy, in particular as magnetic charge next to electric charge of elementary point-like particles. To this end two instruments are used. The first one is the transform of the Higgs field from a functional description into a spatial description, without changing the basic properties. The other instrument is the concept of the magnetic monopole, as introduced by Dirac. The two instruments appear to fit well together. The result of all of this is that electromagnetic energy on its own is the source of all mass. It implies that the search after the Higgs particle will remain fruitless. No other equations, apart from Maxwell's Equations and Dirac's Equation are required to express the fundamentals of quantum waves and quantum fields, which makes the disputed Klein Gordon Equation obsolete. The theory reveals an algorithm to explain the ratios between the lepton masses. In that sense the theory shows a predictive element, while grosso modo, as shown, no derogation is done to the results and instruments of canonic theory.

## 1. Introduction

Since the definition of its concept by Peter Higgs in 1964 a continuous search has been made after a particular massive elementary scalar particle, known as the Higgs boson [1]. Since the unification of the weak nuclear force with electromagnetic force, by the work of Glashow, Salam and Weinberg [2,3] and final theoretical proofs by Marinus Veltman and Gerard 't Hooft [5], this particle is believed to be the corner stone of the so called Standard Model. However, in spite of efforts over more than forty years the particle has not been found. Among other reasons, the existence of such a particle is therefore not undisputed [6]. There is however firm belief that the particle will be detected soon, after full operation of the Large Hadron Collider (LHC) in the spring of 2009. The existence of a potential field of a type as produced by this particle, known as the Higgs field, is undeniable, because of many successful verifications by experiments of phenomena predicted by such fields. If the electromagnetic Maxwell laws are maintained in its classical relativistic format, there is no other way than ascribing the origin of this field to an undiscovered particle.

But what if the Maxwell laws are not maintained unimpaired? Historically a number of proposals have been put forward to generalize these laws. The most prominent ones are the generalizations

---

1. Engel Roza (1940) is a scientist retired from Philips Research Labs, Eindhoven, The Netherlands

as put forward by Paul Dirac [7] and Alexandru Proca [8]. Dirac proposed his generalization because of his wonder about an asymmetry in Maxwell's Equations. His wonder had to do with the absence of magnetic space charge in these equations as a result of a clear absence of it in experimental physics. Driven by his devotion for beauty Dirac symmetrized the equations by the hypothetical existence of a magnetic source, next to the electric source. He made clear that a verified existence of a magnetic monopole would explain the discrete nature of both electric and magnetic charges. So, a long and still continuing search began in an attempt to find experimental verification of such a magnetic monopole. Dirac himself did not urge the necessity of its existence, but never denied its existence either. Despite of efforts over more than seventy years, the magnetic monopole has not been found.

In an attempt to explain by electromagnetism the short range characteristics of nuclear forces. Proca suggested generalizing the Maxwellian Lagrangian by an extra term, proportional to mass. By doing so, Maxwellian laws would maintain its validity for zero mass and the vector potential would show an exponential decay for non-zero mass. In fact he formulated the hypothesis that a massive electromagnetic particle would exist, next to the mass-less photon. As pointed out by Yukawa [9] in 1935, this model fits with the *virtual* particle theory for bosons: a short-range force between nucleons is transferred by force-carrying particles, similarly as force exchange between charged particles is due to photons. The particles are said to be "virtual", because there is no energy available to produce the particles: they have to disappear within a time interval as imposed by the uncertainty principle. These theories appeared to be quite successful as Yukawa could predict rather accurately the characteristics of such particles, known as pi-mesons, which were verified experimentally indeed. However it appeared later that Proca's equations do not meet the so-called gauge condition of the Yang Mills Principle [10], which is believed to be a major fundament in the theory of the Standard Model. In a next section we shall elaborate on this.

In spite of these disclaimers we wish to show in this paper the feasibility of a Higgs field on the basis of generalized Maxwellian equations. We wish to show that the introduction of magnetic space charge into these equations has a short-range force resultant that matches with the characteristics of the weak nuclear force, without violating the gauge condition of the Yang Mills Principle. We shall also explain why an isolated magnetic monopole has never been found in spite of such a presumed existence of magnetic space charge. The implication of this will be that electromagnetic energy on its own, without anything else, is capable to form a fundament below the Standard Model and that no other equations apart from Maxwell's Equations and the Dirac equation are required for mathematical descriptions. There is neither need for a hypothetical elementary massive scalar particle, nor for its presumed Klein Gordon wave equation.

The paper is organized as follows. In the second section Dirac's wave equation in free space will be reviewed. This will serve as an introduction for a review of Yang Mills concept in section 3. In section 4 a view will be presented on the relationship between the concept of Lagrangian density and quantum mechanical wave equations. In section 5 an alternative description will be given for the Higgs field. Section 6 deals with wave function doublets like associated with mesons. In section 7 the origin of the Higgs field is related to magnetic monopoles. In section 8 the theory as developed in this paper is compared with the present canonic theory. Finally, in section 9 it is shown that the Higgs field as created by magnetic monopoles gives an explanation for the mass relationships between leptons (electrons, muons and taus).

## 2. Dirac's Equation

Historically Dirac derived his equation for electrons in order to provide a relativistic wave equation as an alternative for the Klein Gordon Equation, which up to then was seen as the relativistic generalization of Schrödinger's Equation [11]. These equations are supposed to have probabilistic semantics (the so called Born interpretation), which means that the squared absolute value of the amplitude of the wave function solution represents the probability that a particle is at certain moment at a certain position. This imposes the requirement of time independency of the spatial integral of the squared absolute value of the wave function. This requirement is known as the requirement for positive definiteness. To meet this requirement, the temporal derivative in the wave equation has to be of first order. This is the case for Schrödinger's wave equation, but is not the case for the Klein-Gordon Equation. That was the basic motivation for Dirac to develop an alternative.

To keep things simple we wish to review Dirac's Equation for a single spatial dimension. This is sufficient to underline the thread of analysis in succeeding sections. With this background, generalization towards three spatial dimensions can easily be found in textbooks. Dirac has based his equation on Einstein's famous relativistic momentum relationship for moving massive particles. This relationship reads as:

$$p_0^2 + p_x^2 = -m_0^2 c^2, \quad (2-1)$$

wherein  $m_0$  is the mass in rest,  $c$  the velocity of light in vacuum and wherein  $p_i$  are relativistic momenta. These momenta are defined as:

$$p_i = m_0 \frac{dx_i}{d\tau}, \text{ wherein } x_1 = x, x_0 = t' \text{ and } t' = jct \text{ with } j = \sqrt{-1}. \quad (2-2)$$

The momenta are expressed in proper time  $\tau$ , i.e. in the time frame of a co-moving observer. The normalized time coordinate  $t' = jct$  is treated on par with the spatial coordinate(s). Later on the basic quantum mechanical hypothesis will be used, wherein momenta are transformed into operators on wave functions such that:

$$p_i \rightarrow \hat{p}_i \Psi \quad \text{with} \quad \hat{p}_i = \frac{\hbar}{j} \frac{\partial}{\partial x_i}. \quad (2-3)$$

In fact there is a slight, but not unimportant, difference between the Einsteinean relativistic energy  $W$  and the energy parameter  $E$  connected to the temporal moment. The Einsteinean energy  $W$  is defined as:

$$W = c \sqrt{(m_0 c)^2 + p_x^2}, \quad (2-4)$$

whereas from (2-1): 
$$E^2 = -p_0^2 = (m_0c)^2 + p_x^2 . \quad (2-5)$$

There is therefore a sign ambiguity between  $W/c$  and  $E$ . Later on we shall come back on this.

Let us normalize (2-1) as:

$$p_0'^2 + p_x'^2 + 1 = 0 \quad \text{with } p_i' = \frac{p_i}{m_0c}, \quad i = 0, 1 . \quad (2-6)$$

Dirac wrote this expression as the square of a linear relationship:

$$p_0'^2 + p_x'^2 + 1 = (\alpha \cdot \mathbf{p}' + \beta) \cdot (\alpha \cdot \mathbf{p}' + \beta) = 0 , \quad \text{with } \alpha(\alpha_0, \alpha_1) \text{ and } \mathbf{p}'(p_0', p_x') . \quad (2-7)$$

thereby leaving open for the moment the number type of the number  $\beta$  and of the components  $\alpha_0$  and  $\alpha_1$  of the two-dimensional vector  $\alpha$ .

The elaboration of the middle term is:

$$\begin{aligned} (\alpha \cdot \mathbf{p}' + \beta) \cdot (\alpha \cdot \mathbf{p}' + \beta) &= \left( \beta + \sum_i \alpha_i p_i' \right) \left( \beta + \sum_j \alpha_j p_j' \right) \\ &= \beta^2 + \sum_i \beta \alpha_i p_i' + \sum_j \beta \alpha_j p_j' + \sum_i \sum_j \alpha_i \alpha_j p_i' p_j' \\ &= \beta^2 + \sum_i (\beta \alpha_i + \alpha_i \beta) p_i' + \sum_{i \neq j} (\alpha_i \alpha_j + \alpha_j \alpha_i) p_i' p_j' + \sum_i \alpha_i^2 p_i'^2 . \end{aligned} \quad (2-8)$$

To equate this middle term with the left hand term the following conditions should be true:

$$\alpha_i \alpha_j + \alpha_j \alpha_i = 0 \quad \text{if } i \neq j; \quad \beta \alpha_i + \alpha_i \beta = 0$$

and 
$$\alpha_i^2 = 1, \quad \beta^2 = 1 \quad \text{for } i = 0, 1 . \quad (2-9)$$

From these expressions it will be clear that the numbers  $\alpha_i$  and  $\beta$  have to be of special type. To this end Dirac invoked the use of the Pauli matrices, which are defined as:

$$\sigma_1 = \begin{bmatrix} 1 & 0 \\ 0 & -1 \end{bmatrix} \quad \sigma_2 = \begin{bmatrix} 0 & -j \\ j & 0 \end{bmatrix} \quad \sigma_3 = \begin{bmatrix} 0 & 1 \\ 1 & 0 \end{bmatrix}. \quad (2-10)$$

In addition to these also the unity matrix is required, which is defined as:

$$\sigma_0 = I = \begin{bmatrix} 1 & 0 \\ 0 & 1 \end{bmatrix}. \quad (2-11)$$

It can simply be verified that:

$$\sigma_1^2 = \sigma_2^2 = \sigma_3^2 = 1$$

$$\sigma_1\sigma_2 = j\sigma_3; \quad \sigma_3\sigma_1 = j\sigma_2, \quad \sigma_2\sigma_3 = j\sigma_1 \quad \text{and} \quad \sigma_i\sigma_j = -\sigma_j\sigma_i \quad \text{for } i \neq j. \quad (2-12)$$

So, squaring of the momentum relationship, as in (2-6), can be justified if (for instance):

$$\alpha = \alpha(\sigma_3, \sigma_1) \quad \text{and} \quad \beta = \sigma_2. \quad (2-13)$$

Note: It may seem that the Pauli matrices can be assigned in an arbitrary order. However, this freedom does appear not to exist. The reason is that the Dirac decomposition is not the only condition that has to be fulfilled. There is an additional constraint, which states that:

$$\Psi_1\Psi_2^* + \Psi_1^*\Psi_2 = 0. \quad (2-14a)$$

This constraint is a consequence of the requirement for positive definiteness of the probability function  $Pr(x, t)$  given by:

$$Pr(x, t) = \Psi_1\Psi_1^* + \Psi_1\Psi_2^* + \Psi_1^*\Psi_2 + \Psi_2\Psi_2^* = |\Psi_1|^2 + |\Psi_2|^2. \quad (2-14b)$$

As we shall see, the assignment given by (2-13) will eventually yield a solution that satisfies condition (2-14a). In most textbooks this assignment problem is usually overlooked and the problem is settled by quoting something as: “among the various possibilities we choose....”.

As the impulse relationship is two-dimensional, the wave function  $\Psi$  should be two-dimensional as well. Therefore  $\Psi = \Psi(\Psi_1, \Psi_2)$ . After transforming the impulses into operators on wave functions (see 2-3), the impulse relationship is transformed into the following two-dimensional wave equation:

$$\begin{bmatrix} \hat{\sigma}_1 \\ \hat{\sigma}_2 \\ \hat{\sigma}_3 \end{bmatrix} \begin{bmatrix} \hat{p}'_0 \Psi_1 \\ \hat{p}'_0 \Psi_2 \end{bmatrix} + \begin{bmatrix} \hat{\sigma}_2 \\ \hat{\sigma}_1 \\ \hat{\sigma}_3 \end{bmatrix} \begin{bmatrix} \hat{p}'_x \Psi_1 \\ \hat{p}'_x \Psi_2 \end{bmatrix} + \begin{bmatrix} \hat{\sigma}_3 \\ \hat{\sigma}_1 \\ \hat{\sigma}_2 \end{bmatrix} \begin{bmatrix} \Psi_1 \\ \Psi_2 \end{bmatrix} = 0, \quad (2-15)$$

or, with explicit expressions of the Pauli matrices:

$$\begin{bmatrix} 0 & 1 \\ 1 & 0 \end{bmatrix} \begin{bmatrix} \hat{p}'_0 \Psi_1 \\ \hat{p}'_0 \Psi_2 \end{bmatrix} + \begin{bmatrix} 1 & 0 \\ 0 & -1 \end{bmatrix} \begin{bmatrix} \hat{p}'_x \Psi_1 \\ \hat{p}'_x \Psi_2 \end{bmatrix} + \begin{bmatrix} 0 & -j \\ j & 0 \end{bmatrix} \begin{bmatrix} \Psi_1 \\ \Psi_2 \end{bmatrix} = 0. \quad (2-16)$$

This reads as the following two equations:

$$\hat{p}'_0 \Psi_2 + \hat{p}'_x \Psi_1 - j \Psi_2 = 0 \quad \text{and} \quad \hat{p}'_0 \Psi_1 - \hat{p}'_x \Psi_2 + j \Psi_1 = 0, \quad (2-17)$$

or, after denormalization (2-4):

$$\hat{p}_0 \Psi_2 + \hat{p}_x \Psi_1 - j m_0 c \Psi_2 = 0 \quad \text{and} \quad \hat{p}_0 \Psi_1 - \hat{p}_x \Psi_2 + j m_0 c \Psi_1 = 0, \quad (2-18a,b)$$

or, in matrix terms:

$$\begin{bmatrix} \hat{p}_x & \hat{p}_0 - j m_0 c \\ \hat{p}_0 + j m_0 c & -\hat{p}_x \end{bmatrix} \begin{bmatrix} \Psi_1 \\ \Psi_2 \end{bmatrix} = 0. \quad (2-19)$$

Such first order partial differential equations have harmonic wave function solutions of the type:

$$\Psi_i(x, t) = u_i \exp \left[ j \left( \beta \frac{p_x}{\hbar} x - \frac{E}{\hbar} t \right) \right], \quad (2-20)$$

with parameters  $u_i, p_x, E, \beta$ . The characteristics of these parameters are reflected in the chosen symbols: the dimensionality of  $p_x$  is that of a momentum, the dimensionality of  $E$  is that of an energy,  $\beta$  is dimensionless and  $u_i$  is the amplitude of the wave function.

This implies that the two components of the wave function are supposed to have a similar behavior, but that they may differ in amplitude, albeit that may show a temporal time shift. The latter is the case if a phase factor is included in  $u_i$ , which implies that  $u_i$  might be complex.

After substitution of (2-20) into (2-19) we find:

$$\begin{bmatrix} \beta p_x & j(E/c - m_0 c) \\ j(E/c + m_0 c) & -\beta p_x \end{bmatrix} \begin{bmatrix} u_1 \\ u_2 \end{bmatrix} = 0. \quad (2-21)$$

Non-trivial solutions for  $u_i$  are obtained if the determinant of the matrix is zero. This is true if:

$$\frac{E^2}{c^2} = \beta^2 p_x^2 + m_0^2 c^2. \quad (2-22)$$

Comparing this expression with (2-1) and (2-5) we conclude that the condition of a zero value for the determinant reads as:

$$\beta = \pm 1. \quad (2-23)$$

This means that the assumptions we made on the character of the wave function, as expressed by (2-20) are justified. It also means a dual outcome of the determinant expression. This dual outcome simply means that the spatial part of the wave function can be a real function instead of just a complex one. And that is what we would expect from a wave function that meets the requirements for locality. Only if the wave function is spatially real it is possible to compose a spatially confined probability package out of an ensemble of individual wave functions. So, we would have to be surprised if the outcome of the determinant expression would *not* have been dual.

Let us now calculate the ratio of the amplitude values  $u_i$ . It follows now straightforwardly from (2-21) that

$$u_2 = \pm j \frac{v_x}{c(w+1)} \quad \text{if } u_1 = 1. \quad (2-24),$$

wherein  $w = \sqrt{1 - (v_x/c)^2}$ .

This means that the amplitude of the second component of the wave function is usually much smaller than the first component. In the non-relativistic limit this component is negligible. The imaginary value of the amplitude of the second component implies a ninety-degree temporal phase shift of the second component as compared with the main component. Obviously there are two possible values of the phase factor. It is therefore said that the “spin” can be positive or negative.

There is something more. By substitution of (2-23) into (2-22) and subsequent evaluation under consideration of (2-4) and (2-5) we learn that:

$$E = \pm W/c. \quad (2-25)$$

That means that Dirac's Equation is not only satisfied by a positive value of  $E$  but by a negative value as well. As long as no semantics are connected to the parameter  $E$ , this sign ambiguity does not mean anything else apart from a *frequency ambiguity* in the wave function (2-20). And, according to the Born-interpretation, frequency ambiguity has no influence on the observability of a particle.

Nevertheless this phenomenon is usually being regarded as Dirac's famous puzzle of "*negative energy*". So, what was the reason of Dirac's wonder? The reason is a wonder about the interpretation of a negative temporal moment. Obviously two types of wave function, one with a positive frequency and another with a negative frequency can satisfy Dirac's Equation. Do these two wave equations imply two types of particles or do they just imply that one and the same particle can be represented by two different wave functions? Or even stronger: does it imply that the second wave function implies that the particle can be in two different states (apart from the spin state)? It is clear that more types of particles hypothetically can satisfy these wave equations as long as the dynamics of motion are the same. But if the particles are distinguishable it can only be done by a parameter that has no influence on the dynamics of motion.

Such a particle was identified in 1932, when Anderson discovered a particle with the same rest mass as the electron, but with positive electric charge: the *positron*. Anderson's nebula chamber experiment showed the simultaneous generation from cosmic rays of electrons and positrons in parallel paths, which deviate by magnetic fields. This suggested the conversion of zero mass particles of electromagnetic energy into dual mass particles with opposite charge. This phenomenon shows that electrons and positrons are intimately related particles with the same mass but in a different state. This state difference between electrons and positrons can adequately be attributed to the difference in sign of the relativistic temporal momentum. Therefore a positron can be regarded as an electron moving backwards in time, i.e. as an electron in a different state. As a positron and electron are generated by a zero mass particle of electromagnetic energy, they may destroy each other as well, thereby generating electromagnetic radiation. The theoretical modeling of such kind of processes is beyond the scope of classical or relativistic quantum mechanics. Therefore quantum mechanical theory has been extended towards Quantum Field Theory (QFT).

The theoretical prediction of this *antiparticle* and its later experimental verification is now seen as one of the great triumphs in the history of science. The present state of art in quantum theory on nuclear particles has revealed more of those symmetries, implying many other anti-particles (*anti-matter*).

This simplified view on Dirac's Equation is helpful to highlight some consequences, which remain usually undiscussed in most textbooks. In a Side Note added to this paper one of these issues is discussed. It deals with the question about the characteristics of a valid wave equation under the assumption that the spin component is sufficiently small to be neglected.



### 3. Yang Mills Principle

So far we have only considered wave equations in free space. In this section we wish to study wave functions of particles moving in a space under influence of external fields of forces. We shall base this study upon Dirac's Equation and we will start from some observations for time-space with a single spatial dimension. As derived above, Dirac's Equation has the solution given by:

$$\Psi_1 = u_1 \exp\left[-j\frac{E}{\hbar}t\right] \left\{ \alpha_c \cos\left[\frac{p_x}{\hbar}x\right] + \alpha_s \sin\left[\frac{p_x}{\hbar}x\right] \right\}$$

and: 
$$\Psi_2 = ju_2 \exp\left[-j\frac{E}{\hbar}t\right] \left\{ \alpha_c \cos\left[\frac{p_x}{\hbar}x\right] + \alpha_s \sin\left[\frac{p_x}{\hbar}x\right] \right\}, \quad \alpha_c, \alpha_s, u_1, u_2 \text{ real valued.} \quad (3-1)$$

The wave function interpretation in terms of a probability density function is:

$$Pr(x, t) = \Psi_1 \Psi_1^* + \Psi_1 \Psi_2^* + \Psi_2 \Psi_1^* + \Psi_2 \Psi_2^* = |\Psi_1|^2 + |\Psi_2|^2. \quad (3-2)$$

The canceling of the cross products is due to a particular phase relationship between  $\Psi_1$  and  $\Psi_2$ :

$$\Psi_2 = \frac{u_2}{u_1} \exp\left[-j\frac{\pi}{2}\right] \Psi_1 \quad (3-3)$$

As (3-2) is the major property for an extension of a simplex scalar wave function towards a wave function with dual format, we might ask if other relationships apart from (3-3) would provide the same property. Let us inspect (3-1) for the purpose. Under a constant phase shift  $\vartheta_0$ , such that:

$$\exp\left[-j\frac{E}{\hbar}t\right] \rightarrow \exp\left[-j\left(\frac{E}{\hbar}t + \vartheta_0\right)\right],$$

property (3-2) remains valid. This property is known under the name *global phase invariance* of the wave function. Interestingly, property (3-2) remains valid as well if the phase shift shows a spatial dependency, i.e. if

$$\exp\left[-j\frac{E}{\hbar}t\right] \rightarrow \exp\left[-j\left(\frac{E}{\hbar}t + \vartheta(x)\right)\right]. \quad (3-4)$$

This is known as *local phase invariance* of the wave function. Where the global phase invariance shows up as a result of an arbitrary integration constant in the solution of Dirac's Equation in free space, local phase invariance does not. So it requires an additional influence.

Yang and Mills hypothesized (in 1954) *that under influence of a field of forces the global phase invariance of quantum mechanical wave functions is changed into local phase invariance*, similarly as Einstein's hypothesis of change of global Lorentz transform invariance into local Lorentz transform invariance under similar conditions [9]. Similarly as Einstein's Principle of Equivalence this Yang Mills Principle excels in beauty and, as will be shown below, it will enable an elegant transform of free space quantum mechanical wave equations into wave equations in fields of forces.

To investigate the feasibility we apply a generic phase rotation on the wave function, such that:

$$\Psi_0 + j\Psi_1 = \exp[-j\vartheta(x)]\{\Psi_0' + j\Psi_1'\}. \quad (3-5)$$

Herein the  $\Psi' = \Psi_0' + j\Psi_1'$  represents the global phase invariant wave function and  $\Psi = \Psi_0 + j\Psi_1$  represents the presupposed local phase invariant wave function. It is supposed that both these functions obey the same wave equation if this wave equation has a suitable covariant format. To establish this format, covariant derivatives have to be found in terms of a vector field  $\mathbf{A}(A_0, A_x)$ , which is supposed to be the cause of the change of global phase invariance into local phase invariance.

A covariant derivative  $D\Psi/\partial x_i$  has to obey the property that it transforms similarly as the argument  $\Psi$  (3-5), so as:

$$\frac{D\Psi}{\partial x_i} = \exp[-j\vartheta(x)]\frac{D\Psi'}{\partial x_i} \quad \text{wherein } x_0 = jct \text{ and } x_1 = x. \quad (3-6)$$

As will be shown below, this can be obtained by defining the covariant derivative as:

$$\frac{D\Psi}{\partial x_i} = \frac{\partial\Psi}{\partial x_i} + jqA_i\Psi. \quad (3-7)$$

If  $\vartheta(x)$  were a simple constant, the spatial and temporal derivatives would have the format:

$$\frac{\partial\Psi}{\partial x_i} = \exp[-j\vartheta(x)]\frac{\partial}{\partial x_i}\Psi'. \quad (3-8)$$

But the spatial dependence spoils this simple format for the spatial derivative into:

$$\frac{\partial\Psi}{\partial x} = \exp[-j\vartheta(x)]\frac{\partial}{\partial x}\Psi' - j\exp[-j\vartheta(x)]\Psi'\frac{\partial}{\partial x}\vartheta(x). \quad (3-9)$$

To guarantee compatibility between conditions (3-6), (3-7) and (3-8), the field components  $A_i$  have to fulfill the following condition (see appendix A):

$$qA_i = qA_i' + \frac{\partial}{\partial x_i} \mathfrak{G}(x). \quad (3-10)$$

Herein  $q$  is a proportionality factor, known as coupling constant. In the case of electromagnetic fields the coupling factor is identified as electric charge. Under this condition the covariant derivative has the format as defined in (3-7). It is a so-called *gauge condition*. Note that this condition is a result of the proposed format for the covariant derivative under the covariance condition. Another format would have resulted in another gauge condition. Such a gauge condition can always be *formulated* but cannot always be *met*. It is met if the Lagrangian density of the (gauge) field is invariant under the gauge condition. The Lagrangian density is expressed by:

$$\mathcal{L}_g = -\frac{1}{16\pi} \sum_i \sum_j |F_{ij}|^2 \quad \text{wherein} \quad F_{ij} = \frac{\partial A_j}{\partial x_i} - \frac{\partial A_i}{\partial x_j}. \quad (3-11)$$

It can be easily verified that under condition (3-10):

$$F_{ij} = \frac{\partial A_j}{\partial x_i} - \frac{\partial A_i}{\partial x_j} = F_{ij}' = \frac{\partial}{\partial x_i} A_j' - \frac{\partial}{\partial x_j} A_i'. \quad (3-12)$$

The underlying reason is that the addition of scalar function on  $A_x$  has no influence on the magnetic field ( $\mathbf{B} = \nabla \times \mathbf{A}$ ). Or, formulated more principally:

*The very reason that covariant derivatives can be found in terms of the vector field  $\mathbf{A}$  is the fact that the Lagrangian density of this vector field is invariant under local phase rotations.*

The relevance of the considerations above is this: the wave function of particle moving in a field forces can be found by solving its wave equation. This wave equation is a transformed version of the free field wave equation. The transformation consists out of replacing normal derivatives by covariant derivatives. The format of the covariant derivative is subject to a gauge condition on the vector potential of the field forces. The format of the gauge condition results from application of the Yang Mills hypothesis. This hypothesis supposes that the global phase invariance of the wave function of a free moving particle is changed into local phase invariance if the particle is subject to a field of forces.

In fact the Yang Mills hypothesis does not reveal anything new in the case of quantum electrodynamics (QED). It is just another formulation for the so-called *principle of minimum substitution*. This principle states that the wave equation of a charged particle moving in an electromagnetic field can be found from the equation of motion in a free field after transform of the momenta by the rule

$$p_i \rightarrow p_i - jqA_i \quad (3-13)$$

and subsequent application of the basic quantum mechanical theorem:

$$\hat{p}_i \Psi \rightarrow (\hat{p}_i - jqA_i) \Psi \quad \text{with} \quad \hat{p}_i = \frac{\hbar}{j} \frac{\partial}{\partial x_i} . \quad (3-14)$$

As electromagnetic theory can be captured as a subset within the larger Yang Mills framework, other fields of forces may do as well. So, nucleon forces are candidates as well. A main difference between electromagnetic force and nuclear force is the effective range of influence: where electromagnetic forces (and gravitational forces) are long ranged, nucleon forces are short ranged. As already mentioned in the introduction, in 1935, in an attempt to bring nucleon forces within the electromagnetic framework, Proca had suggested a generalization of Maxwell's Equations by introducing a mass term, which appeared to have the desired effect. In the next section, which deals with the relationship between Lagrangian density and wave equations, we shall come back on this.

#### 4. Lagrangian density and wave equations

There is some ambiguity in the concept of wave equations in quantum theory. Sometimes the semantics are probabilistic and sometimes energetic. The quantum mechanical wave equation of a particle is probabilistic: the square of the absolute value of the wave function solution is the probability to find the particle at a certain time at a certain position. It is therefore prone to confusion, although not always incorrect, to derive such a quantum mechanical wave equation from a Lagrangian density [12]. Lagrangian density is an energetic concept. At the other hand electromagnetic waves are clearly energetic and there is no objection to apply the Lagrangian density as a condensed format for their description. A force sensitive particle, such as an electron, is both *target* of an energetic field and *source* of it. As Dirac's Equation (unlike the Klein Gordon Equation) has a decent Lagrangian density [13] it is possible and common practice to assemble a composite Lagrangian density to capture both these aspects. Within the scope of this paper we prefer an alternative approach. We wish to adopt initially a dual assignment: one wave function and associated wave equation for the probabilistic (fermionic) aspect and an additional separate one for the energetic (bosonic) aspect. For the bosonic aspect the Lagrangian density concept will be used, for the fermionic aspect we wish to elaborate directly in terms of a wave equation without a Lagrangian layer above. Later on we wish to rediscuss the feasibility of a composite Lagrangian density. For further clearness we shall use the symbol  $\Psi$  for fermionic wave functions and the symbol  $\Phi$  for the scalar part of a vector field.

Fig. 1 is a graphical illustration of the model. At the right it is indicated that the free space Dirac's Equation is directly formulated from the mass of the particle, i.e. electron. The free space wave equation is transformed under influence of an external energetic vector field (by application of Yang Mills Principle) into the "in-field wave equation". This represents the fermionic aspect. If

desired, this fermionic path can be simplified by ignoring spin. The dotted boxes in the upper right part of the figure show this.

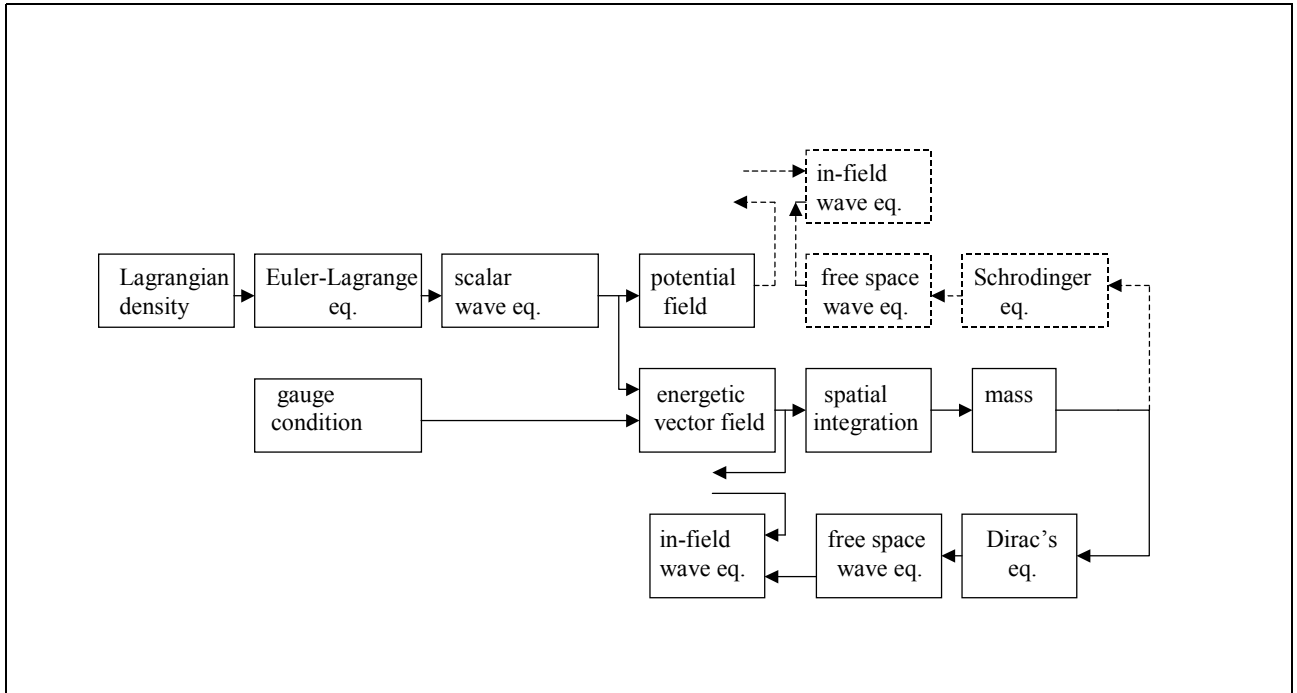

**Fig. 1: Relationship between Lagrangian density and wave equations.**

The left hand part illustrates the generation of the bosonic field, i.e. the electromagnetic field, by the particle, i.e. electron. A scalar wave equation, i.e. the potential field, is derived from the electromagnetic Lagrangian density by application of the Euler Lagrange equations. After application of the Lorenz gauge the full electromagnetic vector field is obtained, which acts as an interfering field for other particles sensitive for electromagnetic fields. In this picture self-interaction (a refinement in Quantum Field Theory) is not taken into consideration. The picture also shows the relationship between the mass of an electron and the electromagnetic energy created by it. In the case that we have to do with a point-like particle, such as an electron, the spatial integral of the components of the vector field, such as electric and magnetic field strengths, determine the mass of the particle.

Note: Usually the Lagrangian density of the electromagnetic field is expressed in terms of (3-11), covariantly written as:

$$\mathcal{L}_g = -\frac{1}{16\pi} F^{\mu\nu} F_{\mu\nu}. \quad (4-A)$$

From this Lagrangian density a wave equation is derived in terms of the (four-)vector potential  $\mathbf{A}$ , which assumes a simple format under an additional condition. The format is:

$$\frac{1}{c^2} \frac{\partial^2 \mathbf{A}}{\partial t^2} - (\nabla \cdot \nabla) \mathbf{A} = \mathbf{J}. \quad (4-B)$$

The vector  $\mathbf{J}$  contains the sources of the field, i.e. currents and space charge. The additional condition is known as the Lorenz gauge. It reads as:

$$\nabla \cdot \mathbf{A} + \frac{1}{c^2} \frac{\partial \Phi}{\partial t} = 0. \quad (4-C)$$

As long as we are only interested in the potential field  $\Phi$ , which is (apart from a proportionality constant) the very first component of the vector potential, we may work with a simplified wave equation and consequently with a simplified Lagrangian density.

The picture as shown in fig.1 has been assembled with the electron in mind. Let us forget now the electron in an attempt to generalize the picture to other type of particles, particularly with respect to the bosonic field that they may generate. Let us model this bosonic field by means of a Lagrangian density with a generic stationary part of the format:

$$\mathcal{L}_g = \frac{1}{2} (\nabla \Phi)^2 - U(\Phi). \quad (4-1)$$

From this Lagrangian the wave equation is derived via the Lagrange Euler equations, resulting into:

$$\nabla(\nabla \Phi) = \frac{d}{d\Phi} U(\Phi). \quad (4-2)$$

Wave equations are often expressed in terms of *potential functions*  $V_\Phi(\Phi)$  (also called potential for short) rather than in *potential energy*  $U(\Phi)$ . Equation (4-2) then has the format:

$$\nabla(\nabla \Phi) = V_\Phi(\Phi) \Phi \quad \text{so that} \quad V_\Phi(\Phi) \Phi = \frac{d}{d\Phi} U(\Phi) \quad (4-3)$$

Such potential functions cannot only expressed functionally as  $V_\Phi(\Phi)$  but, equivalently, spatially as well as  $V(x, y, z)$ .

If  $U(\Phi) = 0$  and if the field is spherically symmetric, the field is Coulomb-like ( $V(r) \sim 1/r$ ) and has therefore a long range. Short-range properties of energetic fields require particular formats for  $U(\Phi)$ . A characteristic example is the exponentially decaying Proca field  $V(r) \sim \exp[-\lambda r]/r$ , which is obtained for:

$$U(\Phi) = \frac{\lambda}{2}\Phi^2. \quad (4-4)$$

In section 3 it has been stated that the behavior of a particle sensitive for potential fields is subject to Yang Mills Principle. This principle supposes the existence of a four-vector potential  $\mathbf{A}(A_0, A_x, A_y, A_z)$  wherein the scalar potential  $\Phi$ , possibly apart from a proportionality factor, is the very first component  $A_0$ . Therefore a Lagrangian density as defined by (4-1) is incomplete. The full specification requires a description for the production rules for all vector potential components and the sources of origin. In addition it requires a test on the local phase invariance on these components. So far, we have only done so for the electromagnetic field (see section 3).

Within the scope of this paper we shall not spend a further discussion on the Proca field, although it would be very instructive and not difficult to handle. The Proca field equations appear not to withstand the local invariance test. It is therefore not relevant for the thread of this paper.

Instead we wish to discuss rather extensively a potential field that has become known as the Higgs field [19,20]. Like the Proca field it is a heuristic proposal. It is specified as:

$$\mathcal{L}_g = \frac{1}{2}(\nabla\Phi)^2 - U(\Phi) \quad \text{wherein} \quad U(\Phi) = -\frac{1}{2}\mu_c^2\Phi^2 + \frac{1}{4}\lambda_c^2\Phi^4, \quad (4-5)$$

wherein  $\mu_c$  and  $\lambda_c$  are parameters with real values. Fig.2 shows a comparison of the functional behavior of the potential energy in the GSW-model (right) and the functional behavior of the potential energy in the Proca model (left).

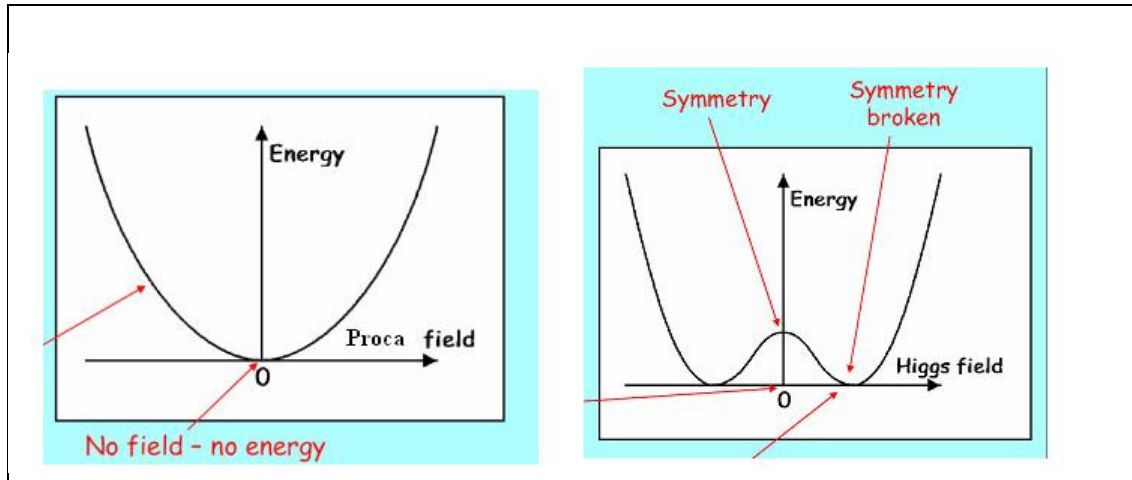

**Fig. 2: Potential energy as a function of  $\Phi$ .**

Although the Lagrangian density in both cases shows global phase invariance there is a symmetry shift of the minimum value of the Higgs potential. It is said that *the symmetry is broken*. As we shall see below it is this broken symmetry, which will allow local phase invariance for short-range

gauge fields. Broken symmetries are not unusual in physics. Examples of broken symmetry are ferro-magnetism and super conductivity. In those cases the properties of the internal electromagnetic fields are changed under the influence of an external energetic influence, in casu under influence of temperature. The permanence of ferro-magnetism is lost above the so-called Curie temperature and super conductivity only occurs at cryogenic temperature levels. These phenomena are commonly modeled with heuristic manipulation of electromagnetic laws. In the next section we wish to present a novel analysis of the Higgs field.

## 5. The Higgs field.

We wish to consider the Higgs field under conditions of rotational symmetry. Application of the Lagrange Euler equations on the Lagrangian density as given by (4-1) gives:

$$\frac{1}{r} \frac{d^2}{dr^2}(r\Phi) = \frac{d}{d\Phi}U(\Phi) \quad (5-1)$$

sowith (4-5):

$$\frac{1}{r} \frac{d^2}{dr^2}(r\Phi) = -(\mu_c^2 - \lambda_c^2 \Phi^2)\Phi. \quad (5-2)$$

This equation is difficult to solve. Rather than expanding the potential function  $\Phi$  around the local minimum, like done in canonic theory, we wish to follow a different approach. This starts with profiling a tentative solution of (5-2). Let us assume that the solution of (5-2) has a format as:

$$\Phi(r) = \Phi_0 \frac{\exp[-\lambda r]}{\lambda r} \left( \frac{\exp[-\lambda r]}{\lambda r} - 1 \right). \quad (5-3)$$

This may seem an arbitrary guess. Let us explain the reasons for this guess. Recently Ishii [17,18] has shown a graph for the inter-nucleon potential as he with his team derived from a detailed numerical mathematical model wherein virtually all knowledge of the present state of canonic particle theory is accommodated. This is shown at the left hand part of fig.3. The right-hand part shows a curve fitting on the basis of (5-3) made by the author of this paper. The curve fits for  $\lambda = 1, 224 \text{fm}^{-1}$  and  $V_0 = 140, 55 \text{MeV}$ . This curve shows the expected behavior of a combination of attractive and repulsive forces. It could well be that such a potential does not only fit at the level of the nucleon, but also at the level of a sub-nucleon. This observation will serve as the thread for our strategy to solve (5-2): Instead of solving (5-2) we adopt the spatial format of this Ishii-potential as a solution and we calculate the functional format of the right-hand part of (5-2) as a consequence of this adoption. So, in mathematical terms:

Step 1: From given  $\Phi(r)$  we calculate from (5-1) a spatial expression for  $dU/d\Phi$ .

Step 2: We make a parametric plot of  $dU/d\Phi$  versus  $\Phi(r)$  (elimination of  $r$ ).



Step 3: We apply a curve fit procedure to obtain a polynomial expression for  $dU/d\Phi$  as a function of  $\Phi$ .

Step 4: We integrate this expression, so that  $U$  as a function of  $\Phi$  is obtained.

Let us normalize (5-3) as:

$$\eta(\rho) = \frac{\exp[-\rho]}{\rho} \left( \frac{\exp[-\rho]}{\rho} - 1 \right) \quad \text{with } \eta = \Phi/\Phi_0 \quad \text{and } \rho = \lambda r. \quad (5-4)$$

:

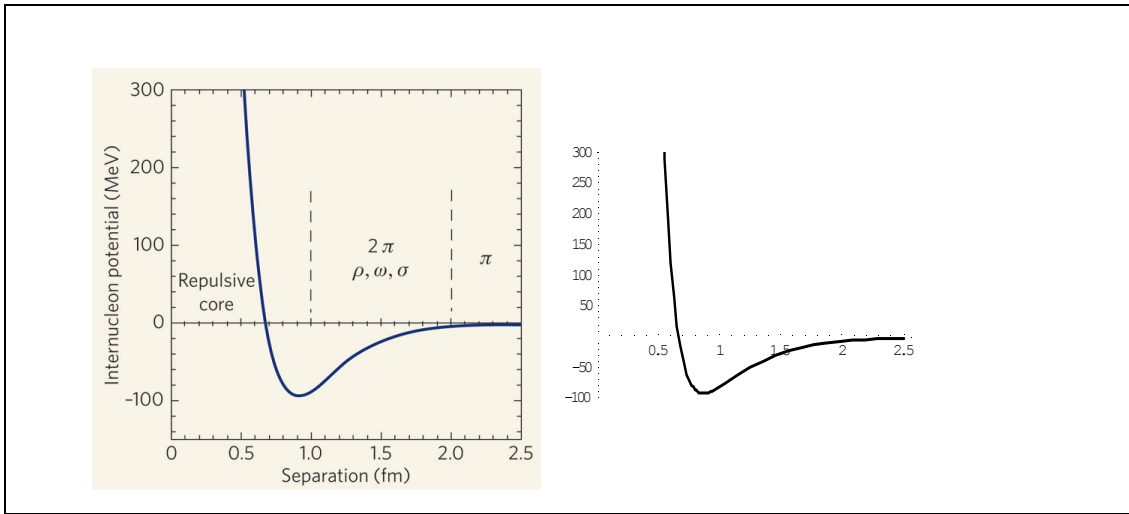
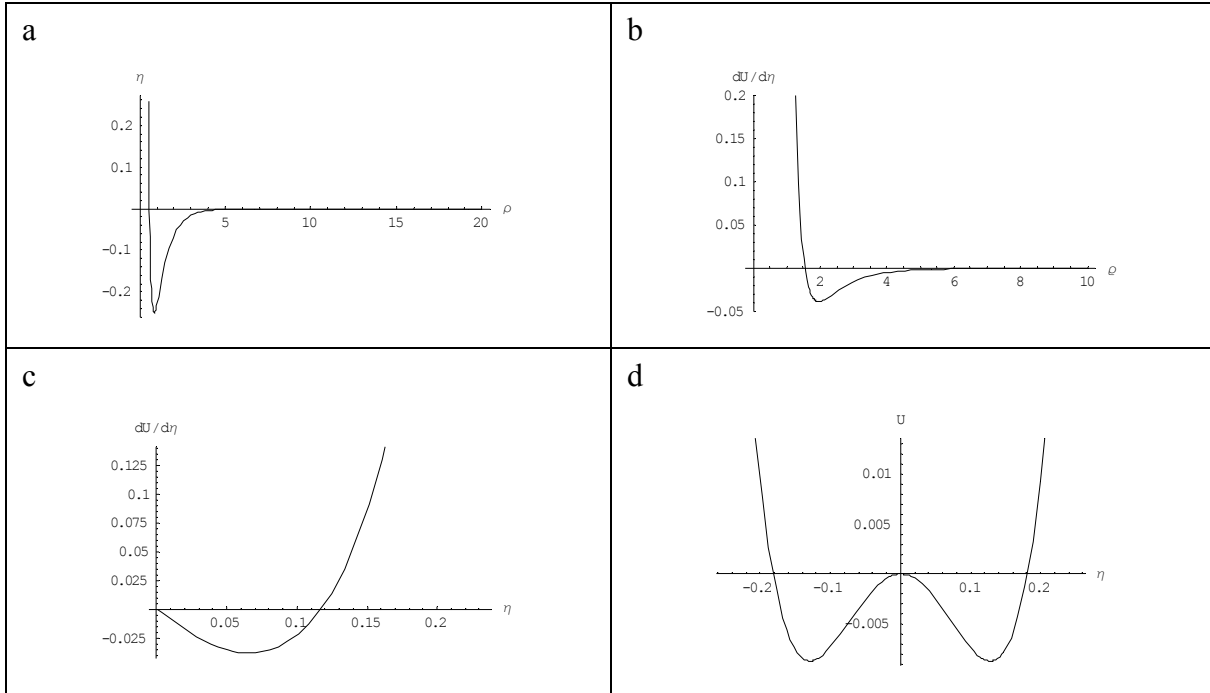

Fig. 3: Potential function of the nucleon doublet as shown by F. Wilczek [17].

The results of the numerical procedure are shown in fig.4. In a:  $\eta(\rho)$ . In b:  $dU/d\eta$ . In c: the parametric plot of  $dU/d\eta$  vs.  $\eta$  and in d:  $U(\eta)$ . The polynomial fit is:

$$U(\eta) = -A\eta^2 + B\eta^4 \quad \text{with } A = 1,06 \quad \text{and } B = 32,3 \quad (5-5)$$



**Fig. 4: Ishii-potential vs. radius (a), functional derivative of potential energy vs. radius (b), functional derivative of potential energy vs. wave function (c), potential energy vs. wave function, i.e. Higgs field (d).**

Comparing (5-5) with (4-5), we may state that the heuristic Higgs potential matches surprisingly well with the heuristic Ishii potential. It does not mean that both formats are identical: they are just an approximation of each other. There is however no reason why one of the two is the better one. A spatial format, like the Ishii potential is, is more easily understood in its physical interpretation.

Some explanation is needed for the right hand part of the field equation (5-2). In classic Maxwellian electromagnetic field theory for free space the right hand part of (5-2) is zero, so that the solution of the time-independent wave equation is a Coulomb field. There is however something odd, that is to say something undefined, with the Coulomb potential. A zero right-hand part of (5-2) means that no source charge is supposed to be present. This is an oversimplification, because without a source there is no field. What is meant of course is, that there is no source charge for  $r > 0$ . But there must be one (with a Dirac delta-pulse shape) at  $r = 0$ . So, a time-independent wave equation wherein the right-hand part is spatially expressed is nothing else than Poisson's wave equation with some source for  $r \geq 0$ . The charge distribution is the one shown in the right upper part of fig.4 (i.e.  $dU/d\eta$ ). This is rapidly decaying, so effectively zero after a very small value of  $r$ .

So, a *monopole* with this source gives a direct electromagnetic interpretation for the Higgs potential. Therefore, in a monopole concept there is no reason to adopt something like a *Higgs field* from a hypothetical spin-less Higgs particle, which gives mass to other particles, like it is hypoth-

esized in the canonic theory of the Standard Model. In spite of efforts over more than forty years, such a Higgs particle has never been found. So, it is the author's belief that it does not exist, but instead that nuclear forces are carried by point-like monopoles (quarks), similarly as electromagnetic forces are carried by leptons (electrons). The monopole explanation for the Higgs field gives the same unification of electromagnetic theory and theory for weak interaction as the canonic theory does, but it has the merit that no hypothetical Higgs particle is needed for this unification. In the subsequent sections of this paper this concept will be further explained.

Considering doublet structures of particles will ease the explanation. An example of a doublet is the nucleon doublet, composed by a proton and a neutron. Although these particles are not point-like, they may be described in terms of wave functions. A proton and a neutron are subject to a combination of short-range attracting and repulsive forces such that equilibrium may occur. The attractive and repulsive forces of two nucleons will bind them together in a stationary position while the two nucleons can be vibrating. As the center of gravity will maintain a static position the system can be conceived as two individual mass-spring systems. So, there is a state of minimum energy with minimum stress on the spring. This minimum state of energy corresponds with a particular amount of spacing between the nucleons. If by slight force this initial spacing is decreased or increased and subsequently released, each of nucleons will start to perform an harmonic oscillation. This harmonic oscillation is subject to quantum mechanical laws, so each of the two systems shows ground state energy and may move to higher states of energy in quantum steps, while the nucleons keep a constant average spacing with respect to each other. This mechanism is the origin of the radiation of bosonic particles, known as pi-mesons. As mentioned in the introduction Yukawa not only predicted the existence of such particles, but was also able to predict a rather accurate estimate of their mass. Like protons and neutrons, these pi-mesons are composite particles, consisting of two quarks. So, there is good reason that doublet structures are not only apparent at the level of composite particles, but at the level of point-like particles as well.

In particular doublets of particles will be considered under influence of potential fields that enable a stable configuration. As suggested above, this will bring the doublet into a status of harmonic

oscillation, thereby creating conditions for absorption or radiation of bosonic particles that look like photons. This is graphically illustrated by fig.5.

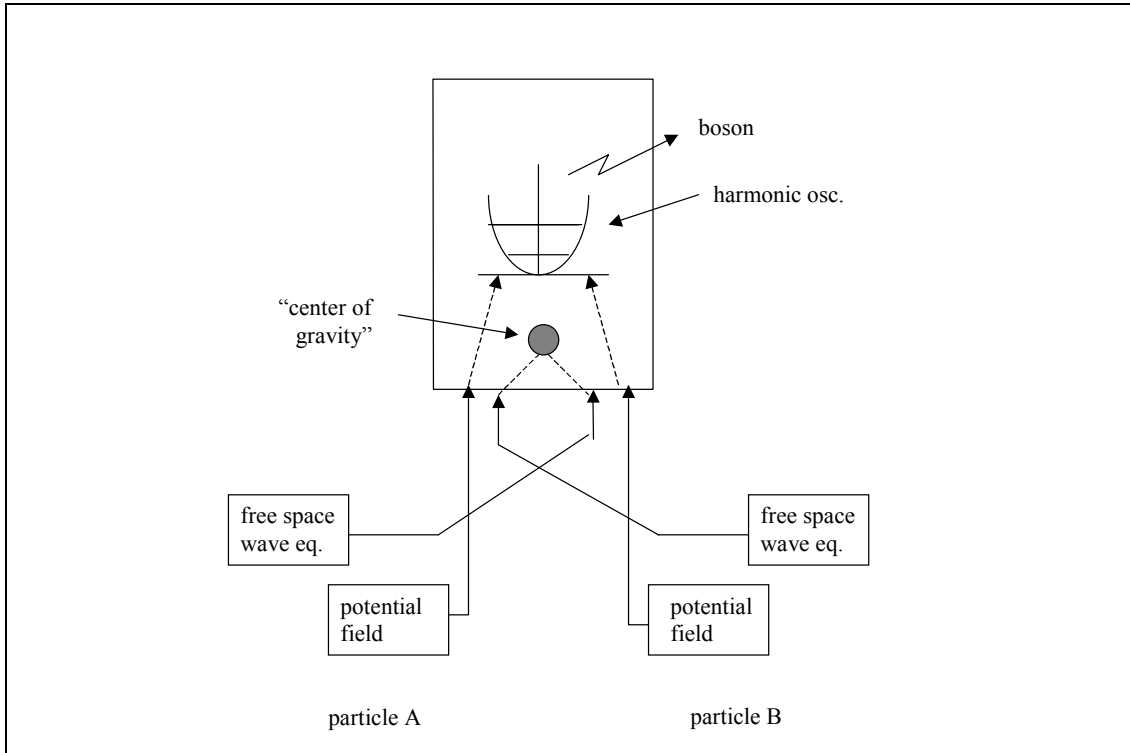

**Fig. 5: Harmonic oscillation condition of doublets.**

In the next section we wish to consider doublet structures in more detail.

## 6. The doublet.

### 6.1 The wave function doublet

Global phase invariance (and therefore local phase invariance) of a doublet is slightly different from that of a singlet in the sense that it is more than the phase invariance of two individual wave functions. Let us consider the composite  $\Psi$  of the doublet, i.e.

$$\Psi = \Psi_a + \Psi_b = (\Psi_{ar} + j\Psi_{ai}) + (\Psi_{br} + j\Psi_{bi}). \quad (6-1)$$

The wave function  $\Psi$  can be seen as a vector in a four-dimensional space  $(\Psi_{ar}, \Psi_{ai}, \Psi_{br}, \Psi_{bi})$ . What kind of phase rotation has no influence on the square of its amplitude (being the relevant parameter)? Rather than a phase rotation over a single angle, there are three possible independent angles now. Let us follow the same procedure as with (3-5) to (3-8). Local phase transformation is written as:

$$\Psi = \exp[-j\vartheta_k(x)]\Psi', \text{ with } k = 1, 2, 3. \quad (6-2)$$

The covariant derivative has the same format as its argument, so:

$$\frac{D\Psi}{dx_i} = \exp[-j\vartheta_k(x)]\frac{D\Psi'}{dx_i}. \quad (6-3)$$

The format of this covariant derivative is tentatively supposed to be:

$$\frac{D\Psi}{dx_i} = \frac{\partial\Psi}{\partial x_i} + jgB_{ki}\Psi. \quad (6-4)$$

As compared with (3-7) the coupling factor is renamed as  $g$  and the components of the now multiple vector field are renamed as  $B_{ki}$ .

If  $\vartheta_k(x)$  were a simple constant, the spatial and temporal derivatives would have the format:

$$\frac{\partial\Psi}{\partial x_i} = \exp[-j\vartheta_k(x)]\frac{\partial\Psi'}{\partial x_i}. \quad (6-5)$$

But the spatial dependence spoils this simple format for the spatial derivative into:

$$\frac{\partial\Psi}{\partial x} = \exp[-j\vartheta_k(x)]\frac{\partial\Psi'}{\partial x} - j\exp[-j\vartheta_k(x)]\Psi'\frac{\partial\vartheta_k(x)}{\partial x}. \quad (6-6)$$

To guarantee compatibility between conditions (6-2), (6-3) and (6-4), the field components  $B_{ki}$  have to fulfill the following condition (see appendix A):

$$gB_{ki} = gB_{ki}' + \frac{\partial}{\partial x_i}\vartheta_k(x). \quad (6-7)$$

This result suggests that a doublet of wave functions shows local phase invariance under influence of an assembly of three gauge fields in the case that these three fields fulfill the gauge condition. The format of the gauge condition is similar to the one for electromagnetic fields in the sense that gauge freedom should exist to add a scalar function to the spatial field vector component.

Stated otherwise: an assembly of three fields of forces is required to let two particles (wave functions) behave as a stationary assembly (doublet). The three fields are subject to an electromagnetic-like gauge condition.

Remark: the reason that three forces come forward, rather than one, is the presupposed degree of freedom of the wave function orientation in  $\Psi$ -space. Note that this orientation is not a spatial one. It can equally apply to a single spatial orientation of the particle assembly as to a three dimensional spatial orientation.

Experimental physics have given evidence of the existence of bosonic particles of three types indeed. At the nucleon level these particles are the mesons. Pi-mesons (pions for short) occur in two charged types: ( $\pi^+$ ) and ( $\pi^-$ ) and a neutral one ( $\pi^0$ ). At the sub-nucleon level three types occur as well: two charged types:  $W^+$ -boson and  $W^-$ -boson and a neutral one Z-boson.

## 6.2 The potential function of a doublet

Let us now consider two particles at a distance  $d'$  apart and being subject to a force with a potential field as given by (5-3) and let these particles be responsible for the creation of this field. Let us further suppose that the two particles are aligned along the  $x'$ -axis and that the center of the particles is at  $x' = 0$ .

The result is a potential function of the type:

$$V(x) = f(x+d) + f(d-x) \quad \text{with} \quad f(x) = \frac{\exp[-2x]}{x^2} - \frac{\exp[-x]}{x},$$

wherein:  $x = x'/\lambda$  and  $d = d'/\lambda$  (6-8)

Fig. 6 shows  $V(x)$  as a function of  $x$ , with  $d$  as parameter. The function shows a clear minimum. As shown in Appendix 1, the minimum occurs for  $d = 0,84$

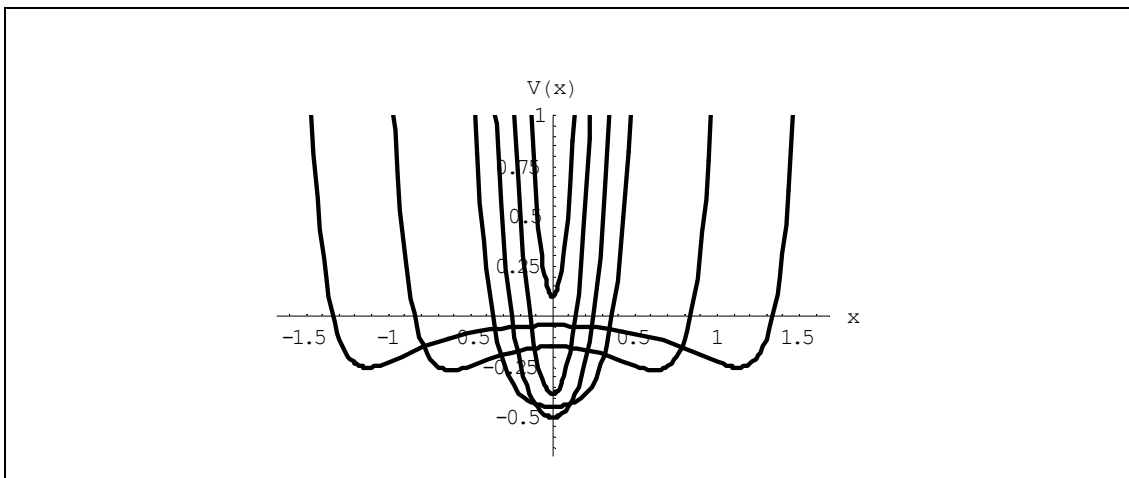

**Fig. 6: Higgs potential as a function of doublet spacing.**

Furthermore the algebraic analysis of Appendix 1 makes clear that the curve of minimum potential can be approximated as:

$$V(x) = k_0 + k_2 x^2 \quad \text{with } k_0 = -\frac{1}{2} \text{ and } k_2 = 2, 62. \quad (6-9)$$

So, a test particle in the center of the doublet will experience a potential as given by (6-9). This potential is similar to the potential energy of a quantum mechanical harmonic oscillator. So, the test particle will behave accordingly. Of course, such a test particle is not physically present. It represents the motion of the vibrating equilibrium of the two particles in the doublet. According to the laws of the harmonic oscillator the energy of the motion can only change in quantum steps. This corresponds with absorption or radiation of virtual particles, i.e. bosons. We may therefore conclude that this model is an elegant interpretation of the origin of such bosons in all kind of doublet structures. The most prominent among these are the nucleon doublet and the meson doublet.

## 7. The magnetic monopole

So far we have identified something as a nuclear charge having similar properties as electric charge. As sub-nucleon particles apparently are carriers of both these charge types, these charge types must simultaneously fit in electromagnetic field theory. So, where is the lacuna in the Maxwellian equations that can be used for the purpose? It was Dirac who has pointed to some asymmetry in Maxwell's Equations. This asymmetry is the absence of magnetic space charge. This absence in the equations is a consequence of the fact that no experimental physical evidence exists for the existence of such charge. Dirac disliked the asymmetry, so he reformulated Maxwell's Equations assuming existence of magnetic space charge. So Dirac's reformulation is:

$$\begin{aligned} \nabla \cdot \mathbf{E} &= \rho_e & \nabla \times \mathbf{E} + \frac{1}{c} \frac{\partial \mathbf{B}}{\partial t} &= -\mathbf{J}_m \\ \nabla \cdot \mathbf{B} &= \rho_m & \nabla \times \mathbf{B} - \frac{1}{c} \frac{\partial \mathbf{E}}{\partial t} &= \mathbf{J}_e. \end{aligned} \quad (7-1a,b,c,d)$$

These equations are dual, i.e. they remain identical under the following transforms:

$$\begin{aligned} \mathbf{E} &\rightarrow \mathbf{B} & \mathbf{B} &\rightarrow -\mathbf{E} \\ \rho_e, \mathbf{J}_e &\rightarrow \rho_m, \mathbf{J}_m & \rho_m, \mathbf{J}_m &\rightarrow -\rho_e, -\mathbf{J}_e. \end{aligned} \quad (7-2a,b,c,d)$$

They are generalizations of Maxwell's Equations due to the presence of  $\rho_m$  and  $\mathbf{J}_m$ . By doing so Dirac had to find an escape route to maintain the concept of the vector potential  $\mathbf{A}$ , which is defined as:

$$\mathbf{B} = \nabla \times \mathbf{A}. \quad (7-3)$$

As the rotation of a vector field is divergence free, the concept of vector potential seems to be in conflict with the presence of magnetic charge. Dirac showed that the adoption of a singularity offers a way out. The singularity has no physical impact, as it only serves to maintain the abstract mathematical vector potential construct in all space apart from the singularity. In order to have a flux from a magnetic pole while not allowing a net flux through a closed surface around the pole (zero divergence) the flux has to be brought in through a singular point on the surface. This does not mean that this mechanism has to exist in physical reality: it has no other purpose than maintaining the mathematical construct of the vector potential. This holds for two ‘worlds’: the normal world wherein the magnetic field is the rotation of the vector potential and the dual world wherein the electric field is the rotation of the dual vector potential.

By maintaining the vector potential concept and by assuming that a magnetic monopole would produce a similar Coulomb like field as an electric monopole does, Dirac proved that charges of electric as well as magnetic monopoles are quantized. The basic reason can be traced back to the asymmetry between two halves of the enclosed surface around the monopole: one with the singularity and the other without. Dirac has never claimed his analysis as a proof for the existence of magnetic monopoles, but he did not exclude the existence either, so that, once found, the discrete characteristics of charged particles have an explanation.

If we do not wish to adopt the existence of elementary discrete particles below the level of quarks, there is no escape from assuming a magnetic field around the quark with two types of magnetic grains: positive and negative. Therefore, unlike as the source of an electric Coulomb field, we cannot identify something like an elementary magnetic charge. The resultant of the magnetic field has a short range, which explains that an isolated magnetic monopole has never been found.

The radial magnetic field  $B(r)$  can be related with the nuclear field derivative  $d\Phi/dr$  by equating the nuclear coupling factor  $g$  with the electromagnetic coupling factor. The electromagnetic coupling factor is a dimensionless quantity related with the elementary electric charge  $q_e$  via:

$$q_e^2 = 2\varepsilon_0 \tilde{h} c g^2. \quad (7-4)$$

In the absence of a magnetic elementary charge, the relationship of  $B(r)$  with  $d\Phi/dr$  has to be established via a relationship with the electric field.

Electromagnetic theory allows relating physical mass with energy of the electromagnetic field. A non-radiating electromagnetic cloud has energy  $W_{em} = m_{em}c^2$  with

$$W_{em} = m_{em}c^2 = \iiint_V \frac{1}{2} \varepsilon_0 \mathbf{E} \cdot \mathbf{E} dV + \iiint_V \frac{1}{2} \mu_0 \mathbf{H} \cdot \mathbf{H} dV = \frac{1}{2} \varepsilon_0 \int_{r_e}^{\infty} E_r^2 4\pi r^2 dr + \frac{1}{2\mu_0} \int_{r_e}^{\infty} B^2(r) 4\pi r^2 dr.$$



(7-5)

The shift of lower integration limit  $r = 0$  to  $r = r_e$  is a consequence of the *renormalization issue*. Coulomb fields ( $E_r \sim 1/r^2$ ) would otherwise result into infinite energy. In structure based theories this problem is avoided by assuming an “empty space” for  $r > r_e$  and a space with some charge distribution for  $r \leq r_e$ . In the formalism of QFT this issue is resolved by making a distinction between electromagnetic mass and material mass and considering the finite difference of the infinite contributions of the two at  $r = 0$  as observable physical mass. As for an electron both rest mass  $m_e$  and electric charge  $q_e$  are observable and measurable quantities, the so-called radius of the electron  $r_e$  can be established.

Although it is our aim to relate  $B(r)$  with  $d\Phi/dr$ , we shall first relate  $E(r)$  with  $d\Phi/dr$  under absence of a magnetic field. We have for the force for an electric particle in an electric field:

$$F_e = q_e E_r. \quad (7-6)$$

Analogously we have for nuclear force in a nucleon field:

$$F_n = g \frac{\partial \Phi}{\partial r}. \quad (7-7)$$

Equating these two forces we get:

$$E_r = \frac{g}{q_e} \frac{\partial \Phi}{\partial r}. \quad (7-8)$$

For the energy  $W_n$  of the nuclear field  $W_n$ , we get from (7-5):

$$W_n = \frac{1}{2} \epsilon_0 \frac{g^2}{q_e^2} \int \left( \frac{\partial \Phi}{\partial r} \right)^2 4\pi r^2 dr, \quad (7-9)$$

so with (7-4):

$$W_n = \frac{\pi}{hc} \int_0^\infty \left( \frac{\partial \Phi}{\partial r} \right)^2 r^2 dr. \quad (7-10)$$

If we now take the position that no electric energy is present in the cloud, but only magnetic energy we have from (7-10) and (7-5):

$$\frac{\pi}{\hbar c} \int_0^{\infty} \left( \frac{\partial \Phi}{\partial r} \right)^2 r^2 dr = \frac{1}{2\mu_0} \int_0^{\infty} B^2(r) 4\pi r^2 dr, \quad (7-11)$$

so:

$$B(r) = \sqrt{\varepsilon_0 \mu_0} \frac{g}{q_e} \frac{d\Phi}{dr} = \frac{g}{c q_e} \frac{d\Phi}{dr}. \quad (7-12)$$

This expression enables us to give a potential field  $\Phi(r)$ , if quantitatively expressed in electron volts, a quantitative interpretation in magnetic quantities. Let us illustrate the significance of this expression. Dirac's monopole theory resulted into the conclusion that:

$$q_e q_m = \frac{n}{2} \hbar c \quad \text{with } n = 1, 2, 3, \dots \quad (7-13)$$

However, the magnetic monopole charge  $q_m$  is in fact the total magnetic flux radiated from a Coulomb-like point-source and is therefore a constant. It is not a constant if the magnetic field is not Coulomb-like, like in our case. Without further proof we memorize that (7-13) in fact has to be reformulated as:

$$\frac{q_e}{\hbar c} \Phi_{\pi}[r] = 2n\pi \quad \text{with } n = 1, 2, 3, \dots \quad \text{and} \quad \Phi_{\pi}[r] = 4\pi r^2 B(r). \quad (7-14)$$

(Note: please don't confuse the flux  $\Phi_{\pi}[r]$  with the field  $\Phi(r)$ ).

From (7-14) and (7-12) it follows that:

$$\frac{2g}{\hbar c} r^2 \frac{d\Phi}{dr} = n \quad \text{wherein } n \text{ is a natural number.} \quad (7-15)$$

As the magnetic pole is granular, we may try to estimate its size. From (5-4) it follows that:

$$\frac{d\Phi}{dr} = \lambda \Phi_0 \frac{d\eta}{d\rho} \quad \text{with} \quad \frac{d\eta}{d\rho} = 4\pi\rho \exp[-\rho] \left(1 + \frac{1}{\rho}\right) \left(1 - \frac{2 \exp[-\rho]}{\rho}\right) \quad (7-16)$$

so we may write for (7-15):

$$\frac{2g\Phi_0 d\eta}{\hbar c \lambda d\rho} = n. \quad (7-14)$$

If we would know figures for  $\lambda$  and  $\Phi_0$  we would be able to calculate the radius of the magnetic cloud beyond which no grain can be found. In section 9  $\lambda$  and  $\Phi_0$  will be related with the W- and Z-bosons. These bosons have energies far beyond the mesons. That is the reason why the values for the bosonic  $\lambda$  and  $\Phi_0$  values will end up in such a small quantitative figure for the magnetic cloud radius that magnetic monopole grains are not detectable.

## 8. Relationship with canonic theory

In this section we wish to compare the view as outlined above with the canonic view. First of all it has to be noted that so far our view is *Abelian*, as no a-priori field quantization is taken into account. Instead field quantization is a result from the analysis rather than a given fact. This is no conflict in views, because from this point on the *non-Abelian* instruments of field quantization can be taken up to proceed further analysis. This will enable to study particle interactions similarly as in canonic theory.

Theoretical predictions based on the hypothesized Higgs-field are so close to verifications by experiments that its existence has to be regarded to be beyond any doubt. As long as the Maxwellian laws are maintained unchanged, some artificial mechanism is required to explain the origin of the field. This mechanism might be not beyond doubt, in particular as it suggests the existence of a fancy particle subject to an additional wave equation apart from Dirac's Equation and the Maxwellian equations. Above we have shown that adaptation of Maxwellian laws by hypothesizing magnetic space charge gives an adequate explanation for the origin of the Higgs field. No fancy extra particle has to be neither hypothesized, nor any other equations apart from the Maxwellian ones and Dirac's Equation.

Where canonic theory heavily relies on the elaboration of one and only Lagrangian density we have applied the Lagrangian density concept so far exclusively for the description of the energetic field, i.e. only for bosonic aspects, while canonic theory uses the Lagrangian density concept for the derivation of the probabilistic quantum mechanical wave equation as well. By doing so a composite Lagrangian density can be composed, allowing applying Feynman's methodology for field and particle interactions. As long as the quantum mechanical wave equation is Dirac's wave equation there is no conflict with the view presented in this document as Dirac's Equation can be derived from a well-defined Lagrangian density. There is no problem whatsoever to modify fig.1 accordingly. See fig. 7. In this scheme the first Lagrangian (the bosonic one) is said to perturb the second Lagrangian (the fermionic one). This scheme allows taking field quantization into account by redefining wave functions as operators on itself with a proper definition of the operation action (i.e. by changing the commutation of position and momentum by non-commutation under restriction of Heisenberg's uncertainty relationship).

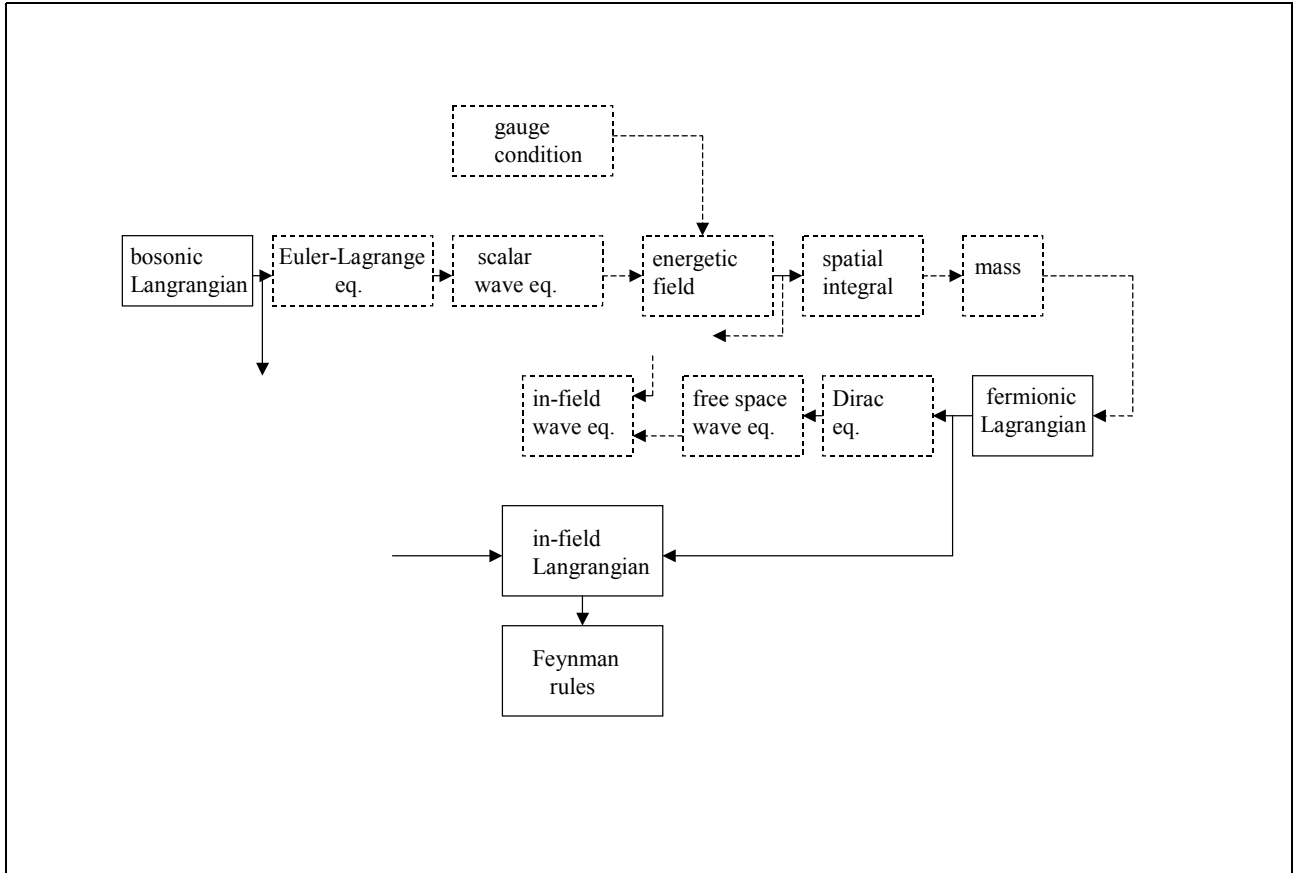

**Fig. 7: Fields, waves and Lagrangians.**

So, if it are not these considerations that make the difference, what else? Let us first consider the case of QED (Quantum Electro Dynamics). Aa single Lagrangian density, usually written as:

$$\mathcal{L} = \mathcal{L}_b + \mathcal{L}_f \quad (8-1)$$

can comprise this.  $\mathcal{L}_b$  is the Lagrangian density of a (bosonic) Maxwellian field and  $\mathcal{L}_f$  is the Lagrangian density of the (fermionic) Dirac field. Due to the presence of the bosonic field the fermionic wave equation is subject to Yang Mills Principle, which expresses that the global phase invariance of the free space fermionic wave function is changed into local phase invariance. This is implemented by changing common derivatives in the fermionic Lagrangian density by covariant derivatives.

Let us now apply this view to the nuclear field. In the magnetic monopole view the bosonic Maxwellian field, and therefore  $\mathcal{L}_b$ , is modified by the introduction of magnetic space charge while the fermionic free space wave equation is made subject to Yang Mills Principle by making  $\mathcal{L}_f$  covariant. As in the case of QED, each particle has bosonic properties as well as fermionic properties. Fig. 7a and 7b shows the correspondence between the QED Lagrangian and the *WFD Lagrangian* (WFD = Weak Force Dynamics) . In canonic scientific notation the QED Lagrangian reads as:

$$\mathcal{L} = -\frac{1}{16\pi}F^{\mu\nu}F_{\mu\nu} + \bar{\Psi}(j\gamma^\mu\partial_\mu - q_e\gamma^\mu A_\mu - m)\Psi \quad (8-2)$$

Note: Greek indices are used for time-space coordinates. The coordinate  $\mu, \nu = 0$  is used for the temporal coordinate. The bar in  $\bar{\Psi}$  stands for the complex conjugate of the Dirac spinor and  $\gamma^\mu$  and  $\gamma_\mu$  are the Dirac Pauli matrices. Upper and lower indices are used according to conventions in covariant expressions. This Lagrangian is the starting point for particle interaction processes according to Feynman's methodology.

In line with the QED Lagrangian we may now formulate the WFD Lagrangian as:

$$\mathcal{L} = -\frac{1}{16\pi}F_{(m)\mu\nu}F_{(m)\mu\nu} - J_{(m)}^\mu A_{(m)\mu} + \bar{\Psi}(j\gamma^\mu\partial_\mu - g\gamma^\mu A_\mu - m)\Psi \quad (8-3)$$

The fermionic part is the same as in the QED Lagrangian, but the bosonic part is different. This bosonic part is different from the one in the QED Lagrangian in two aspects. The electromagnetic tensor  $F_{(m)\mu\nu}$  is the magnetic equivalent (i.e. the dual) of  $F_{\mu\nu}$ . Moreover the bosonic part is not source-less, but contains a source term  $J_{(m)}^\mu A_{(m)\mu}$ , wherein  $J_{(m)\mu}$  is the magnetic current density as a consequence of the non-zero spatial span of the magnetic space charge.

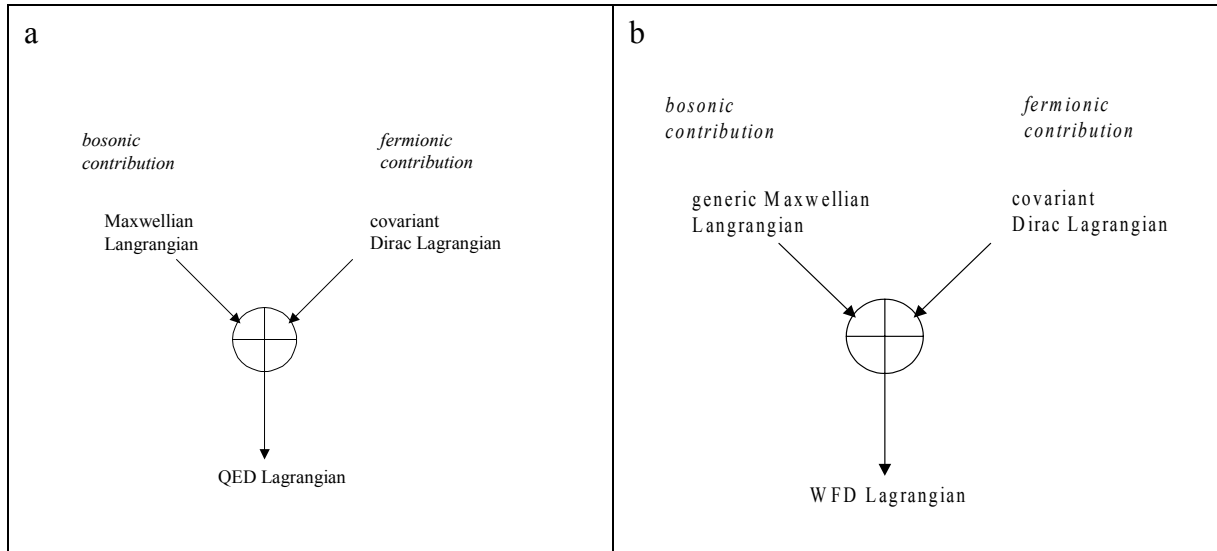

**Fig. 8: QED Lagrangian vs. WFD Lagrangian.**

As the motion of the effective mass reduces to a linear one, the four-element Dirac spinor reduces to a two element one:  $\Psi(\Psi_1, \Psi_2)$ . As we wish to proceed our analysis on the basis of wave equations we may apply the Euler Lagrange equations on (8-3). Equivalently, but more simply, we

may derive the wave equations from the free space mechanical motion equations, application of the minimum substitution principle and the basic quantum mechanical transform of momenta into operators on wave functions. The result of, as invoked from (2-18), is:

$$(\hat{p}_0 - gA_{(m)0})\Psi_2 + (\hat{p}_x - gA_{(m)1})\Psi_1 - jcm\Psi_2 = 0$$

$$(\hat{p}_0 - gA_{(m)0})\Psi_1 - (\hat{p}_x - gA_{(m)1})\Psi_2 + jcm\Psi_1 = 0$$

wherein:  $\hat{p}_i = \frac{\tilde{h}}{j} \frac{\partial}{\partial x_i}$ ,  $x_1 = x$  and  $x_0 = jct$ . (8-4)

Modeling the field as in (4-2), i.e. as a scalar field, we have  $A_{(m)1} = 0$ , so that from (8-4):

$$(\hat{p}_0 - gA_{(m)0})\Psi_2 + \hat{p}_x\Psi_1 - jcm\Psi_2 = 0$$

$$(\hat{p}_0 - gA_{(m)0})\Psi_1 - \hat{p}_x\Psi_2 + jcm\Psi_1 = 0. \quad (8-5)$$

Under suitable conditions this set of equations may have stationary solutions. Such solutions can be found from (8-5) by imposing time independency on  $\Psi(\Psi_1, \Psi_2)$ , which modifies the set (8-5) into:

$$\hat{p}_x\Psi_1 - (jcm + gA_{(m)0})\Psi_2 = 0 \quad \text{and} \quad \hat{p}_x\Psi_2 - (jcm - gA_{(m)0})\Psi_1 = 0. \quad (8-6)$$

To simplify the problem even further spin can be ignored. In the Side Note, annexed to this paper, it is derived that the spin-less limit of Dirac's Equation is:

$$j\tilde{h}\frac{\partial\Psi}{\partial t} + \frac{\tilde{h}^2}{2m_0}\frac{\partial^2\Psi}{\partial x^2} - \{c^2 + V(x)\}\Psi = 0, \quad (8-7)$$

which reduces in the non-relativistic limit to:

$$j\tilde{h}\frac{\partial\Psi}{\partial t} + \frac{\tilde{h}^2}{2m_0}\frac{\partial^2\Psi}{\partial x^2} - V(x)\Psi = 0 \quad (8-8)$$

The time-independent form is the wave equation of a harmonic oscillator. That means that we have a straight path from the full mathematical format to a mathematical expression of a comprehensible physical system. This format will allow us to arrive at some novel insights to be discussed in next section.

## 9. Further evidence: the leptonic algorithm

What kind of experimental evidence can be brought forward to support the theory as presented above? Well, first of all we could invoke Occam's razor. It states that if two theories result in identical outcomes, the more simple of the two is the correct one. Well, inclusion of magnetic space charge in Maxwell's Equations is simpler than the adoption of an additional phantom particle. The disclaimer of course is that the subject is not dealt with in sufficient detail to claim that the experimental results following from the novel view are identical with those of the canonic theory indeed.

Secondly, we could bring forward a negative outcome of a proof: the Higgs particle has not been found so far. The disclaimer is that possibly the energies of present colliders have not been high enough to disclose its existence. Even if the LHC will not be able to disclose it, the search will probably be continued.

Thirdly, quantization of charge and consequently quantization of fields is an outcome of the theory instead of an axiom like it is in canonic theory. Also here we have a disclaimer: the magnetic monopole grain is too small to be verifiable.

If there would be any new predictive value in the theory while maintaining experimental results of the canonic theory, the theory would be superior if the predictive value can be experimentally verified. Is there some?

Let us consider the doublet potential of fig. 6 once more. Suppose that a quantum leap brings the doublet in a state of higher energy. As will be obvious from the graph, the higher state corresponds with a stronger curvature of the potential function, so a next quantum leap will correspond with an even stronger curvature. This implies that the quantum steps in the doublet's potential function will not show a constant spacing, but a progressive spacing instead. Let us try to give an estimating calculation of this spacing.

From the parabolic approximation of the potential function we have (see appendix and 6-9):

$$\frac{\Phi(r)}{\Phi_0} = k_0 + k_2(r\lambda)^2. \quad (9-1)$$

The second term of the right hand part can be identified as the potential energy of an harmonically oscillating unknown effective doublet mass  $m_p$ . Relating stiffness and frequency as usual we may equate:

$$\frac{1}{2}m_p\omega^2 = \Phi_0k_2\lambda^2. \quad (9-2)$$

The energetic state of the harmonic oscillator is subject to stepwise changes by the amount of  $\tilde{h}\omega$ . Let us identify these changes as bosonic masses  $m_W$ . So:

$$m_W c^2 = \tilde{h}\omega. \quad (9-3)$$

For convenience we wish to express mass in terms of energy, so we define:

$$m'_W = m_W c^2 \quad \text{and} \quad m'_p \quad \text{accordingly.} \quad (9-4)$$

From (9-1) - (9-4) we get:

$$\Phi_0 = \frac{m'_p m'^2_W}{2(\tilde{h}c)^2 k_2 \lambda^2}. \quad (9-5)$$

If we assume near-light velocity of the virtual interaction bosons we may go a step further. In that case we may state that:

$$2d_0 \approx c\Delta t, \quad (9-6)$$

wherein  $d_0$  is the half-spacing in minimum energy condition between the quark constituents of the doublet. Applying Heisenberg's relationship  $E\Delta t \geq \tilde{h}$  for virtual particles getting energy  $E$  within the uncertainty interval  $\Delta t$  we get under consideration of (9-3):

$$m'_W = \alpha \frac{\tilde{h}c}{2d_0}, \quad (9-7)$$

wherein a factor  $\alpha$  with order of magnitude of 1 is inserted to correct for boson velocity lower than the light velocity and for the inexactness of the Heisenberg relationship.

Substitution of this value into (9-5) gives:

$$\Phi_0 = \frac{\alpha^2 m'_p}{8(\lambda d_0)^2 k_2}. \quad (9-9)$$

From (9-1) we note that potential function  $\Phi(0)$  for generic spacing is written as:

$$\Phi(0) = \Phi_0 \{k_0(d') + k_2(d')\}, \quad (9-10)$$



wherein  $d' = d\lambda$  and where, as shown in appendix B,

$$k_0 = 2\left(\frac{\exp[-2d']}{d'^2} - \frac{\exp[-d']}{d'}\right) \quad (9-11)$$

$$\text{and } k_2 = \frac{\exp[-2d']}{d'^4}(6 + 4d'^2 + 8d') - \frac{\exp[-d']}{d'^2}\left(2 + d' + \frac{2}{d'}\right). \quad (9-12)$$

Minimum potential occurs for  $x = 0$  at  $d_0' = 0,84$ , so that  $k_0 = -\frac{1}{2}$  and  $k_2(d_0') = 2,62$ .

Let us now shift the potential by an amount of  $\frac{3}{2}\tilde{h}\omega = \frac{3}{2}m'_W$  and calculate the new curvature  $k_2(d_a')$ .

This gives the following condition:

$$\Phi_0 k_0(d_0') + \frac{3}{2}m'_W = \Phi_0 k_0(d_a') \quad (9-13)$$

Defining a parameter  $p$  as:

$$p = \frac{m'_W}{\alpha^2 m'_p}, \quad (9-15)$$

we get for (9-13) under consideration of (9-9):

$$k_0(d_0') + 12pd_0'^2 k_2(d_0') = k_0(d_a'). \quad (9-14)$$

If the parameter  $p$  would be known, the spacing  $d_a'$  can be calculated from  $d_0'$ . Subsequently the calculation can be recursively repeated to calculate an even higher-energy spacing. Similarly so, the hierarchical values for the curvature  $k_2$  can be established from (9-10).

In the case of the doublet archetype, i.e. the meson, all energy radiates in a boson. Therefore the vibrating mass  $m_p$  and the radiative mass  $m_W$  are closely related. Their semantics are different because  $m_p$  is considered as non-virtual and  $m_W$  as virtual. They may be at different scales of magnitude. This is due to the fact that radiative mass  $m_W$  represents binding energy, only existing within the time interval of the Heisenberg uncertainty relationship. So, analysis of the harmonic oscillator has either to be made in the domain of the vibrating mass or in the domain of the radiative mass. As they show up in a ratio it does not matter which domain is chosen. We may then

simply state that  $m_W$  and  $m_p$  are of the same of order of magnitude, which makes the parameter  $p$ , under consideration of the meaning of  $\alpha$  :, of the order of magnitude 1.

Calculation of the first level for the hierarchical spacing above the spacing of minimum energy with  $p = 0,35$  leads to  $d_a' = 0,30$  and a ratio  $k_2(d_a')/k_2(d_0')$  of 200. Interpretation of this result in terms of (9-2) implies a 200x increase of effective mass  $m_p$  for constant  $\omega$ . So, if the mass at minimum energy is pure electromagnetic mass, the new electromagnetic mass is 200 times larger. If this condensates, we would have a particle with 200 times the mass of the particle in ground state. This ratio corresponds with the mass ratio of an electron and a muon. A different value for  $p$  would give a different ratio, so the result is somewhat 'manipulated'. Nevertheless the value  $p = 0,35$  is reasonable, as will be further explained below.

In this calculation it is assumed that this first leap spans the level of minimum energy with the first escape level at a value of the equivalence of  $3/2 \tilde{h}\omega$ . What about the second leap? Let us inspect the behavior of a one-dimensional quantum mechanical oscillator in terms of the Schrödinger equation, so as:

$$-\frac{\tilde{h}^2}{2m_p} \frac{d^2 \Psi}{dr^2} + V(r)\Psi = E\Psi, \quad (9-16)$$

wherein we have, as discussed above:  $V(r) = \Phi_0(k_0 + k_2 r^2 \lambda^2)$ .

This equation has solutions for discrete values of  $(E - k_0 \Phi_0)$  only, i.e. for

$$E_n = k_0 \Phi_0 + \left(n + \frac{1}{2}\right) \tilde{h}\omega = \Phi_0 \left\{ k_0 + \left(n + \frac{1}{2}\right) \frac{m'_W}{\Phi_0} \right\}. \quad (9-17)$$

From (9-9) and (9-14) it follows that:

$$\frac{m'_W}{\Phi_0} = 8p d_0^2 k_2 \quad (9-18)$$

so

$$E_n = \Phi_0 \left\{ k_0 + \left(n + \frac{1}{2}\right) 8p d_0^2 k_2 \right\}, \quad (9-19)$$

and therefore:

$$E_0 = \Phi_0 \left\{ k_0(d_0') + \frac{1}{2} 8p d_0'^2 k_2(d_0') \right\} \quad \text{and} \quad E_1 = \Phi_0 \left\{ k_0(d_0') + \frac{3}{2} 8p d_0'^2 k_2(d_0') \right\}. \quad (9-20)$$

At the value  $E_1$  the oscillator may jump in the ground state of a different mode as we may equate:

$$k_0(d_0') + \frac{3}{2} 8p d_0'^2 k_2(d_0') = k_0(d_1') + \frac{1}{2} 8p d_1'^2 k_2(d_1'). \quad (9-21)$$

So, if  $p$  would be known, we may calculate from (9-20) the shift from  $d_0'$  to  $d_1'$ , which establishes a narrower doublet distance for harmonic oscillation in ground mode. In fig. 9 the process is illustrated. It clarifies the meaning of the distance parameters  $d_0'$ ,  $d_a'$  and  $d_1'$ . The parameters  $d_0'$  and  $d_1'$  determine the “bottom levels” of the potential curves, while the parameters  $d_a'$  and  $d_b'$  determine the “take-over levels” of the modes. These levels can also be seen as “escape levels” for radiation/absorption of bosons. The  $d_a'$ -level is the level for the first mode (above the ground level) of the harmonic oscillation. It is at  $3/2\tilde{h}\omega$  spacing from the bottom level of the lower curve. The  $d_b'$ -level is the level of the second mode of the harmonic oscillation. It is at  $5/2\tilde{h}\omega$  spacing from the bottom level of the middle curve. The mechanism of take-over is further illustrated by the right hand part of the figure. It shows a construction of two bowls, each representing a potential curve. The vibration can be seen as a ball with some rotation energy, which can smoothly move from the lower bowl into the upper bowl. The reason why the left graph does not show a similar smooth take over is due to the mass leap to maintain a constant value for  $m_w c^2 = \tilde{h}\omega$  (see 9-2).

How to interpret these results? Electromagnetic particles are subject to electric fields and magnetic fields. In classic theory magnetic fields are absent in motionless conditions. In the theory as presented above magnetic fields are present at short range in static conditions. So, a stationary doublet of electromagnetic particles may exist. In minimum energy condition these two particles are inseparable. If separated and at large distance apart they are not subject to any interaction. One constituent of the doublet after separation carries the electric field: it is the electron and its mass is determined by the electric field. The other constituent is the (electron) neutrino and carries the magnetic field. As this magnetic field is of short-range, this field does not capture a substantial amount of energy. Therefore the neutrino mass is virtually zero.

The electromagnetic doublet may be subject to external forces, which may bring the doublet in higher states of energy. These levels of energy are spaced in quantum steps. The first hierarchical level is known as a doublet of quark and antiquark, known as meson. In separated condition one of the constituents is the packet of electric energy (muon) and the other is the (muon) neutrino. The electric packet decays into smaller electric packets (electrons). The separation of the muon is the annihilation process of the quark and antiquark, which is facilitated by the virtual quantized format of the electromagnetic energy (boson).

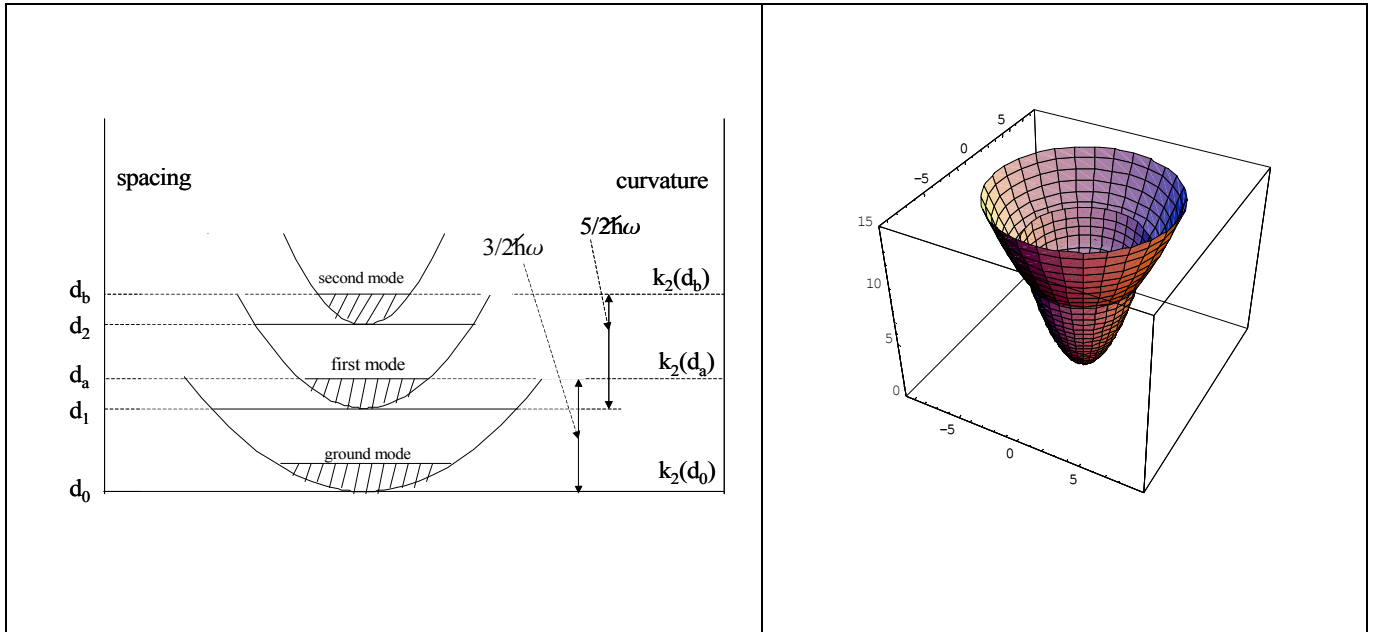

**Fig. 9: Quantum leaps of the Higgs field.**

Above we have adopted a value  $p = 0,35$  to explain the mass ratio of 200 for electrons and muons. A computation of the new doublet spacing for the second mode for  $p = 0,35$  yields a figure of  $d_1' = 0,65$ . This is different from a doublet spacing of 0,50 which would result in ratio of 18 for tauons and muons. Unfortunately the  $k_2$  ratio is rather sensitive for the parameter  $p$ . In fact the spacing  $d_1' = 0,65$  appears to correspond with a ratio of 10,6 only. What is the reason of this discrepancy? The explanation has to do with the simple first order modeling of the potential curves by a second order function of the coordinate. This enabled us to apply the theory of a linear harmonic quantum mechanical oscillator. By expanding the potential curve to a higher order one might expect that the characteristics of the quantum leaps remain discrete, but will be subject to other spacing rules. So, it remains a challenge to refine the computation in an attempt to bring the theoretical closer to the values as found experimentally. It will require modeling the oscillator as an anharmonic quantum oscillator [21,22]. The table of fig. 10 shows our computational results for the simple harmonic model. The results are obtained, as derived above, from the following set of equations:

$$k_0(d_0') + 12pd_0'^2k_2(d_0') = k_0(d_a')$$

$$k_0(d_0') + 12pd_0'^2k_2(d_0') = k_0(d_1') + 4pd_1'^2k_2(d_1')$$

$$k_0(d_1') + 20pd_1'^2k_2(d_1') = k_0(d_b')$$

with (see appendix B):  $k_0 = 2\left(\frac{\exp[-2d']}{d'^2} - \frac{\exp[-d']}{d'}\right)$

$$k_2 = \frac{\exp[-2d']}{d'^4}(6 + 4d'^2 + 8d') - \frac{\exp[-d']}{d'^2}\left(2 + d' + \frac{2}{d'}\right). \quad (9-22)$$

These results are fair enough to believe that our theory explains the differences and correspondences between leptons indeed, but is, unfortunately inadequate to predict the mass of the leptons beyond the tauon with some accuracy.

Nevertheless we wish to conclude that the qualitative explanation as given above reveals the existence of a leptonic algorithm. It also makes the very nature of the neutrino less mysterious.

spacings				
$d_0'$	$d_1'$	$d_a'$	$d_2'$	$d_b'$
0,84	0,65 (0,5)	0,30		0,17

$k_2$ -ratios		
$k_2(d_a')/k_2(d_0')$	$k_2(d_a')/k_2(d_0')$	$k_2(d_b')/k_2(d_1')$
1	200	10,6 (18)

lepton masses		
0,5 MeV/c <sup>2</sup>	100 MeV/c <sup>2</sup>	1800 MeV/c <sup>2</sup>

**Fig. 10: Computational results for  $p = 0,35$ .**

### 9.1 Anharmonic correction

We may obtain a more accurate result if the potential function as shown by (9-2) is expanded by an additional term, i.e. as:

$$\frac{\Phi(r)}{\Phi_0} = k_0 + k_2(r\lambda)^2 + k_4(r\lambda)^4. \quad (9-23)$$

Like  $k_2$ , the coefficient  $k_4$  is a function of the normalized doublet spacing  $d'$ . This function can be found at the end of appendix B. The time independent part of Schrödinger's Equation now reads as:

$$-\frac{\tilde{h}^2}{2m_p} \frac{d^2 \Psi}{dr^2} + \Phi_0(k_0 + k_2 r^2 \lambda^2 + k_4 r^4 \lambda^4) \Psi = E \Psi. \quad (9-24)$$

Let us rescale the variable  $r$  as  $y = ar$  (9-25)

so (9-24) can be written as:

$$-\frac{\tilde{h}^2}{4m_p k_2 \lambda^2 \Phi_0} \frac{d^2 \Psi}{dy^2} + \left( \frac{y^2}{2} + \frac{k_4 \lambda^2 y^4}{2k_2 a^2} \right) \Psi = \frac{a^2}{2\Phi_0 k_2 \lambda^2} (E - k_0 \Phi_0) \Psi. \quad (9-26)$$

Let us choose the scale factor  $a$  such that the coefficient of the first right hand term equals 1/2, i.e.:

$$\frac{\tilde{h}^2}{4m_p k_2 \lambda^2 \Phi_0} a^4 = \frac{1}{2}, \quad (9-27)$$

so, under definition (9-2):  $a^2 = \frac{m_p \omega}{\tilde{h}}$ . (9-28)

Equation (9-26) can now be written as:

$$-\frac{1}{2} \frac{d^2 \Psi}{dy^2} + \frac{y^2}{2} + \beta y^4 \Psi = \frac{m_p \omega}{\tilde{h}} \frac{1}{m_p \omega^2} (E - k_0 \Phi_0) = \frac{1}{\tilde{h} \omega} (E - k_0 \Phi_0)$$

wherein  $\beta = \frac{k_4 \lambda^2}{2k_2} \frac{\tilde{h}}{m_p \omega}$ . (9-29a,b)

As proven in [22] this system is subject to the following relationships:

$$\frac{1}{\tilde{h} \omega} (E_n - k_0 \Phi_0) = \mathcal{E}_n = \mathcal{E}_0 + n\Omega + \frac{3\beta}{2\Omega^2} n(n-1). \quad (9-30)$$

with 
$$\epsilon_0 = \frac{3}{8}\Omega + \frac{1}{8\Omega},$$

wherein  $\Omega$  follows from 
$$\Omega^3 - \Omega - 6\beta = 0. \quad (9-31)$$

(Note that for  $\beta = 0$  the system reduces to a harmonic oscillator.)

Equation (9-31) can be simplified as follows: Let

$$m'_W = \tilde{h}\omega\Omega \quad (9-32) \text{ so under consideration of (9-7):}$$

$$\frac{\tilde{h}}{m_p\omega} = \frac{\tilde{h}^2\Omega}{m_p\tilde{h}\omega\Omega} = \left(\frac{2d_0}{\alpha c}\right)^2 \frac{m'_W\Omega}{m_p} = \frac{4d_0^2\Omega m'_W}{\alpha^2 m'_p} = 4d_0^2 p\Omega. \quad (9-33)$$

This equation enables to write (9-29b) as:

$$\beta = 2\frac{k_4}{k_2}d_0^2 p\Omega. \quad (9-34)$$

This result simplifies the cubic equation (9-31) into a quadratic one, because by inserting (9-34) into (9-31) we find:

$$\Omega^2 = \gamma \quad \text{wherein} \quad \gamma = 1 + 12\frac{k_4}{k_2}d_0^2 p. \quad (9-35)$$

Let us now reformulate the leptonic algorithm set. What is the first escape level? From (9-28) it follows that it is a shift from the bottom by an amount of:

$$\tilde{h}\omega(\epsilon_0 + \Omega) = m'_W\left(\frac{11}{8} + \frac{1}{8\Omega^2}\right). \quad (9-36)$$

Clearly this shift is different from the shift of  $3\tilde{h}\omega/2$  as in the case of the harmonic oscillator. Consequently (9-14) has to be reformulated as:

$$k_0(d_0') + 12p_c d_0'^2 k_2(d_0')\Omega = k_0(d_a'),$$

wherein 
$$p_c = 2p\left(\frac{11}{8} + \frac{1}{8\Omega^2}\right)/3. \quad (9-37)$$

What about the take over level? From (9-28) it follows that the ground level is defined by:

$$\tilde{h}\omega\mathcal{E}_0 = m'_W \left[ \frac{3}{8} + \frac{1}{8\Omega^2} \right]. \quad (9-38)$$

Consequently (9-21) has to be reformulated as:

$$k_0(d_0') + 12p_c d_0'^2 k_2(d_0') \Omega = k_0(d_1') + 4p_{cc} \Omega d_0'^2 k_2(d_1') \quad \text{with } p_{cc} = 2p \left[ \frac{3}{8} + \frac{1}{8\Omega^2} \right]. \quad (9-39)$$

Similarly as before, the equations (9-37) and (9-39) will enable to compute escape levels and take over levels. In the case of the harmonic oscillators it has been supposed that mass lepton ratios have to do with the  $k_2$ -ratios in order to maintain a constant value for the boson mass  $m'_W$ . From (9-32) we learn that this is no longer justified in the case of the anharmonic oscillator, as we have to state now:

$$\omega\Omega = \text{constant} \quad \text{so} \quad \Omega \sqrt{\frac{k_2}{m}} = \text{constant} \quad (9-40)$$

and therefore:

$$\frac{m_{mu}}{m_{el}} = \frac{k_2(d'_a)\gamma(d'_a)}{k_2(d'_0)\gamma(d'_0)} \quad \text{and} \quad \frac{m_{tau}}{m_{mu}} = \frac{k_2(d'_b)\gamma(d'_b)}{k_2(d'_a)\gamma(d'_a)}. \quad (9-41)$$

spacing					
$d_0'$	$d_1'$	$d_a'$	$d_2'$	$d_b'$	$d_c'$
0,84	0,505	0,16	0,48	0,08	0,05

mass ratios			
1	200	16,16 (18)	6,04

lepton masses			
0,5 MeV/c <sup>2</sup>	100 MeV/c <sup>2</sup>	1800 MeV/c <sup>2</sup>	12,2 GeV/c <sup>2</sup>

**Fig. 11: Computational results for  $p = 0,50$  after anharmonic correction.**



The result for the  $m_{\tau}/m_{\mu}$  is now close enough to the experimental value to give an estimation for the mass of the next lepton to be found. To do so the equation set (9-22) has to be extended with an additional level  $((7/2)\tilde{h}\omega)$ , i.e. as:

$$\begin{aligned}
k_0(d_0') + 12p_c d_0'^2 \Omega k_2(d_0') &= k_0(d_a') \\
k_0(d_0') + 12p_c d_0'^2 \Omega k_2(d_0') &= k_0(d_1') + 4p_{cc} \Omega d_1'^2 k_2(d_1') \\
k_0(d_1') + 20p_c d_1'^2 \Omega k_2(d_1') &= k_0(d_b') \\
k_0(d_1') + 20p_c d_1'^2 \Omega k_2(d_1') &= k_0(d_2') + 4p_{dd} \Omega d_2'^2 k_2(d_2') \\
k_0(d_2') + 28p_d d_2'^2 \Omega k_2(d_2') &= k_0(d_c') \\
p_{dd} = 2p \left[ \frac{3}{8} + \frac{1}{8\Omega^2} + \frac{3\beta}{\Omega^3} \right] \text{ and } p_d &= 2p \left[ \frac{19}{8} + \frac{1}{8\Omega^2} + \frac{3\beta}{\Omega^3} \right] / 5
\end{aligned} \tag{9-42}$$

The results are shown in fig.11. This gives a prediction of about 12,2 GeV/c<sup>2</sup> for the next lepton to be found.

Note that the algorithmic fit requires a value of  $p = 0,5$ . Let us reconsider this parameter. It has been defined by (9-15). If we take the equity sign for the Heisenberg relationship and if the boson velocity equals the vacuum light velocity, we would have  $\alpha = 1$ , so that under such conditions:

$$p = \frac{m'_W}{m'_p} = 0,5. \tag{9-43}$$

Knowing from experimental evidence that all vibrating mass  $m'_p$  of a quark doublet eventually turns into bosonic mass  $m'_W$ , why is this ratio, albeit under the constraints just mentioned, not 1 but 0,5 instead? There is some explanation. It is to do with the fact that we have modeled the oscillating system as a one-body system with mass  $m'_p$ , while actually it is a two-body system. This is illustrated by fig.12. As is known from this modeling [23], the actual total two-body mass is twice as large as the one-body mass. So  $m'_W$  represents only half of the total mass, which is actually eventually converted.

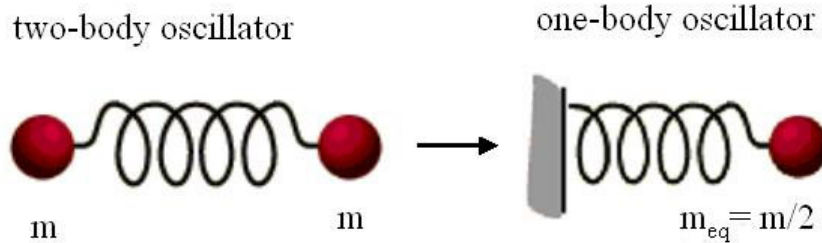

**Fig. 12: modeling of a two-body system by a one-body system.**

## 10. Conclusions

In the views as outlined in this paper we have taken the existence of the Higgs field as an undeniable starting point. We have however challenged the origin of the field. Rather than ascribing the origin of it to a yet undiscovered phantom particle, we have ascribed the origin directly to electromagnetic energy, in particular as magnetic charge next to electric charge of elementary point-like particles. To this end we have used two instruments. The first one is the transform of the Higgs field from a functional description into a spatial description, without changing the basic properties. This is, as far as the author knows, not done before. The other instrument is as old as 1931. It is the concept of the magnetic monopole, as introduced by Dirac. The two instruments fit well together. In the paper it is shown that the particular field of the monopole as imposed by the Higgs field has prevented its experimental verification. As is well known from the work of Dirac, one of the consequences of the magnetic monopole is the discretization of electric charge. The result of all of this is that electromagnetic energy on its own is the source of all mass. It implies that the search after the Higgs particle will remain fruitless. No other equations, apart from Maxwell's Equations and Dirac's Equation are required to express the fundamentals of quantum waves and quantum fields, which makes the disputed Klein Gordon Equation obsolete. We have also shown that the theory as developed along these lines does not only make the neutrino less mysterious, but it also reveals an algorithm to explain the ratios between the lepton masses. In that sense the theory shows a predictive element, while grosso modo, as shown, no derogation is done to the results and instruments of canonic theory.

## References

- [1] P. Higgs . "Broken Symmetries and the Masses of Gauge Bosons", Physical Review Letters 13:, (1964) p. 508
- [2] S.L. Glashow, "Partial symmetries of weak interactions", Nucl. Phys. 22 (1961) 579-588

- [3] J. Goldstone, A. Salam and S. Weinberg, “Broken Symmetries”, Phys. Rev. 127 (1962) 965-
- [5] G. ‘tHooft, M. J.G. Veltman, “Regularization and Renormalization of Gauge Fields”, Nucl. Phys. B44 (1972) 189-213.
- [6] H. Lyre: “Does the Higgs Mechanism exist?”, International Studies in the Philosophy of Science, June 2008
- [7] P. A. M. Dirac, “Quantised Singularities in the Electromagnetic Field”, Proc. R. Soc. A 133 (1931) 60.
- [8] A. Proca, “Sur la theorie ondulatoire des electrons positifs et negatifs”, J. Phys. Radium 7, 347 (1936); Sur la theorie du positon, C. R. Acad. Sci. Paris 202, 1366 (1936).
- [9] H. Yukawa, “On the interaction of elementary particles I”, Proc. Phys.-Math. Soc. Japan 17, 48 (1935).
- [10] C.N. Yang, R. Mills, “Conservation of isotopic Spin and isotopic Gauge Invariance”, Phys. Rev. 96 (1954) 191-195.
- [11] P. Dirac, “The Quantum Theory of the Electron”, Proc.R.Soc.Lond. A117 610-624; ibid A118 351-361 (1928)
- [12] L.M. Brown, Feynman’s Thesis, a new Approach to Quantum Theory, ISBN 978-981-256-366-8, World Scientific Publishing Company, 2005
- [13] E. Comay, “Further difficulties with the Klein Gordon Equation”, Apeiron, Vol.12, No.1, Jan. 2005
- [14] E. Comay, Apeiron, Vol.11, No. 3, p.1 (2004).
- [15] E. Comay, Apeiron, , Vol.14, No. 1, p. 1 (2007).
- [16] E. Comay, Apeiron, Vol. 14, No.2, p. 50 (2007).
- [17] F. Wilczek, Nature 445, 156-157, Jan. 2007
- [18] Ishii, Aoki and T. Hatsuda, Phys. Review Letter 99, 022001 (2007)
- [19] F. Scheck: “Successes and Mysteries of the Standard Model in Particle Physics”, San Jose lectures, summer 2003, p.35, <http://wwthep.physik.uni-mainz.de/~scheck>
- [20] M. Holler: “Die Suche nach dem Higgs-Boson”, [http://web.physik.rwth-aachen.de/~mnich/SeminarWS0203/V9a\\_MatthiasHoeller.pdf](http://web.physik.rwth-aachen.de/~mnich/SeminarWS0203/V9a_MatthiasHoeller.pdf)
- [21] Won-San Chung et al., “Relation between the Quantum Algebra and the Anharmonic Oscillator Problem”, Journal Korean Phys. Soc., Vol.27, No.1, Feb. 1994, p. 117-119
- [22] V. Barsan, “Hsue-Chern Approach to the Quantum Anharmonic Oscillator”, Romanian Reports in Physics, Vol.60, No,2, pp.205-224, (2008)
- [23] C.D. Zeinalipour-Yazdi, “The harmonic oscillator”, [http://www.ucy.ac.cy/~zeinalip/webpage\\_research/The%20Harmonic%20Oscillator.pdf](http://www.ucy.ac.cy/~zeinalip/webpage_research/The%20Harmonic%20Oscillator.pdf)

## Appendix A: Covariant derivative for local phase invariance

From (3-6) and (3-7) we have:

$$\frac{D\Psi}{\partial x_i} = \exp[-j\vartheta(x)] \frac{D\Psi'}{\partial x_i} = \exp[-j\vartheta(x)] \left\{ \frac{\partial}{\partial x_i} \Psi' + jqA_i' \Psi' \right\} \quad (\text{A-1})$$

From (3-8) and (3-5):

$$\exp[-j\vartheta(x)] \frac{\partial}{\partial x_i} \Psi' = \frac{\partial \Psi}{\partial x_i} + j\Psi \frac{\partial}{\partial x_i} \vartheta(x) \quad (\text{A-2})$$

Substitution of (A-2) into (A-1) gives:

$$\frac{D\Psi}{\partial x_i} = \frac{\partial \Psi}{\partial x_i} + j\Psi \frac{\partial}{\partial x_i} \vartheta(x) + jqA_i' \exp[-j\vartheta(x)] \Psi' \quad (\text{A-3})$$

From (A-3) and (8-7) it follows that:

$$qA_i = qA_i' + \frac{\partial}{\partial x_i} \vartheta(x) \quad (\text{A-4})$$

From (10-) and (10-) we have:

$$\frac{D\Psi}{\partial x_i} = \exp[-j\vartheta_k(x)] \frac{D\Psi'}{\partial x_i} = \exp[-j\vartheta_k(x)] \left\{ \frac{\partial}{\partial x_i} \Psi' + jgB_{ki}' \Psi' \right\} \quad (\text{A-5})$$

From (10-) and (10-):

$$\exp[-j\vartheta_k(x)] \frac{\partial}{\partial x_i} \Psi' = \frac{\partial \Psi}{\partial x_i} + j\Psi \frac{\partial}{\partial x_i} \vartheta_k(x) \quad (\text{A-6})$$

Substitution of (A-6) into (A-5) gives:

$$\frac{D\Psi}{\partial x_i} = \frac{\partial \Psi}{\partial x_i} + j\Psi \frac{\partial}{\partial x_i} \vartheta_k(x) + jgB_{ki}' \exp[-j\vartheta_k(x)] \Psi' \quad (\text{A-7})$$

From (A-7) and (10-) it follows that:

$$gB_{ki} = gB_{ki}' + \frac{\partial}{\partial x_i} \vartheta_k(x) \quad (\text{A-8})$$

## Appendix B: Expansion of the Ishii potential

$$V(x) = f(x+d) + f(d-x) \quad \text{with } f(x) = \frac{\exp[-2x]}{x^2} - \frac{\exp[-x]}{x}$$

$$V(x) = g_2(x) - g_1(x)$$

$$g_2(x) = \frac{\exp[-2(x+d)]}{(x+d)^2} + \frac{\exp[-2(d-x)]}{(x-d)^2} = \frac{(d-x)^2 \exp[-2(x+d)] + (x+d)^2 \exp[-2(d-x)]}{(d^2 - x^2)^2}$$

$$= \frac{\exp[-2d]}{(d^2 - x^2)^2} \{ (x^2 - 2dx + d^2) \exp[-2x] + (x^2 + 2dx + d^2) \exp[2x] \}$$

$$= \frac{\exp[-2d]}{(d^2 - x^2)^2} \{ (x^2 + d^2) (\exp[-2x] + \exp[2x]) + 2dx (\exp[2x] - \exp[-2x]) \}$$

$$\approx \frac{\exp[-2d]}{d^4} \left( 1 + \frac{x^2}{d^2} + \frac{x^4}{d^4} \right) \left( 1 + \frac{x^2}{d^2} + \frac{x^4}{d^4} \right) \left\{ (x^2 + d^2) \left( 2 + 4x^2 + \frac{4}{3}x^4 \right) + 8dx^2 + \frac{8}{3}dx^4 \right\}$$

$$\approx \frac{\exp[-2d]}{d^4} \left( 1 + \frac{2x^2}{d^2} + \frac{3x^4}{d^4} \right) \left\{ 2d^2 + x^2(2 + 4d^2 + 8d) + x^4 \left( 4 + \frac{4}{3}d^2 + \frac{8}{3}d \right) \right\}$$

$$\approx \frac{\exp[-2d]}{d^4} \left\{ 2d^2 + x^2(2 + 4d^2 + 8d) + 4x^2 + x^4 \left( 4 + \frac{4}{d^2} + \frac{4}{3}d^2 + \frac{8}{3}d \right) + \frac{2x^4}{d^2} (2 + 4d^2 + 8d) + 6\frac{x^4}{d^2} \right\}$$

$$\approx \frac{\exp[-2d]}{d^4} \left\{ 2d^2 + x^2(6 + 4d^2 + 8d) + x^4 \left( 12 + \frac{14}{d^2} + \frac{16}{d} + \frac{4}{3}d^2 + \frac{8}{3}d \right) \right\}$$

$$g_1(x) = \frac{(d-x) \exp[-(x+d)] + (x+d) \exp[-(d-x)]}{d^2 - x^2} \approx$$

$$\begin{aligned}
&\approx \frac{\exp[-d]}{d^2 - x^2} \{d(\exp[-x] + \exp[x]) + x(\exp[x] - \exp[-x])\} \\
&\approx \frac{\exp[-d]}{d^2 - x^2} \left\{ d \left( 2 + x^2 + \frac{x^4}{12} \right) + 2x^2 + \frac{x^4}{3} \right\} \\
&\approx \frac{\exp[-d]}{d^2} \left( 1 + \frac{x^2}{d^2} + \frac{x^4}{d^4} \right) \left\{ d(2 + x^2) + 2x^2 + x^4 \left( \frac{d}{12} + \frac{1}{3} \right) \right\} \\
&\approx \frac{\exp[-d]}{d^2} \left\{ 2d + x^2 \left( 2 + d + \frac{2}{d} \right) + x^4 \left( \frac{2}{d^3} + \frac{2}{d^2} + \frac{1}{d} + \frac{1}{3} + \frac{d}{12} \right) \right\}
\end{aligned}$$

so: 
$$V(x) = g_2(x) - g_1(x) = k_0 + k_2x^2 + k_4x^4 + \dots$$

with 
$$k_0 = 2 \left( \frac{\exp[-2d]}{d^2} - \frac{\exp[-d]}{d} \right)$$

$$k_2 = \frac{\exp[-2d]}{d^4} (6 + 4d^2 + 8d) - \frac{\exp[-d]}{d^2} \left( 2 + d + \frac{2}{d} \right)$$

$$k_4 = \frac{\exp[-2d]}{d^4} \left( \frac{14}{d^2} + \frac{16}{d} + 12 + \frac{8}{3}d + \frac{4}{3}d^2 \right) - \frac{\exp[-d]}{d^2} \left( \frac{2}{d^3} + \frac{2}{d^2} + \frac{1}{d} + \frac{1}{3} + \frac{d}{12} \right)$$

**Side Note: The relativistic wave equation neglecting spin.**

The development of a spin-less limit for Dirac's Equation starts by observation of the equation set (2-18). Let  $\Psi_1$  be dominant over  $\Psi_2$ . This implies a small value for the energy of  $\Psi_2$ . As we have from (2-1):

$$p_0^2 = p_x^2 - m_0c^2$$

and as it is supposed that:  $m_0c^2 \gg p_x^2$

we have:  $p_0 = \pm jm_0c$

There are two options to choose, a minus sign and plus sign. If we opt for the minus sign, (2-18a) reduces to:

$$\hat{p}_x \Psi_1 \approx 2jm_0c \Psi_2. \quad (2-26)$$

After substitution of (2-26) into (2-18b) and subsequent evaluation we get after identifying  $\Psi_1$  as  $\Psi$ .

$$j\tilde{h}\frac{\partial\Psi}{\partial t} + \frac{\tilde{h}^2}{2m_0}\frac{\partial^2\Psi}{\partial x^2} - c^2\Psi = 0. \quad (2-27)$$

The non-relativistic limit of solutions of this equation appear to be solutions of Schrödinger's Equation:

$$j\tilde{h}\frac{\partial\Psi}{\partial t} + \frac{\tilde{h}^2}{2m_0}\frac{\partial^2\Psi}{\partial x^2} = 0. \quad (2-28)$$

The chosen option for the minus sign corresponds with the negative temporal moment solution of Dirac's Equation. If we suppose that  $\Psi_2$  is dominant over  $\Psi_1$  we may follow the same procedure, but then with the positive temporal moment. The resulting wave equation is the same.

Evidently (2-27) is a valid relativistic version of Schrödinger's Equation. It does not show the flaws of the seriously disputed Klein-Gordon Equation [13,14,15,16] as, according to Dirac's requirement for positive definiteness, the temporal derivative is of first order, thereby obeying the condition for positive definiteness. The very reason for the difference with the Klein-Gordon Equation is the unjustified generalization of the basic hypothesis of quantum mechanics, as formulated in (2-3), of transforming the square of a momentum into a second order differential quotient on a wave function as done in the derivation of the Klein Gordon Equation.

# Supplement I : On the structure of matter

## Summary

In this supplement the structure of the quark doublet is calculated and discussed, thereby showing that the doublet is a bar-bell of two magnetic bubbles with energetic values of tiny masses, but with a strong amount of binding energy. It is explained that the vibration of the bubbles is associated with spin, which is shown to be a modality of the unit of electric charge. Furthermore it is argued that the decay products of the quark doublet, i.e. lepton and (anti-)neutrino are the condensed formats of respectively the electric and magnetic energy of the quark doublet. All this enables to give a view on the possible structure of real matter and dark matter.

## 1. Introduction

In the main text an alternative view has been given on the existence of the Higgs field. The transform of the functional formulation into a spatial formulation has been used as a key instrument to explain nuclear forces in terms of the generalization of Maxwell's equation by introduction of magnetic space charge as originally suggested by Dirac. This view resulted in an explanation of canonic quantum theory without the need to hypothesize the existence of a phantom particle, known as the Higgs boson. It also resulted in an explanation for the algorithmic relationships between the energetic values of the lepton masses, including a prediction for the energetic mass value of the next lepton to be found. It is the aim of this supplement to elaborate further on these ideas. In particular the structure of the quark doublet will be further investigated in an attempt to explain the structure of matter in terms of this novel theory. The structure of the supplement is as follows. In chapter 2 the one-dimensional view on the doublet structure as adopted in the main text will be extended towards a three-dimensional view in order to relate the magnetic energy of the quark doublet with physical mass. In chapter 3 the nature of electric charge of the quark-doublet will be studied, by relating the spin of the motion with an electric field, similarly as the spin of an electron can be related with a magnetic field. In chapter 4 symmetry vs. asymmetry of the quark doublet will be discussed. Finally in chapter 5 a view will be presented on the possible structure of real matter in terms of this theory.

## 2. The structure of the quark-doublet

The theory as outlined in the main text heavily relies upon the alternative formulation of the Higgs field in terms of the Ishii potential defined as:

$$\eta(\rho) = \frac{\exp[-\rho]}{\rho} \left( \frac{\exp[-\rho]}{\rho} - 1 \right) \quad \text{with } \eta = \Phi/\Phi_0 \quad \text{and } \rho = \lambda r. \quad (2-1)$$

The configuration of two particles with this potential can then be characterized by:



$$V(x) = f(x+d) + f(d-x) \quad \text{with } f(x) = \frac{\exp[-2x]}{x^2} - \frac{\exp[-x]}{x}, \quad (2-2)$$

which can be expanded as:

$$V(x) = k_0 + k_2x^2 + k_4x^4 + \dots$$

$$\text{with } k_0 = 2\left(\frac{\exp[-2d]}{d^2} - \frac{\exp[-d]}{d}\right)$$

$$k_2 = \frac{\exp[-2d]}{d^4}(6 + 4d^2 + 8d) - \frac{\exp[-d]}{d^2}\left(2 + d + \frac{2}{d}\right)$$

$$k_4 = \frac{\exp[-2d]}{d^4}\left(\frac{14}{d^2} + \frac{16}{d} + 12 + \frac{8}{3}d + \frac{4}{3}d^2\right) - \frac{\exp[-d]}{d^2}\left(\frac{2}{d^3} + \frac{2}{d^2} + \frac{1}{d} + \frac{1}{3} + \frac{d}{12}\right), \quad (2-3)$$

wherein  $x = r\lambda$ ,  $V(x) = \Phi(x)/\Phi_0$ ,  $d' = d\lambda$  and wherein  $d$  is the distance between quark and antiquark. It has been shown that this configuration is subject to (an)harmonic oscillation. By hypothesis this oscillation has been ascribed to magnetic forces under generalization of Maxwell's laws. In this supplement we wish to elaborate on this hypothesis.

According to the magnetic extension of Maxwell's laws the first spatial derivative of the potential  $\Phi(x)$  is, apart from a proportionality constant, the field  $B(x)$  and the divergence theorem expresses that the first derivative of the field  $B(x)$  is the magnetic space charge  $\rho_m(x)$ . Fig.1 shows pictures of these characteristics for the isolated quark (i.e. not in doublet configuration).

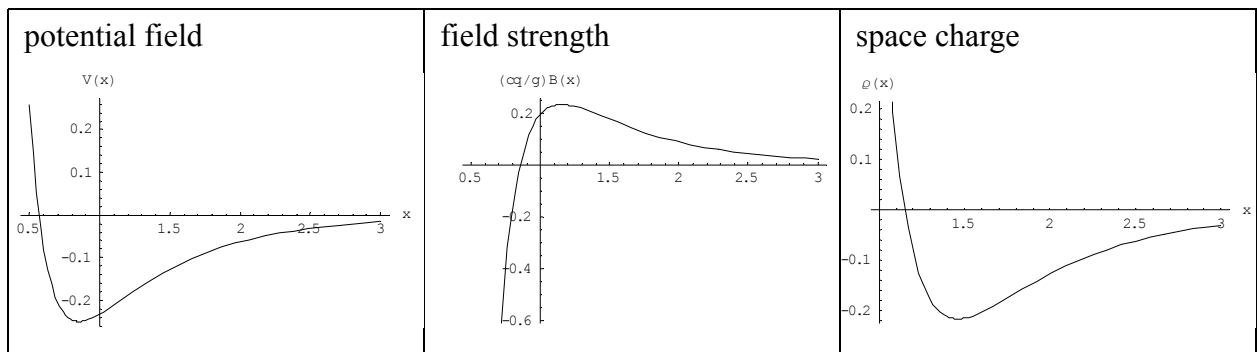

**Table 13: Potential field, field strength and space charge of a single quark**

The middle one of these characteristics shows that a take-over position exists from attractive force to repulsive force. The most left one shows that a take-over position exists where positive mag-

netic space charge changes into negative magnetic space charge. So, the game of attractive and repulsive forces apparently has to be explained as follows. For the space charge particles of a quark A at distance from quark B the attractive force is felt first, i.e. before the repulsive force becomes dominant. This force is different in sign for positive and negative space charge particles of quark B. If the effective total space charge of quark B is positive, quark B is attracted by quark A up to an equilibrium position where attractive and repulsive force are balanced.

This explanation implies that the magnetic charges of both quarks have to be identical to bind them in an equilibrium position. It requires some “mental twist” to understand it: particles with identical (electro)magnetic charge can attract each other, while the mental perception usually tells the opposite. The difference though is that the usual perception is based upon a zero space charge around the electro(magnetic) source while in our case we have to do with a non-zero space charge with a particular distribution.

Fig.2 shows the potential field, field strength and space charge for the quark doublet at minimum energy ( $d' = 0, 84$ )

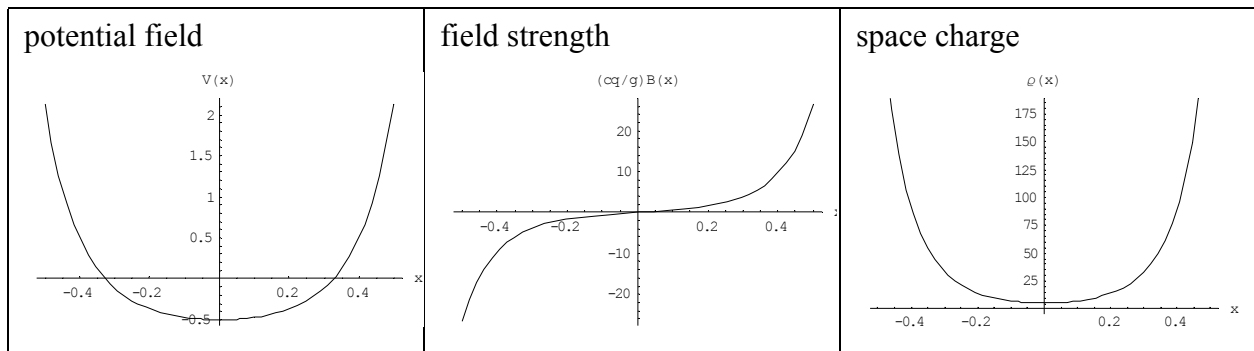
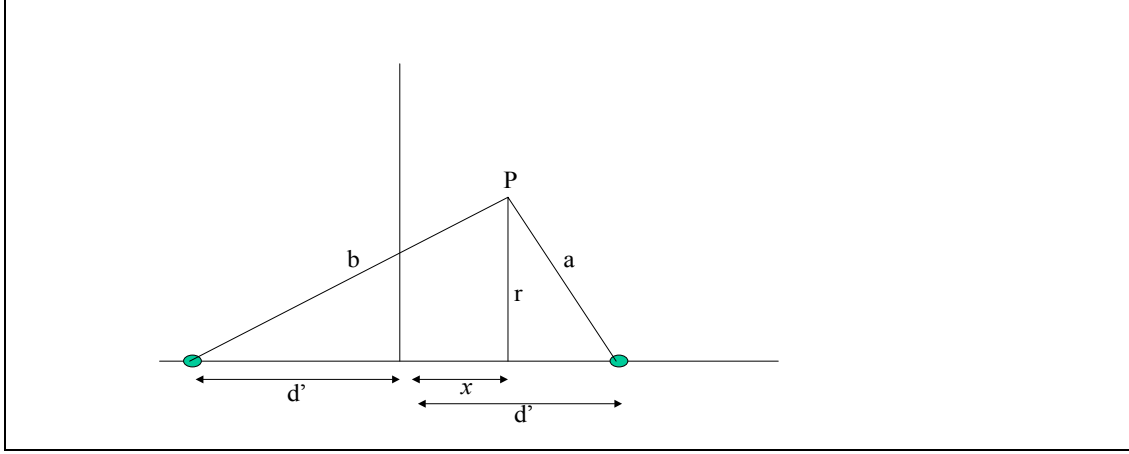

**Table 14: Potential field, field strength and space charge of a quark doublet**

In principle it is possible to calculate the magnetic energy distribution  $W_m(x)$  of the doublet from the field strength characteristic. This requires knowledge of the field strength in terms of a volume element. It is therefore not sufficient to know only the axial field distribution as shown in fig.2. We have to know the radial distribution as well. In fact we have to establish:

$$W(x) = \frac{1}{2\mu_0} \int_0^{\infty} |B_r(x, r)|^2 \pi r^2 dr. \quad (2-4)$$

Therefore the field  $\Phi$  has to be considered in more spatial dimensions than the single one as we did so far.



**Table 15: Coordinates for a field with rotational symmetry around x-axis**

As we know that the field is rotationally symmetric around the linear axis between the two quarks we have to consider  $\Phi(r', x)$ , as clarified by fig.3, now as:

$$\frac{\Phi(r, x)}{\Phi_0} = \frac{\exp[-2a]}{a^2} - \frac{\exp[-a]}{a} + \frac{\exp[-2b]}{b^2} - \frac{\exp[-b]}{b}, \text{ wherein}$$

$$a^2 = r^2 + (d-x)^2 \quad \text{and} \quad b^2 = r^2 + (d+x)^2. \quad (2-5)$$

As we know from section 7 [1] that:

$$\mathbf{B} = \frac{g}{cq_e} \nabla \Phi \quad (2-6)$$

we have

$$B_x(x, r) = \frac{g}{cq_e} \frac{\partial}{\partial x} \Phi(r, x) \quad (2-7)$$

so that from (2-4):

$$W(x) = \frac{1}{2\mu_0} \int_0^\infty \left| \frac{\partial \Phi}{\partial x} \right|^2 \pi r^2 dr \quad (2-8)$$

As

$$q_e^2 = 2\varepsilon_0 \tilde{h} c g^2 \quad (\text{see 7-4, [1]}) \quad (2-9)$$

we get from (2-8):

$$W(x) = \left( \frac{\Phi_0^2}{hc} \right) \int_0^\infty |f(x, r')|^2 \pi r'^2 dr' \quad (2-10)$$

wherein  $f(x, r')$  is a dimensionless function with a similar shape as  $\Phi(r, x)$ . We rewrite (2-10) as:

$$W(x) = \left( \frac{\Phi_0^2}{hc} \right) I(x) \quad \text{with } I(x) = \int_0^\infty |f(x, r')|^2 \pi r'^2 dr'. \quad (2-12)$$

Fig. 4 shows a plot of  $I(x)$  for  $d' = d'_0 = 0,84$ , obtained from numerical computation. From this graph it is clear that the magnetic energy is concentrated at the sides. This is not surprising as the magnetic sources are located at the sides. If we identify the integral of the magnetic energy as the energetic expression for physical mass, the picture is in agreement with the two-body system as shown in fig.12 [1]. We know however that the energy of the motion is in the center of the two bodies, corresponding to the one-body equivalent.

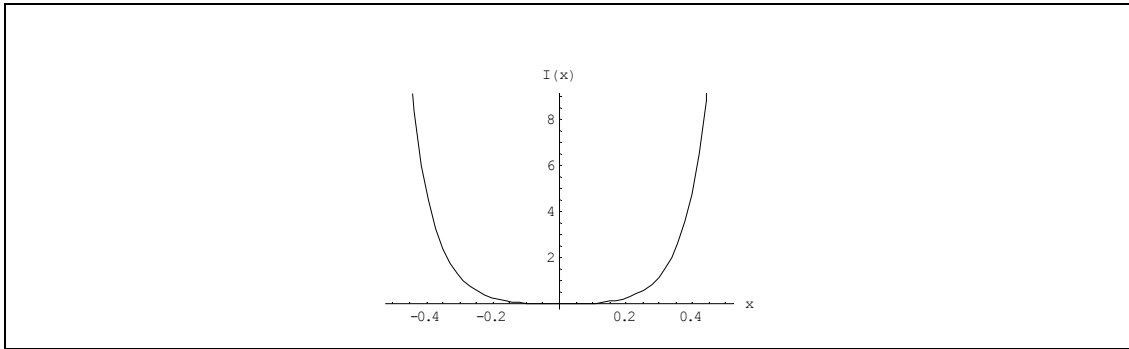

**Table 16: Energy distribution of a quark doublet**

How to relate physical mass of a body in the center with the energetic picture of magnetic energy?

The answer comes from  $\Phi_0$ . In the quantum mechanical (an)harmonic oscillator model a centric mass with energy  $m'_p$  has been identified, which has been related with  $\Phi_0$  by (see 9-9,[1]) as:

$$\Phi_0 = \frac{\alpha^2 m'_p}{8(\lambda d_0)^2 k_2}. \quad (2-13)$$

In the anharmonic model the constant  $\alpha$  has been shown to be  $\alpha = 1$  (see 9-43,[1]). This centric mass is an equivalent model for the two-body mass, which in total is twice as large. Obviously the energetic equivalent  $2m'_p$  of the two-body mass is given by:

$$2m'_p = 2 \int_0^{x_0} W(x) dx \quad \text{where } W(x) \text{ is given by (2-10), so that from (2-12) and (2-10):}$$

$$m'_p = \frac{8d_0^2 k_2^2 \tilde{h} c}{I(x_0)} \quad \text{with } I(x_0) = \int_0^{x_0} F(x) dx. \quad (2-14)$$

It will be obvious from fig.4 that  $I(x_0)$  tends to go to infinity if  $x_0$  tends to go to  $d'_0$ , so that  $m'_p$  tends to go to zero. In fact this means that the problematic *renormalization problem* pops up in an unexpected way. It is due to the fact that the energy of the magnetic source blows up in a similar way as the energy of an electric point source does. Classic electromagnetic theory has no answer on this problem and in quantum mechanics the problem is avoided by renormalization of mass, i.e. by differentiating between so called observable mass and bare mass. This is a rather ugly escape route, implying that two infinite mass parameters are subtracted from each other, thereby providing a finite result.

The theory as developed in this paper allows suggesting an alternative interpretation. Although the theory of quantum mechanical oscillations gives only results in terms of a quantum wave, i.e. in terms of the probability that a particle has at a particular time a particular position, it is allowed to adhere a classical interpretation to it in the sense that the propagation of the probability packet represents a motion of a particle. If we apply this view to the vibration of the (an)harmonically oscillating physical mass as we consider here, we might well suppose that the motion is restricted around the equilibrium position such that it does not fully extend up to  $d'_0$ . This makes the integral  $I(x_0)$  finite, so that we obtain a non-zero value for  $m'_p$  indeed. Unfortunately we have no means to establish a value for  $x_0$ , so that other considerations are required to establish a value for  $m'_p$ .

Remark: The shift from the two-body model to an equivalent one-body model with the conclusion that the one-body mass may be very tiny of course means that the masses of the two bodies in the two-body model are tiny as well. The energy concentration at the sides and the large value for  $I(x_0)$  may suggest otherwise, but note that this very large value is multiplied by the square of a very small value (as represented by  $\Phi_0$ , being a measure for  $m'_p$ ).

Before addressing the problem to establish a value for  $m'_p$ , we wish to pay some attention to another property of the quark doublet. We know that the doublets are charged with the unity of electric charge. But so far, we have described the doublet only in terms of magnetic charge. What about electric charge? This is the issue we wish to address first before discussing the mass value of  $m'_p$ . It will be dealt with in the next section on electromagnetic particles in motion.

### 3. Electromagnetic particles in motion

We have seen before [1] that the solution of Dirac's equation for a charged particle moving with velocity  $v_x$  in space-time with a single spatial dimension has the format of:

$$\Psi_i(x, t) = u_i \exp\left[j\left(\beta \frac{p_x}{\hbar} x - \frac{E}{\hbar} t\right)\right], \text{ wherein } \beta = \pm 1 \text{ and wherein}$$

$$\frac{E^2}{c^2} = \beta^2 p_x^2 \quad \text{such that} \quad E^2 = m_0 \frac{c^4}{w^2} \quad \text{with} \quad w^2 = 1 - (v_x/c)^2. \quad (3-1)$$

Moreover we have concluded that:

$$u_2 = \pm j \frac{v_x}{c(w+1)} \quad \text{if} \quad u_1 = 1. \quad (3-2)$$

The temporal moment  $E$  seems to explode to infinity for  $v_x \rightarrow c$ . However by simultaneously increasing velocity to light velocity and reducing mass to zero, the temporal moment parameter remains a finite constant. For the same reason the spatial momentum  $p_x$  then remains finite as well. Under such conditions we may write:

$$E = \hbar \omega \quad \text{wherein} \quad \omega = \lim_{m_0, w \rightarrow 0} \frac{m_0 c^2}{w \hbar}. \quad (3-3)$$

The resulting wave function is:

$$\Psi_i(x, t) = u_i \exp[j(\pm kx - \omega t)] \quad \text{wherein} \quad k = \omega/c$$

and 
$$u_i = (u_1, u_2) = (1, \pm j) \quad (3-4a,b)$$

For the probability density of this harmonic wave function it follows that:

$$P(x, t) = |\Psi_1|^2 + |\Psi_2|^2. \quad (3-5)$$

The multi-dimensionality of the wave function solution of Dirac's equation allows assigning an energetic interpretation to it. If we identify  $\Psi_1$  and  $\Psi_2$  of this massless limit as respectively

$E_y \sqrt{\epsilon_0}$  and  $H_x \sqrt{\mu_0}$ , we have:

$$E_y = \frac{1}{\sqrt{\epsilon_0}} \exp[-j\omega t] \cos[kx] \text{ and } H_x = \pm j \frac{1}{\sqrt{\mu_0}} \exp[-j\omega t] \cos[kx] , \quad (3-6)$$

so: 
$$P(x, t) = [E_y^2 \sqrt{\epsilon_0} + H_x^2 \sqrt{\mu_0}] \cos^2[kx] . \quad (6-7)$$

This result suggests that the 1+1-dimensional Dirac equation can be gradually transformed into Maxwell's equation. In other words: the energy of an electron can be gradually transformed into photon energy. The mechanism is a gradual decrease of one spinor component and a gradual increase of the other spinor component. These spinor components eventually show up as the electrical field and the magnetic field. It seems as if the electron is predominantly composed by energy of an electric field with a small energy amount of a magnetic field. By increasing the latter one at the cost of the former eventually the energy transforms in photon energy. If the electron is supposed to be at rest the "magnetic component" reduces to zero and the "electric component" carries the total of the energy.

Note: In making this comparison we do not wish to suggest that the spinor components actually represent an electric field and a magnetic field. The spinor has probability semantics while the electromagnetic field has energetic semantics. The spinor has to do with the *target aspect* of the electron. It expresses the sensitivity of its probability density function for a field of forces. The electromagnetic field has to do with the *generation aspect* of the electron. It expresses the strength of the field of forces it generates for which other electrons (and itself if self-interaction is taken into account) are sensitive. In both cases however the relationship between the magnitudes of the components depends on the velocity of the electron in a similar way.

The sign ambiguity of  $H_x$  in (6-7) expresses that the flat Maxwellian wave may be in two states of polarity. If we consider such a wave as the massless limit of an electric charge in motion, there cannot be any ambiguity if the sign of the charge is known. That means that a positive charge is responsible for one polarity and a negative one for the other: one more reason for the existence of a positron as antiparticle for the electron.

From this consideration it may seem as if an electron can turn into a photon by gradually increasing its velocity. But if this true, what kind of photon it is? Is it a single frequency photon with the same energy as the rest mass of the electron? Or is it a massless particle with a narrow Fourier-distribution of frequencies, and if so what is the single-frequency photon distribution in this packet?

If the velocity of a single electron is increased, eventually the energy turns into an unmodulated combination of an electric field and a magnetic field. So, we cannot assign a frequency to this packet of energy. Neither it is possible to assign a uniform Fourier-distribution to this energy packet, because photon quantization would result into infinite energy. This problem has some similarities as with the black body radiator. To give an answer to this problem we have to realize ourselves that quantum theory reflects a statistical view on physics. So, we might well turn a large

ensemble of electrons into a photon gas with a uniform energy distribution over all frequencies under the constraint of finite energy, in spite of the fact that this is impossible from a single electron perspective.

The so-called Free Electron Laser (FEL) is an application for turning electrons into photons [2]. A bundle of electrons is accelerated in a cyclotron and passed through a device with an array of magnets (dipoles) with alternating polarity. So the electrons are not only speeded up near light velocity, but modulated as well, so that single frequency coherent electromagnetic radiation is obtained.

Note: Both the temporal and the spatial differential quotients in Maxwell's wave equation are of second order. In that respect Maxwell's wave equation has a similar shape as the Klein-Gordon Equation. The wave function solution is a product of a real time function and a real spatial function. But, as Dirac pointed out, such a wave function is not compatible with the Born interpretation. But in contrast with the Klein Gordon Equation, Maxwell's wave equation is not criticized. How to explain it? As argued in [3,4], the wave function of Maxwell's equation has to be conceived in terms of the energy measure  $\mathbf{E} \times \mathbf{H}$  (Poynting vector) rather than in *separate* electric and magnetic components. If done so, like done for the first time by Ludwik Silberstein [5], the wave equation meets Dirac's requirement of a first order temporal behavior.

Let us now apply these views for the dual case, i.e. for a particle that is essentially magnetic. Let us suppose that the quark doublet as considered in the preceding sections is a magnetic particle in rest, albeit that the magnetic charge of this doublet has the particular distribution as imposed by the Ishii potential. Its rest mass is the spatial integral of the magnetic field created by this charge, similarly as the electron's rest mass is the spatial integral of the electric field created by its charge. If this mass is brought in heavy vibration, it ultimately evaporates as a boson, similarly as an electron brought at light velocity evaporates as a photon. The boson's energy is virtual, but if it condensates the energy of the condensation products equates the original rest mass plus the energy which has brought the doublet in heavy vibration. There is no reason whatsoever why the condensation products should assume the identical format as the original doublet. Knowing that the condensation product is a lepton and a lepton-neutrino, it is fair to suppose that the lepton's energy is the vibration energy and that the lepton-neutrino energy is the rest mass of the doublet. So, a quark-antiquark doublet, a string of magnetic energy so to say, gains in electric energy, which eventually spins out. As the doublet in this picture is a bounded structure of two magnetic particles there is some minimum amount of an electric field, implying that the doublet shows electric charge. The magnetic monopole theory implies that this charge is discrete. This is in agreement with canonic theory, albeit that the canonic theory prescribes an asymmetric quark doublet wherein one of the quarks is responsible for 2/3 of the electric charge and the other for 1/3 of the charge. We shall come back on this issue in the next chapter.

#### **4. The intra-nucleon structure (Chromo dynamics)**

So far we have discussed the quark doublet in terms of a symmetric structure. In canonic theory the issue of electric charge has been the motivation to abandon a symmetric structure in favor of an asymmetric structure. There are a number of reasons to do so. First of all the Yang Mills prin-



ciple (also discussed in [1]) tells us that a doublet structure has to show three (i.e.  $2^2 - 1$ ) types of bosons. And indeed both the nucleon bosons (mesons) and the meson bosons (W-type, and Z-type) appear to show up in three types indeed: with positive electric charge, with negative electric charge and neutral. If we adopt the view that motions of magnetic particles cause electric fields and that the energy of the electric field represents electric charge, the existence of a neutral boson is not compatible with a symmetric structure. Apparently the one-body model is not a correct equivalent of the two-body model. It might be correct for many properties, but not for all. In canonic theory an asymmetry is introduced for the charges of quarks. As long as a doublet is considered it would not be strictly necessary as symmetry could be preserved by splitting up charges in halves, resulting in a net amount of negative charge ( $-1/2 - 1/2$ ), positive charge ( $1/2 + 1/2$ ) or no charge ( $-1/2 + 1/2$ ). In this way symmetry can be preserved. In canonic theory a split is introduced in  $2/3$  and  $1/3$  in order to obtain negative, positive and neutral charge by respectively ( $-2/3 - 1/3$ ), ( $2/3 + 1/3$ ) and ( $1/3 - 1/3$ , or  $2/3 - 2/3$ ). The reason for choosing this option has to do with the presumed triplet structure for quarks in a nucleon, as will be indicated below. It has to be noted that the choice is purely heuristic, as no charged isolated quarks have ever been detected. Instead only composite quark particles with unity charge physically exist. It will be clear that a split of  $2/3$  and  $1/3$  would result in an asymmetric quark-doublet structure, which would imply a significant derogation of the model developed so far. It would be much more satisfying if we could consider the quark doublet as a bar-bell of two magnetic bubbles with twisted spin for neutral electrical charge and left/ right spin for negative/positive charge. Is such a structure really in conflict with the quark model of nucleons?

The nucleon consists of a triplet of quarks. The magnetic force between three quarks may keep each other in equilibrium. Moreover the internal balancing of the magnetic charge results in a net external force with a similar potential as that of an isolated quark, thereby enabling the nucleon doublets, i.e. a stable neutron-proton doublet and a less stable neutron-neutron doublet. In accordance with the Yang Mills principle there must be eight types (i.e.  $3^2 - 1$ ) of intra-nucleon bosons, as virtual particles can be exchanged with any of the neighbors. These are the so-called chroma-forces. As far as the author of this paper can see, this heuristic model of chroma-forces is not in conflict with the physically based concept of exchange of magnetic forces. But how explaining the electric charge? As already noted above, in canonic theory an electric charge asymmetry of  $2/3$  and  $1/3$  is heuristically adopted to explain positive charge (proton), negative charge (anti-proton) and neutral charge (neutron). But suppose that we maintain the view of spinning magnetic bubbles. At first sight it may seem that such a view is not compatible with a neutral charge. This however is the case if the centric space charge of the triplet is ignored. It is quite improbable that the centric space charge will not spin if the bubbles in the triangle do. Therefore, by including spin of the centric space charge, neutral nucleons may be well conceivable. Again a natural explanation would result for protons, neutrons and anti-protons without violating the symmetry of the quark structure.

It may seem that such a model is in conflict with the present status of the theory of Chromo dynamics. But this theory is a modeling theory, in which models appear to be not in conflict with observed phenomena. It is not excluded that, after all, both models may produce/predict identical results.

## 5. Structure of mass

In fig.5 an illustrative picture is given about the structures as discussed so far. The binding forces of the nucleon doublets are represented by virtual particles that are radiated as mesons if the energy of the nucleon-doublet falls back from a higher state into a lower state. The mesons are believed to be quark doublets. The quark doublet in bounded state, i.e. as sub-particle of a nucleon, is electrically charged by unity charge in a way as explained above, i.e. as modality of spin. The quark doublet in higher energetic state, i.e. as meson, evaporate as W-bosons, which decay into a condensed electric field, known as muon and a rest particle, known as (anti-)neutrino. The muon decays into electrons. The nucleons and electrons are the constituents of real matter. So, in this picture all real matter is nothing else than condensed electromagnetic energy.

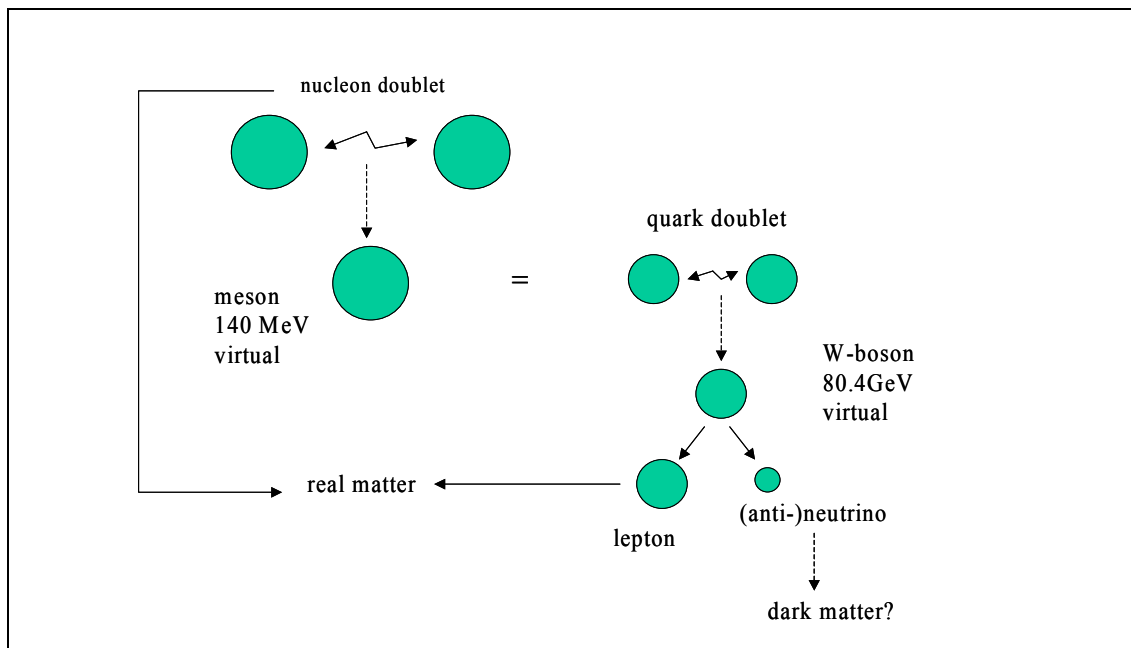

**Table 17: Structure of matter**

This picture of matter is based on a view of *decomposition*. What about the inverse process, i.e. a view of *composition*? Although speculative, the picture suggests the following mechanism. It all starts with the tiny mass of the (anti)neutrino, which represents the energy of a magnetic bubble. Isolated as tiny particles, they are only detectable with special means as product of a forced collision process. They virtually disappear soon thereafter. However if two of those particles could be brought into close encounter, they will bind each other as a quark doublet, thereby forming the ultimate building brick of real matter. As long as they are not brought in close encounter they remain in the background as “*dark matter*”.

Is this all true? The author of this paper does not know, but it gives anyway a picture on matter, which can be more easily understood than composition of matter out of a never detected Higgs-particle.

Let us now address the problem of assigning a value to the parameter  $m'_p$  of the vibrating quark doublet. As we have seen, this doublet radiates a boson with energy  $m'_W$  if the vibration motion falls back from a state of higher energy into a state of lower energy. It has been shown in [1] that the adoption of a value 1 for the ratio of the two masses appears to provide an explanation for the mass relationships within the lepton family. The energetic value of the bosons is known from experimental physics. This value is pretty large:  $m'_W \approx 80,4 \text{ GeV}$ . With a ratio of 1, this would imply the same value for  $m'_p$ , but if so, the centric mass  $m'_p$  of the (an)harmonic oscillator can not be a measure for the physical mass of the quark doublet as  $m'_W$  exceeds the energetic value of the meson mass by some orders of magnitude. To state that the bosons are virtual particles, so that their energy can only be manifest with in Heisenberg's uncertainty interval and that therefore the energy value of a boson is not a relevant parameter, does not explain why the leptonic algorithm appears to be solved under the adoption of a ratio  $m'_W/m'_p = 1$ . Analyzing the role of  $m'_W$  in the various relationships shows that this parameter is nothing else than an expression for the spacing of two quarks in the quark doublet: a narrow spacing necessarily results in a high value for  $m'_W$  if it is true that force binding particle virtual particles operate at near light velocity speed. So, in spite of the fact that  $m'_W$  represents the energy of a virtual particle, the value for  $m'_W$  is not virtual. In fact it is  $m'_p$  which has to be handled with care. Within the Heisenberg interval  $m'_p$  is indefinite, so within this interval the ratio  $m'_W/m'_p = 1$  holds, but the ratio can be quite different outside.

Whether these simple qualitative considerations are in line with the rather complicated mass theory of canonic quantum theory is questionable. In particular as there is no general agreement on the definition of mass [6]. If however the next lepton to be found appears to show a mass level of about  $12,2 \text{ GeV}/c^2$  and if such a particle will be found without any sign of a Higgs boson still, as predicted in [1], a qualitative picture as developed in this paper will make sense.

## 5. Conclusions

We have calculated and discussed the structure of the quark-doublet, thereby showing that the doublet is a bar-bell of two magnetic bubbles with energetic values of tiny masses, but with a strong amount of binding energy. It has been explained that the vibration of the bubbles is associated with spin, which is identified as the unit of electric charge. Furthermore it has been argued that the decay products of the quark doublet, i.e. lepton and (anti-)neutrino are respectively the condensed formats of respectively the electric and magnetic energy of the quark doublet. Finally a view has been given on the possible structure of real matter and dark matter.

## References

[1] main text

[2] [http://en.wikipedia.org/wiki/Free\\_electron\\_laser](http://en.wikipedia.org/wiki/Free_electron_laser)

[3] M. G. Raymer and Brian J. Smith, "The Maxwell wave function of the photon", SPIE Conference, Optics and Photonics, Conference number 5866, The Nature of Light: What is a Photon? (San Diego, Aug. 2005)

[4] I. Bialynicki-Birula, "Photon wave function", Progress in Optics XXXVI, p. 245-294, E. Wolf, ed. (Elsevier, Amsterdam, 1996)

[5] L. Silberstein, "Elektromagnetische Grundgleichungen in bivectorielle Behandlung", Annalen der Physik 22, 579, 1907

[6] R.I. Khrapko, "What is mass?", Phys-USP, 2000, 43(12), 1267-1270

# Supplement II: On the relationship between Gravity and Electromagnetism

## Summary

In this paper a quantum mechanical equivalent is derived for Einstein's Field Equation. This is done by calculating the curvature of space time under influence of the Higgs field and relating the result with the energy momentum content in it. The proportionality constant between the two is the equivalent of the gravitational constant. It is discussed whether this equivalent is equal to the gravitational constant itself in an attempt to unify quantum mechanics, electromagnetism and gravity. For verification of the theory the mass ratios of (anti-)neutrinos is calculated. The result of the calculation shows a fair fit with the estimated values as presently available from experimental evidence.

## 1.0 Introduction

Previously we have described the quark-antiquark doublet as a cloud of vibrating (electro)magnetic energy [1,2]. This vibration has been modeled as the motion of a particle in a energetic field with potential characteristics similar to an (an)harmonic quantum mechanical oscillator. This induces the idea that somehow it must be possible to relate relativistic massive motions with electromagnetism. Motions under general relativity are captured by the concept of Gravity. The relationship as mentioned would be manifest if it would be possible to *calculate* the gravitational constant  $G$  out of parameters belonging to the Quantum Theory. Would that be possible? This is the issue we wish to address in this document.

We shall do so along the following lines. In the next chapter (chapter 2) we first summarize the leading considerations to outline the approach. This will show the need for deriving a quantum mechanical wave function of a particle in terms of the metric tensor of the energetic space time in which it moves. This will be done in chapter 3. In chapter 4 the metric tensor will be expressed in terms of quantum mechanical parameters, in particular in the parameters of the so-called Higgs field. The reason to do so is, that, as shown in the present state of Quantum Theory, the Higgs field is the link between electromagnetism and quantum mechanics. In chapter 5 the ingredients of Einstein's Field Equation (which in fact captures the Gravity Theory), i.e. the Einstein tensor and the energy momentum tensor, are formulated in respectively parameters of the Higgs field (replacing the metric tensor parameters) and energetic parameters of a quantum wave. The new formulation of Einstein's Field Equation will yield an expression for the equivalent of the gravitational constant in terms of electromagnetic and quantum wave parameters.

Is this approach fundamentally different from the wrong and naive approach to equate Coulomb's law with Newton's gravity law? In that case the physical mass is calculated of two charged particles out of the energies of their electric fields and the attractive Newtonian force between the

resulting masses is equated with the attractive or repulsive electric force in order to obtain an expression for the gravitational constant. The outcome of this is false by an order of magnitude of about  $4,3 \times 10^{38}$ . So it is fair to ask whether the approach described above is not a complex way for the same approach and therefore an intellectual trap once more. However where the naive approach equates a strong bipolar (electric) force with a weak unipolar (gravitational) force the method described above equates two unipolar forces. This is the basic reason why the two approaches are fundamentally different indeed.

## 2.0 Considerations and motivation

Let us start with summarizing the considerations outlining the approach for analysis:

1. The motion of a massive test particle in a field of forces is subject to the Principle of Equivalence. This principle says that the particle's motion under force can be derived from its free space motion by a simple transform rule. The transform rule is a transform of coordinates of space time. The resulting equation of motion is the Geodesic Equation, which contains the metric tensor ( $g_{ij}$ ) as a parameter. The metric tensor describes the characteristics of the transform of coordinates.
2. The quantum mechanical wave equation of a massive particle in free space can be derived by its equation of motion in free space by a simple transform rule. The rule consists of transforming momenta into first order differentiation of a wave function.
3. The quantum mechanical wave equation of a massive particle in a field of forces is subject to Yang Mills' Principle. This principle says that the particle's wave function under force can be derived from its free space wave function by a simple transform rule. The rule is a change of global phase invariance into local phase invariance, similarly as the change of global Lorentz transform into local Lorentz transform in relativistic motions.
4. Electromagnetic fields are formats of energy, similarly as massive particles in rest. All formats of energy are subject to Einstein's Field Equation. This equation is expressed in parameters that can be derived from the metric tensor at one end: the Einstein tensor part ( $G_{ij}$ ). At the other end the equation contains parameters that can be derived from energy as present in the space as characterized by the metric tensor: the energy momentum part ( $T_{ij}$ ). There is a proportionality factor  $G$  involved, known as the gravity constant. The full expression is:

$$G_{ij} = \frac{8\pi G}{c^4} T_{ij} \quad \text{with} \quad G_{ij} = R_{ij} - \frac{1}{2} R g_{ij}. \quad (2-1)$$

Herein  $R_{ij}$  and  $R$  are respectively the so-called Ricci tensor and the Ricci scalar which can be calculated if the metric tensor components  $g_{ij}$  are known.

5. The equivalent of the energy momentum tensor of a cloud of electromagnetic energy ( $T_{ij}^{EM}$ ) can be expressed in terms of electric fields  $E$  and magnetic fields  $H$  [3]:

$$\text{if } i = 0 \text{ and } j = 0: \quad T_{00}^{EM} = \frac{1}{2}(\epsilon_0 E^2 + \mu_0 H^2)$$

$$\text{if } i = 0 \text{ and } j \neq 0: \quad T_{0j}^{EM} = (\mathbf{E} \sqrt{\epsilon_0} \times \mathbf{H} \sqrt{\mu_0})_j$$

$$\text{if } i \neq 0 \text{ and } j \neq 0: \quad T_{ij}^{EM} = \epsilon_0 E_i E_j + \mu_0 H_i H_j - \frac{1}{2} \delta_{ij} (\epsilon_0 E^2 + \mu_0 H^2), \text{ wherein}$$

$$E^2 = \sum_{j=1}^3 E_j^2, H^2 = \sum_{i=1}^3 H_i^2 \text{ and } \delta_{ij} = 1 \text{ if } i = j \text{ and } \delta_{ij} = 0 \text{ if } i \neq j. \quad (2-2)$$

What kind of conclusions can be drawn from these considerations? Let us suppose that the dynamics of an electromagnetic cloud can be described as a test particle moving in a space described by a metric tensor. Its quantum mechanical wave equation can be obtained by transform of the equation of motion (consideration 2). This wave equation will contain the parameters of the metric tensor. That is one way to obtain the wave equation. But there is another way as well. This other way is to extract the wave equation from Yang Mills principle (consideration 3). This wave function will contain parameters of a potential field. Knowledge of this potential means that the metric tensor parameters can be extracted in terms of this potential field. Equating the two expressions of the quantum mechanical wave equation can do this. This will enable to calculate the Einstein tensor ( $G_{ij}$ ) in terms of parameters of the potential field. See (2-1). The potential field however is an expression of an electromagnetic behavior. It means that we have expressed now the left hand part of Einstein's Field Equation ( $G_{ij}$ ) in terms of parameters of the electromagnetic field.

What about the right hand part? Apart from the proportionality factor involving the gravitational constant  $G$ , the right hand part consists of the energy momentum tensor, which we can express in terms of the electromagnetic field as well (consideration 5). As soon as these two parts of the Einstein Field Equation can be retrieved, the proportionality  $G$  can, at least in principle, be calculated. So, the crux is in the knowledge of the potential field.

How to obtain this knowledge? In a previous paper we have shown that a quark doublet can be described as a one-dimensional cloud of vibrating (electro)magnetic energy [2]. This energy has been modeled as a test particle moving in an energetic field with potential characteristics similar to an harmonic or anharmonic quantum mechanical oscillator. Moreover we have shown that this energetic field can be identified as the Higgs field described in terms of spatial parameters [2]. All these ingredients indicate the possibility to relate the gravitational constant via the Higgs field

with electromagnetism. That would mean unification between gravity, quantum mechanics and electromagnetism.

Needless to say that this would be a striking conclusion, because the unification problem is the most outstanding problem of to-day's physics.

The question is merely how the mathematics to do so can be organized. This will be the subject of the subsequence of this paper. First of all we wish to derive a quantum mechanical wave equation in terms of components of the metric tensor (section 3). After that we wish to express the metric tensor in terms of quantum mechanical parameters (section 4). Equating two versions of the quantum mechanical wave equation: one including the metric tensor and another one including the Higgs field will do this. In section 5 the electromagnetic energy momentum tensor of the Higgs field will be derived. Using these results, in section 6 an equivalent of the gravitational constant will be expressed in terms of electromagnetic parameters.

### 3.0 The wave function in terms of the metric tensor.

In this section we wish to obtain a quantum mechanical wave equation in terms of the components of the metric tensor. This can be done by transform of the equation of motion of a test particle in a field of forces. This equation of motion is known as the geodesic equation. Fortunately the space time under test has a single spatial dimension. This is a result of the modeling of the quark-anti-quark doublet by a linear mechanical motion. Under this condition the equation of motion can be read as [4]<sup>1</sup>:

$$\begin{aligned} \frac{d^2x}{d\tau^2} + \frac{1}{2g_{xx}} \left[ \frac{\partial g_{xx}}{\partial x} \left( \frac{dx}{d\tau} \right)^2 - \frac{\partial g_{tt}}{\partial x} \left( \frac{dt'}{d\tau} \right)^2 + 2 \frac{\partial g_{xx}}{\partial t'} \left( \frac{dx}{d\tau} \frac{dt'}{d\tau} \right) \right] &= 0 \\ \frac{d^2t'}{d\tau^2} + \frac{1}{2g_{tt}} \left[ \frac{\partial g_{tt}}{\partial t'} \left( \frac{dt'}{d\tau} \right)^2 - \frac{\partial g_{xx}}{\partial t'} \left( \frac{dx}{d\tau} \right)^2 + 2 \frac{\partial g_{tt}}{\partial x} \left( \frac{dx}{d\tau} \frac{dt'}{d\tau} \right) \right] &= 0 \end{aligned} \quad (3-1a,b)$$

What does it mean? We see the following parameters:  $x$ ,  $\tau$ ,  $t'$ ,  $g_{xx}$  and  $g_{tt}$ . Of course  $x$  is the spatial coordinate. Furthermore we have two different time coordinates. The parameter  $t'$  is the normalized time for the stationary observer, i.e.  $t' = jct$ , wherein  $c$  is the light velocity and  $j = \sqrt{-1}$ . The parameter  $\tau$  is proper time, i.e. the wrist time of a co-moving observer (co-moving with the particle). The parameters  $g_{xx}$  and  $g_{tt}$  are elements of the so-called metric tensor. They determine the way how the frame of coördinates  $\xi$ ,  $\tau'$  of the co-moving observer is transformed

---

1. This equation is the "1+1-dimensional" form of Einstein's Geodesic Equation. It requires some effort to simplify the Geodesic Equation for a single spatial dimension. It is simpler to set-up the equation directly in a single spatial dimension and to check the result against Einstein's full format. Unfortunately the author does not know any reference apart from [4] where it is done so.



(by considering  $\xi(x, t')$  and  $\tau'(x, t')$  into the frame of coordinates  $(x, t')$  of the stationary observer. In particular:

$$\left(\frac{\partial \xi}{\partial x}\right)^2 + \left(\frac{\partial \tau'}{\partial x}\right)^2 = g_{xx} \quad \text{and} \quad \left(\frac{\partial \xi}{\partial t'}\right)^2 + \left(\frac{\partial \tau'}{\partial t'}\right)^2 = g_{tt}, \quad \text{with } \tau' = j c \tau. \quad (3-2a,b)$$

The geodesic equation is a result of Einstein's Principle of Equivalence that states that the forced movement of the particle seen by the stationary observer is seen as a free movement seen by the co-moving observer. Therefore the geodesic equation is nothing more than a transformation of the free movement equation by merely transforming the coordinates.

Note that the time parameter of the geodesic equation is the proper time. Note also that temporal and spatial parameters occur on par, i.e. both equations are fully symmetrical. This is a basic feature of relativistically invariant equations.

The parity is lost after introduction a basic step in further evaluation. This step is the assumption of stationary. This means that we shall assume that the elements of the metric tensor are independent of time. This has to do with the nature of the energy field in which the particle is supposed to move. In many cases, such as motions in free space, motions in a gravity field or in a static electromagnetic field, this assumption is justified. If however this static character is violated, for instance as a consequence of particular forms of particle interaction, a reconsideration will be necessary. Such reconsideration is beyond the scope of this paper.

Because of the stationary condition the geodesic equation simplifies to:

$$\frac{d^2 x}{d\tau^2} + \frac{1}{2g_{xx}} \left[ \frac{dg_{xx}}{dx} \left(\frac{dx}{d\tau}\right)^2 - \frac{dg_{tt}}{dx} \left(\frac{dt'}{d\tau}\right)^2 \right] = 0$$

and 
$$\frac{d^2 t'}{d\tau^2} + \frac{1}{g_{tt}} \frac{dg_{tt}}{dx} \left(\frac{dx}{d\tau} \frac{dt'}{d\tau}\right) = 0. \quad (3-3a,b)$$

The latter equation can be easily integrated, resulting in a linear differential equation:

$$\frac{dt'}{d\tau} = \frac{k_{int}}{g_{tt}}, \quad \text{wherein } k_{int} \text{ is an integration constant to be determined.} \quad (3-4)$$

In addition we may consider a redundant equation that makes further use of (3-3a) obsolete. This equation is the formulation of the invariance of the local space time interval, i.e.:

$$d\tau'^2 = g_{xx} dx^2 + g_{tt} dt'^2 \quad \text{so:} \quad \left(\frac{d\tau'}{d\tau}\right)^2 = g_{xx} \left(\frac{dx}{d\tau}\right)^2 + g_{tt} \left(\frac{dt'}{d\tau}\right)^2, \quad (3-5)$$

which is equivalent with 
$$g_{xx}\left(\frac{dx}{d\tau}\right)^2 + g_{tt}\left(\frac{dt'}{d\tau}\right)^2 = -c^2. \quad (3-6)$$

Applying (3-6) to (3-4) we get:

$$\left(\frac{dx}{d\tau}\right)^2 = \frac{1}{g_{xx}}\left[-c^2 - \frac{k_{int}^2}{g_{tt}}\right]. \quad (3-7)$$

It can be shown that elaboration on the basis of (3-3a) instead of (3-6) gives the same result. Equations (3-4) and (3-7) together form an excellent set to derive wave equations for a single spatial dimension by basic rules in which momenta are transformed into operators on wave functions.

If we formulate (3-7) and (3-4) in momentum notation we have:

$$\frac{p_0}{m_0} = \frac{k_0}{g_{tt}} \quad \text{and} \quad \left(\frac{p_x}{m_0}\right)^2 = \frac{1}{g_{xx}}\left[-c^2 - \frac{k_{int}^2}{g_{tt}}\right], \quad \text{wherein} \quad \frac{p_0}{m_0} = \frac{dt'}{d\tau} \quad \text{and} \quad \frac{p_x}{m_0} = \frac{dx}{d\tau}. \quad (3-8a,b)$$

From (3-8b) it follows that:

$$\frac{p_x}{m_0} = \pm \sqrt{\frac{1}{g_{xx}}\left[-c^2 - \frac{k_{int}^2}{g_{tt}}\right]}. \quad (3-9)$$

We now invoke the basic quantum mechanical hypothesis describing transform of momenta into operations on a wave function such that:

$$p_i \rightarrow \hat{p}_i \Psi \quad \text{with} \quad \hat{p}_i = \frac{\tilde{h}}{j} \frac{\partial}{\partial x_i}. \quad (3-A)$$

From (3-A) and (3-8) we obtain operator and differential equations:

$$\hat{p}_0 \Psi = \frac{\tilde{h} \partial \Psi}{j \partial x_0} = \frac{\tilde{h} \partial \Psi}{j \partial jct} = -\frac{\tilde{h} \partial \Psi}{c \partial t} = \frac{m_0 k_{int}}{g_{tt}} \Psi \quad \text{so:} \quad j \tilde{h} \frac{\partial \Psi}{\partial t} = -j c m_0 \frac{k_{int}}{g_{tt}} \Psi$$

and 
$$\hat{p}_x \Psi = \frac{\tilde{h} \partial \Psi}{j \partial x} = \frac{\tilde{h} \partial \Psi}{j \partial x} = \frac{\tilde{h} \partial \Psi}{j \partial x} = \pm \sqrt{\frac{1}{g_{xx}}\left[-c^2 - \frac{k_{int}^2}{g_{tt}}\right]} \Psi \quad \text{so:}$$

$$\frac{\tilde{h}^2}{m_0} \frac{\partial \Psi}{\partial x} = \pm j \tilde{h} \sqrt{\frac{1}{g_{xx}} \left[ -c^2 - \frac{k_{int}^2}{g_{tt}} \right]} \Psi. \quad (3-10)$$

As the curvature is assumed to be stationary we have:

$$j \tilde{h} \frac{\partial \Psi}{\partial t} = f_1(x) \Psi \quad \text{and} \quad \frac{\tilde{h}^2}{m_0} \frac{\partial \Psi}{\partial x} = \pm j f_2(x) \Psi$$

$$\text{with } f_1(x) = -j c m_0 \frac{k_{int}}{g_{tt}} \quad \text{and} \quad f_2(x) = \tilde{h} \sqrt{\frac{1}{g_{xx}} \left[ -c^2 - \frac{k_{int}^2}{g_{tt}} \right]}. \quad (3-11a,b)$$

How to compose out of these equations a single wave equation compatible with the Born interpretation (first order in temporal derivative) and locality for a probability packet (second order in the spatial derivative)? We are able to meet this goal as follows. First (3-11b) is differentiated with respect to  $x$  and added to (3-11a):

$$j \tilde{h} \frac{\partial \Psi}{\partial t} + \frac{\tilde{h}^2}{m_0} \frac{\partial^2 \Psi}{\partial x^2} = f_1(x) \Psi \pm j f_2(x) \frac{\partial \Psi}{\partial x} \pm j \frac{\partial f_2(x)}{\partial x} \Psi. \quad (3-12)$$

After that (3-11b) is applied on this expression resulting into:

$$j \tilde{h} \frac{\partial \Psi}{\partial t} + \frac{\tilde{h}^2}{m_0} \frac{\partial^2 \Psi}{\partial x^2} = f_1(x) \Psi - \frac{f_2^2(x)}{\tilde{h}^2} \Psi \pm j \frac{\partial f_2(x)}{\partial x} \Psi \quad (3-13)$$

$$\text{or:} \quad j \tilde{h} \frac{\partial \Psi}{\partial t} + \frac{\tilde{h}^2}{2m_0} \frac{\partial^2 \Psi}{\partial x^2} = V_r(x) \Psi \quad \text{with} \quad V_r(x) = f_1(x) - \frac{f_2^2(x)}{\tilde{h}^2} \pm j \frac{\partial f_2(x)}{\partial x}. \quad (3-14)$$

Suppose a tentative solution of the type:

$$\Psi(t, x) = \Psi_t(t) \Psi_x(x). \quad (3-15)$$

Then we can split (3-13) into:

$$j \tilde{h} \frac{1}{\Psi_t} \frac{d\Psi_t}{dt} = E \quad \text{and} \quad \frac{\tilde{h}^2}{2m_0} \frac{1}{\Psi_x} \frac{d^2 \Psi_x}{dx^2} = V_r(x) - E. \quad (3-16a,b)$$

Depending on the nature of the right hand part of (3-16b) we may get propagating or stationary non-propagating (“standing”) waves. Examples of the latter category are quantum mechanical oscillations, which occur if  $V(x)$  has the particular format  $V(x) = m\omega^2 x^2/2$ .

Notes:

The sign ambiguity of  $V_r(x)$  suggests two different solutions of the wave function. Later we shall come back on this. Another remark to be made is that the composition of the wave equation from the linear combination of two underlying ones is not unique. We have chosen this approach to arrive at the format (3-13) that is recognized as the relativistic version of Schrödinger’s equation (See [1]).

## 2.1 Simplification

We wish to proceed under two simplifications. The first of these is the *symmetry condition*. The validity of it will be proved in section 4. This condition is:

$$g_{tt}(x) = g_{xx}(x) = g_{00}(x). \quad (3-17)$$

(The proof will follow from symmetry in the electromagnetic energy momentum tensor).

The other simplification is the so-called *weak field condition*. This states that:

$$g_{00} = 1 + \Delta(x) \quad \text{with } |\Delta(x)| \ll 1. \quad (3-18)$$

This assumption is justified as long as the motion takes place in the area where the field is weak as compared to other regions. Under these conditions we get for (3-11):

$$f_1(x) \approx m_0 c^2 (1 - \Delta) \quad f_2(x) \approx j \tilde{\hbar} c \sqrt{\Delta} \quad \text{and} \quad \frac{df_2}{dx} \approx j \frac{\tilde{\hbar} c}{2\sqrt{\Delta}} \frac{d\Delta}{dx}. \quad (3-19)$$

Applying (3-19) on (3-14) we get:

$$V_r(x) = m_0 c^2 \pm \frac{\tilde{\hbar} c}{2\sqrt{\Delta}} \frac{d\Delta}{dx}. \quad (3-20)$$

Let  $y = \sqrt{\Delta}$  (3-21)

so that (3-20) is written as:  $V_r(x) = m_0 c^2 \pm \tilde{\hbar} c \frac{dy}{dx}$ . (3-22)

For the wave equation (3-14) we then may write, under consideration of (3-22):

$$j\tilde{h}\frac{\partial\Psi}{\partial t} + \frac{\tilde{h}^2}{m_0}\frac{\partial^2\Psi}{\partial x^2} = \left[ m_0c^2 \pm \tilde{h}c\frac{dy}{dx} \right] \Psi. \quad (3-23)$$

The non-relativistic limit of this equation can be written as:

$$j\tilde{h}\frac{\partial\Psi}{\partial t} + \frac{\tilde{h}^2}{2m_0}\frac{\partial^2\Psi}{\partial x^2} = \pm\tilde{h}c\frac{dy}{dx}\Psi. \quad (3-24)$$

Let us now discuss the sign ambiguity of the right hand part of the equation. Let us suppose a tentative solution of the type:

$$\Psi(t, x) = \Psi_t(t)\Psi_x(x). \quad (3-25)$$

Then we can split (3-23) into:

$$j\tilde{h}\frac{1}{\Psi_t}\frac{d\Psi_t}{dt} = E \quad \text{and} \quad \frac{\tilde{h}^2}{2m_0}\frac{1}{\Psi_x}\frac{d^2\Psi_x}{dx^2} = V_r(x) - E \quad \text{or} \quad (3-26a)$$

$$j\tilde{h}\frac{1}{\Psi_t}\frac{d\Psi_t}{dt} = E \quad \text{and} \quad \frac{\tilde{h}^2}{2m_0}\frac{1}{\Psi_x}\frac{d^2\Psi_x}{dx^2} = -V_r(x) - E. \quad (3-26b)$$

Equation (3-26a) has standing wave solutions for positive values for the energy parameter  $E$  and the potential function  $V_r(x)$ . In fact a positive sign for  $E$  is only required for the spatial part, because the Born interpretation allows for the temporal part a negative sign for  $E$  as well. More problematic is equation (3-16b). It produces standing waves only for negative values for the mass  $m_0$  and a negative value for the energy parameter  $E$ . In that case (3-16b) can be written as:

$$j\tilde{h}\frac{1}{\Psi_t}\frac{d\Psi_t}{dt} = E' \quad \text{and} \quad \frac{\tilde{h}^2}{2m'_0}\frac{1}{\Psi_x}\frac{d^2\Psi_x}{dx^2} = V_r(x) - E' \quad \text{with } E' = -E \quad \text{and } m'_0 = -m_0. \quad (3-27)$$

Equation (2-27) now has the same format as equation (2-16a). As stated above, a negative value for the energy parameter has no impact on the temporal part. How to interpret the ambiguity in the wave function? It expresses that valid wave equations are compatible with motions of massive particles with negative rest mass (if they would exist) as well.

#### 4.0 The metric tensor in terms of quantum mechanical parameters.

In the previous section we have obtained a quantum mechanical wave equation in terms of the metric tensor, albeit that the metric tensor is indirectly expressed in a parameter  $y$ . This parameter  $y$  can be easily translated into  $g_{ij}$  as we have from (3-17), (3-18) and (3-21):

$$g_{tt}(x) = g_{xx}(x) = 1 + y^2. \quad (4-1)$$

How to relate this with electromagnetism? We do so by invoking the model of the quark doublet [1]. This model describes the motion of a particle with mass  $m_p$  in a Higgs field. This field is supposed to be of magnetic origin and the particle is supposed to be sensitive only for the magnetic force. Two parameters, a first one  $\Phi_0$  with energetic dimension and a second one  $\lambda$  with a dimension  $m^{-1}$  characterizes the field. The energetic parameter can be expressed in terms of magnetic field energy. The wave equation of the particle is:

$$j\tilde{h}\frac{\partial\Psi}{\partial t} + \frac{\tilde{h}^2}{2m_p}\frac{\partial^2\Psi}{\partial x^2} = V_H(x)\Psi \quad \text{with } V_H(x) = \Phi_0\{k_0 + k_2(x\lambda)^2 + \dots\}. \quad (4-1)$$

Equations (3-24) and (4-1) are simultaneously true if  $m_0 = m_p$  and if

$$\pm\tilde{h}c\frac{dy}{dx} = \Phi_0\{k_0 + k_2(x\lambda)^2 + \dots\}. \quad (4-2)$$

Integration of this equation yields:

$$y = \pm\frac{2\Phi_0}{\tilde{h}c}\left(k_0x + \frac{2}{3}k_2\lambda^2x^3 + \dots\right). \quad (4-3)$$

Under consideration of (3-31):

$$\Delta \approx \left(\frac{2\Phi_0}{\tilde{h}c}\right)^2\left(k_0^2x^2 + \frac{4}{3}k_0k_2\lambda^2x^4 + \dots\right). \quad (4-4)$$

so, under consideration of (3-18):

$$g_{00} = g_{11} \approx 1 + \left(\frac{2\Phi_0}{\tilde{h}c}\right)^2\left(k_0^2x^2 + \frac{4}{3}k_0k_2\lambda^2x^4 + \dots\right). \quad (4-5)$$

That means that we have expressed now the metric tensor in terms of the Higgs field. The Higgs field is characterized by two parameters, i.e.  $\lambda$  and  $\Phi_0$ . Note that  $k_0$  ( $= -1/2$ ) and  $k_2$  ( $= 2,62$ ) are not parameters, but known constants. Note also that the Higgs field parameters are parameters of the spatial representation of the Higgs field. Canonically the Higgs field is expressed as a function of the wave function, which shows two parameters as well. The spatial expression however allows a more easy interpretation of the Higgs field [1]. In a subsequent section we shall show that it is not difficult to assign a quantitative value to one of the parameters ( $\lambda$ ). Assigning a quantitative value to  $\Phi_0$  will appear to be more problematic.

## 5.0 The Einstein tensor and the energy momentum tensor of the Higgs field.

### 5.1 The Einstein tensor

The results of the preceding section enables us to express the Einstein tensor ( $G_{ij}$ ) of Einstein's Field Equation (2-1) in terms of the Higgs field parameters  $\lambda$  and  $\Phi_0$ . The Einstein tensor is defined as:

$$G_{ij} = R_{ij} - \frac{1}{2}Rg_{ij}. \quad (5-1)$$

In case of Cartesian space time with a single spatial dimension rather simple expressions for the Ricci tensor  $R_{ij}$  and the Ricci scalar  $R$  are obtained. For the Ricci tensor we may write [5,4]<sup>1</sup>

$$R_{tt} = -\frac{1}{2}\frac{g_{tt}''}{g_{xx}} + \frac{1}{4}\frac{g_{tt}'}{g_{xx}}\left(\frac{g_{tt}'}{g_{xx}} + \frac{g_{tt}'}{g_{tt}}\right), \quad R_{xx} = -\frac{1}{2}\frac{g_{tt}''}{g_{tt}} + \frac{1}{4}\frac{g_{tt}'}{g_{tt}}\left(\frac{g_{xx}'}{g_{xx}} + \frac{g_{tt}'}{g_{tt}}\right), \quad R_{tx} = R_{xt} = 0. \quad (5-2)$$

(Note: the symbols ' and '' stand for differentiation and double differentiation after the spatial parameter  $x$ )

Under the symmetry condition (to be discussed below) we have:

and therefore:

$$R_{tt} = R_{xx} = R_{00} = -\frac{1}{2}\frac{g_{00}''}{g_{00}} + \frac{1}{2}\frac{g_{00}'^2}{g_{00}^2}. \quad (5-3)$$

The Ricci scalar is:

$$R = \sum_{i=0}^1 \sum_{j=0}^1 g^{ij}R_{ij} = 2g_{00}R_{00}. \quad (5-4)$$

Note:  $g^{ij}$  is the inverse matrix of  $g_{ij}$ . From (5-3) and (4-5) it follows that:

---

1. This expression, or equivalent, can be found in many textbooks on General Relativity. The format as shown here is most easily recognized in [5,4]

$$g_{00}' \approx 2k_0^2 x \left( \frac{2\Phi_0}{\hbar c} \right)^2 \quad g_{00}'' \approx 2k_0^2 \left( \frac{2\Phi_0}{\hbar c} \right)^2 \quad (5-5)$$

so:

$$R_{00} \approx -k_0^2 \left( \frac{2\Phi_0}{\hbar c} \right)^2 + \frac{1}{2} k_0^4 x^2 \left( \frac{2\Phi_0}{\hbar c} \right)^4. \quad (5-6)$$

For the Einstein tensor we may write under consideration of (5-4) and (3-18):

$$G_{00} = R_{00} - \frac{1}{2} R g_{00} = R_{00} (1 - g_{00}^2) = R_{00} \{1 - (1 + 2\Delta)\} = -2\Delta R_{00}, \quad (5-7)$$

wherein  $\Delta$  is given by (4-4). From (5-6) and (5-7) we obtain:

$$G_{00} \approx 2k_0^4 \left( \frac{2\Phi_0}{\hbar c} \right)^4 x^2. \quad (5-8)$$

## 5.2. The energy momentum tensor

The right-hand part of Einstein's Field equation is described by the energy momentum tensor. The electromagnetic equivalent determines electromagnetic field density. In the Higgs field the magnetic field dominates largely over the electric field (if there is any). The calculation from (2-2) shows that:

$$T_{00} = T_{11} = \frac{1}{2} \mu_0 H^2(x) \quad \text{and} \quad T_{10} = T_{01} = 0. \quad (5-9)$$

Inspection of Einstein's Field Equation under consideration of (5-9) and (5-2) shows that the equation can be satisfied for all  $x$  if and only if

$$g_{tt}(x) = g_{xx}(x) = g_{00}(x). \quad (5-10)$$

That means that the previously adopted symmetry condition is fulfilled indeed.

From [1] we know that:

$$B(x) = \frac{g}{c q_e} \frac{d\Phi}{dx} \quad \text{wherein} \quad q_e^2 = 2\varepsilon_0 \tilde{\hbar} c g^2. \quad (5-11a,b)$$

and  $B = \mu_0 H$ ,  $g$  the universal quantum mechanical coupling and  $q_e$  the elementary electric charge. As  $\Phi(x)$  is the Higgs field as expressed by (4-1), we have



$$B(x) = \frac{g\Phi_0}{cq_e}(2k_2\lambda^2x + 4k_4\lambda^4x^3 + \dots) = \mu_0H(x) \quad (5-12)$$

so with (5-9):

$$T_{00} = \frac{1}{2}\mu_0H^2(x) = \frac{1}{2}\mu_0\left(\frac{g\Phi_0}{\mu_0cq_e}\right)^2(4k_2^2\lambda^4x^2 + \dots) \quad (5-13)$$

and, under consideration of (5-11b):

$$T_{00} \approx 2k_2^2\lambda^4x^2\frac{\Phi_0^2}{\hbar c}. \quad (5-14)$$

## 6.0 The gravitational constant

It is now possible to express the gravitational constant in terms of the quantum mechanical parameters  $\lambda$  and  $\Phi_0$ . As is obvious from (5-12) these parameters are in fact electromagnetic parameters. Substitution of (5-14) and (5-8) into (2-1) gives:

$$2k_0^4\left(\frac{2\Phi_0}{\hbar c}\right)^4 = \frac{8\pi G}{c^4}2k_2^2\lambda^4\frac{\Phi_0^2}{\hbar c} \quad (6-1)$$

$$\text{so} \quad G = \frac{2}{\pi}\frac{k_0^4}{k_2^2\lambda^4}\frac{\Phi_0^2c^4}{(\hbar c)^3} \quad \left(\frac{[m^3]}{[kg][s^2]}\right). \quad (6-2)$$

If we would know the quantummechanical parameters we would be able to check if the theory as presented is correct. Let us see if it possible to assign meaningful values to these parameters. For  $\lambda$  a fair guess can be made. This is possible, as we know the energy  $m'_W$  of the W-bosons. This energy is about 80,4 GeV. This figure is one of the basic parameters in the Standard Model. Assuming near light velocity of these bosons and supposing that the boson energy is subject to the Heisenberg constraint  $E\Delta t \geq \hbar$ , and considering that  $2d_0 \approx c\Delta t$ , where  $d_0$  is the doublet spacing, we have:

$$m'_W = E = \frac{\hbar c}{2d_0}. \quad (6-3)$$

Defining  $d_0 \lambda = d'_{min}$  (6-4)

so from (6-3) and (6-4):  $\lambda = \frac{2d'_{min}m'_W}{\hbar c}$ . (6-5)

As we know the boson energy (80,4 GeV) and the value of  $k_0$  we may establish the  $\lambda$  value from (6-5). What about  $\Phi_0$ ?

From [1] we know that:

$$\Phi_0 = \frac{m'_p}{8k_0^2 k_2}. \quad (6-6)$$

Insertion of (6-5) and (6-6) into (6-2) yields:

$$G = \frac{1}{32\pi} \left( \frac{c}{2d'_{min}k_2} \right)^4 \left( \frac{m'_p}{m'_W} \right)^2 \frac{\hbar c}{m'^2_W}. \quad (6-7)$$

What do we know about  $m'_p$ ? Note that this value in fact stands for the parameter  $\Phi_0$ . We have modeled this mass as condensed electromagnetic energy. There is experimental evidence that the quark doublet fully decays into electromagnetic particles, such as leptons as muons and electrons with bosons as intermediate. This however does not imply that it is justified to equate  $m'_p$  unconditionally with the energy  $m'_W$  of the boson. The energy semantics are different, because the energy of the particle with  $m'_p$  is supposed to be real, while the boson with energy  $m'_W$  is virtual as this type of energy can only exist within a time interval as imposed by Heisenberg's uncertainty principle.

In spite of the fact that  $m'_W$  represents the energy of a virtual particle, the value itself is not virtual as it is nothing else than a measure for the distance between the quarks in the quark doublet (as expressed by 6-4 and 6-5). The problem of virtuality shows up if we suppose that  $m'_p/m'_W = 1$ . This assumption has been used in [1] to give an explanation for the algorithmic ratio between the masses of leptons even to extent to the prediction for the mass of the next lepton to be found. In fact it is  $m'_p$  which has to be handled with care. One might suppose that the energy of the quark doublet has a structural component and a non-structural component. There is so to say a steady state value of the mass (rest mass)  $m'_{0p}$  and a short-time value. The steady state value can be stirred up to a value that equates  $m'_W$ , resulting in an emission of a short living boson. It is therefore only the short-time component that is relevant for the theory for the leptonic algorithm, justifying a short-term ratio  $m'_p/m'_W = 1$ . This should be distinguished from the structural value. A

better formulation is to state that within the Heisenberg time interval the energy  $m'_p$  (and therefore  $\Phi_0$ ) is indefinite. There is therefore no conflict between the condition  $m'_p/m'_W = 1$  for the Heisenberg interval and quite another structural value  $m'_{0p}/m'_W$ .

In fact no instruments are available to estimate a value for  $m'_{0p}$ . What we could do is to play the game inversely, i.e. to establish the rest mass from the known figure of the gravitational constant and the analytical result (6-7). The result of the calculation is shown in table I.

**Table 18:**

parameters	doublet rest mass
$G \approx 6,67 \times 10^{-11} \text{ m}^3 \text{ kg}^{-1} \text{ s}^{-2}$	$m'_{0p} \approx 1,52 \times 10^{-6} \text{ eV}$
$c \approx 3 \times 10^8 \text{ ms}^{-1}$	
$\hbar c \approx 197,3 \text{ MeV fm}$	
$m'_W \approx 80,4 \text{ GeV}$	
$d'_{min} \approx 0,84$	
$k_2 \approx 2,62$	

Is this all true? To credibility of this theory would increase if some relation can be found between this value of the doublet rest mass with some parameter of the Standard Model. The rest mass value is very tiny. The tiniest masses of Standard Model parameters are those of the (anti-)neutrinos, which still exceed significantly the mass value as calculated here. However mass can only be established as observable mass. As ultra light particles are difficult to decelerate, the mass figure can only be appreciated if the velocity of the particle is known. As we may expect that velocities be near to the velocity of light, the observable equivalent of  $m'_{0p}$  can indeed exceed the calculated value by orders of magnitude. Anyhow to relate the result of table I with some experimental evidence is difficult to make.

There is however something else. From (6-7) we see that  $m'_{0p}$  is proportional with  $k_2^2$ . So,  $m'_{0p}$ -values associated with electrons, muons and tauons are different and can be ratioed. In table 2 the calculated ratios are listed such that muons (anti-)neutrinos are compared with electron (anti-)neutrinos and tauon (anti-)neutrinos are compared with muon (anti-)neutrinos. A prediction for the (anti-)neutrino of the next lepton is added. The calculated values follow from fig.11 of [1].

**Table 19:**

	electron	muon	tauon	next lepton
$d$	0,84	0,16	0,08	
$k_2$ -ratio	1	200	16,16(18)	
$m'_{0p}$ -ratio	1	$4 \times 10^4$	324	37
present estimations	1	$6,8 \times 10^4$	106	

These mass ratios are not accurately known in canonic theory. Estimations are listed in [6]. The figures of the calculated figures of the theory presented in this paper correspond in order of magnitude. This result is rather satisfactory, taking in mind that no precision is claimed (consider for instance the first order approximation in 5-13).

Unfortunately a gauge to translate the ratios into numerical values of masses is still missing. What can be said though is that the theory as presented in this document shows a way to relate the curvature of time space with the energy momentum content comprised in it, similarly as Einstein did, i.e. by setting up an equation with curvature at one side of the equation and energy momentum at the other side and equating the two by a proportionality constant. It has to be noted that in Einstein's Field Equation the constant is nothing else than a gauge constant by conditioning that the weak-field solution of this equation has to be identical with Newton's law. So far an easy instrument for gauging is lacking in the theory as we developed in this document. Therefore there is no final proof that the constant equals the gravitational constant as can be expected if Einstein's Field Equation is generic for all forms of energy. Nevertheless the fair correspondence of the calculated ratios between the (ant-)neutrinos with the estimated values as presently available from experimental evidence gives a rather strong support for the validity of the theory.

It is one of the two: either Einstein's law is generically applicable to all forms of energy in the sense that equal amounts of energy, be it electromagnetic, be it gravity mass, curves space time to the same amount, either it does not, in the sense that the amount of curvature is different for different forms of energy. In the former case the (equivalents of) gravitational constants must be the same for all forms of energy. In the latter case this will not be the case.

How to explain the result if it is assumed that Einstein's law is generic? Two particles with tiny masses (half of  $m_{0p}$ ) click together (as a result of a magnetic force). The energetic value of these masses is the energy of their magnetic fields. After the click of the two masses it requires more energy to separate them than the energetic value of the masses themselves. It is a consequence of the binding force that manifests itself as a vibration of the two masses, or, in other terms as a consequence of the ground state energy of a quantum mechanical (an)harmonic oscillator. This can also be explained as the energy of an electric field associated with the spin of the motion. If the energy of the doublet is enhanced due to an external influence, the energy of the doublet evapo-

rates as a boson, which decays in an electric component (lepton) and some tiny rest mass (lepton-neutrino). For details of this model see [2].

## 7.0 Summary

This document is the third of a series of documents. The contents of these documents are captured by their titles, respectively:

1. On the existence of the magnetic monopole and the non-existence of the Higgs particle
2. On the structure of matter
3. On the relationship between Gravity and Electromagnetism

The theory gives an explanation for several phenomena of Quantum Theory for which the present canonic theory has no answer. Among these are:

- explanation why the Higgs particle has not been found
- explanation for the relationship between gravity and electromagnetism
- explanation for the discreteness of fields and charges
- explanation for the mass relationships of the leptons
- explanation for the (a)symmetry of Maxwell's equations
- explanation for the nature of electrons
- explanation for the nature of (anti-)neutrinos

The theory has been developed by means of two instruments. The first is the transform of the functional format of the Higgs field into a spatial format. Even if the theory as developed in the three documents appears to contain flaws, this transform may well appear to be an eye-opener for outstanding problems in Quantum Theory. The transform is made in a straightforward mathematical way and has no speculative elements. The second instrument is the application of Dirac's generalization of Maxwell's law. This instrument is hypothetical, so predictive results of the theory developed are required to justify the hypothesis. The most concrete prediction is for the mass of the next lepton to be found (ca.  $12,2 \text{ GeV}/c^2$ ). The failure to find the Higgs particle is predicted as well, but hard-believers will probably persist.

In many aspects, the instruments and results of canonic theory, i.e. the Standard Model, are not affected. However our documents are by no means detailed enough to claim this generically. The most significance difference possibly is the symmetric structure of quark doublets and quark triplets. Where in canonic Chromo dynamics quarks are charged asymmetrically by  $2/3$  and  $1/3$  this is not in the theory as developed in our papers where full symmetry is adopted.

It has been shown in this paper that the spatial formulation of the Higgs field enables to relate space time curvature with the energy momentum content of the field, similarly as in Einstein's Field Equation. This means that Quantum mechanics can be related with General Relativity. Unfortunately a full proof for the unification of quantum mechanics, electromagnetism and grav-

ity still lacks a gauge to show full equivalence of the proportionality constant involved with the gravitational constant.

The theory as presented in the three papers lacks the rigid mathematical structure  $U(1) \otimes SU(2) \otimes SU(3)$  of the Standard Model. The three gauge fields have not been discussed in terms of non-Abelian Group Theory, but merely in Abelian basic mathematics and mostly in time space with a single spatial dimension. If there is merit in the theory, rigid mathematics can be added later. The main purpose has been to gain some physical understanding of these matters, as these are usually masked by complex formal mathematics. This formal mathematics are fine and impressive, but the complexity of it may turn out to be a roadblock for removing non-understood subjects. Therefore a more qualitative approach, like presented here, might be a useful supplement.

## References

- [1] E.Roza, “On the existence of the magnetic monopole and the non-existence of the Higgs particle, <http://arxiv.org/ftp/arxiv/papers/0811/0811.0286.pdf>
- [2] E.Roza, “On the structure of matter”, to be archived
- [3] “The electromagnetic energy tensor”, <http://farside.ph.utexas.edu/teaching/jk1/lectures/node29.html>
- [4] E. Roza, “Ruimte, Tijd en Energie, 100 jaar Relativiteitstheorie”, p.61-64, ISBN 90-9019549-1, Liberoosa Valkenswaard
- [5] W.A. van Leeuwen, “Algemene Relativiteitstheorie I”, p. 50, <http://soliton.science.uva.nl/~leeuwen/art.pdf>
- [6] <http://nl.wikipedia.org/wiki/Neutrino>