

Towards Realistic String Vacua From Branes At Singularities

Joseph P. Conlon¹, Anshuman Maharana², Fernando Quevedo^{2,3}

¹*Rudolf Peierls Center for Theoretical Physics, 1 Keble Road, Oxford OX1 3NP, UK*

²*DAMTP, Centre for Mathematical Sciences,
Wilberforce Road, Cambridge, CB3 0WA, United Kingdom*

³*CERN Theory Division, CH-1211, Geneva 23, Switzerland*

ABSTRACT: We report on progress towards constructing string models incorporating both realistic D-brane matter content and moduli stabilisation with dynamical low-scale supersymmetry breaking. The general framework is that of local D-brane models embedded into the LARGE volume approach to moduli stabilisation. We review quiver theories on del Pezzo n (dP_n) singularities including both D3 and D7 branes. We provide supersymmetric examples with three quark/lepton families and the gauge symmetries of the Standard, Left-Right Symmetric, Pati-Salam and Trinification models, without unwanted chiral exotics. We describe how the singularity structure leads to family symmetries governing the Yukawa couplings which may give mass hierarchies among the different generations. We outline how these models can be embedded into compact Calabi-Yau compactifications with LARGE volume moduli stabilisation, and state the minimal conditions for this to be possible. We study the general structure of soft supersymmetry breaking. At the singularity all leading order contributions to the soft terms (both gravity- and anomaly-mediation) vanish. We enumerate subleading contributions and estimate their magnitude. We also describe model-independent physical implications of this scenario. These include the masses of anomalous and non-anomalous $U(1)$'s and the generic existence of a new hyperweak force under which leptons and/or quarks could be charged. We propose that such a gauge boson could be responsible for the ghost muon anomaly recently found at the Tevatron's CDF detector.

Contents

1. Introduction	2
2. Local Model Building	4
2.1 Generalities	4
2.2 Branes at Singularities	6
2.3 Del Pezzo 0	9
2.3.1 Standard Model	11
2.3.2 Left-Right Symmetric Models	13
2.3.3 Pati-Salam Models	14
2.3.4 Trinification Models	15
2.4 Del Pezzo 1	17
2.4.1 Standard and Left-Right Symmetric dP_1 Models	19
2.5 Higher del Pezzos	20
3. Global Embeddings	20
3.1 Local/Global Mixing	20
3.2 Towards Fully Global Models	23
3.3 Effective Field Theory Near the Singularity	25
3.4 Phenomenological Features	27
3.4.1 Hyperweak Forces	27
3.4.2 Masses of anomalous and non-anomalous $U(1)$ s	30
4. Supersymmetry Breaking in Global Embeddings	32
4.1 Gravity Mediation	32
4.2 Anomaly Mediation	35
4.3 Gauge Mediation	36
4.4 Summary	36
5. Conclusions	36
A. Non-anomalous $U(1)$ in the dP_1 quiver	38

1. Introduction

String vacua aiming to describe the real world must cross various hurdles. Among these *pontes asinorum* are the requirements that the low energy particle content incorporate the Standard Model and that the compactification geometry is stabilised with all geometric moduli being massive. The vacuum must also break supersymmetry in such a way that Bose-Fermi splitting is not much smaller than 1 TeV. While actual TeV-scale supersymmetry is not essential for viability, it is a phenomenologically attractive feature and for our purposes we shall assume its correctness.

String theory has seen much separate effort on constructing either chiral models of particle physics or stabilised vacua. The construction of models with a chiral matter content resembling the Standard Model dates from the earliest work on heterotic compactifications. While no one model is compelling, the heterotic string remains a promising arena for model-building with a steady development in the technical tools available. Examples of recent work in this direction include [1–4]. More recently the discovery of D-branes provided new possibilities for model-building through intersecting branes in both IIA and IIB string theory. D-brane model building is now an extensive subject and is well covered by review articles such as [5–7].

Branes at singularities of a Calabi-Yau manifold provide an interesting class of chiral quasi realistic models. They are local models and therefore many of their properties do not depend on the global structure of the compactification and are expected to survive a full compactification including moduli stabilisation. Local model-building was initiated by Aldazabal, Ibáñez, Quevedo and Uranga in [8]. These authors studied models of D3 and D7 branes at orbifold singularities including, in detail, the $\mathbb{C}^3/\mathbb{Z}_3 \equiv dP_0$ singularity, with the gauge group supported on fractional D3 branes. More recent examples of local model-building include [9–13]. In recent years, partly motivated by the AdS/CFT correspondence, substantial progress has been made on the understanding and classification of Calabi-Yau singularities, mostly on toric singularities. General classes have been classified, such as the $Y_{p,q}$ and $L_{a,b,c}$ singularities [14]. Powerful techniques using quiver and dimer diagrams have been developed that allows to go beyond the simple orbifold singularities studied in [8] in computing the spectrum of matter fields and the effective superpotential. It is then worth exploring the potential phenomenological implications for local D-brane model building of more general singularities.

The construction of stabilised vacua has also received much attention in recent years, and progress is reviewed in [15, 16]. Such constructions tend to require the use of fluxes and non-perturbative effects to stabilise moduli. Arguably the best understood models are those of IIB flux compactifications, where the fluxes stabilise the dilaton and complex structure moduli [17] and non-perturbative effects are required to stabilise the Kähler moduli. The simplest constructions of stabilised vacua (for example KKLТ [18]) are however often supersymmetric, at relatively small volumes and with a flux superpotential tuned to many orders of magnitude to obtain a reliable minimum and a small gravitino mass. This renders control over the α' expansion marginal and makes them relatively less at-

tractive starting points for low-energy supersymmetric phenomenology. These problems can be evaded by the LARGE volume models of [19,20]. These incorporate α' corrections into the Kähler potential and thereby generate a stable minimum at exponentially large values of the volume. Such models stabilise moduli deep in the geometric regime while also generating dynamical low-scale supersymmetry breaking.

As the soft terms are induced by the moduli F-terms this falls under the heading of gravity mediation (or more precisely moduli mediation). Gravity mediation occurs naturally in string theory and is attractive as a supersymmetry breaking mechanism for its directness and its calculability.¹ In principle supersymmetry could also be communicated to the visible sector by gauge interactions. This is an interesting alternative that naturally gives flavour universality of soft breaking terms. However in addition to the usual phenomenological and calculational problems (excessive CP violation, problems with the Higgs potential and the computational difficulties of strongly coupled gauge theories), gauge mediation in string theory is hard to realise in a controlled fashion incorporating moduli stabilisation. For a recent careful analysis of the potential of realising gauge mediation in string theory, see [23].

An important task is to combine moduli stabilisation with realistic chiral matter sectors (for previous studies in this direction see [24–27]). Such a combination will allow a test of the assumptions that have gone into each side of this construction and may also suggest new phenomenological possibilities. Ideally one would hope to simply bolt together a scenario of moduli stabilisation with a D-brane MSSM-like model. However, Blumenhagen, Moster and Plauschinn have recently in [28] pointed out an important obstruction to this, in that the requirement of chirality constrains the techniques used for moduli stabilisation. Specifically, in D-brane models the chiral nature of the Standard Model implies that instantons cannot be used to stabilise the Standard Model cycle.

The basic aims of this paper are to make progress towards models which combine realistic matter sectors, full moduli stabilisation and controlled dynamical low-energy supersymmetry breaking. The structure of this paper will be as follows. In section 2 we will discuss local models, as first introduced in [8]. We review the philosophy of local model building and give various new models of D3/D7 branes at del Pezzo singularities, including non-vanishing hierarchical Yukawa couplings. In section 3 we outline how such models can be embedded into global moduli-stabilised compactifications, explaining how such local models may allow the problems of [28] to be evaded. We provide conditions on the Calabi-Yau geometry for such global embeddings to be realised. In 4 we discuss soft terms in this framework. Embedded into the large volume framework, the use of branes at singularities leads to a remarkable cancellation of all leading-order soft terms (both gravity- and anomaly-mediated). We enumerate the possible sub-leading contributions but do not attempt a full phenomenological analysis.

¹There is a challenge of flavour non-universality unless - as holds for example for Kähler moduli in IIB string compactifications [21,22] - the moduli fields responsible for supersymmetry breaking do not appear in the Yukawa couplings.

2. Local Model Building

2.1 Generalities

Phenomenological string models can be either global or local. The basic distinction is that for local models there is a limit in which the Standard Model gauge couplings remain finite while the bulk volume is taken to infinity. For global models, the canonical examples of which are Calabi-Yau compactifications of the weakly coupled heterotic string, all gauge couplings vanish in the limit that the bulk volume is taken to infinity. We will focus on IIB string theory with D3/D7 branes, in which case the MSSM gauge interactions are supported on 7-branes wrapping 4-cycles. In this case for local models the 4-cycles on which the MSSM is supported are vanishing cycles, which can be collapsed to give a Calabi-Yau singularity. Local models may equally well be constructed either at the singular locus or on the resolution. The simplest case has only a single resolving 4-cycle, in which case the 4-cycle is necessarily of del Pezzo type and the singularity is a del Pezzo singularity.²

The use of local models is in fact forced upon us in the LARGE volume moduli stabilisation scenario of [19, 20]: if the volume is exponentially large, the known sizes of the Standard Model gauge couplings imply that any construction of the Standard Model is necessarily local.

Local models have various technical advantages. In global models, the chiral matter spectrum depends on the full geometry of the compact space and cannot be computed until all global tadpoles and anomalies have been canceled. In local models, the chiral matter is determined by only a small region of the geometry. While for consistency bulk tadpoles must still be canceled, the details of this do not affect the chiral matter content and interactions of the local model. Local models also allow realistic matter content and coupling with a bulk volume deep in the geometric regime. For global models, it has long been known that the observed size of the Standard Model couplings implies that either the α' or g_s expansion is not well controlled [29].

One of the principal attractions of local models is their separation between local and bulk degrees of freedom. However it is important to distinguish between phenomenological questions that can be addressed locally and those that require some knowledge of the bulk physics.

What can be studied locally

Many phenomenological quantities can be determined purely locally. These include:

1. The gauge groups and matter content: these are determined solely by the number of branes wrapping the local cycles and their topological flux and intersection numbers.

²We recall that the del Pezzo surfaces, dP_n for $n = 0, 1, 2, \dots, 8$ correspond to the blow-up into \mathbb{P}^1 s of n points on $\mathbb{P}^2 \equiv dP_0$.

2. The Wilsonian gauge couplings defined at the string scale. For D7 branes wrapping collapsible cycles, these are determined purely by the values of the dilaton S , the size of the collapsing 4-cycle T , and the 2-forms $\int B_2$ on 2-cycles inside the collapsing 4-cycle. All these quantities are local.
3. The high-scale interactions between the massless modes, including Yukawa couplings. To leading order, these are determined entirely by the local geometry and the local singularity.
4. The approximate global flavour symmetry groups, which follow purely from the local geometry. As an example, for branes at the $\mathbb{C}^3/\mathbb{Z}_3$ singularity the interactions of (33) states are governed by an approximate $SU(3)$ global flavour symmetry.

What can not be studied locally

There are also many features that cannot be computed locally and require some knowledge of the whole compactification. In general this category includes all dimensionful scales. The essential reason is that in string theory all dimensionful scales derive from the string scale, which is in turn derived from the bulk volume using $m_s = g_s M_P / \sqrt{\mathcal{V}}$, and therefore requires knowledge of the global geometry.³ Phenomenological features that cannot be computed in a purely local framework include:

1. The scale of the cosmological constant: all sectors contribute to the vacuum energy and all contributions are additive. The answer is dominated by the size of the largest contribution.
2. Moduli stabilisation. Addressing the moduli problem of string compactifications clearly requires a global approach, especially for the closed string moduli that probe the full compactification geometry.
3. The scale of supersymmetry breaking. As for item 1 above, any sector of the compactification can break supersymmetry and contribute to supersymmetry breaking. The contributions to visible soft masses are additive and dominated by the largest contribution. Ensuring low-scale supersymmetry breaking requires global rather than local control.
4. The high-scale entering the phenomenological RGEs. The structure of MSSM soft terms and gauge couplings depends crucially on the high scale from which the running starts. This is the string/Kaluza-Klein scale and so depends on the global embedding.
5. The value of the axion decay constant. In string theory the axion-matter coupling is a non-renormalisable coupling. The axion decay constant is typically the string scale and in any case is always compactification-dependent.

³We work with the conventional Einstein-Hilbert general relativity action, in which case the 4d Planck scale is fixed and the string scale is a derived quantity.

6. The suppression scale for non-renormalisable operators (this includes item 5 above). An important example of such an operator is the suppression scale Λ entering the quartic $\frac{1}{\Lambda} H_u H_u L L$ neutrino mass term. Depending on the particular operator, this may be the string scale, the Planck scale, or somewhere in between.
7. Early universe cosmology, such as attempts to derive inflation and reheating or other scenarios from string theory, necessarily requires the dynamics of moduli stabilisation and therefore cannot be approached locally.

The most important of these examples is probably that of supersymmetry breaking. Viable models of supersymmetry breaking require Bose-Fermi mass splittings not smaller than 1TeV, and models with *any* source of supersymmetry breaking much larger than this fail to provide a solution to the hierarchy problem based on supersymmetry. In supergravity the scale of Bose-Fermi splitting is set by the gravitino mass, $m_{3/2} = e^{K/2} W$. In string theory the gravitino mass is a dynamical function of all fields present in the compactification, not only those contained within the local model.

For example, instantons often generate non-perturbative contributions to the superpotential. A single hidden-sector instanton, geometrically far separated from the local model and with amplitude as small as $e^{-S} \sim 10^{-13} \in e^{K/2} W$, will give a contribution to Bose-Fermi splitting one hundred times larger than that dictated by the mass of the Higgs. A consistent study of supersymmetry breaking therefore always requires the global compactification, as any local model of supersymmetry breaking can be washed out by such global effects. This point is illustrated in figure 1.

We then emphasise that efforts towards a purely local description of supersymmetry breaking, such as those based on pure gauge mediated supersymmetry breaking scenarios can be justified only under strong assumptions on the gravitational degrees of freedom. For example, most gauge mediation models introduce the gravitino mass - which is a function of the moduli - as a new *ad hoc* scale $m_{3/2} \lll M_P$. A natural mechanism of moduli stabilisation at an almost Minkowski compactification without breaking supersymmetry is yet to be found.

2.2 Branes at Singularities

Having restricted to the class of local models, we can further distinguish based on whether or not the local spacetime is geometric. A supersymmetric model requires the constituent branes to be stable D-flat BPS objects that will not decay. However the identification of such branes is well known to depend on the locus in moduli space and may change across lines of marginal stability. In the geometric regime, the D-flatness conditions require world-volume gauge bundles to satisfy $J \wedge F = 0$. It is also necessary that objects wrapping a given 4-cycle carry the same RR charge - branes and antibranes are mutually non-supersymmetric.

In the limit of small Kähler moduli these conditions are modified. At a singularity both ‘branes’ and ‘antibranes’ - objects wrapped on the collapsed cycle and carrying opposite RR charge with respect to this cycle - can be mutually supersymmetric. In this limit the allowed interactions between supersymmetric branes is very different from the geometric limit. In particular, for supersymmetric magnetised branes wrapped on finite-volume del Pezzos, all Yukawa couplings for the induced chiral matter vanish [11, 30]. However in the singular limit this is no longer true and such Yukawa couplings are generically non-vanishing.

Partly for this reason, in this paper we will focus on local model-building at the singular locus. The singular locus also turns out to be attractive for reasons of moduli stabilisation in a global context. We shall elaborate on this point in sections 3 and 4.

The allowed types of supersymmetric branes at a singularity has been extensively studied. These are the fractional branes, which come in two types. The first type is that of fractional D3 branes (magnetised D7 branes wrapped solely on the collapsing cycle). The second type is that of fractional D7 branes (bulk D7 branes that wrap both bulk and collapsed cycles). All such fractional branes are wrapped on the collapsed cycle, carry twisted Ramond-Ramond charge and cannot move away from the singularity. They may recombine into a bulk brane, with no twisted charge, which can move away from the singularity.

The matter content for such intersecting brane models comes in bifundamentals and is determined by the topological intersection of a pair of supersymmetric branes. This matter content is simply expressed through a quiver diagram. For the case of fractional D3 branes, the quiver diagram and superpotential for dP_0 was computed in [31], that for dP_1 , dP_2 and dP_3 in [32] and that for dP_4 through dP_8 in [33]. The inclusion of fractional

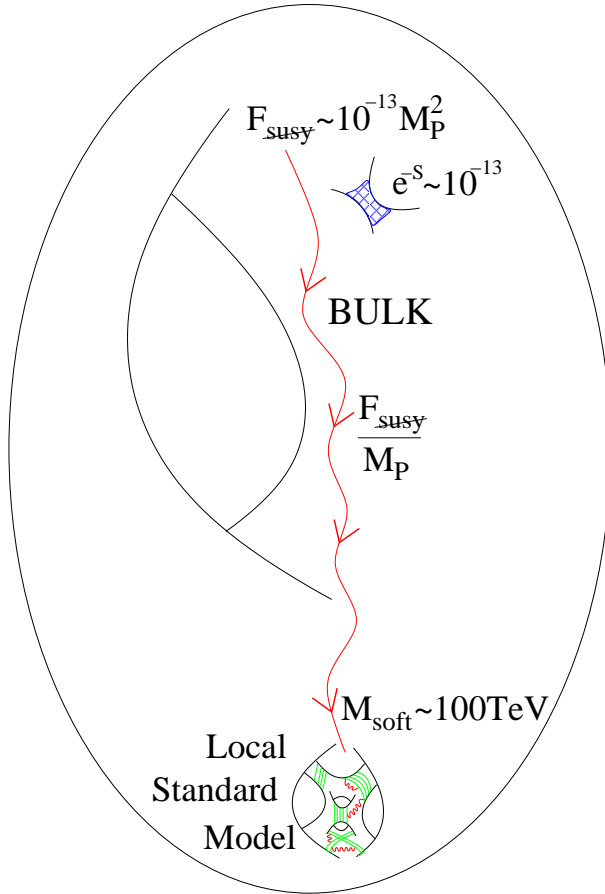

Figure 1: Why it is not consistent to study supersymmetry breaking purely locally. The presence of a hidden D3-instanton appearing in the gauge-invariant superpotential $e^{K/2}W$ with amplitude $e^{-S} \sim 10^{-13}$ gives a gravitational contribution to Bose-Fermi splitting of order $\Delta m \sim (10^{-13} M_P) \sim 100\text{TeV}$. Any such effect, whose presence or absence can only be determined globally, entirely washes out all TeV contributions of local supersymmetry breaking.

D7 branes into the quivers is described in general, and in detail for dP_1 , in [34].

The matter content and superpotential of such theories may be efficiently encoded using the technology of dimer diagrams. These also allow a simple description of the effect of introducing fractional D7 branes into the theory. We will not directly use dimer diagrams in this paper and will instead simply write down the appropriate superpotential. The interested reader can consult the appendix of [34] which describes dimer diagrams and in particular how they allow a general description of fractional D7 branes and their interactions.

The del Pezzo spaces can be viewed as \mathbb{P}^2 blown up at n separate points. \mathbb{P}^2 admits an action $PGL(3, \mathbb{C})$ on the projective coordinates (z_1, z_2, z_3) , preserving the complex structure of \mathbb{P}^2 . $PGL(3, \mathbb{C})$ has eight complex parameters, of which two are used in fixing the position of each blow-up. Once all parameters are exhausted the location of the blow-up represents a complex structure modulus, and thus dP_n has $(2n - 8)$ complex structure moduli. dP_0 is \mathbb{P}^2 and has the canonical Fubini-Study metric with $SU(3)$ isometry. The isometry group is reflected in the flavour symmetry of the quiver. As points are progressively blown up this flavour symmetry is reduced, to $SU(2) \times U(1)$ for dP_1 and $U(1)$ for dP_2 . For higher del Pezzos, there are no flavour symmetries of the superpotential, and for $n > 4$, the superpotential (and thus the Yukawa couplings) depend on the complex structure moduli.

In principle the MSSM may arise from any configuration of supersymmetric branes at any singularity. However, there are many singularities and a global search may not be most productive. We shall organise our analysis using two general principles: triplication, and the presence of flavour symmetries. The three Standard Model families make triplication of matter content essential. Flavour symmetries are also desirable. One of the most striking features of the Standard Model is the pattern of Yukawa couplings. While the origin of the Yukawas is unknown, one attractive idea is that the Yukawas are governed by approximate flavour symmetries under which different generations take different charges. Flavour symmetries are also appealing in models of neutrino masses and supersymmetry breaking.

For this reason, we shall mostly focus on the lower-degree del Pezzos, which automatically generate family symmetries. The dP_0 singularity is simply $\mathbb{C}^3/\mathbb{Z}_3$, with a manifest $SU(3)$ global symmetry. In fact we shall see that $SU(3)$ is too large as a family symmetry and gives problematic Yukawas. For this reason models based on dP_1 or dP_2 are more attractive. dP_1 has an $SU(2) \times U(1)$ family symmetry. This symmetry is also shared by $Y^{P,Q}$ singularities. However, unlike the del Pezzo case these do not give rise to family triplication.⁴

As shown in [8], it is easy to construct models on dP_0 with realistic spectra, with hypercharge emerging naturally as the unique anomaly-free $U(1)$. We start by reviewing the structure of these models, before describing how they can be generalised to the more attractive dP_1 case. Some of the following models have already appeared in [8] and others

⁴We thank A. Uranga for very useful discussions on this subject.

are new.

2.3 Del Pezzo 0

The full $dP_0 \equiv \mathbb{C}^3/\mathbb{Z}_3$ quiver, including the possible presence of fractional D7 branes, is shown in figure 2. This quiver has been studied extensively, using the language of Chan-Paton factors, in the paper [8]. An important general point is that, as a bifundamental

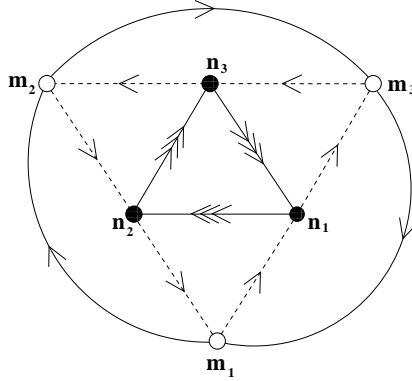

Figure 2: The quiver for the dP_0 singularity. Dark circles correspond to fractional D3 branes wrapping only the collapsed cycles and support Standard Model gauge groups. White circles correspond to fractional D7 branes wrapping both bulk and collapsed cycles and support bulk hidden sector gauge groups. Standard Model matter arises from either $D3 - D3$ or $D3 - D7$ states.

under non-Abelian gauge groups, the Q_L fields must exist as one of the internal 33 lines in the quiver.

The $\mathbb{C}^3/\mathbb{Z}_3$ geometry has a manifest $SU(3)$ symmetry under $z_i \rightarrow U_{ij}z_j$. This global $SU(3)$ symmetry is reflected in the superpotential for the 33 interactions, which is

$$W = \epsilon_{ijk} X_i Y_j Z_k. \quad (2.1)$$

This superpotential has an $SU(3)$ flavour symmetry, under which X , Y and Z all transform as $\mathbf{3}$ s, with the superpotential corresponding to the baryonic $SU(3)$ invariant. As a symmetry of the full Lagrangian the $SU(3)$ flavour symmetry is however broken by the presence of fractional 7-branes. Each 7-brane singles out a complex plane and thus breaks the flavour symmetry to $SU(2) \times U(1)$.

A fractional 7-brane is defined by its Chan-Paton factor and the bulk cycle it wraps. The Chan-Paton factor corresponds to the magnetic flux of the 7-brane on the collapsed cycles. This determines the intersection numbers with the fractional 3-branes and thus the matter content. In figure 2 the different white circles correspond to different choices of Chan-Paton factor for the 7-brane. The choice of bulk cycle wrapped by the 7-brane does not affect the matter content but does affect the superpotential. The superpotential for (33)(37)(73) interactions is

$$W = \Phi_{33}^i \Phi_{37_i} \Phi_{7_i3}. \quad (2.2)$$

That is, a 7_i -brane (one not wrapping the i th complex dimension) couples only to the 33 state along the i th complex dimension. The full superpotential for dP_0 is therefore

$$W = \epsilon_{ijk} \Phi_{33}^i \Phi_{33}^j \Phi_{33}^k + \sum \Phi_{33}^i \Phi_{37_i} \Phi_{7_i3}, \quad (2.3)$$

where we have suppressed all gauge indices. Note that by the choice of the bulk cycle and Chan-Paton factor for the 7-brane, a unique (33) state is singled out which interacts with the (37) states. We also note that the (33) interactions respect the full $SU(3)$ symmetry, whereas the (33)(37)(73) interactions respect only the smaller $SU(2) \times U(1)$ symmetry preserved by the 7-brane. With sufficient D7-branes, the $SU(3)$ symmetry is completely broken as a symmetry of the full Lagrangian.

For generality, we first allow an arbitrary number of branes on each node, labelled n_i for the D3 branes and m_j for D7 branes as in figure 2. The gauge theory carried by the D3 brane nodes is $U(n_1) \times U(n_2) \times U(n_3)$. For the D7 branes, the gauge group depends on the bulk cycles and we leave this open.⁵ The i -th D7 node will correspond to a subgroup of $U(m_i)$. Since the standard model gauge group must come from the D3 brane sector, we leave the D7 brane groups unspecified and only count the multiplicity from the number of D7 branes on each node.

The chiral matter spectrum under $SU(n_1) \times SU(n_2) \times SU(n_3)$ can be written as:

$$\begin{aligned} & 3[(\mathbf{n}_1, \bar{\mathbf{n}}_2, \mathbf{1}) + (\mathbf{1}, \mathbf{n}_2, \bar{\mathbf{n}}_3) + (\bar{\mathbf{n}}_1, \mathbf{1}, \mathbf{n}_3)] + m_1 [(\bar{\mathbf{n}}_1, \mathbf{1}, \mathbf{1}) + (\mathbf{1}, \mathbf{n}_2, \mathbf{1})] \\ & + m_2 [(\mathbf{1}, \bar{\mathbf{n}}_2, \mathbf{1}) + (\mathbf{1}, \mathbf{1}, \mathbf{n}_3)] + m_3 [(\mathbf{1}, \mathbf{1}, \bar{\mathbf{n}}_3) + (\mathbf{n}_1, \mathbf{1}, \mathbf{1})] \end{aligned} \quad (2.4)$$

The quantum numbers under the $U(1)$ factors of $U(n_i) = SU(n_i) \times U(1)$ are +1 for a fundamental, -1 for an antifundamental and 0 for a singlet.

To these particles we must add D3 brane singlets from the intersections among different D7 branes. These are particles which will not be charged under the standard model group and appear in the outer circle of figure 2. A non-vanishing vev breaks the D7 gauge symmetries and gives masses to D3-D7 states. As remarked in [8], if the standard model comes from the D3 brane sector of the quiver diagram, the dP_0 models will naturally lead to three families and at most three non-abelian factors.

The consistency requirement of tadpole cancellation implies anomaly cancellation for all non-abelian gauge symmetries. This equates the number of fundamentals and anti-fundamentals for all nodes on the quiver.⁶ The number of D7 branes is therefore given by:

$$m_2 = 3(n_3 - n_1) + m_1 \quad m_3 = 3(n_3 - n_2) + m_1, \quad (2.5)$$

with the constraint $m_i \geq 0$ imposed. The complete set of solutions is obtained by ordering the n_i as $n_3 \geq n_2 \geq n_1$ (without loss of generality) and taking $m_1 \geq 0$. This determines $m_{2,3}$ by (2.5).

⁵Each white circle can be split into three separate nodes, one for each choice of bulk 4-cycle. The D7 gauge group depends on the details of this splitting.

⁶In quiver diagrams $SU(2)$ nodes are ‘really’ $U(2)$. By a slight abuse of notation, we use $\mathbf{2}$ and $\bar{\mathbf{2}}$ to refer to $SU(2)$ $\mathbf{2}$ s with opposite charges under the $U(1)$ of $U(2) = SU(2) \times U(1)$. Likewise we refer to the $\mathbf{2}$ and $\bar{\mathbf{2}}$ as fundamentals and antifundamentals of $SU(2)$.

There are two anomalous $U(1)$ s, which are cancelled by the Green-Schwarz terms induced by the integrals of RR forms of the form $\int_{\gamma_4} C_4$ and $\int_{\gamma_2} C_2$, with $\gamma_{4,2}$ the associated 4 and 2 cycles. These are local modes in the sense that they have normalisable kinetic terms in the non-compact limit. This follows from the fact that the local 2- and 4-cycle of dP_0 are dual to each other (so the dP_0 has non-zero self-intersection). As will be shown in section 3, the two anomalous $U(1)$'s both receive masses at the string scale, $m \sim \frac{1}{\sqrt{\alpha'}}$. The unique anomaly-free $U(1)$ is

$$Q_{anomaly-free} = - \sum_{i=1}^3 \frac{Q_i}{n_i}, \quad (2.6)$$

where n_i is the rank of the i th gauge group factor and Q_i the diagonal $U(1)$ of this factor.

Let us now discuss some phenomenologically attractive models where the D3 brane gauge group corresponds to the Standard Model, the Left-Right Symmetric Model, the Trinification Model and the Pati-Salam model.

2.3.1 Standard Model

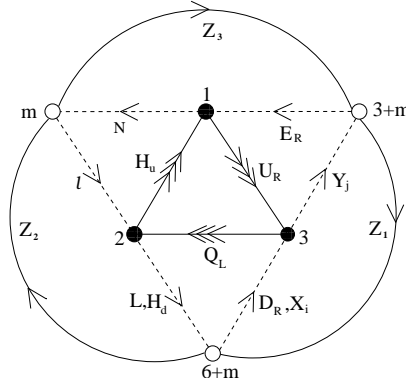

Figure 3: The quiver for the Standard Model realised at a dP_0 singularity.

This is a slightly generalised version of the models already discussed in [8, 36]. The spectrum can be seen in the quiver diagram 3. Some features should be emphasised:

- The total number of D7 branes is determined by the free parameter m_1 . The simplest case m_1 reproduces the models in [8].
- As expected, the unique non-anomalous $U(1)$, $Q_{anomaly-free}$ is precisely hypercharge. However, the normalisation is not standard [36]. Using the standard normalisation for the $U(n)$ generators to be $\text{Tr}T^2 = 1/2$ the hypercharge normalisation is $k_1 = 11/3$ different from the standard GUT normalisation $k_1 = 5/3$. This gives the Weinberg angle $\sin^2 \theta_w = 1/(1 + k_1) = 3/14 = 0.214$ already close to the experimental one (~ 0.2397) indicating that loop corrections, unlike the GUT case, should be small.
- The left handed quarks Q_L together with the right handed up quarks U_R and the down Higgs H_u come in three copies and couple with a superpotential $\epsilon_{ijk} Q_L^i U_R^j H_u^k$

which gives masses to up-quarks. On giving a vev to the Higgs field the quark mass matrix is

$$M_{ij} = \begin{pmatrix} 0 & M & 0 \\ -M & 0 & 0 \\ 0 & 0 & 0 \end{pmatrix},$$

with two heavy quarks and one light one.

- Both the right handed down quarks D_R and the (three) down Higgs H_d are D3-D7 states. The allowed coupling $Q_L D_R H_d$ provides masses to down quarks. There are $(m + 3)$ extra $SU(3)$ vector-like triplets X_i, Y_i that in principle can obtain a mass if the standard model singlets Z_1 get a non-vanishing vev.
- All leptons are D3-D7 states. The left-handed ones leptons L have the same origin as the down Higgses but couple to Q_L and X as $Q_L L X$. If X is heavy and integrated out of the low-energy effective theory this interaction is not relevant for low-energy physics. The $3 + m$ right-handed electrons E_R couple to U_R and Y . There are m extra fields N, l that couple to H_u . Finally there are no clear identifiable right-handed neutrinos. These could come from the standard model singlets $Z_{1,2,3}$ or other heavy singlets such as Kaluza-Klein excitations of moduli fields.
- If the standard model singlets $Z_{1,2,3}$ get a vev the spectrum reduces to three copies of: $Q_L, U_R, D_R, L, E_R, H_u, H_d$ which is precisely the MSSM spectrum (with all right quantum numbers including hypercharge) plus two extra Higgs pairs. Yukawa couplings are induced for both up and down quarks but not for leptons.
- If the blow up mode is stabilised at the singularity all dangerous R -parity violating operators are forbidden by a combination of the global symmetries descending from anomalous $U(1)$'s [35] (see also [36,37]).⁷ As in the Standard Model, such symmetries can be broken by non-perturbative effects, but these are usually suppressed.

If the Fayet-Iliopoulos (FI) parameter (blow-up mode) is stabilised at a non-zero value, in general R -parity violating operators will appear in the effective action. For small values of the blow-up mode one expects the coefficients of these operators to be suppressed by powers of the blow-up vev in string units. These operators would induce proton decay through sfermion exchange with a rate

$$\Gamma \sim \left(\frac{|\phi|}{M_{\text{string}}} \right)^{2(p+q)} \frac{m_{\text{proton}}^5}{16\pi^2 M_{\text{susy}}^4} \quad (2.7)$$

where M_{susy} is the SUSY breaking scale, ϕ the vev of the blow up, and p and q the suppression powers of the two MSSM vertices involved in the process. Comparing to the current bounds of 10^{32} years for the proton lifetime, we require

$$\left(\frac{\langle |\phi| \rangle}{M_{\text{string}}} \right)^{(p+q)} < 10^{-27} \quad (2.8)$$

⁷In particular, anomalous $U(1)$ at the node 3 in figure 3 corresponds to baryon number. This mechanism for proton stability seems to be a generic feature of models constructed from quivers.

For the LVS, taking $M_{\text{string}} = 10^{12}\text{GeV}$, for $|\phi| \sim 10\text{TeV}$ the bound implies $p+q \geq 4$. Another possibility is that the symmetry breaking process leaves some remaining discrete symmetries that forbid R -parity violating operators. In [36] a concrete example was found in which a \mathbb{Z}_2 symmetry coming from the fact that D3-D7 states couple in pairs combines with a remnant \mathbb{Z}_2 from the breaking of the gauge symmetry to give rise to an effective R -parity.

2.3.2 Left-Right Symmetric Models

A second simple class of models are the left-right symmetric models with gauge symmetry $SU(3)_c \times SU(2)_L \times SU(2)_R \times U(1)_{B-L}$ previously studied in [8, 36]. Figure 4 represents the general class of these models. These models offer an interesting generalisation of the

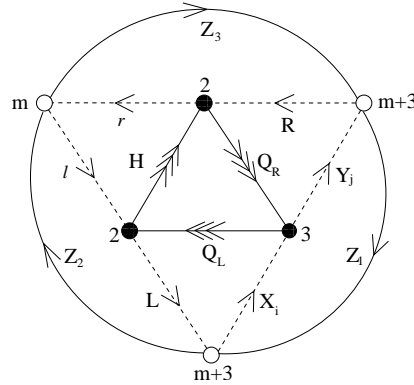

Figure 4: The quiver for the Left-Right symmetric model realised at a dP_0 singularity.

standard-like models.

- The anomaly free combination $Q_{\text{anomaly-free}}$ is $U(1)_{B-L}$, with normalisation $k_{B-L} = 32/3$. Upon breaking to the standard model this leaves to the same Weinberg angle as before.
- The D3-D3 sector gives three families of both left-handed quarks Q_L and right-handed quarks U_R, D_R which come in an $SU(2)_R$ doublet Q_R . Both Higgses H_u, H_d contain another $SU(2)_R$ doublet H and also come in three families. Unlike the Standard Model case, they are clearly distinguished from leptons. The Yukawa couplings for all quarks come from the coupling $\epsilon_{ijk} Q_L^i Q_R^j H^k$.
- The $(m+3)$ leptons L, R are in the D3-D7 sector with no Yukawa couplings. The leptons R include both the E_R and the right-handed neutrinos ν_R .
- There are $m+3$ pairs of vector-like triplets X, Y that can get a mass if the LR singlets Z_1 get a vev.
- The n extra D3-D7 fields, r, l couple to the Higgses as Hrl . These can also be made massive by giving a vev to the singlets $Z_{2,3}$.

- If all $Z_{1,2,3}$ get a vev, the model reduces to simply the supersymmetric version of the LR model plus two extra Higgses.
- A nonvanishing vev for the fields R induces the breaking of $SU(2)_R \times U(1)_{B-L} \rightarrow U(1)_Y$. Here hypercharge $Y = T_R + Q_{B-L}$ and T_R is the $U(1)$ generator inside $SU(2)_R$. This symmetry breaking should be at a similar scale as the Standard Model symmetry breaking ($\langle R \rangle \gtrsim \langle H \rangle$) and is expected to be induced after supersymmetry breaking.
- $U(1)_{B-L}$ prevents the proton from decaying and the symmetry can survive as a global symmetry if the blow-up mode is stabilised at the singularity.
- In references [8, 36] it was found that this class of models leads to gauge coupling unification at the intermediate scale $\sim 10^{12}$ GeV with the same level of precision as the MSSM. It is interesting to notice that this is also the scale preferred from the LARGE volume scenario of moduli stabilisation in order to have TeV scale of soft supersymmetry breaking terms.
- In [8] an extension of this model to a (singular) F-theory compact model with the LR symmetric model living inside 7 D3 branes and 6 D7 branes at a \mathbb{Z}_3 singularity. This was the first realistic supersymmetric *compact* D-brane model constructed explicitly and serves as the prime example that the bottom-up approach of local model building can actually be embedded in compact Calabi-Yau constructions with all tadpoles cancelled. (For other constructions of compact models including warped throats see [24].) Unfortunately, for our purposes, this compactification does not seem to satisfy the conditions for a LARGE volume compactification and F-theory at singularities is yet to be properly understood [38].

2.3.3 Pati-Salam Models

The natural next step is to construct Pati-Salam models with three families of $SU(4) \times SU(2)_L \times SU(2)_R \times U(1)$. These are illustrated in the quiver diagram 5.

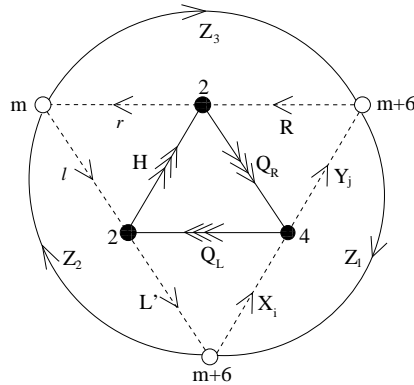

Figure 5: The quiver diagram for the Pati-Salam models realised at a dP_0 singularity.

The main ingredients of these models are.

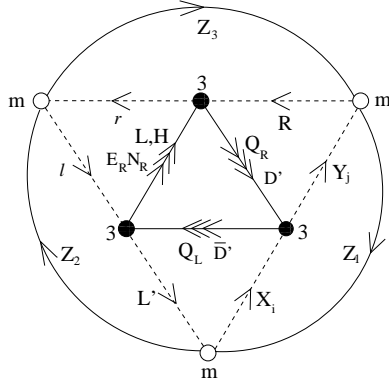

Figure 6: Quiver diagram for the Trinification Models.

- All 16 standard model particles, including the right handed neutrinos, fit precisely in the D3-D3 part of the spectrum as in a full $\mathbf{16}$ of $SO(10)$. In particular the field Q_L transforming in the $(\mathbf{4}, \bar{\mathbf{2}}, \mathbf{1})$ includes left handed quarks and leptons. This is remarkable and in principle appears as a substantial advantage over the previous models. Yukawa couplings for all quarks and leptons may be generated from the superpotential $\epsilon_{ijk} Q_L^i Q_R^j H^k$.
- The scalar right-handed neutrino inside the $(\bar{\mathbf{4}}, \mathbf{1}, \mathbf{2})$ may participate in the breaking of the symmetry to the standard model. This would however give a mass to some of the Higgses and leptons.
- There are extra doublets of both $SU(2)$'s (L', l, r, R) from the D3-D7 sector, and also (anti) fundamentals of $SU(4)$, X and Y . These in principle could be used to break $SU(4) \times U(1)$ to $SU(3)_c \times U(1)_{B-L}$. They can also become heavy if the Z_1 fields get a vev. The fields r, R can be used to break $SU(2)_R \times U(1)_{B-L}$ to $U(1)_Y$.
- If the $Z_{1,2,3}$ fields get a vev we would be left with the three families of the original Pati-Salam model together with 6 copies of the left(right) doublets $L'(R)$.

2.3.4 Trinification Models

Another interesting extension of the Standard Model is the trinification model with three families of $SU(3)^3$ as shown in the figure.

- The anomaly free $U(1)$, $Q_{anomaly-free}$ is in this case a trivial overall $U(1)$ that decouples. So in this case the model is $SU(3)_c \times SU(3)_L \times SU(3)_R$ and there are no extra massless $U(1)$'s. In this case the origin of hypercharge has to be from the rank-reduction breaking of $SU(3)_L \times SU(3)_R$.
- These models are particularly simple as, since all nodes in the quiver diagram are equal, there is no requirement to add D7 branes to cancel the anomalies. All the

standard model particles, plus additional matter, fit in the 27 states of the D3 brane sector:

$$3[(\mathbf{3}, \bar{\mathbf{3}}, \mathbf{1}) + (\mathbf{1}, \mathbf{3}, \bar{\mathbf{3}}) + (\bar{\mathbf{3}}, \mathbf{1}, \mathbf{3})] \quad (2.9)$$

which corresponds to a $\mathbf{27}$ of E_6 . Therefore this model is similar to a Calabi-Yau compactification with three families of $\mathbf{27}$'s after the breaking $E_6 \rightarrow SU(3)_c \times SU(3)_L \times SU(3)_R$ [39]. The first nine states include the left-handed quarks Q_L plus one (exotic) triplet \bar{D}' of hypercharge $Y = -1/3$. The second nine states include the right handed quarks plus an extra down quark, D' . The rest include the leptons and Higgses including two right-handed neutrinos. A vev for the scalar components of the right-handed neutrinos can break the symmetry to the standard model giving also a mass to the extra triplets D', \bar{D}' . However, in this process the would-be leptons are Goldstone-bosons that are eaten by the gauge fields.

- The D3-D7 spectrum consists of a number m of pairs of $\mathbf{3}$ and $\bar{\mathbf{3}}$ for each of the $SU(3)$ gauge groups and could play a role for gauge symmetry breaking, provided they do not all receive a mass by vev's of the Z_i fields.

In summary, while none of these models are fully realistic, we have a series of interesting models with three families all containing the matter content of the MSSM and no chiral exotics. There are further models that can easily be considered, for example the 331 model for which only one sector of D7's is needed for anomaly cancellation. Furthermore, as in [8], we could have considered models at orientifold singularities obtaining for instance a three-family $SU(5)$ model and its extensions to higher del Pezzo singularities. A detailed analysis of the phenomenological prospects of each model is out of the scope of this article.

One general problem we note is that anomalous $U(1)$ s tend to forbid the existence of Yukawa couplings for leptons. This is because the leptons L and E_R come from different D3-D7 sectors, and the orientation of the arrows (which indicate the $U(1)$ charge of $U(n) = SU(n) \times U(1)$) do not allow a non-vanishing coupling among them. This is less of an issue for the Pati-Salam and Trinification models, where Standard Model fields are all D3-D3 states. However in this case it is difficult to break the gauge groups down to the Standard Model.

We shall however concentrate on one general issue regarding Yukawa couplings that applies to all the models based around dP_0 . While the matter content of the models is appealing, the $SU(3)$ global symmetry of the 33 sector is always problematic. Once one of the Higgs fields acquires a vev, the Yukawa matrix can be written without loss of generality as

$$Y_{ijk} \sim \begin{pmatrix} 0 & M & 0 \\ -M & 0 & 0 \\ 0 & 0 & 0 \end{pmatrix}.$$

This mass matrix can be diagonalised as $(M, M, 0)$, and therefore all models based around figure 2 make the unacceptable prediction that $m_t \sim m_c$.

2.4 Del Pezzo 1

The origin of the problematic Yukawa texture for models based on dP_0 was the over-large global $SU(3)$ family symmetry. We want to keep the many attractive features of the dP_0 models while reducing this family symmetry. As the size of the symmetry group is reduced with the height of the del Pezzo, this naturally leads us to higher del Pezzos. However, as n increases the family symmetry of the quiver disappears entirely. As flavour symmetries are phenomenologically attractive and we prefer to maintain them, we therefore focus on models based on dP_1 . The quivers for lower degree del Pezzos can be obtained from higgsing higher del Pezzos and so the models we now describe can be naturally generalised to $dP_{n>1}$.

The dP_1 singularity is not an orbifold but is toric, and can be obtained through successive blow-ups of the $\mathbb{C}^3/\mathbb{Z}_3 \times \mathbb{Z}_3$ orbifold singularity [32]. The allowed spectrum of fractional D7 branes for this model were computed in [34]. The quiver for this theory, including the possible supersymmetric fractional D7 brane states, are shown in figure 7. For every 33

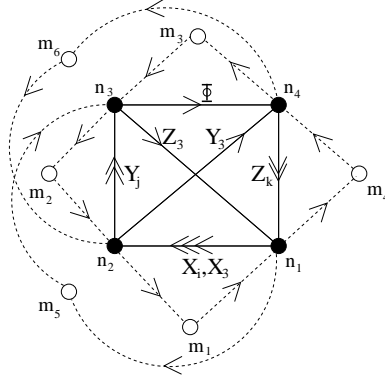

Figure 7: The dP_1 quiver, including all possible fractional D7 branes. Black circles denote fractional D3 branes and white circles fractional D7 branes. We have only shown 33 and 37 states.

state $\Phi_{3_i 3_j}$, there exists a supersymmetric 7-brane giving an $(7i)$ fundamental and a $(7j)$ antifundamental with the Yukawa coupling $\Phi_{3_i 3_j}(7i)(7j)$.

The superpotential for the 33 states for the dP_1 quiver is

$$W = \epsilon_{ij} X_i Y_j Z_3 - \epsilon_{ij} X_i Y_3 Z_j + \frac{\Phi}{\Lambda} X_3 \epsilon_{ij} Y_i Z_j, \quad (2.10)$$

where Λ is an appropriate UV cutoff.⁸ There is an $SU(2)$ flavour symmetry under which X, Y and Z transform as $\mathbf{2}_s$, and also a $U(1)$ flavour symmetry under which X_3 has charge $+1$ and Φ charge -1 . There is also a $U(1)_R$ symmetry and the three $U(1)$ s descending from the four D3 brane vertices, with an overall $U(1)$ decoupling.

As with the dP_0 quiver, fractional 7-branes can be inserted which wrap both bulk and collapsed cycles. Analogously to dP_0 , and as described in detail in the appendix of [34],

⁸Note that within the low energy $\mathcal{N} = 1$ supergravity, Λ is necessarily M_P due to holomorphy, and the actual physical suppression scale is determined by terms in the Kähler potential.

singularity	flavour symmetry
dP_0	SU(3)
dP_1	SU(2) \times U(1)
dP_2	U(1)
$dP_{n>2}$	none

Table 1: Table showing the continuous flavour symmetry associated with 33 states for various del Pezzo singularities.

there is one 7-brane for each (33) state. For every (33) state, there is a 7-brane that leads to a (33)(37)(73) Yukawa coupling coupling only to that (33) state. At the level of gauge interactions, this is visible in the presence of the white dots in figure 7, which lead to Yukawa couplings involving every (33) state. Not shown in figure 7, but as held for dP_0 , is that the choice of which bulk 4-cycle the 7-brane wraps allows us to couple the (37) states to any given (33) state, independent of flavour.

The number of D7 branes is bound by the tadpole/non-abelian anomaly cancellation as in the dP_0 case, which in this case reads:

$$\begin{aligned}
m_4 &= n_4 + n_3 - n_1 - n_2 + m_1 - m_2 + m_3, \\
m_5 &= n_1 - 2n_2 + n_4 + m_2 - m_3, \\
m_6 &= n_4 - 3n_1 + 2n_3 + m_1 - m_2
\end{aligned}
\tag{2.11}$$

That is, given the number of D3 branes at each node n_i , the models are determined by fixing also the number of D7 branes at the first three nodes in the figure $m_{1,2,3}$. Solutions with $m_i \geq 0$ are physically relevant.

Similar to the dP_0 case the anomaly free combination of $U(1)$'s is:

$$Q_{anomaly-free} = \sum_i \frac{Q_i}{n_i}
\tag{2.12}$$

Once $\langle \Phi \rangle \neq 0$, the matter content is Higgsed back to the dP_0 quiver for energies $E \ll \langle \Phi \rangle$. In principle there is no objection to Φ obtaining a vev, provided that the mass of the Z' that the vev would produce is beyond experimental bounds. Indeed, in a realistic model it is necessary that one node of the quiver (the Higgs) is radiatively vevved during supersymmetry breaking. It is not implausible that this is not the only node that is vevved by the process of supersymmetry breaking.

The $SU(2) \times U(1)$ family symmetry, allows us to engineer family symmetries that are less restrictive than the models discussed in 2.3. Upon diagonalization, the mass squared matrix MM^\dagger associated with the superpotential (2.10) takes the form

$$\begin{pmatrix} M^2 & 0 & 0 \\ 0 & m^2 & 0 \\ 0 & 0 & 0 \end{pmatrix}.$$

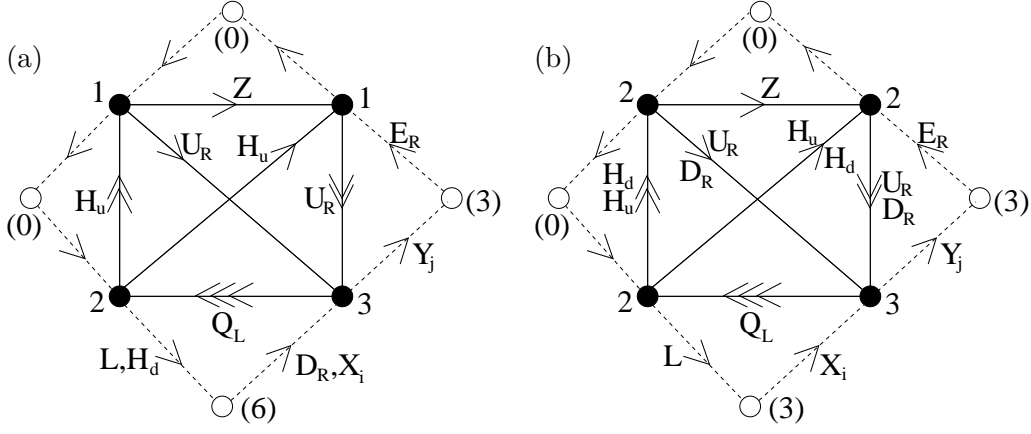

Figure 8: A MSSM-like model and LR-symmetric model based on the del Pezzo 1 singularity.

with $M \gg m$ for small values of the vev of Φ , $\frac{\langle \Phi \rangle}{\Lambda} \ll 1$. This provides a more realistic hierarchy of fermion masses than the dP_0 models.⁹ Further suppressed instanton contributions to Yukawa couplings have been recently computed for branes at singularity models in [40].

2.4.1 Standard and Left-Right Symmetric dP_1 Models

We can modify the dP_0 models of section 2.3 to obtain models with more realistic Yukawa couplings, with a flavour symmetry of $SU(2) \times U(1)$. In figure 8 we show some quasi-realistic models based on the dP_1 singularity.

The first figure of 8 shows a quiver for generating an MSSM-like model. In the non-compact limit, the anomaly-free gauge group of this model is $SU(3) \times SU(2) \times U(1)_Y \times U(1)_Z$. The additional $U(1)$ compared to the dP_0 models comes from the presence of the splitting of the $U(1)$ node into two separate $U(1)$ s, joined by the field Z . One of these $U(1)$ s corresponds to hypercharge and the other to an additional $U(1)_Z$ under which different quark generations (in particular the U_R fields) have different charges.

In the non-compact limit, $U(1)_Z$ is massless. However in a compact model it will acquire a mass through the Green-Schwarz mechanism, provided all 2-cycles of dP_1 remain 2-cycles of the Calabi-Yau. As we shall see below, $U(1)_Z$ will then acquire a mass of M_{KK} , the bulk KK scale of the compactification, and decouple from the low-energy physics. In this case the gauge group returns to the case of dP_0 (with the addition of the neutral Z field) while the structure of Yukawa couplings is set by an $SU(2) \times U(1)$ flavour symmetry.

The second figure of 8 shows a quiver for generating a Left-Right Symmetric model from the dP_1 singularity. In this case, it is necessary to vev the Z field in order to break the spectrum and gauge group back down to that of the dP_0 case. It may be asked why

⁹The limit $\frac{\langle \Phi \rangle}{\Lambda} \rightarrow 1$ corresponds to the dP_0 quiver, in this limit $m \rightarrow M$ restoring the $SU(3)$ symmetry of dP_0 .

the dP_1 quiver is relevant at all, if it is necessary to vev it back down to the dP_0 quiver. The collapse of the dP_1 quiver to the dP_0 quiver corresponds to the fact that upon vevving the Z field, in the absence of SUSY breaking the dP_1 theory flows to the dP_0 theory in the deep infrared. By considering dP_1 models in which SUSY breaking occurs well before the theory has evolved to the dP_0 theory,¹⁰ one can obtain models in which the interactions are different from theories at dP_0 quivers. In particular, the flavour symmetry is that associated with the dP_1 geometry, while the low energy matter content is that associated with a dP_0 quiver.

Some comments are appropriate about the relationship of the vevved dP_1 quiver and the dP_0 models. By blowing up a 2-cycle in the dP_1 geometry, the geometry of the actual singularity reduces to that of dP_0 . It may therefore seem more appropriate to describe the singularity as dP_0 . However, if the vev of the blow up field is substantially sub-stringy, and so far away from the geometric regime, this vev is most straightforwardly viewed as a perturbation on dP_1 within field theory rather than as dP_0 with a nearby resolved cycle in the geometry. This latter viewpoint would be more appropriate if the cycle was resolved with a string/Planck vev taking it all the way into the bulk geometric regime.

Further models can be constructed based on dP_1 : it is in principle possible to consider a node in the quiver without any branes. This immediately fixes the modulus corresponding to fractional branes moving out of the singularity and avoids reducing the gauge group to factors smaller than the Standard Model. However, it is not clear how the correct hypercharge assignments will emerge in this case (and this modulus is expected to be fixed by soft supersymmetry breaking terms). We could also orientifold these models opening the possibility of reducing the number of extra doublets as studied in the second reference of [9], and also potentially introducing symmetric and antisymmetric representations.

2.5 Higher del Pezzos

Using the methodology of adding nodes and vevving them, it is easy to extend any of the above models to any of the higher del Pezzos. The motivation for doing so however weakens as the del Pezzo rank is increased: the extent of flavour symmetries decrease, and the amount of vevving required to reduce to the Standard Model spectrum makes the models increasingly baroque, without substantially improving the phenomenology.

3. Global Embeddings

3.1 Local/Global Mixing

To study supersymmetry breaking in a controlled fashion, it is necessary to embed the above local constructions into global models in which the moduli are stabilised and supersymmetry is broken. Recently Blumenhagen, Moster and Plauschinn have emphasised a difficulty with combining realistic chiral matter sectors with moduli stabilisation [28].

¹⁰This can be achieved if $\langle Z \rangle \ll M_{\text{pl}}$.

In the IIB context the issue can be summarised as follows. In the IIB context, moduli stabilisation techniques involve 3-form fluxes stabilising the complex structure moduli and non-perturbative effects stabilising the Kähler moduli. The typical moduli effective action takes the form

$$K = -2 \ln \left(\mathcal{V} + \frac{\xi(S + \bar{S})^{3/2}}{2} \right) - \ln \left(i \int \Omega \wedge \bar{\Omega}(U, \bar{U}) \right) - \ln(S + \bar{S}), \quad (3.1)$$

$$W = \int G_3 \wedge \Omega(U) + \sum A_i(U) e^{-a_i T_i}. \quad (3.2)$$

Here T_i are Kähler moduli, U_j complex structure moduli and S is the dilaton. ξ is a numerical factor representing the α^3 correction to the Kähler potential. After flux stabilisation, the effective theory for the Kähler moduli is

$$K = -2 \ln \left(\mathcal{V} + \frac{\xi'}{g_s^{3/2}} \right), \quad (3.3)$$

$$W = W_0 + \sum A_i e^{-a_i T_i}. \quad (3.4)$$

The justification for integrating out the U moduli is essentially the factorised form of the Kähler potential and the lack of cross-couplings between U and T fields. For a recent discussion of the consistency of integrating out moduli in supergravity, see [41]. The presence of a ‘bare’ instanton superpotential $e^{-a_i T_i}$ requires the instanton to have only two fermionic zero modes and the modulus T to be uncharged. This occurs for example for instantons wrapping rigid blow-up cycle, where there are no massless adjoint degrees of freedom.

By definition however there are branes and chiral fermions on the cycles supporting the MSSM. Instantons wrapping the same cycle as any MSSM brane have a non-zero intersection number with such branes, giving rise to extra fermionic zero modes. This forbids the bare term $e^{-a T_{MSSM}}$ from appearing in the superpotential and requires it to be instead dressed with matter fields. Equivalently, in brane constructions the chiral nature of the MSSM implies the existence of anomalous U(1)s under which moduli are charged, $\delta_\lambda T_{MSSM} = T_{MSSM} + i Q_T \lambda$. For all such moduli the term $e^{-a T_{MSSM}}$ is gauge-variant and cannot appear bare in the superpotential.

The consequence is that if T_{MSSM} appears in the superpotential, it can only do so in the gauge-invariant form

$$\left(\prod_i \Phi_{hidden,i} \right) \left(\prod_j \Phi_{MSSM,j} \right) e^{-a T_{MSSM}}.$$

However Φ_{MSSM} does not acquire a vev,¹¹ and so there is no non-perturbative superpotential available to stabilise T_{MSSM} .

¹¹The Higgs vev is too small to be relevant for moduli stabilisation.

There are two basic approaches to this problem. One could suppose as in [42] that the MSSM cycle size is stabilised by loop (worldsheet or spacetime) corrections to the Kähler potential. The difficulty here is that such corrections are hard to calculate in a controlled way, and it is not easy to ensure the cycle is stabilised in the geometric regime.

Reference [28] suggested aiming to stabilise the Standard Model cycle using D-terms for anomalous U(1)s. Such D-terms take the form

$$D_a^2 \sim \sum_i (|\Phi|^2 - \xi)^2,$$

where ξ is the moduli-dependent Fayet-Iliopoulos term $\xi = (\partial_{V_a} K)|_{V_a=0}$ and V^a is the U(1) vector multiplet. In the geometric regime the FI term can be written as $\xi \sim \int J \wedge F$. If Φ_{MSSM} is forced to vanish, these Kähler moduli are stabilised by $\xi = 0$.

In [28] a toy model was studied where D-terms constrained the ‘Standard Model’ cycle to finite size while another unrelated cycle collapsed to the edge of the Kähler cone. A general disadvantage of using the geometric expressions for D-terms to stabilise moduli is that the FI term has a tendency to drive cycles to collapse, i.e. to the boundary of the Kähler cone. However in this regime the FI term will be modified by corrections to the Kähler potential. Furthermore, branes that were originally BPS in the geometric regime may become unstable and decay to a new set of stable branes. It is instead necessary to use the BPS brane states associated to the collapsed geometry, but it is not easy to follow this transition through.

An attractive feature of models of branes at singularities is that they allow a promising possible resolution of this tension. As described in section 2, the stable BPS branes at the singularity are known and their matter content and interactions are encoded in the quiver/dimer diagrams. We have also seen that realistic matter spectra occur rather naturally in this framework. The FI terms for the anomalous U(1)s correspond to vevs for the blow-up modes that resolve the singularity. Requiring vanishing FI terms stabilises the blow-up moduli at the singularity. Even though this is on the edge of the Kähler cone, we have excellent model-building control here as we know the appropriate set of fractional branes that apply at the singularity. For the $\mathbb{C}^3/\mathbb{Z}_3$ singularity the geometry is even simpler and is a very simple orbifold singularity.

We note that strictly speaking what is fixed by the D-term is a combination of the matter field vevs and the FI term, as a non-zero $\langle \xi \rangle$ can always be cancelled by a non-zero $\langle \Phi \rangle$. However, after supersymmetry breaking the presence of soft scalar masses for the matter fields Φ will lift this degeneracy. As $\Phi = 0$ is a point of enhanced symmetry, we consider it a reasonable assumption that after supersymmetry breaking soft scalar masses will fix $\Phi = 0$. It would however clearly be nice to verify this assumption in a full model.

For clarity let us enumerate the steps required (also see [24] for similar ideas):

1. The D-term generates a potential

$$V_D \sim \left(\sum_i |\Phi_{MSSM}|^2 - \xi \right)^2 \quad (3.5)$$

that fixes a combination of the matter fields Φ_{MSSM} and the unfixed Kähler moduli (in ξ) but leaves an overall flat direction.

2. The presence of soft scalar masses for the matter fields, induced after supersymmetry breaking, will lift this degeneracy.
3. If the soft masses are positive in an expansion about $\Phi = 0$ then the full minimum of the potential will be at $\Phi = 0$ and $\xi = 0$ thereby fixing the Kähler moduli at the singularity. While it is not possible to determine the sign of the soft masses without a full study of supersymmetry breaking, this sign does only represent a discrete parameter.

We also note that in a phenomenological model the positive mass is phenomenologically necessary (except for the Higgs scalars) in order to avoid charge and colour breaking minima. Thus in models in phenomenologically realistic supersymmetry breaking the blow-up moduli will be fixed at the singularity.

We now flesh out this picture and describe the requirements on the global geometry in order to realise this embedding.

3.2 Towards Fully Global Models

We wish to embed the above local models into a bulk that stabilises moduli and breaks supersymmetry. We will base the bulk on the LARGE volume method of moduli stabilisation [19, 20]. Under rather general conditions, analysed in most detail in [42], this stabilises moduli and gives controlled and dynamical low-energy supersymmetry breaking. The principal characteristic of this model is the exponentially large volume. The stabilisation and phenomenology of these models have been studied in [20, 21, 28, 43–46, 48, 49]. General features of these models are

1. A ‘Swiss-cheese’ geometry, with a large bulk volume and several small blow-up cycles.
2. A gravitino mass

$$m_{3/2} = \frac{W_0 M_P}{\mathcal{V}}. \quad (3.6)$$

3. Supersymmetry dominantly broken by the volume modulus in an approximately no-scale fashion.

In figure 9 we provide a schematic of the geometry required for the minimal global embedding. The minimal geometry consists of a Calabi-Yau with 4 Kähler moduli, of which one (τ_b) controls the overall volume and three ($\tau_{s,i}$) are blow-up modes resolving singularities. Such shrinkable 4-cycles are del Pezzo surfaces and thus rigid: a brane wrapping such a surface has no adjoint matter. For simplicity we assume the local geometry around each blow-up mode to be the cone over dP_0 , i.e. the geometry of the \mathbb{Z}_3 singularity. The volume can be written in the ‘Swiss-cheese’ form

$$\mathcal{V} = \tau_b^{3/2} - \tau_{s,1}^{3/2} - \tau_{s,2}^{3/2} - \tau_{s,3}^{3/2}. \quad (3.7)$$

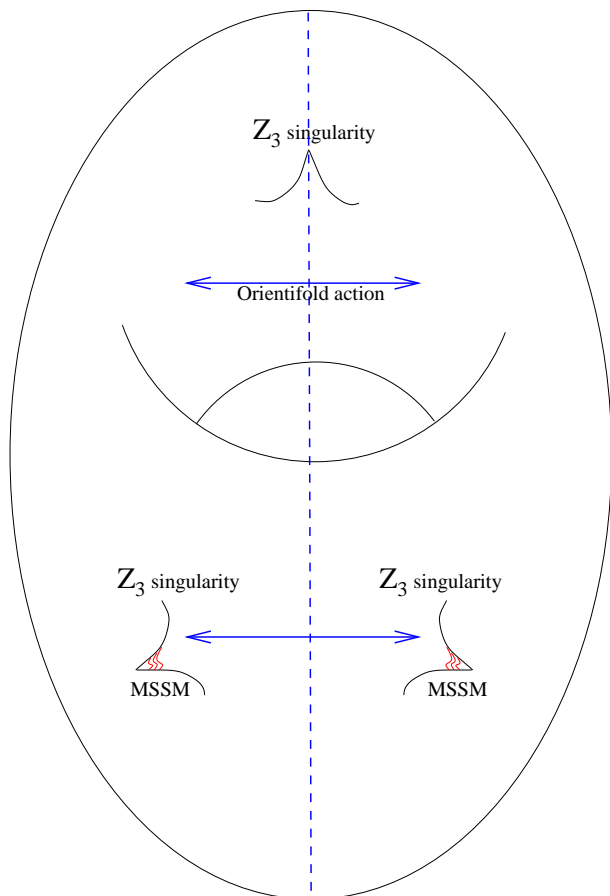

Figure 9: A schematic of the required Calabi-Yau properties to generate a model with a realistic matter sector, full moduli stabilisation and controlled hierarchically small dynamical supersymmetry breaking.

In this example there are a total of four Kähler moduli. This is a minimal requirement: one to control the overall volume, one to have non-perturbative effects, and two to be exchanged by the orientifold. This framework can be trivially generalised to models with more Kähler moduli. The ‘Swiss-Cheese’ form of the volume is known to exist for models with 2 ($\mathbb{P}^4_{[1,1,1,6,9]}$), 3 ($\mathbb{P}^4_{[1,3,3,3,5]}$), and 5 Kähler moduli ($\mathbb{P}^4_{[1,1,3,10,15]}$) (the last two are described in [28]). Further examples are also discussed in [13].

We require that an orientifold action leading to O3/O7 planes is well-defined on the Calabi-Yau. An orientifold requires invariance under the action of $\Omega\sigma(-1)^F$, where Ω is world-sheet parity, F is world-sheet fermion number, and σ is a \mathbb{Z}_2 involution of the Calabi-Yau. The involution σ acts on the various 4-cycles and we use $h_{1,1}^+$ ($h_{1,1}^-$) to denote the number of 4-cycles with positive (negative) parity under σ . The moduli content after the orientifold is given by

$$h_{1,1}^+ \quad T_\Sigma + iC_4 \quad (3.8)$$

$$h_{1,1}^- \quad B_2 + iC_2. \quad (3.9)$$

We require that under the involution the large 4-cycle, τ_b , and one of the small blow-up cycles, for definiteness $\tau_{s,1}$, is taken to itself. In the case that an orientifold plane wraps this cycle we place D7 branes on top of the O7-plane, cancelling the local tadpoles and generating an $SO(8)$ gauge group. As the cycle is a blow-up cycle it is rigid and a brane wrapping it carries no adjoint matter and no additional fermionic zero modes. The $SO(8)$ gauge group therefore undergoes gaugino condensation and generates a non-perturbative superpotential in τ_1 . If no orientifold plane wraps the τ_1 cycle, then D3-instantons will generate a non-perturbative superpotential for τ_1 . Such a nonperturbative superpotential for τ_1 is necessary to obtain the LARGE volume stabilisation.

We also require the involution to exchange the remaining two small cycles, $\tau_{s,2} \leftrightarrow \tau_{s,3}$. This will ensure the local geometry near these singularities is that of a pure Calabi-Yau singularity. The orientifold action simply relates the physics at one singularity to that at the other. Orientifolded singularities may also be interesting for model-building, but for simplicity we do not consider them here. At these singularities we introduce one of the models of section 2, giving a realisation of a chiral matter sector containing the Standard Model matter content. These models cancel all local tadpoles and only leave a bulk D7 tadpole and a D3 tadpole. For the trinification model, there is no D7 tadpole and the only tadpole to be cancelled is the D3 tadpole.

As well as the construction of an appropriate Calabi-Yau - for example using the models of [13] - many other conditions must be satisfied to build a fully consistent global model. These include the cancellation of all RR tadpoles, the specification of explicit 3-form flux quantum numbers and the solution of the flux equations $D_U W = 0$, and cancellation of Freed-Witten anomalies between fluxes and branes. Many of these conditions are more mathematical in nature, and do not seem to have direct effect on the phenomenology or the pattern of supersymmetry breaking. While the explicit construction of such global models is important, it is beyond the scope of this paper (see [55] for a recent detailed discussion of consistency conditions for IIB model building).

3.3 Effective Field Theory Near the Singularity

For a given compactification we usually know that an effective field theory can be used in the regime where the moduli are larger than the string scale l_s . Starting in this regime, the effective field theory ceases to be valid when we approach the boundary of the Kähler cone in which one of the moduli collapses to zero size. However, string theory is known to behave properly at singularities. Therefore there exists an effective field theory description close to the singularity, in the regime for which the overall size of the corresponding blow-up mode is much smaller than the string scale l_s . We therefore have two different effective field theories depending on which regime we are considering the blow-up mode. Most of the studies have been done in the large modulus regime corresponding to magnetised D7 branes models. We collect here the main expressions for the effective field theory in the vicinity of the singularity. For concreteness we will assume that the Standard Model cycle of size T_{SM} is close to the singularity whereas the 4-cycle of size T_s providing the non-perturbative

superpotential is in the large modulus regime.

As usual we need expressions for the gauge kinetic functions f , the superpotential W and the Kähler potential K . The gauge kinetic function in the magnetised D7 brane regime look like $f = T_s + \alpha S$, with T_s the 4-cycle modulus, S the dilaton and α a flux dependent coefficient. Close to the singularity the gauge kinetic function takes the form $f = S + \beta T_{SM}$, with β a loop correction parameter.

For the superpotential, as usual RR and NS-NS fluxes give rise to a constant superpotential W_0 (after stabilising complex structure and dilaton moduli), non-perturbative effects give rise to the standard e^{-aT_s} term. Yukawa couplings differ substantially whether the standard model is at the singularity compared to the large blow-up limit. In [11, 30] it was shown that the Yukawa couplings in a blown-up P_2 vanish identically, however it is known that at the singularity the Yukawa couplings are generally non-vanishing and determined by the structure of the quiver/dimer diagram as we have discussed above.

$$W = W_0 + Ae^{-aT_s} + Y_{ijk}C^iC^jC^k. \quad (3.10)$$

Y_{ijk} is singularity dependent (for dP_0 it is ϵ_{ijk}). The Kähler potential is more difficult to determine and takes the form:

$$\mathcal{K} = -2 \ln((T_b + \bar{T}_b)^{3/2} - (T_s + \bar{T}_s)^{3/2} + \xi) + \frac{(T_{SM} + \bar{T}_{SM} - qV)^2}{\mathcal{V}} \quad (3.11)$$

$$+ \frac{(B_2 + \bar{B}_2 - q'V')^2}{\mathcal{V}} + \frac{C^i \bar{C}^i}{\mathcal{V}^{2/3}} \left(1 + \mathcal{O}((T_{SM} + \bar{T}_{SM})^\lambda + \dots)\right), \quad (3.12)$$

with $\lambda > 0$. Here C^i are chiral matter fields, T_{SM} and B_2 the local moduli of the singularity, and q and q' the charges of the moduli under the two anomalous $U(1)$ s of the dP_0 singularity. V and V' are the vector multiplets of these $U(1)$ s. The kinetic term factors of $\frac{1}{\mathcal{V}}$ for the local modulus T_{SM} and $\frac{1}{\mathcal{V}^{2/3}}$ for the local matter fields will be justified as follows.

Let us start with the matter fields for which we follow an argument similar to [50]. The volume dependence of $\mathcal{V}^{2/3}$ is equivalent to the statement that the physical Yukawa couplings are local and do not depend on the overall volume. This follows from the expression for the physical Yukawas $\hat{Y}_{\alpha\beta\gamma}$,

$$\hat{Y}_{\alpha\beta\gamma} = e^{\mathcal{K}/2} \frac{Y_{\alpha\beta\gamma}}{\sqrt{K_\alpha K_\beta K_\gamma}}. \quad (3.13)$$

As the superpotential Yukawas cannot depend on the volume moduli due to holomorphy, the dependence of the Kähler metric on the volume is fixed by the requirement that $\hat{Y}_{\alpha\beta\gamma}$ does not depend on the bulk volume. The absence of any leading order dependence on T_{SM} also follows from the finiteness of the Yukawas: at the singularity $T_{SM} = 0$, while the physical Yukawas are finite and non-zero.

Let us now consider the volume scaling, $K_{B_2} \sim K_{T_{SM}} \sim \frac{M_P}{\mathcal{V}}$. There are three ways to understand the volume scaling of this.

1. This is the volume scaling that holds in the geometric regime (e.g. for T_s). Collapsing to the singularity is a local effect and will not affect the power of volume that appears.

2. As we will see in the next subsection, the mass of an anomalous U(1) is given by $m_{U(1)}^2 = M_P^2 K''(T_{SM} + \bar{T}_{SM})$. As we calculate $m_{U(1)}^2 = M_s^2 = \frac{M_P^2}{\mathcal{V}}$, this fixes the volume scaling of $K(T_{SM} + \bar{T}_{SM})$ to be $1/\mathcal{V}$.
3. We can imagine moving to a point in field space where T_{SM} is resolved to finite size comparable to the string scale but where none of the matter fields have vevs. This configuration breaks supersymmetry in a hard fashion. The vacuum energy comes from a non-supersymmetric brane configuration and will be $V \sim M_{string}^4 \sim \frac{M_P^4}{\mathcal{V}^2}$. As this energy is associated with the D-term this implies that

$$V_D = \frac{M_P^4}{2} \text{Re}(f_a)^{-1} (Q \partial_{T_{SM}} K)^2 \sim \frac{M_P^4}{\mathcal{V}^2}.$$

It follows that if T_{SM} measures the size of the resolution in string units, and is thus $\mathcal{O}(1)$ for a resolving geometry of characteristic radius $\sqrt{\alpha'}$ and characteristic energy $V \sim M_{string}^4$,

$$K(T_{SM}, \bar{T}_{SM}) = \frac{(T_{SM} + \bar{T}_{SM} + qV)^2}{\mathcal{V}}.$$

The shift symmetry is associated with the axionic nature of $\text{Im}(T)$.

Given this geometry, the LARGE volume stabilisation mechanism of [19] gives rise to both moduli stabilisation and dynamical supersymmetry breaking, with the volume stabilised at an exponentially large value. For this to occur we require that the compact space X has more complex structure moduli than Kähler moduli, $h^{2,1}(X) > h^{1,1}(X)$. This condition is due to a requirement on the sign of the α'^3 correction to the Kähler potential, which depends on the sign of the Euler number of the Calabi-Yau.

Finally we would like to emphasise the following important feature that can be confusing. One of the properties of local models is that, contrary to common lore, not all the moduli couple with gravitational strength interactions. It is clear that the matter fields living in a local cycle couple to the volume modulus with gravitational strength interactions since their couplings probe the whole manifold. The same applies to couplings to other moduli. However the interaction of matter fields on a local cycle with the moduli controlling the size of that cycle are only suppressed by the string scale and not by the Planck scale. Explicit calculations illustrating this fact can be found in reference [51]. This result will play an important role when we discuss soft supersymmetry breaking.

3.4 Phenomenological Features

3.4.1 Hyperweak Forces

In local models of branes at singularities, the global D7 branes provide global symmetries of the model. However once the corresponding model is embedded in a compact model, the symmetries induced by these D7 branes will be gauged with an inverse gauge coupling of order the size of the bulk cycle. As emphasised in reference [52], the D7 branes could play an important phenomenological role. Since they probe the global structure of the extra

dimensions, they naturally wrap the exponentially large 4-cycle and the corresponding gauge coupling will be exponentially small ($g^{-2} \sim \tau_b \sim \mathcal{V}^{2/3}$) (see [53] for related work). Therefore the Standard Model states coming from D3-D7 states will be charged under these extra symmetries. In some of the examples above these particles are the leptons but there are also models with the right handed quarks corresponding to D3-D7 states. The existence of these remarkably weak interactions could be considered as an interesting way to test some of these models. Estimates for the masses of the extra gauge bosons and their phenomenological implications are discussed in [52].

Here we note that such hyperweak gauge bosons may be relevant for explaining the ghost muon anomaly recently seen at the CDF detector at the TeVatron [54]. Di-muon events with tight identification within the inner silicon vertex (SVX) trackers (and small impact parameters $\sim \mathcal{O}(0.1\text{cm})$) are well-described by Standard Model and detector effects, giving a $\sigma_{b \rightarrow \mu, \bar{b} \rightarrow \mu}$ cross-section in good agreement with NLO theoretical predictions. However there are also a large number of so-called ‘ghost’ muon events, which register on loose SVX cuts, with large muon impact parameters $\mathcal{O}(1\text{cm})$. These ghost muons have larger additional nearby particle multiplicity than for muons from known QCD events and have a broad peak in their invariant mass spectrum at $\mathcal{O}(1)$ GeV. CDF is currently unable to account for the presence of these ghost muons with their large impact parameters using their current understanding of Standard Model backgrounds and detector performance. While this may be due to experimental subtleties in understanding backgrounds, particle reconstruction or other detector effects - and most experimental anomalies do in time go away - there is however the possibility that the ghost muons are due to the decay of a previously unknown long lived particle which we will henceforth denote U .

If such an interpretation is correct, CDF’s fit to the distribution of impact parameters gives a lab lifetime $\tau \sim 2 \times 10^{-11} s$ for this new particle. The large numbers of events with ghost muons (73000 events compared to 195000 for $b \rightarrow \mu, \bar{b} \rightarrow \mu$ for 2fb^{-1}) suggests this U is produced abundantly and with relatively large cross-section, even if it is possible to attribute an $\mathcal{O}(1)$ fraction of ghost events to non-exotic physics. This argues against interpretations in which U is accessed only through a very heavy portal, e.g. supersymmetric cascade decays of the gluino. Such processes would have difficulty producing sufficient U events while remaining consistent with null results for new high P_T physics searches at the TeVatron.

Light weakly coupled particles are naturally long lived. A hyper-weak gauge boson can be naturally light, with a mass $m_U \sim v g_U$ where v is the vev of the U Higgs. For weak-scale vevs (as for the SM Higgs) the U boson mass is significantly suppressed compared to M_W by the small coupling. For direct two-body decay, on dimensional grounds the U boson lifetime would be

$$\Gamma \sim \frac{g_U^2 m_U}{4\pi}, \quad \tau \sim \frac{4\pi}{g_U^2 m_U} \sim \left(\frac{1\text{GeV}}{m_U} \right) \left(\frac{10^{-8}}{g_U^2} \right) 10^{-16} s. \quad (3.14)$$

The lifetime is automatically enhanced compared to e.g. QCD timescales by the low mass and weak coupling.

In order for U to be abundantly produced at a hadron collider, quarks must be charged under it. A light U can be produced either directly through $q\bar{q}$ annihilation or alternatively as initial state (ISR) or final state (FSR) radiation in any regular QCD process. For either ISR or FSR emission probabilities of a light U boson are logarithmically enhanced by standard Sudakov factors. If $m_U \sim 1\text{GeV} \sim \Lambda_{QCD}$ then on dimensional grounds we expect U boson emission from the initial or final state to be suppressed compared to QCD emission by α_U/α_{QCD} . While this number is small, the overall number of events involving U emission may still be very large given the colossal size of the QCD background at a hadron collider.

Supposing a new U particle to be responsible for the ghost muons, the CDF dimuon invariant mass spectrum shows no sign of a sharp narrow muon resonance associated to 2-body $U \rightarrow \mu^+\mu^-$ decay. Instead a broad plateau is seen at invariant energies $m_{\mu\mu} \sim 1\text{GeV}$. While the presence of (possibly multiple) muons in U decay implies muons must exist as U decay products, the absence of a resonant peak implies the 2-body decay $U \rightarrow \mu^+\mu^-$ should have small to negligible branching ratio. Interpreting U as a gauge boson, this suggest that leptons (or at least muons) should not have gauge couplings to U .

For $m_U \sim 1\text{GeV}$ the U lifetime (3.14) is still too short to account for the large impact factors of ghost muons. However if U is light, with quarks charged under it, then U may have no kinematically accessible on-shell 2-body decay modes. For example, it is trivially true that for $m_U < m_\pi$, no hadronic final states at all are accessible. This effect may be enhanced if U has family-dependent couplings so that - for example - U decays must necessarily involve second generation quarks. In any event, U is obliged to decay either through loops or off-shell hadrons which in turn decay to the observed particles. The additional suppression from such decays can then bring the U lifetime to the $\mathcal{O}(10)$ ps range necessary to account for the ghost muon anomaly. If such higher-order decays involve the weak interaction (or have as products short-lived hadrons with significant (semi)-leptonic decay modes) then muons can be produced in U decays without a resonant muon peak.

In summary, we propose that hyperweak forces could be responsible for the CDF ghost muon anomaly in the following way:

1. There exists a light hyperweak gauge boson U of mass $m_U \sim 1\text{GeV}$ under which (some) quarks are charged but muons are not charged. The U gauge coupling is substantially (possibly exponentially) weaker than the Standard Model gauge couplings.
2. U is produced relatively abundantly in high energy $p\bar{p}$ collisions either through direct production or through initial/final state radiation off quarks in any vanilla QCD event. In particular, U does not require TeV-scale new physics as a portal for its production.
3. U has no direct $\mu\mu$ coupling and kinematics forbids the direct decay of U into 2-body hadron final states. U is instead obliged to decay through off-shell hadronic final states. Kinematics require some of these off-shell processes to involve the weak interaction resulting in muons as a decay product.

4. The combination of the weakness of the initial gauge coupling, the lightness of U and the absence of direct kinematically accessible final states leads to a displaced U vertex and the macroscopic muon impact parameters observed by CDF.

Notice that this proposal to explain the CDF data can be considered independently of string theory. While we have assumed U to be a gauge boson motivated by the D3-D7 brane models considered in this paper, the same basic phenomenological approach could apply for any bulk state with very weak couplings to quarks and no kinematically accessible 2-body decays. In the LARGE volume scenario a mass $m_U \sim 1\text{GeV}$ (and a Standard Model scale vev) implies a volume of order $\mathcal{V} \sim 10^8$ which would correspond to $M_s \sim 10^{14}\text{GeV}$. It remains to be seen if with these numbers it is possible to obtain the proper U lifetime.

The above is clearly a phenomenological scenario and not yet a full model. More detailed model-building is necessary for a full analysis of the merits and further phenomenological and cosmological implications of the approach outlined. However, it provides a proposal for how such additional hyper-weak $U(1)$ s could manifest themselves in collider phenomenology with possible relevance for the current CDF ghost muon anomaly.

3.4.2 Masses of anomalous and non-anomalous $U(1)$ s

It is well known that in brane models masses can be generated through the Green-Schwarz mechanism for $U(1)$ gauge bosons that are non-anomalous. For global brane models, the masses of such $U(1)$ bosons are comparable to those of anomalous $U(1)$ bosons and are close to the string scale. In local models, the situation is more subtle as the non-anomalous $U(1)$ bosons are massless in the non-compact limit and only acquire masses on compactification. For large compact volumes the $U(1)$ masses are hierarchically lower than the string scale. Our purpose here is to compute the mass scale of such $U(1)$ s.

The relevant Lagrangian is

$$\mathcal{L} = -H_{\mu\nu\rho}H^{\mu\nu\rho} - \frac{1}{4g^2}F_{\mu\nu}F^{\mu\nu} - mD_2 \wedge F_2. \quad (3.15)$$

On dualising D_2 to a pseudoscalar this generates an explicit mass term $m^2 A_\mu A^\mu$ for the gauge boson. We consider a model of D7 branes wrapping a local (collapsed) 4-cycle X and use dimensional reduction to derive the above Lagrangian. The $D_2 \wedge F_2$ term descends from

$$\frac{2\pi}{(2\pi\sqrt{\alpha'})^8} \int \sum C_q \wedge e^{2\pi\alpha'F} \rightarrow \frac{1}{2\pi(2\pi\sqrt{\alpha'})^4} \int_{\mathbb{M}_4 \times X} F_2 \wedge C_4 \wedge F_2.$$

We can decompose C_4 as

$$C_4 = D_2^i(x) \wedge \omega_2^i(y) + a^i(x)\tilde{\omega}_4^i(y). \quad (3.16)$$

Here ω_2 is a harmonic 2-form with $\frac{1}{(2\pi\sqrt{\alpha'})^2} \int_{\Sigma_j} \omega_2^i = \delta_j^i$. Self-duality of $F_5 = dC_4$ relates D_2^i and a^i . Reduction of C_4 along the brane gives a coupling

$$\frac{Q_i}{2\pi(2\pi\sqrt{\alpha'})^2} \int D_2^i \wedge F_2,$$

where D_2 is dimensionless. $Q_i = \int_X \omega_2 \wedge F_2$ is simply a number which is unimportant for our purposes. Using $(2\pi\sqrt{\alpha'})^{-2} \sim M_s^2 \sim \frac{M_P^2}{\mathcal{V}}$, we can write the $D \wedge F$ coupling as

$$\frac{M_P^2}{\mathcal{V}} \int D_2 \wedge F_2 = \frac{M_P}{\mathcal{V}} \int (M_P D_2) \wedge F_2.$$

To compute the mass, we also need the normalisation of the kinetic term $H_{\mu\nu\rho}H^{\mu\nu\rho}$. This term descends from

$$\frac{1}{(2\pi\sqrt{\alpha'})^8} \int dC_4 \wedge *dC^4 = \frac{1}{(2\pi\sqrt{\alpha'})^8} \int dD_2^i \wedge *dD_2^j \int \omega_2^i \wedge (*\omega_2)^j.$$

If t^i represents a 2-cycle size with $\mathcal{V} = k_{ijk}t^i t^j t^k$, then [58]

$$\frac{1}{(2\pi\sqrt{\alpha'})^6} \int \omega_2^i \wedge *\omega_2^j = k_{ijk}t^k - \frac{3(k_{ipq}t^p t^q)(k_{irs}t^r t^s)}{2\mathcal{V}} \quad (3.17)$$

$$\equiv \mathcal{K}_{ij} - \frac{3\mathcal{K}_i \mathcal{K}_j}{2\mathcal{V}}. \quad (3.18)$$

This gives

$$\frac{1}{(2\pi\sqrt{\alpha'})^2} \int dD_2^i \wedge (*dD_2)^j \left(\mathcal{K}_{ij} - \frac{3\mathcal{K}_i \mathcal{K}_j}{2\mathcal{V}} \right). \quad (3.19)$$

Using $dD_2^i \wedge (*dD_2)^j = \sqrt{g}H_{\mu\nu\rho}^i H^{j,\mu\nu\rho}$, we obtain

$$\frac{1}{\mathcal{V}} \int \sqrt{g}(M_P H_{\mu\nu\rho})(M_P H^{\mu\nu\rho}) \left(\mathcal{K}_{ij} - \frac{3\mathcal{K}_i \mathcal{K}_j}{2\mathcal{V}} \right).$$

For anomalous $U(1)$ s, the dual 4-cycle is compact in the local geometry and $\mathcal{K}_{ij} \sim \mathcal{O}(1)$. For non-anomalous $U(1)$ s, the dual 4-cycle is non-compact and $\mathcal{K}_\alpha \sim \mathcal{V}^{2/3}$. The normalisation of the kinetic terms are therefore

$$\text{Anomalous } U(1)\text{s} \quad \int \sqrt{g} \left(\frac{M_P H_{\mu\nu\rho}^i}{\sqrt{\mathcal{V}}} \right) \left(\frac{M_P H^{j,\mu\nu\rho}}{\sqrt{\mathcal{V}}} \right) \quad (3.20)$$

$$\text{Non-anomalous } U(1)\text{s} \quad \int \sqrt{g} \left(\frac{M_P H_{\mu\nu\rho}^i}{\mathcal{V}^{1/3}} \right) \left(\frac{M_P H^{j,\mu\nu\rho}}{\mathcal{V}^{1/3}} \right) \quad (3.21)$$

The canonically normalised Lagrangians are then

$$\text{Anomalous } U(1)\text{s} \quad \sqrt{g}H_{\mu\nu\rho}H^{\mu\nu\rho} + \frac{1}{4g^2}F_{\mu\nu}F^{\mu\nu} + \frac{M_P}{\mathcal{V}^{1/2}}D_2 \wedge F_2. \quad (3.22)$$

$$\text{Non-Anomalous } U(1)\text{s} \quad \sqrt{g}H_{\mu\nu\rho}H^{\mu\nu\rho} + \frac{1}{4g^2}F_{\mu\nu}F^{\mu\nu} + \frac{M_P}{\mathcal{V}^{2/3}}D_2 \wedge F_2. \quad (3.23)$$

We conclude that anomalous $U(1)$'s have a string scale mass. For non-anomalous $U(1)$ s we therefore obtain¹²

$$M_{U(1)} = \frac{M_P}{\mathcal{V}^{2/3}}. \quad (3.24)$$

¹²This result agrees with a general expression found in [56]. For a discussion of volume dependence of massive $U(1)$ s in toroidal compactifications see [57].

This is the same mass scale of bulk KK modes, although the mode is associated with local 3-3 strings and has renormalisable couplings to the matter fields. For intermediate scale models ($M_s \sim 10^{11}$ GeV) this implies that the non-anomalous $U(1)$'s have a mass of 10^8 GeV, whereas for TeV string scale their mass is of order 10 MeV, which should have been observed if their couplings are not too weak

4. Supersymmetry Breaking in Global Embeddings

We want to study the structure of supersymmetry breaking in this framework. Aspects of this discussion have appeared in [21], which studied soft terms for local models in the geometric regime on the assumption of a realistic matter sector. We will discuss various forms of mediation mechanism and how they can contribute to the soft terms.

4.1 Gravity Mediation

As described in e.g. [59], gravity mediation arises from non-renormalisable contact interactions in the supergravity Lagrangian. The soft terms depend on the F-terms $F^i = e^{\tilde{K}/2} K^{i\bar{j}} D_{\bar{j}} W$ and are given by [59],

$$\begin{aligned} M_a &= \frac{F^i \partial_i f_a}{\text{Re}(f_a)}, \\ m_\alpha^2 &= m_{3/2}^2 - F^i F^{\bar{j}} \partial_i \partial_{\bar{j}} \ln \tilde{K}_\alpha, \\ A_{\alpha\beta\gamma} &= F^i \left(\partial_i K - \partial_i \ln(\tilde{K}_\alpha \tilde{K}_\beta \tilde{K}_\gamma) \right). \end{aligned} \quad (4.1)$$

The moduli F-terms for the LARGE volume minimum can be directly computed. This computation is described in [20, 21] and we shall simply state results. Important for this computation is that the matter field kinetic terms behave as

$$\mathcal{K} = \frac{C\bar{C}}{\mathcal{V}^{2/3}} \left(1 + \mathcal{O}(T_{SM} + \bar{T}_{SM})^\lambda + \dots \right) \quad (4.2)$$

Bulk moduli

The supersymmetry breaking is dominated by the volume modulus. The F-terms have canonical magnitude¹³

$$|F^{T_b}| \sim \frac{M_P^2}{\mathcal{V}}, \quad |F^{T_s}| \sim \frac{M_P^2}{\mathcal{V}^{3/2}}, \quad |F^S| \sim \frac{M_P^2}{\mathcal{V}^2}.$$

The dominant F-term is that of the volume modulus T_b , which naively gives non-zero soft terms of $\mathcal{O}(M_P/\mathcal{V}) = \mathcal{O}(m_{3/2})$. However at leading order the interactions of T_b take the no-scale form,

$$K = -3 \ln(T_b + \bar{T}_b) + \frac{C\bar{C}}{T_b + \bar{T}_b} + \dots, \quad W = W_0 + \dots$$

¹³By the canonical magnitude we mean that $|F^{T_b}| = |K_{b\bar{b}} F^b \bar{F}^{\bar{b}}|^{1/2}$. This differs from $F^i = e^{K/2} K^{i\bar{j}} D_{\bar{j}} W$ by factors of the Kähler metric, which are significant in the large volume limit. The canonical magnitude is the appropriate quantity to use in dimensional analysis estimates of soft terms, $m_{soft} = F/M_P$.

As is well known and can be easily checked, the induced soft terms vanish for no-scale models.

It is this fact that makes the computation of soft terms in this framework a delicate issue. The no-scale structure will certainly be lifted at higher order. For example, string loop corrections [60] give rise to corrections to the Kähler potential,

$$K = -3 \ln(T_b + \bar{T}_b) + \frac{\alpha}{T_b + \bar{T}_b} + \frac{C\bar{C}}{T_b + \bar{T}_b} \left(1 + \frac{\beta}{T_b + \bar{T}_b} \right), \quad W = W_0.$$

These higher order effects break no-scale and lead to non-vanishing soft terms. In this case direct evaluation shows the soft masses to be given by

$$m_Q^2 = m_{3/2}^2 \left(\frac{2(\alpha/3 - \beta)}{(T_b + \bar{T}_b)} + \dots \right). \quad (4.3)$$

Provided there is no cancellation between α and β , this generates soft masses at order

$$m_Q^2 \sim \frac{m_{3/2}^2}{(T_b + \bar{T}_b)} \sim m_{3/2}^2 \left(\frac{m_{3/2}}{M_P} \right)^{2/3}.$$

To have $m_Q \sim \text{TeV}$ this would imply a string scale of order 10^{13} GeV. A cancellation between α and β is equivalent to the statement that the physical Yukawa couplings do not depend on T_b even at subleading order in the volume: i.e. that the expression $\frac{e^{K/2}}{\sqrt{\bar{K}_\alpha \bar{K}_\beta \bar{K}_\gamma}}$ is independent of T_b .

While the breaking of no-scale is generic, any soft terms generated in this fashion are suppressed by factors of volume from the ‘natural’ soft term scale of $m_{3/2}$. As for $\mathcal{V} \gg 1$ this represents a very large suppression it is important to consider all other possible sources of supersymmetry breaking that may be induced.

The field T_s has $|F| \sim \frac{M_P^2}{\mathcal{V}^{3/2}}$ and so would be expected to generate soft terms at the scale $M_P/\mathcal{V}^{3/2} = m_{3/2} (m_{3/2}/M_P)^{1/2}$, whereas S has $|F| \sim \frac{M_P^2}{\mathcal{V}^{3/2}}$ and so would give $|F| \sim \frac{M_P^2}{\mathcal{V}^2}$. If we want F^{T_s} to be of order TeV, this would require a string scale of order $10^{13} - 10^{14}$ GeV. For branes at singularities the dilaton is the gauge coupling superfield and so soft terms of this order seem unavoidable. The question is whether there are larger contributions.

In [20, 21] it was assumed that the Standard Model could be realised on a stack of branes wrapping the cycle T_s . As a local model, the coupling of T_s to the Standard Model is then suppressed by only the string scale (i.e M_s not M_P) and soft terms are generated at order $|F^{T_s}|/M_s \sim m_{3/2}$. However, we have seen that due to the clash between chirality and moduli stabilisation, this is not possible.

Local Blow-up Moduli

Another potential source of soft terms are the local blow-up moduli. These are directly coupled to Standard Model matter. Being local, they also couple with string scale suppression and if these break supersymmetry they generate direct moduli mediated soft terms.

For explicitness here we focus on the dP_0 case where there are two anomalous $U(1)$ s. The twisted sector moduli are charged under the two anomalous $U(1)$ s. These transform as

$$T_{SM} \rightarrow T_{SM} + iQ\lambda, \quad B_2 \rightarrow B_2 + iQ_B\lambda',$$

where λ, λ' are the gauge parameters of the two anomalous $U(1)$ s. There is no loss of generality in making T_{SM} charged under $U(1)_1$ and B_2 charged under $U(1)_2$. The gauge-invariant Kähler potential for these fields is

$$\mathcal{K}(T_{SM} + \bar{T}_{SM}) \rightarrow \mathcal{K}(T_{SM} + \bar{T}_{SM} + QV_{U(1)}),$$

where V is the vector multiplet for the anomalous $U(1)$. A similar expression holds for B_2 . On expanding $\int d^4\theta \mathcal{K}$, this generates both an FI term for the $U(1)$ and also a mass term for the $U(1)$. The FI term ξ is given by

$$\int d^4\theta \xi V, \quad \xi = \left. \frac{\partial \mathcal{K}}{\partial V} \right|_{V=0} = Q \left. \frac{\partial \mathcal{K}}{\partial T} \right|_{V=0}.$$

In general supergravity D-terms are given by [61]

$$V_D = \frac{M_P^4}{2\text{Re}(f_a)} D^a D^a = \frac{M_P^4}{2\text{Re}(f_a)} (\eta_A^I \partial_I K - 3r_A)^2.$$

r_A is only non-zero for a gauged R-symmetry and so not relevant. η_A^I is the transformation, $\delta_A \Phi^I = \eta_A^I(\Phi)$. For moduli charged under an anomalous $U(1)$, $\eta^I = Q$. The D-term for an anomalous $U(1)$ is then

$$D_{U(1)} = \left(Q \partial_{T_{SM}} K + \sum_i q_i K_i \phi_i \right),$$

containing the appropriate Fayet-Iliopoulos term, where $K_i = \partial K / \partial \phi_i$. We can therefore write the D-term potential for the blow-up moduli as

$$V = V_{U(1)} + V_{U(1)'} = \frac{1}{\text{Re}(S)} \left(Q \partial_{T_{SM}} K + \sum_i q_i K_i \phi_i \right)^2 + \frac{1}{\text{Re}(S)} \left(Q' \partial_B K + \sum_i q'_i K_i \phi_i \right)^2. \quad (4.4)$$

This admits a minimum at $T = B = \phi = 0$, i.e. at the singular limit.

However, as the superpotential does not depend on T_{SM} , this implies that

$$\begin{aligned} F^{T_{SM}} &= e^{K/2} K^{T_{SM} \bar{T}_{SM}} D_{T_{SM}} W \\ &= e^{K/2} K^{T_{SM} \bar{T}_{SM}} K_{T_{SM}} W \\ &= 0. \end{aligned} \quad (4.5)$$

The essential point is that for the twisted moduli the magnitude of F-term susy breaking equals that of the FI term. At the singularity itself, the FI term vanishes and thus so does the F-term breaking, since both are proportional to $K_{T_{SM}}$. This holds even if we

postulate quantum corrections to the FI term such that the stable supersymmetric configuration is away from the singularity - the supergravity structure implies that cancellation of the FI term will lead to cancellation of the F-term.

Notice however that in general there are D-flat directions along which the singularity is partially resolved and the FI term is cancelled against matter field vevs¹⁴,

$$Q\partial_{T_{SM}}K = \sum q_i K_i \phi_i \neq 0.$$

Along this direction $F^{T_{SM}}$ is non-zero and soft terms are generated in the visible sector through the coupling of T_{SM} to Standard Model matter. Vevving along such a direction is not possible in the dP_0 Standard-like models but is possible (using the Z direction) in the dP_1 model. In this case, we expect conventional gravity mediation to be realised through the F-term associated to $F^{T_{SM}}$, except that the soft terms will be suppressed by M_s instead of M_P ($|F^{T_{SM}}|/M_s \sim m_{3/2}$).

Thus at the singularity the twisted moduli preserve supersymmetry and do not generate soft terms. If the singularity can be resolved with non-zero FI term cancelled against the matter field vevs, then soft terms can be generated at $\mathcal{O}(m_{3/2})$.

4.2 Anomaly Mediation

The vanishing of gravity-mediated soft terms may seem to suggest that anomaly-mediation may play an important role. However the dominant no-scale susy breaking structure implies that anomaly mediated contributions also vanish. For anomaly mediation in supergravity the gaugino mass formula from [62] is

$$m_{1/2} = \frac{g^2}{16\pi^2} \left[(3T_g - T_R)m_{3/2} + (T_G - T_R)K_i F^i + \frac{2T_R}{d_R} (\ln \det \tilde{K}|_R)_{,i} F^i \right]. \quad (4.6)$$

Evaluated for no-scale models, this vanishes. Anomaly mediation is therefore not capable of generating non-vanishing soft terms in this framework at leading order. Further corrections to K may induce non-vanishing contributions for soft-terms from anomaly mediation, but they will have the standard loop factor suppression over the corrections to the standard gravity mediation.

We note that it has recently been argued that the formula (4.6) is not fully correct [64], which would lead to a modification of the soft masses. A detailed discussion of these issues is outside the scope of this paper, and we refer the interested reader to [64] for a fuller discussion of this issue.

¹⁴In this more generic case the axionic component of T_{SM} mixes with the argument of the complex scalar field that gets a vev, one combination is eaten by the gauge field and the other combination remains massless and a candidate to be the QCD axion. This can be seen by noticing that $(A - \partial a)^2 + (A - \partial \theta)^2 = 1/2(2A - \partial(a + \theta))^2 + 1/2(\partial(a - \theta))^2$ which illustrates that for the two axions a and θ , the combination $a + \theta$ is eaten by the gauge field whereas the combination $a - \theta$ remains as an effective massless axion. Notice also that the axionic component of B_2 cannot be a proper axion since it appears explicitly in the DBI action and therefore it does not only have derivative couplings.

4.3 Gauge Mediation

A final and possibly surprising source of soft terms is gauge mediation. To see how this is possible, suppose we have a model such as dP_1 where there exists a non-anomalous $U(1)$ gauge boson that acquires masses through the Green-Schwarz mechanism. As calculated in section 3, the mass of such a $U(1)$ gauge boson is

$$M_{U(1)} \sim M_{KK,bulk} \sim \frac{M_P}{\mathcal{V}^{2/3}}.$$

The important point is that such $U(1)$ bosons have masses that are less than the local string/KK scale from which RG running should start, and so represent a threshold in renormalisation group running between the high scale and the weak scale. Such $U(1)$ s will enter into Feynman diagrams for squark propagators or for the running gauge coupling, and will affect quantities such as the gauge coupling RGEs.

However, the mass of these $U(1)$ s, and thus the threshold scale, is set by the volume, which is the field that breaks supersymmetry. This implies that (for example) the low-scale gauge coupling depends radiatively on the volume. At some level therefore such diagrams feel the breaking of supersymmetry and contribute to soft terms in the visible sector. However such soft terms will vanish both in the limit that gauge couplings go to zero, and also in the limit that the Planck mass is taken to infinity. They can also only be generated for models with an appropriate non-anomalous $U(1)$.

4.4 Summary

Let us summarise this section on supersymmetry breaking. At the singularity, all leading order contributions to the soft terms (both gravity and anomaly-mediation) vanish. If some of the twisted moduli are vev'd against matter fields, then these can break supersymmetry and generate non-vanishing soft terms of $\mathcal{O}(m_{3/2})$. Otherwise, the leading contributions to soft terms seems to come from sub-leading terms that are difficult to calculate and are volume-suppressed compared to $m_{3/2}$.

In all cases, the ‘mirror mediation’ mechanism for flavour universality is at work. The complex structure moduli, responsible for flavour play a subdominant role in supersymmetry breaking. Furthermore in the simplest del Pezzo singularities, the structure of the Yukawas is actually rigid and not even the complex structure moduli appear. Therefore approximate flavour universality is guaranteed in this scenario.

5. Conclusions

We have made progress into closing the gap between the local phenomenological D-brane models and the important issue of moduli stabilisation and supersymmetry breaking. Our main results can be summarised as follows.

- We generalised the previous constructions of realistic models on branes at singularities in the bottom-up approach to model building using recent developments in terms of quiver theories. The constructions can be generalised beyond orbifold singularities to include higher order del Pezzo and, in principle, infinite classes of singularities such as $Y_{p,q}$ and $L_{l,m,n}$. We used triplication of families and especially the global symmetries of the Yukawa couplings to select preferred models. We found that the main problem of dP_0 models, namely that the D3-D3 couplings lead to a mass matrix with eigenvalue $(M, M, 0)$ clearly against observations, is naturally solved if we move to more general singularities such as dP_1 for which the eigenvalues are of the form $(M, m, 0)$ with m hierarchically smaller than M , while keeping the other attractive properties of the models such as triplication of families.
- We argued that the LARGE volume scenario of moduli stabilisation *implies* the bottom-up approach of model building. This is relevant because the original justification of this approach was on the basis of simplicity of model construction. Now we can see that this is required from a concrete mechanism of moduli stabilisation.
- Being in the vicinity of a singularity implies a particular form of the local effective field theory. In particular Yukawa couplings do not vanish (contrary to the blown-up case). Also, the volume dependence of Kähler potentials for matter fields and blown-up modes were determined as well as an explicit derivation of the mass of anomalous and non-anomalous $U(1)$ s. The generic existence of hyperweak interactions coming from D7 branes wrapping the large cycle was emphasised and their potential phenomenological implications were outlined, including their potential relevance to recent CDF results. A more detailed study is left for the future.
- We outlined the minimal requirements to extend our model to a local compact Calabi-Yau compactification with moduli stabilised. In particular avoiding global/local mixing requires the Standard Model modulus to be fixed by a combination of D-terms and loop corrections to Kähler potential rather than the standard non-perturbative effects. This leaves the axionic partner of the blow-up mode (or a combination of this and the argument of the complex scalar field that gets a vev to cancel the FI contribution to the D-terms) unfixed which could play the role of QCD axion. An explicit construction for a compact model with all tadpoles cancelled is left for future work.
- The structure of soft supersymmetry breaking terms and their scales were estimated. In particular they are different from previous studies and require further investigation. Even though, as argued in the introduction, supersymmetry breaking requires a full global analysis, we have seen that due to the bulk no-scale structure the leading order contribution for soft supersymmetry breaking terms may be local. The F-term of the modulus corresponding to the Standard Model cycle may be responsible for the soft terms and its mediation is only suppressed by M_s instead of M_P . Other possible sources of soft terms are also allowed depending on the value of the blow-up mode

at the minimum of its potential. However a full phenomenological analysis of soft supersymmetry breaking is beyond the scope of this article.

- Even though our models were restricted to branes at singularities, many of our results should extend to more general compactifications such as F-theory constructions of GUT models [11, 63] which are also local. It is an interesting open question to make the connection directly between the LARGE volume scenario of moduli stabilisation and F-theory models, although direct connection with concrete local IIB orientifold models in terms of magnetised D7 branes should be tractable.

A. Non-anomalous $U(1)$ in the dP_1 quiver

We summarize the $U(1)$ charge assignments of fields in the dP_1 quiver in the table below. We denote the 73 strings stretching between the D7 node m_i and D3 node n_j as A^{ij} .

With these charge assignments it can be checked that the combination $Q = \sum \frac{Q_{ni}}{n_i}$ is indeed anomaly free, i.e the condition for absence of gravitational, $U^3(1)$ and mixed anomalies (involving all the non-abelian gauge groups) are satisfied

$$\sum_{\text{species}} Q = 0 \tag{A.1}$$

$$\sum_{\text{species}} Q^3 = 0 \tag{A.2}$$

$$\sum_{\text{rep}} Q \text{Tr}(T^a T^b) = 0 \tag{A.3}$$

Field	Q_{n1}	Q_{n2}	Q_{n3}	Q_{n4}	$Q = \sum \frac{Q_{ni}}{n_i}$
Φ	0	0	+1	-1	$+\frac{1}{n_3} - \frac{1}{n_4}$
Z_K	-1	0	0	+1	$-\frac{1}{n_1} + \frac{1}{n_4}$
X_i	+1	-1	0	0	$+\frac{1}{n_1} - \frac{1}{n_2}$
X_3	+1	-1	0	0	$+\frac{1}{n_1} - \frac{1}{n_2}$
Y_j	0	+1	-1	0	$+\frac{1}{n_2} - \frac{1}{n_3}$
Z_3	-1	0	+1	0	$-\frac{1}{n_1} + \frac{1}{n_3}$
Y_3	0	+1	0	-1	$+\frac{1}{n_2} - \frac{1}{n_4}$
A^{11}	-1	0	0	0	$-\frac{1}{n_1}$
A^{12}	0	+1	0	0	$+\frac{1}{n_2}$
A^{22}	0	-1	0	0	$-\frac{1}{n_2}$
A^{23}	0	0	+1	0	$+\frac{1}{n_3}$
A^{33}	0	0	-1	0	$-\frac{1}{n_3}$
A^{34}	0	0	0	+1	$+\frac{1}{n_4}$
A^{44}	0	0	0	-1	$-\frac{1}{n_4}$
A^{41}	+1	0	0	0	$+\frac{1}{n_1}$
A^{53}	0	0	-1	0	$-\frac{1}{n_3}$
A^{51}	1	0	0	0	$+\frac{1}{n_1}$
A^{62}	0	-1	0	0	$-\frac{1}{n_2}$
A^{64}	0	0	0	+1	$+\frac{1}{n_4}$

Acknowledgments

We are indebted to Angel Uranga for many patient explanations about singularities and many useful discussions on the subject of this work. We are also grateful for conversations with S. AbdusSalam, B. Allanach, M. Cicoli, M. Kreuzer, F. Marchesano, K. Narayan, E. Palti, H. Reall, S. Theisen and M. Schulz. JC thanks the Royal Society for a University Research Fellowship. FQ is partially funded by STFC and a Royal Society Wolfson award. AM and FQ thank the CERN theory group for hospitality during the ‘String Phenomenology Institute’. FQ also thank the organisers and participants of the ‘Stringy Reflections on the LHC’ at the Clay Mathematics Institute, for hospitality and many useful discussions.

References

- [1] V. Bouchard and R. Donagi, Phys. Lett. B **633** (2006) 783 [arXiv:hep-th/0512149].
- [2] V. Braun, Y. H. He, B. A. Ovrut and T. Pantev, JHEP **0605** (2006) 043 [arXiv:hep-th/0512177].
- [3] L. B. Anderson, Y. H. He and A. Lukas, JHEP **0707**, 049 (2007) [arXiv:hep-th/0702210].
- [4] H. P. Nilles, S. Ramos-Sanchez, M. Ratz and P. K. S. Vaudrevange, arXiv:0806.3905 [hep-th]; S. Raby, arXiv:0807.4921 [hep-ph].

- [5] R. Blumenhagen, M. Cvetič, P. Langacker and G. Shiu, *Ann. Rev. Nucl. Part. Sci.* **55**, 71 (2005) [arXiv:hep-th/0502005].
- [6] R. Blumenhagen, B. Kors, D. Lust and S. Stieberger, *Phys. Rept.* **445**, 1 (2007) [arXiv:hep-th/0610327].
- [7] F. Marchesano, *Fortsch. Phys.* **55** (2007) 491 [arXiv:hep-th/0702094].
- [8] G. Aldazabal, L. E. Ibáñez, F. Quevedo and A. M. Uranga, *JHEP* **0008** (2000) 002 [arXiv:hep-th/0005067].
- [9] D. Berenstein, V. Jejjala and R. G. Leigh, *Phys. Rev. Lett.* **88** (2002) 071602 [arXiv:hep-ph/0105042]; L. F. Alday and G. Aldazabal, *JHEP* **0205** (2002) 022 [arXiv:hep-th/0203129].
- [10] H. Verlinde and M. Wijnholt, *JHEP* **0701** (2007) 106 [arXiv:hep-th/0508089].
- [11] C. Beasley, J. J. Heckman and C. Vafa, arXiv:0802.3391 [hep-th].
- [12] R. Tatar and T. Watari, arXiv:0806.0634 [hep-th].
- [13] T. W. Grimm and A. Klemm, *JHEP* **0810** (2008) 077 [arXiv:0805.3361 [hep-th]].
- [14] Y. H. He, arXiv:hep-th/0408142; K. D. Kennaway, *Int. J. Mod. Phys. A* **22** (2007) 2977 [arXiv:0706.1660 [hep-th]].
- [15] M. R. Douglas and S. Kachru, *Rev. Mod. Phys.* **79**, 733 (2007) [arXiv:hep-th/0610102].
- [16] F. Denef, arXiv:0803.1194 [hep-th].
- [17] S. B. Giddings, S. Kachru and J. Polchinski, *Phys. Rev. D* **66**, 106006 (2002) [arXiv:hep-th/0105097].
- [18] S. Kachru, R. Kallosh, A. Linde and S. P. Trivedi, *Phys. Rev. D* **68**, 046005 (2003) [arXiv:hep-th/0301240].
- [19] V. Balasubramanian, P. Berglund, J. P. Conlon and F. Quevedo, *JHEP* **0503**, 007 (2005) [arXiv:hep-th/0502058].
- [20] J. P. Conlon, F. Quevedo and K. Suruliz, *JHEP* **0508**, 007 (2005) [arXiv:hep-th/0505076].
- [21] J. P. Conlon, S. S. Abdussalam, F. Quevedo and K. Suruliz, *JHEP* **0701**, 032 (2007) [arXiv:hep-th/0610129].
- [22] J. P. Conlon, *JHEP* **0803**, 025 (2008) [arXiv:0710.0873 [hep-th]].
- [23] E. Dudas, Y. Mambrini, S. Pokorski, A. Romagnoni and M. Trapletti, arXiv:0809.5064 [hep-th].
- [24] J. F. G. Cascales, M. P. Garcia del Moral, F. Quevedo and A. M. Uranga, *JHEP* **0402**, 031 (2004) [arXiv:hep-th/0312051].
- [25] F. Marchesano and G. Shiu, *JHEP* **0411** (2004) 041 [arXiv:hep-th/0409132].
- [26] I. Antoniadis, A. Kumar and T. Maillard, *Nucl. Phys. B* **767** (2007) 139 [arXiv:hep-th/0610246].
- [27] C. M. Chen, T. Li, V. E. Mayes and D. V. Nanopoulos, *Phys. Rev. D* **77** (2008) 125023 [arXiv:0711.0396 [hep-ph]].
- [28] R. Blumenhagen, S. Moster and E. Plauschinn, *JHEP* **0801**, 058 (2008) [arXiv:0711.3389 [hep-th]].

- [29] M. Dine and N. Seiberg, Phys. Lett. B **162** (1985) 299.
- [30] J. P. Conlon, A. Maharana and F. Quevedo, JHEP **0809**, 104 (2008) [arXiv:0807.0789 [hep-th]].
- [31] M. R. Douglas and G. W. Moore, arXiv:hep-th/9603167.
- [32] B. Feng, A. Hanany and Y. H. He, Nucl. Phys. B **595** (2001) 165 [arXiv:hep-th/0003085].
- [33] M. Wijnholt, Adv. Theor. Math. Phys. **7** (2004) 1117 [arXiv:hep-th/0212021].
- [34] S. Franco and A. M. Uranga, JHEP **0606** (2006) 031 [arXiv:hep-th/0604136].
- [35] L. E. Ibáñez and F. Quevedo, JHEP **9910** (1999) 001 [arXiv:hep-ph/9908305].
- [36] G. Aldazabal, L. E. Ibáñez and F. Quevedo, JHEP **0002**, 015 (2000) [arXiv:hep-ph/0001083]; JHEP **0001** (2000) 031 [arXiv:hep-th/9909172].
- [37] I. Antoniadis, E. Kiritsis and T. N. Tomaras, Phys. Lett. B **486** (2000) 186 [arXiv:hep-ph/0004214].
- [38] M. Wijnholt and A. Uranga, private communication.
- [39] B. R. Greene, K. H. Kirklin, P. J. Miron and G. G. Ross, Phys. Lett. B **192**, 111 (1987).
- [40] L. E. Ibáñez and A. M. Uranga, JHEP **0802** (2008) 103 [arXiv:0711.1316 [hep-th]].
- [41] S. P. de Alwis, Phys. Lett. B **628** (2005) 183 [arXiv:hep-th/0506267]; A. Achucarro, S. Hardeman and K. Sousa, arXiv:0806.4364 [hep-th].
- [42] M. Cicoli, J. P. Conlon and F. Quevedo, arXiv:0805.1029 [hep-th].
- [43] M. Berg, M. Haack and E. Pajer, JHEP **0709**, 031 (2007) [arXiv:0704.0737 [hep-th]].
- [44] J. P. Conlon and F. Quevedo, JHEP **0606**, 029 (2006) [arXiv:hep-th/0605141].
- [45] A. Misra and P. Shukla, Nucl. Phys. B **799** (2008) 165 [arXiv:0707.0105 [hep-th]].
- [46] E. Palti, G. Tasinato and J. Ward, JHEP **0806** (2008) 084 [arXiv:0804.1248 [hep-th]].
- [47] L. Aparicio, D. G. Cerdeno and L. E. Ibáñez, JHEP **0807**, 099 (2008) [arXiv:0805.2943 [hep-ph]].
- [48] R. Blumenhagen, S. Moster and E. Plauschinn, arXiv:0806.2667 [hep-th].
- [49] K. Hristov, arXiv:0810.3329 [hep-th].
- [50] J. P. Conlon, D. Cremades and F. Quevedo, JHEP **0701**, 022 (2007) [arXiv:hep-th/0609180].
- [51] J. P. Conlon and F. Quevedo, JCAP **0708** (2007) 019 [arXiv:0705.3460 [hep-ph]].
- [52] C. P. Burgess, J. P. Conlon, L. Y. Hung, C. H. Kom, A. Maharana and F. Quevedo, JHEP **0807**, 073 (2008) [arXiv:0805.4037 [hep-th]].
- [53] I. Antoniadis, E. Kiritsis and T. Tomaras, Fortsch. Phys. **49**, 573 (2001) [arXiv:hep-th/0111269].
- [54] T. Aaltonen *et al.* [CDF Collaboration], arXiv:0810.5357 [hep-ex].
- [55] A. Collinucci, F. Denef and M. Esole, arXiv:0805.1573 [hep-th].
- [56] M. Buican, D. Malyshev, D. R. Morrison, H. Verlinde and M. Wijnholt, JHEP **0701** (2007) 107 [arXiv:hep-th/0610007].

- [57] I. Antoniadis, E. Kiritsis and J. Rizos, Nucl. Phys. B **637** (2002) 92 [arXiv:hep-th/0204153].
- [58] P. Candelas and X. de la Ossa, Nucl. Phys. B **355**, 455 (1991).
- [59] A. Brignole, L. E. Ibáñez and C. Muñoz, arXiv:hep-ph/9707209.
- [60] M. Berg, M. Haack and B. Kors, JHEP **0511**, 030 (2005) [arXiv:hep-th/0508043].
- [61] P. Binetruiy, G. Dvali, R. Kallosh and A. Van Proeyen, Class. Quant. Grav. **21** (2004) 3137 [arXiv:hep-th/0402046].
- [62] J. A. Bagger, T. Moroi and E. Poppitz, JHEP **0004**, 009 (2000) [arXiv:hep-th/9911029].
- [63] C. Beasley, J. J. Heckman and C. Vafa, arXiv:0806.0102 [hep-th].
- [64] S. P. de Alwis, Phys. Rev. D **77**, 105020 (2008) [arXiv:0801.0578 [hep-th]].