

Investigation of resonant and transient phenomena in Josephson junction flux qubits

Jeffrey E. Marchese

Department of Applied Science, University of California, Davis, California 95616

Matteo Cirillo

Dipartimento di Fisica and MINAS-Lab, Università di Roma "Tor Vergata", I-00173 Roma, Italy

Niels Grønbech-Jensen

Department of Applied Science, University of California, Davis, California 95616

(Dated: December 25, 2018)

We present an analytical and computational study of resonances and transient responses in a classical Josephson junction system. A theoretical basis for resonances in a superconducting loop with three junctions is presented, outlining both the direct relationship between the dynamics of single- and multi-junction systems, and the direct relationships between observations of the classical counterparts to Rabi oscillations, Ramsey fringes, and spin echo oscillations in this class of systems. We show simulation data along with analytical analyses of the classical model, and the results are related to previously reported experiments conducted on three junction loops. We further investigate the effect of off-resonant microwave perturbations to, e.g., the Rabi-type response of the Josephson system, and we relate this response back to the nonlinear and multi-valued resonance behavior previously reported for a single Josephson junction. The close relationships between single and multi-junction behavior demonstrates the underlying dynamical mechanism for a whole class of classical counterparts to expected quantum mechanical observations in a variety of systems; namely the resonant and transient behavior of a particle in an anharmonic potential well with subsequent escape.

I. INTRODUCTION

Since the mid 1980's several experiments have sought to establish that Josephson systems show evidence of quantum interference of macroscopically distinct states. Various configurations have been utilized to elicit the phenomenon, including current-biased single-junction circuits [1, 2, 3, 4, 5], flux-biased two-junction SQUIDs [6], charge-biased two-junction SQUIDs [7], flux-biased three-junction SQUIDs [8, 9, 10, 11, 12, 13], charge-biased three-junction SQUIDs [14], and hybrid systems which often include inductor-based systems to create multiple potential wells [15, 16, 17, 18, 19]. The phenomena observed to date include multi-peaked probability distributions in bias current, Rabi oscillations [20], Ramsey fringes [21], spin-echo oscillations [22], and quantum tomography [23].

In several recent investigations the authors of the present paper have contributed to an alternative interpretation of the basic types of experiments on Josephson junctions. This interpretation relies on the well established phenomenology of the Resistively and Capacitively Shunted Junction (RCSJ) model [24] and on nonlinear dynamics related to it. Multi-peaked resonances were addressed in Refs. [25-27] while References [28,29] developed analytical expressions and presented computer simulations which described the relationships between classical Rabi-type oscillations, driving amplitude and frequency, and systematic dissipation. The related phenomena of Ramsey-fringes and spin-echo oscillations are depicted and described from a classical point of view in Refs. [30,31]. While this exemplifies the phenomena through current-biased single-junction circuits, we submit that a wide class of Josephson systems exhibits same behavior when a system variable is trapped in a potential well [32]. This presentation will amplify this point.

A few examples of multi-junction systems for which direct comparisons between classical theory and experimental results have been made in the low temperature regime, where quantum phenomena should be observed, include multi-peaked resonances in Josephson interferometers, made of two junctions connected in parallel [33], and a more complex Josephson interferometer-based device [34] containing a double-SQUID, in which a butterfly catastrophe was observed at 10 mK. In both cases, the standard classical RCSJ model provided sufficient detail to understand the experimental observations.

The observations from interferometer systems described in the last paragraph encouraged us [32] to extend the classical ideas and implementations developed for the single junctions and two-junction interferometers to the more complex system of the flux-biased three-junction loop [10, 11, 12, 35]. It is the plan of the present paper to report on our approach to this problem. In this approach the analysis of the most important features of three junctions loop under the influence of pulsed microwaves was precluded by a study of analogous single junction phenomenology.

In the next section we derive the basic equations for the three junction loop and present an analytical description of resonances in the system. In sect. 3 we demonstrate computer simulations which map the resonances as a function of the biases (the magnetic flux in the loop). Simulations are shown which depict the Rabi-type oscillations, Ramsey-type

fringes and spin-echo-type oscillations in the three-junction loop. Also, off-resonant in the three-junction loop are explored. Our simulations and analytical treatment allow us to interpret the essential experimental features reported for Josephson circuits.

II. THREE-JUNCTION LOOP RCSJ MODEL

A. Single-junction theory

Figure 1(a) depicts the single Josephson junction RCSJ model. Such a physical system is also referred to as Josephson phase qubit. The normalized classical equation can be written[24]

$$\ddot{\varphi} + \alpha\dot{\varphi} + \sin \varphi = \eta + \varepsilon_s \sin(\omega_s t + \theta_s) + \varepsilon_p(t) + n(t), \quad (1)$$

where φ is the difference between the phases of the quantum mechanical wave functions defining the junction, η represents the dc bias current, and $\varepsilon_s(t)$ and ω_s represent microwave current amplitude and frequency, respectively. All currents are normalized to the critical current I_c , and time is measured in units of the inverse plasma frequency, ω_0^{-1} , where $\omega_0^2 = 2eI_c/\hbar C = 2\pi I_c/\Phi_0 C$, C being the capacitance of the junction and $\Phi_0 = h/2e$ the flux quantum. Tunneling of quasiparticles is represented by the dissipative term, where $\alpha = \hbar\omega_0/2eRI_c$ is given by the shunt resistance R , and the accompanying thermal fluctuations are defined by the normalized dissipation-fluctuation relationship[36]

$$\langle n(t) \rangle = 0 \quad (2)$$

$$\langle n(t)n(t') \rangle = 2\alpha \frac{k_B T}{H_J} \delta(t - t') = 2\alpha \Theta \delta(t - t'), \quad (3)$$

T being the temperature and H_J is the characteristic Josephson energy $H_J = I_c \hbar/2e$.

The normalized energy, $(H - H_0)$ is defined by

$$H = \frac{1}{2}\dot{\varphi}^2 + 1 - \cos \varphi - \eta\varphi \quad (4)$$

$$H_0 = 1 - \sqrt{1 - \eta^2} - \eta \sin^{-1} \eta, \quad (5)$$

where H_0 is the energy at the minimum of a potential well. In Refs.[28,29] a classical analysis is presented for the modulated frequency, which is small when compared to the driving signal ω_s , and referred to as the Rabi-type oscillation frequency Ω_R due to its direct relationship with experimentally reported Rabi oscillations.

B. Three junction loop theory

Figure 1b depicts the three-junction loop which will be the subject of the analysis of this paper. We concentrate our study on this system which has been the core of several experiments and theoretical analyses[35]. It consists of a superconducting loop containing two identical junctions and one with smaller capacity and critical current. The normalized classical equations can be written [35, 37],

$$\begin{aligned} \ddot{\varphi}_1 + \alpha\dot{\varphi}_1 + \sin \varphi_1 &= \frac{-1}{\beta_L} [2\pi M(t) + \varphi_1 + \varphi_2 + \varphi_3] + n_1(t) \\ \ddot{\varphi}_2 + \alpha\dot{\varphi}_2 + \sin \varphi_2 &= \frac{-1}{\beta_L} [2\pi M(t) + \varphi_1 + \varphi_2 + \varphi_3] + n_2(t) \\ \ddot{\varphi}_3 + \alpha\dot{\varphi}_3 + \sin \varphi_3 &= \frac{-1}{\kappa\beta_L} [2\pi M(t) + \varphi_1 + \varphi_2 + \varphi_3] + n_3(t). \end{aligned} \quad (6)$$

where φ_i is the difference between the phases of the quantum mechanical wave functions defining the i th junction, κ is the scale factor relating the one smaller junction, represented by φ_3 , to the other two larger junctions, β_L is the normalized loop inductance $\beta_L = 2\pi LI_c/\Phi_0$. $M(t)$ is a composite of the various external magnetic fluxes to which the system is exposed

$$M(t) = M_{dc} + \varepsilon_s(t) \sin(\omega_s t + \theta_s) + \varepsilon_p(t), \quad (7)$$

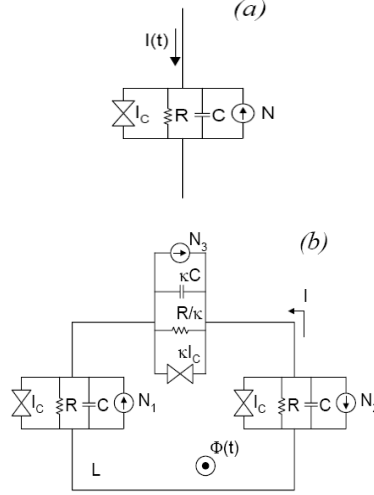

FIG. 1: Circuit diagram for (a) the single junction model and (b) the three junction loop. In (b) the smaller junction is indicated by the factor κ applied to the capacitance, resistance, and critical current.

where M_{dc} represents the dc bias flux, and $\varepsilon_s(t)$ and ω_s represent the ac flux (signal) amplitude and frequency, respectively. A flux pulse for probing the state of the system is represented by $\varepsilon_p(t)$.

We identify a Hamiltonian for the system for the undamped ($\alpha = 0$) system as

$$H = H_k + H_p \quad (8)$$

$$H_k = \frac{1}{2}(\dot{\varphi}_1^2 + \dot{\varphi}_2^2 + \kappa\dot{\varphi}_3^2) \quad (9)$$

$$H_p = 2 - \cos \varphi_1 - \cos \varphi_2 + \kappa(1 - \cos \varphi_3) + \frac{1}{2\beta_L}(\varphi_1 + \varphi_2 + \varphi_3 + 2\pi M)^2. \quad (10)$$

For small β_L in Eq. (8), we can see that energy from the loop current (last term) dictates the sum of the phases. We may therefore use the following orthogonal (and therefore separable) transformation to analyze the system:

$$\left. \begin{aligned} \psi_1 &= \varphi_1 + \varphi_2 + \varphi_3 \\ \psi_2 &= \varphi_1 - \varphi_2 \\ \psi_3 &= -\frac{1}{1+2\kappa}(\varphi_1 + \varphi_2) + \frac{2\kappa}{1+2\kappa}\varphi_3 \end{aligned} \right\} \Leftrightarrow \left\{ \begin{aligned} \varphi_1 &= \frac{\kappa}{1+2\kappa}\psi_1 + \frac{1}{2}\psi_2 - \frac{1}{2}\psi_3 \\ \varphi_2 &= \frac{\kappa}{1+2\kappa}\psi_1 - \frac{1}{2}\psi_2 - \frac{1}{2}\psi_3 \\ \varphi_3 &= \frac{1}{1+2\kappa}\psi_1 + \psi_3 \end{aligned} \right.$$

The Hamiltonian now reads

$$\begin{aligned} H_k &= \frac{1}{2}(\kappa\dot{\psi}_1^2 + \dot{\psi}_2^2 + \frac{1}{2}(1+2\kappa)\dot{\psi}_3^2) \\ H_p &= 2 - 2\cos\frac{\psi_2}{2}\cos\left(\frac{\kappa}{1+2\kappa}\psi_1 - \frac{1}{2}\psi_3\right) \\ &\quad + \kappa\left[1 - \cos\left(\frac{1}{1+2\kappa}\psi_1 + \psi_3\right)\right] + \frac{1}{2\beta_L}(\psi_1 + 2\pi M)^2. \end{aligned} \quad (11)$$

Under the condition $\beta_L \ll 1$, this system can be simplified to a single degree of freedom by examining the constraints which frame ψ_1 and ψ_2 . First, it can be seen from Eq. (11) that potential energy considerations prevent the deviation of ψ_1 far from $-2\pi M$.

A second constraint, on ψ_2 , is obtained by considering the equation of motion

$$\ddot{\psi}_2 + \alpha\dot{\psi}_2 + 2\cos\left(\frac{\kappa}{1+2\kappa}\psi_1 - \frac{1}{2}\psi_3\right)\sin\frac{\psi_2}{2} = n_1(t) - n_2(t).$$

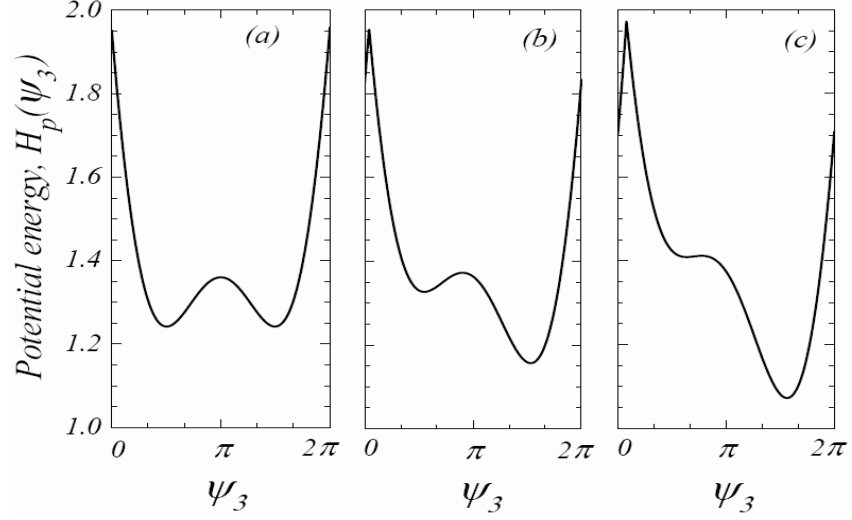

FIG. 2: Three-junction loop Potential Energy in terms of the reduced variable ψ_3 . Each view represents a different value of M_{dc} : (a) $M_{dc} = 0.5$, (b) $M_{dc} = 0.52$, and (c) $M_{dc} = 0.542$. Other parameters are $\kappa = 0.68$ and $\beta = 0.09559$.

From this it can be seen that the static equilibrium value of ψ_2 is given by

$$\cos \frac{\psi_2}{2} = \begin{cases} 1 & \text{for } \cos\left(\frac{\kappa}{1+2\kappa}\psi_1 - \frac{1}{2}\psi_3\right) > 0 \\ -1 & \text{for } \cos\left(\frac{\kappa}{1+2\kappa}\psi_1 - \frac{1}{2}\psi_3\right) < 0 \end{cases} \quad (12)$$

Note that this is a *weak* constraint as it does not require much energy to break the equilibrium. Equation (11) can now be written

$$H_p = 2 \mp 2 \cos\left(\frac{\kappa}{1+2\kappa}\psi_1 - \frac{1}{2}\psi_3\right) + \kappa\left(1 - \cos\left(\frac{1}{1+2\kappa}\psi_1 + \psi_3\right)\right) + \frac{1}{2\beta_L}(\psi_1 + 2\pi M)^2, \quad (13)$$

where \pm refers to the optimized choice based on Eq. (12). The constraint on ψ_1 can be determined by minimizing H_p with respect to ψ_1

$$\begin{aligned} \frac{\partial H_p}{\partial \psi_1} &= \frac{\pm 2\kappa}{1+2\kappa} \sin\left(\frac{\kappa}{1+2\kappa}\psi_1 - \frac{1}{2}\psi_3\right) \\ &\quad + \frac{\kappa}{1+2\kappa} \sin\left(\frac{1}{1+2\kappa}\psi_1 + \psi_3\right) + \frac{1}{\beta_L}(\psi_1 + 2\pi M) = 0 \\ \Rightarrow \psi_1 &= -2\pi M - \beta_L \delta_1 \\ &\approx -2\pi M - \beta_L \frac{\kappa}{1+2\kappa} \left[\mp 2 \sin\left(\frac{2\pi M \kappa}{1+2\kappa} + \frac{1}{2}\psi_3\right) + \sin\left(\psi_3 - \frac{2\pi M}{1+2\kappa}\right) \right], \end{aligned}$$

which is correct to first order in β_L .

The potential energy can now be approximated by a function of ψ_3 only

$$H_p = 2 \mp 2 \cos\left(\frac{2\pi M \kappa}{1+2\kappa} + \frac{1}{2}\psi_3\right) + \kappa - \kappa \cos\left(\psi_3 - \frac{2\pi M}{1+2\kappa}\right) - \frac{\beta_L}{2} \delta_1^2,$$

where the choice between \mp should be such that the energy is minimized.

Figure 2 depicts this single-degree-of-freedom representation of the potential energy. Note that while, in general, this potential consists of pairs of wells separated by higher energy ‘cusps’, for purposes of this work we focus on a single well-pair, as the energies are kept below these cusps. Calculating the linear resonance frequency for a given well, the equation of motion for the friction-less and constant- M system is

$$\frac{1}{2}(1+2\kappa)\ddot{\psi}_3 + \frac{\partial H_p}{\partial \psi_3} = 0,$$

such that the fixed point ψ_3^* is given by

$$\left. \frac{\partial H_p}{\partial \psi_3} \right|_{\psi_3=\psi_3^*} = 0$$

and for small oscillations δ around the fixed point $\psi_3 = \psi_3^* + \delta$ provide the linear resonance frequency ω_l

$$\frac{1}{2}(1+2\kappa)\ddot{\delta} + \left. \frac{\partial^2 H_p}{\partial \psi_3^2} \right|_{\psi_3^*} \delta = 0 \Rightarrow \quad (14)$$

$$\omega_l = \sqrt{2 \left. \frac{\partial^2 H_p}{\partial \psi_3^2} \right|_{\psi_3^*} / (1+2\kappa)}. \quad (15)$$

In the next section we will use this result to characterize the switching statistics of microwave induced excitations in the classical model of the three-junction superconducting loop.

III. SIMULATION RESULTS

A convention we adopt in this work is to adjust the arbitrary integer associated with multi-valued nature of the flux bias such that: $\{|M_{dc}| \leq 0.5\}$ represents a configuration which initially places the inter-well barrier at a value of ψ_3 which is higher than the minimum of lower-energy well. Also, applied forces are defined as positive if they act to push the reduced phase-difference ψ_3 in a positive direction. In order to best describe the experimental reality the temperatures that we consider are in the tens of millikelvin range

To verify equation (14), we conducted computer simulations of pulsed microwave spectroscopy for the three-junction loop described by equation (6). The results are shown in the dispersion chart, Fig. 3. Each open circle represents the minimum flux pulse ε_p required to obtain a statistical response of 50% escape probability. Each trial in the simulation is conducted in the following manner: with initial conditions of ψ_3 in the minimum energy configuration [according to the above convention] and $\dot{\psi}_3 = 0$, the system is driven at frequency ω_s and amplitude ε_s for a period of $(2/\alpha)$. At the end of the driving phase and after a slight pause (50 time units), a pulse of magnitude ε_p is applied (in similar fashion to reference [30]) and the subsequent escape or non-escape to the alternate well is recorded. Statistics are then gathered to determine $\varepsilon_p^{50\%}$ for varying frequency. A resonance is determined for each value of M_{dc} , as indicated by a minimum value of $\varepsilon_p^{50\%}$ as a function of frequency.

The solid line in Fig. 3 represents the resonant frequency response as predicted by Eq. (14). The open circles indicate the simulation results and depict the minimum amplitude probe pulse ε_p for which the escape rate equals 50%. The inset shows the relationship between probe pulse (at 50% escape probability) and signal frequency for $M_{dc} = 0.48$. The minimum energy value in each well is marked with a boxed symbol to establish the correspondence with the potential energy plot. The dashed line indicates the symmetric relationship in linear resonance frequency (about $M_{dc} = 0.5$) for a well placement convention which is opposite to our convention. The data presented is based on 2500-7000 escape events ; the simulation results show close agreement with our theory although the agreement diminishes slightly for increasing values of M_{dc} . This can be understood by noting that as the flux bias is increased, the higher of the two wells becomes broader, allowing larger oscillations, which corresponds to a greater degree of anharmonic behavior.

Next we investigated whether the results obtained on the linear resonance frequency calculated from Eq. 14 will generate features consistent with what one could expect from spectroscopic measurements on real Josephson junction systems. Thus we adapted our simulations to generate Rabi-type oscillations, Ramsey-type fringes, and spin-echo-type oscillations [30, 31]. The recipes for generating these oscillations follow closely the ones described in the previous publications for the single junction model and a summary of the signalling used for generating Rabi-oscillations, Ramsey-fringes, and spin-echo is shown in Figure 4 together with the idealized phase responses in the two relevant cases of escape and no-escape from the potential well.

Our statistical simulation results are shown in Figs. 5 and 6 . The normalized slope that we extract from the linear dependency of the Rabi frequency versus ac amplitude Fig. 5b) is very close to that of the experimental results reported in Fig. 4b of Ref. [12] and with Fig. 4b of Ref. [10]. We conclude that our numerical and analytical results are quite consistent with the experimental reality. As far as the Ramsey fringes are concerned, if we compare Fig. 5d in this presentation with the results reported in Fig. 4d of Ref. [12], we also find very good agreement in the Ramsey fringe being represented by a unity-sloped V-shaped fringe frequency dependence on the microwave detuning from the oscillator resonance. Thus, just as it has been demonstrated for Rabi oscillations, the classical system exhibits a signature similar, if not identical, to what one would expect from quantum theory.

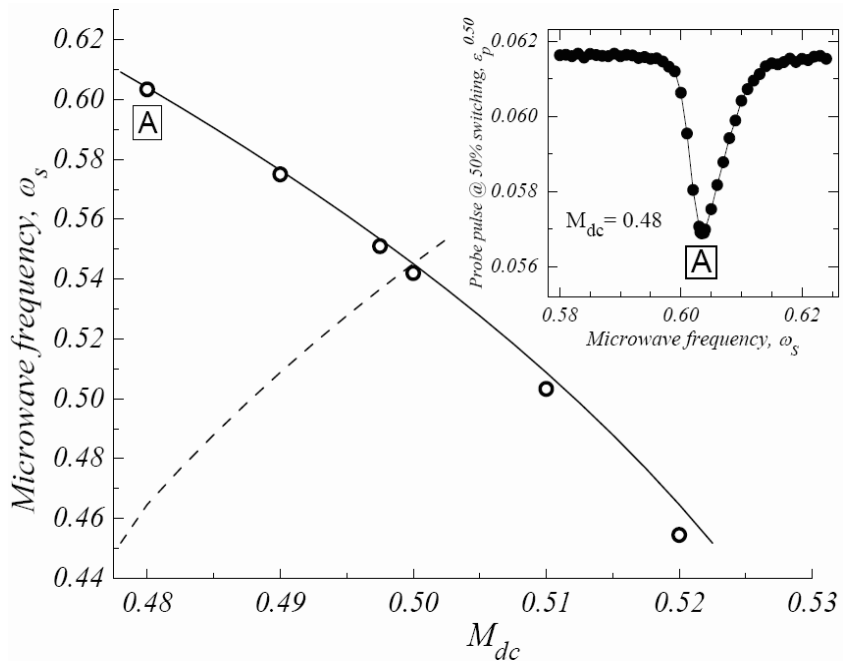

FIG. 3: Resonant frequency response in the three-junction loop. Lines represent the predicted frequency response from Eq. (14). The open circles indicate the resonances from the results of our simulations. The inset is a switching distribution indicating the resonance at the box marked 'A'. This provides an example of the placement for the open circles in the larger plot. Parameters for the simulation were $\beta_L = 0.09994$, $\kappa = 0.68$, $\alpha = 4 \cdot 10^{-5}$, $\varepsilon_s = 4 \cdot 10^{-4}$, and $\Theta(T) = 9.12 \cdot 10^{-3}$. The dashed line indicates the symmetric relationship in linear resonance frequency. The data presented is based on 2500-7000 escape events.

The classical result, leading to the Ramsey fringe frequency being identical to the detuning between the applied microwave frequency ω_s and the intrinsic resonance ω_r of the oscillator, can be rationalized by considering the system behavior in the interval between the two $\pi/2$ -pulses. The oscillator is, at the time of the conclusion of the first $\pi/2$ -pulse, defined by a specific phase-relationship (phase-locking) to the phase of the π -pulse. This phase-relationship is free to detune in the (ballistic) interval Δt between the two $\pi/2$ -pulses, and the mutual phase detuning θ_F between the microwave field and the oscillator is therefore given by

$$\theta_F = \int_0^{\Delta t} (\omega_s - \omega_r(t)) dt ,$$

where ω_r can be a (weak) function of time due to the anharmonicity of the potential energy; i.e., as the oscillation amplitude decreases, due to the intrinsic damping in the system, the natural resonance frequency of the oscillator increases. However, for a lightly damped system, where $\alpha \Delta t \ll 1$, the above time integration can be simplified, and the result for the Ramsey fringe frequency Ω_F becomes

$$\Omega_F = \frac{\theta_F}{\Delta t} \approx \omega_s - \omega_r ,$$

which is exactly the detuning between the applied microwave frequency and the natural resonance frequency of the oscillator in the phase-locked state. Thus, the observed Ramsey fringe frequency dependence on the microwave detuning from resonance is easily understood classically for this system, and the intrinsic oscillator frequency $\omega_r \lesssim \omega_l$ is close to the microwave frequency that results in $\Omega_F \approx 0$. We submit that this detuning is also causing the so-called spin-echo measurements, which are generated by maintaining a constant temporal separation between the two $\pi/2$ -pulses from Ramsey fringe measurements, and then inserting a π -pulse. The final phase-relationship between the oscillator and the external microwave signal is detected by the second $\pi/2$ -pulse, but this phase-relationship is now subject to the phase-twisting caused by the inserted π -pulse, which in turn depends on the detuning at the time of π -pulse initiation. Thus, while the Rabi-frequency determines the magnitude and duration of the microwave pulses used in Ramsey-fringe experiments, it is the Ramsey-fringe frequency that determines the echo from the detuning at the time of the initiation of the π -pulse [31].

In previous work, and here in Fig. 5b, we have considered Rabi-type oscillations using the resonant frequency as the driving frequency: $\omega_s = \omega_l \sim \omega_r$. However, this is not necessarily the case for all experiments. In Fig. 7 we show

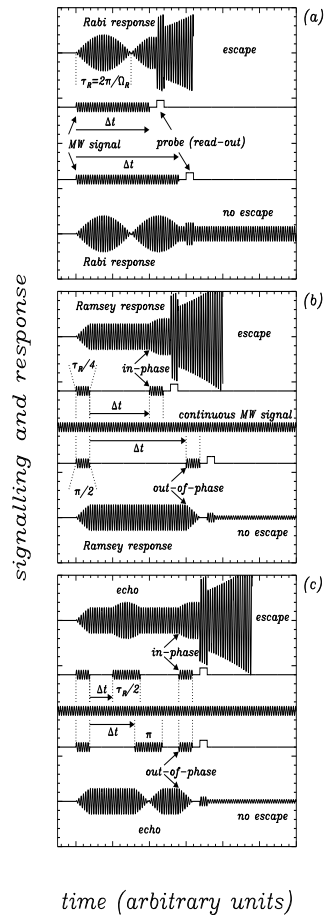

FIG. 4: Sketches of idealized microwave perturbations and corresponding classical system (phase) responses for (a) Rabi oscillations, (b) Ramsey fringes, and (c) spin echo. Upper part of each plot illustrates a situation in which the probe (read out) pulse results in an escape from the potential well, while the lower part illustrates a no-escape case. The experimentally varied time for observing the oscillations in response is shown on each plot as Δt .

the effect of a lower-than-resonance ($\omega_s < \omega_l$) driving signal on Rabi-type frequency. One important aspect of these plots is that low-amplitude signals result in modulation frequencies which do not lie on the "main sequence" curve to which higher-amplitude responses conform. We assert that the reason for this is found in the multi-valued nature of the amplitude (and energy) response for off-resonant driving as shown in Ref. [27], Fig. 1. Also notable is the fact that this effect (an analytical result for the single junction) is also seen in the three-junction loop.

IV. CONCLUSIONS

The analysis we have developed reducing the three-junction loop to a single degree of freedom provides a significant reduction in the complexity of the system. The resulting equation provides direct agreement with our simulations when identifying the system resonances from experimentally relevant switching experiments.

Our studies of off-resonant driving of Rabi-type oscillations reinforce earlier work concerning multi-valued functions in signal amplitude. Although no distinct conclusions can be made with regard to a connection between off-resonant driving signals and linear relationships between Rabi-type frequency and signal amplitude, we have shown evidence that driving the system near (but not exactly at) resonance does extract nearly linear behavior in the response for

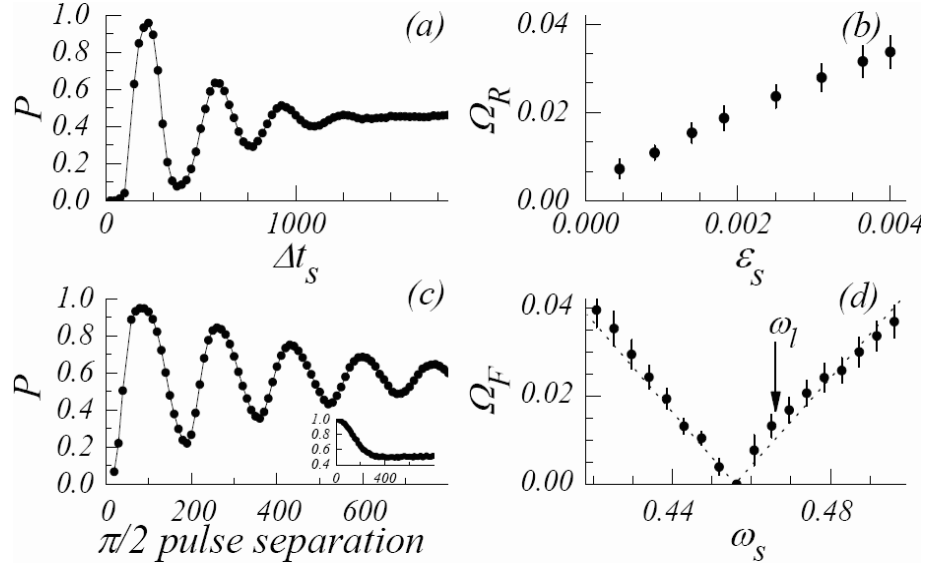

FIG. 5: Oscillation phenomena for the three-junction loop: Rabi-type oscillations and Ramsey-type fringes. Panel (a) shows Rabi-type oscillations. Panel (b) indicates the Rabi-type frequency as a function of microwave amplitude, with ε_s for $\omega_s = 0.45629 \sim \omega_r$. Panel (c) is the resulting switching distribution for Ramsey-type fringes with $\omega_s = 0.42528$ and $\varepsilon_p = 0.0195$. The inset depicts the driving frequency which achieves a fringe frequency of zero; here $\omega_s = 0.45629 \sim \omega_r$, $\varepsilon_p = 0.0148$. Panel (d) provides the relationship between fringe frequency and driving frequency. The arrow indicates measurement of $\omega_l = 0.46557$ by direct simulation. Note Eq. (14) predicts $\omega_l = 0.46625$. Parameters for all panels, unless otherwise noted, were $M_{dc} = 0.52$, $\beta_L = 0.09559$, $\kappa = 0.68$, $\alpha = 1.5 \cdot 10^{-4}$, $\varepsilon_s = 1.82 \cdot 10^{-3}$, $\omega_s = 0.443$, $\varepsilon_p = 0.0149$, and $\Theta(T) = 3 \cdot 10^{-3}$; statistics were gathered for $\sim 20\,000$ escape events.

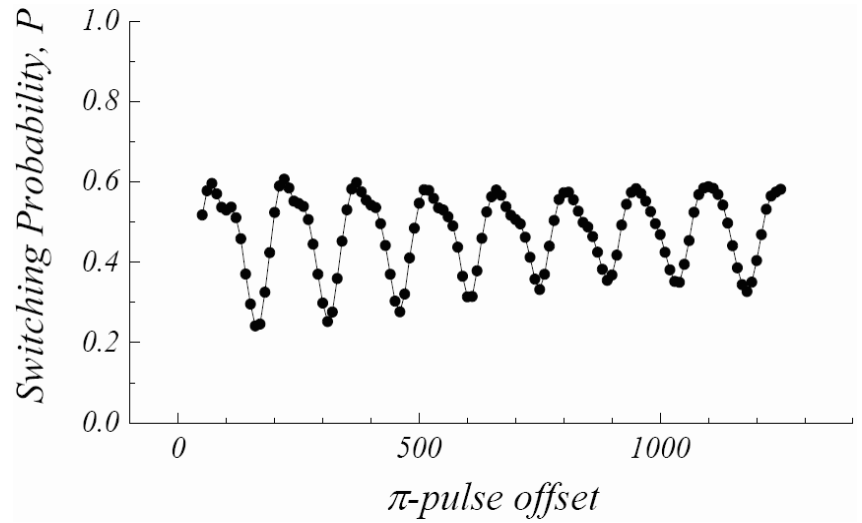

FIG. 6: Spin-echo-type oscillations for three-junction loop. Parameters are $M_{dc} = 0.52$, $\beta_L = 0.09559$, $\kappa = 0.68$, $\alpha = 1.5 \cdot 10^{-4}$, $\omega_s = 0.419787$, $\varepsilon_s = 1.82 \cdot 10^{-3}$, $\varepsilon_p = 0.0195$, and $\Theta(T) = 3 \cdot 10^{-3}$. Each dot represents 22000 escape events.

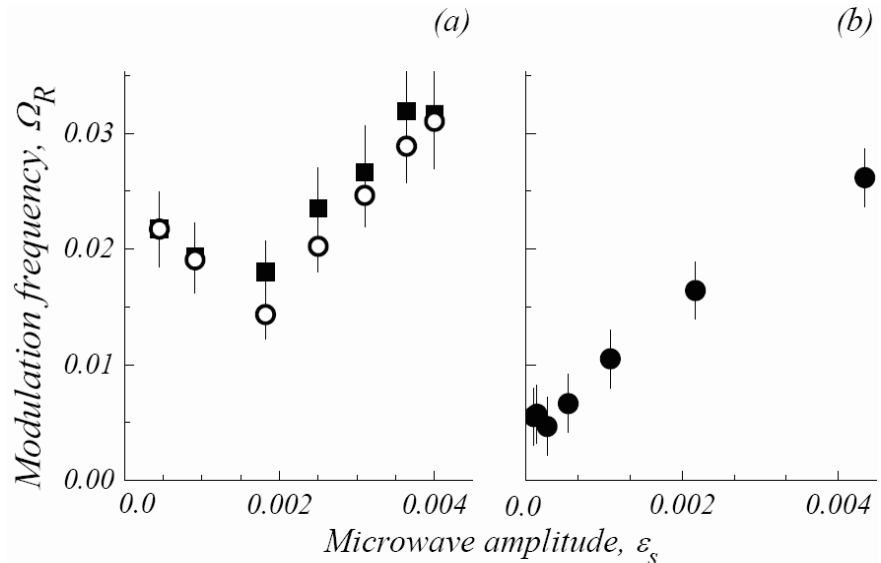

FIG. 7: Simulations of off-resonance Rabi-type oscillation frequencies. Panel (a) depicts the off-resonance modes for the three-junction loop. Parameters were: $M_{dc} = 0.52$, $\beta_L = 0.09559$, $\kappa = 0.68$, $\omega_s = 0.443$, $\varepsilon_s = 1.82 \cdot 10^{-3}$, $\varepsilon_p = 0.063$, and $\Theta = 3 \cdot 10^{-3}$. Two values of characteristic damping are given. The filled squares correspond to $\alpha = 1.5 \cdot 10^{-4}$, empty circles: $\alpha = 0$. The resonance frequency, ω_r (as shown in Fig. 5 (d)) is 0.45629. Panel (b) shows the off-resonance modes for the single-junction circuit. Parameters were $\alpha \sim 1.5 \cdot 10^{-4}$, $\eta = \sqrt{1 - \omega_l^4}$, $\omega_s = 0.99\omega_l = 0.646188$, and $\Theta = 2 \cdot 10^{-4}$.

larger amplitudes. We emphasize that the simple model we are using may not completely account for all the details of the observed phenomena.

Consistently with our previous work, we have used the classical RCSJ phenomenology to investigate various phenomena heretofore attributed to macroscopic quantum tunneling and we have shown very good agreement with experimental results so far reported. We have shown that, with regard to Rabi-type oscillations, Ramsey-type fringes, and spin-echo-type oscillations, the three-junction loop differs little, qualitatively, from the single-junction circuit. This is easily attributed to the fact that the important dynamics of these systems is governed by resonant excitations in anharmonic potential wells followed by a read-out perturbation which makes the system escape from the well. Thus, our developed analysis and intuition about the system response to applied microwave pulses translates easily from a simple single junction system to other systems with similar overall resonant excitations and escape from anharmonic wells. The main difference between the single junction system and other systems, such as the three loop system studied here, is that the experimental reality may be different. For example, given the relative insensitivity to noise inherent in the three-junction loop, it is no surprise from a classical viewpoint that experimental research groups are favoring its use.

We conclude that the systems analyzed in this paper, previously considered as microwave pulse-driven flux qubits, can be interpreted within the nonlinear dynamics framework of the Josephson systems. Recently, following [32] an RCSJ-based analysis [38] of the three-junction Josephson system has been reported. There, the pumping by an ac drive was used in order to generate low frequency modulations of phase and energy. The conclusion of that work confirms a nonlinear phenomenon reported previously in simulations and experiments [25, 26, 27, 39], namely that it is possible to phase-lock Josephson systems by superharmonic pumping; the quantum effects on the other hand should not be sensitive to the superharmonic drive and therefore this difference could constitute a discriminant between classical and quantum effects. Two of the authors of the present paper in particular were co-authors in publications [25, 26] in which the superharmonic pumping of phase qubit was observed. We must recall in any case that nonlinear dynamics can model a Josephson system over broad parameter ranges and in particular at very low temperatures. Recent observations [34] indicate that this is indeed the case down to 10mK where striking experimental observations of nonlinear effects are observed; therefore it might not be easy to engineer a Josephson system on which all the nonlinear effects are purged out. It is also worth noticing that it is not straightforward to draw conclusions from experiments with superharmonic pumping of a superconducting circuit due to the varying responses that both the system and the microwave apparatus may have at different frequencies.

The possibility that the behavior of a physical system thought to demonstrate evidence of macroscopic quantum superposition can be interpreted with a different approach is not a unique characteristic the Josephson effect. Roughly three decades ago scientists were looking for macroscopic quantum effects in charge density-wave systems [40] and it was found that the reported results could also be explained by alternative and more "classical" models [41]. It was earlier speculated that these kind of arguments would not find space and motivation in Josephson systems, but while our findings for resonant switching, Rabi-oscillations, Ramsey-fringes, and spin-echo do not preclude observations of quantum behavior in Josephson systems, the evidence of recent years has shown that many observed phenomena in this class of systems can be attributed to RCSJ classical dynamics.

V. ACKNOWLEDGMENTS

We wish to thank John Clarke, Alexey Ustinov, Paul Reichardt, and Travis Hime for taking the time to assist us in this endeavor. This work was supported in part by the UC Davis Center for Digital Security under the AFOSR grant FA9550-04-1-0171, in part by MIUR.(Italy) COFIN04.

-
- [1] *Quantum Computing and Quantum Bits in Mesoscopic Systems*, A. Leggett, B. Ruggiero, and P. Silvestrini, Eds. (Kluwer Academic/Plenum Publishers, New York, 2004).
 - [2] P. Silvestrini, V. Palmieri, B. Ruggiero, and M. Russo, Phys. Rev. Lett. **70**, 3046 (1997) ; P. Silvestrini, B. Ruggiero, C. Granata, and E. Esposito, Phys. Lett. A **267**, 45 (2000).
 - [3] J. M. Martinis, S. Nam, and J. Aumentado, Phys. Rev. Lett. **89**, 117901 (2002).
 - [4] R. W. Simmonds, K. M. Lang, D. A. Hite, S. Nam, D. P. Pappas, and J. M. Martinis, Phys. Rev. Lett. **93**, 077003 (2004).
 - [5] A. Wallraff, A. Lukashenko, A. V. Ustinov, Phys. Rev. Lett. **90**, 037003 (2003).
 - [6] J. Claudon, F. Balestro, F. W. J. Hekking, and O. Buisson, Phys. Rev. Lett. **93**, 187003 (2004).
 - [7] A. Wallraff, D. I. Schuster, A. Blais, L. Frunzio, J. Majer, M. Devoret, S. M. Girvin, and R. J. Schoelkopf, Phys. Rev. Lett. **95**, 060501 (2005).
 - [8] C. H. van der Wal, A. C. J. ter Haar, F. K. Wilhelm, R. N. Schouten, C. J. P. M. Harmans, T. P. O. S. Lloyd, and J. E. Mooij, Science **290**, 773 (2000).
 - [9] I. Chiorescu, Y. Nakamura, C. J. P. M. Harmans, and J. E. Mooij, Science **299**, 1869 (2003).
 - [10] E. Il'ichev, N. A. Oukhanski, A. Izmailov, T. Wagner, M. Grajcar, H.-G. Meyer, A. Smirnov, A. M. van den Brink, M. H. S. Amin, and A. Zagorin, Phys. Rev. Lett. **91**, 097906 (2003).
 - [11] T. Kutsuzawa, H. Tanaka, S. Saito, H. Nakano, K. Semba, and H. Takayanagi, Appl. Phys. Lett. **87**, 073501 (2005).
 - [12] B. L. T. Plourde, T. L. Robertson, P. A. Reichardt, T. Hime, S. Linzen, C. E. Wu, and J. Clarke, Phys. Rev. B **72**, 060506 (2005).
 - [13] S. Saito, T. Meno, M. Ueda, H. Tanaka, K. Semba, H. Takayanagi, Phys. Rev. Lett. **96**, 107001 (2006).
 - [14] D. Vion, A. Aasime, A. Cottet, P. Joyez, H. Pothier, C. Urbina, D. Esteve, and M. H. Devoret, Science **296**, 886 (2002).
 - [15] J. R. Friedman, V. Patel, W. Chen, S. K. Tolpygo, and J. E. Lukens, Nature **406**, 43 (2000).
 - [16] Y. Nakamura, Y. A. Pashkin, J. S. Tsai, Phys. Rev. Lett. **87**, 246601 (2001).
 - [17] Y. A. Pashkin, T. Yamamoto, O. Astafiev, Y. Nakamura, D. V. Averin, and J. S. Tsai, Nature **421**, 823 (2003).
 - [18] R. H. Koch, J. R. Rozen, G. A. Keefe, F. M. Milliken, C. C. Tsuei, J. R. Kirtley, and D. P. DiVincenzo, Phys. Rev. B **72**, 092512 (2005).
 - [19] P. Bertet, I. Chiorescu, G. Burkard, K. Semba, C. J. P. M. Harmans, D. P. DiVincenzo, and J. E. Mooij, Phys. Rev. Lett. **95**, 257002 (2005).
 - [20] I. I. Rabi, Phys. Rev. Lett. **51**, 652 (1937).
 - [21] N. F. Ramsey, Phys. Rev. **78**, 695 (1950).
 - [22] D. Vion, A. Aasime, A. Cottet, P. Joyez, H. Pothier, C. Urbina, D. Esteve, and M. H. Devoret, Fortschr. Phys. **51**, 462 (2003).
 - [23] M. Steffen, M. Ansmann, R. C. Bialczak, N. Katz, E. Lucero, R. McDermott, M. Neeley, E. M. Weig, A. N. Cleland, J. M. Martinis, Science **313**, 1423 (2006).
 - [24] T. Van Duzer and C. W. Turner, *Principles of Superconducting Devices and Circuits*, Elsevier (1998) ; A. Barone and G. Paternò, *Physics and Applications of the Josephson Effect*, J. Wiley (1982).
 - [25] N. Grønbech-Jensen, M. G. Castellano, F. Chiarello, M. Cirillo, C. Cosmelli, L. V. Filippenko, R. Russo, and G. Torrioli, Phys. Rev. Lett. **93**, 107002 (2004).
 - [26] N. Grønbech-Jensen, M. G. Castellano, F. Chiarello, M. Cirillo, C. Cosmelli, V. Merlo, R. Russo, and G. Torrioli, in "Quantum Computing: Solid State Systems", edited by B. Ruggiero, P. Delsing, C. Granata, Y. Pashkin, and P. Silvestrini (Kluwer Academic and Springer Publishers, New York, 2005), pp. 111-119 (cond-mat/0412692).
 - [27] N. Grønbech-Jensen and M. Cirillo, Phys. Rev. B. **70**, 214507 (2004).
 - [28] N. Grønbech-Jensen and M. Cirillo, Phys. Rev. Lett. **95**, 067001 (2005).
 - [29] J. E. Marchese, M. Cirillo, and N. Grønbech-Jensen, Phys. Rev. B **73**, 174507 (2006).

- [30] J. E. Marchese, M. Cirillo, and N. Grønbech-Jensen, *Open Sys. & Information Dyn.* **14**, 189 (2007).
- [31] J. E. Marchese, M. Cirillo, and N. Grønbech-Jensen, *Eur. Phys. J.* **147**, 333 (2007).
- [32] J. E. Marchese, Ph.D. thesis, University of California, Davis (2007).
- [33] M. Cirillo, P. Carelli, M. G. Castellano, F. Chiarello, C. Cosmelli, N. Grønbech-Jensen, R. Leoni, J. E. Marchese, F. Mattioli, D. Simeone, and G. Torrioli, *Physica C* **437-438**, 46 (2006).
- [34] M. G. Castellano, G. F. Chiarello, R. Leoni, F. Mattioli, P. Carelli, M. Cirillo, C. Cosmelli, A. de Waard, G. Frossati, N. Grønbech-Jensen, and S. Poletto, *Phys. Rev. Lett.* **98**, 177002 (2007).
- [35] T. P. Orlando, J. E. Mooij, L. Tian, C. H. van der Wal, L. S. Levitov, S. Lloyd, and J. J. Mazo, *Phys. Rev. B* **60**, 15398 (1999).
- [36] G. Parisi, *Statistical Field Theory* (Addison-Wesley, Redding, MA, 1988).
- [37] U. Geigenmüller, *J. Appl. Phys.* **80**, 3934 (1996).
- [38] A. N. Omelyanchouk, S. N. Shevchenko, A. M. Zagoskin, E. Il'ichev, and F. Nori, *Phys. Rev.* **B78**, 054512 (2008).
- [39] M. Cirillo, G. Rotoli, A. R. Bishop, N. Grønbech-Jensen, P. S. Lomdahl, *Phys. Rev.* **B52**, 506 (1995) ; M. Cirillo, V. Merlo, D. Winkler, and N. Thyssen, *IEEE Trans. Appl. Superconductivity* **9**, 3745 (1999).
- [40] J. Bardeen, *Phys. Rev. Lett.* **42**, 1498 (1979); R. E. Thorne, J. R. Tucker, and J. Bardeen, *Phys. Rev. Lett.* **58**, 828 (1987).
- [41] L. Sneddon, M. C. Cross, and D. S. Fisher, *Phys. Rev. Lett.* **49**, 292 (1982); R. A. Klemm and J. R. Schrieffer, *Phys. Rev. Lett.* **51**, 47 (1983).