

QUANTUM STABILIZER CODES AND BEYOND

A Dissertation

by

PRADEEP KIRAN SARVEPALLI

Submitted to the Office of Graduate Studies of  
Texas A&M University  
in partial fulfillment of the requirements for the degree of

DOCTOR OF PHILOSOPHY

August 2008

Major Subject: Computer Science

QUANTUM STABILIZER CODES AND BEYOND

A Dissertation

by

PRADEEP KIRAN SARVEPALLI

Submitted to the Office of Graduate Studies of  
Texas A&M University  
in partial fulfillment of the requirements for the degree of

DOCTOR OF PHILOSOPHY

Approved by:

Chair of Committee,	Andreas Klappenecker
Committee Members,	Donald K. Friesen
	Jennifer L. Welch
	Scott L. Miller
Head of Department,	Valerie E. Taylor

August 2008

Major Subject: Computer Science

## ABSTRACT

Quantum Stabilizer Codes and Beyond. (August 2008)

Pradeep Kiran Sarvepalli, B.Tech., Indian Institute of Technology, Madras;

M.S., Texas A&M University

Chair of Advisory Committee: Dr. Andreas Klappenecker

The importance of quantum error correction in paving the way to build a practical quantum computer is no longer in doubt. Despite the large body of literature in quantum coding theory, many important questions, especially those centering on the issue of “good codes” are unresolved. In this dissertation the dominant underlying theme is that of constructing good quantum codes. It approaches this problem from three rather different but not exclusive strategies. Broadly, its contribution to the theory of quantum error correction is threefold.

Firstly, it extends the framework of an important class of quantum codes – nonbinary stabilizer codes. It clarifies the connections of stabilizer codes to classical codes over quadratic extension fields, provides many new constructions of quantum codes, and develops further the theory of optimal quantum codes and punctured quantum codes. In particular it provides many explicit constructions of stabilizer codes, most notably it simplifies the criteria by which quantum BCH codes can be constructed from classical codes.

Secondly, it contributes to the theory of operator quantum error correcting codes also called as subsystem codes. These codes are expected to have efficient error recovery schemes than stabilizer codes. Prior to our work however, systematic methods to construct these codes were few and it was not clear how to fairly compare them with other classes of quantum codes. This dissertation develops a framework for study and analysis of subsystem codes using character theoretic methods. In particular, this work established a close link between subsystem codes and classical codes and it became clear that the subsystem

codes can be constructed from arbitrary classical codes.

Thirdly, it seeks to exploit the knowledge of noise to design efficient quantum codes and considers more realistic channels than the commonly studied depolarizing channel. It gives systematic constructions of asymmetric quantum stabilizer codes that exploit the asymmetry of errors in certain quantum channels. This approach is based on a Calderbank-Shor-Steane construction that combines BCH and finite geometry LDPC codes.

To My Parents

## ACKNOWLEDGMENTS

I owe a debt of gratitude to many who have directly or indirectly contributed to bring this dissertation into shape. First and foremost, I would like to thank my advisor, Andreas Klappenecker. He created and sustained a positive and encouraging atmosphere within which I could carry out my research. Even when I was a fledgling in the field, he treated me as an equal, while gently correcting me without discouraging. I am greatly indebted to him for his guidance.

Many thanks to my co-authors, Avanti Ketkar, Santosh Kumar, Salah Aly, Martin Rötteler, and Markus Grassl, for the many illuminating discussions and their role in enhancing my understanding. Martin, in particular, was instrumental in my study of asymmetric quantum codes when I was an intern at NEC Laboratories America, in the summer of 2007. I would also like to thank Marcus Silva and Angad Kamat, with whom I had several interesting discussions. I would also like to take this opportunity to thank Profs. Jennifer Welch, Donald Friesen and Scott Miller for serving on my Ph.D. committee.

On a personal note, I thank Ammumma, Tataiah, Chelli, Aso Mama, Raja Mama and Harsha Mama, for their encouragement and prayers. I was free to pursue my research partly because my brother Bobby stepped in to shoulder my responsibilities at home. This work would not have been possible without the unwavering and undiminishing support of my parents. I am deeply grateful for their faith and prayers. As I look back, there is a sense in which this work seems to be incomplete. Yet, to the extent that God has given me the grace to complete it and for His many kindnesses, I am grateful to God.

## TABLE OF CONTENTS

CHAPTER		Page
I	INTRODUCTION . . . . .	1
	A. Motivation . . . . .	1
	B. Quantum Error Correction . . . . .	2
	C. Outline and Contribution . . . . .	4
II	BACKGROUND . . . . .	9
	A. Quantum Computation . . . . .	9
	1. Qubits . . . . .	9
	2. Quantum Gates . . . . .	12
	3. Density Operators . . . . .	14
	4. Quantum Noise . . . . .	15
	5. Quantum Channels . . . . .	15
	B. Quantum Error Correction . . . . .	16
	C. Classical Coding Theory . . . . .	21
III	THEORY OF NONBINARY STABILIZER CODES . . . . .	24
	A. Stabilizer Codes . . . . .	26
	1. Error Bases . . . . .	27
	2. Stabilizer Codes . . . . .	29
	3. Minimum Distance . . . . .	30
	B. Galois Connection . . . . .	31
	C. Additive Codes . . . . .	35
	1. Codes over $\mathbb{F}_q$ . . . . .	37
	2. Codes over $\mathbb{F}_{q^2}$ . . . . .	39
	3. Classical Codes . . . . .	42
	D. Weight Enumerators . . . . .	44
	E. Bounds . . . . .	48
	1. Upper Bounds . . . . .	48
	2. Lower Bounds . . . . .	52
	F. Code Constructions . . . . .	56
	G. Puncturing Stabilizer Codes . . . . .	61
	H. Conclusions . . . . .	64
IV	CLASSES OF STABILIZER CODES . . . . .	65

CHAPTER	Page
A. Quantum Cyclic Codes . . . . .	65
1. Cyclic Hamming Codes . . . . .	69
2. Quantum Quadratic Residue Codes . . . . .	71
B. Quantum BCH Codes . . . . .	72
1. BCH Codes. . . . .	73
2. Generalized Carlitz-Uchiyama Bound. . . . .	73
3. Primitive BCH Codes Containing Their Duals. . . . .	74
4. Extending Quantum BCH Codes . . . . .	76
5. Puncturing BCH Codes. . . . .	78
C. MDS Codes . . . . .	81
D. Conclusions . . . . .	84
V SUBSYSTEM CODES – BEYOND STABILIZER CODES . . . . .	86
A. Review of Operator Quantum Error Correction . . . . .	87
B. A Detour Through Clifford Codes . . . . .	92
C. Constructing Operator Quantum Error-Correcting Codes . . . . .	94
D. Subsystem Codes from Classical Codes . . . . .	99
E. Conclusions . . . . .	106
F. Appendix . . . . .	107
VI SUBSYSTEM CODES – BOUNDS AND CONSTRUCTIONS . . . . .	109
A. Quantum Singleton Bound for $\mathbb{F}_q$ -linear Subsystem Codes . . . . .	112
B. Comparing Subsystem Codes with Stabilizer Codes . . . . .	119
C. Subsystem Codes on a Lattice . . . . .	121
1. Bacon-Shor Codes . . . . .	124
D. Subsystem Codes and Packing . . . . .	125
E. Conclusions . . . . .	129
VII ENCODING AND DECODING OF SUBSYSTEM CODES . . . . .	131
A. Introduction . . . . .	131
B. Encoding Stabilizer Codes – A Review . . . . .	132
C. Encoding Clifford Codes . . . . .	138
D. Encoding Subsystem Codes . . . . .	142
1. Illustrative Examples . . . . .	146
2. Encoding Subsystem Codes by Standard Form Method . . . . .	150
3. Encoding Subsystem Codes by Conjugation Method . . . . .	156
E. Syndrome Measurement for Nonbinary $\mathbb{F}_q$ -linear Codes . . . . .	164
F. Conclusions . . . . .	168



CHAPTER	Page
G. Appendix . . . . .	169
VIII QUANTUM LDPC CODES FOR ASYMMETRIC CHANNELS . . .	172
A. Background . . . . .	173
B. Asymmetric Quantum Codes from LDPC Codes . . . . .	176
1. Finite Geometry LDPC Codes . . . . .	177
2. Generalized Reed-Muller Codes . . . . .	178
3. New Families of Asymmetric Quantum Codes . . . . .	180
C. Performance Results . . . . .	184
IX NEW RESULTS ON BCH CODES . . . . .	191
A. Euclidean Dual Codes . . . . .	193
B. Dimension and Minimum Distance . . . . .	199
C. Hermitian Dual Codes . . . . .	202
D. Families of Quantum BCH Codes . . . . .	206
E. Conclusions . . . . .	209
REFERENCES . . . . .	210
VITA . . . . .	226

## LIST OF TABLES

TABLE		Page
I	The existence of a pure $[[n, k, d]]_q$ stabilizer code implies the existence of codes with other parameters. . . . .	56
II	A compilation of known families of quantum codes . . . . .	85
III	Asymmetric BCH-LDPC stabilizer codes . . . . .	185

## LIST OF FIGURES

FIGURE	Page
1	Encoding the $[[4, 1, 1, 2]]$ code (Gauge qubits can be in any state) . . . . . 147
2	Encoding the $[[4, 1, 1, 2]]$ code (Gauge qubits initialized to zero) . . . . . 147
3	Encoding $[[4, 1, 1, 2]]$ code (Encoded operators for the gauge qubits are trivial and gauge qubits can be initialized to random states) . . . . . 149
4	Encoder for the $[[9, 1, 4, 3]]$ code. This is also an encoder for the $[[9, 1, 3]]$ code. . . . . 153
5	Encoder for the $[[9, 1, 4, 3]]$ code with fewer CNOT gates. . . . . 154
6	Encoding $[[4, 1, 1, 2]]$ code by conjugation method . . . . . 163
7	Encoding $[[4, 1, 1, 2]]$ code by conjugation method . . . . . 163
8	Encoding $[[4, 1, 1, 2]]$ code by conjugation method – optimized . . . . . 164
9	Modification of the iterative message passing algorithm to the quantum case. The initialization step is different from the classical case as no soft information from the channel is available but rather only hard information about the measured syndrome is available. The algorithm begins with initializing all bit nodes to 0 and the check nodes with the syndrome. From then on, any classically known method for iterative decoding can be applied. In the figure this principle is shown for the example of a classical $[7,4,3]$ Hamming code. Application to the quantum case is straightforward as the decoding algorithm only works with classical information to compute the most likely error. . . . . 188
10	Performance of a $[[255, 159, 5/17]]$ code described in the text for choices $A = 1, 10, 100$ of the channel asymmetry. . . . . 189
11	Performance of a $[[255, 151, 7/17]]$ code described in the text for choices $A = 1, 10, 100$ of the channel asymmetry. . . . . 189

FIGURE		Page
12	Performance of a $[[255, 143, 9/17]]$ code described in the text for choices $A = 1, 10, 100$ of the channel asymmetry. . . . .	190
13	Performance of $[[1023, 731, 11/33]]$ code for $A = 100$ . . . . .	190

## CHAPTER I

### INTRODUCTION

#### A. Motivation

In the 1980s and 1990s, it gradually became apparent that the theory of information founded by Claude Shannon was a purely classical theory in that it did not take into account quantum mechanics. This realization crystallized the notion of quantum information as distinct from classical information. Despite the success of the abstract formulation of information by Shannon, it is far more physical\* than it appears. The representation of information *i.e.*, the mechanism/device used to store does affect its behavior. Two level systems such as a switches or more realistically transistors can be used to store and manipulate classical bits. One can also use systems such as photons or electrons. In case of photons for instance, information maybe stored on the polarization of the photon. The photon can be vertically or horizontally polarized. Other quantum mechanical systems such as spin- $\frac{1}{2}$  systems *i.e.*, systems with two spin states can also be used for representing information. These quantum mechanical representations give us something more than what we bargained for. Because they operate in a regime where the quantum mechanical effects can come into play<sup>†</sup>, in addition to representing the usual logical states they permit phenomena (such as linear combination of the logical states), which have no classical analogues. These phenomena seem to confer additional power when it comes to information processing. A far reaching ram-

---

The journal model is *IEEE Transactions on Information Theory*.

\*R. Landauer.

<sup>†</sup>It might be argued that quantum mechanical effects are present even when information is stored on a transistor (or any other device). That is true, however, when we speak of quantum mechanical effects we are not so much interested as to how they affect the functioning of the device as much as how they affect the logical state of the device. In so far as the logical state is considered, the transistor behaves classically.

ification due to differences between quantum and classical information is that computers processing quantum information, if they were built, could provide exponential speedups over computers that process classical information alone. For instance, Shor's algorithm for factoring integers provides an exponential speedup over the best known classical algorithms. A little less dramatically, Grover's search algorithm provides a quadratic speedup over its classical counterparts. Quantum computers therefore pose a challenge to one of the central tenets in theoretical computer science – the (modern) Church-Turing thesis which states:

Any reasonable model of computation can be simulated on a (probabilistic) Turing machine with at most a polynomial overhead, (see [25, 153]).

It must be emphasized that quantum computers cannot solve problems that are not solvable on classical computers, for the simple reason that a quantum computer can be simulated on a classical computer albeit with exponential slowdown. Quantum computers can potentially change the landscape of tractable problems. But to realize their promise we have one important hurdle to cross – which is the central theme of this dissertation – that of protecting quantum information.

## B. Quantum Error Correction

A quantum computer that can implement something nontrivial and useful as Shor's algorithm would require the control and manipulation of a large number of sensitive quantum mechanical systems. Any practical quantum computer would require the ability to protect quantum information against not only noise but also the inevitable operational (*i.e.*, gate) errors that accompany its processing. It was initially supposed that it would be impossible to protect quantum information not only because of the scale of computation but because of reasons intrinsic to quantum information. Fortunately, such skepticism was laid to rest

when Peter Shor [142] and Andrew Steane [144, 145] independently proposed schemes to protect quantum information from noise and operational errors. Gottesman [61] and independently Calderbank *et al.*, [35] proposed methods to construct quantum codes from classical codes. Commonly referred to as “stabilizer codes”, these codes are the most studied class of quantum codes. Their work was followed with a substantial body of results related to quantum error correction. More importantly, it was shown that if the overall error rate was lower than a “threshold”, it was possible to perform an arbitrarily long quantum computation with any desired accuracy with only a polylogarithmic overhead in time and space [1].

With these fundamental results in place, the focus of quantum coding theory shifted to the design of good codes, systematic methods for construction, efficient decoding algorithms, passive error correction schemes, optimizing codes for realistic noise processes and the like. These questions are in some sense interrelated. This dissertation seeks to address these questions<sup>‡</sup> in varying degree as will be elaborated below. It explores various models and methods of quantum error correction. Broadly, its contribution to the theory of quantum error correction is threefold. Firstly, it extends the framework of nonbinary stabilizer codes. It clarifies the connections of stabilizer codes to classical codes over quadratic extension fields, provides many new constructions of quantum codes, and develops further the theory of optimal quantum codes and punctured quantum codes. Secondly, it contributes to the theory of operator quantum error correcting codes (also called as subsystem codes). These codes are expected to have efficient error recovery schemes compared to stabilizer codes. This dissertation develops a framework for study and analysis of subsystem codes using character theoretic methods. The framework has made it possible to study subsystem codes by translating them into classical codes. Thirdly, it seeks to exploit the knowledge

---

<sup>‡</sup>In this dissertation we do not focus so much on fault tolerance.

of noise to design efficient quantum codes and considers more realistic channels than the commonly studied depolarizing channel. In addition to providing many explicit constructions for quantum codes, it seeks to integrate developments such as low density parity check (LDPC) codes into quantum coding theory.

### C. Outline and Contribution

This dissertation is structured as follows. In Chapter III, we consider the theory of nonbinary stabilizer codes initiated by Rains [126] and Ashikhmin and Knill [11]. This work was motivated in part by the comparatively little attention that codes over nonbinary alphabet had received. Currently it appears that binary quantum systems are comparatively easier to control and implement than multi-level quantum systems. However, the growing interest in nonbinary implementations suggests that nonbinary codes deserve a closer study, especially as quantum technologies mature. Further, many of the quantum mechanical systems naturally allow for a multi-dimensional representation of quantum information. Instead of simply ignoring them as is often the case, it might be to our benefit to exploit these additional degrees of freedom. It could for instance lead to implementation of quantum processors with fewer systems. In fact, there are proposals to exploit these additional modes not only to implement nonbinary quantum systems [30] but also use them to simplify binary implementations [51, 130]. It stands to reason that we need a systematic theory to design good codes for nonbinary implementations. This chapter concerns itself with generalizing many of the ideas of stabilizer codes to the nonbinary setting. The nonbinary generalization turns out to be a nontrivial task and in fact there still remain many open questions with respect to nonbinary quantum codes. We derive a number of important results with regard to structure and constructions of nonbinary stabilizer codes.

Armed with the framework of nonbinary stabilizer codes developed in Chapter III, we



then turn to a more constructive task of designing good quantum codes in Chapter IV. As in the classical case, quite often, imposing the constraint of linearity on the code structure substantially simplifies our task. We have more control over the parameters of the codes we design and more importantly, imposing the linearity constraint simplifies the encoding and decoding complexity. Therefore, we focus on the construction of some linear quantum codes bringing into bearing the machinery of the previous chapter. As in the case of classical codes, optimal codes generate a lot of interest not only because of their optimality, but because, not infrequently, they possess additional combinatorial structure that leads to interesting mathematical problems. We also study the quantum MDS codes in this chapter, establishing some structural results related to them.

While error correcting codes address the problem of protecting quantum information, there are still certain hurdles to be crossed if we are to build a quantum computer. Unlike classical case where we can, with good reason, assume that the encoding and decoding operations are noiseless or at least that they are not as noisy as the channel, quantum information processing does not allow us to do so. The process of encoding and decoding can be as noisy as the channel itself. Codes then have to be designed to allow for fault tolerant computation not merely communication or storage. The theory of fault tolerant quantum computation was developed to address this challenge. In keeping with this goal of fault tolerant quantum computation some researchers have been investigating passive forms of quantum error correction, where information was encoded into subsystems that were immune to noise. Kribs *et al.*, [99, 100] proposed a generalized framework for understanding both active and passive forms of quantum error correction. Such codes are called operator quantum error correcting codes or subsystem codes because in this model information is protected by encoding into subsystems as against the subspaces. Informally, this amounts to encoding each logical state into an equivalence class rather a unique state in the codespace. The equivalence class is actually a subspace and any state in the subspace is a representa-

tive of the logical state. This is accomplished through the use of additional qubits called gauge qubits. This method also generalizes the class of stabilizer codes studied in the Chapters III, IV. In view of its relevance to fault tolerant quantum computing we devote Chapter V to the study of operator quantum error correcting codes. Using character theoretic methods we establish a connection with classical codes that enables us to construct these codes systematically. In particular, we relax the constraint of self-orthogonality on the classical codes used to construct stabilizer codes.

In Chapter VI we extend the theory of operator quantum error correcting codes. The results are of interest in that they provide insight into the structure of subsystem codes. Additionally, they enable us to compare the gains that subsystem codes provide over stabilizer codes. An important question that had been raised when the subsystem codes were first discovered was the possibility of improving upon optimal stabilizer codes in the sense of requiring fewer syndrome measurements than them. We demonstrate in this particular sense the subsystem codes, at least the linear ones, cannot outperform the MDS stabilizer codes.

The presence of gauge qubits in subsystem codes not only simplifies error correction procedures, but it can potentially simplify the encoding process. Usually, the complexity of encoding is not as large as the complexity of decoding and is often neglected. But in the context of fault tolerant quantum computing, it is useful to have simpler encoding schemes. Previous work on subsystem codes contained claims that the encoding could also benefit due to subsystem coding but the exact circuits and the trade offs involved in achieving these gains were either absent or not rigorously justified. In Chapter VII we show how subsystem codes can be encoded, and how to exploit the presence of the gauge qubits to simplify the encoding process. We contend these simplifications in the encoding circuitry should also lead to additional benefits for fault tolerant quantum computation.

Much of quantum coding theory followed the same path as the classical coding theory

did historically. That is it took on an algebraic outlook with great emphasis on the distance of the code. But modern coding theory has gradually moved away from such a one dimensional characterization of code performance. In the modern picture instead of requiring that all errors up to a certain weight be correctable it has shifted the focus to achieving the capacity of the channel while keeping the complexity of encoding and decoding low. But these insights have not yet been fully absorbed by quantum coding theory. The reason is not that it has not been attempted. Starting with the works of Postol [119], MacKay *et al.*, [105], Camara *et al.*, [37] and more recently Poulin and Chung [122], there have been attempts to incorporate these modern developments into quantum coding theory. The difficulty is addressing the conflicting requirements that are posed on the classical codes from which the quantum codes are constructed. The additional constraints usually imply that these are bad codes classically and unlikely to lead to good quantum codes. In Chapter VIII, we contribute to the ongoing discussion on quantum LDPC codes by providing new constructions of algebraic quantum LDPC codes.

In Chapter VIII we also study a problem that has generated a lot of interest lately viz. the use of realistic noise models in quantum error correction. Much of earlier work often assumed that the channels are depolarizing channels. The depolarizing channel while being particularly simple is not necessarily the most accurate noise model which reflects many of the current quantum technologies. In Chapter VIII we study the design of codes that are in some measure optimized to channels that are asymmetric. For these channels we also address the problem mentioned earlier, how to incorporate the modern developments such as LDPC codes effectively. We study the theory of codes for asymmetric quantum channels and also provide systematic constructions of classes of quantum codes for them. While it remains to be seen if these codes are suitable for quantum computation, they seem most suited for quantum memories.

In Chapter IX we slightly change tracks to illustrate how the study of quantum codes

can shed light on classical codes. In this chapter we show how studies in quantum codes led to us to gain additional insight into the properties of BCH codes. Despite the fact these codes have been known for more than forty years now, there remain open problems with regard to their properties. We make some contribution to our understanding of these codes in the context of quantum error correction. We characterize the dimension and duals of narrow-sense BCH codes giving simple closed form expressions for their dimensions and simple criteria to identify dual containing BCH codes.

The material in Chapters III and IV is due to a joint work [83] with Andreas Klappenecker, Avanti Ketkar, and Santosh Kumar. Part of this material has appeared earlier in the theses of Avanti Ketkar and Santosh Kumar. Chapters V, VI and VII are in collaboration with Andreas Klappenecker and are based on [90, 91] and [135]. The material in Chapter VIII is the outcome of a joint work [136] with Martin Rötteler and Andreas Klappenecker and was partly performed while at NEC Laboratories America, Inc. The results in Chapter IX are due to a joint work with Andreas Klappenecker and Salah Aly [8].

To keep the dissertation of a manageable and readable size, I have not included my investigations of algebraic geometric quantum codes (in collaboration with Andreas Klappenecker) [133, 134], quantum convolutional codes [3, 9] (together with Andreas Klappenecker, Salah Aly, Martin Rötteler and Markus Grassl), degenerate quantum codes [5], group algebra duadic codes [7], some additional results on subsystem codes from [6] which were due to joint work with Andreas Klappenecker and Salah Aly.

## CHAPTER II

### BACKGROUND

To make the dissertation self-contained and also to provide the context for the research performed, this section provides a brief review of ideas relevant to quantum error correction. Because the breadth of the contents precludes any possibility of covering it completely in a short space, we recommend the lecture notes by Preskill [123] and the textbook by Nielsen and Chuang [114] for an accessible introduction to quantum computation. Those familiar with quantum computing can skip this chapter and proceed directly to topics of interest. While there is a logical progression of ideas, effort has been made so that the chapters can be read independently to some extent.

#### A. Quantum Computation

##### 1. Qubits

Just as bits are abstractions of classical two level systems, qubits are an abstraction of two level quantum systems. We denote the basis states in the so-called Dirac notation where  $|0\rangle$  (ket zero) and  $|1\rangle$  (ket one), are simply column vectors  $\begin{bmatrix} 1 \\ 0 \end{bmatrix}$  and  $\begin{bmatrix} 0 \\ 1 \end{bmatrix}$  respectively. This notation also serves to distinguish them from the classical states. The first essential difference with respect to bits is that the qubits can be in superposition of the basis states *i.e.*, they can be in any linear combination of the basis states subject to a normalization constraint. For instance, consider a single qubit. This qubit can be in the state

$$a|0\rangle + b|1\rangle, \quad \text{where } a, b \in \mathbb{C} \text{ and } |a|^2 + |b|^2 = 1.$$

So the state space of a qubit is  $\mathbb{C}^2$ .

While the qubit can be put in any superposition of the basis states, the observed state

of the qubit is restricted to be either one of the states. We cannot observe the superposition itself. Any observation of the qubit “collapses” the state of the qubit to either  $|0\rangle$  or  $|1\rangle$  with probability  $|a|^2$  and  $|b|^2$  respectively. This underscores the second difference between bits and qubits. Observation of qubits can change their state in general.

If we have  $n$  qubits, then the state space is actually a tensor product of the individual state spaces. We refer to the state space of the system as the Hilbert space and denote it by  $\mathcal{H}$ . We have  $\mathcal{H} \cong \mathbb{C}^2 \otimes \mathbb{C}^2 \otimes \cdots \otimes \mathbb{C}^2$  with  $\dim \mathcal{H} = 2^n$ . An orthonormal basis for  $\mathcal{H}$  is given by  $|x_1\rangle \otimes |x_2\rangle \otimes \cdots \otimes |x_n\rangle$ . The basis states are also sometimes denoted as  $|x_1 x_2 \dots x_n\rangle$  or  $|x_1, x_2, \dots, x_n\rangle$ , where the  $x_i$  take the values zero or one. We can also label the basis elements by  $x \in \mathbb{F}_2^n$ . Then a general state is given by

$$|\psi\rangle = \sum_{x \in \mathbb{F}_2^n} \alpha_x |x\rangle; \quad \sum_{x \in \mathbb{F}_2^n} |\alpha_x|^2 = 1. \quad (2.1)$$

The state of the system is a unit vector of length one in  $\mathcal{H}$ . The probability of observing the system in state  $|x\rangle$  is given by  $|\alpha_x|^2$ . The normalization constraint is due to the fact on measurement some state will be observed. To describe a general state then, we require  $2^n - 1$  complex numbers. This is in contrast to the classical case where the state space is only  $n$  dimensional. As an example, a two qubit system can be put in the state

$$a_0 |00\rangle + a_1 |01\rangle + a_2 |10\rangle + a_3 |11\rangle,$$

where  $|a_0|^2 + |a_1|^2 + |a_2|^2 + |a_3|^2 = 1$ . The basis state  $|00\rangle$  is actually  $|0\rangle \otimes |0\rangle = \begin{bmatrix} 1 \\ 0 \end{bmatrix} \otimes \begin{bmatrix} 1 \\ 0 \end{bmatrix}$ .

Other basis states are given similarly.

Often we will need to observe only a part of the system. This is a little more involved. Assume that we have a system of  $m + n$  qubits and we want to observe  $m$  qubits. An

arbitrary state of the system is of the form

$$|\psi\rangle = \sum_{x \in \mathbb{F}_2^m, y \in \mathbb{F}_2^n} \alpha_{x,y} |x\rangle |y\rangle; \quad \sum_{x \in \mathbb{F}_2^m, y \in \mathbb{F}_2^n} |\alpha_{x,y}|^2 = 1. \quad (2.2)$$

Let us assume that we want to observe the qubits whose states correspond to  $|x\rangle$ . Then the probability of observing these qubits in state  $|x\rangle$  is given by

$$p_x = \sum_{y \in \mathbb{F}_2^n} |\alpha_{x,y}|^2.$$

Assuming that we observed  $|x\rangle$ , the state of the system after observation is given by

$$\frac{1}{\sqrt{p_x}} \sum_{y \in \mathbb{F}_2^n} \alpha_{x,y} |y\rangle |x\rangle.$$

Observing quantum systems can be described using the more powerful measurement formalism, see for instance [114].

An important consequence of the fact that the qubits can be in superposition is a phenomenon known as entanglement. Consider the following state. We ignore the normalization factors for convenience.

$$|\psi\rangle = |01\rangle + |11\rangle.$$

We could also write this state as the product state *i.e.*,

$$|\psi\rangle = |0\rangle \otimes (|0\rangle + |1\rangle).$$

When the states of the qubits can be written as product states then we can observe each of the product states without disturbing the rest of the system. However there are states such as the following which cannot be written as the product of individual qubit states.

$$|\psi\rangle = |00\rangle + |11\rangle \quad |\varphi\rangle = |01\rangle + |10\rangle.$$

Such states are said to be entangled and this phenomenon is called entanglement. When

qubits are entangled it is not possible to observe the state of one of the entangled qubits without disturbing the rest of the system. One could view the speedup provided by quantum computers as being due to entanglement.

We associate to every state  $|\psi\rangle$  in  $\mathcal{H}$  a row vector denoted as  $\langle\psi|$  which is simply the adjoint of the column vector corresponding to  $|\psi\rangle$ . Two vectors  $|\psi\rangle$  and  $|\varphi\rangle$  are said to be orthogonal if their scalar product denoted as  $\langle\varphi|\psi\rangle = 0$ . This is also called the inner product of two vectors.

## 2. Quantum Gates

Just as classical data is manipulated using gates, qubits are also manipulated using quantum gates. Since the quantum states are unit vectors in  $\mathbb{C}^{2^n}$ , we could view the application of gates on the qubits as matrices on  $\mathbb{C}^{2^n}$ . The postulates of quantum mechanics require the matrices to be unitary, *i.e.*, they must satisfy  $U^{-1} = U^\dagger$ , where  $U^\dagger$  is the adjoint of the matrix. We denote the action of a gate  $U$  on a state  $|\psi\rangle$  as  $U|\psi\rangle$ . We denote the inner product of  $U|\psi\rangle$  and  $|\varphi\rangle$  as  $\langle\varphi|U|\psi\rangle$ . Some important operations on a single qubit are the following.

$$X = \begin{bmatrix} 0 & 1 \\ 1 & 0 \end{bmatrix}; \quad Y = \begin{bmatrix} 0 & -i \\ i & 0 \end{bmatrix}; \quad Z = \begin{bmatrix} 1 & 0 \\ 0 & -1 \end{bmatrix}. \quad (2.3)$$

These operators are also called Pauli errors. We will denote the group generated by the Pauli errors by  $\mathcal{P}$ . Often  $Y$  is redefined without the  $i$  for convenience in analysis. When we consider  $n$  qubits we define the Pauli group of matrices on them as

$$\mathcal{P}_n = \{i^c e_1 \otimes e_2 \otimes \cdots \otimes e_n \mid e_i \in \mathcal{P}, c \in \mathbb{Z}_4\}, \text{ where } \mathbb{Z}_4 = \{0, 1, 2, 3\}. \quad (2.4)$$

In a subsequent chapter we will generalize the notion of Pauli group and use it to define error operators and construct codes over prime power alphabet.



Other important single qubit gates are the Hadamard gate,  $H$ , the phase gate  $P$  and the  $\pi/8$  gate (or  $T$  gate) which are defined as

$$H = \begin{bmatrix} 1 & 1 \\ 1 & -1 \end{bmatrix}; \quad P = \begin{bmatrix} 1 & 0 \\ 0 & i \end{bmatrix}; \quad T = \begin{bmatrix} 1 & 0 \\ 0 & e^{i\pi/4} \end{bmatrix}. \quad (2.5)$$

Perhaps the most important two qubit gate is the CNOT (controlled-NOT) gate. The action of the CNOT gate on the basis states is as follows.

$$\begin{array}{c} |x\rangle \\ |y\rangle \end{array} \begin{array}{c} \bullet \\ \oplus \end{array} \begin{array}{c} |x\rangle \\ |x \oplus y\rangle \end{array}$$

The top qubit is called the control qubit and the bottom qubit is called the target qubit. A CNOT gate with control qubit  $i$  and target qubit  $j$  is denoted as  $\text{CNOT}^{i,j}$  and acts as follows on these two qubits:

$$\begin{bmatrix} 1 & 0 & 0 & 0 \\ 0 & 1 & 0 & 0 \\ 0 & 0 & 0 & 1 \\ 0 & 0 & 1 & 0 \end{bmatrix}. \quad (2.6)$$

The CNOT gate along with  $H$ ,  $P$  and  $T$  gates forms a set of universal gates for quantum computation. Any arbitrary quantum gate can be realized efficiently using these set of gates to arbitrary accuracy by the Solovay-Kitaev theorem. A graphic representation of the gates mentioned so far is given below:

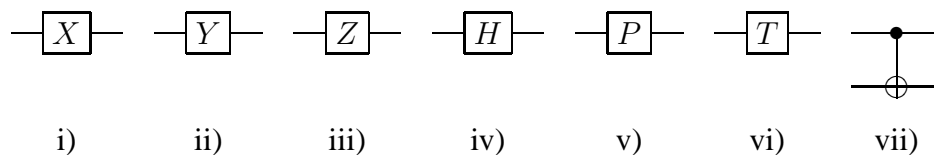

An important point about the quantum gates is that they act linearly. Let us illustrate. The

$X$  gate acts as follows:

$$X |0\rangle \mapsto |1\rangle \text{ and } X |1\rangle \mapsto |0\rangle,$$

so when it acts on an arbitrary state such as  $a |0\rangle + b |1\rangle$  we get  $a |1\rangle + b |0\rangle$ . Later in Chapter VII we will have occasion to give encoding and decoding circuits for subsystem codes. These ideas will be needed then.

### 3. Density Operators

The state of qubits can be viewed not only as a unit vector in the Hilbert space but also as operators on  $\mathcal{H}$ . This approach makes it easy to analyze and study quantum channels. Given two vectors  $|\psi\rangle$  and  $|\phi\rangle$  we can define what is known as the outer product of  $|\psi\rangle$  and  $|\phi\rangle$  as  $|\phi\rangle\langle\psi|$ . For instance if  $|\psi\rangle = |0\rangle$  and  $|\phi\rangle = |1\rangle$ . Then  $|1\rangle\langle 0| = \begin{bmatrix} 0 & 0 \\ 1 & 0 \end{bmatrix}$ . We call the outer product obtained from  $|\psi\rangle$  with itself *i.e.*,  $\rho = |\psi\rangle\langle\psi|$  as the density matrix or the density operator. The density matrix is positive definite, *i.e.*,  $\langle\psi|\rho|\psi\rangle \geq 0$ , and  $\text{Tr}(\rho) = 1$  where  $\text{Tr}$  is the sum of the diagonal entries. Since the density operators are matrices of size  $2^n \times 2^n$ , we can also view the states as being operators on the system Hilbert space. A view which will be useful when defining quantum channels. More generally if a system can be found in one of the states  $|\psi_i\rangle$  with probability  $p_i$ , the density operator associated to this system is given by

$$\rho = \sum_i p_i |\psi_i\rangle\langle\psi_i|.$$

A state is pure if  $\text{Tr}(\rho^2) = 1$  and mixed otherwise. The density operator approach will be helpful in understanding the motivation behind operator quantum error correction in Chapter V and also in Chapter VIII, where we design codes optimized for a given channel. When a gate  $U$  is applied to a state with density matrix  $\rho$ , it transforms as  $U\rho U^\dagger$ .

#### 4. Quantum Noise

Noise on qubits is very different from the noise that we deal with bits. The noise can be thought to be arising out of the fact that the information bearing system cannot be completely isolated from the environment and its interaction with the environment causes its state to change. Sometimes this phenomenon is also called decoherence.

Since the state of a single qubit is given  $a|0\rangle + b|1\rangle$ , where  $a, b$  are complex numbers, one can expect that errors on quantum information form a continuum unlike the classical bits where there exist only bit flip errors. In fact, we can view noise on a qubit as a  $2 \times 2$  complex matrix and more generally, noise on  $n$  qubits is a  $2^n \times 2^n$  complex matrix; for this reason we often refer to errors as error operators.

While we have to protect quantum information from an infinitude of errors, in view of linearity of quantum mechanics, it suffices to correct for only a basis of errors. The importance of the Pauli errors also stems from the fact that they form a basis for the error operators. Of course, we cannot protect against all errors. We usually make the assumption that noise on each qubit is independent. Under this assumption we can decompose an error on the system into a tensor product of  $n$  single qubit errors.

Errors on the quantum states can also arise due to the finite precision with which the quantum gates are implemented. Fortunately, the same mechanisms that are used to correct decoherence can also be used to correct for these type of errors [140, 142].

#### 5. Quantum Channels

A quantum channel is a linear map on the density operators (on  $\mathbb{C}^{2^m}$ ) to the set of density operators (on  $\mathbb{C}^{2^n}$ ); we usually assume that the input and output Hilbert spaces are same *i.e.*,  $m = n$ . Sometimes quantum channels are also called “superoperators” to indicate that they act on (density) operators. In this dissertation we will confine ourselves to maps which

are completely positive and trace preserving (CPTP) maps. A CPTP map  $\mathcal{E}$  is usually given in terms of its Kraus decomposition.

$$\mathcal{E}(\rho) = \sum_i E_i \rho E_i^\dagger \text{ where } \sum_i E_i^\dagger E_i = I. \quad (2.7)$$

The quantum channel view is very convenient to understand errors. For instance if we assume that the bit flip errors occur with a probability  $p$  and the rest of the time there are no errors. We can represent this as the following channel.

$$\mathcal{E}(\rho) = (1 - p)\rho + pX\rho X. \quad (2.8)$$

The Kraus operators are easily identified as  $\sqrt{1-p}I$  and  $\sqrt{p}X$ . The channel often studied in the context of quantum codes is the depolarizing channel and it parallels the classical 4-ary symmetric channel. This channel acts as

$$\mathcal{E}(\rho) = (1 - 3p)\rho + pX\rho X + pY\rho Y + pZ\rho Z. \quad (2.9)$$

In this channel, each of the Pauli errors  $X$ ,  $Y$  or  $Z$  act with a probability  $p$  and with a probability of  $1 - 3p$ , the state is preserved. The Kraus operators are simply given by  $\sqrt{1-3p}I$ ,  $\sqrt{p}X$ ,  $\sqrt{p}Y$  and  $\sqrt{p}Z$ .

## B. Quantum Error Correction

In this section we briefly review the elements of quantum error correction. The reader is also recommended to [35,61,95] for more details. Additionally, there are many expositions to the ideas of quantum error correction, see [13,55,82,96,108]. Here we summarize the main features. We will restrict our attention to additive quantum codes.

A binary quantum code is a linear subspace of the system Hilbert space i.e.,  $\mathbb{C}^{2^n}$ . The subspace structure arises due to the fact that we can have superpositions of the encoded

states. For instance, let us assume that the logical states are the following:

$$|\bar{0}\rangle = |000\rangle; \quad |\bar{1}\rangle = |111\rangle. \quad (2.10)$$

Since we are allowed to have linear combinations of states, this implies that  $a|000\rangle + b|111\rangle$  is also a valid state and belongs to the code. The subspace structure of the quantum code can be seen to emerge naturally. The typical questions that we have to address when dealing with error correcting codes classical or otherwise are:

- Construction
- Encoding
- Error correction
- Performance

In the case quantum codes, there is yet another component that plays a much more important role than in case of classical codes. The codes should be suitable for fault tolerant computation *i.e.*, we should be able to perform logical operations on the encoded data without having to decode them. The encoded operations must also ensure that the errors must not propagate catastrophically beyond the error correcting capability of the code. In this thesis we will not get into the issues of fault tolerance. We shall address the problem of construction and performance in more detail in the later chapters of this dissertation. Let us look at the other two aspects.

Since quantum codes are subspaces in  $\mathbb{C}^{2^n}$ , constructing quantum codes can be viewed as packing of subspaces in  $\mathcal{H}$ . In fact, the original approaches to quantum error correction were along this route. This geometric picture while intuitive is not very convenient; fortunately, we can translate the problem of construction into one with a lot more algebraic flavor and more importantly, into a much more familiar language involving construction of

classical codes. We will have much more to say on this topic of how to link the classical codes and the subspaces in  $\mathcal{H}$  later in Chapters III and V.

Assume for now that we have some means to choose a subspace to be our quantum code,  $Q$ . Then, from linear algebra we know that we can project onto a subspace by means of a projector. A projector  $P$  satisfies  $P^2 = P$ . A projector for  $Q$  can be easily constructed by choosing an orthonormal basis of the subspace  $Q$ , say  $\{|\alpha_1\rangle, \dots, |\alpha_K\rangle\}$ , and forming the following matrix

$$P = \sum_{i=1}^K |\alpha_i\rangle \langle \alpha_i|.$$

The dimension of the subspace is related to  $P$  as  $\dim Q = \text{Tr}(P)$ . The subspace induces a decomposition of the Hilbert space into orthogonal subspaces. Encoding amounts to realizing  $P$ , though there are important subtleties to be addressed, (such as the nonunitariness of  $P$ ). For instance, the encoding in equation (2.10) can be easily accomplished using the following circuit.

$$\left. \begin{array}{l} a|0\rangle + b|1\rangle \\ |0\rangle \\ |0\rangle \end{array} \right\} \begin{array}{c} \bullet \quad \bullet \\ \oplus \quad \oplus \end{array} \left. \right\} a|000\rangle + b|111\rangle$$

We shall study encoding circuits in more detail in Chapter VII when we discuss encoding of subsystem codes.

When it comes to quantum error correction, there are a few points worth highlighting. Error correction or error recovery implies that we correct the errors on the encoded information without finding out what was the original information stored. By decoding we mean the process of extracting the information from the encoded qubits. It presumes that error correction has already been performed. Classically, we do not have to make such fine distinction between error correction and decoding because once error correction is performed it is not difficult to obtain the information that was encoded without affecting the encoded state. In the quantum setting decoding amounts to destroying the encoded state.

In the context of fault tolerant quantum computation we would not like to decode until the end of the computation as it would remove the protection afforded by the code. Unless explicitly mentioned our focus will be on error recovery or correction. We will assume that the decoding of the encoded information is performed at the end of the computation. In this dissertation we will be concerned with error correction unless specified otherwise.

Let us look at the error correction process in a little more detail. Assume that we use the encoding given in equation (2.10). Suppose that there is a bit flip error on the first qubit, also called an  $X$  error. Then we have

$$a |000\rangle + b |111\rangle \xrightarrow{\text{Bit flip}} a |100\rangle + b |011\rangle.$$

We cannot take a majority voting to figure out the error as in the classical case because if we observed the state we would collapse the state to either  $|100\rangle$  or  $|011\rangle$ . Although we maybe able to find that there was an error on the first qubit, we have also damaged the state. Thus error correction process is a little more complicated in the quantum case. We must not perform a full measurement of the system. We solve this problem by partial measurements and the use of additional qubits called ancilla. Let us illustrate this for our running example. We can compute the parity of the first two qubits and the second two qubits as follows.

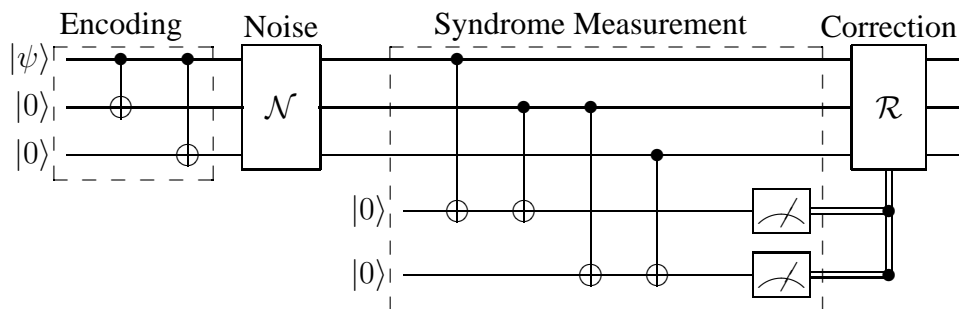

The state of the qubits changes as follows as we move across the circuit:

$$\begin{aligned}
& a |0\rangle + b |1\rangle |00\rangle |00\rangle \xrightarrow{\text{Encoder}} (a |000\rangle + b |111\rangle) |00\rangle \xrightarrow{\text{Noise}} (a |100\rangle + b |011\rangle) |00\rangle \\
& \xrightarrow{\text{CNOT}^{1,4}} (a |100\rangle |1\rangle + b |011\rangle |0\rangle) |0\rangle \xrightarrow{\text{CNOT}^{2,4}} (a |100\rangle |1\rangle + b |011\rangle |1\rangle) |0\rangle \\
& = (a |100\rangle + b |011\rangle) |1\rangle |0\rangle
\end{aligned}$$

It will be seen that the first ancilla qubit becomes entangled with the encoded state briefly and then becomes unentangled. At this point we can make a measurement of the ancilla without disturbing the rest of the encoded state. The double lines indicate classical bits. We can then perform a correction operation based on the measurement of ancilla qubits. The value measured is usually called the syndrome.

The important thing to notice is that if we have an error then the codespace is taken to an orthogonal subspace of  $\mathbb{C}^{2^n}$ , in the example considered it is the space spanned by  $|100\rangle$  and  $|011\rangle$ . On the other hand consider an error that flips all the qubits. This error takes  $|000\rangle$  to  $|111\rangle$  and vice versa. Its action on  $Q$  is to merely permute the basis vectors. Since it takes valid codevectors to valid codevectors, it cannot be detected. Finally, let us consider an error which has no classical analogue. If we had a  $Z$  error on the first two qubits, then it would take  $|000\rangle$  to  $|000\rangle$  and  $|111\rangle$  to  $|111\rangle$ . So a nontrivial error can act trivially on the codespace. We consider such errors to be harmless. This gives us a general principle for an error to be detectable. We shall make use of this lemma later, especially in Chapters III, V.

**Lemma II.1** ([95]). *Given a quantum code  $Q$ , with projector  $P$ , and  $|\alpha\rangle$  and  $|\beta\rangle$  two orthogonal vectors in  $Q$ . An error  $E$  is detectable if and only if  $\langle\alpha|E|\beta\rangle = \lambda_E \langle\alpha|\beta\rangle$ , where  $\lambda_E$  depends only on  $E$ . Alternatively, an error is detectable if and only if  $PEP = \lambda_E P$ .*

Given a set of errors  $\{E_1, E_2, \dots, E_l\}$  that are detectable by  $Q$ , their linear span is also detectable by  $Q$ . The subspace  $Q$  induces a decomposition of  $\mathbb{C}^{2^n}$ . Detectable errors take



the subspace one of the orthogonal subspaces, while undetectable errors take  $Q$  to itself.

### C. Classical Coding Theory

In this section we discuss some of the relevant aspects of classical codes setting the stage for our work on quantum error correction. In view of vastness of the subject, the reader is recommended standard textbooks in the field such as [76, 104, 107] for a comprehensive treatment of the field.

Let  $\mathbb{F}_q$  denote a finite field with  $q$  elements; we have  $q = p^m$  for some prime  $p$ . If  $x = (x_1, \dots, x_n) \in \mathbb{F}_q^n$ , then we denote the Hamming weight of  $x$  as

$$\text{wt}(x) = |\{x_i \neq 0\}|, \quad (2.11)$$

*i.e.*, it is the number of nonzero coordinates of  $x$ . We say that a subset  $C \subseteq \mathbb{F}_q^n$  is an *additive code* if for any  $x, y$  in  $C$ ,  $x + y$  is also in  $C$ . Additive codes play an important role in quantum error correction. If in addition to being additive,  $C$  also satisfies  $\alpha c \in C$  for any  $\alpha \in \mathbb{F}_q$  and  $c \in C$ , then  $C$  is said to be an  $\mathbb{F}_q$ -linear code. Such codes often have simpler encoding and decoding schemes while being tractable in terms of construction and analysis. The *minimum distance* of a set  $C \subset \mathbb{F}_q^n$  is defined as

$$\text{wt}(C) = \min_{\substack{x, y \in C \\ x \neq y}} \{\text{wt}(x - y)\}. \quad (2.12)$$

The (minimum) distance of a code is indicative of the error correcting capabilities of the code. If  $C$  is an additive code, its distance is given by

$$\text{wt}(C) = \min_{0 \neq c \in C} \text{wt}(c). \quad (2.13)$$

A classical  $(n, K, d)_q$  code  $C \subseteq \mathbb{F}_q^n$  is subset of  $\mathbb{F}_q^n$  of size  $|C| = K$  and distance  $d = \text{wt}(C)$ . If  $|C| = q^k$ , then we denote it by  $[n, k, d]_q$ . If  $C$  is also  $\mathbb{F}_q$ -linear code, then

$C$  is a  $k$ -dimensional subspace of  $\mathbb{F}_q^n$ . Linear codes are often described by giving a basis of codewords in the form a matrix, often called as the generator matrix. For example, consider the  $[7, 4, 3]_2$  Hamming code with the generator matrix

$$G = \left[ \begin{array}{cccc|ccc} 1 & 0 & 0 & 0 & 1 & 1 & 0 \\ 0 & 1 & 0 & 0 & 1 & 0 & 1 \\ 0 & 0 & 1 & 0 & 0 & 1 & 1 \\ 0 & 0 & 0 & 1 & 1 & 1 & 1 \end{array} \right].$$

It consists of all the linear combinations of the rows of  $G$ . When the generator matrix is in the form  $[I|P]$  we say that it is in the standard form. We define the Euclidean inner product between two codewords  $x, y \in \mathbb{F}_q^n$  as

$$x \cdot y = x_1y_1 + \cdots + x_ny_n = \sum_{i=1}^n x_iy_i. \quad (2.14)$$

The Euclidean inner product enables us to define a dual code. It is defined as

$$C^\perp = \{x \in \mathbb{F}_q^n \mid x \cdot c = 0 \text{ for all } c \in C\}. \quad (2.15)$$

This is also called as the Euclidean dual of  $C$ . The dual code is itself a linear code with its own generator matrix  $H$ . A generator matrix of  $C^\perp$  is also called a parity check matrix for  $C$ . For the example just considered, a parity check matrix is given by

$$H = \left[ \begin{array}{cccc|ccc} 1 & 1 & 0 & 1 & 1 & 0 & 0 \\ 1 & 0 & 1 & 1 & 0 & 1 & 0 \\ 0 & 1 & 1 & 1 & 0 & 0 & 1 \end{array} \right].$$

When the generator matrix for  $C$  is given in the standard form  $[I_k|P]$ , a parity check matrix is easily obtained as  $[-P^t|I_{n-k}]$ . One important relation between the generator matrix and the parity check matrix is that  $GH^t = 0$ . When a code  $C \subseteq C^\perp$ , we say that  $C$  is a self-

orthogonal code. If  $C = C^\perp$ , then we say it is a self-dual code. In the context of quantum error correcting codes, dual codes and self-orthogonal codes play a much more significant role than in the classical case. Additionally, we encounter far more general notions of inner products.

## CHAPTER III

## THEORY OF NONBINARY STABILIZER CODES\*

As mentioned earlier, quantum codes were developed to make fault-tolerant quantum computation possible. The most widely studied class of quantum error-correcting codes are binary stabilizer codes, see [14, 15, 26, 34, 36, 41–44, 49, 56, 60, 61, 63, 64, 66, 68, 69, 72, 84, 85, 87, 108, 127, 142, 144–147, 151, 154] and, in particular, the seminal works [35, 59]. An appealing aspect of binary stabilizer codes is that there exist links to classical coding theory that facilitate the construction of good codes. More recently, some results were generalized to the case of nonbinary stabilizer codes [1, 10, 11, 28, 39, 40, 53, 54, 62, 71, 73, 86, 102, 109, 126, 132, 137, 138], but the theory is not nearly as complete as in the binary case.

One would naturally ask why study nonbinary codes? There are at least three reasons for our interest in nonbinary codes. The first reason is the generalization is a nontrivial mathematical problem that is of interest in itself. Results which are considerably easy to prove in the binary case turn out to be much more formidable requiring the use of elegant mathematical techniques to solve the problems. The second reason is a practical one and motivated by the behavior of classical codes. Many good classical codes like Reed-Solomon codes are nonbinary codes. Algebraic geometric codes that were the first shown to beat the Gilbert-Varshamov bound were once again nonbinary codes. Even in the case LDPC codes it has been shown that increasing the alphabet size improves the performance albeit at the expense of complexity. As we shall see the close connections between the classical and quantum codes tempt the conclusion that perhaps one would expect to find good classes of quantum codes over a larger alphabet. Thirdly, quite often many implementations

---

\*©2006 IEEE. Reprinted in part, with permission, from A. Ketkar, A. Klappenecker, S. Kumar and P. K. Sarvepalli, “Nonbinary stabilizer codes over finite fields”. *IEEE Trans. Inform. Theory*, vol. 52, no. 11, pp. 4892–4914, 2006.

naturally allow for a multilevel quantum system. These extra modes are usually ignored; but lately they have received interest, see [23, 30, 46, 65, 113] and references therein. Additionally, as shown in [130], if properly exploited, this can lead to efficient implementation of gates. All these reasons motivate our investigations of nonbinary quantum codes.

This chapter has two primary goals. On one hand we provide a review of the theory of stabilizer codes and on the other we also extend and generalize many of the results. This chapter is structured as follows. We recall the basic principles of nonbinary stabilizer codes over finite fields in Section A. In Section B, we introduce a Galois theory for quantum error-correcting codes. The original theory developed by Evariste Galois relates field extensions to groups. Oystein Ore derived a significantly more general theory for pairs of lattices [116]. We use this framework and set up a Galois correspondence between quantum error-correcting codes and groups. This theory shows how some properties of general quantum codes, such as bounds on the minimum distance, can be deduced from results about stabilizer codes.

In Section C, we recall that stabilizer codes over a finite field  $\mathbb{F}_q$  correspond to additive codes over  $\mathbb{F}_q$  that are self-orthogonal with respect to a trace-symplectic form [11]. We also establish the correspondence to additive codes over  $\mathbb{F}_{q^2}$  that are self-orthogonal with respect to a trace-alternating form; remarkably, this basic construction had been missing in the literature, in spite of the fact that it is a generalization of the famous  $\mathbb{F}_4$ -codes [35].

The MacWilliams relations for weight enumerators of stabilizer codes are particularly easy to prove, as we show in Section D. We then derive upper and lower bounds on the minimum distance of the best possible stabilizer codes in Section E. Section F details methods to construct new methods to construct quantum codes from existing quantum codes. Unlike classical codes, puncturing quantum codes is a relatively complex task. So we include a generalization of the puncturing theory introduced by Rains to additive codes that are not necessarily pure. In a later chapter we show how to apply it.

Apart from the basics of quantum computing, we recommend [35] and [61] for background on binary stabilizer codes, in addition to books on classical coding theory, such as [76, 104, 107]. The general theory of quantum codes is discussed in [95], and we assume that the reader is familiar with the notion of a detectable error, as introduced there.

*Notations.* We assume throughout this chapter that  $\mathbb{F}_q$  denotes a finite field of characteristic  $p$ ; in particular,  $q$  always denotes a power of a prime  $p$ . The trace function from  $\mathbb{F}_{q^m}$  to  $\mathbb{F}_q$  is defined as  $\text{tr}_{q^m/q}(x) = \sum_{k=0}^{m-1} x^{q^k}$ ; we may omit the subscripts if  $\mathbb{F}_q$  is the prime field. If  $G$  is a group, then we denote by  $Z(G)$  the center of  $G$ . If  $S \subseteq G$ , then we denote by  $C_G(S)$  the centralizer of  $S$  in  $G$ . We write  $H \leq G$  to express the fact that  $H$  is a subgroup of  $G$ . The trace  $\text{Tr}(M)$  of a square matrix  $M$  is the sum of the diagonal elements of  $M$ .

#### A. Stabilizer Codes

Let  $\mathbb{C}^q$  be a  $q$ -dimensional complex vector space representing the states of a quantum mechanical system. We denote by  $|x\rangle$  the vectors of a distinguished orthonormal basis of  $\mathbb{C}^q$ , where the labels  $x$  range over the elements of a finite field  $\mathbb{F}_q$  with  $q$  elements. A quantum error-correcting code  $Q$  is a  $K$ -dimensional subspace of  $\mathbb{C}^{q^n} = \mathbb{C}^q \otimes \dots \otimes \mathbb{C}^q$ .

We need to select an appropriate error model so that we can measure the performance of a code. We simplify matters by choosing a basis  $\mathcal{E}_n$  of the vector space of complex  $q^n \times q^n$  matrices to represent a discrete set of errors. A stabilizer code is defined as the joint eigenspace of a subset of  $\mathcal{E}_n$ , so the error operators play a crucial role.

## 1. Error Bases

Let  $a$  and  $b$  be elements of the finite field  $\mathbb{F}_q$ . We define the unitary operators  $X(a)$  and  $Z(b)$  on  $\mathbb{C}^q$  by

$$X(a) |x\rangle = |x + a\rangle, \quad Z(b) |x\rangle = \omega^{\text{tr}(bx)} |x\rangle,$$

where  $\text{tr}$  denotes the trace operation from the extension field  $\mathbb{F}_q$  to the prime field  $\mathbb{F}_p$ , and  $\omega = \exp(2\pi i/p)$  is a primitive  $p$ th root of unity.

We form the set  $\mathcal{E} = \{X(a)Z(b) \mid a, b \in \mathbb{F}_q\}$  of error operators. The set  $\mathcal{E}$  has some interesting properties, namely (a) it contains the identity matrix, (b) the product of two matrices in  $\mathcal{E}$  is a scalar multiple of another element in  $\mathcal{E}$ , and (c) the trace  $\text{Tr}(A^\dagger B) = 0$  for distinct elements  $A, B$  of  $\mathcal{E}$ . A finite set of  $q^2$  unitary matrices that satisfy the properties (a), (b), and (c) is called a *nice error basis*, see [93].

The set  $\mathcal{E}$  of error operators forms a basis of the set of complex  $q \times q$  matrices due to property (c). We include a proof that  $\mathcal{E}$  is a nice error basis, because parts of our argument will be of independent interest in the subsequent sections.

**Lemma III.1.** *The set  $\mathcal{E} = \{X(a)Z(b) \mid a, b \in \mathbb{F}_q\}$  is a nice error basis on  $\mathbb{C}^q$ .*

*Proof.* The matrix  $X(0)Z(0)$  is the identity matrix, so property (a) holds. We also have  $\omega^{\text{tr}(ba)} X(a)Z(b) = Z(b)X(a)$ , which implies that the product of two error operators is given by

$$X(a)Z(b) X(a')Z(b') = \omega^{\text{tr}(ba')} X(a + a')Z(b + b'). \quad (3.1)$$

This is a scalar multiple of an operator in  $\mathcal{E}$ , hence property (b) holds.

Suppose that the error operators are of the form  $A = X(a)Z(b)$  and  $B = X(a)Z(b')$  for some  $a, b, b' \in \mathbb{F}_q$ . Then

$$\text{Tr}(A^\dagger B) = \text{Tr}(Z(b' - b)) = \sum_{x \in \mathbb{F}_q} \omega^{\text{tr}((b' - b)x)}.$$

The map  $x \mapsto \omega^{\text{tr}((b'-b)x)}$  is an additive character of  $\mathbb{F}_q$ . The sum of all character values is 0 unless the character is trivial; thus,  $\text{Tr}(A^\dagger B) = 0$  when  $b' \neq b$ .

On the other hand, if  $A = X(a)Z(b)$  and  $B = X(a')Z(b')$  are two error operators satisfying  $a \neq a'$ , then the diagonal elements of the matrix  $A^\dagger B = Z(-b)X(a' - a)Z(b')$  are 0, which implies  $\text{Tr}(A^\dagger B) = 0$ . Thus, whenever  $A$  and  $B$  are distinct element of  $\mathcal{E}$ , then  $\text{Tr}(A^\dagger B) = 0$ , which proves (c).  $\square$

**Example III.2.** We give an explicit construction of a nice error basis with  $q = 4$  levels. The finite field  $\mathbb{F}_4$  consists of the elements  $\mathbb{F}_4 = \{0, 1, \alpha, \bar{\alpha}\}$ . We denote the four standard basis vectors of the complex vector space  $\mathbb{C}^4$  by  $|0\rangle, |1\rangle, |\alpha\rangle$ , and  $|\bar{\alpha}\rangle$ . Let  $\mathbf{1}_2$  denote the  $2 \times 2$  identity matrix,  $\sigma_x = \begin{pmatrix} 0 & 1 \\ 1 & 0 \end{pmatrix}$ , and  $\sigma_z = \begin{pmatrix} 1 & 0 \\ 0 & -1 \end{pmatrix}$ . Then

$$\begin{aligned} X(0) &= \mathbf{1}_2 \otimes \mathbf{1}_2, & X(1) &= \mathbf{1}_2 \otimes \sigma_x, \\ X(\alpha) &= \sigma_x \otimes \mathbf{1}_2, & X(\bar{\alpha}) &= \sigma_x \otimes \sigma_x, \\ Z(0) &= \mathbf{1}_2 \otimes \mathbf{1}_2, & Z(1) &= \sigma_z \otimes \mathbf{1}_2, \\ Z(\alpha) &= \sigma_z \otimes \sigma_z, & Z(\bar{\alpha}) &= \mathbf{1}_2 \otimes \sigma_z. \end{aligned}$$

We see that this nice error basis is obtained by tensoring the Pauli basis, a nice error basis on  $\mathbb{C}^2$ . The next lemma shows that this is a general design principle for nice error bases.

**Lemma III.3.** If  $\mathcal{E}_1$  and  $\mathcal{E}_2$  are nice error bases, then

$$\mathcal{E} = \{E_1 \otimes E_2 \mid E_1 \in \mathcal{E}_1, E_2 \in \mathcal{E}_2\}$$

is a nice error basis as well.

The proof of this observation follows directly from the definitions.

Let  $\mathbf{a} = (a_1, \dots, a_n) \in \mathbb{F}_q^n$ . We write  $X(\mathbf{a}) = X(a_1) \otimes \dots \otimes X(a_n)$  and  $Z(\mathbf{a}) = Z(a_1) \otimes \dots \otimes Z(a_n)$  for the tensor products of  $n$  error operators. Our aim is to provide an error model that conveniently represents errors acting locally on one quantum system. Using the new notations, we can easily formulate this model.



**Corollary III.4.** *The set  $\mathcal{E}_n = \{X(\mathbf{a})Z(\mathbf{b}) \mid \mathbf{a}, \mathbf{b} \in \mathbb{F}_q^n\}$  is a nice error basis on the complex vector space  $\mathbb{C}^{q^n}$ .*

*Remark.* Several authors have used an error basis that is equivalent to our definition of  $\mathcal{E}_n$ , see [11, 54, 86, 109]. We have defined the operator  $Z(b)$  in a slightly different way, so that the properties relevant for the design of stabilizer codes become more transparent. In particular, we can avoid an intermediate step that requires tensoring  $p \times p$ -matrices, and that allows us to obtain the trace-symplectic form directly, see Lemma III.5.

## 2. Stabilizer Codes

Let  $G_n$  denote the group generated by the matrices of the nice error basis  $\mathcal{E}_n$ . It follows from equation (3.1) that

$$G_n = \{\omega^c X(\mathbf{a})Z(\mathbf{b}) \mid \mathbf{a}, \mathbf{b} \in \mathbb{F}_q^n, c \in \mathbb{F}_p\}. \quad (3.2)$$

Note that  $G_n$  is a finite group of order  $pq^{2n}$ . We call  $G_n$  the *error group* associated with the nice error basis  $\mathcal{E}_n$ .

A *stabilizer code*  $Q$  is a non-zero subspace of  $\mathbb{C}^{q^n}$  that satisfies

$$Q = \bigcap_{E \in S} \{v \in \mathbb{C}^{q^n} \mid Ev = v\} \quad (3.3)$$

for some subgroup  $S$  of  $G_n$ . In other words,  $Q$  is the joint eigenvalue-1 eigenspace of a subgroup  $S$  of the error group  $G_n$ .

*Remark.* A crucial property of a stabilizer code is that it contains *all* joint eigenvectors of  $S$  with eigenvalue 1, as equation (3.3) indicates. If the code is smaller and does not exhaust all joint eigenvectors of  $S$  with eigenvalue 1, then it is not a stabilizer code for  $S$ .

### 3. Minimum Distance

The error correction and detection capabilities of a quantum error-correcting code  $Q$  are the most crucial aspects of the code. Recall that a quantum code  $Q$  is able to detect an error  $E$  in the unitary group  $U(q^n)$  if and only if the condition  $\langle c_1|E|c_2\rangle = \lambda_E\langle c_1|c_2\rangle$  holds for all  $c_1, c_2 \in Q$ , see [95].

It turns out that a stabilizer code  $Q$  with stabilizer  $S$  can detect all errors in  $G_n$  that are scalar multiples of elements in  $S$  or that do not commute with some element of  $S$ , see Lemma III.11. In particular, an error in  $G_n$  that is not detectable has to commute with all elements of the stabilizer. Commuting elements in  $G_n$  are characterized as follows:

**Lemma III.5.** *Two elements  $E = \omega^c X(\mathbf{a})Z(\mathbf{b})$  and  $E' = \omega^{c'} X(\mathbf{a}')Z(\mathbf{b}')$  of the error group  $G_n$  satisfy the relation*

$$EE' = \omega^{\text{tr}(\mathbf{b}\cdot\mathbf{a}' - \mathbf{b}'\cdot\mathbf{a})} E'E.$$

*In particular, the elements  $E$  and  $E'$  commute if and only if the trace symplectic form  $\text{tr}(\mathbf{b}\cdot\mathbf{a}' - \mathbf{b}'\cdot\mathbf{a})$  vanishes.*

*Proof.* It follows from equation (3.1) that  $EE' = \omega^{\text{tr}(\mathbf{b}\cdot\mathbf{a}')} X(\mathbf{a} + \mathbf{a}')Z(\mathbf{b} + \mathbf{b}')$  and  $E'E = \omega^{\text{tr}(\mathbf{b}'\cdot\mathbf{a})} X(\mathbf{a} + \mathbf{a}')Z(\mathbf{b} + \mathbf{b}')$ . Therefore, multiplying  $E'E$  by the scalar  $\omega^{\text{tr}(\mathbf{b}\cdot\mathbf{a}' - \mathbf{b}'\cdot\mathbf{a})}$  yields  $EE'$ , as claimed.  $\square$

We define the *symplectic weight*  $\text{swt}$  of a vector  $(\mathbf{a}|\mathbf{b})$  in  $\mathbb{F}_q^{2n}$  as

$$\text{swt}((\mathbf{a}|\mathbf{b})) = |\{k \mid (a_k, b_k) \neq (0, 0)\}|.$$

The weight  $w(E)$  of an element  $E = \omega^c X(\mathbf{a})Z(\mathbf{b})$  in the error group  $G_n$  is defined to be the number of nonidentity tensor components,  $w(E) = \text{swt}((\mathbf{a}|\mathbf{b}))$ . In particular, the weight of a scalar multiple of the identity matrix is by definition zero.

A quantum code  $Q$  has *minimum distance*  $d$  if and only if it can detect all errors in  $G_n$  of weight less than  $d$ , but cannot detect some error of weight  $d$ . We say that  $Q$  is an  $((n, K, d))_q$  code if and only if  $Q$  is a  $K$ -dimensional subspace of  $\mathbb{C}^{q^n}$  that has minimum distance  $d$ . An  $((n, q^k, d))_q$  code is also called an  $[[n, k, d]]_q$  code. We remark that some authors are more restrictive and use the bracket notation just for stabilizer codes.

We say that a quantum code  $Q$  is *pure to  $t$*  if and only if its stabilizer group  $S$  does not contain non-scalar matrices of weight less than  $t$ . A quantum code is called *pure* if and only if it is pure to its minimum distance. As in [35], we always assume that an  $[[n, 0, d]]_q$  code has to be pure.

*Remarks.* (a) If a quantum error-correcting code can detect a set  $\mathcal{D}$  of errors, then it can detect all errors in the linear span of  $\mathcal{D}$ . (b) A code of minimum distance  $d$  can correct all errors of weight  $t = \lfloor (d-1)/2 \rfloor$  or less.

## B. Galois Connection

We want to clarify the relation between stabilizer codes and more general quantum codes before we proceed further. Let us denote by  $\mathcal{Q}$  the set of all subspaces of  $\mathbb{C}^{q^n}$ . The set  $\mathcal{Q}$  is partially ordered by the inclusion relation. Any two elements of  $\mathcal{Q}$  have a least upper bound and a greatest lower bound with respect to the inclusion relation, namely

$$\sup\{Q, Q'\} = Q + Q' \quad \text{and} \quad \inf\{Q, Q'\} = Q \cap Q'.$$

Therefore,  $\mathcal{Q}$  is a complete (order) lattice. An element of this lattice is a quantum error-correcting code or is equal to the vector space  $\{0\}$ .

Let  $\mathcal{G}$  denote the lattice of subgroups of the error group  $G_n$ . We will introduce two order-reversing maps between  $\mathcal{G}$  and  $\mathcal{Q}$  that establish a Galois connection. We will see that stabilizer codes are distinguished elements of  $\mathcal{Q}$  that remain the same when mapped to the

lattice  $\mathcal{G}$  and back.

Let us define a map  $\text{Fix}$  from the lattice  $\mathcal{G}$  of subgroups to the lattice  $\mathcal{Q}$  of subspaces that associates to a group  $S$  its joint eigenspace with eigenvalue 1,

$$\text{Fix}(S) = \bigcap_{E \in S} \{v \in \mathbb{C}^{q^n} \mid Ev = v\}. \quad (3.4)$$

We define for the reverse direction a map  $\text{Stab}$  from the lattice  $\mathcal{Q}$  to the lattice  $\mathcal{G}$  that associates to a quantum code  $Q$  its stabilizer group  $\text{Stab}(Q)$ ,

$$\text{Stab}(Q) = \{E \in G_n \mid Ev = v \text{ for all } v \in Q\}. \quad (3.5)$$

We obtain four direct consequences of the definitions (3.4) and (3.5):

**G1.** If  $Q_1 \subseteq Q_2$  are subspaces of  $\mathbb{C}^{q^n}$ , then  $\text{Stab}(Q_2) \leq \text{Stab}(Q_1)$ .

**G2.** If  $S_1 \leq S_2$  are subgroups of  $G_n$ , then  $\text{Fix}(S_2) \leq \text{Fix}(S_1)$ .

**G3.** A subspace  $Q$  of  $\mathbb{C}^{q^n}$  satisfies  $Q \subseteq \text{Fix}(\text{Stab}(Q))$ .

**G4.** A subgroup  $S$  of  $G_n$  satisfies  $S \leq \text{Stab}(\text{Fix}(S))$ .

The first two properties establish that  $\text{Fix}$  and  $\text{Stab}$  are order-reversing maps. The extension properties G3 and G4 establish that  $\text{Fix}$  and  $\text{Stab}$  form a Galois connection, see [29, page 56]. The general theory of Galois connections establishes, among other results, that  $\text{Fix}(S) = \text{Fix}(\text{Stab}(\text{Fix}(S)))$  and  $\text{Stab}(Q) = \text{Stab}(\text{Fix}(\text{Stab}(Q)))$  holds for all  $S$  in  $\mathcal{G}$  and all  $Q$  in  $\mathcal{Q}$ .

A subspace  $Q$  of the vector space  $\mathbb{C}^{q^n}$  satisfying G3 with equality is called a *closed subspace*, and a subgroup  $S$  of the error group  $G_n$  satisfying G4 with equality is called a *closed subgroup*. We record the main result of abstract Galois theory in the following proposition.

**Proposition III.6.** *The closed subspaces of the vector space  $\mathbb{C}^{q^n}$  form a complete sublattice  $\mathcal{Q}_c$  of the lattice  $\mathcal{Q}$ . The closed subgroups of  $G_n$  form a complete sublattice  $\mathcal{G}_c$  of the lattice  $\mathcal{G}$  that is dual isomorphic to the lattice  $\mathcal{Q}_c$ .*

*Proof.* This result holds for any Galois connection, see Theorem 10 in the book by Birkhoff [29, page 56].  $\square$

We need to characterize the closed subspaces and subgroups to make this proposition useful. We begin with the closed subspaces because this is easier.

**Lemma III.7.** *A closed subspace is a stabilizer code or is 0-dimensional.*

*Proof.* By definition, a closed subspace  $Q$  satisfies

$$Q = \text{Fix}(\text{Stab}(Q)) = \bigcap_{E \in \text{Stab}(Q)} \{v \in \mathbb{C}^{q^n} \mid Ev = v\},$$

hence is a stabilizer code or  $\{0\}$ .  $\square$

**Lemma III.8.** *If  $Q$  is a nonzero subspace of  $\mathbb{C}^{q^n}$ , then its stabilizer  $S = \text{Stab}(Q)$  is an abelian group satisfying  $S \cap Z(G_n) = \{1\}$ .*

*Proof.* Suppose that  $E$  and  $E'$  are non-commuting elements of  $S = \text{Stab}(Q)$ . By Lemma III.5, we have  $EE' = \omega^k E'E$  for some  $\omega^k \neq 1$ . A nonzero vector  $v$  in  $Q$  would have to satisfy  $v = EE'v = \omega^k E'E'v = \omega^k v$ , contradiction. Therefore,  $S$  is an abelian group. The stabilizer cannot contain any element  $\omega^k \mathbf{1}$ , unless  $k = 0$ , which proves the second assertion.  $\square$

**Lemma III.9.** *Suppose that  $S$  is the stabilizer of a vector space  $Q$ . An orthogonal projector onto the joint eigenspace  $\text{Fix}(S)$  is given by*

$$P = \frac{1}{|S|} \sum_{E \in S} E.$$

*Proof.* A vector  $v$  in  $\text{Fix}(S)$  satisfies  $Pv = v$ , hence  $\text{Fix}(S)$  is contained in the image of  $P$ . Conversely, note that  $EP = P$  holds for all  $E$  in  $S$ , hence any vector in the image of  $P$  is an eigenvector with eigenvalue 1 of all error operators  $E$  in  $S$ . Therefore,  $\text{Fix}(S) = \text{image } P$ . The operator  $P$  is idempotent, because

$$P^2 = \frac{1}{|S|} \sum_{E \in S} EP = \frac{1}{|S|} \sum_{E \in S} P = P$$

holds. The inverse  $E^\dagger$  of  $E$  is contained in the group  $S$ , hence  $P^\dagger = P$ . Therefore,  $P$  is an orthogonal projector onto  $\text{Fix}(S)$ .  $\square$

*Remark.* If  $S$  is a nonabelian subgroup of the group  $G_n$ , then it necessarily contains the center  $Z(G_n)$  of  $G_n$ ; it follows that  $P$  is equal to the all-zero matrix. Note that the image of  $P$  has dimension  $\text{Tr}(P) = q^n/|S|$ .

**Lemma III.10.** *A subgroup  $S$  of  $G_n$  is closed if and only if  $S$  is an abelian subgroup that satisfies  $S \cap Z(G_n) = \{1\}$  or if  $S$  is equal to  $G_n$ .*

*Proof.* Suppose that  $S$  is a closed subgroup of  $G_n$ . The vector space  $Q = \text{Fix}(S)$  is, by definition, either a stabilizer code or a 0-dimensional vector space. We have  $\text{Stab}(\{0\}) = G_n$ . Furthermore, if  $Q \neq \{0\}$ , then  $\text{Stab}(Q) = S$  is an abelian group satisfying  $S \cap Z(G_n) = \{1\}$ , by Lemma III.8.

Conversely, suppose that  $S$  is an abelian subgroup of  $G_n$  such that  $S$  trivially intersects the center  $Z(G_n)$ . Let  $S^* = \text{Stab}(\text{Fix}(S))$ . We have  $\text{Fix}(S^*) = \text{Fix}(\text{Stab}(\text{Fix}(S))) = \text{Fix}(S)$ , because this holds for any pair of maps that form a Galois connection. It follows from Lemma III.9 that

$$q^n/|S^*| = \text{Tr} \left( \frac{1}{|S^*|} \sum_{E \in S^*} E \right) = \text{Tr} \left( \frac{1}{|S|} \sum_{E \in S} E \right) = q^n/|S|.$$

Since  $S \leq S^*$ , this shows that  $S = S^* = \text{Stab}(\text{Fix}(S))$ ; hence,  $S$  is a closed subgroup of  $G_n$ . We note that  $\text{Fix}(G_n) = \{0\}$ , so that  $G_n = \text{Stab}(\text{Fix}(G_n))$  is closed.  $\square$

The stabilizer codes are easier to study than arbitrary quantum codes, as we will see in the subsequent sections. If we know the error correction capabilities of stabilizer codes, then we sometimes get a lower bound on the minimum distance of an arbitrary code by the following simple observation:

**Fact.** An arbitrary quantum code  $Q$  is contained in the larger stabilizer code given by  $Q^* = \text{Fix}(\text{Stab}(Q))$ . If an error  $E$  can be detected by  $Q^*$ , then it can be detected by  $Q$  as well. Therefore, if the stabilizer code  $Q^*$  has minimum distance  $d$ , then the quantum code  $Q$  has at least minimum distance  $d$ .

### C. Additive Codes

The previous section explored the relation between stabilizer codes and other quantum codes. We show next how stabilizer codes are related to classical codes (namely, additive codes over  $\mathbb{F}_q$  or  $\mathbb{F}_{q^2}$ ). The classical codes allow us to characterize the errors in  $G_n$  that are detectable by the stabilizer code.

In the binary case, the problem of finding stabilizer codes of length  $n$  had been translated into (a) finding binary classical codes of length  $2n$  that are self-orthogonal with respect to a symplectic inner product or (b) finding classical codes of length  $n$  over  $\mathbb{F}_4$  that are self-orthogonal with respect to a trace-inner product, see [35]. The approach (a) was generalized to prime alphabets by Rains [126] and to prime-power alphabets by Ashikhmin and Knill [11]. We simplify the arguments and include a full proof of this connection. There were many attempts to generalize the approach (b) to nonbinary alphabets, but without complete success (but see for instance [86, 109, 126] for notable partial solutions). We fill this gap and introduce a natural generalization of (b). Furthermore, we discuss simpler constructions for linear codes. Before exploring these connections to classical codes, we first recall some facts about detectable errors.

If  $S$  is a subgroup of  $G_n$ , then  $C_{G_n}(S)$  denotes centralizer of  $S$  in  $G_n$ ,

$$C_{G_n}(S) = \{E \in G_n \mid EF = FE \text{ for all } F \in S\},$$

and  $SZ(G_n)$  denotes the group generated by  $S$  and the center  $Z(G_n)$ . We first recall the following characterization of detectable errors (see also [11]; the interested reader can find a more general approach in [88, 92]).

**Lemma III.11.** *Suppose that  $S \leq G_n$  is the stabilizer group of a stabilizer code  $Q$  of dimension  $\dim Q > 1$ . An error  $E$  in  $G_n$  is detectable by the quantum code  $Q$  if and only if either  $E$  is an element of  $SZ(G_n)$  or  $E$  does not belong to the centralizer  $C_{G_n}(S)$ .*

*Proof.* An element  $E$  in  $SZ(G_n)$  is a scalar multiple of a stabilizer; thus, it acts by multiplication with a scalar  $\lambda_E$  on  $Q$ . It follows that  $E$  is a detectable error.

Suppose now that  $E$  is an error in  $G_n$  that does not commute with some element  $F$  of the stabilizer  $S$ ; it follows that  $EF = \lambda FE$  for some complex number  $\lambda \neq 1$ , see Lemma III.5. All vectors  $u$  and  $v$  in  $Q$  satisfy the condition

$$\langle u \mid E \mid v \rangle = \langle u \mid EF \mid v \rangle = \lambda \langle u \mid FE \mid v \rangle = \lambda \langle u \mid E \mid v \rangle; \quad (3.6)$$

hence,  $\langle u \mid E \mid v \rangle = 0$ . It follows that the error  $E$  is detectable.

Finally, suppose that  $E$  is an element of  $C_{G_n}(S) \setminus SZ(G_n)$ . Seeking a contradiction, we assume that  $E$  is detectable; this implies that there exists a complex scalar  $\lambda_E$  such that  $Ev = \lambda_E v$  for all  $v$  in  $Q$ . The scalar  $\lambda_E$  cannot be zero because  $E$  commutes with the elements of  $S$ , so  $EP = PEP = \lambda_E P$  and clearly  $EP \neq 0$ . Let  $S^*$  denote the abelian group generated by  $\lambda_E^{-1}E$  and by the elements of  $S$ . The joint eigenspace of  $S^*$  with eigenvalue 1 has dimension  $q^n/|S^*| < \dim Q = q^n/|S|$ . This implies that not all vectors in  $Q$  remain invariant under  $\lambda_E^{-1}E$ , in contradiction to the detectability of  $E$ .  $\square$

**Corollary III.12.** *If a stabilizer code  $Q$  has minimum distance  $d$  and is pure to  $t$ , then all*



errors  $E \in G_n$  with  $1 \leq \text{wt}(E) < \min\{t, d\}$  satisfy  $\langle u|E|v \rangle = 0$  for all  $u$  and  $v$  in  $Q$ .

*Proof.* By assumption, the weight of  $E$  is less than the minimum distance, so the error is detectable. However,  $E$  is not an element of  $Z(G_n)S$ , since the code is pure to  $t > \text{wt}(E)$ . Therefore,  $E$  does not belong to  $C_{G_n}(S)$ , and the claim follows from equation (3.6).  $\square$

### 1. Codes over $\mathbb{F}_q$

Lemma III.11 characterizes the error detection capabilities of a stabilizer code with stabilizer group  $S$  in terms of the groups  $SZ(G_n)$  and  $C_{G_n}(S)$ . The phase information of an element in  $G_n$  is not relevant for questions concerning the detectability, since an element  $E$  of  $G_n$  is detectable if and only if  $\omega E$  is detectable. Thus, if we associate with an element  $\omega^c X(\mathbf{a})Z(\mathbf{b})$  of  $G_n$  an element  $(\mathbf{a}|\mathbf{b})$  of  $\mathbb{F}_q^{2n}$ , then the group  $SZ(G_n)$  is mapped to the additive code

$$C = \{(\mathbf{a}|\mathbf{b}) \mid \omega^c X(\mathbf{a})Z(\mathbf{b}) \in SZ(G_n)\} = SZ(G_n)/Z(G_n).$$

To describe the image of the centralizer, we need the notion of a trace-symplectic form of two vectors  $(\mathbf{a}|\mathbf{b})$  and  $(\mathbf{a}'|\mathbf{b}')$  in  $\mathbb{F}_q^{2n}$ ,

$$\langle (\mathbf{a}|\mathbf{b}) \mid (\mathbf{a}'|\mathbf{b}') \rangle_s = \text{tr}_{q/p}(\mathbf{b} \cdot \mathbf{a}' - \mathbf{b}' \cdot \mathbf{a}).$$

The centralizer  $C_{G_n}(S)$  contains all elements of  $G_n$  that commute with each element of  $S$ ; thus, by Lemma III.5,  $C_{G_n}(S)$  is mapped onto the trace-symplectic dual code  $C^{\perp_s}$  of the code  $C$ ,

$$C^{\perp_s} = \{(\mathbf{a}|\mathbf{b}) \mid \omega^c X(\mathbf{a})Z(\mathbf{b}) \in C_{G_n}(S)\}.$$

The connection between these classical codes and the stabilizer code is made precise in the next theorem. This theorem is essentially contained in [11] and generalizes the well-known connection to symplectic codes [35, 59] of the binary case.

**Theorem III.13.** *An  $((n, K, d))_q$  stabilizer code exists if and only if there exists an additive code  $C \leq \mathbb{F}_q^{2n}$  of size  $|C| = q^n/K$  such that  $C \leq C^{\perp_s}$  and  $\text{swt}(C^{\perp_s} \setminus C) = d$  if  $K > 1$  (and  $\text{swt}(C^{\perp_s}) = d$  if  $K = 1$ ).*

*Proof.* Suppose that an  $((n, K, d))_q$  stabilizer code  $Q$  exists. This implies that there exists a closed subgroup  $S$  of  $G_n$  of order  $|S| = q^n/K$  such that  $Q = \text{Fix}(S)$ . The group  $S$  is abelian and satisfies  $S \cap Z(G_n) = 1$ , by Lemma III.10. The quotient  $C \cong SZ(G_n)/Z(G_n)$  is an additive subgroup of  $\mathbb{F}_q^{2n}$  such that  $|C| = |S| = q^n/K$ . We have  $C^{\perp_s} = C_{G_n}(S)/Z(G_n)$  by Lemma III.5. Since  $S$  is an abelian group,  $SZ(G_n) \leq C_{G_n}(S)$ , hence  $C \leq C^{\perp_s}$ . Recall that the weight of an element  $\omega^c X(\mathbf{a})Z(\mathbf{b})$  in  $G_n$  is equal to  $\text{swt}(\mathbf{a}|\mathbf{b})$ . If  $K = 1$ , then  $Q$  is a pure quantum code, thus  $\text{wt}(C_{G_n}(S)) = \text{swt}(C^{\perp_s}) = d$ . If  $K > 1$ , then the elements of  $C_{G_n}(S) \setminus SZ(G_n)$  have at least weight  $d$  by Lemma III.11, so that  $\text{swt}(C^{\perp_s} \setminus C) = d$ .

Conversely, suppose that  $C$  is an additive subcode of  $\mathbb{F}_q^{2n}$  such that  $|C| = q^n/K$ ,  $C \leq C^{\perp_s}$ , and  $\text{swt}(C^{\perp_s} \setminus C) = d$  if  $K > 1$  (and  $\text{swt}(C^{\perp_s}) = d$  if  $K = 1$ ). Let

$$N = \{\omega^c X(\mathbf{a})Z(\mathbf{b}) \mid c \in \mathbb{F}_p \text{ and } (\mathbf{a}|\mathbf{b}) \in C\}.$$

Notice that  $N$  is an abelian normal subgroup of  $G_n$ , because it is the pre-image of  $C = N/Z(G_n)$ . Choose a character  $\chi$  of  $N$  such that  $\chi(\omega^c \mathbf{1}) = \omega^c$ . Then

$$P_N = \frac{1}{|N|} \sum_{E \in N} \chi(E^{-1})E$$

is an orthogonal projector onto a vector space  $Q$ , because  $P_N$  is an idempotent in the group ring  $\mathbb{C}[G_n]$ , see [88, Theorem 1]. We have

$$\dim Q = \text{Tr } P_N = |Z(G_n)|q^n/|N| = q^n/|C| = K.$$

Each coset of  $N$  modulo  $Z(G_n)$  contains exactly one matrix  $E$  such that  $Ev = v$  for all  $v$

in  $Q$ . Set  $S = \{E \in N \mid Ev = v \text{ for all } v \in Q\}$ . Then  $S$  is an abelian subgroup of  $G_n$  of order  $|S| = |C| = q^n/K$ . We have  $Q = \text{Fix}(S)$ , because  $Q$  is clearly a subspace of  $\text{Fix}(S)$ , but  $\dim Q = q^n/|S| = K$ . An element  $\omega^c X(\mathbf{a})Z(\mathbf{b})$  in  $C_{G_n}(S) \setminus SZ(G_n)$  cannot have weight less than  $d$ , because this would imply that  $(\mathbf{a}|\mathbf{b}) \in C^{\perp_s} \setminus C$  has weight less than  $d$ , which is impossible. By the same token, if  $K = 1$ , then all nonidentity elements of the centralizer  $C_{G_n}(S)$  must have weight  $d$  or higher. Therefore,  $Q$  is an  $((n, K, d))_q$  stabilizer code.  $\square$

The results of this paragraph were established by Ashikhmin and Knill [11]. It is instructive to compare the two approaches, since their definition of the error basis is different (but equivalent).

## 2. Codes over $\mathbb{F}_{q^2}$

A drawback of the codes in the previous paragraph is that the symplectic weight is somewhat unusual. In the binary case, reference [35] provided a remedy by relating binary stabilizer codes to additive codes over  $\mathbb{F}_4$ , allowing the use of the familiar Hamming weight. Somewhat surprisingly, the corresponding concept was not completely generalized to  $\mathbb{F}_{q^2}$ , although [86, 109] and [126] paved the way to our approach. After an initial circulation of the results in this chapter, Gottesman drew our attention to another interesting approach that was initiated by Barnum, see [21, 22], where a sufficient condition for the existence of stabilizer codes is established using a symplectic form.

Let  $(\beta, \beta^q)$  denote a normal basis of  $\mathbb{F}_{q^2}$  over  $\mathbb{F}_q$ . We define a trace-alternating form of two vectors  $v$  and  $w$  in  $\mathbb{F}_{q^2}^n$  by

$$\langle v|w \rangle_a = \text{tr}_{q/p} \left( \frac{v \cdot w^q - v^q \cdot w}{\beta^{2q} - \beta^2} \right). \quad (3.7)$$

We note that the argument of the trace is invariant under the Galois automorphism  $x \mapsto x^q$ ,

so it is indeed an element of  $\mathbb{F}_q$ , which shows that (3.7) is well-defined.

The trace-alternating form is bi-additive, that is,  $\langle u + v | w \rangle_a = \langle u | w \rangle_a + \langle v | w \rangle_a$  and  $\langle u | v + w \rangle_a = \langle u | v \rangle_a + \langle u | w \rangle_a$  holds for all  $u, v, w \in \mathbb{F}_{q^2}^n$ . It is  $\mathbb{F}_p$ -linear, but not  $\mathbb{F}_q$ -linear unless  $q = p$  and it is alternating in the sense that  $\langle u | u \rangle_a = 0$  holds for all  $u \in \mathbb{F}_{q^2}^n$ . We write  $u \perp_a w$  if and only if  $\langle u | w \rangle_a = 0$  holds.

At this point it might be helpful to see the form the trace-alternating form takes in the binary case. A normal basis for  $\mathbb{F}_4$  over  $\mathbb{F}_2$  is given by  $\{\omega, \omega^2\}$ . Since  $\omega^2 + \omega + 1 = 0$ , the trace-alternating form simplifies to

$$\langle v | w \rangle_a = \text{tr}_{2/2} \left( \frac{v \cdot w^2 + v^2 \cdot w}{\omega^4 + \omega^2} \right) = v \cdot w^q + v^q \cdot w, \quad (3.8)$$

where we have used the facts that  $\omega^3 = 1$  and  $x = -x$  over  $\mathbb{F}_4$ .

We define a bijective map  $\phi$  that takes an element  $(\mathbf{a} | \mathbf{b})$  of the vector space  $\mathbb{F}_q^{2n}$  to a vector in  $\mathbb{F}_{q^2}$  by setting  $\phi((\mathbf{a} | \mathbf{b})) = \beta \mathbf{a} + \beta^q \mathbf{b}$ . The map  $\phi$  is isometric in the sense that the symplectic weight of  $(\mathbf{a} | \mathbf{b})$  is equal to the Hamming weight of  $\phi((\mathbf{a} | \mathbf{b}))$ .

**Lemma III.14.** *Suppose that  $c$  and  $d$  are two vectors of  $\mathbb{F}_q^{2n}$ . Then*

$$\langle c | d \rangle_s = \langle \phi(c) | \phi(d) \rangle_a.$$

*In particular,  $c$  and  $d$  are orthogonal with respect to the trace-symplectic form if and only if  $\phi(c)$  and  $\phi(d)$  are orthogonal with respect to the trace-alternating form.*

*Proof.* Let  $c = (\mathbf{a} | \mathbf{b})$  and  $d = (\mathbf{a}' | \mathbf{b}')$ . We calculate

$$\phi(c) \cdot \phi(d)^q = \beta^{q+1} \mathbf{a} \cdot \mathbf{a}' + \beta^2 \mathbf{a} \cdot \mathbf{b}' + \beta^{2q} \mathbf{b} \cdot \mathbf{a}' + \beta^{q+1} \mathbf{b} \cdot \mathbf{b}',$$

$$\phi(c)^q \cdot \phi(d) = \beta^{q+1} \mathbf{a} \cdot \mathbf{a}' + \beta^{2q} \mathbf{a} \cdot \mathbf{b}' + \beta^2 \mathbf{b} \cdot \mathbf{a}' + \beta^{q+1} \mathbf{b} \cdot \mathbf{b}'.$$

Therefore, the trace-alternating form of  $\phi(c)$  and  $\phi(d)$  is given by

$$\begin{aligned}\langle \phi(c) | \phi(d) \rangle_a &= \text{tr}_{q/p} \left( \frac{\phi(c) \cdot \phi(d)^q - \phi(c)^q \cdot \phi(d)}{\beta^{2q} - \beta^2} \right), \\ &= \text{tr}_{q/p}(\mathbf{b} \cdot \mathbf{a}' - \mathbf{a} \cdot \mathbf{b}'),\end{aligned}$$

which is precisely the trace-symplectic form  $\langle c | d \rangle_s$ .  $\square$

**Theorem III.15.** *An  $((n, K, d))_q$  stabilizer code exists if and only if there exists an additive subcode  $D$  of  $\mathbb{F}_{q^2}^n$  of cardinality  $|D| = q^n/K$  such that  $D \leq D^{\perp_a}$  and  $\text{wt}(D^{\perp_a} \setminus D) = d$  if  $K > 1$  (and  $\text{wt}(D^{\perp_a}) = d$  if  $K = 1$ ).*

*Proof.* Theorem III.13 shows that an  $((n, K, d))_q$  stabilizer code exists if and only if there exists a code  $C \leq \mathbb{F}_q^{2n}$  with  $|C| = q^n/K$ ,  $C \leq C^{\perp_s}$ , and  $\text{swt}(C^{\perp_s} \setminus C) = d$  if  $K > 1$  (and  $\text{swt}(C^{\perp_s}) = d$  if  $K = 1$ ). We obtain the statement of the theorem by applying the isometry  $\phi$ .  $\square$

We obtain the following convenient condition for the existence of a stabilizer code as a direct consequence of the previous theorem.

**Corollary III.16.** *If there exists a classical  $[n, k]_{q^2}$  additive code  $D \leq \mathbb{F}_{q^2}^n$  such that  $D \leq D^{\perp_a}$  and  $d^{\perp_a} = \text{wt}(D^{\perp_a})$ , then there exists an  $[[n, n - 2k, \geq d^{\perp_a}]]_q$  stabilizer code that is pure to  $d^{\perp_a}$ .*

*Remark.* It is not necessary to use a normal basis in the definition of the isometry  $\phi$  and the trace-alternating form. Alternatively, we could have used a polynomial basis  $(1, \gamma)$  of  $\mathbb{F}_q^2/\mathbb{F}_q$ . In that case, one can define the isometry  $\phi$  by  $\phi((\mathbf{a}|\mathbf{b})) = \mathbf{a} + \gamma\mathbf{b}$ , and a compatible trace-alternating form by

$$\langle v | w \rangle_{a'} = \text{tr}_{q/p} \left( \frac{v \cdot w^q - v^q \cdot w}{\gamma - \gamma^q} \right).$$

One can check that the statement of Lemma III.14 is satisfied for this choice as well. Other variations on this theme are possible.

### 3. Classical Codes

Self-orthogonal codes with respect to the trace-alternating form are not often studied in classical coding theory; more common are codes which are self-orthogonal with respect to a euclidean or hermitian inner product. We relate these concepts of orthogonality as follows. Consider the hermitian inner product  $\mathbf{x}^q \cdot \mathbf{y}$  of two vectors  $\mathbf{x}$  and  $\mathbf{y}$  in  $\mathbb{F}_{q^2}^n$ ; we write  $\mathbf{x} \perp_h \mathbf{y}$  if and only if  $\mathbf{x}^q \cdot \mathbf{y} = 0$  holds.

**Lemma III.17.** *If two vectors  $\mathbf{x}$  and  $\mathbf{y}$  in  $\mathbb{F}_{q^2}^n$  satisfy  $\mathbf{x} \perp_h \mathbf{y}$ , then they satisfy  $\mathbf{x} \perp_a \mathbf{y}$ . In particular, if  $D \leq \mathbb{F}_{q^2}^n$ , then  $D^{\perp_h} \leq D^{\perp_a}$ .*

*Proof.* It follows from  $\mathbf{x}^q \cdot \mathbf{y} = 0$  that  $\mathbf{x} \cdot \mathbf{y}^q = 0$  holds, whence

$$\langle \mathbf{x} | \mathbf{y} \rangle_a = \text{tr}_{q/p} \left( \frac{\mathbf{x} \cdot \mathbf{y}^q - \mathbf{x}^q \cdot \mathbf{y}}{\beta^{2q} - \beta^2} \right) = 0,$$

as claimed. □

Therefore, any self-orthogonal code with respect to the hermitian inner product is self-orthogonal with respect to the trace-alternating form. In general, the two dual spaces  $D^{\perp_h}$  and  $D^{\perp_a}$  are not the same. However, if  $D$  happens to be  $\mathbb{F}_{q^2}$ -linear, then the two dual spaces coincide.

**Lemma III.18.** *Suppose that  $D \leq \mathbb{F}_{q^2}^n$  is  $\mathbb{F}_{q^2}$ -linear, then  $D^{\perp_h} = D^{\perp_a}$ .*

*Proof.* Let  $q = p^m$ ,  $p$  prime. If  $D$  is a  $k$ -dimensional subspace of  $\mathbb{F}_{q^2}^n$ , then  $D^{\perp_h}$  is an  $(n - k)$ -dimensional subspace of  $\mathbb{F}_{q^2}^n$ . We can also view  $D$  as a  $2mk$ -dimensional subspace of  $\mathbb{F}_p^{2mn}$ , and  $D^{\perp_a}$  as a  $2m(n - k)$ -dimensional subspace of  $\mathbb{F}_p^{2mn}$ . Since  $D^{\perp_h} \subseteq D^{\perp_a}$  and the cardinalities of  $D^{\perp_a}$  and  $D^{\perp_h}$  are the same, we can conclude that  $D^{\perp_a} = D^{\perp_h}$ . □

**Corollary III.19** (Hermitian Construction). *If there exists an  $\mathbb{F}_{q^2}$ -linear  $[n, k, d]_{q^2}$  code  $B$  such that  $B^{\perp_h} \leq B$ , then there exists an  $[[n, 2k - n, \geq d]]_q$  quantum code that is pure to  $d$ .*

*Proof.* The hermitian inner product is nondegenerate, so the hermitian dual of the code  $D := B^{\perp h}$  is  $B$ . The  $[n, n - k]_{q^2}$  code  $D$  is  $\mathbb{F}_{q^2}$ -linear, so  $D^{\perp h} = D^{\perp a}$  by Lemma III.18, and the claim follows from Corollary III.16.  $\square$

So it suffices to consider hermitian forms in the case of  $\mathbb{F}_{q^2}$ -linear codes. We have to use the slightly more cumbersome trace-alternating form in the case of additive codes that are not linear over  $\mathbb{F}_{q^2}$ .

An elegant and surprisingly simple construction of quantum codes was introduced in 1996 by Calderbank and Shor [36] and by Steane [145]. The CSS code construction provides perhaps the most direct link to classical coding theory.

**Lemma III.20** (CSS Code Construction). *Let  $C_1$  and  $C_2$  denote two classical linear codes with parameters  $[n, k_1, d_1]_q$  and  $[n, k_2, d_2]_q$  such that  $C_2^\perp \leq C_1$ . Then there exists a  $[[n, k_1 + k_2 - n, d]]_q$  stabilizer code with minimum distance  $d = \min\{\text{wt}(c) \mid c \in (C_1 \setminus C_2^\perp) \cup (C_2 \setminus C_1^\perp)\}$  that is pure to  $\min\{d_1, d_2\}$ .*

*Proof.* Let  $C = C_1^\perp \times C_2^\perp \leq \mathbb{F}_q^{2n}$ . If  $(c_1 \mid c_2)$  and  $(c'_1 \mid c'_2)$  are two elements of  $C$ , then we observe that

$$\text{tr}(c_2 \cdot c'_1 - c'_2 \cdot c_1) = \text{tr}(0 - 0) = 0.$$

Therefore,  $C \leq C^{\perp s}$ . Furthermore, the trace-symplectic dual of  $C$  contains  $C_2 \times C_1$ , and a dimensionality argument shows that  $C^{\perp s} = C_2 \times C_1$ . Since the cartesian product  $C_1^\perp \times C_2^\perp$  has  $q^{2n - (k_1 + k_2)}$  elements, the stabilizer code has dimension  $q^{k_1 + k_2 - n}$  by Theorem III.13. The claim about the minimum distance and purity of the code is obvious from the construction.  $\square$

**Corollary III.21** (Euclidean Construction). *If  $C$  is a classical linear  $[n, k, d]_q$  code containing its dual,  $C^\perp \leq C$ , then there exists an  $[[n, 2k - n, \geq d]]_q$  stabilizer code that is pure to  $d$ .*

#### D. Weight Enumerators

The Shor-Laflamme weight enumerators of an arbitrary  $((n, K))_q$  quantum code  $Q$  with orthogonal projector  $P$  are defined by the polynomials

$$\sum_{i=0}^n A_i^{\text{SL}} z^i, \quad \text{with} \quad A_i^{\text{SL}} = \frac{1}{K^2} \sum_{\substack{E \in G_n \\ \text{wt}(E)=i}} \text{Tr}(E^\dagger P) \text{Tr}(EP),$$

and

$$\sum_{i=0}^n B_i^{\text{SL}} z^i, \quad \text{with} \quad B_i^{\text{SL}} = \frac{1}{K} \sum_{\substack{E \in G_n \\ \text{wt}(E)=i}} \text{Tr}(E^\dagger PEP),$$

see [141] for the binary case. The definition given here differs from the original definition by Shor and Laflamme by a normalization factor  $p$ , which is due to the sums running over the full error group  $G_n$ . The theory of Shor-Laflamme weight enumerators [141] was considerably extended by Rains in [124, 125, 128, 129]. In this section we give a simple proof for the relation between these weight enumerators and the symplectic weight enumerators of the additive codes associated with the stabilizer code.

The weights  $A_i^{\text{SL}}$  and  $B_i^{\text{SL}}$  have a nice combinatorial interpretation in the case of stabilizer codes. Indeed, let  $C \leq \mathbb{F}_q^{2n}$  denote the additive code associated with the stabilizer code  $Q$ . Define the symplectic weights of  $C$  and  $C^{\perp_s}$  respectively by  $A_i = |\{c \in C \mid \text{swt}(c) = i\}|$  and  $B_i = |\{c \in C^{\perp_s} \mid \text{swt}(c) = i\}|$ . The next lemma belongs to the folklore of stabilizer codes.

**Lemma III.22.** *The Shor-Laflamme weights of an  $((n, K))_q$  stabilizer code  $Q$  are multiples of the symplectic weights of the associated additive codes  $C$  and  $C^{\perp_s}$ ; more precisely,*

$$A_i^{\text{SL}} = pA_i \quad \text{and} \quad B_i^{\text{SL}} = pB_i \quad \text{for} \quad 0 \leq i \leq n,$$

where  $p$  is the characteristic of the field  $\mathbb{F}_q$ .



*Proof.* Recall that

$$P = \frac{1}{|S|} \sum_{E \in S} S$$

for the stabilizer group  $S$  of  $Q$ . The trace  $\text{Tr}(EP)$  is nonzero if and only if  $E^\dagger$  is an element of  $SZ(G_n)$ . If  $E^\dagger \in SZ(G_n)$ , then  $\text{Tr}(E^\dagger P) \text{Tr}(EP) = (q^n/|S|)^2 = K^2$ . Therefore,  $A_i^{\text{SL}}$  counts the elements in  $SZ(G_n)$  of weight  $i$ , so  $A_i^{\text{SL}} = |Z(G_n)| \times |\{c \in C \mid \text{swt}(c) = i\}| = pA_i$ .

If  $E$  commutes with all elements in  $S$ , then  $\text{Tr}(E^\dagger PEP) = \text{Tr}(P^2) = \text{Tr}(P) = K$ . If  $E$  does not commute with some element of  $S$ , then  $E$  is detectable; more precisely, the proof of Lemma III.11 shows that  $PEP = 0P$ , hence  $\text{Tr}(E^\dagger PEP) = 0$ . Therefore,  $B_i^{\text{SL}}$  counts the elements in  $C_{G_n}(S)$  of weight  $i$ , hence  $B_i^{\text{SL}} = |Z(G_n)| \times |\{c \in C^{\perp_s} \mid \text{swt}(c) = i\}| = pB_i$ .  $\square$

Shor and Laflamme had been aware of the stabilizer case when they introduced their weight enumerators, so the combinatorial interpretation of the weights does not appear to be a coincidence. Recall that the Shor-Laflamme enumerators of arbitrary quantum codes are related by a MacWilliams identity, see [124, 141]. For stabilizer codes, we can directly relate the symplectic weight enumerators of  $C$  and  $C^{\perp_s}$ ,

$$A(z) = \sum_{i=0}^n A_i z^i \quad \text{and} \quad B(z) = \sum_{i=0}^n B_i z^i,$$

using a simple argument that is very much in the spirit of Jessie MacWilliams' original proof for euclidean dual codes [106].

**Theorem III.23.** *Let  $C$  be an additive subcode of  $\mathbb{F}_q^{2n}$  with symplectic weight enumerator  $A(z)$ . Then the symplectic weight enumerator of  $C^{\perp_s}$  is given by*

$$B(z) = \frac{(1 + (q^2 - 1)z)^n}{|C|} A\left(\frac{1 - z}{1 + (q^2 - 1)z}\right).$$

*Proof.* Let  $\chi$  be a nontrivial additive character of  $\mathbb{F}_p$ . We define for  $b \in \mathbb{F}_q^{2n}$  a character  $\chi_b$

of the additive group  $C$  by substituting the trace-symplectic form for the argument of the character  $\chi$ , such that

$$\chi_b(c) = \chi(\langle c|b \rangle_s).$$

The character  $\chi_b$  is trivial if and only if  $b$  is an element of  $C^{\perp_s}$ . Therefore, we obtain from the orthogonality relations of characters that

$$\sum_{c \in C} \chi_b(c) = \begin{cases} |C| & \text{for } b \in C^{\perp_s}, \\ 0 & \text{otherwise.} \end{cases}$$

The following relation for polynomials is an immediate consequence

$$\sum_{c \in C} \sum_{b \in \mathbb{F}_q^{2n}} \chi_b(c) z^{\text{swt}(b)} = \sum_{b \in \mathbb{F}_q^{2n}} z^{\text{swt}(b)} \sum_{c \in C} \chi_b(c) = |C| B(z). \quad (3.9)$$

The right hand side is a multiple of the weight enumerator of the code  $C^{\perp_s}$ . Let us have a closer look at the inner sum of the left-hand side. If we express the vector  $c \in C$  in the form  $c = (c_1, \dots, c_n | d_1, \dots, d_n)$ , and expand the character and its trace-symplectic form, then we obtain

$$\begin{aligned} \sum_{b \in \mathbb{F}_q^{2n}} \chi_b(c) z^{\text{swt}(b)} &= \sum_{(a_1, \dots, a_n | b_1, \dots, b_n) \in \mathbb{F}_q^{2n}} z^{\sum_{k=1}^n \text{swt}(a_k | b_k)} \chi \left( \sum_{k=1}^n \text{tr}(d_k a_k - b_k c_k) \right) \\ &= \sum_{(a_1, \dots, a_n | b_1, \dots, b_n) \in \mathbb{F}_q^{2n}} \prod_{k=1}^n z^{\text{swt}(a_k | b_k)} \chi(\text{tr}(d_k a_k - b_k c_k)) \\ &= \prod_{k=1}^n \sum_{(a_k | b_k) \in \mathbb{F}_q^2} z^{\text{swt}(a_k | b_k)} \chi(\text{tr}(d_k a_k - b_k c_k)). \end{aligned}$$

Recall that  $\chi$  is a nontrivial character of  $\mathbb{F}_p$ , hence the map  $(a_k | b_k) \mapsto \chi(\text{tr}(d_k a_k - b_k c_k))$  is a nontrivial character of  $\mathbb{F}_q^2$  for all  $(c_k | d_k) \neq (0|0)$ . Therefore, we can simplify the inner

sum to

$$\sum_{(a_k|b_k) \in \mathbb{F}_q^{2n}} z^{\text{swt}(a_k|b_k)} \chi(\text{tr}(d_k a_k - b_k c_k)) = \begin{cases} 1 + (q^2 - 1)z & \text{if } (c_k|d_k) = (0, 0), \\ 1 - z & \text{if } (c_k|d_k) \neq (0, 0). \end{cases}$$

It follows that

$$\sum_{b \in \mathbb{F}_q^{2n}} \chi_b(c) z^{\text{swt}(b)} = (1 - z)^{\text{swt}(c)} (1 + (q^2 - 1)z)^{n - \text{swt}(c)}.$$

Substituting this expression into equation (3.9), we find that

$$\begin{aligned} B(z) &= |C|^{-1} \sum_{c \in C} \sum_{b \in \mathbb{F}_q^{2n}} \chi_b(c) z^{\text{swt}(b)} \\ &= \frac{(1 + (q^2 - 1)z)^n}{|C|} \sum_{c \in C} \left( \frac{1 - z}{1 + (q^2 - 1)z} \right)^{\text{swt}(c)} \\ &= \frac{(1 + (q^2 - 1)z)^n}{|C|} A \left( \frac{1 - z}{1 + (q^2 - 1)z} \right), \end{aligned}$$

which proves the claim.  $\square$

The coefficient of  $z^j$  in  $(1 + (q^2 - 1)z)^{n-x} (1 - z)^x$  is given by the Krawtchouk polynomial of degree  $j$  in the variable  $x$ ,

$$K_j(x) = \sum_{s=0}^j (-1)^s (q^2 - 1)^{j-s} \binom{x}{s} \binom{n-x}{j-s}.$$

**Corollary III.24.** *Keeping the notation of the previous theorem, we have*

$$B_j = \frac{1}{|C|} \sum_{x=0}^n K_j(x) A_x.$$

*Proof.* According to the previous theorem, we have

$$\begin{aligned} B(z) &= \frac{(1 + (q^2 - 1)z)^n}{|C|} A \left( \frac{1 - z}{1 + (q^2 - 1)z} \right) \\ &= \frac{1}{|C|} \sum_{x=0}^n A_x (1 - z)^x (1 + (q^2 - 1)z)^{n-x}. \end{aligned}$$

We obtain the result by comparing the coefficients of  $z^j$  on both sides.  $\square$

The weight enumerators turn out to be very useful in establishing the bounds on quantum codes, as we will see in the next section.

## E. Bounds

We need some bounds on the achievable minimum distance of a quantum stabilizer code. The main results in this section are the generalization of the linear programming bounds [35], alternative proofs for the nonbinary quantum Singleton bound using a generalization of the methods given in [12], a proof of the validity of the quantum Hamming bound for single error-correcting (degenerate) quantum codes (which generalizes an earlier result by Gottesman [61, Chapter 7]), a simpler nonconstructive proof for lower bounds on quantum codes, and an existence proof of a class of optimal quantum codes.

### 1. Upper Bounds

We shall derive a series of upper bounds for nonbinary stabilizer codes. The first theorem yields a bound that is well-suited for computer search.

**Theorem III.25.** *If an  $((n, K, d))_q$  stabilizer code with  $K > 1$  exists, then there exists a solution to the optimization problem: minimize  $\sum_{j=1}^{d-1} A_j$  subject to the constraints*

1.  $A_0 = 1$  and  $A_j \geq 0$  for all  $1 \leq j \leq n$ ;
2.  $\sum_{j=0}^n A_j = q^n / K$ ;
3.  $B_j = \frac{K}{q^n} \sum_{r=0}^n K_j(r) A_r$  holds for all  $j$  in the range  $0 \leq j \leq n$ ;
4.  $A_j = B_j$  for all  $j$  in  $0 \leq j < d$  and  $A_j \leq B_j$  for all  $d \leq j \leq n$ ;
5.  $(p - 1)$  divides  $A_j$  for all  $j$  in the range  $1 \leq j \leq n$ .

*Proof.* If an  $((n, K, d))_q$  stabilizer code exists, then the symplectic weight distribution of the associated additive code  $C$  satisfies conditions 1) and 2). For each nonzero codeword  $c$  in  $C$ ,  $\alpha c$  is again in  $C$  for all  $\alpha$  in  $\mathbb{F}_p^*$ , so 5) holds. Corollary III.24 shows that 3) holds. Since the quantum code has minimum distance  $d$ , it follows that 4) holds.  $\square$

**Remark III.26.** *If we are interested in bounds for  $\mathbb{F}_{q^2}$  linear codes, then we can replace condition 5) in the previous theorem by  $q^2 - 1$  divides  $A_j$  for  $1 \leq j \leq n$ . This will even help in characteristic 2.*

The next bound is more convenient when one wants to find bounds by hand. In particular, any function  $f$  satisfying the constraints of the next theorem will yield a useful bound on the dimension of a stabilizer code. This approach was introduced by Delsarte for classical codes [47]. Binary versions of Theorem III.27 and Corollary III.28 were proved by Ashikhmin and Litsyn [12], see also [15].

**Theorem III.27.** *Let  $Q$  be an  $((n, K, d))_q$  stabilizer code of dimension  $K > 1$ . Suppose that  $S$  is a nonempty subset of  $\{0, \dots, d-1\}$  and  $N = \{0, \dots, n\}$ . Let*

$$f(x) = \sum_{i=0}^n f_i K_i(x)$$

*be a polynomial satisfying the conditions*

- i)  $f_x > 0$  for all  $x$  in  $S$ , and  $f_x \geq 0$  otherwise;*
- ii)  $f(x) \leq 0$  for all  $x$  in  $N \setminus S$ .*

*Then*

$$K \leq \frac{1}{q^n} \max_{x \in S} \frac{f(x)}{f_x}.$$

*Proof.* Suppose that  $C \leq \mathbb{F}_q^{2n}$  is the additive code associated with the stabilizer code  $Q$ . If we apply Corollary III.24 to the trace-symplectic dual code  $C^{\perp_s}$  of the code  $C$ , then we

obtain

$$A_i = \frac{1}{|C^{\perp_s}|} \sum_{x=0}^n K_i(x) B_x.$$

Using this relation, we find that

$$\begin{aligned} |C^{\perp_s}| \sum_{i \in S} f_i A_i &\leq |C^{\perp_s}| \sum_{i=0}^n f_i A_i \\ &= |C^{\perp_s}| \sum_{i=0}^n f_i \left( \frac{1}{|C^{\perp_s}|} \sum_{x=0}^n K_i(x) B_x \right) \\ &= \sum_{x=0}^n B_x \sum_{i=0}^n f_i K_i(x). \end{aligned}$$

By assumption,  $f(x) = \sum_{i=0}^n f_i K_i(x)$ ; thus, we can simplify the latter inequality and obtain

$$|C^{\perp_s}| \sum_{i \in S} f_i A_i \leq \sum_{x=0}^n B_x f(x) \leq \sum_{x \in S} B_x f(x) = \sum_{x \in S} A_x f(x),$$

where the last equality follows from the fact that the stabilizer code has minimum distance  $d$ , meaning that  $A_x = B_x$  holds for all  $x$  in the range  $0 \leq x < d$ . We can conclude that

$$|C^{\perp_s}| \leq \left( \sum_{x \in S} A_x f(x) \right) / \left( \sum_{x \in S} f_x A_x \right) \leq \max_{x \in S} \frac{f(x)}{f_x},$$

which proves the theorem, since  $|C^{\perp_s}| = q^n K$ .  $\square$

The previous theorem implies the quantum Singleton bound. In general, linear programming yields better bounds, but for short lengths one can actually find codes meeting the quantum Singleton bound.

**Corollary III.28** (Quantum Singleton Bound). *An  $((n, K, d))_q$  stabilizer code with  $K > 1$  satisfies*

$$K \leq q^{n-2d+2}.$$

The binary version of the quantum Singleton bound was first proved by Knill and Laflamme in [95], see also [12, 15], and later generalized by Rains using weight enumera-

tors in [126].

A more interesting application of Theorem III.27 is to derive the quantum Hamming bound. The quantum Hamming bound states that any pure  $((n, K, d))_q$  stabilizer code satisfies

$$\sum_{i=0}^{\lfloor (d-1)/2 \rfloor} \binom{n}{i} (q^2 - 1)^i \leq q^n / K, \quad (3.10)$$

see [55, 59]. Several researchers have tried to find impure stabilizer codes that beat the quantum Hamming bound. However, Gottesman has shown that impure single and double error-correcting binary quantum codes cannot beat the quantum Hamming bound [61]. In the same vein, Theorem III.27 allows us to derive the Hamming bound for arbitrary stabilizer codes, at least when the minimum distance is small. We illustrate the method for single error-correcting codes, and note that the same approach works for double error-correcting codes as well.

**Corollary III.29** (Quantum Hamming Bound). *An  $((n, K, 3))_q$  stabilizer code with  $K > 1$  satisfies*

$$K \leq q^n / (n(q^2 - 1) + 1).$$

*Proof.* Recall that the intersection number  $p_{ij}^k$  of the Hamming association scheme  $H(n, q^2)$  is the integer  $p_{ij}^k = |\{z \in \mathbb{F}_q^n \mid d(x, z) = i, d(y, z) = j\}|$ , where  $x$  and  $y$  are two vectors in  $\mathbb{F}_q^n$  of Hamming distance  $d(x, y) = k$ . The intersection numbers are related to Krawtchouk polynomials by the expression

$$p_{ij}^k = q^{-2n} \sum_{u=0}^n K_i^n(u) K_j^n(u) K_u^n(k),$$

see [20].

After this preparation, we can proceed to derive the Hamming bound as a consequence

of Theorem III.27. Let

$$\begin{aligned} f(x) &= \sum_{j,k=0}^1 \sum_{i=0}^n K_j^n(i) K_k^n(i) K_i^n(x), \\ &= q^{2n} (p_{00}^x + p_{10}^x + p_{01}^x + p_{11}^x). \end{aligned}$$

The triangle inequality implies that  $p_{ij}^k = 0$  if one of the three arguments exceeds the sum of the other two; hence,  $f(x) = 0$  for  $x > 2$ . The coefficients of the Krawtchouk expansion  $f(x) = \sum_{i=0}^n f_i K_i(x)$  obviously satisfy  $f_i = (K_0(i) + K_1(i))^2 \geq 0$ . A straightforward calculation gives

$$\begin{aligned} f(0) &= q^{2n} (n(q^2 - 1) + 1), & f_0 &= (n(q^2 - 1) + 1)^2, \\ f(1) &= q^{2n+2}, & f_1 &= ((n - 1)(q^2 - 1))^2, \\ f(2) &= 2q^{2n}, & f_2 &= ((n - 2)(q^2 - 1) - 1)^2. \end{aligned}$$

It follows that

$$\max\{f(0)/f_0, f(1)/f_1, f(2)/f_2\} \leq q^{2n} / (n(q^2 - 1) + 1)$$

holds for all  $n \geq 5$ . Using Theorem III.27, we obtain the claim for all  $n \geq 5$ . For the lengths  $n < 5$ , we obtain the claim from the quantum Singleton bound.  $\square$

One real disadvantage of Theorem III.27 is that the number of terms increase with the minimum distance and this can lead to cumbersome calculations. However, one can derive more consequences from Theorem III.27; see, for instance, [12, 15, 101, 110].

## 2. Lower Bounds

Feng and Ma have recently shown a quantum version of the classical lower bounds by Gilbert and Varshamov [55]. We conclude this section by giving a simple proof for a weaker version of this result based on a counting argument. It must be remembered that



these lower bounds are nonconstructive.

Our first lemma generalizes an idea used by Gottesman in his proof of the binary case.

**Lemma III.30.** *An  $((n, K, \geq d))_q$  stabilizer code with  $K > 1$  exists provided that*

$$(q^n K - q^n / K) \sum_{j=1}^{d-1} \binom{n}{j} (q^2 - 1)^j < (q^{2n} - 1)(p - 1) \quad (3.11)$$

*holds.*

*Proof.* Let  $L$  denote the multiset

$$L = \{C^{\perp_s} \setminus C \mid C \leq C^{\perp_s} \leq \mathbb{F}_q^{2n} \text{ with } |C| = q^n / K\}.$$

The elements of this multiset correspond to stabilizer codes of dimension  $K$ . Note that  $L$  is nonempty, since there exists a code  $C$  of size  $q^n / K$  that is generated by elements of the form  $(a|0)$ ; the form of the generators ensures that  $C \leq C^{\perp_s}$ .

All nonzero vectors in  $\mathbb{F}_q^{2n}$  appear in the same number of sets in  $L$ . Indeed, the symplectic group  $\text{Sp}(2n, \mathbb{F}_q)$  acts transitively on the set  $\mathbb{F}_q^{2n} \setminus \{0\}$ , see [74, Proposition 3.2], which means that for any nonzero vectors  $u$  and  $v$  in  $\mathbb{F}_q^{2n}$  there exists  $\tau \in \text{Sp}(2n, \mathbb{F}_q)$  such that  $v = \tau u$ . Therefore,  $u$  is contained in  $C^{\perp_s} \setminus C$  if and only if  $v$  is contained in the element  $(\tau C)^{\perp_s} \setminus \tau C$  of  $L$ .

The transitivity argument shows that any nonzero vector in  $\mathbb{F}_q^{2n}$  occurs in  $|L|(q^n K - q^n / K) / (q^{2n} - 1)$  elements of  $L$ . Furthermore, a nonzero vector and its  $\mathbb{F}_p^\times$ -multiples are contained in the exact same sets of  $L$ . Thus, if we delete all sets from  $L$  that contain a nonzero vector with symplectic weight less than  $d$ , then we remove at most

$$\frac{\sum_{j=1}^{d-1} \binom{n}{j} (q^2 - 1)^j}{p - 1} |L| \frac{(q^n K - q^n / K)}{q^{2n} - 1}$$

sets from  $L$ . By assumption, this number is less than  $|L|$ ; hence, there exists an  $((n, K, \geq d))_q$  stabilizer code.  $\square$

The Gilbert-Varshamov bound shows the existence of surprisingly good codes, even for smaller lengths, when the characteristic of the field is not too small. If  $n \equiv k \pmod{2}$ , then we can significantly strengthen the bound.

**Lemma III.31.** *If  $k \geq 1$ ,  $n \equiv k \pmod{2}$  and*

$$(q^{n+k} - q^{n-k}) \sum_{j=1}^{d-1} \binom{n}{j} (q^2 - 1)^{j-1} < (q^{2n} - 1) \quad (3.12)$$

*holds, then there exists an  $\mathbb{F}_{q^2}$ -linear  $[[n, k, d]]_q$  stabilizer code.*

*Proof.* The proof is almost the same as in the previous lemma, except that we list only codes  $C$  such that  $\phi(C)$  is linear, meaning that  $\phi(C)$  is a vector space over  $\mathbb{F}_{q^2}$ . We repeat the previous argument with the multiset

$$L = \left\{ C^{\perp_s} \setminus C \mid \begin{array}{l} C \leq C^{\perp_s} \leq F_q^{2n}, |C| = q^{n-k}, \\ \phi(C) \text{ is } \mathbb{F}_{q^2}\text{-linear} \end{array} \right\}.$$

It is easy to see that  $L$  is not empty. Note that each set  $\phi(C^{\perp_s}) \setminus \phi(C)$  in  $L$  contains now all  $\mathbb{F}_{q^2}^\times$ -multiples of a nonzero vector, not just the  $\mathbb{F}_p^\times$ -multiples, which proves the statement.  $\square$

Feng and Ma show that one can extend the previous result to even prove the existence of pure stabilizer codes, but much more delicate counting arguments are needed in that case, see [55]. We are not aware of short proofs for this stronger result.

The previous lemma allows us to show the existence of good quantum codes, especially for larger alphabets. We illustrate this fact by proving the existence of MDS stabilizer codes, see Section C for more details on such codes.

**Corollary III.32.** *If  $2 \leq d \leq \lceil n/2 \rceil$  and  $q^2 - 1 \geq \binom{n}{d}$ , then there exists a linear  $[[n, n - 2d + 2, d]]_q$  stabilizer code.*

*Proof.* The assumption  $d \leq \lceil n/2 \rceil$  implies that  $\binom{n}{1} \leq \binom{n}{2} \leq \dots \leq \binom{n}{d}$ , so the maximum value of these binomial coefficients is at most  $q^2 - 1$ . Let  $k = n - 2d + 2$ . It follows from the assumption that  $k \geq 1$  and  $n \equiv k \pmod{2}$ . It remains to show that (3.12) holds. For the choice  $k = n - 2d + 2$ , the left hand side of (3.12) equals

$$\begin{aligned} & (q^{2n-2d+2} - q^{2d-2}) \sum_{j=1}^{d-1} \binom{n}{j} (q^2 - 1)^{j-1} \\ & \leq (q^{2n-2d+2} - q^{2d-2}) \sum_{j=1}^{d-1} (q^2 - 1)^j \\ & = (q^{2n-2d+2} - q^{2d-2}) \frac{(q^2 - 1)^d - (q^2 - 1)}{q^2 - 2}. \end{aligned}$$

We claim that the latter term is less than  $q^{2n} - 1$ . To prove this, it suffices to show that

$$q^{2n-2d+2} \frac{(q^2 - 1)^d - (q^2 - 1)}{q^2 - 2} \leq q^{2n} \quad (3.13)$$

holds. The latter inequality is equivalent to  $(q^2 - 1)^d \leq q^{2d} - 2q^{2d-2} + q^2 - 1$ , and it is not hard to see that this inequality holds. Indeed, note that

$$q^{2d} = ((q^2 - 1) + 1)^d = (q^2 - 1)^d + \sum_{j=0}^{d-1} \binom{d}{j} (q^2 - 1)^j.$$

Recall that  $\binom{d}{j} = \binom{d-1}{j-1} + \binom{d-1}{j}$ ; hence,

$$\begin{aligned} & q^{2d} - 2q^{2d-2} - (q^2 - 1)^d \\ & = \sum_{j=0}^{d-1} \left( \binom{d}{j} - 2\binom{d-1}{j} \right) (q^2 - 1)^j, \\ & = \sum_{j=0}^{d-1} \underbrace{\left( \binom{d-1}{j-1} - \binom{d-1}{j} \right)}_{\alpha(j)} (q^2 - 1)^j. \end{aligned}$$

We have  $\alpha(j) = -\alpha(d-j)$  for  $0 \leq j \leq d-1$ , and  $\alpha(j) \geq 0$  for  $j \geq d/2$ . This shows that all negative terms get canceled by larger positive terms and we can conclude

that  $q^{2d} - 2q^{2d-2} - (q^2 - 1)^d \geq 0$  for  $d \geq 2$ ; this implies inequality (3.13) and consequently shows that (3.12) holds.  $\square$

**Example III.33.** Recall that there does not exist a  $[[7, 1, 4]]_2$  code, see [35]. In contrast, the existence of a  $[[7, 1, 4]]_q$  code for all prime powers  $q \geq 7$  is guaranteed by the preceding corollary. It also shows that there exist  $[[6, 2, 3]]_q$  for all prime powers  $q \geq 5$  and  $[[7, 3, 3]]_q$  for all prime powers  $q \geq 7$ , which slightly generalizes [53].

## F. Code Constructions

Constructing good quantum codes is a difficult task. We need a quantum code for each parameter  $n$  and  $k$  in our tables. In this section we collect some simple facts about the construction of codes. Lemmas III.34–III.36, (see also Table I), show how to lengthen, shorten or reduce the dimension of the stabilizer code. These generalize and extend the constructions for binary quantum codes [35, Theorem 6].

Table I. The existence of a pure  $[[n, k, d]]_q$  stabilizer code implies the existence of codes with other parameters.

n/k	$k - 1$	$k$	$k + 1$
$n - 1$	$\geq d - 1$ pure Lemma III.36	$\geq d - 1$ pure Lemma III.36	$d - 1$ pure Lemma III.35
$n$	$\geq d$ pure Lemma III.36	$d$ pure	$d - 1$ impure Lemma III.34
$n + 1$	$\geq d$ impure Lemma III.34	$d$ impure Lemma III.34	

**Lemma III.34.** If an  $[[n, k, d]]_q$  stabilizer code exists for  $k > 0$ , then there exists an impure  $[[n + 1, k, d]]_q$  stabilizer code.

*Proof.* If an  $[[n, k, d]]_q$  stabilizer code exists, then there exists an additive subcode  $C \leq \mathbb{F}_q^{2n}$  such that  $|C| = q^{n-k}$ ,  $C \leq C^{\perp_s}$ , and  $\text{swt}(C^{\perp_s} \setminus C) = d$ . Define the additive code

$$C' = \{(a\alpha|b0) \mid \alpha \in \mathbb{F}_q, (a|b) \in C\}.$$

We have  $|C'| = q^{n-k+1}$ . The definition ensures that  $C'$  is self-orthogonal with respect to the trace-symplectic inner product. Indeed, two arbitrary elements  $(a\alpha|b0)$  and  $(a'\alpha'|b'0)$  of  $C'$  satisfy the orthogonality condition

$$\langle (a\alpha|b0)|(a'\alpha'|b'0) \rangle_s = \langle (a|b)|(a'|b') \rangle_s + \text{tr}(\alpha \cdot 0 - \alpha' \cdot 0) = 0.$$

A vector in the trace-symplectic dual of  $C'$  has to be of the form  $(a\alpha|b0)$  with  $(a|b) \in C^{\perp_s}$  and  $\alpha \in \mathbb{F}_q$ . Furthermore,

$$\text{swt}(C'^{\perp_s} \setminus C') = \min\{\text{swt}(a\alpha|b0) \mid \alpha \in \mathbb{F}_q, a, b \in C^{\perp_s} \setminus C\},$$

which coincides with  $\text{swt}(C^{\perp_s} \setminus C)$ . Therefore, an  $[[n+1, k, d]]_q$  stabilizer code exists by Theorem III.13. If  $d > 1$ , then the code is impure, because  $C'^{\perp_s}$  contains the vector  $(0\alpha|00)$  of symplectic weight 1.  $\square$

**Lemma III.35.** *If a pure  $[[n, k, d]]_q$  stabilizer code exists with  $n \geq 2$  and  $d \geq 2$ , then there exists a pure  $[[n-1, k+1, d-1]]_q$  stabilizer code.*

*Proof.* If a pure  $[[n, k, d]]_q$  stabilizer code exists, then there exists an additive code  $D \leq \mathbb{F}_{q^2}^n$  that is self-orthogonal with respect to the trace-alternating form, so that  $|D| = q^{n-k}$  and  $\text{wt}(D^{\perp_a}) = d$ . Let  $D_0^{\perp_a}$  denote the code obtained by puncturing the first coordinate of  $D^{\perp_a}$ . Since the minimum distance of  $D^{\perp_a}$  is at least 2, we know that  $|D_0^{\perp_a}| = |D^{\perp_a}| = q^{n+k}$ , and we note that the minimum distance of  $D_0^{\perp_a}$  is  $d-1$ . The dual of  $D_0^{\perp_a}$  consists of all vectors  $u$  in  $\mathbb{F}_{q^2}^{n-1}$  such that  $0u$  is contained in  $D$ . Furthermore, if  $u$  is an element of  $D_0$ , then  $0u$  is contained in  $D$ ; hence,  $D_0$  is a self-orthogonal additive code. The code  $D_0$  is of

size  $q^{(n-1)-(k+1)}$ , because

$$\dim D_0 + \dim D_0^{\perp a} = \dim \mathbb{F}_{q^2}^{n-1}$$

when we view  $D_0$  and its dual as  $\mathbb{F}_p$ -vector spaces. It follows that there exists a pure  $[[n-1, k+1, d-1]]_q$  stabilizer code.  $\square$

**Lemma III.36.** *If a (pure)  $[[n, k, d]]_q$  stabilizer code exists, with  $k \geq 2$  ( $k \geq 1$ ), then there exists an  $[[n, k-1, d^*]]_q$  stabilizer code (pure to  $d$ ) such that  $d^* \geq d$ .*

*Proof.* If an  $[[n, k, d]]_q$  stabilizer code exists, then there exists an additive code  $D \leq \mathbb{F}_{q^2}^n$  such that  $D \leq D^{\perp a}$  with  $\text{wt}(D^{\perp a} \setminus D) = d$  and  $|D| = q^{n-k}$ . Choose an additive code  $D_b$  of size  $|D_b| = q^{n-k+1}$  such that  $D \leq D_b \leq D_b^{\perp a} \leq D^{\perp a}$ . Since  $D \leq D_b$ , we have  $D_b^{\perp a} \leq D^{\perp a}$ . The set  $\Sigma_b = D_b^{\perp a} \setminus D_b$  is a subset of  $D^{\perp a} \setminus D$ , hence the minimum weight  $d^*$  of  $\Sigma_b$  is at least  $d$ . This proves the existence of an  $[[n, k-1, d^*]]_q$  code.

If the code is pure, then  $\text{wt}(D^{\perp a}) = d$ ; it follows from  $D_b^{\perp a} \leq D^{\perp a}$  that  $\text{wt}(D_b^{\perp a}) \geq d$ , so the smaller code is pure as well.  $\square$

**Corollary III.37.** *If a pure  $[[n, k, d]]_q$  stabilizer code with  $n \geq 2$  and  $d \geq 2$  exists, then there exists a pure  $[[n-1, k, \geq d-1]]_q$  stabilizer code.*

*Proof.* Combine Lemmas III.35 and III.36.  $\square$

**Lemma III.38.** *Suppose that an  $((n, K, d))_q$  and an  $((n', K', d'))_q$  stabilizer code exist. Then there exists an  $((n+n', KK', \min(d, d'))_q$  stabilizer code.*

*Proof.* Suppose that  $P$  and  $P'$  are the orthogonal projectors onto the stabilizer codes for the  $((n, K, d))_q$  and  $((n', K', d'))_q$  stabilizer codes, respectively. Then  $P \otimes P'$  is an orthogonal projector onto a  $KK'$ -dimensional subspace  $Q^*$  of  $\mathbb{C}^d$ , where  $d = q^{n+n'}$ . Let  $S$  and  $S'$  respectively denote the stabilizer groups of the images of  $P$  and  $P'$ . Then  $S^* = \{E \otimes E' \mid E \in S, E' \in S'\}$  is the stabilizer group of  $Q^*$ .

If an element  $F \otimes F^*$  of  $G_n \otimes G_{n'} = G_{n+n'}$  is not detectable, then  $F$  has to commute with all elements in  $S$ , and  $F'$  has to commute with all elements in  $S'$ . It is not possible that both  $F \in Z(G_n)S$  and  $F' \in Z(G_{n'})S'$  hold, because this would imply that  $F \otimes F'$  is detectable. Therefore, either  $F$  or  $F'$  is not detectable, which shows that the weight of  $F \otimes F'$  is at least  $\min(d, d')$ .  $\square$

**Lemma III.39.** *Let  $Q_1$  and  $Q_2$  be pure stabilizer codes that respectively have parameters  $[[n, k_1, d_1]]_q$  and  $[[n, k_2, d_2]]_q$ . If  $Q_2 \subseteq Q_1$ , then there exists a  $[[2n, k_1 + k_2, d]]_q$  pure stabilizer code with minimum distance  $d \geq \min\{2d_2, d_1\}$ .*

*Proof.* The hypothesis implies that there exist additive subcodes  $D_1 \leq D_2$  of  $\mathbb{F}_{q^2}^n$  such that  $D_m \leq D_m^{\perp a}$ ,  $|D_m| = q^{n-k_m}$ , and  $\text{wt}(D_m^{\perp a}) = d_m$  for  $m = 1, 2$ . The additive code

$$D = \{(u, u + v) \mid u \in D_1, v \in D_2\} \leq \mathbb{F}_{q^2}^{2n}$$

is of size  $|D| = q^{2n-(k_1+k_2)}$ . The trace-alternating dual of the code  $D$  is  $D^{\perp a} = \{(u' + v', v') \mid u' \in D_1^{\perp a}, v' \in D_2^{\perp a}\}$ . Indeed, the vectors on the right hand side are perpendicular to the vectors in  $D$ , because

$$\langle (u, u + v) \mid (u' + v', v') \rangle_a = \langle u \mid u' + v' \rangle_a + \langle u + v \mid v' \rangle_a = 0$$

holds for all  $u \in D_1, v \in D_2$  and  $u' \in D_1^{\perp a}, v' \in D_2^{\perp a}$ . We observe that  $D$  is self-orthogonal,  $D \leq D^{\perp a}$ . The weight of a vector  $(u' + v', v') \in D^{\perp a} \setminus D$  is at least  $\min\{2d_2, d_1\}$ ; the claim follows.  $\square$

**Lemma III.40.** *Let  $q$  be a power of two. If a pure  $[[n, k_1, d_1]]_q$  stabilizer code  $Q_1$  exists that has a pure subcode  $Q_2 \subseteq Q_1$  with parameters  $[[n, k_2, d_2]]_q$  such that  $k_1 > k_2$ , then a pure  $[[2n, k_1 - k_2, d]]_q$  stabilizer code exists such that  $d \geq \min\{2d_1, d_2\}$ .*

*Proof.* If an  $[[n_m, k_m, d_m]]_q$  stabilizer code exists, then there exists an additive code  $D_m \leq \mathbb{F}_{q^2}^n$  such that  $D_m \leq D_m^{\perp a}$ ,  $\text{wt}(D_m^{\perp a}) = d$ , and  $|D_m| = q^{n-k_m}$  for  $m = 1, 2$ . The inclusion

$Q_2 \subseteq Q_1$  implies that  $D_1 \leq D_2$ . Let  $D$  denote the additive code consisting of vectors of the form  $(u, u + v)$  such that  $u \in D_2^{\perp a}$  and  $v \in D_1$ .

We claim that  $D^{\perp a}$  consists of vectors of the form  $(u', u' + v')$  such that  $u' \in D_1^{\perp a}$  and  $v' \in D_2$ . Indeed, let  $v_1 = (u, u + v)$  denote a vector in  $D$ , and let  $v_2 = (u', u' + v')$  be a vector with  $u' \in D_1^{\perp a}$  and  $v' \in D_2$ . We have

$$\langle v_1 | v_2 \rangle_a = \langle u | u' \rangle_a + \langle u | u' \rangle_a + \langle u | v' \rangle_a + \langle v | u' \rangle_a + \langle v | v' \rangle_a.$$

The first two terms on the right hand side cancel because the characteristic of the field is even; the next two terms vanish since the vectors belong to dual spaces; the last term vanishes because  $v$  and  $v'$  are both contained in  $D_2$ , and  $D_2$  is self-orthogonal. Therefore,  $v_1$  and  $v_2$  are orthogonal. The set  $\{(u', u' + v') \mid u' \in D_1^{\perp a}, v' \in D_2\} \subseteq D^{\perp a}$  has cardinality  $q^{2n+k_1-k_2}$ , so it must be equal to  $D^{\perp a}$  by a dimension argument.

The Hamming weight of a vector  $(u', u' + v')$  in  $D^{\perp a}$  is at least  $\min\{2d_1, d_2\}$ , because  $u' \in D_1^{\perp a}$  and  $v' \in D_2 \leq D_2^{\perp a}$ .  $\square$

**Lemma III.41.** *Let  $q$  be a power of a prime. If an  $((n, K, d))_{q^m}$  stabilizer code exists, then an  $((nm, K, \geq d))_q$  stabilizer code exists. Conversely, if an  $((nm, K, d))_q$  stabilizer code exists, then there exists an  $((n, K, \geq \lfloor d/m \rfloor))_{q^m}$  stabilizer code.*

This lemma is implicitly contained in the paper by Ashikhmin and Knill [11].

*Proof.* Let  $B = \{\beta_1, \dots, \beta_m\}$  denote a basis of  $\mathbb{F}_{q^m}/\mathbb{F}_q$ . If  $a$  is an element of  $\mathbb{F}_{q^m}$ , then we denote by  $e_B(a)$  the coordinate vector in  $\mathbb{F}_q^m$  given by  $e_B(a) = (a_1, \dots, a_m)$ , where  $a = \sum_{i=1}^m a_i \beta_i$ .

A nondegenerate symmetric form on the  $\mathbb{F}_q$ -vector space  $\mathbb{F}_{q^m}$  is given by  $\text{tr}_{q^m/q}(xy)$ . It follows that the Gram matrix  $M = (\text{tr}_{q^m/q}(\beta_i \beta_j))_{1 \leq i, j \leq m}$  is nonsingular. We have  $\text{tr}_{q^m/q}(xy) = e_B(x)^t M e_B(y)$  for all  $x, y$  in  $\mathbb{F}_{q^m}$ . We define an  $\mathbb{F}_p$ -vector space isomor-



phism  $\varphi_B$  from  $\mathbb{F}_{q^m}^{2n}$  onto  $\mathbb{F}_q^{2nm}$  by

$$\varphi_B((a|b)) = ((e_B(a_1), \dots, e_B(a_n)) | (Me_B(b_1), \dots, Me_B(b_n))).$$

It follows from the fact that  $\text{tr}_{q^m/q}(\text{tr}_{q/p}(x)) = \text{tr}_{q^m/p}(x)$  for all  $x$  in  $\mathbb{F}_{q^m}$  and the definition of the isomorphism  $\varphi_B$  that  $(a|b) \perp_s (c|d)$  holds in  $\mathbb{F}_{q^m}^{2n}$  if and only if  $\varphi_B((a|b)) \perp_s \varphi_B((c|d))$  holds in  $\mathbb{F}_{q^{2nm}}$ .

If an  $((n, K, d))_{q^m}$  exists, then there exists an additive code  $C \leq \mathbb{F}_{q^m}^{2n}$  of size  $|C| = q^{nm}/K$  such that  $C \leq C^{\perp_s}$ ,  $\text{swt}(C^{\perp_s} \setminus C) = d$  if  $K > 1$ , and  $\text{swt}(C^{\perp_s}) = d$  if  $K = 1$ . Therefore, the code  $\varphi_B(C)$  over the alphabet  $\mathbb{F}_q$  is of size  $q^{nm}/K$ , satisfies  $\varphi_B(C) \leq \varphi_B(C)^{\perp_s} \leq \mathbb{F}_q^{2nm}$ , and  $\text{swt}(\varphi_B(C)^{\perp_s} \setminus \varphi_B(C)) = d$  if  $K > 1$  and  $\text{swt}(\varphi_B(C)^{\perp_s}) = d$  if  $K = 1$ . Thus, an  $((nm, K, d))_q$  stabilizer code exists.

The existence of an  $((nm, K, d))_q$  stabilizer code implies the existence of an  $((n, K))_{q^m}$  stabilizer code; the claim about the minimum distance follows from the fact that  $\varphi_B^{-1}$  maps each nonzero block of  $m$  symbols to a nonzero symbol in  $\mathbb{F}_{q^m}$ .  $\square$

We notice that there exists a basis  $B$  such that  $M$  is the identity matrix if and only if either  $q$  is even or both  $q$  and  $m$  are odd, see [139]. In that case,  $\varphi_B$  simply expands each symbol into coordinates with respect to  $B$ .

## G. Puncturing Stabilizer Codes

If we delete one coordinate in all codewords of a classical code, then we obtain a shorter code that is called the punctured code. In general, we cannot proceed in the same way with stabilizer codes, since the resulting matrices might not commute if we delete one or more tensor components.

Rains [126] invented an interesting approach that solves the puncturing problem for linear stabilizer codes and, even better, gives a way to construct stabilizer codes from arbi-

rary linear codes. The idea is to associate with a classical linear code a so-called puncture code; if the puncture code contains a codeword of weight  $r$ , then a self-orthogonal code of length  $r$  exists and the minimum distance is the same or higher than that of the initial classical code. Further convenient criteria for puncture codes are given in [71].

In this section, we generalize puncturing to arbitrary stabilizer codes and review some known facts. Determining a puncture code is a challenging task, and maynot always possible to find it in closed form. In the next chapter we show how the results of this section can be applied to puncture quantum BCH codes.

It will be convenient to denote the the pointwise product of two vectors  $u$  and  $v$  in  $\mathbb{F}_q^n$  by  $uv$ , that is,  $uv = (u_i v_i)_{i=1}^n$ . Suppose that  $C \leq \mathbb{F}_q^{2n}$  is an arbitrary additive code. The associated puncture code  $P_s(C) \subseteq \mathbb{F}_q^n$  is defined as

$$P_s(C) = \{(b_k a'_k - b'_k a_k)_{k=1}^n \mid (a|b), (a'|b') \in C\}^\perp. \quad (3.14)$$

**Theorem III.42.** *Suppose that  $C$  is an arbitrary additive subcode of  $\mathbb{F}_q^{2n}$  of size  $|C| = q^n/K$  such that  $\text{swt}(C^{\perp_s} \setminus C) = d$ . If the puncture code  $P_s(C)$  contains a codeword of Hamming weight  $r$ , then there exists an  $((r, K^*, d^*))_q$  stabilizer code with  $K^* \geq K/q^{n-r}$  that has minimum distance  $d^* \geq d$  when  $K^* > 1$ . If  $\text{swt}(C^{\perp_s}) = d$ , then the resulting punctured stabilizer code is pure to  $d$ .*

*Proof.* Let  $x$  be a codeword of weight  $r$  in the  $P_s(C)$ . Define an additive code  $C_x \leq \mathbb{F}_q^{2n}$  by

$$C_x = \{(a|bx) \mid (a|b) \in C\}.$$

If  $(a|bx)$  and  $(a'|b'x)$  are arbitrary elements of  $C_x$ , then

$$\langle (a|bx) \mid (a'|b'x) \rangle_s = \text{tr} \left( \sum_{k=1}^n (b_k a'_k - b'_k a_k) x_k \right) = 0 \quad (3.15)$$

by definition of  $P_s(C)$ ; thus,  $C_x \leq (C_x)^{\perp_s}$ .

Let  $C_x^R = \{(a_k|b_k)_{k \in S} | (a|b) \in C_x\}$  denote the restriction of  $C_x$  to the support  $S$  of the vector  $x$ . Since equation (3.15) depends only on the nonzero coefficients of the vector  $x$ , it follows that  $C_x^R \leq (C_x^R)^{\perp_s}$  holds.

We note that  $|C| \geq |C_x^R|$ ; hence, the dimension  $K^*$  of the punctured quantum code is bounded by

$$K^* \geq q^r / |C_x^R| \geq q^r / |C| = q^r / (q^n / K) = K / q^{n-r}.$$

It remains to show that  $\text{swt}((C_x^R)^{\perp_s} \setminus C_x^R) \geq d$ . Seeking a contradiction, we suppose that  $u_x^R$  is a vector in  $(C_x^R)^{\perp_s} \setminus C_x^R$  such that  $\text{swt}(u_x^R) < d$ . Let  $u_x = (a|b)$  denote the vector in  $(C_x)^{\perp_s}$  that is zero outside the support of  $x$  and coincides with  $u_x^R$  when restricted to the support of  $x$ . It follows that  $(ax|b)$  is contained in  $C^{\perp_s}$ . However  $\text{swt}(ax|b) < d$ , so  $(ax|b)$  must be an element of  $C$ , since  $\text{swt}(C^{\perp_s} \setminus C) = d$ . This implies that  $(ax|bx)$  is an element of  $C_x \leq (C_x)^{\perp_s}$ . Arguing as before, it follows that  $(ax^2|bx)$  is in  $C$  and  $(ax^2|bx^2)$  is in  $C_x$ . Repeating the process, we obtain that  $v_x = (ax^{q-1}|bx^{q-1})$  is in  $C_x$ , and we note that  $x^{q-1}$  is the characteristic vector of the support of  $x$ . Restricting  $v_x$  in  $C_x$  to the support of  $x$  yields  $u_x^R \in C_x^R$ , contradicting the assumption that  $u_x^R \in (C_x^R)^{\perp_s} \setminus C_x^R$ .

Finally, the last statement concerning the purity is easy to prove (a direct generalization of the argument given in [71] for pure linear codes).  $\square$

If the code  $C$  is a direct product, as in the case of CSS codes, then the expression for the puncture code simplifies somewhat.

**Lemma III.43.** *If  $C_1$  and  $C_2$  are two additive subcodes of  $\mathbb{F}_q^n$ , then*

$$P_s(C_1 \times C_2) = \{ab \mid a \in C_1, b \in C_2\}^{\perp} \leq \mathbb{F}_q^n.$$

*Proof.* Since  $\langle ab \mid a \in C_1, b \in C_2 \rangle = \langle (ba' - b'a) \mid a, a' \in C_1, b, b' \in C_2 \rangle$ , the claim about the orthogonal complements of these sets is obvious.  $\square$

Since many quantum codes are constructed from self-orthogonal codes  $C \leq C^{\perp}$ , we

write

$$P_e(C) = P_s(C \times C) = \{ab \mid a, b \in C\}^\perp. \quad (3.16)$$

## H. Conclusions

In this chapter we have further developed the theory of nonbinary stabilizer codes. After reviewing the basic theory of nonbinary stabilizer codes over finite fields, we introduced Galois-theoretic methods to clarify the relation between these and more general quantum codes. We showed the most general class of codes over quadratic extension fields that can be used to construct quantum codes are those that are self-orthogonal with respect to the trace alternating product.

We gave simpler proofs for the existence of nonbinary quantum codes. We also generalized the linear programming bounds for the nonbinary codes. Following Gottesman's lead [61], we were able to show that single and double error-correcting nonbinary stabilizer codes cannot beat the quantum Hamming bound. We conjecture that no quantum stabilizer code can exceed the quantum Hamming bound, but a proof is still elusive. We also gave methods to obtain new quantum codes from existing quantum codes. In particular, we developed the theory of puncture codes.

There are open questions that the work in this chapter suggests. We could for instance start with a different choice of error basis [93], and one can develop a similar theory for such stabilizer codes. For example, one choice leads to self-orthogonal additive subcodes of  $\mathbb{Z}_q^n \times \mathbb{Z}_q^n$  instead of subcodes of  $\mathbb{F}_q^n \times \mathbb{F}_q^n$ . It would be interesting to know how the stabilizer codes with respect to different error bases compare. To the best of our knowledge, such a comparison has not been made.

## CHAPTER IV

## CLASSES OF STABILIZER CODES\*

In this chapter we shall take a constructive approach to our study of stabilizer codes giving explicit constructions for many classes of codes. Much of the theory we developed in Chapter III will be brought to bearing with additional simplifications for the classes of linear codes. In case of linear codes, our main methods of constructions will be the Hermitian construction and the CSS construction (Lemmas III.19–III.21). Hence, we need to look for classical codes that are self-orthogonal with respect to the Hermitian or the Euclidean product or families of nested codes like the BCH codes. Additionally, we investigate the structural properties of nontrivial codes that meet the quantum Singleton bound and establish bounds on the maximal length of such codes. We provide a concrete illustration of the theory of puncture codes developed in the last chapter by puncturing the quantum BCH codes.

## A. Quantum Cyclic Codes

Cyclic codes are an interesting class of codes which have simple encoding and efficient decoding algorithms. Consequently, quantum cyclic codes have also generated interest. Before we construct quantum cyclic codes we need the following results for identifying cyclic codes that contain their duals. We have not been able to trace the references that first proved these results, but we note that these conditions have been established in various forms earlier, especially for codes over  $\mathbb{F}_2$  and  $\mathbb{F}_4$ ; see [76, Chapter 4] for general results concerning classical codes and [35, 70] for results concerning binary quantum codes. We

---

\*©2006 IEEE. Reprinted in part, with permission, from A. Ketkar, A. Klappenecker, S. Kumar and P. K. Sarvepalli, “Nonbinary stabilizer codes over finite fields”. *IEEE Trans. Inform. Theory*, vol. 52, no. 11, pp. 4892–4914, 2006.

provide a convenient and unified treatment while giving the nonbinary equivalents.

Recall that a classical cyclic code with parameters  $[n, k]_q$  is a principal ideal in the ring  $\mathbb{F}_q[x]/(x^n - 1)$  and can be succinctly described by its generator polynomial or its defining set. The polynomial  $x^n - 1$  of  $\mathbb{F}_q[x]$  has simple roots if and only if  $n$  and  $q$  are coprime. If the latter condition is satisfied, then there exists a positive integer  $m$  such that the field  $\mathbb{F}_{q^m}$  contains a primitive  $n$ th root of unity  $\beta$ . In that case, one can describe a cyclic code with generator polynomial  $g(x)$  in terms of its defining set  $Z = \{k \mid g(\beta^k) = 0 \text{ for } 0 \leq k < n\}$ . Further details on cyclic codes can be found in any standard textbook on coding theory, see [76] or [107].

In the case of cyclic codes, identifying the self-orthogonal codes can be translated into equivalent conditions on the generator polynomial of the code or its defining set. First we shall consider codes over  $\mathbb{F}_{q^2}$ . Let  $\sigma$  denote the automorphism of the field  $\mathbb{F}_{q^2}$  given by  $\sigma(x) = x^q$ . We can define an action of  $\sigma$  on the polynomial ring  $\mathbb{F}_{q^2}[x]$  by

$$h(x) = \sum_{k=0}^n h_k x^k \mapsto h^\sigma(x) = \sum_{k=0}^n \sigma(h_k) x^k.$$

**Lemma IV.1.** *Suppose that  $B$  is a classical cyclic  $[n, k, d]_{q^2}$  code with generator polynomial  $g(x)$  and check polynomial  $h(x) = (x^n - 1)/g(x)$ . If  $g(x)$  divides  $\sigma(h_0)^{-1} x^k h^\sigma(1/x)$ , then  $B^{\perp_h} \subseteq B$ , and there exists an  $[[n, 2k - n, \geq d]]_q$  stabilizer code that is pure to  $d$ .*

*Proof.* If  $h(x)$  is the check polynomial of  $B$ , then  $h^\sigma(x)$  is the check polynomial of  $\sigma(B)$ . The generator polynomial of the dual code  $\sigma(B)^\perp = B^{\perp_h}$  is given by  $\sigma(h_0)^{-1} x^k h^\sigma(1/x)$ , the normalized reciprocal polynomial of  $h^\sigma(x)$ . Therefore, the condition that the polynomial  $g(x)$  divides  $\sigma(h_0)^{-1} x^k h^\sigma(1/x)$  is equivalent to the condition  $B^{\perp_h} \subseteq B$ . The stabilizer code follows from Corollary III.19.  $\square$

The following Lemma summarizes various equivalent conditions on dual containing codes in terms of the generator polynomial  $g(x)$  and the defining set  $Z$ .

**Lemma IV.2.** *Let  $\gcd(n, q^2) = 1$  and  $C$  be a classical cyclic  $[n, k, d]_{q^2}$  code whose generator polynomial is  $g(x)$  and defining set is  $Z$ . Suppose that any of the following equivalent conditions are satisfied*

(i)  $x^n - 1 \equiv 0 \pmod{g(x)g^*(x)}$  where  $g^*(x) = x^{n-k}g^\sigma(1/x)$ ;

(ii)  $Z \subseteq \{-qz \mid z \in N \setminus Z\}$ ;

(iii)  $Z \cap Z^{-q} = \emptyset$ , where  $Z^{-q} = \{-qz \mid z \in Z\}$ .

Then  $C^{\perp_h} \subseteq C$  and there exists an  $[[n, 2k - n, \geq d]]_q$  stabilizer code that is pure to  $d$ .

*Proof.* Let  $h(x) = (x^n - 1)/g(x)$  be the check polynomial of  $C$ . Then  $h^\sigma(x) = \sigma((x^n - 1)/g(x)) = (x^n - 1)/g^\sigma(x)$ . From Lemma IV.1 we know that  $C$  contains its Hermitian dual if  $g(x)$  divides  $\sigma(h_0)^{-1}x^k h^\sigma(1/x)$  viz.  $g(x) \mid \sigma(h_0)^{-1}(1 - x^n)/(x^{n-k}g^\sigma(1/x))$ , which implies  $x^n - 1 \equiv 0 \pmod{g(x)g^*(x)}$  which proves (i).

The generator polynomial  $g(x)$  of  $C$  is given by  $g(x) = \prod_{z \in Z} (x - \beta^z)$ , hence its check polynomial is of the form

$$h(x) = (x^n - 1)/g(x) = \prod_{z \in N \setminus Z} (x - \beta^z).$$

Applying the automorphism  $\sigma$  yields  $h^\sigma(x) = \prod_{z \in N \setminus Z} (x - \beta^{qz})$ . Therefore, the generator polynomial of  $C^{\perp_h}$  is given by

$$\begin{aligned} h^\sigma(0)^{-1}x^k h^\sigma(1/x) &= h^\sigma(0)^{-1} \prod_{z \in N \setminus Z} (1 - \beta^{qz}x) \\ &= \prod_{z \in N \setminus Z} (x - \beta^{-qz}); \end{aligned}$$

in the last equality, we have used the fact that  $h^\sigma(0)^{-1} = \prod_{z \in N \setminus Z} (-\beta^{-qz})$ . By Lemma IV.1,  $B^{\perp_h} \subseteq B$  if and only if the generator polynomial  $g(x)$  divides  $h^\sigma(0)^{-1}x^k h^\sigma(1/x)$ . The latter condition is equivalent to the fact that  $Z$  is a subset of  $\{-qz \mid z \in N \setminus Z\}$  and (ii) follows. From (ii) we know that  $C^{\perp_h} \subseteq C$  if and only if  $Z \subseteq \{-qz \mid z \in N \setminus Z\}$ . In other words  $Z^{-q} \subseteq N \setminus Z$ . Hence  $Z \cap Z^{-q} = \emptyset$ . An  $[[n, 2k - n, \geq d]]_q$  stabilizer code follows from Corollary III.19.  $\square$

Cyclic codes that contain their Euclidean duals can also be nicely characterized in terms of their generator polynomials and defining sets. The following Lemma is a very straight forward extension of the binary case and summarizes some of the known results in the nonbinary case as well, but we include it because of its usefulness in constructing cyclic quantum codes.

**Lemma IV.3.** *Let  $C$  be an  $[[n, k, d]]_q$  cyclic code such that  $\gcd(n, q) = 1$ . Let its defining set  $Z$  and generator polynomial  $g(x)$  be such that any of the following equivalent conditions are satisfied*

- (i)  $x^n - 1 \equiv 0 \pmod{g(x)g^\dagger(x)}$ , where  $g^\dagger(x) = x^{n-k}g(1/x)$ ;
- (ii)  $Z \subseteq \{-z \mid z \in N \setminus Z\}$ ;
- (iii)  $Z \cap Z^{-1} = \emptyset$  where  $Z^{-1} = \{-z \pmod{n} \mid z \in Z\}$ .

*Then  $C^\perp \subseteq C$  and there exists an  $[[n, 2k - n, \geq d]]_q$  stabilizer code that is pure to  $d$ .*

*Proof.* The check polynomial of  $C$  is given by  $h(x) = (x^n - 1)/g(x)$ , from which we obtain the (un-normalized) generator polynomial of  $C^\perp$  as  $h^\dagger(x) = x^k h(x^{-1}) = (1 - x^n)/(x^{n-k}g(x^{-1})) = -(x^n - 1)/g^\dagger(x)$ . If  $C^\perp \subseteq C$ , then  $g(x) \mid h^\dagger(x)$ ; this means that  $g(x)$  divides  $(x^n - 1)/g^\dagger(x)$ . In other words  $x^n - 1 \equiv 0 \pmod{g(x)g^\dagger(x)}$ .

The defining set of  $C^\perp$  is given by  $\{-z \pmod{n} \mid z \in N \setminus Z\}$ , where  $N = \{0, 1, \dots, n-1\}$ . Thus  $C^\perp \subseteq C$  implies  $Z \subseteq \{-z \pmod{n} \mid N \setminus Z\}$ . Since this means that the inverses of elements in  $Z$  are present in  $N \setminus Z$ , this condition can also be written as  $Z \cap Z^{-1} = \emptyset$ . The existence of quantum code  $[[n, 2k - n, \geq d]]_q$  follows from Corollary III.21.  $\square$

Although we have considered purely cyclic codes, a larger class of cyclic quantum codes can be derived by considering constacyclic or conjucyclic codes as in [35], [154].



## 1. Cyclic Hamming Codes

Binary quantum Hamming codes have been studied by various authors; see for instance [35, 54, 59]. We now derive stabilizer codes from nonbinary classical cyclic Hamming codes. Let  $m > 1$  be an integer such that  $\gcd(q-1, m) = 1$ . A classical cyclic Hamming code  $H_q(m)$  has parameters  $[n, n-m, 3]_q$  with length  $n = (q^m - 1)/(q - 1)$ . Let  $\beta$  denote a primitive  $n$ th root of unity in  $\mathbb{F}_{q^m}$ . The generator polynomial of  $H_q(m)$  is given by

$$g(x) = \prod_{i=0}^{m-1} (x - \beta^{q^i}), \quad (4.1)$$

an element of  $\mathbb{F}_q[x]$ . Thus, the code  $H_q(m)$  is defined by the cyclotomic coset  $C_1 = \{q^i \bmod n \mid i \in \mathbb{Z}\}$ .

**Lemma IV.4.** *The Hamming code  $H_{q^2}(m)$  contains its Hermitian dual, that is,  $H_{q^2}(m)^{\perp_h} \leq H_{q^2}(m)$ .*

*Proof.* The statement  $H_{q^2}(m)^{\perp_h} \leq H_{q^2}(m)$  is equivalent to the fact that the cyclotomic coset  $C_1$  satisfies  $C_1 \subseteq N_1 = \{-qz \bmod n \mid z \in N \setminus C_1\}$ , where  $N = \{0, \dots, n-1\}$  and  $n = (q^{2m} - 1)/(q^2 - 1)$ . We note that  $C_1$  can be expressed in the form

$$\begin{aligned} C_1 &= \left\{ (1-n)q^{2k} \bmod n \mid k \in \mathbb{Z} \right\} \\ &= \left\{ -qzq^{2k} \bmod n \mid k \in \mathbb{Z} \right\}, \end{aligned} \quad (4.2)$$

where  $z = q(q^{2m-2} - 1)/(q^2 - 1)$ . Therefore, the condition  $C_1 \subseteq N_1$  holds if and only if  $C_z \subseteq N \setminus C_1$  holds, where  $C_z = \{zq^{2j} \bmod n \mid j \in \mathbb{Z}\}$ .

Seeking a contradiction, we assume that the two cyclotomic cosets  $C_1$  and  $C_z$  have an element in common, hence are the same. This means that there must exist a positive integer  $k$  such that  $q^{2k} = q(q^{2m-2} - 1)/(q^2 - 1)$ . This implies that  $q^{2k-1}$  divides  $q^{2m-2} - 1$ , which is absurd. Thus, the sets  $C_1$  and  $C_z$  are disjoint, hence  $C_z \subseteq N \setminus C_1$ , which proves the claim.  $\square$

**Theorem IV.5.** *For each integer  $m \geq 2$  such that  $\gcd(m, q^2 - 1) = 1$ , there exists a pure  $[[n, n - 2m, 3]]_q$  stabilizer code of length  $n = (q^{2m} - 1)/(q^2 - 1)$ .*

*Proof.* If  $\gcd(m, q^2 - 1) = 1$ , then there exists a classical  $[n, n - m, 3]_{q^2}$  Hamming code  $H_{q^2}(m)$ . By Lemma IV.4, we have  $H_{q^2}(m)^{\perp_h} \leq H_{q^2}(m)$ , hence there exists a pure  $[[n, n - 2m, 3]]_q$  stabilizer code by Corollary III.19. The purity is due to the fact that the  $H_{q^2}(m)^{\perp_h}$  has minimum distance  $q^{2m-2} \geq 3$  for  $m \geq 2$  [76, Theorem 1.8.3].  $\square$

These quantum Hamming codes are optimal since they attain the quantum Hamming bound, see Corollary III.29. A different approach that allows construction of noncyclic perfect quantum codes can be found in [28]. It is also possible to construct quantum codes from Hamming codes that contain their Euclidean duals, however these codes do not meet the quantum Hamming bound.

**Lemma IV.6.** *If  $\gcd(m, q - 1) = 1$  and  $m \geq 2$ , then there exists a pure  $[[n, n - 2m, 3]]_q$  quantum code, where  $n = (q^m - 1)/(q - 1)$ .*

*Proof.* The generating polynomial of an  $[n, n - m, 3]_q$  Hamming code, with  $n = (q^m - 1)/(q - 1)$  is given by equation (4.1) where  $\beta$  is an element of order  $n$ . The code exists only if  $\gcd(m, q - 1) = 1$ . By Lemma IV.3 a cyclic code contains its dual if  $x^n - 1 \equiv 0 \pmod{g(x)g^\dagger(x)}$ , where  $g^\dagger(x) = x^{n-k}g(x^{-1})$ . If  $g(x)$  is not self-reciprocal then  $g(x)g^\dagger(x)$  divides  $x^n - 1$  [152]. Since the generating polynomial of the Hamming code is not self-reciprocal, the code contains its Euclidean dual. By Lemma IV.3 we can construct a quantum code with the parameters  $[[n, n - 2m, 3]]_q$ . Once again the purity follows due to the fact the duals of Hamming codes are simplex codes with weight  $q^{m-1} \geq 3$  for  $m \geq 2$  [76, Theorem 1.8.3].  $\square$

## 2. Quantum Quadratic Residue Codes

Another well known family of classical codes are the quadratic residue codes. Rains constructed quadratic residue codes for prime alphabet in [126]. In this section we will construct two series of quantum codes based on the classical quadratic residue codes over an arbitrary field using elementary methods.

Let  $\alpha$  denote a primitive  $n$ th root of unity from some extension field of  $\mathbb{F}_q$ . We denote by  $R = \{r^2 \bmod n \mid r \in \mathbb{Z} \text{ such that } 1 \leq r \leq (n-1)/2\}$  the set of quadratic residues modulo  $n$  and by  $N = \{1, \dots, n-1\} \setminus R$  the set of quadratic non-residues modulo  $n$ .

Let  $C_R$  and  $C_N$  denote the cyclic codes of length  $n$  that are respectively generated by the polynomials  $q_R(x)$  and  $q_N(x)$ , where

$$q_R(x) = \prod_{r \in R} (x - \alpha^r) \quad \text{and} \quad q_N(x) = \prod_{r \in N} (x - \alpha^r).$$

Both codes have parameters  $[n, (n+1)/2, d]_q$  with  $d^2 \geq n$ , see [27, pp. 114-119] or [76]. The codes with generator polynomials  $(x-1)q_R(x)$  and  $(x-1)q_N(x)$  are the even-like subcodes of  $C_R$  and  $C_N$  respectively and have the parameters  $[n, (n-1)/2, d']_q$  with  $d' \geq d$ . The relevance of these codes will become apparent in the following theorems.

**Theorem IV.7.** *Let  $n$  be a prime of the form  $n \equiv 3 \pmod{4}$ , and let  $q$  be a power of a prime that is not divisible by  $n$ . If  $q$  is a quadratic residue modulo  $n$ , then there exists a pure  $[[n, 1, d]]_q$  stabilizer code with minimum distance  $d$  satisfying  $d^2 - d + 1 \geq n$ .*

*Proof.* The code  $C_R$  has parameters  $[n, (n+1)/2, d]_q$  and if  $n \equiv 3 \pmod{4}$ , the dual code  $C_R^\perp$  of  $C_R$  is given by the cyclic code generated by  $(x-1)q_R(x)$ , the even-like subcode of  $C_R$ . The minimum distance  $d$  is bounded by  $d^2 - d + 1 \geq n$ , see, for instance, [27, pp. 114-119]. Further  $\text{wt}(C_R \setminus C_R^\perp) = \text{wt}(C_R) = d$  by [76, Theorem 6.6.22]. We can deduce from Corollary III.21 that there exists a pure  $[[n, (n+1) - n, d]]_q$  stabilizer code.  $\square$

For example, the prime  $p = 3$  is a quadratic residue modulo  $n = 23$ . The previous

proposition guarantees the existence of a  $[[23, 1, d]]_3$  stabilizer code with minimum distance  $d \geq 6$ .

If  $n$  is an odd prime of the form  $n \equiv 1 \pmod{4}$ , then we can also construct quadratic residue codes, but now we need to employ Lemma III.20, because  $C_R$  does not contain its dual.

**Theorem IV.8.** *Let  $n$  be a prime of the form  $n \equiv 1 \pmod{4}$ . Let  $q$  be a power of a prime that is not divisible by  $n$ . If  $q$  is a quadratic residue modulo  $n$ , then there exists a pure  $[[n, 1, d]]_q$  stabilizer code with minimum distance  $d$  bounded from below by  $d \geq \sqrt{n}$ .*

*Proof.* The dual code of  $C_R$  is given by the even-like subcode of  $C_N$ ; in other words,  $C_R^\perp$  is a cyclic code of length  $n$  over  $\mathbb{F}_q$  that is generated by the polynomial  $(x-1)q_N(x)$ ; in particular,  $C_R^\perp \leq C_N$ . Moreover  $\text{wt}(C_R \setminus C_R^\perp) = \text{wt}(C_N \setminus C_R^\perp) = \text{wt}(C_R) = \text{wt}(C_N) = d$  by [76, Theorem 6.6.22]. Therefore, we obtain a pure  $[[n, (n+1)/2 + (n+1)/2 - n, d]]_q$  code by Lemma III.20.  $\square$

## B. Quantum BCH Codes

In this section we consider a popular family of classical codes, the BCH codes, and construct the associated nonbinary quantum stabilizer codes. Binary quantum BCH codes were studied in [35, 43, 68, 146]. The CSS construction turns out to be especially useful, because BCH codes form a naturally nested family of codes. In case of primitive BCH codes over prime fields, the distance of the dual is lower bounded by the generalized Carlitz-Uchiyama bound, and this allows us to derive bounds on the minimum distance of the resulting quantum codes.

## 1. BCH Codes.

Let  $q$  be a power of a prime and  $n$  a positive integer that is coprime to  $q$ . Recall that a BCH code  $C$  of length  $n$  and designed distance  $\delta$  over  $\mathbb{F}_q$  is a cyclic code whose defining set  $Z$  is given by a union of  $\delta - 1$  subsequent cyclotomic cosets,

$$Z = \bigcup_{x=b}^{b+\delta-2} C_x, \quad \text{where } C_x = \{xq^r \bmod n \mid r \in \mathbb{Z}, r \geq 0\}.$$

The generator polynomial of the code is of the form

$$g(x) = \prod_{z \in Z} (x - \beta^z),$$

where  $\beta$  is a primitive  $n$ -th root of unity of some extension field of  $\mathbb{F}_q$ . The definition ensures that  $g(x)$  generates a cyclic  $[n, k, d]_q$  code of dimension  $k = n - |Z|$  and minimum distance  $d \geq \delta$ . If  $b = 1$ , then the code  $C$  is called a narrow-sense BCH code, and if  $n = q^m - 1$  for some  $m \geq 1$ , then the code is called primitive. More precise statements can be made about the structure of primitive, narrow-sense codes than the other classes of BCH codes and we will restrict our attention to these in this paper. More details on BCH codes can be found in [76, 107].

## 2. Generalized Carlitz-Uchiyama Bound.

Our first construction derives stabilizer codes from BCH codes over prime fields. We use the Knuth-Iverson bracket  $[statement]$  in the formulation of the Carlitz-Uchiyama bound that evaluates to 1 if *statement* is true and 0 otherwise.

**Lemma IV.9** (Generalized Carlitz-Uchiyama Bound). *Let  $p$  be a prime. Let  $C$  denote a narrow-sense BCH code of length  $n = p^m - 1$  over  $\mathbb{F}_p$ , of designed distance  $\delta = 2t + 1$ .*

Then the minimum distance  $d^\perp$  of its Euclidean dual code  $C^\perp$  is bounded by

$$d^\perp \geq \left(1 - \frac{1}{p}\right) \left(p^m - \frac{\delta - 2 - [\delta - 1 \equiv 0 \pmod{p}]}{2} \lfloor 2p^{m/2} \rfloor\right). \quad (4.3)$$

*Proof.* See [149, Theorem 7]; for further background, see [107, page 280].  $\square$

**Theorem IV.10.** *Let  $p$  be a prime. Let  $C$  be a  $[p^m - 1, k, \geq \delta]_p$  narrow-sense BCH code of designed distance  $\delta = 2t + 1$  and  $C^*$  a  $[p^m - 1, k^*, d^*]_p$  BCH code such that  $C \subseteq C^*$ . Then there exists a  $[[p^m - 1, k^* - k, \geq \min\{d^*, d^\perp\}]]_p$  stabilizer code, where  $d^\perp$  is given by (4.3).*

*Proof.* The result follows from applying Lemma IV.9 to  $C$  and Lemma III.20 to the codes  $C$  and  $C^*$ .  $\square$

**Remark IV.11.** (i) *The Carlitz-Uchiyama bound becomes trivial for larger design distances.* (ii) *In [111, Corollary 2] it was shown that for binary BCH codes of design distance  $d$ , the lower bound in equation (4.3) is attained when  $n = 2^{2ab} - 1$ , where  $a$  is the smallest integer such that  $d - 2 \mid 2^a + 1$  and  $b$  is odd.* (iii) *For a further tightening of the Carlitz-Uchiyama bound see [112, Theorem 2].*

### 3. Primitive BCH Codes Containing Their Duals.

We can extend the results of the previous section to BCH codes over finite fields that are not necessarily prime. In fact, if we restrict ourselves to smaller designed distances, then we can even achieve significantly sharper results. We will just review the results and refer the reader to our companion paper [4] for the proofs. A generalization of the following results is given in Chapter IX, with a view to demonstrate the fact that study of quantum codes can lead to interesting insights into classical coding theory.

In the BCH code construction, it is in general not obvious how large the cyclotomic cosets will be. However, if the designed distance is small, then one can show that the

cyclotomic cosets all have maximal size.

**Lemma IV.12.** *A narrow-sense, primitive BCH code with design distance  $2 \leq \delta \leq q^{\lceil m/2 \rceil} + 1$  has parameters  $[q^m - 1, q^m - 1 - m\lceil(\delta - 1)(1 - 1/q)\rceil, \geq \delta]_q$ .*

*Proof.* See [4, Theorem 7]; the binary case was already established by Steane [146].  $\square$

In the case of small designed distances, primitive, narrow-sense BCH codes contain their Euclidean duals.

**Lemma IV.13.** *A narrow-sense, primitive BCH code over  $\mathbb{F}_q^n$  contains its Euclidean dual if and only if its design distance satisfies  $2 \leq \delta \leq q^{\lceil m/2 \rceil} - 1 - (q - 2)[m \text{ odd}]$ , where  $n = q^m - 1$  and  $m \geq 2$ .*

*Proof.* See [4, Theorem 2].  $\square$

A simple consequence is the following theorem:

**Theorem IV.14.** *If  $C$  is a narrow-sense primitive BCH code over  $\mathbb{F}_q$  with design distance  $2 \leq \delta \leq q^{\lceil m/2 \rceil} - 1 - (q - 2)[m \text{ odd}]$  and  $m \geq 2$ , then there exists an  $[[q^m - 1, q^m - 1 - 2m\lceil(\delta - 1)(1 - 1/q)\rceil, \geq \delta]_q$  stabilizer code that is pure to  $\delta$ .*

*Proof.* If we combine Lemmas IV.12 and IV.13 and apply the CSS construction, then we obtain the claim. See [4] for details about purity.  $\square$

One can argue in a similar way for Hermitian duals of primitive, narrow-sense BCH codes.

**Theorem IV.15.** *If  $C$  is a narrow-sense primitive BCH code over  $\mathbb{F}_{q^2}^n$  with design distance  $2 \leq \delta \leq q^m - 1$ , then there exists an  $[[q^{2m} - 1, q^{2m} - 1 - 2m\lceil(\delta - 1)(1 - 1/q^2)\rceil, \geq \delta]_q$  stabilizer code that is pure to  $\delta$ .*

*Proof.* See [4] for details.  $\square$

When  $m = 1$ , the BCH codes are the same as the Reed Solomon codes and this case has been dealt with in [71]. An alternate perspective using Reed-Muller codes is considered in [134].

#### 4. Extending Quantum BCH Codes

It is not always possible to extend a stabilizer code, because the corresponding classical codes are required to be self-orthogonal. We now show that it is possible to extend narrow-sense BCH codes of certain lengths.

**Lemma IV.16.** *Let  $\mathbb{F}_{q^2}$  be a finite field of characteristic  $p$ . If  $C$  is a narrow-sense  $[[n, k, \geq d]]_{q^2}$  BCH code such that  $C^{\perp_h} \subseteq C$  and  $n \equiv -1 \pmod{p}$ , then there exists an  $[[n, 2k - n, \geq d]]_q$  stabilizer code that is pure to  $d$  which can be extended to an  $[[n+1, 2k - n - 1, \geq d+1]]_q$  stabilizer code that is pure to  $d + 1$ .*

*Proof.* Since  $C^{\perp_h} \subseteq C$ , Corollary III.19 implies the existence of an  $[[n, 2k - n, \geq d]]_q$  quantum code that is pure to  $d$  and being narrow-sense the parity check matrix of  $C$  has the form

$$H = \begin{bmatrix} 1 & \alpha & \alpha^2 & \dots & \alpha^{(n-1)} \\ 1 & \alpha^2 & \alpha^{2(2)} & \dots & \alpha^{2(n-1)} \\ \vdots & \ddots & \ddots & \ddots & \ddots \\ 1 & \alpha^{d-1} & \alpha^{2(d-1)} & \dots & \alpha^{(n-1)(d-1)} \end{bmatrix},$$

where  $\alpha$  is a primitive  $n^{\text{th}}$  root of unity. This can be extended to give an  $[[n + 1, k, d + 1]]_q$



code  $C_e$ , whose parity check matrix is given as

$$H_e = \begin{bmatrix} 1 & 1 & 1 & \cdots & 1 & 1 \\ 1 & \alpha & \alpha^2 & \cdots & \alpha^{(n-1)} & 0 \\ 1 & \alpha^2 & \alpha^{2(2)} & \cdots & \alpha^{2(n-1)} & 0 \\ \vdots & \ddots & \ddots & \ddots & \ddots & \vdots \\ 1 & \alpha^{d-1} & \alpha^{2(d-1)} & \cdots & \alpha^{(n-1)(d-1)} & 0 \end{bmatrix}.$$

We show that  $C_e^{\perp_h}$  is self-orthogonal. Let  $R_i$  be the  $i^{\text{th}}$  row in  $H_e$ . For  $2 \leq i \leq d$  the self-orthogonality of  $H$  implies that  $\langle R_i | R_j \rangle_h = 0$ . We need to show that  $\langle R_i | \mathbf{1} \rangle_h = 0$ ,  $1 \leq i \leq d$ . For  $2 \leq i \leq d$  we have  $\langle R_i | \mathbf{1} \rangle_h = \sum_{j=0}^{n-1} \alpha^{ij} = (\alpha^{in} - 1)/(\alpha^i - 1) = 0$ , as  $\alpha^n = 1$  and  $\alpha^i \neq 1$ . For  $i = 1$  we have  $\langle \mathbf{1} | \mathbf{1} \rangle_h = n + 1 \pmod{p}$ , which vanishes because of the assumption  $n \equiv -1 \pmod{p}$ .

Now we show that the rank of  $H_e$  is  $d$ , thus  $C_e$  has a minimum distance of at least  $d + 1$ . Any  $d$  columns of  $H_e$  excluding the last column form a  $d \times d$  vandermonde matrix which is nonsingular, indicating that the  $d$  columns are linearly independent. If we consider any set of  $d$  columns that includes the last column, we can find the determinant of the corresponding matrix by expanding by the last column. This gives us a  $d - 1 \times d - 1$  vandermonde matrix with nonzero determinant. Thus any  $d$  columns of  $H_e$  are independent and the minimum distance of  $C_e$  is at least  $d + 1$ . Therefore  $C_e$  is an  $[[n + 1, k, \geq d + 1]]_{q^2}$  extended cyclic code such that  $C_e^{\perp_h} \subseteq C_e$ . By Corollary III.19 it defines an  $[[n + 1, 2k - n - 1, \geq d + 1]]_q$  quantum code pure to  $d + 1$ .  $\square$

**Corollary IV.17.** *For all prime powers  $q$ , integers  $m \geq 1$  and all  $\delta$  in the range  $2 \leq \delta \leq q^m - 1$  there exists an*

$$[[q^{2m}, q^{2m} - 2 - 2m[(\delta - 1)(1 - 1/q^2)], \geq \delta + 1]]_q$$

*stabilizer code pure to  $\delta + 1$ .*

*Proof.* The stabilizer codes from Theorem IV.15 are derived from primitive, narrow-sense BCH codes. If  $p$  denotes the characteristic of  $\mathbb{F}_{q^2}$ , then  $q^{2m} - 1 \equiv -1 \pmod{p}$ , so the stabilizer codes given in Theorem IV.15 can be extended by Lemma IV.16.  $\square$

A result similar to Lemma IV.16 can be developed for BCH codes that contain their Euclidean duals.

## 5. Puncturing BCH Codes.

In this section, let  $\text{BCH}_q^m(\delta)$  denote a primitive, narrow-sense  $q$ -ary BCH code of length  $n = q^m - 1$  and designed distance  $\delta$ . We illustrate the theory of puncture codes developed in Chapter III by puncturing such BCH codes. Some knowledge about the puncture code is necessary for this task, and we show in Theorem IV.19 that a cyclic generalized Reed-Muller code is contained in the puncture code.

First, let us recall some basic facts about cyclic generalized Reed-Muller codes, see [16, 17, 80, 117] for details. Let  $L_m(\nu)$  denote the subspace of  $\mathbb{F}_q[x_1, \dots, x_m]$  consisting of polynomials of degree  $\leq \nu$ , and let  $(P_0, \dots, P_{n-1})$  be an enumeration of the points in  $\mathbb{F}_q^m$  where  $P_0 = \mathbf{0}$ . The  $q$ -ary cyclic generalized Reed-Muller code  $\mathcal{R}_q^*(\nu, m)$  of order  $\nu$  and length  $n = q^m - 1$  is defined as

$$\mathcal{R}_q^*(\nu, m) = \{ev f \mid f \in L_m(\nu)\},$$

where the codewords are evaluations of the polynomials in all but  $P_0$  defined by  $ev f = (f(P_1), \dots, f(P_{n-1}))$ . The dimension  $k^*(\nu)$  of the code  $\mathcal{R}_q^*(\nu, m)$  is given by the formula  $k^*(\nu) = \sum_{j=0}^m (-1)^j \binom{m}{j} \binom{m+\nu-jq}{\nu-jq}$  and its minimum distance  $d^*(\nu) = (R+1)q^Q - 1$ , where  $m(q-1) - \nu = (q-1)Q + R$  with  $0 \leq R < q-1$ . The dual code of  $\mathcal{R}_q^*(\nu, m)$  can be characterized by

$$\mathcal{R}_q^*(\nu, m)^\perp = \{ev f \mid f \in L_m^*(\nu^\perp)\}, \quad (4.4)$$

where  $\nu^\perp = m(q-1) - \nu - 1$  and  $L_m^*(\nu)$  is the subspace of all nonconstant polynomials in  $L_m(\nu)$ ;

It is well-known that a primitive, narrow-sense BCH code contains a cyclic generalized Reed-Muller code, see [80, Theorem 5], and we determine the largest such subcode in our next lemma.

**Lemma IV.18.** *Let  $\nu = (m-Q)(q-1) - R$ , with  $Q = \lfloor \log_q(\delta+1) \rfloor$  and  $R = \lceil (\delta+1)/q^Q \rceil - 1$ , then  $\mathcal{R}_q^*(\nu, m) \subseteq \text{BCH}_q^m(\delta)$ . Also for all orders  $\nu' > \nu$ , we have  $\mathcal{R}_q^*(\nu', m) \not\subseteq \text{BCH}_q^m(\delta)$ .*

*Proof.* First, we show that  $\mathcal{R}_q^*(\nu, m) \subseteq \text{BCH}_q^m(\delta)$ . Recall that the minimum distance  $d^*(\nu) = (R+1)q^Q - 1$ , where  $m(q-1) - \nu = (q-1)Q + R$  with  $0 \leq R < q-1$ . By [80, Theorem 5], we have  $\mathcal{R}_q^*(\nu, m) \subseteq \text{BCH}_q^m((R+1)q^Q - 1)$ . Notice that  $(R+1)q^Q - 1 = \lceil (\delta+1)/q^Q \rceil q^Q - 1 \geq \delta$ , so  $\text{BCH}_q^m((R+1)q^Q - 1) \subseteq \text{BCH}_q^m(\delta)$ . Therefore,  $\mathcal{R}_q^*(\nu, m) \subseteq \text{BCH}_q^m(\delta)$ , as claimed.

For the second claim, it suffices to show that  $\mathcal{R}_q^*(\nu+1, m)$  is not a subcode of  $\text{BCH}_q^m(\delta)$ . We prove this by showing that the minimum distance  $d^*(\nu+1) < \delta$ . Notice that

$$m(q-1) - (\nu+1) = \begin{cases} (q-1)Q + R - 1, & R \geq 1, \\ (q-1)(Q-1) + q - 2, & R = 0 \end{cases}$$

with  $R$  and  $Q$  as given in the hypothesis. Therefore, the distance  $d^*(\nu+1)$  of  $\mathcal{R}_q^*(\nu+1, m)$  is given by

$$d^*(\nu+1) = \begin{cases} (\lceil (\delta+1)/q^Q \rceil - 1)q^Q - 1 & \text{for } R \geq 1, \\ (q-1)q^{Q-1} - 1 & \text{for } R = 0. \end{cases}$$

In both cases, it is straightforward to verify that  $d^*(\nu+1) < \delta$ .  $\square$

Explicitly determining the puncture code is a challenging task. For the duals of BCH codes, we are able to determine large subcodes of the puncture code.

**Theorem IV.19.** *If  $\delta < q^{\lfloor m/2 \rfloor} - 1$ , then  $\mathcal{R}_q^*(\mu, m) \subseteq P_e(\text{BCH}_q^m(\delta)^\perp)$  for all orders  $\mu$  in the range  $0 \leq \mu \leq m(q-1) - 2(R + (q-1)Q) + 1$  with  $Q = \lfloor \log_q(\delta + 1) \rfloor$  and  $R = \lceil (\delta + 1)/q^Q \rceil - 1$ .*

*Proof.* By Lemma IV.18, we have  $\mathcal{R}_q^*(\nu, m) \subseteq \text{BCH}_q^m(\delta)$  for  $\nu = (m - Q)(q - 1) - R$ ; hence,  $\text{BCH}_q^m(\delta)^\perp \subseteq \mathcal{R}_q^*(\nu, m)^\perp$ . It follows from the definition of the puncture code that  $P_e(\text{BCH}_q^m(\delta)^\perp) \supseteq P_e(\mathcal{R}_q^*(\nu, m)^\perp)$ . However,

$$\begin{aligned} P_e(\mathcal{R}_q^*(\nu, m)^\perp) &= \{evf \cdot evg \mid f, g \in L_m^*(\nu^\perp)\}^\perp, \\ &\supseteq \{evf \mid f \in L_m^*(2\nu^\perp)\}^\perp, \\ &= \mathcal{R}_q^*((2\nu^\perp)^\perp, m), \end{aligned}$$

where the last equality follows from equation (4.4). This is meaningful only if  $(2\nu^\perp)^\perp \geq 0$  or, equivalently, if  $\nu \geq (m(q-1) - 1)/2$ . Since  $\delta < q^{\lfloor m/2 \rfloor} - 1$ , it follows that  $Q \leq \lfloor m/2 \rfloor - 1$ , and the order  $\nu$  satisfies

$$\begin{aligned} \nu &= (m - Q)(q - 1) - R \geq \lceil m/2 + 1 \rceil (q - 1) - R \\ &\geq \lceil m/2 \rceil (q - 1) + 1 \geq (m(q - 1) - 1)/2, \end{aligned}$$

as required. Since  $\mathcal{R}_q^*(\mu, m) \subseteq \mathcal{R}_q^*((2\nu^\perp)^\perp, m)$  for  $0 \leq \mu \leq (2\nu^\perp)^\perp$ , we have  $\mathcal{R}_q^*(\mu, m) \subseteq P_e(\text{BCH}_q^m(\delta)^\perp)$ .  $\square$

Unfortunately, the weight distribution of generalized cyclic Reed-Muller codes is not known, see [38]. However, we know that the puncture code of  $\text{BCH}_q^m(\delta)^\perp$  contains the codes  $\mathcal{R}_q^*(0, m) \subseteq \mathcal{R}_q^*(1, m) \subseteq \dots \subseteq \mathcal{R}_q^*(m(q-1) - 2(R + (q-1)Q) + 1, m)$ , so it must contain codewords of the respective minimum distances.

**Corollary IV.20.** *If  $\delta$  and  $\mu$  are integers in the range  $2 \leq \delta < q^{\lfloor m/2 \rfloor} - 1$  and  $0 \leq \mu \leq m(q-1) - 2(R + (q-1)Q) + 1$ , where  $Q = \lfloor \log_q(\delta + 1) \rfloor$  and  $R = \lceil (\delta + 1)/q^Q \rceil - 1$ ,*

then there exists a

$$[[d^*(\mu), \geq d^*(\mu) - 2m\lceil(\delta - 1)(1 - 1/q)\rceil, \geq \delta]]_q$$

stabilizer code of length  $d^*(\mu) = (\rho + 1)q^\sigma - 1$ , where  $\sigma$  and  $\rho$  satisfy the relations  $m(q - 1) - \mu = (q - 1)\sigma + \rho$  and  $0 \leq \rho < q - 1$ .

*Proof.* If  $2 \leq \delta < q^{\lfloor m/2 \rfloor} - 1$ , then from Theorem IV.14 we know that there exists an  $[[q^m - 1, q^m - 1 - 2m\lceil(\delta - 1)(1 - 1/q)\rceil, \geq \delta]]_q$  quantum code. From Lemma IV.19 we know that  $P_e(\text{BCH}_q^m(\delta)^\perp) \supseteq \mathcal{R}_q^*(\mu, m)$ , where  $0 \leq \mu \leq m(q - 1) - 2(q - 1)Q - 2R + 1$ . By Theorem III.42, if there exists a vector of weight  $r$  in  $P_e(\text{BCH}_q^m(\delta)^\perp)$ , the corresponding quantum code can be punctured to give  $[[r, \geq r - 2m\lceil(\delta - 1)(1 - 1/q)\rceil, d \geq \delta]]_q$ . The minimum distance of  $\mathcal{R}_q^*(\mu, m)$  is  $d^*(\mu) = (\rho + 1)q^\sigma - 1$ , where  $0 \leq \rho < q - 1$  [80, Theorem 5]. Hence, it is always possible to puncture the quantum code to  $[[d^*(\mu), \geq d^*(\mu) - 2m\lceil(\delta - 1)(1 - 1/q)\rceil, \geq \delta]]_q$ .  $\square$

It is also possible to puncture quantum codes constructed via classical codes self-orthogonal with respect to the Hermitian inner product. Examples of such puncturing can be found in [71] and [134].

### C. MDS Codes

A quantum code that attains the quantum Singleton bound is called a quantum Maximum Distance Separable code or quantum MDS code for short. These codes have received much attention, but many aspects have not yet been explored in the quantum case (but see [71, 126]). In this section we study the maximal length of MDS stabilizer codes.

An interesting result concerning the purity of quantum MDS codes was derived by Rains [126, Theorem 2]:

**Lemma IV.21** (Rains). *An  $[[n, k, d]]_q$  quantum MDS code with  $k \geq 1$  is pure up to  $n - d + 2$ .*

**Corollary IV.22.** *All quantum MDS codes are pure.*

*Proof.* An  $[[n, k, d]]_q$  quantum MDS code with  $k = 0$  is pure by definition; if  $k \geq 1$  then it is pure up to  $n - d + 2$ . By the quantum Singleton bound  $n - 2d + 2 = k \geq 0$ ; thus,  $n - d + 2 \geq d$ , which means that the code is pure.  $\square$

**Lemma IV.23.** *For any  $[[n, n - 2d + 2, d]]_q$  quantum MDS stabilizer code with  $n - 2d + 2 > 0$ , the corresponding classical codes  $C \subseteq C^{\perp_a}$  are also MDS.*

*Proof.* If an  $[[n, n - 2d + 2, d]]_q$  stabilizer code exists, then Theorem III.15 implies the existence of an additive  $[n, d - 1]_{q^2}$  code  $C$  such that  $C \subseteq C^{\perp_a}$ . Corollary IV.22 shows that  $C^{\perp_a}$  has minimum distance  $d$ , so  $C^{\perp_a}$  is an  $[n, n - d + 1, d]_{q^2}$  MDS code. By Lemma IV.21, the minimum distance of  $C$  is  $\geq n - d + 2$ , so  $C$  is an  $[n, d - 1, n - d + 2]_{q^2}$  MDS code.  $\square$

A classical  $[n, k, d]_q$  MDS code is said to be trivial if  $k \leq 1$  or  $k \geq n - 1$ . A trivial MDS code can have arbitrary length, but a nontrivial one cannot. The next lemma is a straightforward generalization from linear to additive MDS codes.

**Lemma IV.24.** *Assume that there exists a classical additive  $(n, q^k, d)_q$  MDS code  $C$ .*

- (i) *If the code is trivial, then it can have arbitrary length.*
- (ii) *If the code is nontrivial, then its code parameters must be in the range  $2 \leq k \leq \min\{n - 2, q - 1\}$  and  $n \leq q + k - 1 \leq 2q - 2$ .*

*Proof.* The first statement is obvious. For (ii), we note that the weight distribution of the code  $C$  and its dual are related by the MacWilliams relations. The proof given in [107, p. 320-321] for linear codes applies without change, and one finds that the number of codewords of weight  $n - k + 2$  in  $C$  is given by

$$A_{n-k+2} = \binom{n}{k-2} (q-1)(q-n+k-1).$$

Since  $A_{n-k+2}$  must be a nonnegative number, we obtain the claim.  $\square$

We say that a quantum  $[[n, k, d]]_q$  MDS code is trivial if and only if its minimum distance  $d \leq 2$ . The length of trivial quantum MDS codes is not bounded, but the length of nontrivial ones is, as the next lemma shows.

**Theorem IV.25** (Maximal Length of MDS Stabilizer Codes). *A nontrivial  $[[n, k, d]]_q$  MDS stabilizer code satisfies the following constraints:*

- i) *its length  $n$  is in the range  $4 \leq n \leq q^2 + d - 2 \leq 2q^2 - 2$ ;*
- ii) *its minimum distance satisfies  $\max\{3, n - q^2 + 2\} \leq d \leq \min\{n - 1, q^2\}$ .*

*Proof.* By definition, a quantum MDS code attains the Singleton bound, so  $n - 2d + 2 = k \geq 0$ ; hence,  $n \geq 2d - 2$ . Therefore, a nontrivial quantum MDS code satisfies  $n \geq 2d - 2 \geq 4$ .

By Lemma IV.23, the existence of an  $[[n, n - 2d + 2, d]]_q$  stabilizer code implies the existence of classical MDS codes  $C$  and  $C^{\perp_a}$  with parameters  $[n, d - 1, n - d + 2]_{q^2}$  and  $[n, n - d + 1, d]_{q^2}$ , respectively. If the quantum code is a nontrivial MDS code, then the associated classical codes are nontrivial classical MDS codes. Indeed, for  $n \geq 4$  the quantum Singleton bound implies  $d \leq (n + 2)/2 \leq (2n - 2)/2 = n - 1$ , so  $C$  is a nontrivial classical MDS code.

By Lemma IV.24, the dimension of  $C$  satisfies the constraints  $2 \leq d - 1 \leq \min\{n - 2, q^2 - 1\}$ , or equivalently  $3 \leq d \leq \min\{n - 1, q^2\}$ . Similarly, the length  $n$  of  $C$  satisfies  $n \leq q^2 + (d - 1) - 1 \leq 2q^2 - 2$ . If we combine these inequalities then we get our claim.  $\square$

**Example IV.26.** *The length of a nontrivial binary MDS stabilizer code cannot exceed  $2q^2 - 2 = 6$ . In [35] the nontrivial MDS stabilizer codes for  $q = 2$  were found to be  $[[5, 1, 3]]_2$  and  $[[6, 0, 4]]_2$ , so there cannot exist further nontrivial MDS stabilizer codes.*

In [71], the question of the maximal length of MDS codes was raised. All MDS stabilizer codes provided in that reference had a length of  $q^2$  or less; this prompted us

to look at the following famous conjecture for classical codes (cf. [76, Theorem 7.4.5] or [107, pages 327-328]).

**MDS Conjecture.** *If there is a nontrivial  $[n, k]_q$  MDS code, then  $n \leq q + 1$  except when  $q$  is even and  $k = 3$  or  $k = q - 1$  in which case  $n \leq q + 2$ .*

If the MDS conjecture is true (and much supporting evidence is known), then we can improve upon the result of Theorem IV.25.

**Corollary IV.27.** *If the classical MDS conjecture holds, then there are no nontrivial MDS stabilizer codes of lengths exceeding  $q^2 + 1$  except when  $q$  is even and  $d = 4$  or  $d = q^2$  in which case  $n \leq q^2 + 2$ .*

#### D. Conclusions

In this chapter we applied the theory developed in Chapter III to derive classes of quantum codes. This work has also led to the construction of many more families of codes. The interested reader can find the details in [8]. Table II gives an overview and summarizes the main parameters of these families. We also illustrated the theory of puncture codes by deriving new codes from quantum BCH codes. One central theme in quantum error-correction is the construction of codes that have a large minimum distance. We were able to show that the length of an MDS stabilizer code over  $\mathbb{F}_q$  cannot exceed  $q^2 + 1$ , except in a few sporadic cases, assuming that the classical MDS conjecture holds. An open problem is whether the length  $n$  of a  $q$ -ary quantum MDS code is bounded by  $q^2 + 1$  for all but finitely many  $n$ . Another related problem is to construct analytically quantum MDS codes between lengths  $q$  and  $q^2$ . Currently, constructions are known only for a few lengths in this range.



Table II. A compilation of known families of quantum codes

Family	$[[n, k, d]]_q$	Purity	Parameter Ranges and References
Short MDS	$[[n, n - 2d + 2, d]]_q$	pure	$2 \leq d \leq \lceil n/2 \rceil, q^2 - 1 \geq \binom{n}{d}$
Hermitian Hamming	$[[n, n - 2m, 3]]_q$	pure	$m \geq 2, \gcd(m, q^2 - 1) = 1, n = (q^{2m} - 1)/(q^2 - 1)$
Euclidean Hamming	$[[n, n - 2m, 3]]_q$	pure	$m \geq 2, \gcd(m, q - 1) = 1, n = (q^m - 1)/(q - 1)$
Quadratic Residue I	$[[n, 1, d]]_q$	pure	$n$ prime, $n \equiv 3 \pmod{4}, q \not\equiv 0 \pmod{n}$ $q$ is a quadratic residue modulo $n, d^2 - d + 1 \geq n$
Quadratic Residue II	$[[n, 1, d]]_q$	pure	$n$ prime, $n \equiv 1 \pmod{4}, q \not\equiv 0 \pmod{n}$ $q$ is a quadratic residue modulo $n, d \geq \sqrt{n}$
Melas	$[[n, n - 4m, \geq 3]]_q$	pure	$q$ even, $n = q^{2m} - 1$ , Pure to 3
Euclidean BCH	$[[n, n - 2m\lceil(\delta - 1)(1 - 1/q)\rceil, \geq \delta]]_q$	pure to $\delta$	$2 \leq \delta \leq q^{\lceil m/2 \rceil} - 1 - (q - 2)[m \text{ odd}]$ $n = q^m - 1$ and $m \geq 2$
Punctured BCH	$[[d^*(\mu), \geq d^*(\mu) - 2m\lceil(\delta - 1)(1 - 1/q)\rceil, \geq \delta]]_q$	pure?	$\delta < q^{\lceil m/2 \rceil} - 1$ , See Corollary IV.20
Hermitian BCH	$[[n, n - 2m\lceil(\delta - 1)(1 - 1/q^2)\rceil, \geq \delta]]_q$	pure	$2 \leq \delta \leq q^m - 1, n = q^{2m} - 1$ , Pure to $\delta$
Extended BCH	$[[n + 1, n - 2m\lceil(\delta - 1)(1 - 1/q^2)\rceil - 1, \geq \delta + 1]]_q$	pure	Pure to $\delta + 1$
Trivial MDS	$[[n, n - 2, 2]]_q$ $[[n, n, 1]]_q$	pure pure	$n \equiv 0 \pmod{p}$ $n \geq 1$
Character	$[[n, k(r_2) - k(r_1), \min\{2^{m-r_2}, 2^{r_1+1}\}]]_q$	pure	$n = 2^m, q$ odd, $0 \leq r_1 < r_2 \leq m, k(r) = \sum_{j=0}^r \binom{m}{j}$
CSS GRM	$[[q^m, k(\nu_2) - k(\nu_1), \min\{d(\nu_2), d(\nu_1^\perp)\}]]_q$ $0 \leq \nu_1 \leq \nu_2 \leq m(q - 1) - 1$	pure	$k(\nu) = \sum_{j=0}^m (-1)^j \binom{m}{j} \binom{m+\nu-jq}{\nu-jq}, \nu^\perp = m(q - 1) - \nu - 1$ $\nu^\perp + 1 = (q - 1)Q + R, d(\nu) = (R + 1)q^Q$
Punctured GRM	$[[d(\mu), \geq k(\nu_2) - k(\nu_1) - (n - d(\mu)), \geq d]]_q$	pure?	$d \geq \min\{d(\nu_2), d(\nu_1^\perp)\}, 0 \leq \mu \leq \nu_2 - \nu_1$ ; [134]
Hermitian GRM	$[[q^{2m}, q^{2m} - 2k(\nu), d(\nu^\perp)]]_q$ $0 \leq \nu \leq m(q - 1) - 1$	pure	$k(\nu) = \sum_{j=0}^m (-1)^j \binom{m}{j} \binom{m+\nu-jq^2}{\nu-jq^2}, \nu^\perp = m(q^2 - 1) - \nu - 1$ $\nu^\perp + 1 = (q^2 - 1)Q + R, d(\nu) = (R + 1)q^{2Q}$
Punctured GRM	$[[d(\mu^\perp), \geq d(\mu^\perp) - 2k(\nu), \geq d(\nu^\perp)]]_q$	pure?	$(\nu + 1)q \leq \mu \leq m(q^2 - 1) - 1$ ; [134]
Punctured MDS	$[[q^2 - q\alpha, q^2 - q\alpha - 2\nu - 2, \nu + 2]]_q$	pure	$0 \leq \nu \leq q - 2, 0 \leq \alpha \leq q - \nu - 1$ ; [134]
Euclidean MDS	$[[n, n - 2d + 2, d]]_q$	pure	$3 \leq n \leq q, 1 \leq d \leq n/2 + 1$ ; [73]
Hermitian MDS	$[[q^2 - s, q^2 - s - 2d + 2, d]]_q$	pure	$1 \leq d \leq q, s = 0, 1$ ; [73]
Twisted	$[[q^2 + 1, q^2 - 3, 3]]_q$	pure?	[28]
Extended Twisted	$[[q^r, q^r - r - 2, 3]]_q$ $[[n, n - r - 2, 3]]_q$	pure pure	$r \geq 2$ ; [28] $n = (q^{r+2} - q^3)/(q^2 - 1), r \geq 1, r$ odd; [28]
Perfect	$[[n, n - r - 2, 3]]_q$	pure	$n = (q^{r+2} - 1)/(q^2 - 1), r \geq 2, r$ even; [28]

## CHAPTER V

## SUBSYSTEM CODES – BEYOND STABILIZER CODES\*

In this chapter we study a recent generalization of quantum codes that unifies many apparently disparate notions of quantum error correction. This generalization called operator quantum error correction gathers within its framework both passive and active error correction schemes, among them decoherence free subspaces (DFS), noiseless subsystems (NS), and standard quantum error-correcting codes (including stabilizer codes which formed the main theme of the last two chapters). Our main contribution in this chapter is to provide a natural construction of such codes in terms of Clifford codes, an elegant generalization of stabilizer codes due to Knill. Character-theoretic methods are used to derive a simple method to construct operator quantum error-correcting codes from any classical additive code over a finite field, which obviates the need for self-orthogonal codes. In view of its importance and also to better appreciate our contribution we shall spend a little time reviewing operator quantum error correction. The following review summarizes the key points of [99, 100] relevant for our discussion. A quick word about the nomenclature. These codes were originally studied in the context of operator algebras and hence, were named operator quantum error correcting codes. We shall often use the descriptive term subsystem codes in view of brevity. Both will be used interchangeably.

*Notation.* If  $N$  is a group, then  $Z(N)$  denotes the center of  $N$ . We denote by  $\text{Irr}(N)$  the set of irreducible characters of  $N$ . If  $\chi$  and  $\psi$  are characters of  $N$ , then  $(\chi, \psi)_N = |N|^{-1} \sum_{n \in N} \chi(n)\psi(n^{-1})$  defines a scalar product on the vector space of class functions on  $N$ , and  $\text{Irr}(N)$  is an orthonormal basis of this space. We denote by  $\text{supp}(\chi) = \{n \in N \mid \chi(n) \neq 0\}$ . If  $\chi \in \text{Irr}(N)$ , then  $Z(\chi) = \{n \in N \mid \chi(1) = |\chi(n)|\}$  denotes the quasikernel of  $\chi$ . Suppose that  $G$  is a group that

---

\*Part of the material in this chapter has been submitted to IEEE and currently under review. Copyright maybe transferred to IEEE.

contains  $N$  as a subgroup. If  $\phi \in \text{Irr}(G)$ , then  $\phi_N$  denotes the restriction of this character to  $N$ . If  $x, y \in N$ , then  $[x, y] = x^{-1}y^{-1}xy$  is the commutator. If  $A$  and  $B$  are subgroups of a group, then  $[A, B] = \langle [a, b] \mid a \in A \text{ and } b \in B \rangle$  is the commutator subgroup of  $A$  and  $B$ . In particular,  $N' = [N, N]$  denotes the derived subgroup of  $N$ . The reader can find background material on finite groups in [131] and on character theory in [78]. As usual let  $\mathcal{H}$  be the system Hilbert space under consideration. Let  $\mathcal{B}(\mathcal{H})$  denote bounded linear operators on  $\mathcal{H}$ .

### A. Review of Operator Quantum Error Correction

The class of codes which we considered in the last two chapters come within the framework of a model often called the standard model. Mathematically, this model is defined as a triple  $(\mathcal{R}, \mathcal{E}, \mathcal{C})$ , where  $\mathcal{E}$  is the quantum channel,  $\mathcal{C}$  a subspace of  $\mathcal{H}$  and  $\mathcal{R}$  a recovery operation. Additionally, we define a projector  $P$  onto the codespace  $\mathcal{C}$ , thus  $\mathcal{C} = P\mathcal{H}$ . For any density operator  $\rho$  supported by  $\mathcal{C}$  *i.e.*  $\rho \in \mathcal{B}(\mathcal{C})$  or equivalently  $\rho = P\rho P$ , the triple satisfies the following relation:

$$(\mathcal{R} \circ \mathcal{E})(\rho) = \rho \text{ for all } \rho = P\rho P. \quad (5.1)$$

As we can see the standard model assumes a recovery operation  $\mathcal{R}$ . In general  $\mathcal{R}$  is nontrivial which in turn implies some form of active monitoring of the encoded quantum information in order to detect and correct the errors that occur. An alternative approach is to rely on passive error correction mechanisms, exemplified by decoherence free subspaces and noiseless subsystems.

If we want to avoid performing active error correction, we are naturally led to the idea that the encoded states should not be affected by the channel. In other words, we must encode into  $\text{Fix}(\mathcal{E})$ , the fixed points of  $\mathcal{E}$  where

$$\text{Fix}(\mathcal{E}) = \{\rho \in \mathcal{B}(\mathcal{H}) \mid \mathcal{E}(\rho) = \rho\}.$$

These fixed points can be nicely characterized for a certain class of quantum channels. Given a quantum channel  $\mathcal{E}$ , we can write the channel in terms of its Kraus operators as follows

$$\mathcal{E}(\rho) = \sum_i E_i \rho E_i^\dagger. \quad (5.2)$$

Because of this decomposition we often write the channel  $\mathcal{E} = \{E_i, E_i^\dagger\}$ . When the quantum channels satisfy the condition

$$\sum_i E_i E_i^\dagger = I, \quad (5.3)$$

we have a convenient way to characterize the fixed points. Channels satisfying equation (5.3) are called unital channels. Let  $\rho E_i = E_i \rho$  for any  $E_i$ . Then under the unital assumption all such  $\rho$  are fixed points of  $\mathcal{E}$  as

$$\mathcal{E}(\rho) = \sum_i E_i \rho E_i^\dagger = \rho \sum_i E_i E_i^\dagger = \rho. \quad (5.4)$$

We denote by  $\mathcal{A}$ , the matrix polynomials generated by  $\{E_i, E_i^\dagger\}$  *i.e.*, the algebra generated by  $\{E_i, E_i^\dagger\}$ . This is called the *interaction algebra* in the literature. The *noise commutant*  $\mathcal{A}'$  is defined as

$$\mathcal{A}' = \left\{ \rho \in \mathcal{B}(\mathcal{H}) \mid \rho E = E \rho \text{ for any } E \in \{E_i, E_i^\dagger\} \right\}. \quad (5.5)$$

From equation (5.4), it follows that  $\mathcal{A}' \subseteq \text{Fix}(\mathcal{E})$ . In fact, for unital channels it was shown that  $\text{Fix}(\mathcal{E}) = \mathcal{A}'$ . Using results on  $\mathbb{C}^*$  algebras, Kribs *et al.*, showed that the interaction algebra has a representation of the form

$$\mathcal{A} \cong \bigoplus_j I_{K_j} \otimes \mathcal{B}(\mathcal{H}_j^B) \cong \bigoplus_j I_{K_j} \otimes M_{R_j}, \quad (5.6)$$

where  $M_{R_j}$  is  $R_j$ -dimensional matrix algebra (over  $\mathbb{C}$ ). This representation induces the

following structure on  $\mathcal{H}$

$$\mathcal{H} \cong \bigoplus_j \mathcal{H}_j^A \otimes \mathcal{H}_j^B, \quad (5.7)$$

where  $\dim \mathcal{H}_j^A = K_j$  and  $\dim \mathcal{H}_j^B = R_j$ . Since  $\mathcal{E}$  (and  $\mathcal{A}$ ) act trivially on  $\mathcal{H}_j^A$ , the subsystems  $\mathcal{H}_j^A$  are called noiseless subsystems. To simplify matters we usually encode into only one subsystem, which gives us the following decomposition

$$\mathcal{H} = \mathcal{C} \oplus \mathcal{C}^\perp = (\mathcal{H}^A \otimes \mathcal{H}^B) \oplus \mathcal{C}^\perp, \quad (5.8)$$

where  $\mathcal{C}^\perp$  is the complement of  $\mathcal{C}$ . Let  $\dim \mathcal{H}^A = K$  and  $\dim \mathcal{H}^B = R$ . Then  $\dim \mathcal{C} = KR$  and  $\dim \mathcal{C}^\perp = \dim \mathcal{H} - KR$ . Let us denote operators in  $\mathcal{B}(\mathcal{H}^A)$  and  $\mathcal{B}(\mathcal{H}^B)$  as  $\rho^A$  and  $\rho^B$  respectively. The (standard) noiseless subsystem given by  $\mathcal{C}$  consists of operators in  $\mathcal{B}(\mathcal{H}^A \otimes \mathcal{H}^B)$  that are of the form  $\mathcal{B}(\mathcal{H}^A) \otimes I_R$  in other words  $\rho^A \otimes I_R$ . In this case the co-subsystem  $B$  is in the maximally mixed state. The codespace  $\mathcal{C}$  is an algebra of operators. Decoherence free subspaces are noiseless subsystems with the dimension of the co-subsystem equal to one. In this case the codespace  $\mathcal{C}$  is a subspace of  $\mathcal{H}$ .

One of the insights of [99] was that we can relax the constraint that the co-subsystem  $B$  should be in the maximally mixed state. This led to the idea of generalized noiseless subsystems. In this case the noiseless subsystem code is given by the operators in  $\mathcal{B}(\mathcal{H})$  that are of the form  $(\rho^A \otimes \rho^B)$ . Comparing with equation (5.6) we can see that in this case we are not always encoding into the fixed points of  $\mathcal{E}$ . The codespace instead of being an algebra of operators is now a monoid<sup>†</sup> of operators of the form  $\rho^A \otimes \rho^B$ . Given a decomposition of  $\mathcal{H} = \mathcal{H}^A \otimes \mathcal{H}^B \oplus \mathcal{C}^\perp$  and orthonormal bases  $\{|\alpha_i\rangle\}_{i=1}^n$ , and  $\{|\beta_j\rangle\}_{j=1}^m$

---

<sup>†</sup>In [99], they refer to  $\mathcal{C}$  as a semigroup even though  $\mathcal{C}$  is equipped with identity.

for  $\mathcal{H}^A$  and  $\mathcal{H}^B$  respectively, we define a projector onto  $\mathcal{C} = \mathcal{H}^A \otimes \mathcal{H}^B = P\mathcal{H}$  as

$$P = \mathbf{1}^{AB} = \mathbf{1}^A \otimes \mathbf{1}^B = \left( \sum_i |\alpha_i\rangle \langle \alpha_i| \right) \otimes \left( \sum_j |\beta_j\rangle \langle \beta_j| \right). \quad (5.9)$$

The action of  $P$  on  $\rho$  is defined as  $P\rho P$ . Then a generalized noiseless subsystem is defined as follows, see [99, Lemma 2].

**Lemma V.1** (Generalized noiseless subsystems [99]). *Given a fixed decomposition of  $\mathcal{H} = \mathcal{H}^A \otimes \mathcal{H}^B \oplus \mathcal{C}^\perp$  and a CPTP map  $\mathcal{E}$ , define  $\mathcal{C} = \{\rho \in \mathcal{B}(\mathcal{H}) \mid \rho = \rho^A \otimes \rho^B\}$ . Then the following conditions are equivalent and define a generalized noiseless subsystem  $\mathcal{H}^A$ .*

- i)  $\mathcal{E}(\rho^A \otimes \rho^B) = \rho^A \otimes \sigma^B$ , for all  $\rho^A \otimes \rho^B \in \mathcal{C}$  and some  $\sigma^B$ .
- ii)  $\mathcal{E}(\rho^A \otimes I_B) = \rho^A \otimes \sigma^B$ , for all  $\rho^A \otimes I_B \in \mathcal{C}$  and some  $\sigma^B$ .
- iii)  $(\text{Tr}_A \circ P \circ \mathcal{E})(\rho) = \text{Tr}_A(\rho)$ , for all  $\rho \in \mathcal{C}$ .

Kribs *et al.*, [99, 100] generalized these ideas further by incorporating active error correction also on the subsystem  $A$ . As in the standard model we now define a recovery operation  $\mathcal{R}$ , that restores the subsystem  $B$  after the error. The definition is as follows.

**Lemma V.2** (Operator quantum error correcting codes [99]). *Given a fixed decomposition of  $\mathcal{H} = \mathcal{H}^A \otimes \mathcal{H}^B \oplus \mathcal{K}$  and a CPTP map  $\mathcal{E}$ , define  $\mathcal{C} = \{\rho \in \mathcal{B}(\mathcal{H}) \mid \rho = \rho^A \otimes \rho^B\}$ . Then the following conditions are equivalent and define an operator quantum error correcting code  $\mathcal{C}$  with recovery operation  $\mathcal{R}$ .*

- i)  $\mathcal{R} \circ \mathcal{E}(\rho^A \otimes \rho^B) = \rho^A \otimes \sigma^B$ , for all  $\rho^A \otimes \rho^B \in \mathcal{C}$  and some  $\sigma^B$
- ii)  $\mathcal{R} \circ \mathcal{E}(\rho^A \otimes I_B) = \rho^A \otimes \sigma^B$ , for all  $\rho^A \otimes I_B \in \mathcal{C}$  and some  $\sigma^B$
- iii)  $(\text{Tr}_A \circ P \circ \mathcal{R} \circ \mathcal{E})(\rho) = \text{Tr}_A(\rho)$ , for all  $\rho \in \mathcal{C}$ .

We are often more interested in a simple condition that identifies correctable errors for a given channel  $\mathcal{E} = \{E_a, E_a^\dagger\}$  or equivalently, the detectable errors for a given subspace in  $\mathcal{H}$ . Recall that if a code corrects the set of errors in  $\Sigma = \{E_a\}$ , it detects all the errors in the algebra  $\Sigma_D = \{E_a^\dagger E_b \mid E_a, E_b \in \Sigma\}$ .

**Theorem V.3** ([99, 115]). *Let  $\mathcal{H} = \mathcal{H}^A \otimes \mathcal{H}^B \oplus \mathcal{K}$  and  $P = \mathbf{1}^A \otimes \mathbf{1}^B$  be a projector onto  $\mathcal{C} = \mathcal{H}^A \otimes \mathcal{H}^B = P\mathcal{H}$ . Then an error  $E$  is detectable by the operator quantum error correcting code  $\mathcal{C}$  if and only if*

$$PEP = \mathbf{1}^A \otimes \rho_E^B \text{ for some } \rho_E^B \in \mathcal{B}(\mathcal{H}^B). \quad (5.10)$$

Now that we have reviewed the salient ideas of operator quantum error correction, we will address a very important question – how do we systematically construct these codes? Two important contributions in this direction were the introduction of a stabilizer formalism and the notion of a gauge group by Poulin [120], and construction of a class of subsystem codes capable of encoding one qubit by Bacon [18]. However the bigger question of systematic construction of good subsystem codes still remained open. Our work addresses this problem in more detail. Subsequent to the publication of this work, Bacon and Cassacino independently proposed a class of subsystem codes [19]; these codes can be viewed as a special case of the codes constructed in this chapter. More details on these codes will be given in Chapter VI.

Our approach is based on an elegant formalism to construct quantum error-correcting codes that has been introduced in 1996 by Knill as a generalization of the stabilizer code concept. At the heart of this quantum code construction is a famous theorem by Clifford concerning the restriction of irreducible representations of finite groups to normal subgroups, so these codes were termed as “Clifford codes” in [88, 89], although “Knill codes” is perhaps a more appropriate name. Unexpectedly, it turned out that Clifford codes are in many cases stabilizer codes, so this construction did not become as widely known.

In our approach, we construct a Clifford code  $C$  and give conditions that ensure that this code decomposes into a tensor product  $C = A \otimes B$ . The Clifford codes allow us to control the dimensions of  $A$  and  $B$ , and we get a simple characterization of the detectable errors of the operator quantum error-correcting code. Since there may exist many different

ways to construct the same Clifford code  $C$ , we should note that these constructions can lead to different tensor product decompositions. In fact, even if one is just interested in the tensor decomposition of a stabilizer code  $C$ , then the Clifford codes can provide a natural way to induce an operator quantum error-correcting code on  $C$ .

## B. A Detour Through Clifford Codes

As we have seen in the previous sections and in Chapter III, the study of quantum codes is related to the operators acting on the system Hilbert space. To simplify matters we can restrict our attention to a basis of these operators and the group generated by that basis, called the error group. In the binary case we deal with the familiar Pauli matrices and the group generated by them on  $n$  qubits. Knill generalized this concept by introducing the notion of nice error bases and abstract error groups which generalize the Pauli error group. We have already seen one application of this generalization in Chapter III, where we dealt with the generalization of the Pauli group to nonbinary alphabet. The benefit of the abstract approach is that it will free us from having to deal with cumbersome matrix operators but instead work with groups. The representations of the groups (in  $\mathcal{H}$ ) will bring us back to the concrete world of operators. In this chapter, we shall pursue this abstract approach permitting different error groups other than the Pauli error group. We say that a finite group  $E$  is an abstract error group if it has a faithful irreducible unitary representation  $\rho$  of degree  $d = |E : Z(E)|^{1/2}$ . The irreducibility of the representation ensures that one can express any error acting on  $\mathbb{C}^d$  as a linear combination of the matrices  $\rho(g)$ , with  $g \in E$ . The fact that the representation is faithful and has the largest possible degree ensures that the set of matrices  $\{\rho(g) \mid g \in T\}$ , where  $T$  is a set of representatives of  $E/Z(E)$ , forms a *basis* of the vector space of  $d \times d$  matrices.

A Clifford code is constructed with the help of a normal subgroup  $N$  of the error group



$E$  and an irreducible character  $\chi$  of  $N$ . Let  $\phi$  denote the irreducible character corresponding to the representation  $\rho$  of the group  $E$ , that is,  $\phi(g) = \text{Tr } \rho(g)$  for  $g \in E$ . Suppose that  $N$  is a normal subgroup of  $E$  and that  $\chi$  is an irreducible character of  $N$  such that  $(\chi, \phi_N)_N > 0$ .

**Definition V.4** (Clifford codes). *A Clifford code  $C$  corresponding to  $(E, \rho, N, \chi)$  is defined as the image of the orthogonal projector*

$$P = \frac{\chi(1)}{|N|} \sum_{n \in N} \chi(n^{-1}) \rho(n),$$

see [88, Theorem 1].

We emphasize that if we refer to a Clifford code with data  $(E, \rho, N, \chi)$ , then it is assumed that  $(\chi, \phi_N) > 0$ , as this condition ensures that  $\dim C > 0$ . Recall that an error  $e$  in  $E$  is detectable by the (Clifford) quantum code  $C$  if and only if  $P\rho(e)P = \lambda_e P$  holds for some  $\lambda_e \in \mathbb{C}$ .

The image of  $P$  is the homogeneous component that consists of the direct sum of all irreducible  $\mathbb{C}N$ -submodules with character  $\chi$  that are contained in the restriction of  $\rho$  to  $N$ . The elements  $e$  in  $E$  that satisfy  $\rho(e)C = C$  form a group known as the inertia group  $I_E(\chi) = \{g \in E \mid \chi(gxg^{-1}) = \chi(x) \text{ for all } x \in N\}$ . We note that  $C$  is an irreducible  $\mathbb{C}[I_E(\chi)]$ -module. Let  $\vartheta$  be the irreducible character corresponding to this module.

**Fact V.5.** *Let  $C$  be a Clifford code with data  $(E, \rho, N, \chi)$ . Then the dimension of the code is given by  $\dim C = |Z(E) \cap N| |E : Z(E)|^{1/2} \chi(1)^2 / |N|$ . An error  $e$  in  $E$  can be detected by  $C$  if and only if  $e$  is in  $E - (I_E(\chi) - Z(\vartheta))$ .*

For a proof of this fact see [88] and for more background on Clifford codes see [89] and the seminal papers [92, 93].

### C. Constructing Operator Quantum Error-Correcting Codes

We are now concerned with the construction of a decomposition of the Hilbert space  $\mathcal{H}$  in the form

$$\mathcal{H} = (A \otimes B) \oplus C^\perp.$$

Put differently, we seek a decomposition of the Clifford code  $C$  as a tensor product  $A \otimes B$ .

The next theorem gives a construction of operator quantum error-correcting codes when one can express the inertia group  $I_E(\chi)$  as a central product  $I_E(\chi) = LN$ , where  $L$  is a subgroup of  $E$  such that  $[L, N] = 1$ .

**Theorem V.6.** *Suppose that  $C$  is a Clifford code with data  $(E, \rho, N, \chi)$ . If the inertia group  $I_E(\chi)$  is of the form  $I_E(\chi) = LN$ , where  $L$  is a subgroup of  $E$  such that  $[L, N] = 1$ , then  $C$  is an operator quantum error-correcting code  $C = A \otimes B$  such that*

- i)  $\dim A = |Z(E) \cap N| |E : Z(E)|^{1/2} \chi(1) / |N|$ ,
- ii)  $\dim B = \chi(1)$ .

*The subsystem  $A$  is an irreducible  $\mathbb{C}L$ -module with character  $\chi_A \in \text{Irr}(L)$ . An error  $e$  in  $E$  is detectable by subsystem  $A$  if and only if  $e$  is contained in the set  $E - (I_E(\chi) - Z(\chi_A)N)$ .*

*Proof.* Since the Clifford code  $C$  is an irreducible  $\mathbb{C}[I_E(\chi)]$ -module and  $I_E(\chi) = LN$ , with  $[L, N] = 1$ , there exists an irreducible  $\mathbb{C}L$ -module  $A$  and an irreducible  $\mathbb{C}N$ -module  $B$  such that  $C \cong A \otimes B$ , see [57, Proposition 9.14]. If  $\chi_A \in \text{Irr}(L)$  is the character associated with the module  $A$ ,  $\chi_B \in \text{Irr}(N)$  the character associated with  $B$ , and  $\vartheta \in \text{Irr}(I_E(\chi))$  the character associated with  $C$ , then  $\vartheta$  is of the form  $\vartheta(\ell n) = \chi_A(\ell) \chi_B(n)$  with  $\ell \in L$  and  $n \in N$ .

As the restriction of  $C$  to a  $\mathbb{C}N$ -module contains an irreducible  $\mathbb{C}N$ -module  $W$  with

character  $\chi$ , we must have

$$\begin{aligned} (\vartheta_N, \chi)_N &= \frac{1}{|N|} \sum_{n \in N} \vartheta(1, n^{-1}) \chi(n) = \frac{1}{|N|} \sum_{n \in N} \chi_A(1) \chi_B(n^{-1}) \chi(n) \\ &= \chi_A(1) (\chi_B, \chi)_N > 0. \end{aligned}$$

Since  $\text{Irr}(N)$  forms an orthonormal basis with respect to  $(\cdot, \cdot)_N$ , we can conclude that the irreducible character  $\chi_B$  must be equal to  $\chi$ . It follows that  $C \cong A \otimes W$ .

The dimension of  $W \cong B$  is  $\chi(1)$ , and by Fact V.5 the dimension of  $C$  is given by

$$\text{Tr } P = |Z(E) \cap N| |E : Z(E)|^{1/2} \chi(1)^2 / |N|.$$

The dimension of  $B$  follows from the formula  $\dim C = \dim A \dim B$ .

Note that the projector for  $C$  acts as  $\mathbf{1}^{AB} = \mathbf{1}^A \otimes \mathbf{1}^B$  on  $C$ . By [88, Theorem 1], an error  $e \in E - I_E(\chi)$  maps  $C$  to an orthogonal complement, so  $eP$  and  $P$  project onto orthogonal subspaces and we have  $PeP = 0$ ; by equation (5.10) the error  $e$  is detectable<sup>‡</sup>. An error  $e$  in  $Z(\chi_A)N$  acts by scalar multiplication on  $A$  and arbitrarily on  $B$ , so  $eP = \mathbf{1}^A \otimes \rho^B$  for some  $\rho^B \in \mathcal{B}(B)$ . Thus  $PeP = \mathbf{1}^A \otimes \mathcal{B}(B)$ ; again by equation (5.10) these errors are detectable (harmless would be a better word). Therefore, all errors in  $E - (I_E(\chi) - Z(\chi_A)N)$  are detectable. Conversely, an error  $e$  in  $I_E(\chi) - Z(\chi_A)N$  cannot be detectable, since  $e$  does not act by scalar multiplication on  $A$ . We have  $eP \neq \mathbf{1}^A \otimes \rho^B$ . Therefore  $PeP \neq \mathbf{1}^A \otimes \rho^B$  and thus  $e$  is an undetectable error.  $\square$

The data given in the previous theorem can be easily computed, especially with the help of a computer algebra system such as GAP or MAGMA.

We will now consider some important special cases. Recall that most abstract error groups that are used in the literature satisfy the constraint  $E' \subseteq Z(E)$  (put differently, the

---

<sup>‡</sup> Alternatively by Fact V.5, the error  $e$  is detectable when we view  $C$  as a Clifford code. When viewed as an operator quantum error correcting code, we encode only into a subspace of  $C$ , therefore  $e$  still remains detectable.

quotient group  $E/Z(E)$  is abelian). In that case, we are able to obtain a characterization of the resulting operator quantum error-correcting codes that does not depend on the choice of the character  $\chi$ .

**Theorem V.7.** *Suppose that  $E$  is an abstract error group such that  $E' \subseteq Z(E)$ . Suppose that  $C$  is a Clifford code with data  $(E, \rho, N, \chi)$ . In this case, the inertia group is given by  $I_E(\chi) = C_E(Z(N))$ . If  $C_E(Z(N)) = LN$  for some subgroup  $L$  of  $E$  such that  $[L, N] = 1$ , then  $C$  is an operator quantum error-correcting code  $C = A \otimes B$  such that*

- i)  $\dim A = |Z(E) \cap N| |E : Z(E)|^{1/2} |N : Z(N)|^{1/2} / |N|$ ,
- ii)  $\dim B = |N : Z(N)|^{1/2}$ .

*An error  $e$  in  $E$  is detectable by subsystem  $A$  if and only if  $e$  is contained in the set  $E - (C_E(Z(N)) - Z(L)N)$ .*

*Proof.* Since the abstract error group  $E$  satisfies the condition  $E' \subseteq Z(E)$ , the inertia group of the character  $\chi$  in  $E$  can be fully determined; it is given by  $T := I_E(\chi) = C_E(Z(N))$ , see [88, Lemma 5].

Suppose that

$$P_1 = \frac{\chi(1)}{|N|} \sum_{n \in N} \chi(n^{-1}) \rho(n)$$

is the orthogonal projector onto  $C$ . The assumption  $E' \subseteq Z(E)$  implies that there exists a linear character  $\varphi$  of  $\text{Irr}(Z(N))$  such that

$$P_2 = \frac{1}{|Z(N)|} \sum_{n \in Z(N)} \varphi(n^{-1}) \rho(n)$$

satisfies  $P_1 = P_2$ , see [88, Theorem 6].

Let  $\phi$  be the character of the representation  $\rho$ , that is,  $\phi(g) = \text{Tr } \rho(g)$  for  $g \in E$ . We have  $\text{Tr } P_1 = \chi(1)^2 \phi(1) |N \cap Z(E)| / |N|$  and  $\text{Tr } P_2 = \phi(1) |N \cap Z(E)| / |Z(N)|$ . Since  $P_1 = P_2$  project onto the codespace  $C$ , and  $\dim C > 0$ , we have  $\text{Tr } P_1 / \text{Tr } P_2 = 1$ , which implies  $\chi(1)^2 = |N : Z(N)|$ . Therefore, the claims i) and ii) follow from Theorem V.6.

Let  $\vartheta \in \text{Irr}(T)$  be the character associated with the  $\mathbb{C}[T]$ -module  $C$ ; put differently,  $\vartheta$  is the unique character in  $\text{Irr}(T)$  that satisfies  $(\vartheta_N, \chi)_N > 0$  and  $(\phi_T, \vartheta)_T > 0$ . Since  $Z(E) \leq T$  and  $(\phi_T, \vartheta)_T > 0$ , it follows from Lemma V.18 that  $\text{supp}(\vartheta) = Z(T)$ .

Since the inertia group  $T$  is a central product given by  $T = LN$  with  $[L, N] = 1$ , there exist characters  $\chi_A \in \text{Irr}(L)$  and  $\chi_B = \chi \in \text{Irr}(N)$  such that  $\vartheta(\ell n) = \chi_A(\ell)\chi(n)$  for  $\ell \in L$  and  $n \in N$ . By Lemma V.19, we have  $Z(T) = Z(L)Z(N)$ ; thus,  $\text{supp}(\vartheta) = Z(L)Z(N)$ . This implies that  $\text{supp}(\chi_A) = L \cap Z(L)Z(N) = Z(L)$ ; hence  $Z(\chi_A) = Z(L)$ . The characterization of the detectable errors is obtained by substituting these facts in Theorem V.6.  $\square$

In the previous theorem, we still need to check whether  $C_E(Z(N))$  decomposes into a central product of  $N$  and some group  $L$ . In the case of extraspecial  $p$ -groups (which is arguably the most popular choice of abstract error groups) the decomposition of the inertia group into a central product is always guaranteed, as we will show next.

Recall that a finite group  $E$  whose order is a power of a prime  $p$  is called extraspecial if its derived subgroup  $E'$  and its center  $Z(E)$  coincide and have order  $p$ . An extraspecial  $p$ -group is an abstract error group. The quotient group  $\overline{E} = E/Z(E)$  is the direct product of two isomorphic elementary abelian  $p$ -groups. Therefore, one can regard  $\overline{E}$  as a vector space  $\mathbb{F}_p^{2n}$  over the finite field  $\mathbb{F}_p$ .

Let  $\zeta$  be a fixed generator of the cyclic group  $Z(E)$ . As the commutator  $[x, y]$  depends only on the cosets  $\overline{x} = xZ(E)$  and  $\overline{y} = yZ(E)$ , one can determine a well-defined function  $s: \overline{E} \times \overline{E} \rightarrow \mathbb{F}_p$  by  $[x, y] = \zeta^{s(\overline{x}, \overline{y})}$ . The function  $s$  is a nondegenerate symplectic form. We note that two elements  $x$  and  $y$  in  $E$  commute if and only if  $s(\overline{x}, \overline{y}) = 0$ . We write  $\overline{x} \perp_s \overline{y}$  if and only if  $s(\overline{x}, \overline{y}) = 0$ .

For a subgroup  $G$  of  $E$ , we will use  $\overline{G}$  to denote  $G/Z(E)$ .

**Lemma V.8.** *If  $E$  is an extraspecial  $p$ -group and  $N$  a normal subgroup of  $E$ , then  $C_E(Z(N)) =$*

$NC_E(N)$ .

*Proof.* Since  $Z(E) \leq NC_E(N) \leq C_E(Z(N))$ , it suffices to show that the dimensions of the  $\mathbb{F}_p$ -linear vector spaces

$$\overline{NC_E(N)} \quad \text{and} \quad \overline{C_E(Z(N))}$$

are the same. Suppose that  $z = \dim \overline{Z(N)}$  and  $k = \dim \overline{N}$ . Then

$$\begin{aligned} \dim \overline{NC_E(N)} &= \dim(\overline{N} + \overline{N}^{\perp_s}) = \dim \overline{N} + \dim \overline{N}^{\perp_s} - \dim(\overline{N} \cap \overline{N}^{\perp_s}) \\ &= \dim \overline{N} + \dim \overline{N}^{\perp_s} - \dim(\overline{Z(N)}) \\ &= k + (2n - k) - z = 2n - z, \end{aligned}$$

which coincides with  $\dim \overline{C_E(Z(N))} = \dim \overline{Z(N)}^{\perp_s} = 2n - z$ , and this proves our claim.  $\square$

The next theorem shows that it suffices to choose a normal subgroup  $N$  of the extraspecial  $p$ -group  $E$ , and this choice determines the parameters of an operator quantum error-correcting code provided by a Clifford code  $C$ .

**Theorem V.9.** *Suppose that  $E$  is an extraspecial  $p$ -group. If  $C$  is a Clifford code with data  $(E, \rho, N, \chi)$ , with  $N \neq 1$ , then  $C$  is an operator quantum error-correcting code  $C = A \otimes B$  such that*

- i)  $\dim A = |Z(E) \cap N| |E : Z(E)|^{1/2} |N : Z(N)|^{1/2} / |N|$ ,
- ii)  $\dim B = |N : Z(N)|^{1/2}$ .

*An error  $e$  in  $E$  is detectable by subsystem  $A$  if and only if  $e$  is contained in the set  $E - (NC_E(N) - N)$ .*

*Proof.* The inertia group  $I_\chi(E) = C_E(Z(N))$ , since  $E' \subseteq Z(E)$ , see [88, Lemma 5]. By Lemma V.8, we have  $I_E(\chi) = LN = NL$  with  $L = C_E(N)$ . Thus,  $C$  is an operator quantum error-correcting code and the statements i) and ii) follow from Theorem V.7.

Furthermore, Theorem V.7 shows that an error  $e$  in  $E$  is detectable if and only if  $e \in E - (NC_E(N) - Z(L)N)$ . Since  $E$  is a  $p$ -group and  $N \neq 1$ , we have  $N \cap Z(E) \neq 1$ ; hence  $Z(E) \leq N$ . We note that  $\overline{Z(L)} \subseteq \overline{L} \cap \overline{L}^{\perp_s} = \overline{N}^{\perp_s} \cap \overline{N} \subseteq \overline{N}$ ; therefore,  $N \subseteq Z(L)N \subseteq Z(N)N = N$ , forcing  $Z(L)N = N$ .  $\square$

The normal subgroup  $N$  used in the construction of subsystem codes will henceforth be called as the *gauge group*. This definition coincides with the definition of the gauge group in [120].

#### D. Subsystem Codes from Classical Codes

We conclude this chapter by showing how the previous results can be related to classical coding theory. Let  $a$  and  $b$  be elements of the finite field  $\mathbb{F}_q$  of characteristic  $p$ . Recall that in Section 1 we defined the unitary operators  $X(a)$  and  $Z(b)$  on  $\mathbb{C}^q$  by

$$X(a) |x\rangle = |x + a\rangle, \quad Z(b) |x\rangle = \omega^{\text{tr}(bx)} |x\rangle,$$

where  $\text{tr}$  denotes the trace operation from the extension field  $\mathbb{F}_q$  to the prime field  $\mathbb{F}_p$ , and  $\omega = \exp(2\pi i/p)$  is a primitive  $p$ th root of unity. Let  $\mathbf{a} = (a_1, \dots, a_n) \in \mathbb{F}_q^n$ . We write  $X(\mathbf{a}) = X(a_1) \otimes \dots \otimes X(a_n)$  and  $Z(\mathbf{a}) = Z(a_1) \otimes \dots \otimes Z(a_n)$  for the tensor products of  $n$  error operators. One readily checks that the group

$$E = \langle X(a), Z(b) \mid a, b \in \mathbb{F}_q^n \rangle$$

is an extraspecial  $p$ -group of order  $pq^{2n}$ . As a representation  $\rho$ , we can take the identity map on  $E$ . We have  $E/Z(E) \cong \mathbb{F}_q^{2n}$ .

We need to introduce a notion of weights of errors. Recall that an error in  $E$  can be expressed in the form  $\alpha X(a)Z(b)$  for some nonzero scalar  $\alpha$ . The weight of  $\alpha X(a)Z(b)$  is defined as  $|\{i \mid 1 \leq i \leq n, a_i \neq 0 \text{ or } b_i \neq 0\}|$ , that is, as the number of quantum systems

that are affected by the error. Similarly, we can introduce a weight on vectors of  $\mathbb{F}_q^{2n}$  by

$$\text{swt}(a|b) = \{i \mid 1 \leq i \leq n, a_i \neq 0 \text{ or } b_i \neq 0\}$$

for  $a, b \in \mathbb{F}_q^n$ .

Theorem V.9 suggests the following approach to construct operator quantum error-correcting codes.

**Theorem V.10.** *Let  $X$  be a classical additive subcode of  $\mathbb{F}_q^{2n}$  such that  $X \neq \{0\}$  and let  $Y$  denote its subcode  $Y = X \cap X^{\perp_s}$ . If  $x = |X|$  and  $y = |Y|$ , then there exists an operator quantum error-correcting code  $C = A \otimes B$  such that*

- i)  $\dim A = q^n / (xy)^{1/2}$ ,
- ii)  $\dim B = (x/y)^{1/2}$ .

*The minimum distance of subsystem  $A$  is given by  $d = \text{swt}((X + X^{\perp_s}) - X) = \text{swt}(Y^{\perp_s} - X)$ . Thus, the subsystem  $A$  can detect all errors in  $E$  of weight less than  $d$ , and can correct all errors in  $E$  of weight  $\leq \lfloor (d - 1)/2 \rfloor$ .*

*Proof.* Let  $E$  be the extraspecial  $p$ -group of order  $pq^{2n}$ , and let  $N$  be the full preimage of  $\overline{N} = X$  in  $E$  under the canonical quotient map. Therefore, we can apply Theorem V.9. The remainder of the proof justifies how the parameters given in Theorem V.9 can be expressed in terms of the code sizes  $x$  and  $y$ .

Then  $\overline{Z(\overline{N})} = X \cap X^{\perp_s} = Y$ . By definition,  $N$  contains  $Z(E)$ ; hence,  $Z(E) \leq Z(N)$ . It follows that  $|N : Z(N)| = |\overline{N} : \overline{Z(\overline{N})}| = x/y$ , so ii) follows from Theorem V.9. For the claim i), we remark that  $x = |X| = |N|/p$ , which implies that  $\dim A = (p/|N|)|E : Z(E)|^{1/2}|N : Z(N)|^{1/2} = q^n(x/y)^{1/2}/x$ .

The minimum distance of subsystem  $A$  is the weight of the smallest nondetectable error, so it is the minimum weight of an error in the set  $NC_E(N) - N = C_E(Z(N)) - N$ . Since the quotient map  $E \rightarrow \overline{E}$  maps an error  $e$  of weight  $w$  onto a vector  $\overline{e}$  such



that  $w = \text{swt } \bar{e}$ , the claim about the minimum distance follows from the observations that  $\overline{NC_E(N) - N} = (X + X^{\perp_s}) - X$  and  $\overline{C_E(Z(N)) - N} = Y^{\perp_s} - X$ .  $\square$

**Remark V.11.** *As in the case of stabilizer codes, the most general symplectic form we can choose is  $\langle u|v \rangle_s = \text{tr}_{q/p}(a' \cdot b - a \cdot b')$ , where  $u = (a|b)$  and  $v = (a'|b')$  are in  $\mathbb{F}_q^{2n}$ . We define the trace symplectic dual as  $C^{\perp_s} = \{x \in \mathbb{F}_q^{2n} \mid \langle x|y \rangle_s = 0, \text{ for all } y \in C\}$ . In case of  $\mathbb{F}_q$ -linear codes, the trace symplectic form  $\langle (a|b)|(a'|b') \rangle_s$  vanishes if and only if  $a' \cdot b - a \cdot b'$  vanishes. The trace symplectic dual for an  $\mathbb{F}_q$ -linear code therefore coincides with its symplectic dual. So when dealing with  $\mathbb{F}_q$ -linear codes we indulge in an abuse of notation and denote  $a' \cdot b - a \cdot b'$  also by  $\langle (a|b)|(a'|b') \rangle_s$  and the duals with respect to both forms as  $C^{\perp_s}$ .*

In the above the theorem we had been able to define the distance in terms of the classical codes. Having made choice of the error group we can also go back and recast the distance in terms of the gauge group as  $\text{wt}(C_E(Z(N)) - N)$ . In addition, we can also extend the notion of purity to subsystem codes also in a straightforward manner.

**Definition V.12** (Pure and impure subsystem codes). *Let  $N$  be the gauge group of a subsystem code  $Q$  with distance  $d = \text{wt}(C_E(Z(N)) - N)$ . We say that  $Q$  is pure to  $d'$  if there is no error of weight less than  $d'$  in  $N$ . The code is said to be exactly pure to  $d'$  if  $\text{wt}(N)$  is  $d'$  and it is said to pure if  $d' \geq d$ . The code is said to be impure if it is exactly pure to  $d' < d$ .*

This refinement to the notion of purity was made in recognition of certain subtleties that had to be addressed when constructing other subsystem codes from existing subsystem codes, see [6] for details.

An operator quantum error-correcting code with parameters  $((n, K, R, d))_q$  is a subspace  $C = A \otimes B$  of a  $q^n$ -dimensional Hilbert space  $H$  such that  $K = \dim A$ ,  $R = \dim B$ , and the subsystem  $A$  has minimum distance  $d$ . The above theorem constructs

an  $((n, q^n/(xy)^{1/2}, (x/y)^{1/2}, d))_q$  operator quantum error-correcting code given a classical  $(n, x)_q$  code  $X$  and its  $(n, y)_q$  subcode  $Y = X \cap X^{\perp_s}$ . We write  $[[n, k, r, d]]_q$  for an  $((n, q^k, q^r, d))_q$  operator quantum error-correcting code.

A further simplification of the above construction is possible which takes any pair of classical codes to give a subsystem code.

**Corollary V.13** (Euclidean Construction). *Let  $X_i \subseteq \mathbb{F}_q^n$ , be  $[n, k_i]_q$  linear codes where  $i \in \{1, 2\}$ . Then there exists an  $[[n, k, r, d]]_q$  Clifford subsystem code with*

- $k = n - (k_1 + k_2 + k')/2$ ,
- $r = (k_1 + k_2 - k')/2$ , and
- $d = \min\{\text{wt}((X_1^\perp \cap X_2)^\perp \setminus X_1), \text{wt}((X_2^\perp \cap X_1)^\perp \setminus X_2)\}$ ,

where  $k' = \dim_{\mathbb{F}_q}(X_1 \cap X_2^\perp) \times (X_1^\perp \cap X_2)$ .

The result follows from Theorem V.9 by defining  $C = X_1 \times X_2$ ; it follows that  $C^{\perp_s} = X_2^\perp \times X_1^\perp$  and  $D = C \cap C^{\perp_s} = (X_1 \cap X_2^\perp) \times (X_2 \cap X_1^\perp)$ , and the parameters are easily obtained from these definitions, see [6] for a detailed proof.

The notions of purity can be defined in terms of classical codes as well. Let  $C$  be an additive subcode of  $\mathbb{F}_q^{2n}$  and  $D = C \cap C^{\perp_s}$ . By theorem V.9, we can obtain an  $((n, K, R, d))_q$  subsystem code  $Q$  from  $C$  that has minimum distance  $d = \text{swt}(D^{\perp_s} - C)$ . If  $d' \leq \text{swt}(C)$ , then we say that the associated operator quantum error correcting code is *pure to  $d'$* .

Extending the ideas of purity to subsystem codes is useful because it facilitates the analysis of the parameters of the subsystem codes, as will become clear when we derive bounds in the next chapter.

As in the case of stabilizer codes we would like one would like to characterize the minimum distance in terms of the familiar Hamming weight. For this purpose, we reformulate the above result in terms of codes of length  $n$  over  $\mathbb{F}_{q^2}$ .

Let  $(\beta, \beta^q)$  be a fixed normal basis of  $\mathbb{F}_{q^2}$  over  $\mathbb{F}_q$ . We can define a bijection  $\phi$  from

$\mathbb{F}_q^{2n}$  onto  $\mathbb{F}_{q^2}^n$  by setting

$$\phi((a|b)) = \beta a + \beta^q b \quad \text{for } (a|b) \in \mathbb{F}_q^{2n}.$$

The map is chosen such that a vector  $(a|b)$  of symplectic weight  $x$  is mapped to a vector  $\phi((a|b))$  of Hamming weight  $x$ . Recall the trace-alternating form  $\langle v|w \rangle_a$  for vectors  $v$  and  $w$  in  $\mathbb{F}_{q^2}^n$  given in equation (3.7)

$$\langle v|w \rangle_a = \text{tr}_{q/p} \left( \frac{v \cdot w^q - v^q \cdot w}{\beta^{2q} - \beta^q} \right).$$

It is easy to show that  $\langle c|d \rangle_s = \langle \phi(c)|\phi(d) \rangle_a$  holds for all  $c, d \in \mathbb{F}_q^{2n}$ , see Lemma III.14. Specifically, we have  $c \perp_s d$  if and only if  $\phi(c) \perp_a \phi(d)$ . Therefore, the previous theorem can be reformulated in terms of codes of length  $n$  over  $\mathbb{F}_{q^2}$  as follows:

**Theorem V.14.** *Let  $X$  be a classical additive subcode of  $\mathbb{F}_{q^2}^n$  such that  $X \neq \{0\}$  and let  $Y$  denote its subcode  $Y = X \cap X^{\perp_a}$ . If  $x = |X|$  and  $y = |Y|$ , then there exists an operator quantum error-correcting code  $C = A \otimes B$  such that*

- i)  $\dim A = q^n / (xy)^{1/2}$ ,
- ii)  $\dim B = (x/y)^{1/2}$ .

*The minimum distance of subsystem  $A$  is given by*

$$d = \text{wt}((X + X^{\perp_a}) - X) = \text{wt}(Y^{\perp_a} - X),$$

*where  $\text{wt}$  denotes the Hamming weight. Thus, the subsystem  $A$  can detect all errors in  $E$  of Hamming weight less than  $d$ , and can correct all errors in  $E$  of Hamming weight  $\lfloor (d-1)/2 \rfloor$  or less.*

*Proof.* This follows from Theorem V.10 and the definition of the isometry  $\phi$ . □

The above connections of Clifford operator quantum error-correcting codes to classical codes allow one to explore a plethora of code constructions. Henceforth codes con-

structed by using Theorems V.10,V.14 will be referred to as *Clifford subsystem codes* or just subsystem codes. We shall give an example to illustrate the idea. For simplicity we shall consider binary codes derived from codes over  $\mathbb{F}_4$  whose elements are given by  $\{0, 1, \omega, \omega^2\}$ , where  $\omega^2 + \omega + 1 = 0$ . Further, choosing  $\beta = \omega$ , the trace alternating product simplifies as  $\langle v|w \rangle_a = v \cdot w^2 + v^2 \cdot w$ . Note that if  $w = (w_1, \dots, w_n)$ , then we denote  $w^2 = (w_1^2, \dots, w_n^2)$ .

**Example V.15.** Let  $X$  be the additive code given by the following generator matrix.

$$G_X = \begin{bmatrix} 1 & 1 & 0 & 0 \\ 0 & 0 & 1 & 1 \\ \omega & 0 & \omega & 0 \\ 0 & \omega & 0 & \omega \end{bmatrix}$$

Then it can be verified that  $X^{\perp_a}$  is generated by

$$G_{X^{\perp_a}} = \begin{bmatrix} \omega & \omega & 0 & 0 \\ 0 & 0 & \omega & \omega \\ 1 & 0 & 1 & 0 \\ 0 & 1 & 0 & 1 \end{bmatrix}.$$

Further,  $Y = X \cap X^{\perp_a}$  is generated by

$$G_Y = \begin{bmatrix} 1 & 1 & 1 & 1 \\ \omega & \omega & \omega & \omega \end{bmatrix}.$$

We see that  $|X| = 2^4$ , while  $|Y| = 2^2$ . Thus by Theorem V.14 we have a  $((4, K, R, d))_2$  Clifford subsystem code where  $K = 2^4/\sqrt{2^4 \cdot 2^2} = 1$  and  $R = \sqrt{2^4/2^2} = 2$ . The distance of the code is 2 because the  $Y^{\perp_a} \setminus X$  contains  $(0, 1, 0, 1)$  among other weight two elements. Thus we obtain a  $((4, 2, 2, 2))_2$  i.e. a  $[[4, 1, 1, 2]]_2$  code. This code is not a Clifford code. The associated Clifford code is a  $[[4, 2, 2]]_2$  code. Incidentally, this code is the smallest

*error detecting subsystem code with nontrivial dimensions for the subsystems.*

Often linear codes are of more interest than the additive codes. So we shall consider a linear operator quantum error-correcting code. In this case we can look at Hermitian duals instead of the trace-alternating duals. Let  $x, y \in \mathbb{F}_4^n$ . Then we define the Hermitian inner product  $\langle x|y \rangle_h = \sum_i^n x_i y_i^2$ . Let  $C \subseteq \mathbb{F}_4^n$  be an  $\mathbb{F}_4$ -linear code. The Hermitian dual of  $C$  is defined as  $C^{\perp_h} = \{x \in \mathbb{F}_4^n \mid \langle x|c \rangle_h = 0 \text{ for all } c \in C\}$ . From Lemma III.18, we know that  $C^{\perp_a} = C^{\perp_h}$ . So we can use Hermitian duals in Theorem V.14.

**Example V.16.** *Let  $X \subseteq \mathbb{F}_4^{15}$  be a narrow-sense BCH code of design distance 6. This code is neither self-orthogonal nor does it contain its (Hermitian) dual. The generator polynomial of  $X$  is given by*

$$g(x) = x^7 + x^6 + \omega x^4 + x^2 + \omega^2 x + \omega^2.$$

*Thus  $X$  is an  $[15, 8, \geq 6]_4$  code. A generator matrix for this code is obtained as*

$$G = \left[ \begin{array}{ccc|ccc|ccc|ccc|ccc} 1 & 1 & 0 & \omega & 0 & 1 & \omega^2 & \omega^2 & 0 & 0 & 0 & 0 & 0 & 0 & 0 \\ 0 & 1 & 1 & 0 & \omega & 0 & 1 & \omega^2 & \omega^2 & 0 & 0 & 0 & 0 & 0 & 0 \\ 0 & 0 & 1 & 1 & 0 & \omega & 0 & 1 & \omega^2 & \omega^2 & 0 & 0 & 0 & 0 & 0 \\ 0 & 0 & 0 & 1 & 1 & 0 & \omega & 0 & 1 & \omega^2 & \omega^2 & 0 & 0 & 0 & 0 \\ 0 & 0 & 0 & 0 & 1 & 1 & 0 & \omega & 0 & 1 & \omega^2 & \omega^2 & 0 & 0 & 0 \\ 0 & 0 & 0 & 0 & 0 & 1 & 1 & 0 & \omega & 0 & 1 & \omega^2 & \omega^2 & 0 & 0 \\ 0 & 0 & 0 & 0 & 0 & 0 & 1 & 1 & 0 & \omega & 0 & 1 & \omega^2 & \omega^2 & 0 \\ 0 & 0 & 0 & 0 & 0 & 0 & 0 & 1 & 1 & 0 & \omega & 0 & 1 & \omega^2 & \omega^2 \end{array} \right].$$

*The gauge group is the (full) preimage of  $G$  under the isometry  $\phi$ . The generator polynomial of its Hermitian dual is given by*

$$x^8 + x^7 + \omega x^6 + x^5 + \omega x^4 + \omega^2 x^3 + \omega x^2 + \omega x + \omega.$$

The generator polynomial of  $Y = C \cap C^{\perp_h}$  is given by

$$h(x) = x^9 + \omega x^8 + x^7 + x^5 + \omega x^4 + \omega^2 x^2 + \omega^2 x + 1.$$

We see that  $Y^{\perp_h}$  is a  $[15, 9]_4$  code. Again using Theorem V.14 we can compute the dimensions of the subsystems  $A$  and  $B$  as  $2^{15}/\sqrt{4^8 \cdot 4^6} = 2$  and  $\sqrt{4^8/4^6} = 4$  respectively. The code  $Y^{\perp_h}$  has minimum weight 5 (computed using MAGMA). Since  $\text{wt}(X) \geq 6$ , it follows that  $\text{wt}(Y^{\perp_h} \setminus X) = 5$ . Thus,  $X$  defines a  $((15, 2, 4, 5))_2$  code. But note that the associated Clifford code has the parameters  $((15, 8, 5))_2$ .

Further simplifications of Theorem V.14 for constructing operator quantum error-correcting codes can be found in [6]. The reader can also find examples of Clifford subsystem codes derived from BCH codes, Reed-Solomon codes therein. Interested readers can also refer to [19] for a novel method to construct subsystem codes from a pair of classical codes.

## E. Conclusions

We have introduced a method for constructing operator quantum error-correcting codes. We have seen that a Clifford codes  $C$  offers naturally a tensor-product decomposition  $C = A \otimes B$ , where the dimensions of the subsystems are controlled by the choice of the normal subgroup  $N$  and its character  $\chi$ .

Our construction in terms of classical codes is fairly simple: Any classical (additive) code over a finite field can be used to construct an operator quantum error-correcting code. In particular, we do not require any self-orthogonality conditions as in the case of stabilizer code constructions.

The most prominent open problem concerning operator quantum error-correcting codes is whether one can achieve better error correction that by means of a quantum error-

correcting code. The construction given in Theorem V.10 allows one to compare the parameters of Clifford codes with the parameters of stabilizer codes. One should note that a fair comparison should be made between  $[[n - r, k, d]]$  stabilizer codes and  $[[n, k, r, d]]$  Clifford subsystem codes. In subsequent chapters we shall establish bounds on the parameters of subsystem codes and make a fair comparison of the subsystem codes and stabilizer codes. Additionally, we shall also look into other aspects which we have not considered here such as encoding subsystem codes, the gains in encoding and decoding.

## F. Appendix

In this appendix, we prove some simple technical results on groups and characters.

**Lemma V.17.** *Let  $E$  be a finite group such that  $E' \subseteq Z(E)$ , and let  $H$  be a subgroup of  $E$ . If  $\chi \in \text{Irr}(H)$  satisfies  $Z(E) \cap \ker \chi = \{1\}$ , then  $\text{supp } \chi = Z(H)$ .*

*Proof.* Let  $h \in \text{supp}(\chi)$ . Seeking a contradiction, we assume that  $h \in H - Z(H)$ . Since  $E' \subseteq Z(E)$ , there exists an element  $g \in H$  such that  $ghg^{-1} = zh$  with  $z \in Z(E)$  such that  $z \neq 1$ . Since  $zh \in H$  and  $h \in H$ , we have  $z \in H \cap Z(E)$ . As  $\chi$  is irreducible, the element  $z \in H \cap Z(E)$  is represented by  $\omega I$  for some  $\omega \in \mathbb{C}$  by Schur's lemma; furthermore,  $\omega \neq 1$ , since  $Z(E) \cap \ker \chi = \{1\}$ . We note that  $\chi(h) = \chi(ghg^{-1}) = \chi(zh) = \omega\chi(h)$ , with  $\omega \neq 1$ , forcing  $\chi(h) = 0$ , contradiction.

The elements of  $Z(H)$  belong to the support of  $\chi$ , since they are represented by scalar invertible matrices. □

**Lemma V.18.** *Let  $E$  be a finite group such that  $E' \subseteq Z(E)$ , and let  $\phi \in \text{Irr}(E)$  be a faithful character of degree  $\phi(1) = |E : Z(E)|^{1/2}$ . Let  $T$  be a subgroup of  $E$  such that  $Z(E) \leq T$ . If  $\vartheta \in \text{Irr}(T)$  and  $(\phi_T, \vartheta)_T > 0$ , then  $\text{supp}(\vartheta) = Z(T)$ .*

*Proof.* Let  $Z = Z(E)$ . We have  $\text{supp}(\phi) = Z$  by [78, Lemma 2.29]. Since the support of

$\phi$  equals  $Z$ , it follows from the definitions that

$$0 < (\phi_T, \vartheta)_T = \frac{1}{|T : Z|} (\phi_Z, \vartheta_Z)_Z.$$

Clearly,  $\phi_Z = \phi(1)\varphi$  and  $\vartheta_Z = \vartheta(1)\theta$  for some linear characters  $\varphi$  and  $\theta$  of  $Z$ . As  $(\phi_Z, \vartheta_Z)_Z = \phi(1)\vartheta(1)(\varphi, \theta)_Z > 0$ , we must have  $\theta = \varphi$ . Since  $\phi$  is faithful, it follows that  $\varphi = \theta$  is faithful; hence,  $\ker \vartheta \cap Z(E) = \{1\}$ . Thus,  $\text{supp } \vartheta = Z(T)$  by Lemma V.17.  $\square$

**Lemma V.19.** *Suppose that  $T$  is a group with subgroups  $L$  and  $N$  such that  $T = LN$  and  $[L, N] = 1$ . Then  $Z(T) = Z(L)Z(N)$ .*

*Proof.* Since  $T = LN$ , an arbitrary element  $z$  of  $Z(T)$  can be expressed in the form  $z = ln$  for some  $l \in L$  and  $n \in N$ . For  $n'$  in  $N$ , we have  $l n n' = n' l n = l n' n$ , where the latter equality follows from  $[L, N] = 1$ . Consequently,  $n n' = n' n$  for all  $n'$  in  $N$ , so  $n$  is an element of  $Z(N)$ . Similarly,  $l$  must be an element of  $Z(L)$ . It follows that  $Z(T) = Z(L)Z(N)$ .  $\square$



## CHAPTER VI

## SUBSYSTEM CODES – BOUNDS AND CONSTRUCTIONS\*

In this chapter we extend the theory of subsystem codes. One of our goals is to clarify the benefits that can be gained from the use of subsystem codes with respect to stabilizer codes. In this context we derive bounds on the parameters of subsystem codes. These bounds help in comparing the performance of subsystem codes with respect to stabilizer codes. Of course subsystem codes subsume stabilizer and in that sense every stabilizer code is a subsystem code. However, we use the term subsystem code to mean a code with nontrivial dimension of the gauge subsystem. We generalize the quantum Singleton bound to  $\mathbb{F}_q$ -linear subsystem codes. It follows that no subsystem code over a prime field can beat the quantum Singleton bound. On the other hand, we show the remarkable fact that there exist impure subsystem codes beating the quantum Hamming bound. A number of open problems concern the comparison in performance of stabilizer and subsystem codes. One of the open problems suggested by Poulin's work asks whether a subsystem code can use fewer syndrome measurements than an optimal  $\mathbb{F}_q$ -linear MDS stabilizer code while encoding the same number of qudits and having the same distance. We prove that linear subsystem codes cannot offer such an improvement under complete decoding.

One of the promises of subsystem codes is their potential for simplifying error recovery. Perhaps the benefits of subsystem codes are best understood by an example. Consider the first quantum error correcting code proposed by [142], which encodes one qubit into nine qubits. This code which is capable of correcting a single error on any of the qubits requires the measurement of eight syndrome qubits. The Bacon-Shor subsystem code [18]

---

\*©2007. Part of the material in this chapter is reprinted from A. Klappenecker and P. K. Sarvepalli, "On subsystem codes beating the quantum Hamming or Singleton bound", *Proc. Royal Society London A*, vol 463, pp. 2887-2905, 2007.

on the other hand, also encodes one qubit into nine but it requires only four syndrome measurements, giving a simpler error recovery scheme.

In this context it becomes crucial to identify when subsystem codes provide gains over the stabilizer codes. It also becomes necessary to compare the stabilizer codes and the subsystem codes fairly and with meaningful criteria. For instance, once again consider the  $[[9, 1, 3]]_2$  Shor code requiring  $n - k = 9 - 1 = 8$  syndrome measurements. The  $[[9, 1, 4, 3]]_2$  Bacon-Shor code on the other hand requires  $n - k - r = 9 - 1 - 4 = 4$  syndrome measurements. Clearly, this code is better than the Shor's code. But the optimal single error correcting binary quantum code that encodes one qubit is the  $[[5, 1, 3]]_2$  code, which also requires only  $5 - 1 = 4$  syndrome measurements. So it is apparent that while a given subsystem code can be superior to some stabilizer codes, it is not at all obvious that it is better than the best stabilizer code for the same function, *viz.*, encoding  $k$  qubits with a distance  $d$ .

The first part of our chapter seeks to address this issue for  $\mathbb{F}_q$ -linear Clifford subsystem codes which might perhaps be the most useful class of subsystem codes. In this chapter we generalize the quantum Singleton bound to  $\mathbb{F}_q$ -linear Clifford subsystem codes. It follows that no Clifford subsystem code over a prime field can beat the quantum Singleton bound. We then show how the quantum Singleton bound can be applied to make the comparison between stabilizer and subsystem codes (focusing on stabilizer codes that are optimal in the sense that they meet the quantum Singleton bound). This bound makes it possible to quantify the gains that subsystem codes can provide in error recovery. In particular, our results show that these gains involve a trade off between the distance of the subsystem code and the number of information and the gauge qudits. We show that if there exists an  $\mathbb{F}_q$ -linear MDS stabilizer code, *i.e.*, a code meeting the quantum Singleton bound, then no  $\mathbb{F}_q$ -linear subsystem code can outperform it in the sense of requiring fewer syndrome measurements for error correction.

Then we shift our attention to a class of subsystem codes on lattices. Bacon and Casacino [19] obtain a subsystem code from two classical codes. We show that this method is a special case of the Euclidean construction for subsystem codes proposed in [6] and give a coding theoretic analysis of these codes.

Since the early works on quantum error-correcting codes, it has been suspected that impure codes should somehow perform better than the pure codes. However, it was shown that the quantum Singleton bound holds true for both pure and impure stabilizer codes. But it was not so clear with respect to the quantum Hamming bound. In fact, it was often conjectured that there might exist impure quantum error-correcting codes beating the quantum Hamming bound, but a proof remained elusive. At least in the case of binary stabilizer codes there exists some evidence that the conjecture might not be true, as [12] showed that asymptotically the quantum Hamming bound was obeyed by impure codes as well, and [61] showed that no single error correcting binary stabilizer code can beat the quantum Hamming bound. In this context it is not surprising that questions were raised [18] if subsystem codes are any different. In [6] we proved the quantum Hamming bound for pure subsystem codes. We show here that impure subsystem codes can indeed beat the quantum Hamming bound for pure subsystem codes. For example, we demonstrate that the lattice subsystem codes can provide examples of impure subsystem codes that beat the quantum Hamming bound.

The chapter is structured as follows. We assume that the reader is familiar with the notion of subsystem code introduced in the last chapter. We prove the quantum Singleton bound for subsystem codes in Section A. The lattice subsystem codes are focus of attention in Section C and Section D, wherein it is shown that there exist impure subsystem codes that beat the quantum Hamming bound. We conclude with a few open questions on subsystem codes.

### A. Quantum Singleton Bound for $\mathbb{F}_q$ -linear Subsystem Codes

Recall that the quantum Singleton bound states that an  $[[n, k, d]]_q$  quantum code satisfies  $2d \leq n - k + 2$ , [95, 126]. In this context it is natural to ask if subsystem codes also obey a similar relation. The usefulness of such a bound is obvious. Apart from establishing the bounds for optimal subsystem codes, they also make it possible to compare stabilizer and subsystem codes, as we shall see subsequently. We prove that the  $\mathbb{F}_q$ -linear subsystem codes with the parameters  $[[n, k, r, d]]_q$  satisfy a quantum Singleton like bound *viz.*,  $k + r \leq n - 2d + 2$ . It will be seen that this reduces to the quantum Singleton bound if  $r = 0$ . More interestingly, this reveals that there is a trade off in the size of subsystem  $A$  and the gauge subsystem. One pays a price for the gains in error recovery. The cost is the reduction in the information to be stored.

Our proof for this result is quite straightforward, though the intermediate details are a little involved. First we show that a linear  $[[n, k, r > 0, d]]_q$  subsystem code that is exactly pure to 1 can be punctured to an  $[[n - 1, k, r - 1, d]]_q$  code which retains the relationship between  $n, k, r, d$ . If  $d = 2$  by repeated puncturing we either arrive at a pure code or a stabilizer code, both of which have upper bounds. For  $d > 2$ , two cases can arise, if the code is exactly pure to 1, we simply puncture it to get a smaller code as in  $d = 2$  case. Otherwise, we puncture it to get an  $[[n - 1, k, r + 1, d - 1]]_q$  code. By repeatedly shortening we either get a stabilizer code or a distance 2 code both of which have an upper bound. Keeping track of the change in the parameters will give us an upper bound on the parameters of the original code.

Let  $w = (a_1, a_2, \dots, a_n | b_1, b_2, \dots, b_n) \in \mathbb{F}_q^{2n}$ . We denote by  $\rho(w) \in \mathbb{F}_q^{2n-2}$ , the vector obtained by deleting the first and the  $n + 1^{th}$  coordinates of  $w$ . Thus we have

$$\rho(w) = (a_2, \dots, a_n | b_2, \dots, b_n) \in \mathbb{F}_q^{2n-2}.$$

Similarly, given a classical code  $C \subseteq \mathbb{F}_q^{2n}$  we denote the puncturing of a codeword or code in the first and  $n + 1$  coordinates by  $\rho(C)$ .

In Theorem V.10 subsystem codes are constructed using a trace symplectic product. Following Remark V.11 for  $\mathbb{F}_q$ -linear codes instead of considering the trace symplectic inner product we can consider the relatively simpler symplectic product. Recall that the symplectic product of  $u = (a|b)$  and  $v = (a'|b')$  in  $\mathbb{F}_q^{2n}$  is defined as  $\langle u|v \rangle_s = \langle (a|b)|(a'|b') \rangle_s = a' \cdot b - a \cdot b'$ . The symplectic dual of a code  $C \subseteq \mathbb{F}_q^{2n}$  is defined as  $C^{\perp_s} = \{x \in \mathbb{F}_q^{2n} \mid \langle x|y \rangle_s = 0, \text{ for all } y \in C\}$ . As we shall be concerned with  $\mathbb{F}_q$ -linear codes in this chapter, we will focus only on the symplectic inner product in the rest of the chapter.

**Lemma VI.1.** *Let  $C \subseteq \mathbb{F}_q^{2n}$  be an  $\mathbb{F}_q$ -linear code. Then  $C$  has an  $\mathbb{F}_q$ -linear basis of the form*

$$B = \{z_1, \dots, z_k, z_{k+1}, x_{k+1}, z_{k+2}, x_{k+2}, \dots, z_{k+r}, x_{k+r}\}$$

where  $\langle x_i|x_j \rangle_s = 0 = \langle z_i|z_j \rangle_s$  and  $\langle x_i|z_j \rangle_s = \delta_{i,j}$ .

*Proof.* First we choose a basis  $B = \{z_1, \dots, z_k, z_{k+1}, \dots, z_{k+r}\}$  for a maximal isotropic subspace  $C_0$  of  $C$ . If  $C_0 \neq C$ , then we can choose a codeword  $x_{k+1}$  in  $C$  that is orthogonal to all of the  $z_i$  except one, say  $z_{k+1}$  (renumbering if necessary). We can scale  $x_{k+1}$  by an element in  $\mathbb{F}_q^\times$  so that  $\langle z_{k+1}|x_{k+1} \rangle_s = 1$ . If  $\langle C_0, x_{k+1} \rangle \neq C$ , then we repeat the process by choosing another codeword  $x_{k+i}$  that is orthogonal to all the previously chosen  $\{x_{k+1}, \dots, x_{k+i-1}\}$  and all  $z_i$  except  $z_{k+i}$ , until we have a basis of the desired form.  $\square$

For the remainder of the section, we fix the following notation. By Theorem V.10, we can associate with an  $\mathbb{F}_q$ -linear  $[[n, k, r, d]]_q$  subsystem code two classical  $\mathbb{F}_q$ -linear codes  $C, D \subseteq \mathbb{F}_q^{2n}$  such that  $D = C \cap C^{\perp_s}$ ,  $|C| = q^{n-k+r}$ ,  $|D| = q^{n-k-r}$  and  $\text{swt}(D^{\perp_s} \setminus C) = d$ .

By lemma VI.1, we can also assume that  $C$  is generated by

$$C = \langle z_1, \dots, z_s, z_{s+1}, x_{s+1}, \dots, z_{s+r}, x_{s+r} \rangle,$$

where  $s = n - k - r$  and the vectors  $x_i, z_i$  in  $\mathbb{F}_q^{2n}$  satisfy the relations  $\langle x_i | x_j \rangle_s = 0 = \langle z_i | z_j \rangle_s$  and  $\langle x_i | z_j \rangle_s = \delta_{i,j}$ . These relations on  $x_i, z_i$  imply that

$$\begin{aligned} C^{\perp_s} &= \langle z_1, \dots, z_s, z_{s+r+1}, x_{s+r+1}, \dots, z_{s+r+k}, x_{s+r+k} \rangle, \\ D = C \cap C^{\perp_s} &= \langle z_1, \dots, z_s \rangle, \\ D^{\perp_s} &= \langle z_1, \dots, z_s, z_{s+1}, x_{s+1}, \dots, z_n, x_n \rangle. \end{aligned}$$

**Lemma VI.2.** *An  $\mathbb{F}_q$ -linear  $[[n, k, r > 0, d \geq 2]]_q$  Clifford subsystem code exactly pure to 1 can be punctured to an  $\mathbb{F}_q$ -linear  $[[n - 1, k, r - 1, \geq d]]_q$  code.*

*Proof.* As mentioned above, we can associate to the subsystem code two classical codes  $C, D \subseteq \mathbb{F}_q^{2n}$ . Two cases arise depending on  $\text{swt}(D)$ .

a) If  $\text{swt}(D) = 1$ , then without loss of generality we can assume that  $\text{swt}(z_1) = 1$ . Further,  $z_1$  can be taken to be of the form  $(1, 0, \dots, 0 | a, 0, \dots, 0)$ . And for  $i \neq 1$ , because of  $\mathbb{F}_q$ -linearity of the codes we can pick all  $x_i, z_i$  to be of the form  $(0, a_2, \dots, a_n | b_1, b_2, \dots, b_n)$ . Further, as  $x_i, z_i$  must satisfy the orthogonality relations with  $z_1$  viz.,  $\langle z_1 | z_i \rangle_s = 0 = \langle z_1 | x_i \rangle_s$ , for  $i > 1$  we can choose  $x_i, z_i$  to be of the form  $(0, a_2, \dots, a_n | 0, b_2, \dots, b_n)$ . It follows that because of the form of  $x_i$  and  $z_i$  puncturing the first and  $n + 1^{\text{th}}$  coordinate will not alter these orthogonality relations, in particular  $\langle \rho(x_i) | \rho(z_i) \rangle_s \neq 0$  for  $s + 1 \leq i \leq n$ .

Letting  $\rho(x_i) = x'_i, \rho(z_i) = z'_i$  and observing that  $\rho(z_1) = (0, \dots, 0 | 0, \dots, 0)$ , we see that the code  $\rho(C) = \langle z'_2, \dots, z'_s, z'_{s+1}, x'_{s+1}, \dots, z'_{s+r}, x'_{s+r} \rangle$ . Denoting by  $D_p = \rho(C) \cap \rho(C)^{\perp_s}$  it is immediate that  $D_p$  is generated by  $\{z'_2, \dots, z'_s\}$  while  $D_p^{\perp_s} = \langle z'_2, \dots, z'_s, z'_{s+1}, x'_{s+1}, \dots, z'_n, x'_n \rangle$ . Hence  $\rho(C)$  defines an  $[[n - 1, k, r, \text{swt}(D_p^{\perp_s} \setminus \rho(C))]]_q$

code.

Next we show that  $\text{swt}(D_p^{\perp s} \setminus \rho(C)) \geq d$ . Let  $u = (a_2, \dots, a_n | b_2, \dots, b_n)$  be in  $D_p^{\perp s} \setminus \rho(C)$ , then we can easily verify that  $(0, a_2, \dots, a_n | 0, b_2, \dots, b_n)$  is orthogonal to all  $z_i$ ,  $1 \leq i \leq s$  and hence it is in  $D^{\perp s}$ . It cannot be in  $C$  as that would imply that  $u$  is in  $\rho(C)$ . But  $\text{swt}(D^{\perp s} \setminus C) \geq d$ . Therefore  $\text{swt}(u) \geq d$ . and  $\rho(C)$  defines an  $[[n-1, k, r, \geq d]]_q$  code. By choosing  $C' = \langle z'_2, \dots, z'_s, z'_{s+1}, z'_{s+2}, x'_{s+2}, \dots, z'_{s+r}, x'_{s+r} \rangle$  we can conclude that there exists an  $[[n-, k, r-1, d]]_q$  code. Alternatively, apply Theorem 16 in [6].

- b) If  $\text{swt}(D) > 1$ , then we can assume that  $\text{swt}(z_{s+1}) = 1$  and form the code  $C' = \langle z_1, \dots, z_s, z_{s+1}, z_{s+2}, x_{s+2}, \dots, z_{s+r}, x_{s+r} \rangle$ . It is clear that  $C'$  defines an  $[[n, k, r-1, d]]_q$  code that is pure to 1 with  $\text{swt}(C' \cap C'^{\perp s}) = 1$ . But this is just the previous case, from which we can conclude that there exists an  $[[n-1, k, r-1, \geq d]]_q$  code.

□

Lemma VI.2 allows us to establish a bound for distance 2 codes which can then be used to prove the bound for arbitrary distances.

**Lemma VI.3.** *An impure  $\mathbb{F}_q$ -linear  $[[n, k, r, d = 2]]_q$  Clifford subsystem code satisfies*

$$k + r \leq n - 2d + 2.$$

*Proof.* Suppose that there exists an  $\mathbb{F}_q$ -linear  $[[n, k, r, d = 2]]_q$  impure subsystem code such that  $k + r > n - 2d + 2$ ; in particular, this code must be pure to 1. By Lemma VI.2 it can be punctured to give an  $[[n-1, k, r-1, \geq d]]_2$  subsystem code. If this code is pure, then  $k + r - 1 \leq n - 1 - 2d + 2$  holds, contradicting our assumption  $k + r > n - 2d + 2$ ; hence, the resulting code is once again impure and pure to 1.

Now we repeatedly apply Lemma VI.2 to puncture the shortened codes until we get an  $[[n-r, k, 0, \geq d]]_q$  subsystem code. But this is a stabilizer code which must obey the Singleton bound  $k \leq n - r - 2d + 2$ , contradicting our initial assumption  $k + r > n - 2d + 2$ .

Therefore, we can conclude that  $k + r \leq n - 2d + 2$ .  $\square$

If the codes are of distance greater than 2, then we puncture the code until it either has distance 2 or it is a pure code. The following result tells us how the parameters of the subsystem codes vary on puncturing.

**Lemma VI.4.** *An impure  $\mathbb{F}_q$ -linear  $[[n, k, r, d \geq 3]]_q$  Clifford subsystem code exactly pure to  $d' \geq 2$  implies the existence of an  $\mathbb{F}_q$ -linear  $[[n - 1, k, r + 1, \geq d - 1]]_q$  subsystem code.*

*Proof.* Recall that the existence of an  $[[n, k, r, d \geq 3]]_q$  subsystem code implies the existence of  $\mathbb{F}_q$ -linear codes  $C$  and  $D$  such that

$$C = \langle z_1, \dots, z_s, z_{s+1}, x_{s+1}, \dots, z_{s+r}, x_{s+r} \rangle,$$

with  $s = n - k - r$ , and  $D = C \cap C^{\perp_s}$ , see above.

The stabilizer code defined by  $D$  satisfies  $k + r = n - s \leq n - 2d' + 2$ , or equivalently  $s \geq 2d - 2$ ; it follows that  $s \geq 2$ , since  $d' \geq 2$ . Without loss of generality, we can take  $z_1$  to be of the form  $(1, a_2, \dots, a_n | b_1, b_2, \dots, b_n)$  for if no such codeword exists in  $D$ , then  $(0, 0, \dots, 0 | 1, 0, \dots, 0)$  is contained in  $D^{\perp_s}$ , contradicting the fact that  $\text{swt}(D^{\perp_s}) \geq 2$ . Consequently, we can choose  $z_2$  in  $D$  to be of the form  $(0, c_2, \dots, c_n | 1, d_2, \dots, d_n)$ , and we may further assume that  $b_1 = 0$  in  $z_1$ . The form of  $z_1$  and  $z_2$  allows us to assume that any remaining generator of  $C$  is of the form  $(0, u_2, \dots, u_n | 0, v_2, \dots, v_n)$ .

Let  $\rho$  be the map defined by puncturing the first and  $(n + 1)^{\text{th}}$  coordinate of a vector in  $C$ . Define for all  $i$  the punctured vectors  $x'_i = \rho(x_i)$  and  $z'_i = \rho(z_i)$ . Then one easily checks that  $\langle \rho(x_i) | \rho(x_j) \rangle_s = 0 = \langle \rho(z_i) | \rho(z_j) \rangle_s$  for all indices  $i$  and  $j$ , and  $\langle \rho(x_i) | \rho(z_j) \rangle_s = \delta_{i,j}$  if  $i \geq s + 1$  or  $j \geq 3$ , and that  $\langle \rho(z_1) | \rho(z_2) \rangle_s = -1$ .

Let us look at the punctured code  $\rho(C)$ ,

$$\rho(C) = \langle z'_3, \dots, z'_s, z'_{s+1}, x'_{s+1}, \dots, z'_{s+r}, x'_{s+r}, z'_1, z'_2 \rangle.$$



Since  $\langle \rho(z_1) \mid \rho(z_2) \rangle_s = -1$  we have  $D_p = \rho(C) \cap \rho(C)^{\perp_s} = \langle z'_3, \dots, z'_s \rangle$ , whence  $|D_p| = |D|/q^2$ . As  $\text{swt}(C) \geq 2$ , it follows that  $|\rho(C)| = |C|$ . Thus  $\rho(C)$  defines an  $[[n-1, k, r+1, \text{swt}(D_p^{\perp_s} \setminus \rho(C))]]_q$  subsystem code.

Recall that the code  $D$  is generated by  $s \geq 2$  vectors; we will show next that our assumptions actually force  $s \geq 3$ . Indeed, if  $s = 2$ , then  $|D| = q^2$  and  $|D^{\perp_s}| = q^{2n-2}$ . Under the assumption  $\text{swt}(D^{\perp_s}) \geq 2$ , it follows that  $|\rho(D^{\perp_s})| = |D^{\perp_s}| = q^{2n-2}$ . But as  $\rho(D^{\perp_s}) \subseteq \mathbb{F}_q^{2n-2}$  this implies that  $\rho(D^{\perp_s}) = \mathbb{F}_q^{2n-2}$ . Since  $\mathbb{F}_q^{2n-2}$  has  $2n-2$  independent codewords of symplectic weight one,  $D^{\perp_s}$  must have  $2n-2$  independent codewords of symplectic weight two. However, this contradicts our assumptions on the minimum distance of the subsystem code:

- (a) If  $C$  is a proper subspace of  $D^{\perp_s}$ , then the minimum distance  $d$  is given by  $d = \text{swt}(D^{\perp_s} \setminus C) \geq 3$ ; thus, the weight 2 vectors must all be contained in  $C$ , which shows that  $|C| = q^{2n-2} = |D|$ , contradicting  $|C| < |D^{\perp_s}|$ .
- (b) If  $C = D^{\perp_s}$ , then the minimum distance is given by  $d = \text{swt}(D^{\perp_s}) = 2$ , contradicting our assumption that  $d \geq 3$ .

Thus, from now on, we can assume that  $s \geq 3$ .

Before bounding the minimum distance of the punctured subsystem code, we are going to show that  $D_p^{\perp_s} = \rho(D^{\perp_s})$ . Let  $w = (u_1, u_2, \dots, u_n \mid v_1, v_2, \dots, v_n)$  be a vector in  $D^{\perp_s}$ . For  $3 \leq i \leq s$ , the vectors  $z_i$  are of the form  $(0, a_2, \dots, a_n \mid 0, b_2, \dots, b_n)$ ; thus, it follows from  $\langle w \mid z_i \rangle_s = 0$  that  $\langle \rho(w) \mid z'_i \rangle_s = 0$ . Hence  $\rho(w)$  is in  $D_p^{\perp_s}$ , which implies  $\rho(D^{\perp_s}) \subseteq D_p^{\perp_s}$ . We have  $|D_p^{\perp_s}| = q^{2n-2}/|D_p| = q^{2n}/|D| = |D^{\perp_s}|$ , and we note that  $|D^{\perp_s}| = |\rho(D^{\perp_s})|$ , because  $\text{swt}(D^{\perp_s}) \geq 2$ ; hence,  $D_p^{\perp_s} = \rho(D^{\perp_s})$ .

Let  $w' = (u_2, \dots, u_n \mid v_2, \dots, v_n)$  be an arbitrary vector in  $\rho(D^{\perp_s}) \setminus \rho(C)$ . It follows that there exist some  $\alpha, \beta$  in  $\mathbb{F}_q$  such that  $w = (\alpha, u_2, \dots, u_n \mid \beta, v_2, \dots, v_n)$  is in  $D^{\perp_s}$ ; it is clear that  $w$  cannot be in  $C$ , since then  $\rho(w) = w'$  would be in  $\rho(C)$ ; hence,  $\text{swt}(w) \geq d$ . It immediately follows that  $\text{swt}(D_p^{\perp_s} \setminus \rho(C)) \geq d-1$ . Hence  $\rho(C)$  defines an  $[[n-1, k, r+1, \geq$

$d - 1]]_q$  subsystem code. □

Now we are ready to prove the upper bound for an arbitrary subsystem code. Essentially we reduce it to a pure code or distance two code by repeated puncturing and bound the parameters by carefully tracing the changes.

**Theorem VI.5.** *An  $\mathbb{F}_q$ -linear  $[[n, k, r, d \geq 2]]_q$  Clifford subsystem code satisfies*

$$k + r \leq n - 2d + 2. \quad (6.1)$$

*Proof.* The bound holds for all pure codes, see [6]. So assume that the code is impure. If  $d = 2$ , then the relation holds by Lemma VI.3; so let  $d \geq 3$ . If the code is exactly pure to 1, then it can be punctured using Lemma VI.2 to give an  $[[n - 1, k, r - 1, d' = d]]_q$  code, otherwise it can be punctured using Lemma VI.4 to obtain an  $[[n - 1, k, r + 1, d' \geq d - 1]]_q$  code. If the punctured code is pure, then it follows that either  $k + r - 1 \leq n - 1 - 2d + 2$  or  $k + r + 1 \leq n - 1 - 2d' + 2 \leq n - 1 - 2(d - 1) + 2$  holds; in both cases, these inequalities imply that  $k + r \leq n - 2d + 2$ .

If the resulting code is impure, then if it is exactly pure to 1 we puncture the code again using Lemma VI.2, if not we puncture using Lemma VI.4, until we get a pure code or a code with distance two. Assume that we punctured  $i$  times using Lemma VI.2 and  $j$  times using Lemma VI.4, then the resulting code is an  $[[n - i - j, k, r + j - i, d' \geq d - j]]_q$  subsystem code. Since pure subsystem codes and distance 2 subsystem codes satisfy

$$k + r + j - i \leq n - i - j - 2d' + 2 \leq n - i - j - 2(d - j) + 2,$$

it follows that  $k + r \leq n - 2d + 2$  holds. □

When the subsystem codes are over a prime alphabet, this bound holds for all codes over that alphabet. In the more general case where the code is not linear, numerical evidence indicates that it is unlikely that the additive subsystem codes have a different bound. We

have shown that a large class of impure codes already satisfy this bound. This prompts the following conjecture.

**Conjecture VI.6.** *Any  $[[n, k, r, d]]_q$  Clifford subsystem code satisfies  $k + r \leq n - 2d + 2$ .*

## B. Comparing Subsystem Codes with Stabilizer Codes

In this section, we compare stabilizer codes with subsystem codes. We first need to establish the criteria for the comparison, since subsystem codes cannot be universally better than stabilizer codes. For example, it is known that a subsystem code can be converted to a stabilizer code [100, 120]. See also Lemma 10 in [6] for a simple proof to convert an  $[[n, k, r, d]]_q$  code to an  $[[n, k, d]]_q$  code. This implies that no  $[[n, k, r, d]]_q$  subsystem code can beat an optimal  $[[n, k, d']]_q$  stabilizer code in terms of minimum distance, as  $d' \geq d$ . One of the attractive features of subsystem codes is a potential reduction of the number of syndrome measurements, and we use this criterion as the basis for our comparison.

First, we must highlight a subtle point on the required number of syndrome bits for an  $\mathbb{F}_q$ -linear  $[n, k, d]_q$  code. A complete decoder, will require  $n - k$  syndrome bits. Complete decoders are also optimal decoders. A bounded distance decoder on the other hand can potentially decode with fewer syndrome bits. Bounded distance decoders typically decode up to  $\lfloor (d - 1)/2 \rfloor$ . However, to the best of our knowledge, except for the lookup table decoding method, all bounded distance decoders also require  $n - k$  syndrome bits. As the complexity of decoding using a lookup table increases exponentially in  $n - k$  it is highly impractical for long lengths. We therefore assume that for practical purposes, that we need  $n - k$  syndrome bits.

Similarly, for an  $\mathbb{F}_q$ -linear  $[[n, k, r, d]]_q$  subsystem code, a complete decoder will require  $n - k - r$  syndrome measurements, as is shown in E. We are not aware of any quantum code, stabilizer or subsystem, for which there exists a bounded distance decoder that uses

less than  $n - k - r$  syndrome measurements to perform bounded distance decoding. The work by Poulin [120] prompts the following question: Given an optimal  $[[k + 2d - 2, k, d]]_q$  MDS stabilizer code, is it possible to find an  $[[n, k, r, d]]_q$  subsystem code that uses fewer syndrome measurements?

There exist numerous known examples of subsystem codes that improve upon nonoptimal stabilizer codes. The fact that the stabilizer code is assumed to be optimal makes this question interesting. The Singleton bound  $k + r \leq n - 2d + 2$  of an  $\mathbb{F}_q$ -linear  $[[n, k, r, d]]_q$  subsystem code implies that the number  $n - k - r$  of syndrome measurements is bounded by  $n - k - r \geq 2d - 2$ ; thus, for fixed minimum distance  $d$ , there exists a trade off between the dimension  $k$  and the difference  $n - r$  between length and number of gauge qudits.

**Corollary VI.7.** *Under complete decoding an  $\mathbb{F}_q$ -linear  $[[n, k, r, d \geq 2]]_q$  Clifford subsystem code cannot use fewer syndrome measurements than an  $\mathbb{F}_q$ -linear  $[[k + 2d - 2, k, d]]_q$  stabilizer code.*

*Proof.* Seeking a contradiction, we assume that there exists an  $[[n, k, r, d]]_q$  subsystem code that requires fewer syndrome measurements than the optimal  $[[k + 2d - 2, k, d]]_q$  MDS stabilizer code. In other words, the number of syndrome measurement yield the inequality  $k + 2d - 2 - k > n - k - r$ , which is equivalent to  $k + r > n - 2d + 2$ , but this contradicts the Singleton bound.  $\square$

Poulin [120] showed by exhaustive computer search that there does not exist an  $[[5, 1, r > 0, 3]]_2$  subsystem code. The above result confirms his computer search and shows further that not even allowing longer lengths and more gauge qudits can help in reducing the number of syndrome measurements. In fact, we conjecture that corollary VI.7 holds for bounded distance decoders also.

We wish to caution the reader that gains in error recovery cannot be quantified purely by the number of syndrome measurements. In practice, more complex measures such as

the simplicity of the decoding algorithm or the resulting threshold in fault-tolerant quantum computing are more relevant. The drawback is that the comparison of large classes of codes becomes unwieldy when such complex criteria are used.

### C. Subsystem Codes on a Lattice

Bacon gave the first family of subsystem codes generalizing the ideas of Shor's  $[[9, 1, 3]]_2$  code [18]. Recently, he and Casaccino gave another construction which generalizes this further by considering a pair of classical codes [19]. We show that this method is a special case of Theorem V.13. Since this construction is not limited to binary codes and our proofs remain essentially the same, we will immediately discuss a generalization to nonbinary alphabets.

**Theorem VI.8.** *For  $i \in \{1, 2\}$ , let  $C_i \subseteq \mathbb{F}_q^{n_i}$  be  $\mathbb{F}_q$ -linear codes with the parameters  $[n_i, k_i, d_i]_q$ . Then there exists a Clifford subsystem code with the parameters*

$$[[n_1 n_2, k_1 k_2, (n_1 - k_1)(n_2 - k_2), \min\{d_1, d_2\}]]_q$$

*that is pure to  $d_p = \min\{d_1^\perp, d_2^\perp\}$ , where  $d_i^\perp$  denotes the minimum distance of  $C_i^\perp$ .*

*Proof.* Let  $C$  be the classical linear code given by  $C = (\mathbb{F}_q^{n_1} \otimes C_2^\perp) \times (C_1^\perp \otimes \mathbb{F}_q^{n_2})$ . Then  $\dim C = n_1(n_2 - k_2) + n_2(n_1 - k_1)$  and  $\text{swt}(C \setminus \{0\}) \geq \min\{d_1^\perp, d_2^\perp\}$ . The symplectic dual of  $C$  is given by

$$\begin{aligned} C^{\perp_s} &= (C_1^\perp \otimes \mathbb{F}_q^{n_2})^\perp \times (\mathbb{F}_q^{n_1} \otimes C_2^\perp)^\perp \\ &= (C_1 \otimes \mathbb{F}_q^{n_2}) \times (\mathbb{F}_q^{n_1} \otimes C_2). \end{aligned}$$

We have  $\dim C^{\perp s} = k_1 n_2 + n_1 k_2$ . The code  $D = C \cap C^{\perp s}$  is given by

$$\begin{aligned} D &= ((\mathbb{F}_q^{n_1} \otimes C_2^\perp) \times (C_1^\perp \otimes \mathbb{F}_q^{n_2})) \cap ((C_1 \otimes \mathbb{F}_q^{n_2}) \times (\mathbb{F}_q^{n_1} \otimes C_2)) \\ &= ((\mathbb{F}_q^{n_1} \otimes C_2^\perp) \cap (C_1 \otimes \mathbb{F}_q^{n_2})) \times ((C_1^\perp \otimes \mathbb{F}_q^{n_2}) \cap (\mathbb{F}_q^{n_1} \otimes C_2)) \\ &= (C_1 \otimes C_2^\perp) \times (C_1^\perp \otimes C_2), \end{aligned}$$

and  $\dim D = k_1(n_2 - k_2) + k_2(n_1 - k_1)$ . It follows that  $\dim C - \dim D = 2(n_1 - k_1)(n_2 - k_2)$  and  $\dim C^{\perp s} - \dim D = 2k_1 k_2$ . Using corollary V.13, we can get a subsystem code with the parameters

$$[[n_1 n_2, k_1 k_2, (n_1 - k_1)(n_2 - k_2), d = \text{swt}(D^{\perp s} \setminus C)]]_q$$

that is pure to  $d_p = \min\{d_1^\perp, d_2^\perp\}$ . It remains to show that  $d = \min\{d_1, d_2\}$ .

Since  $D = (C_1 \otimes C_2^\perp) \times (C_1^\perp \otimes C_2)$ , we have

$$\begin{aligned} D^{\perp s} &= (C_1^\perp \otimes C_2)^\perp \times (C_1 \otimes C_2^\perp)^\perp \\ &= ((C_1 \otimes \mathbb{F}_q^{n_2}) + (\mathbb{F}_q^{n_1} \otimes C_2^\perp)) \times ((\mathbb{F}_q^{n_1} \otimes C_2) + (C_1^\perp \otimes \mathbb{F}_q^{n_2})). \end{aligned}$$

In the last equality, we used the fact that vectors  $u_1 \otimes u_2$  and  $v_1 \otimes v_2$  are orthogonal if and only if  $u_1 \perp v_1$  or  $u_2 \perp v_2$ .

For  $i \in \{1, 2\}$ , let  $G_i$  and  $H_i$  respectively denote the generator and parity check matrix of the code  $C_i$ . Without loss of generality, we may assume that these matrices are in standard form

$$H_i = \begin{bmatrix} I_{n_i - k_i} & P_i \end{bmatrix} \text{ and } G_i = \begin{bmatrix} -P_i^t & I_{k_i} \end{bmatrix},$$

where  $P_i^t$  is the transpose of  $P_i$ . Let  $H_i^c = \begin{bmatrix} 0 & I_{k_i} \end{bmatrix}$ . Using these notations, the generator

matrices of  $C$  and  $D^{\perp_s}$  can be written as

$$G_C = \begin{bmatrix} I_{n_1} \otimes H_2 & 0 \\ 0 & H_1 \otimes I_{n_2} \end{bmatrix} \quad \text{and} \quad G_{D^{\perp_s}} = \begin{bmatrix} G_1 \otimes H_2^c & 0 \\ I_{n_1} \otimes H_2 & 0 \\ 0 & H_1^c \otimes G_2 \\ 0 & H_1 \otimes I_{n_2} \end{bmatrix}.$$

It follows that the minimum distance  $d$  is given by

$$\text{swt}(D^{\perp_s} \setminus C) = \min \left\{ \text{wt} \left( \left\langle \begin{array}{c} G_1 \otimes H_2^c \\ I_{n_1} \otimes H_2 \end{array} \right\rangle \setminus \left\langle \begin{array}{c} I_{n_1} \otimes H_2 \end{array} \right\rangle \right), \right. \\ \left. \text{wt} \left( \left\langle \begin{array}{c} H_1^c \otimes G_2 \\ H_1 \otimes I_{n_2} \end{array} \right\rangle \setminus \left\langle \begin{array}{c} H_1 \otimes I_{n_2} \end{array} \right\rangle \right) \right\}.$$

Let us compute

$$\text{wt} \left( \left\langle \begin{array}{c} H_1^c \otimes G_2 \\ H_1 \otimes I_{n_2} \end{array} \right\rangle \setminus \left\langle \begin{array}{c} H_1 \otimes I_{n_2} \end{array} \right\rangle \right).$$

If minimum weight codeword is present in  $D^{\perp_s} \setminus C$ , it must be expressed as linear combination of at least one row from  $[H_1^c \otimes G_2]$  otherwise the codeword is entirely in  $C$ . Recall that  $H_1 = [ I_{n_1-k_1} \ P_1 ]$  and  $H_1^c = [ 0 \ I_{k_1} ]$ . Letting  $P_1 = (p_{ij})$ , we can write

$$\begin{bmatrix} H_1^c \otimes G_2 \\ H_1 \otimes I_{n_2} \end{bmatrix} = \begin{bmatrix} 0 & 0 & \dots & 0 & G_2 & 0 \\ 0 & 0 & \dots & 0 & 0 & G_2 & 0 \\ \dots & \dots & \dots & \dots & \dots & \dots & \dots \\ 0 & 0 & \dots & 0 & 0 & \dots & \dots & G_2 \\ \hline I_{n_2} & 0 & \dots & 0 & p_{11}I_{n_2} & \dots & \dots & p_{1k_1}I_{n_2} \\ 0 & I_{n_2} & \dots & \dots & p_{21}I_{n_2} & \dots & \dots & p_{2k_1}I_{n_2} \\ \dots & \dots & \dots & \dots & \dots & \dots & \dots & \dots \\ 0 & 0 & \dots & I_{n_2} & p_{(n_1-k_1)1}I_{n_2} & \dots & \dots & p_{(n_1-k_1)k_1}I_{n_2} \end{bmatrix}.$$

Now observe that any row below the line in the above matrix can have a weight of only one in each of the last  $k_1$  blocks of size  $n_2$ . And any linear combination of them involving less than  $d_2$  and at least one generator from the rows above must have a weight  $\geq d_2$ . If on the other hand there are more than  $d_2$  rows involved, then the first  $n_2(n_1 - k_1)$  columns will have a weight  $\geq d_2$ . Thus in either case the weight of an element that involves a generator from  $[H_1^c \otimes G_2]$  must have a weight  $\geq d_2$ . On the other hand, the minimum weight of the span of  $[H_1^c \otimes G_2]$  is  $\text{wt}(C_2) = d_2$ , from which we can conclude that

$$\text{wt} \left( \left\langle \begin{array}{c} H_1^c \otimes G_2 \\ H_1 \otimes I_{n_2} \end{array} \right\rangle \setminus \left\langle H_1 \otimes I_{n_2} \right\rangle \right) = d_2.$$

Because of the symmetry in the code we can argue that

$$\text{wt} \left( \left\langle \begin{array}{c} G_1 \otimes H_2^c \\ I_{n_1} \otimes H_2 \end{array} \right\rangle \setminus \left\langle I_{n_1} \otimes H_2 \right\rangle \right) = d_1$$

and consequently  $d = \min\{d_1, d_2\}$ , which proves the theorem.  $\square$

## 1. Bacon-Shor Codes

Bacon [18] proposed one of the first families of subsystem codes based on square lattices. A trivial modification using rectangular lattices instead of square ones gives the following codes, see also [19]. The relevance of these codes will be seen later in Section D. Using the same notation as in Theorem VI.8, let  $G_i = [1, \dots, 1]_{1 \times i}$  and  $H_i$  be the matrix defined





It is natural to ask if impure subsystem codes also satisfy this bound. We show that they do not by giving an explicit counterexample. This counter example comes from the codes proposed by [18]. Recall the Bacon-Shor codes are  $[[n^2, 1, (n-1)^2, n]]_2$  subsystem codes. The  $[[9, 1, 4, 3]]_2$  is an interesting code. We can check that it satisfies the Singleton bound for subsystem codes as

$$k + r = 1 + 4 = n - 2d + 2 = 9 - 6 + 2.$$

So it is an optimal code. More interestingly, substituting the parameters of the  $[[9, 1, 4, 3]]_2$  Bacon-Shor code in the above inequality we get

$$\sum_{j=0}^1 \binom{9}{j} 3^j = 28 > 2^{9-5} = 16.$$

Therefore the  $[[9, 1, 4, 3]]_2$  Bacon-Shor code beats the quantum Hamming bound for the pure subsystem codes proving the following result.

**Theorem VI.11.** *There exist impure  $((n, K, R, d))_q$  Clifford subsystem codes that do not satisfy*

$$\sum_{j=0}^{\lfloor (d-1)/2 \rfloor} \binom{n}{j} (q^2 - 1)^j \leq q^n / KR.$$

An obvious question is why impure codes can potentially pack more efficiently than the pure codes. Let us understand this by looking at the  $[[9, 1, 4, 3]]_2$  code a little more closely. This code encodes information into a subspace,  $Q$  where  $\dim Q = 2^{k+r} = 2^5$ . As it is a subsystem code  $Q$  can be decomposed as  $Q = A \otimes B$ , with  $\dim A = 2^k = 2$  and  $\dim B = 2^r = 2^4$ . In a pure single error correcting code all single errors must take the code space into orthogonal subspaces. In an impure code this is not required two or more distinct errors can take the code space to the same orthogonal space. In the Bacon-Shor code a phase flip error on any of the first three qubits will take the code space to same orthogonal subspace and because of this we cannot distinguish between these errors.

However, it is not a problem because we can restore the code space with respect to  $A$  even though we cannot restore  $B$ . Thus instead of requiring 9 orthogonal subspaces as in a pure code, we only require 3 orthogonal subspaces to correct for any single phase flip error. Considering the bit flip errors and the combinations we need only 9 orthogonal subspaces. Thus with the original code space this means we need to pack ten  $2^5$ -dimensional subspaces in the  $2^n = 2^9$  dimensional ambient space, which is achievable as  $10 \cdot 2^5 < 2^9$ .

More generally, in a sense degeneracy allows distinct errors to share the same orthogonal subspace and thus pack more efficiently. It must be pointed out though that this better packing is attained at the cost of  $r$  gauge qudits compared to a stabilizer code.

In fact there exists another code among the Bacon-Shor codes which also beats the Hamming bound for the subsystem codes. This is the  $[[25, 1, 16, 5]]_2$  code. The family of codes given in corollary VI.9 provides us with  $[[12, 1, 6, 3]]_2$ , yet another example of a code that beats the quantum Hamming bound like the  $[[9, 1, 4, 3]]_2$  code. We can check that

$$\sum_{j=0}^1 \binom{12}{j} 3^j = 37 > 2^{12-1-6} = 2^5 = 32.$$

But note that unlike  $[[9, 1, 4, 3]]_2$  this code does not meet the Singleton bound for pure subsystem codes as  $6 + 1 < 12 - 6 + 2$ . Naturally we can ask if there is a systematic method to construct codes that beat the quantum Hamming bound. Ashikhmin and Litsyn showed that all binary stabilizer codes – pure or impure – of sufficiently large length obey the quantum Hamming bound, ruling out the possibility that impure codes of large length can outperform pure codes with respect to sphere packing. In contrast we show that impure subsystem codes do not obey the quantum Hamming bound for pure subsystem codes, not even asymptotically. We show that there exist arbitrarily long Bacon-Shor codes that violate the quantum Hamming bound.

Degenerate quantum error-correcting codes pose many interesting questions in the

theory of quantum error-correction. The early discovery of the phenomenon of degeneracy raised the question whether degenerate quantum codes can perform better than nondegenerate quantum codes. One of the unresolved questions to this day in the theory of stabilizer codes is whether the bounds that hold for nondegenerate codes also hold for degenerate codes. Some bounds like the quantum Singleton bound do. But for others, like quantum Hamming bound, an answer remains elusive. Partial answers were provided by Gottesman [61] for single error-correcting and double error-correcting codes. Ashikhmin and Litsyn [12] showed that asymptotically degenerate codes cannot beat the quantum Hamming bound. *This leaves only a small range of degenerate binary stabilizer codes of moderate length that can potentially beat the quantum Hamming bound, but we conjecture that no such examples can be found.*

We show that the situation is markedly different in the case of subsystem codes (also known as operator quantum error-correcting codes [94, 99, 100]). The quantum Hamming for pure subsystem codes was derived in [6]. We have already shown that there exist impure subsystem codes that beat the quantum Hamming bound for pure subsystem codes. Now we address the question whether impure subsystem codes asymptotically obey the quantum Hamming bound, as in the case of binary stabilizer codes. We show that there exist impure subsystem codes of arbitrarily large length that beat the quantum Hamming (or sphere-packing) bound.

For the binary cases the quantum Hamming bound for subsystem codes states that a pure  $[[n, k, r, d]]$  subsystem code satisfies

$$2^{n-k-r} \geq \sum_{j=0}^{\lfloor (d-1)/2 \rfloor} \binom{n}{j} 3^j. \quad (6.3)$$

We claim that all the Bacon-Shor codes [18, 19] of odd lengths *i.e.*,  $[[ (2t+1)^2, 1, 4t^2, 2t+1 ]]$

violate the quantum Hamming bound, namely that

$$2^{(2t+1)^2-1-4t^2} = 2^{4t} \not\geq \sum_{j=0}^t \binom{(2t+1)^2}{j} 3^j$$

holds for all positive integers  $t$ . It suffices to show that

$$2^{4t} < \binom{(2t+1)^2}{t} 3^t \tag{6.4}$$

holds for all positive integers  $t$ . Since  $0 < 4(t - 1/6)^2 + 8/9 = 4t^2 - 4t/3 + 1$ , we have

$$\frac{16t}{3} < 4t^2 + 1 + 4t$$

for all  $t > 0$ . Multiplying both sides by  $3/t$  and raising to the  $t^{\text{th}}$  power yields

$$2^{4t} < \frac{3^t(2t+1)^{2t}}{t^t},$$

which proves the inequality (6.4), as  $\binom{n}{k} \geq n^t k^{-t}$ . Thus, we can conclude that the Bacon-Shor codes of odd length do not obey the quantum Hamming bound.

**Theorem VI.12.** *Asymptotically, the quantum Hamming bound (6.3) does not hold for impure subsystem codes.*

It is remarkable that there exist such families of subsystem codes that can pack more densely than any pure subsystem code. Further examples of such densely packing subsystem codes can be found among the family with parameters  $[[n_1 n_2, 1, (n_1 - 1)(n_2 - 1), \min\{n_1, n_2\}]]$ , which contains for instance a  $[[12, 1, 6, 3]]$  subsystem code.

## E. Conclusions

We have proved that any  $\mathbb{F}_q$ -linear  $[[n, k, r, d]]_q$  Clifford subsystem code obeys the Singleton bound  $k + r \leq n - 2d + 2$ . Furthermore, we have shown earlier that pure Clifford subsystem codes satisfy this bound as well. Our results provide much evidence for the

conjecture that the Singleton bound holds for arbitrary subsystem codes. Proving this for all additive subsystem codes will be an interesting problem.

Pure Clifford subsystem codes obey the Hamming (or sphere packing) bound. In this chapter, we have shown the amazing fact that there exist impure Clifford subsystem codes beating the Hamming bound. This is the first illustration of a case when impure codes pack more efficiently than their pure counterparts. One example of a code beating the Hamming bound is provided by the  $[[9, 1, 4, 3]]_2$  Bacon-Shor code; this remarkable example also illustrates the following noteworthy facts:

- a) The  $[[9, 1, 4, 3]]_2$  code requires  $9 - 1 - 4 = 4$  syndrome measurements just like the perfect  $[[5, 1, 3]]_2$  code.
- b) Since  $k + r \leq n - 2d + 2$  for all prime alphabet codes,  $[[9, 1, 4, 3]]_2$  code is also an optimal subsystem code. This is interesting because the underlying classical codes are not MDS. In MDS stabilizer codes, the underlying classical codes are required to be MDS codes.
- c) The Bacon-Shor code is also impure. So unlike MDS stabilizer codes which must be pure, MDS subsystem codes can be impure.
- d) The maximal length of a  $q$ -ary stabilizer MDS code is  $2q^2 - 2$ , see Theorem IV.25 whereas for subsystem codes it is larger as the  $[[9, 1, 4, 3]]_2$  code indicates.

The implication of b)–d) is that optimal subsystem codes can be derived from suboptimal classical codes, unlike stabilizer codes. It would be an interesting problem to determine what are the conditions under which a non-MDS classical code will lead to an MDS subsystem code.

## CHAPTER VII

## ENCODING AND DECODING OF SUBSYSTEM CODES

## A. Introduction

In this chapter we investigate encoding and to some extent decoding of subsystem codes. Our main result is that encoding of a subsystem code can be reduced to the encoding of a related stabilizer code, thereby making use of the previous theory on encoding stabilizer codes [42, 61, 73]. We shall prove this in two steps. First, we shall show that Clifford codes can be encoded using the same methods used for stabilizer codes. Secondly, we shall show how these methods can be adapted to encode Clifford subsystem codes. Since subsystem codes subsume stabilizer codes, noiseless subsystems and decoherence free subspaces, these results imply that we can essentially use the same methods to encode all these codes. In fact, while the exact details were not provided it was suggested in [121] that encoding of subsystem codes can be achieved by Clifford unitaries. Our treatment is comprehensive and gives proofs for all the claims.

Subsystem codes can potentially lead to simpler error recovery schemes. In a similar vein, they can also simplify the encoding process, though perhaps not as dramatically\*. These simplifications have not been investigated thoroughly, neither have the gains in encoding been fully characterized. Essentially, these gains are in two forms. In the encoded state there need not exist a one to one correspondence between the gauge qubits and the physical qubits. However, prior to encoding such a correspondence exists. We can exploit this identification between the virtual qubits and the physical qubits before encoding to tolerate errors on the gauge qubits, a fact which was recognized in [121]. Alternatively,

---

\*In general, decoding is usually of greater complexity than encoding and for this reason it is often neglected in comparison. This parallels the classical case where also the decoding is studied much more extensively than encoding.

we can optimize the encoding circuits by eliminating certain encoding operations. The encoding operations that are saved correspond to the encoded operators on the gauge qubits. This is a slightly subtle point and will be elaborated at length subsequently. We argue that optimizing the encoding circuit for the latter is much more beneficial than simply allowing for random initialization of gauge qubits.

*Notation.* The inner product of two characters of a group  $N$ , say  $\chi$  and  $\theta$ , is defined as  $(\chi, \theta)_N = 1/|N| \sum_{n \in N} \chi(n)\theta(n^{-1})$ . We shall denote the center of a group  $N$  by  $Z(N)$ . Given a subgroup  $N \leq E$ , we shall denote the centralizer of  $N$  in  $E$  by  $C_E(N)$ . Given a matrix  $A$ , we consider another matrix  $B$  obtained from  $A$  by column permutation  $\pi$  as being equivalent and denote this by  $B =_{\pi} A$ . Often we shall represent the basis of a group by the rows of a matrix. In this case we will regard another basis obtained by any row operations or permutations as being equivalent and by a slight abuse of notation continue to denote  $B =_{\pi} A$ . The commutator of two operators  $A, B$  is defined as  $[A, B] = AB - BA$ . This can potentially conflict with our definition of commutator in Chapter V as  $[x, y] = xyx^{-1}y^{-1}$ . However, in this chapter we will not have occasion to use this definition.

## B. Encoding Stabilizer Codes – A Review

Recall the Pauli matrix operators<sup>†</sup>,

$$X = \begin{bmatrix} 0 & 1 \\ 1 & 0 \end{bmatrix}, \quad Z = \begin{bmatrix} 1 & 0 \\ 0 & -1 \end{bmatrix}, \quad Y = \begin{bmatrix} 0 & -1 \\ 1 & 0 \end{bmatrix} = XZ. \quad (7.1)$$

Let  $\mathcal{P}_n$  be the Pauli group on  $n$  qubits. An element  $e = (-1)^c X^{a_1} Z^{b_1} \otimes \dots \otimes X^{a_n} Z^{b_n}$  in  $\mathcal{P}_n$ , can be mapped to  $\mathbb{F}_2^{2n}$  by  $\tau : \mathcal{P}_n \rightarrow \mathbb{F}_2^{2n}$  as

$$\tau(e) = (a_1, \dots, a_n | b_1, \dots, b_n). \quad (7.2)$$

---

<sup>†</sup>We consider the real version of the Pauli group in this chapter.



Given an  $[[n, k, d]]_2$  code with stabilizer  $S$ , we can associate to  $S$  (and therefore the code), a matrix in  $\mathbb{F}_2^{(n-k) \times 2n}$  obtained by taking the image of any set of its generators under the mapping  $\tau$ . We shall refer to this matrix as the *stabilizer matrix*. We shall refer to the stabilizer as well as any set of generators as the stabilizer. Additionally, because of the mapping  $\tau$ , we shall refer to the stabilizer matrix or any matrix obtained from it by row reduction or column permutations also as the stabilizer. The stabilizer matrix can be put in the so-called “standard form”, see [42, 61]. This form also allows us to compute the encoded operators for the stabilizer code. Recall that the encoded operators allow us to perform computations on the encoded data without having to decode the data and then compute.

**Definition VII.1** (Encoded operators). *Given a  $[[n, k, d]]_2$  stabilizer code with stabilizer  $S$ , let  $\overline{X}_i, \overline{Z}_i$  for  $1 \leq i \leq k$  be a set of  $2k$  linearly independent operators in  $C_{\mathcal{P}_n}(S) \setminus SZ(\mathcal{P}_n)$ . The operators  $\overline{X}_i, \overline{Z}_i$  are said to be encoded operators for the code if they satisfy the following requirements.*

- i)  $[\overline{X}_i, \overline{X}_j] = 0$
- ii)  $[\overline{Z}_i, \overline{Z}_j] = 0$
- iii)  $[\overline{X}_i, \overline{Z}_j] = 2\delta_{ij}\overline{X}_i\overline{Z}_i$

The operators  $\overline{X}_i$  and  $\overline{Z}_j$  are referred to as encoded or logical  $X$  and  $Z$  operators on the  $i$ th and  $j$ th logical qubits, respectively. The choice of which of the  $2k$  linearly independent elements of  $C_{\mathcal{P}_n}(S) \setminus SZ(\mathcal{P}_n)$  we choose to call encoded  $X$  operators and  $Z$  operators is arbitrary; as long as the generators satisfy the conditions above, any choice is valid. Different choices lead to different sets of encoded logical states; alternatively, a different orthonormal basis for the codespace.

**Lemma VII.2** (Standard form of stabilizer matrix [42, 61]). *Up to a permutation  $\pi$ , the*

stabilizer matrix of an  $[[n, k, d]]_2$  code can be put in the following form,

$$S =_{\pi} \left[ \begin{array}{ccc|ccc} I_{s'} & A_1 & A_2 & B & 0 & C \\ 0 & 0 & 0 & D & I_{n-k-s'} & E \end{array} \right], \quad (7.3)$$

while the associated encoded operators can be derived as

$$\left[ \begin{array}{c} \overline{Z} \\ \overline{X} \end{array} \right] =_{\pi} \left[ \begin{array}{ccc|ccc} 0 & 0 & 0 & A_2^t & 0 & I_k \\ 0 & E^t & I_k & C^t & 0 & 0 \end{array} \right]. \quad (7.4)$$

**Remark VII.3.** Encoding using essentially same ideas is possible even if the identity matrices  $I_{s'}$  in the stabilizer matrix or  $I_k$  in the encoded operators are replaced by upper triangular matrices.

The standard form of the stabilizer matrix prompts us to distinguish between two types of the generators for the stabilizer as they affect the encoding in different ways (although it can be shown that they are of equivalent complexity).

**Definition VII.4** (Primary generators). A generator  $G_i = (a_1, \dots, a_n | b_1, \dots, b_n)$  with at least one nonzero  $a_i$  is called a primary generator.

In other words, primary generators contain at least one  $X$  or  $Y$  operator on some qubit. The primary generators determine to a large extent the complexity of the encoding circuit along with the encoded  $X$  operators. The operators  $\overline{X}$  are also called seed generators and they also figure in the encoding circuit. The encoded  $Z$  operators do not.

**Definition VII.5** (Secondary generators). A generator of the form  $(0, \dots, 0 | b_1, \dots, b_n)$  is called secondary generator.

In the standard form encoding, the complexity of the encoded  $X$  operators is determined by the secondary generators. Therefore they indirectly contribute<sup>‡</sup> to the com-

---

<sup>‡</sup>Indirect because the submatrix  $E$ , figures in both the secondary generators, see equa-

plexity of encoding. We mentioned earlier that different choices of the encoded operators amounts to choosing different orthonormal basis for the codespace. However, the choice in Lemma VII.2 is particularly suitable for encoding. We can represent our input in the form  $|0\rangle^{\otimes n-k} |\alpha_1 \dots \alpha_k\rangle$  which allows us to make the identification that  $|0\rangle^{\otimes n}$  is mapped to  $|\bar{0}\rangle$ , the logical all zero code word. This state is precisely the state stabilized by the stabilizer generators and logical  $Z$  operators, (which in Lemma VII.2 can be seen to be consisting of only  $Z$  operators). Given the stabilizer matrix in the standard form and the encoded operators as in Lemma VII.2, the encoding circuit is given as follows.

**Lemma VII.6** (Standard form encoding stabilizer codes [42, 61]). *Let  $S$  be the stabilizer matrix of an  $[[n, k, d]]$  stabilizer code in the standard form i.e., as in equation (7.3). Let  $G_i$  denote the  $i$ th primary generator of  $S$  and  $\bar{X}_j$  denote the  $j$ th encoded  $X$  operator as in equation (7.4). Then these operators are in the form<sup>§</sup>*

$$G_i = (0, 0, \dots, 1, a_{i+1}, \dots, a_n | b_1, \dots, b_{s'}, 0, \dots, 0, b_{n-k+1}, \dots, b_n),$$

$$\bar{X}_j = (0, \dots, 0, c_{s'+1}, \dots, c_{n-k} | 0, \dots, 0, 1 = c_{n-k+j}, 0, \dots, 0 | d_1, \dots, d_{s'}, 0, \dots, 0).$$

To encode the stabilizer code we implement the following circuits corresponding to each of the primary generators and the encoded operators. The generator  $G_i$  is implemented after  $G_{i+1}$ . The encoded operators precede the primary generators in their implementation but

---

tion (7.3), and also the encoded  $X$  operators, see equation (7.4).

<sup>§</sup>We allow some freedom in the primary generators, in that instead of  $I_{s'}$  in equation (7.3), we allow it be an upper triangular matrix also.

we can implement  $\overline{X}_j$  before or after  $\overline{X}_{j+1}$ .

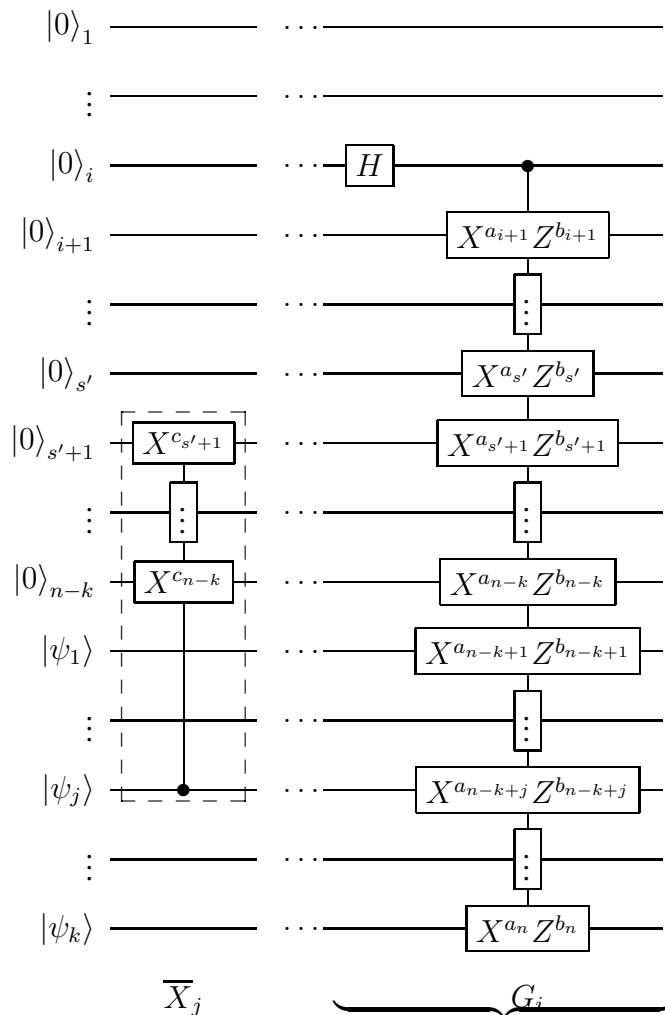

To encode a stabilizer code, we first put the stabilizer matrix in the standard form, then implement the seed generators i.e., the encoded  $X$  operators, followed by the primary generators  $i = s'$  to  $i = 1$  as per Lemma VII.6. The complexity of encoding the  $i$ th primary generator is at most  $n - i$  two qubit gates and one  $H$  gate. The complexity of encoding an encoded operator is at most  $n - k - s'$  CNOT gates. This means the complexity of standard form encoding is upper bounded by  $(2n - 1 - k - s')s'/2$  two qubit gates and  $s'$  Hadamard gates;  $O(n(n - k))$  gates. A minor modification ([66]) must be incorporated when  $Y$  is defined as  $Y = \begin{bmatrix} 0 & -i \\ i & 0 \end{bmatrix}$  as the following example illustrates. See [67] for more examples.

**Example VII.7.** Consider the  $[[5, 1, 3]]$  code with following stabilizer, with  $Y = \begin{bmatrix} 0 & -i \\ i & 0 \end{bmatrix}$ .

$$S = \begin{bmatrix} X & I & X & X & X \\ I & X & Z & X & Y \\ Z & I & Z & Z & Z \\ I & Z & Y & Z & X \end{bmatrix}$$

The associated stabilizer matrix is given by

$$S = \left[ \begin{array}{ccccc|ccccc} 1 & 0 & 1 & 1 & 1 & 0 & 0 & 0 & 0 & 0 \\ 0 & 1 & 0 & 1 & 1 & 0 & 0 & 1 & 0 & 1 \\ 0 & 0 & 0 & 0 & 0 & 1 & 0 & 1 & 1 & 1 \\ 0 & 0 & 1 & 0 & 1 & 0 & 1 & 1 & 1 & 0 \end{array} \right]$$

Writing  $S$  in standard form we get

$$S = \left[ \begin{array}{ccccc|ccccc} 1 & 0 & 0 & 1 & 0 & 1 & 1 & 0 & 0 & 1 \\ 0 & 1 & 0 & 1 & 1 & 0 & 0 & 1 & 0 & 1 \\ 0 & 0 & 1 & 0 & 1 & 1 & 1 & 0 & 0 & 1 \\ 0 & 0 & 0 & 0 & 0 & 1 & 0 & 1 & 1 & 1 \end{array} \right] = \left[ \begin{array}{ccccc} Y & Z & I & X & Z \\ I & X & Z & X & Y \\ Z & Z & X & I & Y \\ Z & I & Z & Z & Z \end{array} \right] = \left[ \begin{array}{c} G_1 \\ G_2 \\ G_3 \\ G_4 \end{array} \right].$$

The encoded operators for this code are

$$\left[ \begin{array}{c} \bar{Z} \\ \bar{X} \end{array} \right] = \left[ \begin{array}{ccccc|ccccc} 0 & 0 & 0 & 0 & 0 & 0 & 1 & 1 & 0 & 1 \\ 0 & 0 & 0 & 1 & 1 & 1 & 1 & 1 & 0 & 0 \end{array} \right].$$

In addition to following the procedure described in Lemma VII.6, one must throw in a  $P$  gate, for every  $Y$  on the diagonal of the stabilizer (in standard form). The encoding circuit

is given by

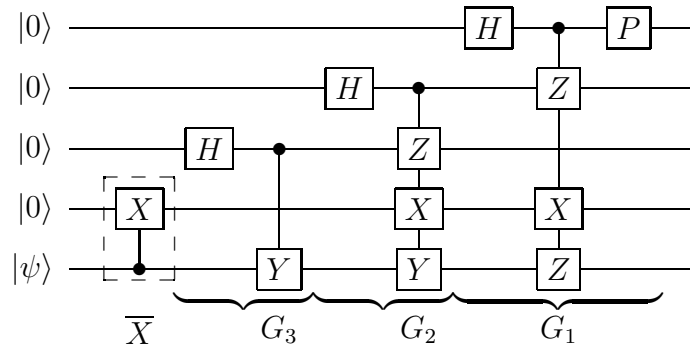

### C. Encoding Clifford Codes

In this section, we show that a Clifford code can be encoded using its stabilizer and therefore the methods used for encoding stabilizer codes are applicable. So that this chapter can be read independently of Chapter V, we briefly recapitulate some facts about Clifford subsystem codes. Let  $E$  be an abstract error group *i.e.*, it is a finite group with a faithful irreducible unitary representation  $\rho$  of degree  $|E : Z(E)|^{1/2}$ . Denote by  $\phi$ , the irreducible character afforded by  $\rho$ . Let  $N$  be a normal subgroup of  $E$ . Further, let  $\chi$  be an irreducible character  $\chi$  of  $N$  such that  $(\phi_N, \chi)_N > 0$ . Then the Clifford code defined by  $(E, \rho, N, \chi)$  is the image of the orthogonal projector

$$P = \frac{\chi(1)}{|N|} \sum_{n \in N} \chi(n^{-1}) \rho(n). \quad (7.5)$$

Under certain conditions we can construct a subsystem code from the Clifford code, in particular when  $E$  is the extraspecial  $p$ -group, the Clifford code  $C$  has a tensor product decomposition<sup>¶</sup> as  $C = A \otimes B$ , where  $B$  is an irreducible  $\mathbb{C}N$ -module,  $A$  is an irreducible  $\mathbb{C}L$ -module and  $L = C_E(N)$ . In this case we can encode information only into the subsystem  $A$ , while the co-subsystem  $B$  provides additional protection. When encoded this way we say  $C$  is a Clifford subsystem code. The normal subgroup  $N$  consists of all errors

<sup>¶</sup>Strictly speaking the equality should be replaced by an isomorphism.

in  $E$  that act trivially on  $A$ . It is also called the gauge group of the subsystem code. Our main goal will be to show how to encode into the subsystem  $A$ . Therefore, our interest will center on the projectors for the Clifford code and the subsystem code and not so much on the parameters of the codes themselves.

An alternate projector for a Clifford code with data  $(E, \rho, N, \chi)$  can be defined in terms of  $Z(N)$ , the center of  $N$ . The proof of this can be found in [88, Theorem 6]. This projector is given as

$$P' = \frac{1}{|Z(N)|} \sum_{n \in Z(N)} \varphi(n^{-1}) \rho(n), \quad (7.6)$$

where  $\varphi$  is an irreducible character of  $Z(N)$ , that satisfies  $(\chi \downarrow Z(N))(x) = \chi(1)\varphi(x)$ . In this case  $Q$  can be thought of as a stabilizer code in the sense of [35] i.e.

$$\rho(m) |\psi\rangle = \varphi(m) |\psi\rangle \text{ for any } m \text{ in } Z(N). \quad (7.7)$$

In addition to the assumption that the error group is an extraspecial  $p$ -group we also assume that  $Z(E) \leq N$ . The inclusion of the center of  $E$  does not change the code but helps in analysis. Thus we have the following lemma.

**Lemma VII.8.** *Let  $(E, \rho, N, \chi)$  be the data of a Clifford code and  $\varphi$  an irreducible character of  $Z(N)$ , the center of  $N$ , satisfying  $(\chi \downarrow Z(N))(x) = \chi(1)\varphi(x)$ . If  $E$  is an extraspecial  $p$ -group, then for all  $n$  in  $Z(N)$ ,  $\varphi(n) \in \{\zeta^k \mid \zeta = e^{j2\pi/p}, 0 \leq k < p\}$ . Further, if  $Z(E) \leq N$ , then for any  $n \in Z(N)$ , we have  $\varphi(n^{-1})\rho(n) \in \rho(Z(N))$ .*

*Proof.* First we note that the irreducibility of  $\rho$  implies that for any  $z$  in  $Z(E)$  we have  $\rho(z) = \omega I$  for some  $\omega \in \mathbb{C}$  by Schur's lemma. The assumption that  $E$  is an extraspecial  $p$ -group forces  $\omega \in \{\zeta^k \mid 0 \leq k < p\}$  where  $\zeta = e^{j2\pi/p}$ . This is because  $|Z(E)| = p$  for extraspecial  $p$ -groups. Secondly, we observe that  $\varphi$  is an irreducible additive character of  $Z(N)$  (an abelian subgroup of an extraspecial  $p$ -group) which implies that we must have

$\varphi(n) = \zeta^l$  for some  $0 \leq l < p$ , [103]. Together these observations imply that we can assume  $\varphi(n^{-1})I = \zeta^l I = \rho(z)$  for some  $0 \leq l \leq p$  and  $z \in Z(E)$ . Since  $Z(E) \leq N$ , it follows that  $Z(E) \leq Z(N)$  and  $\varphi(n^{-1})\rho(n)$  is in  $\rho(Z(N))$ .  $\square$

Our goal is to use the stabilizer of  $Q$  for encoding and as a first step we will show that it can be computed from  $Z(N)$ . The usefulness of such a projector is that it obviates the need to know the character  $\varphi$ . Let  $S \leq \rho(E)$  be the stabilizer of  $Q$ . Then we claim that  $S$  is given as

$$S = \{\varphi(n^{-1})\rho(n) \mid n \in Z(N)\}.$$

We claim that  $S$  can be used for encoding the associated Clifford code. Then we will show how the encoding circuit of the Clifford code is to be modified so that we can encode the subsystem code derived from the Clifford code.

**Theorem VII.9.** *Let  $Q$  be a Clifford code with the data  $(E, \rho, N, \chi)$  and  $\varphi$  a constituent of the restriction of  $\chi$  to  $Z = Z(N)$ . Let  $E$  be an extraspecial  $p$ -group and  $Z(E) \leq N$  and*

$$S = \{\varphi(n^{-1})\rho(n) \mid n \in Z(N)\} \quad \text{and} \quad P = \frac{1}{|S|} \sum_{s \in S} s. \quad (7.8)$$

*Then  $S$  is the stabilizer of  $Q$  and  $\text{Im } P = Q$ .*

*Proof.* We will show this in a series of steps.

- 1) First we will show that  $S \leq \rho(Z)$ . By Lemma VII.8 we know that  $\varphi(n^{-1})\rho(n)$  is in  $\rho(Z)$ , therefore  $S \subseteq \rho(Z)$ . For any two elements  $n_1, n_2 \in Z$ , we have  $s_1 = \varphi(n_1^{-1})\rho(n_1)$ ,  $s_2 = \varphi(n_2^{-1})\rho(n_2) \in S$  and we can easily verify that  $s_1^{-1}s_2 = \varphi(n_1)\rho(n_1^{-1})\varphi(n_2^{-1})\rho(n_2) = \varphi(n_2^{-1}n_1)\rho(n_1^{-1}n_2) \in S$ , as  $\rho(n_1^{-1}n_2)$  is in  $\rho(Z)$ . Hence  $S \leq \rho(Z)$ .
- 2) Now we show that  $S$  fixes  $Q$ . Let  $s \in S$  and  $|\psi\rangle \in Q$ . Then  $s = \varphi(n^{-1})\rho(n)$  for some  $n \in Z$ . The action of  $s$  on  $|\psi\rangle$  is given as  $s|\psi\rangle = \varphi(n^{-1})\rho(n)|\psi\rangle = \varphi(n^{-1})\varphi(n)|\psi\rangle = |\psi\rangle$ , in other words  $S$  fixes  $Q$ .



- 3) Next, we show that  $|S| = |Z|/|Z(E)|$ . If two elements  $n_1$  and  $n_2$  in  $Z$  map to the same element in  $S$ , then  $\varphi(n_1^{-1})\rho(n_1) = \varphi(n_2^{-1})\rho(n_2)$ , that is  $\rho(n_2) = \varphi(n_1^{-1}n_2)\rho(n_1)$ . From Lemma VII.8 it follows that  $\rho(n_2) = \zeta^l\rho(n_1)$  for some  $0 \leq l < p$ . Since  $\rho(Z(E)) = \{e^{j2\pi k/p}I \mid 0 \leq k < p\}$ , we must have  $n_2 = zn_1$  for some  $z \in Z(E)$ . Thus,  $|S| = |Z|/|Z(E)|$ .
- 4) Let  $T$  be a traversal of  $Z(E)$  in  $Z$ , then every element in  $Z$  can be written as  $zt$  for some  $z \in Z(E)$  and  $t \in T$ . From step 3) we can see that all elements in a coset of  $Z(E)$  in  $Z$  map to the same element in  $S$ , therefore,

$$S = \{\varphi(t^{-1})\rho(t) \mid t \in T\}.$$

Recall that a projector for  $Q$  is given by

$$\begin{aligned} P' &= \frac{1}{|Z|} \sum_{n \in Z} \varphi(n^{-1})\rho(n), \\ &= \frac{1}{|Z|} \sum_{t \in T} \sum_{z \in Z(E)} \varphi((zt)^{-1})\rho(zt). \end{aligned}$$

But we know from step 3) that if  $z \in Z(E)$ , then  $\varphi(n^{-1})\rho(n) = \varphi((zn)^{-1})\rho(zn)$ . So we can simplify  $P'$  as

$$\begin{aligned} P' &= \frac{1}{|Z|} \sum_{t \in T} \sum_{z \in Z(E)} \varphi(t^{-1})\rho(t), \\ &= \frac{|Z(E)|}{|Z|} \sum_{t \in T} \varphi(t^{-1})\rho(t) \\ &= \frac{1}{|S|} \sum_{s \in S} s = P. \end{aligned}$$

Thus the projector defined by  $S$  is precisely the same as  $P'$  and  $P$  is also a projector for  $Q$ .

From step 3) it is clear that  $S \cap Z(E) = \{1\}$  and by Lemma III.10,  $S$  is a closed subgroup

of  $E$ . By Lemma III.9,  $\text{Im } P = Q$  is a stabilizer code. Hence  $S$  is the stabilizer of  $Q$ .  $\square$

**Corollary VII.10.** *Let  $Q$  be an  $[[n, k, r, d]]$  Clifford subsystem code and  $S$  its stabilizer.*

*Let*

$$P = \frac{1}{|S|} \sum_{s \in S} s. \quad (7.9)$$

*Then  $P$  is a projector for the subsystem code i.e.  $Q = \text{Im } P$ .*

*Proof.* By [90, Theorem 4], we know that an  $[[n, k, r, d]]$  Clifford subsystem code is derived from a Clifford code with data  $(E, \rho, N, \chi)$ . This construction assumes that  $E$  is an extraspecial  $p$ -group and  $Z(E) \leq N \trianglelefteq E$ . Since as subspaces the Clifford code and subsystem code are identical, by Theorem VII.9 we conclude that the projector defined from the stabilizer of the subspace is also a projector for the subsystem code.  $\square$

Theorem VII.9 shows that any Clifford code can be encoded using its stabilizer. As to a subsystem code, while Corollary VII.10 shows that there exists a projector that can be defined from its stabilizer, it is not clear how to use it so that one respects the subsystem structure during encoding. More precisely, how do we use the projector defined in Corollary VII.10 to encode into the information carrying subsystem  $A$  and not the gauge subsystem. This will be the focus of the next section.

#### D. Encoding Subsystem Codes

For ease of presentation and clarity henceforth we will focus on binary codes, though the results can be extended to nonbinary alphabet using methods similar to stabilizer codes, see [73]. Theorem VII.9 shows that in order to encode Clifford codes we can use a projector derived from the underlying stabilizer to project onto the codespace. But in case of Clifford subsystem codes we know that  $Q = A \otimes B$  and the information is to be actually encoded in

A. Hence, it is not sufficient to merely project onto  $Q$ , we must also show that we encode into  $A$  when we encode using the projector defined in Corollary VII.10.

Let us clarify what we mean by encoding the information in  $A$  and not in  $B$ . Suppose that  $P$  maps  $|0\rangle$  to  $|\psi\rangle_A \otimes |0\rangle_B$  and  $|1\rangle$  to  $|\psi\rangle_A \otimes |1\rangle_B$ . Then the information is actually encoded into  $B$ . Since the gauge group acts nontrivially on  $B$ , this particular encoding does not protect information. Of course a subsystem code should not encode (only) into  $B$ , but we have to show that the projector defined by  $P$  in equation 7.9 does not do that.

We need the following result on the structure of the gauge group and the encoded operators of a subsystem code. Poulin [120] proved a useful result on the structure of the gauge group and the encoded operators of the subsystem code. But first a little notation. A basis for  $\mathcal{P}_n$  is  $X_i, Z_i, 1 \leq i \leq n$ , where  $X_i$  and  $Z_i$  are given as

$$X_i = \bigotimes_{j=1}^n X^{\delta_{ij}} \quad \text{and} \quad Z_i = \bigotimes_{j=1}^n Z^{\delta_{ij}}.$$

They satisfy the relations  $[X_i, X_j] = 0 = [Z_i, Z_j]$ ;  $[X_i, Z_j] = 2\delta_{ij}X_iZ_j$ . However, we can choose other generating sets  $\{x_i, z_i \mid 1 \leq i \leq n\}$  for  $\mathcal{P}_n$  that satisfy similar commutation relations *i.e.*,  $[x_i, x_j] = 0 = [z_i, z_j]$  and  $[x_i, z_j] = 2\delta_{ij}x_i z_j$ . These operators may act nontrivially on many qubits. Given an  $[[n, k, r, d]]$  code we could view the state space of the physical  $n$  qubits as that of  $n$  virtual qubits on which these  $x_i, z_i$  act as  $X$  and  $Z$  operators. In particular  $k$  of these virtual qubits are the logical qubits and  $r$  of them gauge qubits. The usefulness of these operators is that we can specify the structure of the stabilizer, the gauge group and the encoded operators. The following lemma makes this specification precise.

**Lemma VII.11.** *Let  $Q$  be an  $[[n, k, r, d]]_2$  subsystem code with gauge group,  $G$  and stabilizer  $S$ . Denote the encoded operators by  $\bar{X}_i, \bar{Z}_i, 1 \leq i \leq k$ , where  $[\bar{X}_i, \bar{X}_j] = 0 = [\bar{Z}_i, \bar{Z}_j]$ ;  $[\bar{X}_i, \bar{Z}_j] = 2\delta_{ij}\bar{X}_i\bar{Z}_j$ . Then there exist operators  $\{x_i, z_i \in \mathcal{P}_n \mid 1 \leq i \leq n\}$  such that*

- i)  $S = \langle z_1, z_2, \dots, z_s \rangle$ ,
- ii)  $G = \langle S, z_{s+1}, x_{s+1}, \dots, z_{s+r}, x_{s+r}, Z(\mathcal{P}_n) \rangle$ ,
- iii)  $C_{\mathcal{P}_n}(S) = \langle G, \overline{X}_1, \overline{Z}_1, \dots, \overline{X}_k, \overline{Z}_k \rangle$ ,
- iv)  $\overline{X}_i = x_{s+r+i}$  and  $\overline{Z}_i = z_{s+r+i}$ ,  $1 \leq i \leq k$ ,

where  $[z_i, z_j] = [x_i, x_j] = 0$ ;  $[x_i, z_i] = 2\delta_{ij}x_i z_i$ . Further,  $S$  defines an  $[[n, k+r]]$  stabilizer code encoding into the same space as the subsystem code and its encoded operators are given by  $\{x_{s+1}, z_{s+1}, \dots, x_{s+r}, z_{s+r}, \overline{X}_1, \overline{Z}_1, \dots, \overline{X}_k, \overline{Z}_k\}$

*Proof.* See [120] for proof on the structure of the groups. Let  $Q = A \otimes B$ , then  $\dim A = 2^k$  and  $\dim B = 2^r$ . From Corollary VII.10 we know that the projector defined by  $S$  also projects onto  $Q$  (which is  $2^{k+r}$ -dimensional) and therefore it defines an  $[[n, k+r]]$  stabilizer code. From the definition of the operators  $x_i, z_i$  and  $\overline{X}_i, \overline{Z}_i$  and the fact that

$$C_{\mathcal{P}_n}(S) = \langle S, x_{s+1}, z_{s+1}, \dots, x_{s+r}, z_{s+r}, \overline{X}_1, \overline{Z}_1, \dots, \overline{X}_k, \overline{Z}_k, Z(\mathcal{P}_n) \rangle$$

we see that  $x_i, z_i$ , for  $s+1 \leq i \leq r$  act like encoded operators on the gauge qubits, while  $\overline{X}_i, \overline{Z}_i$  continue to be the encoded operators on the information qubits. Together they exhaust the set of  $2(k+r)$  encoded operators of the  $[[n, k+r]]$  stabilizer code.  $\square$

We observe that the logical operators of the subsystem code are also logical operators for the underlying stabilizer code. so if the stabilizer code and the subsystem code have the same logical all zero state, then Lemma VII.11 suggests that in order to encode the subsystem code, we can treat it as stabilizer code and use the same techniques to encode. If the logical all zero code word was the same for both the codes, then because they have the same logical operators we can encode any given input to the same logical state in both cases. Using linearity we could then encode any arbitrary state. Encoding the all zero state seems to be the key. Now, even in the case of the stabilizer codes, there is no unique all zero logical state. There are many possible choices. The reader can refer to the appendix

for examples. Given the encoded operators it is easy to define the logical all zero state as the following definition shows:

**Definition VII.12.** *A logical all zero state of an  $[[n, k, r, d]]$  subsystem code is any state that is fixed by its stabilizer and  $k$  logical  $Z$  operators.*

This definition is valid in case of stabilizer codes also. This definition might appear a little circular. After all, we seem to have assumed the definition of the logical  $Z$  operators. Actually, this is a legitimate definition because, depending on the choice of our logical operators, we can have many choices of the logical all zero state. In case of the subsystem codes, this definition implies that the logical all zero state is fixed by  $n - r$  operators, consequently it can be any state in that  $2^r$ -dimensional subspace. If we consider the  $[[n, k + r]]$  stabilizer code that is associated to the subsystem code, then its logical zero is additionally fixed by  $r$  more operators. So any logical zero of the stabilizer code is also a logical all zero state of the subsystem code. It follows that if we know how to encode the stabilizer code's logical all zero, we know how to encode the subsystem code. We are interested in more than merely encoding the subsystem code of course. We also want to leverage the gauge qubits to simplify and/or make the encoding process more robust. Perhaps a few examples will clarify the ideas.

### 1. Illustrative Examples

Consider the following  $[[4, 1, 1, 2]]_2$  subsystem code, with the gauge group  $G$ , stabilizer  $S$  and encoded operators given by  $L$ .

$$S = \begin{bmatrix} X & X & X & X \\ Z & Z & Z & Z \end{bmatrix} = \begin{bmatrix} z_1 \\ z_2 \end{bmatrix},$$

$$G = \frac{\begin{bmatrix} X & X & X & X \\ Z & Z & Z & Z \end{bmatrix}}{\begin{bmatrix} I & X & I & X \\ I & I & Z & Z \end{bmatrix}} = \frac{\begin{bmatrix} z_1 \\ z_2 \end{bmatrix}}{\begin{bmatrix} x_3 \\ z_3 \end{bmatrix}}.$$

The encoded operators of this code are given by

$$L = \begin{bmatrix} I & I & X & X \\ I & Z & I & Z \end{bmatrix} = \begin{bmatrix} \bar{X}_1 \\ \bar{Z}_1 \end{bmatrix}.$$

The associated  $[[4, 2]]$  stabilizer code has the following encoded operators.

$$T = \begin{bmatrix} I & X & I & X \\ I & I & X & X \\ I & I & Z & Z \\ I & Z & I & Z \end{bmatrix} = \begin{bmatrix} x_3 \\ \bar{X}_1 \\ z_3 \\ \bar{Z}_1 \end{bmatrix}.$$

It will be observed that the encoded  $X$  operators of  $[[4, 2]]$  are in a form convenient for encoding. We treat the  $[[4, 1, 1, 2]]$  code as  $[[4, 2]]$  code and encode it as in Figure 1. The gauge qubits are permitted to be in any state.

Assuming  $g = a|0\rangle + b|1\rangle$ , the logical states up to a normalizing constant are

$$\begin{aligned} |\bar{0}\rangle &= a(|0000\rangle + |1111\rangle) + b(|0101\rangle + |1010\rangle), \\ |\bar{1}\rangle &= a(|0011\rangle + |1100\rangle) + b(|0110\rangle + |1001\rangle). \end{aligned}$$

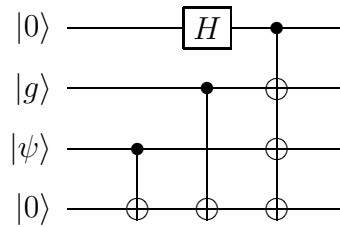

Fig. 1. Encoding the  $[[4, 1, 1, 2]]$  code (Gauge qubits can be in any state)

It can be easily verified that  $S$  stabilizes the above state and while the gauge group acts in a nontrivial fashion, the resulting states are still orthogonal. In this example we have encoded as if we were encoding the  $[[4, 2]]$  code. Prior to encoding the gauge qubits can be identified with physical qubits. After the encoding however such a correspondence between the physical qubits and gauge qubits does not necessarily exist in a nontrivial subsystem code. Since the encoded operators of the subsystem code are also encoded operators for the stabilizer code, we are guaranteed that the information is not encoded into the gauge subsystem.

As the state of gauge qubits is of no consequence, we can initialize them to any state. Alternatively, if we initialized them to zero, we can simplify the circuit as shown in Figure 2.

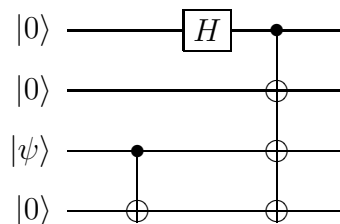

Fig. 2. Encoding the  $[[4, 1, 1, 2]]$  code (Gauge qubits initialized to zero)

The encoded states in this case are (again, the normalization factors are ignored)

$$\begin{aligned} |\bar{0}\rangle &= |0000\rangle + |1111\rangle, \\ |\bar{1}\rangle &= |0011\rangle + |1100\rangle. \end{aligned}$$

The benefit with respect to the previous version is that at the cost of initializing the gauge qubits, we have been able to get rid of all the encoded operators associated with them. This seems to be a better option than randomly initializing the gauge qubits. Because it is certainly easier to prepare them in a known state like  $|0\rangle$ , rather than implement a series of controlled gates depending on the encoded operators associated with those qubits.

At this point we might ask if it is possible to get both the benefits of random initialization of the gauge qubits as well as avoid implementing the encoded operators associated with them. To answer this question let us look a little more closely at the previous two encoding circuits for the subsystem codes. We can see from them that it will not work in general. Let us see why. If we initialize the gauge qubit to  $|1\rangle$  instead of  $|0\rangle$  in the encoding given in Figure 2, then the encoded state is

$$\begin{aligned} |\bar{0}\rangle &= |0100\rangle + |1011\rangle, \\ |\bar{1}\rangle &= |0111\rangle + |1000\rangle. \end{aligned}$$

Both these states are not stabilized by  $S$ , indicating that these states are not in the code space.

In general, an encoding circuit where it is simultaneously possible initialize the gauge qubits to random states and also avoid the encoded operators is likely to be having more complex primary generators. For instance, let us consider the following  $[[4, 1, 1, 2]]$  sub-



system code:

$$S = \begin{bmatrix} X & Z & Z & X \\ Z & X & X & Z \end{bmatrix} = \begin{bmatrix} z_1 \\ z_2 \end{bmatrix},$$

$$G = \begin{bmatrix} X & Z & Z & X \\ Z & X & X & Z \\ Z & I & X & I \\ I & Z & Z & I \end{bmatrix} = \begin{bmatrix} z_1 \\ z_2 \\ x_3 \\ z_3 \end{bmatrix}.$$

The encoded operators of this code are given by

$$L = \begin{bmatrix} I & Z & I & X \\ Z & I & I & Z \end{bmatrix} = \begin{bmatrix} \bar{X}_1 \\ \bar{Z}_1 \end{bmatrix}.$$

The associated  $[[4, 2]]$  stabilizer code has the following encoded operators.

$$T = \begin{bmatrix} Z & I & X & I \\ I & Z & I & X \\ I & Z & Z & I \\ Z & I & I & Z \end{bmatrix} = \begin{bmatrix} x_3 \\ \bar{X}_1 \\ z_3 \\ \bar{Z}_1 \end{bmatrix}.$$

The encoding circuit for this code is given in Figure 3.

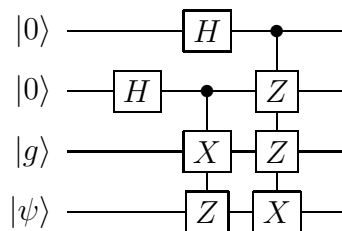

Fig. 3. Encoding  $[[4, 1, 1, 2]]$  code (Encoded operators for the gauge qubits are trivial and gauge qubits can be initialized to random states)

In this particular case, the gauge qubits (as well as the information qubits) do not

require any additional encoding circuitry. In this case we can initialize the gauge qubits to any state we want. But, the reader would have observed we did not altogether end up with a simpler circuit. The primary generators are two as against one and the complexity of the encoded operators has been shifted to them. So even though we were able to get rid of the encoded operator on the gauge qubit and also get the benefit of initializing it to a random state, this is still more complex compared to either of encoders in Figures 1 and 2. Our contention is that it is better to initialize the gauge qubits to zero state and not implement the encoded operators associated to them.

## 2. Encoding Subsystem Codes by Standard Form Method

The previous two examples might lead us to conclude that we can take the stabilizer of the given subsystem code and form the encoded operators by reducing the stabilizer to its standard form and encode as if it were a stabilizer code. However, there are certain subtle points to be kept in mind. When we form the encoded operators we get  $k + r$  encoded operators; we cannot from the stabilizer alone conclude which are the encoded operators on the information qubits and which on the gauge qubits. Put differently, these operators belong to the space  $C_{\mathcal{P}_n}(S) \setminus S = GC_{\mathcal{P}_n}(G) \setminus SZ(\mathcal{P}_n)$ . It is not guaranteed that they are entirely in  $C_{\mathcal{P}_n}(G)$  *i.e.*, we cannot say if they act as encoded operators on the logical qubits. This implies that in general all these operators act nontrivially on both  $A$  and  $B$ . Consequently, we must be careful in choosing the encoded operators and the gauge group must be taken into account. We give two slightly different methods for encoding subsystem codes. The difference between the two methods is subtle. Both methods require the gauge qubits to be initialized to zero. In the second method (see Algorithm 2) however, we can avoid the encoded operators associated to them. Under certain circumstances, we can also permit initialization to random states.

**Correctness of Algorithm 1.** Since stabilizer  $S_A \geq S$ , the space stabilized by  $S_A$  is a

---

**Algorithm 1** ENCODING SUBSYSTEM CODES – STANDARD FORM METHOD 1
 

---

**Require:** Gauge group,  $G = \langle S, x_{s+1}, z_{s+1}, \dots, x_{s+r}, z_{s+r}, \pm I \rangle$  and stabilizer,  $S = \langle z_1, \dots, z_{n-k-r} \rangle$  of the  $[[n, k, r, d]]$  subsystem code.

**Ensure:**  $[x_i, x_j] = [z_i, z_j] = 0$ ;  $[x_i, z_j] = 2x_i z_i \delta_{ij}$

1: Form  $S_A = \langle S, z_{s+1}, \dots, z_{s+r} \rangle$ , where  $s = n - k - r$

2: Compute the standard form of  $S_A$  as per Lemma VII.2

$$S_A =_{\pi} \left[ \begin{array}{ccc|ccc} I_{s'} & A_1 & A_2 & B & 0 & C \\ 0 & 0 & 0 & D & I_{s+r-s'} & E \end{array} \right]$$

3: Compute the encoded operators  $\bar{X}_1, \dots, \bar{X}_k$  as

$$\left[ \begin{array}{c} \bar{Z} \\ \bar{X} \end{array} \right] =_{\pi} \left[ \begin{array}{ccc|ccc} 0 & 0 & 0 & A_2^t & 0 & I_k \\ 0 & E^t & I_k & C^t & 0 & 0 \end{array} \right]$$

4: Encode using the primary generators of  $S_A$  and  $\bar{X}_i$  as encoded operators, see Lemma VII.6; all the other  $(n - k)$  qubits are initialized to  $|0\rangle$ .

---

subspace of the  $A \otimes B$ , the subspace stabilized by  $S$ . As  $|S_A|/|S| = 2^r$ , the dimension of the subspace stabilized by  $S_A$  is  $2^{k+r}/2^r = 2^k$ . Additionally, the generators  $z_{s+1}, \dots, z_{s+r}$  act trivially on  $A$ . The encoded operators as computed in the algorithm act nontrivially on  $A$  and give  $2^k$  orthogonal states; thus we are assured that the information is encoded into  $A$ .

Let us encode the  $[[9, 1, 4, 3]]$  Bacon-Shor code using the method just proposed. The

stabilizer and the gauge group are given by

$$S = \left[ \begin{array}{ccc|ccc|ccc} X & X & X & I & I & I & X & X & X \\ I & I & I & X & X & X & X & X & X \\ Z & I & Z & Z & I & Z & Z & I & Z \\ I & Z & Z & I & Z & Z & I & Z & Z \end{array} \right],$$

$$G = \left[ \begin{array}{ccc|ccc|ccc} X & X & X & I & I & I & X & X & X \\ I & I & I & X & X & X & X & X & X \\ Z & I & Z & Z & I & Z & Z & I & Z \\ I & Z & Z & I & Z & Z & I & Z & Z \\ \hline I & X & I & I & X & I & I & I & I \\ I & I & X & I & I & X & I & I & I \\ I & I & I & I & I & X & I & I & X \\ X & X & X & X & X & X & I & I & I \\ \hline Z & I & Z & I & I & I & I & I & I \\ I & I & I & Z & I & Z & I & I & I \\ I & Z & Z & I & I & I & I & I & I \\ I & I & I & I & Z & Z & I & I & I \end{array} \right] = \left[ \begin{array}{c} S \\ G_x \\ G_z \end{array} \right].$$

Let us form  $S_A$  by augmenting  $S$  with  $G_z$ . Then

$$S_A = \left[ \begin{array}{ccc|ccc|ccc} X & X & X & I & I & I & X & X & X \\ I & I & I & X & X & X & X & X & X \\ Z & I & Z & Z & I & Z & Z & I & Z \\ I & Z & Z & I & Z & Z & I & Z & Z \\ \hline Z & I & Z & I & I & I & I & I & I \\ I & I & I & Z & I & Z & I & I & I \\ I & Z & Z & I & I & I & I & I & I \\ I & I & I & I & Z & Z & I & I & I \end{array} \right].$$

The encoded  $X$  and  $Z$  operators are  $X_7X_8X_9$  and  $Z_1Z_4Z_7$ , respectively. After putting  $S_A$  in the standard form, and encoder for this code is given in Figure 4.

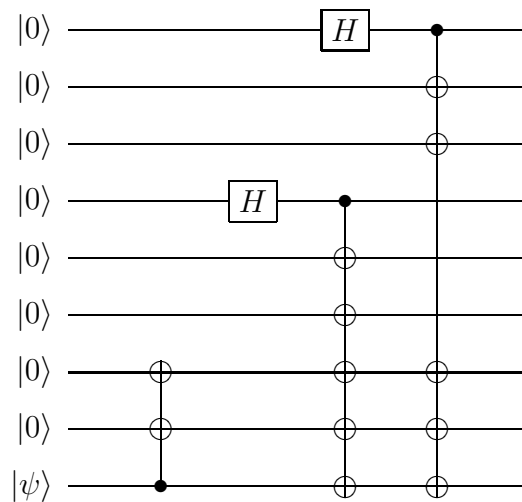

Fig. 4. Encoder for the  $[[9, 1, 4, 3]]$  code. This is also an encoder for the  $[[9, 1, 3]]$  code.

If on the other hand we had formed  $S_A$  by adding  $G_x$  instead, then  $S_A$  would have



following variant on standard form encoding, where we try to minimize the the number of primary generators. This is not guaranteed to reduce the overall complexity, since that is determined by both the primary generators and the encoded operators. Fewer primary generators might usually imply encoded operators with larger complexity. In fact we have already seen, that in the case of  $[[9, 1, 4, 3]]_2$  code that a larger number of primary generators does not necessarily imply higher complexity. However, it has the potential for lower complexity.

---

**Algorithm 2** ENCODING SUBSYSTEM CODES – STANDARD FORM METHOD 2

---

**Require:** Gauge group,  $G = \langle S, x_{s+1}, z_{s+1}, \dots, x_{s+r}, z_{s+r}, \pm I \rangle$  and stabilizer,  $S = \langle z_1, \dots, z_{n-k-r} \rangle$  of the  $[[n, k, r, d]]$  subsystem code.

**Ensure:**  $[x_i, x_j] = [z_i, z_j] = 0$ ;  $[x_i, z_j] = 2x_i z_i \delta_{ij}$

1: Compute the standard form of  $S$  as per Lemma VII.2

$$S =_{\pi_1} \left[ \begin{array}{ccc|ccc} I_{s'} & A_1 & A_2 & B & 0 & C \\ 0 & 0 & 0 & D & I_{s-s'} & E \end{array} \right]$$

2: Form  $S_A = \langle S, z_{s+1}, \dots, z_{s+r} \rangle$ , where  $s = n - k - r$

3: Compute the standard form of  $S_A$  as per Lemma VII.2

$$S_A =_{\pi_2} \left[ \begin{array}{ccc|ccc} I_l & F_1 & F_2 & G_1 & 0 & G_2 \\ 0 & 0 & 0 & D' & I_{s+r-l} & H \end{array} \right]$$

4: Compute the encoded operators  $\overline{X}_1, \dots, \overline{X}_k$  as

$$\left[ \begin{array}{c} \overline{Z} \\ \overline{X} \end{array} \right] =_{\pi_2} \left[ \begin{array}{ccc|ccc} 0 & 0 & 0 & F_2^t & 0 & I_k \\ 0 & H^t & I_k & G_2^t & 0 & 0 \end{array} \right]$$

5: Encode using the primary generators of  $S$  and  $\overline{X}_i$  as encoded operators, accounting for  $\pi_1$  and  $\pi_2$ , see Lemma VII.6; all the other  $(n - k)$  qubits are initialized to  $|0\rangle$ .

---

The main difference in the second method comes in lines 1 and 5. We encode using the primary generators of the stabilizer of the subsystem code instead of the augmented stabilizer. The encoded operators however remain the same as before.

**Correctness of Algorithm 2.** The correctness of this method lies in the observation we made earlier (see discussion following Definition VII.12), that any logical all zero state of the stabilizer code is also a logical all zero of the subsystem code and the fact that both share the encoded operators on the encoded qubits.

The encoded operators are given modulo the elements of the gauge group as in Algorithm 1, which implies that their action might be nontrivial on the gauge qubits. The benefit of the second method is when  $S$  and  $S_A$  have different number of primary generators. The following aspects of both the methods are worth highlighting.

- 1) The gauge qubits must be initialized to  $|0\rangle$  in both methods.
- 2) In Algorithm 1, the number of primary generators of  $S$  and  $S_A$  can be different leading to a potential increase in complexity compared to encoding with  $S$ .
- 3) In both methods, the encoded operators as computed are modulo  $S_A$ . Consequently, the encoded operators might act nontrivially on the gauge qubits.

### 3. Encoding Subsystem Codes by Conjugation Method

The other benefit of subsystem codes is the random initialization of the gauge qubits. We now give circuits where we can encode the subsystem codes to realize this benefit. But instead of using the standard form method we will use the conjugation method proposed by Grassl *et al.*, [73] for stabilizer codes. After briefly reviewing this method we shall show how it can be modified for encoding subsystem codes.

The conjugation encoding method can be understood as follows. It is based on the idea that the Clifford group acts transitively on the Pauli error group. It is possible to transform the stabilizer matrix of any  $[[n, k, d]]$  stabilizer code into the matrix  $(00|I_{n-k}0)$ . For a code



with this stabilizer matrix the encoding is trivial. We simply map  $|\psi\rangle$  to  $|0\rangle^{\otimes n-k} |\psi\rangle$ . The associated encoded  $\overline{X}$  and  $\overline{Z}$  operators are given by  $(0I_k|00)$  and  $(00|0I_k)$  respectively. Here we give a sketch of the method for the binary case, the reader can refer to [73] for details. Assume that the stabilizer matrix is given by  $S$ . Then we shall transform it into  $(00|I_{n-k}0)$  using the following sequence of operations.

$$(X|Z) \mapsto (I_{n-k}0|0) \mapsto (00|I_{n-k}0). \quad (7.10)$$

This can be accomplished through the action of  $H = \begin{bmatrix} 1 & 1 \\ 1 & -1 \end{bmatrix}$ ,  $P = \begin{bmatrix} 1 & 0 \\ 0 & i \end{bmatrix}$  and CNOT gates on the Pauli group under conjugation. The action of  $H$  on the  $i$ th qubit of  $(a_1, \dots, a_n|b_1, \dots, b_n)$  transforms it as

$$(a_1, \dots, a_n|b_1, \dots, b_n) \xrightarrow{H_i} (a_1, \dots, \mathbf{b}_i, \dots, a_n|b_1, \dots, \mathbf{a}_i, \dots, b_n). \quad (7.11)$$

These modified entries have been highlighted for convenience. The phase gate  $P$  on the  $i$ th qubit transforms  $(a_1, \dots, a_n|b_1, \dots, b_n)$  as

$$(a_1, \dots, a_n|b_1, \dots, b_n) \xrightarrow{P_i} (a_1, \dots, \mathbf{a}_i, \dots, a_n|b_1, \dots, \mathbf{a}_i + \mathbf{b}_i, \dots, b_n). \quad (7.12)$$

We denote the CNOT gate with the control on the  $i$ th qubit and the target on the  $j$ th qubit by  $\text{CNOT}^{i,j}$ . The action of the  $\text{CNOT}^{i,j}$  gate on  $(a_1, \dots, a_n|b_1, \dots, b_n)$  is to transform it to

$$(a_1, \dots, a_{j-1}, \mathbf{a}_j + \mathbf{a}_i, a_{j+1}, \dots, a_n|b_1, \dots, b_{i-1}, \mathbf{b}_i + \mathbf{b}_j, b_{i+1}, \dots, a_n). \quad (7.13)$$

Note that the  $j$ th entry is changed in the  $X$  part while the  $i$ th entry is changed in the  $Z$  part.

For example, consider

$$(1, 0, 0, 1, 0|0, 1, 1, 0, 0) \xrightarrow{\text{CNOT}^{1,4}} (1, 0, 0, \mathbf{0}, 0|0, 1, 1, 0, 0),$$

$$(1, 0, 0, 1, 0|0, 1, 1, 1, 0) \xrightarrow{\text{CNOT}^{1,4}} (1, 0, 0, \mathbf{0}, 0|\mathbf{1}, 1, 1, 1, 0).$$

Based on the action of these three gates we have the following lemmas to transform error operators.

**Lemma VII.13.** *Assume that we have a error operator of the form  $(a_1, \dots, a_n | b_1, \dots, b_n)$ . Then we apply the following gates on the  $i$ th qubit to transform the stabilizer, transforming  $(a_i, b_i)$  to  $(\alpha, \beta)$  as per the following table.*

$(a_i, b_i)$	Gate	$(\alpha, \beta)$
$(0,0)$	$I$	$(0,0)$
$(0,1)$	$H$	$(1,0)$
$(1,0)$	$I$	$(1,0)$
$(1,1)$	$P$	$(1,0)$

Let  $\bar{x}$  denote  $1 + x$ , then the transformation to  $(a_1, \dots, a_n | 0, \dots, 0)$  is achieved by

$$\bigotimes_{i=1}^n H^{\bar{a}_i b_i} P^{a_i b_i}.$$

For example, consider the following generator  $(1, 0, 0, 1, 0 | 0, 1, 1, 1, 0)$ . This can be transformed to  $(1, 1, 1, 1, 0 | 0, 0, 0, 0, 0)$  by the application of  $I \otimes H \otimes H \otimes P \otimes I$ .

**Lemma VII.14.** *Let  $e$  be an error operator of the form  $(a_1, \dots, a_i = 1, \dots, a_n | 0, \dots, 0)$ . Then  $e$  can be transformed to  $(0, \dots, 0, a_i = 1, 0, \dots, 0 | 0, \dots, 0)$  by*

$$\prod_{j=1, i \neq j}^n [\text{CNOT}^{i,j}]^{a_j}.$$

As an example  $(1, 1, 1, 1, 0 | 0, 0, 0, 0, 0)$  can be transformed to  $(0, 1, 0, 0, 0 | 0, 0, 0, 0, 0)$  by

$$\text{CNOT}^{2,1} \cdot \text{CNOT}^{2,3} \cdot \text{CNOT}^{2,4}.$$

The first step involves making the  $Z$  portion of the stabilizer matrix all zeros. This is achieved by single qubit operations consisting of  $H$  and  $P$  performed on each row one by one.

Note that we must also modify the other rows of the stabilizer matrix according to the action of the gates applied.

Once we have a row of stabilizer matrix in the form  $(a|0)$ , where  $a$  is nonzero we can transform it to the form  $(0, \dots, 0, a_i = 1, 0, \dots, 0|0)$  by using CNOT gates. Thus it is easy to transform  $(X|Z)$  to  $(I_{n-k}0|0)$  using CNOT,  $P$  and  $H$  gates. The final transformation to  $(0|I_{n-k}0)$  is achieved by using  $H$  gates on the first  $n - k$  qubits. At this point the stabilizer matrix has been transformed to a trivial stabilizer matrix which stabilizes the state  $|0\rangle^{\otimes n-k} |\psi\rangle$ . The encoded operators are  $(0I_k|0)$  and  $(0|0I_k)$ . Let  $T$  be the sequence of gates applied to transform the stabilizer matrix to the trivial stabilizer matrix. Then  $T$  applied in the reverse order to  $|0\rangle^{\otimes n-k} |\psi\rangle$  gives the encoding circuit for the stabilizer code.

Now we shall use this method to encode the subsystem codes. The main difference is that instead of considering just the stabilizer we need to consider the entire gauge group. Let the gauge group be  $G = \langle S, G_Z, G_X \rangle$ , where  $G_Z = \langle z_{s+1}, \dots, z_{s+r} \rangle$ , and  $G_X = \langle x_{s+1}, \dots, x_{s+r} \rangle$ . The idea is to transform the gauge group as follows.

$$G = \left[ \begin{array}{c} S \\ \hline G_Z \\ \hline G_X \end{array} \right] \mapsto \left[ \begin{array}{ccc|ccc} 0 & 0 & 0 & I_s & 0 & 0 \\ \hline 0 & 0 & 0 & 0 & I_r & 0 \\ \hline 0 & I_r & 0 & 0 & 0 & 0 \end{array} \right]. \quad (7.14)$$

At this point the gauge group has been transformed to a group with trivial stabilizer and trivial encoded operators for the gauge qubits and the encoded qubits. The sequence of gates required to achieve this transformation in the reverse order will encode the state  $|0\rangle^{\otimes s} |\phi\rangle |\psi\rangle$ . The state  $|\phi\rangle$  corresponds to the gauge qubits and it can be initialized to any state, while  $|\psi\rangle$  corresponds to the input.

---

**Algorithm 3** ENCODING SUBSYSTEM CODES – CONJUGATION METHOD
 

---

**Require:** Gauge group,  $G = \langle S, G_Z, G_X \rangle$ , where  $G_Z = \langle z_{s+1}, \dots, z_{s+r} \rangle$ , and  $G_X = \langle x_{s+1}, \dots, x_{s+r} \rangle$  and stabilizer,  $S = \langle z_1, \dots, z_{n-k-r} \rangle$  of the  $[[n, k, r, d]]$  subsystem code.

**Ensure:**  $[x_i, x_j] = [z_i, z_j] = 0$ ;  $[x_i, z_j] = 2x_i z_i \delta_{ij}$

1: Assume that  $G$  is the following form

$$G = \left[ \begin{array}{c} S \\ \hline G_Z \\ \hline G_X \end{array} \right]$$

2: **for all**  $i = 1$  to  $s + r$  **do**

3: Transform  $z_i$  to  $z'_i = (a_1, \dots, a_n | 0, \dots, 0)$  using Lemma VII.13

4: Transform  $z'_i$  to  $(0, \dots, a_i = 1, \dots, 0 | 0)$  using Lemma VII.14

5: Perform Gaussian elimination on column  $i$  for rows  $j > i$

6: **end for**

7: Apply  $H$  gate on each qubit  $i = 1$  to  $i = s + r$

8: **for all**  $i = s + 1$  to  $s + r$  **do**

9: Transform  $x_i$  to  $x'_i = (a_1, \dots, a_n | 0, \dots, 0)$  using Lemma VII.13

10: Transform  $x'_i$  to  $(0, \dots, a_i = 1, \dots, 0 | 0)$  using Lemma VII.14

11: Perform Gaussian elimination on column  $i$  for rows  $j > i$

12: **end for**

---

In the above algorithm, we assume that whenever a row is transformed according to Lemma VII.13 or VII.14, all the other rows are also transformed according to the transformation applied.

**Correctness of Algorithm 3.** The correctness of the algorithm is straightforward. As

$G$  has full rank of  $n - k + r$ , for each row of  $G$ , we will be able to find some nonzero pair  $(a, b)$  so that the the transformation in lines 2–6 can be achieved. When  $S$  and  $G_Z$  are in the form  $(0|I_{s+r}0)$ , the rows in  $G_X$  are in the form

$$\left[ \begin{array}{ccc|ccc} 0 & A & B & 0 & 0 & D \end{array} \right].$$

The zero columns of  $G_X$  are consequence of the requirement to satisfy the commutation relations with (transformed)  $S$  and  $G_Z$ . For instance, The first  $n - k - r$  are all zero because they must commute with  $(0|I_s0)$ , the elements of the transformed stabilizer. The submatrix  $A$  must have rank  $r$ , otherwise at this point one of the rows of  $G_X$  commutes with all the rows of  $G_Z$  and the condition that we have there are  $r$  hyperbolic pairs is violated. It is possible therefore to transform  $A$  to the form  $(0I_r0|0)$ . It cannot be any other form because then we would not have the  $r$  hyperbolic pairs. The applied transformations transform  $G$  to the form given in equation (7.14). The encoded operators for this gauge group are clearly  $(0I_k|0)$  and  $(0|0I_k)$ . We conclude with a simple example that illustrates the process.

**Example VII.15.** *To compare with the standard form method, we consider the  $[[4, 1, 1, 2]]$  code again. Let the gauge group  $G$ , stabilizer  $S$  and encoded operators given by  $L$ .*

$$S = \left[ \begin{array}{cccc} X & X & X & X \\ Z & Z & Z & Z \end{array} \right] = \left[ \begin{array}{c} z_1 \\ z_2 \end{array} \right],$$

$$G = \left[ \begin{array}{cccc|cccc} X & X & X & X & & & & \\ Z & Z & Z & Z & & & & \\ \hline I & I & Z & Z & & & & \\ I & X & I & X & & & & \end{array} \right] = \left[ \begin{array}{c} z_1 \\ z_2 \\ x_3 \\ z_3 \end{array} \right].$$

In matrix form  $G$  can be written as

$$G = \left[ \begin{array}{cccc|cccc} 1 & 1 & 1 & 1 & 0 & 0 & 0 & 0 \\ 0 & 0 & 0 & 0 & 1 & 1 & 1 & 1 \\ \hline 0 & 0 & 0 & 0 & 0 & 0 & 1 & 1 \\ 0 & 1 & 0 & 1 & 0 & 0 & 0 & 0 \end{array} \right].$$

The transformations consisting of  $T_1 = \text{CNOT}^{1,2}\text{CNOT}^{1,3}\text{CNOT}^{1,4}$  followed by  $T_2 = I \otimes H \otimes H \otimes H$  maps  $G$  to

$$\xrightarrow{T_1} \left[ \begin{array}{cccc|cccc} 1 & 0 & 0 & 0 & 0 & 0 & 0 & 0 \\ 0 & 0 & 0 & 0 & 0 & 1 & 1 & 1 \\ \hline 0 & 0 & 0 & 0 & 0 & 0 & 1 & 1 \\ 0 & 1 & 0 & 1 & 0 & 0 & 0 & 0 \end{array} \right] \xrightarrow{T_2} \left[ \begin{array}{cccc|cccc} 1 & 0 & 0 & 0 & 0 & 0 & 0 & 0 \\ 0 & 1 & 1 & 1 & 0 & 0 & 0 & 0 \\ \hline 0 & 0 & 1 & 1 & 0 & 0 & 0 & 0 \\ 0 & 0 & 0 & 0 & 0 & 1 & 0 & 1 \end{array} \right].$$

Now transform the second row using  $T_3 = \text{CNOT}^{2,3}\text{CNOT}^{2,4}$ . Then transform using  $T_4 = \text{CNOT}^{4,3}$ . We get

$$\xrightarrow{T_3} \left[ \begin{array}{cccc|cccc} 1 & 0 & 0 & 0 & 0 & 0 & 0 & 0 \\ 0 & 1 & 0 & 0 & 0 & 0 & 0 & 0 \\ \hline 0 & 0 & 1 & 1 & 0 & 0 & 0 & 0 \\ 0 & 0 & 0 & 0 & 0 & 0 & 0 & 1 \end{array} \right] \xrightarrow{T_4} \left[ \begin{array}{cccc|cccc} 1 & 0 & 0 & 0 & 0 & 0 & 0 & 0 \\ 0 & 1 & 0 & 0 & 0 & 0 & 0 & 0 \\ \hline 0 & 0 & 0 & 1 & 0 & 0 & 0 & 0 \\ 0 & 0 & 0 & 0 & 0 & 0 & 0 & 1 \end{array} \right].$$

Applying  $T_5 = H \otimes H \otimes I \otimes H$  gives us

$$\xrightarrow{T_5} \left[ \begin{array}{cccc|cccc} 0 & 0 & 0 & 0 & 1 & 0 & 0 & 0 \\ 0 & 0 & 0 & 0 & 0 & 1 & 0 & 0 \\ \hline 0 & 0 & 0 & 1 & 0 & 0 & 0 & 0 \\ 0 & 0 & 0 & 0 & 0 & 0 & 0 & 1 \end{array} \right].$$

We could have chosen  $T_5 = H \otimes H \otimes I \otimes I$ , since the effect of  $H$  on the fourth qubit is

trivial. The complete circuit is given in Figure 6.

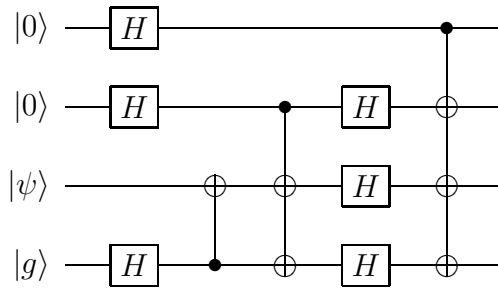

Fig. 6. Encoding  $[[4, 1, 1, 2]]$  code by conjugation method

By switching the target and control qubits of the CNOT gates in  $T_3$  and  $T_4$  we can show that this circuit is equivalent to the circuit shown in Figure 7.

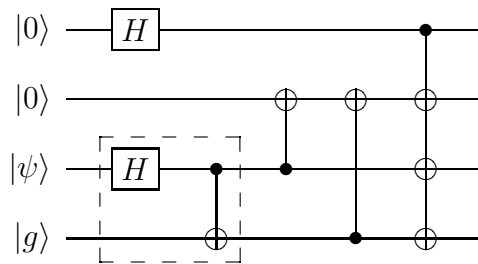

Fig. 7. Encoding  $[[4, 1, 1, 2]]$  code by conjugation method

It is instructive to compare this circuit with the one given earlier in Figure 1. The dotted lines show the additional circuitry. Since the gauge qubit can be initialized to any state, we can initialize  $|g\rangle$  to  $|0\rangle$ , which then gives the following logical states for the code.

$$|\bar{0}\rangle = |0000\rangle + |1111\rangle + |0011\rangle + |1100\rangle, \quad (7.15)$$

$$|\bar{1}\rangle = |0000\rangle + |1111\rangle - |0011\rangle - |1100\rangle. \quad (7.16)$$

It will be observed that  $IIXX$  acts as the logical  $Z$  operator while  $IZIZ$  acts as the logical  $X$  operator. We could flip these logical operators by absorbing the  $H$  gate into  $|\psi\rangle$ .

If we additionally initialize  $|g\rangle$  to  $|0\rangle$ , we will see that the two CNOT gates on the second qubit can be removed. The simplified circuit is shown in Figure 8.

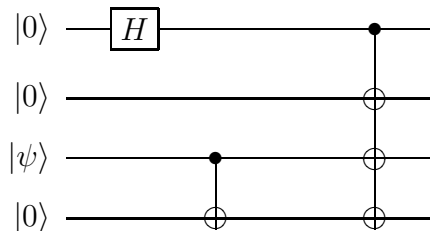

Fig. 8. Encoding  $[[4, 1, 1, 2]]$  code by conjugation method – optimized

This is precisely, the same circuit that we had arrived earlier in Figure 2 using the standard form method.

The preceding example provides additional evidence in the direction that it is better to initialize the gauge qubits to zero and avoid the encoding operators on them.

### E. Syndrome Measurement for Nonbinary $\mathbb{F}_q$ -linear Codes

Decoding of nonbinary quantum codes has not been studied as well as binary codes. Encoding of  $\mathbb{F}_q$ -linear nonbinary quantum codes was investigated in [73]. The authors suggest that the decoder is simply the encoder running backwards. In this context one important task is that measuring the syndrome so that appropriate error correction maybe performed. While binary codes have been well studied in this regard similar efforts have not been invested in the nonbinary case. Here we give a method that allows us to measure the syndrome for  $\mathbb{F}_q$ -linear nonbinary quantum codes. We also show that an  $\mathbb{F}_q$ -linear  $[[n, k, r, d]]_q$  code requires  $n - k - r$  syndrome measurements. But first we need the definition of the following nonbinary gates, see [73].

- i)  $X(a) |x\rangle = |x + a\rangle$
- ii)  $Z(b) |x\rangle = \omega^{\text{tr}_{q/p}(bx)} |x\rangle, \omega = e^{j2\pi/p}$



- iii)  $M(c) |x\rangle = |cx\rangle, c \in \mathbb{F}_q^\times$
- iv)  $F |x\rangle = \frac{1}{\sqrt{q}} \sum_{y \in \mathbb{F}_q} \omega^{\text{tr}_{q/p}(xy)} |y\rangle$
- v)  $A |x\rangle |y\rangle = |x\rangle |x + y\rangle$

Graphically, these gates are represented below.

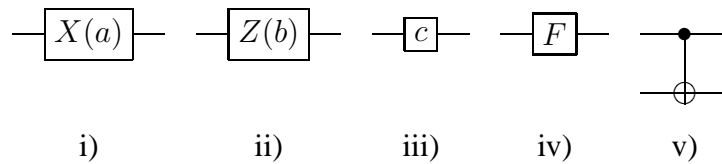

Consider the following circuit.

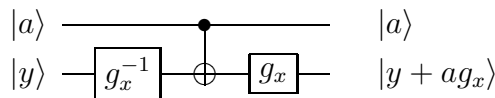

Alternatively, this circuit maps  $|a\rangle |x\rangle$  to  $|a\rangle X(ag_x) |y\rangle$ . Observe that this circuit effectively applies  $X(ag_x)$  on the second qudit. Using the linearity, we can analyze the following circuit.

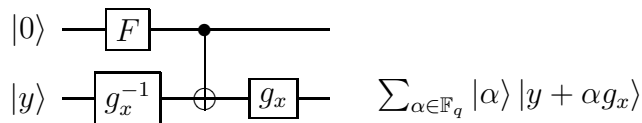

The above circuit maps  $|0\rangle |y\rangle$  to  $\sum_{\alpha \in \mathbb{F}_q} |\alpha\rangle X(\alpha g_x) |y\rangle$ . Using the fact that  $F X(b) F^\dagger = Z(b)$ , we can show that the following circuit maps  $|b\rangle |y\rangle$  to  $|b\rangle Z(b g_z) |y\rangle$ .

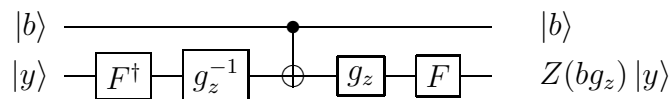

If we wanted to apply a general operator  $X(ag_x)Z(ag_z)$  to the second qudit conditioned on the first one, then we can combine the previous circuits as follows.

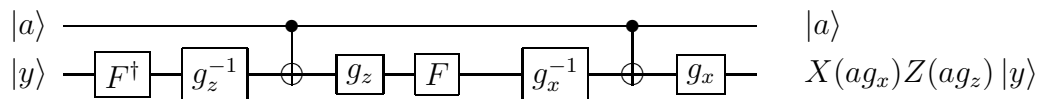

The above implementation is not optimal in terms of gates, but it will suffice for our purposes. Consider an  $[[n, k, r, d]]_q$  code. Let  $E$  be an error in  $G_n$ , (see 3.2). If  $E$  is detectable, then  $E$  does not commute with some element(s) in the stabilizer of the code. Let

$$g = (g_x|g_z) = (0, \dots, 0, a_j, \dots, a_n|0, \dots, 0, b_j, \dots, b_n) \in \mathbb{F}_q^{2n},$$

where  $(a_j, b_j) \neq (0, 0)$ , be a generator of the stabilizer. Then for all detectable errors that do not commute with a multiple of  $g$ , the following circuit gives a nonzero value on measurement.

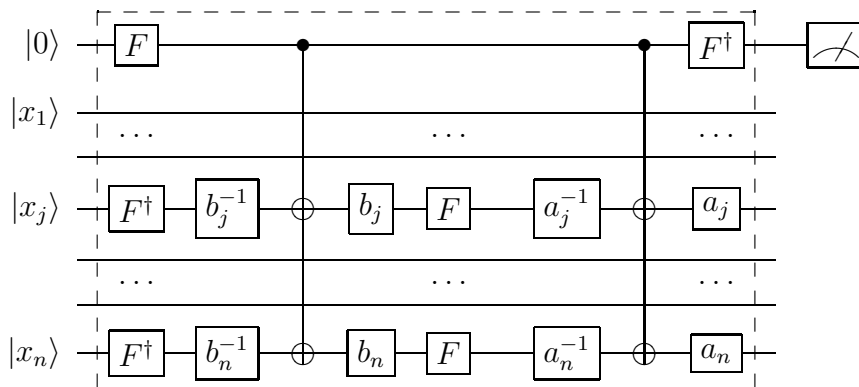

Note that whenever  $(a_i, b_i) = (0, 0)$ , then we leave that qudit alone. Similarly if  $a_i$  or  $b_i$  are zero, then we do not implement the corresponding portion. Let the input to the above circuit be  $E|\psi\rangle$ , where  $|\psi\rangle$  is an encoded state. It can be easily verified that the above circuit maps the state  $|0\rangle E|\psi\rangle$  to

$$\sum_{\alpha \in \mathbb{F}_q} F^\dagger |\alpha\rangle X(\alpha g_x) Z(\alpha g_z) E |\psi\rangle.$$

Let  $X(g_x)Z(g_z)E = \omega^{\text{tr}_{q/p}(t)} EX(g_x)Z(g_z)$ , where  $X(g_x)Z(g_z)$  is corresponding matrix representation of  $g$ . By Lemma III.5. we have  $X(\alpha g_x)Z(\alpha g_z)E = \omega^{\text{tr}_{q/p}(\alpha t)} EX(g_x)Z(g_z)$ .

Thus we can write

$$\begin{aligned} \sum_{\alpha \in \mathbb{F}_q} |\alpha\rangle X(\alpha g_x) Z(\alpha g_z) E |\psi\rangle &= \sum_{\alpha \in \mathbb{F}_q} |\alpha\rangle \omega^{\text{tr}_{q/p}(\alpha t)} E X(\alpha g_x) Z(\alpha g_z) |\psi\rangle, \\ &= \left( \sum_{\alpha \in \mathbb{F}_q} |\alpha\rangle \omega^{\text{tr}_{q/p}(\alpha t)} \right) E |\psi\rangle, \end{aligned}$$

where we have made use of the fact that  $X(\alpha g_x) Z(\alpha g_z) |\psi\rangle = |\psi\rangle$  as  $X(\alpha g_x) Z(\alpha g_z)$  is in the stabilizer. The final state is given by

$$\begin{aligned} \sum_{\alpha \in \mathbb{F}_q} F^\dagger |\alpha\rangle X(\alpha g_x) Z(\alpha g_z) E |\psi\rangle &= \sum_{\alpha \in \mathbb{F}_q} F^\dagger |\alpha\rangle \omega^{\text{tr}_{q/p}(\alpha t)} E |\psi\rangle, \\ &= \sum_{\alpha \in \mathbb{F}_q} \sum_{\beta \in \mathbb{F}_q} \omega^{-\text{tr}_{q/p}(\alpha \beta)} |\beta\rangle \omega^{\text{tr}_{q/p}(\alpha t)} E |\psi\rangle, \\ &= \sum_{\beta \in \mathbb{F}_q} |\beta\rangle \sum_{\alpha \in \mathbb{F}_q} \omega^{\text{tr}_{q/p}(\alpha t - \alpha \beta)} E |\psi\rangle, \\ &= \sum_{\beta \in \mathbb{F}_q} |\beta\rangle \sum_{\alpha \in \mathbb{F}_q} \omega^{\text{tr}_{q/p}(\alpha t - \alpha \beta)} E |\psi\rangle, \\ &= |t\rangle E |\psi\rangle, \end{aligned}$$

where the last equality follows from the property of the characters of  $\mathbb{F}_q$ . Next we observe that the error  $\alpha E$ , where  $\alpha \in \mathbb{F}_q$  gives  $|\alpha t\rangle$  on measurement. Strictly speaking we refer to the preimage of  $\alpha \bar{E}$  in  $G_n$ . Hence the syndrome qudit can take  $q$  different values. Since every detectable error does not commute with some  $\mathbb{F}_q$ -multiple of a stabilizer generator, we have the following lemma on the necessary and sufficient number of syndrome measurements.

**Lemma VII.16.** *Given an  $\mathbb{F}_q$ -linear  $[[n, k, r, d]]_q$  Clifford subsystem code,  $n - k - r$  syndrome measurements are required for decoding it completely.*

*Proof.* Let  $g$  be a generator of the stabilizer of the subsystem code. By Theorem V.10 and Lemma VI.1, for every generator  $g$  there exists at least one detectable error that does not commute with  $g$  but commutes with all the other generators. This error can be detected only

by measuring  $g$ . Thus we need to measure all the generators of the stabilizer, equivalently  $n - k - r$  syndrome measurements must be performed.

Every correctable error takes the code space into a  $q^{k+r}$ -dimensional orthogonal subspace in the  $q^n$ -dimensional ambient space. Each of these errors will give a distinct syndrome. This implies that we can have  $q^{n-k-r}$  distinct syndromes. Since each syndrome measurement can have  $q$  possible outcomes and there are  $n - k - r$  generators, these measurements are sufficient for performing error correction.  $\square$

This parallels the classical case where an  $[[n, k, d]]_q$  code requires  $n - k$  syndrome bits. A subtle caveat must be issued to the reader. If we choose to perform bounded distance decoding, then it may be possible that the set of correctable errors can be distinguished by a smaller number of syndrome measurements. But even in the case of (classical) bounded distance decoding it is often the case that we need to measure all the syndrome bits.

## F. Conclusions

In this paper, we have demonstrated that the subsystem codes can be encoded using the techniques used for stabilizer codes. In particular, we have considered two methods for encoding stabilizer codes – the standard form method and the conjugation method. While the standard form method explored here required us to initialize the gauge qubits to zero, it admits two variants and seems to have the potential for lower complexity; the exact gains being determined by the actual codes under consideration. The conjugation method allows us to initialize the gauge qubits to any state. The disadvantage seems to be the increased complexity of encoding. It must be emphasized that the standard form method is equivalent to the conjugation method and it is certainly possible to use this method to encode subsystem codes so that the gauge qubits can be initialized to arbitrary states. However, it appears to be a little more cumbersome and for this reason we have not investigated this in

this chapter. There is yet another method for encoding stabilizer codes based on the teleportation due to Knill. We expect that gauge qubits can be exploited even in this method to reduce its complexity. It would be interesting to investigate fault tolerant encoding schemes for subsystem codes and how gauge qubits can be used to improve fault tolerant thresholds. Finally, we mention that it is still open how to leverage the subsystem coding in the one way quantum computer model.

### G. Appendix

The logical states of a stabilizer code. We assume that our basis input states are of the form  $|0\rangle^{\otimes n-k} |\alpha_1 \dots \alpha_k\rangle$ , where  $\alpha_i \in \{0, 1\}$ . Clearly, we have freedom in the choice of the states into which each of these states are encoded to. Additionally, we have freedom in the choice of the encoded operators though they are not entirely unrelated. Perhaps, this is best illustrated through an example. Let us consider Shor's  $[[9, 1, 3]]_2$  code. A choice of the logical states for this code is

$$\begin{aligned} |\bar{0}\rangle &= (|000\rangle + |111\rangle)(|000\rangle + |111\rangle)(|000\rangle + |111\rangle), \\ |\bar{1}\rangle &= (|000\rangle - |111\rangle)(|000\rangle - |111\rangle)(|000\rangle - |111\rangle). \end{aligned}$$

For this choice of the encoded states the logical  $Z$  operator is  $X^{\otimes 9}$  and the logical  $X$  operator is  $Z^{\otimes 9}$ . On the other hand, let us see what happens if we choose the logical states as follows

$$\begin{aligned} |\bar{0}\rangle &= |000000000\rangle + |000111111\rangle + |111000111\rangle + |111111000\rangle, \\ |\bar{1}\rangle &= |111111111\rangle + |111000000\rangle + |000111000\rangle + |000000111\rangle. \end{aligned}$$

In this case the encoded  $X$  operator is  $X^{\otimes 9}$  and encoded  $Z$  operator is  $Z^{\otimes 9}$ ; they are flipped with respect to the previous choice!

So it becomes apparent that the assignment of the encoded operators as logical  $Z$  or  $X$  is flexible and it seems to depend on the choice of the logical states. But are we free to choose any basis of the codespace as the encoded logical states. We can show that this cannot be. For instance let us choose the logical zero state to be a superposition of the previous two assignments. Then we have

$$\begin{aligned} |\bar{0}\rangle &= (|000\rangle + |111\rangle)(|000\rangle + |111\rangle)(|000\rangle + |111\rangle) \\ &+ |000000000\rangle + |000111111\rangle + |111000111\rangle \\ &+ |111111000\rangle. \end{aligned}$$

The possibilities for the logical  $Z$  operator<sup>||</sup> are  $\pm X^{\otimes 9}$ ,  $\pm Z^{\otimes 9}$ ,  $\pm X^{\otimes 9} Z^{\otimes 9}$ . But for none of these operators we have  $\bar{Z} |\bar{0}\rangle = |\bar{0}\rangle$ . As these are the only possible encoded operators (modulo the stabilizer which acts trivially in any case), this is not a valid choice for  $|\bar{0}\rangle$ . This raises the question what are all the possible valid choices for the logical states. Let us look at yet another choice of logical states.

$$\begin{aligned} |\bar{0}\rangle &= (|000\rangle - |111\rangle)(|000\rangle - |111\rangle)(|000\rangle - |111\rangle), \\ |\bar{1}\rangle &= (|000\rangle + |111\rangle)(|000\rangle + |111\rangle)(|000\rangle + |111\rangle). \end{aligned}$$

In this case, the encoded  $Z$  and  $X$  operators are  $-X^{\otimes 9}$  and  $Z^{\otimes 9}$  respectively. This gives us a clue as to the possible logical all zero states for a given stabilizer code. The all zero logical state is the state in the code space that is fixed by the stabilizer and the logical  $Z$  operators. Assuming that  $S$  is the stabilizer and  $C_{\mathcal{P}_n}(S)$ , its centralizer, we can pick any  $k$  independent commuting generators in  $C_{\mathcal{P}_n}(S) \setminus SZ(\mathcal{P}_n)$  as  $Z$  operators. Hence, we have the following lemma.

**Lemma VII.17.** *Let  $S$  be the stabilizer of an  $[[n, k, d]]_2$  stabilizer code. If  $L \leq C_{\mathcal{P}_n}(S)$  is*

---

<sup>||</sup>Including scalar multiples of  $i$  will not change our conclusions.

any subgroup generated by  $n$  commuting generators such that  $L \cap Z(\mathcal{P}_n) = I$  and  $S \leq L$ , then the state stabilized by  $L$  is a valid logical all zero state for the stabilizer code defined by  $S$ .

The implicit choice of  $|\bar{0}\rangle$  made in Lemma VII.2 (by picking the encoded  $Z$  operators, at least the representatives) is convenient in the sense it allows us to speak of a canonical  $|\bar{0}\rangle$  without ambiguity. This  $|\bar{0}\rangle$  can be conveniently identified with the state  $P|0\rangle^{\otimes n}$ , where it will be recalled that  $P$  is the projector for the stabilizer code given as

$$P = \frac{1}{|S|} \sum_{M \in S} M. \quad (7.17)$$

## CHAPTER VIII

## QUANTUM LDPC CODES FOR ASYMMETRIC CHANNELS\*

Recently, quantum error-correcting codes were proposed that capitalize on the fact that many physical error models lead to a significant asymmetry between the probabilities for bit flip and phase flip errors. An example for a channel which exhibits such asymmetry is the combined amplitude damping and dephasing channel, where the probabilities of bit flips and phase flips can be related to relaxation and dephasing time, respectively. We give systematic constructions of asymmetric quantum stabilizer codes that exploit this asymmetry. Our approach is based on a CSS construction that combines BCH and finite geometry LDPC codes.

In many quantum mechanical systems the mechanisms for the occurrence of bit flip and phase flip errors are quite different. In a recent paper Ioffe and Mézard [77] postulated that quantum error-correction should take into account this asymmetry. The main argument given in [77] is that most of the known quantum computing devices have relaxation times ( $T_1$ ) that are around 1–2 orders of magnitude larger than the corresponding dephasing times ( $T_2$ ). In general, relaxation leads to both bit flip and phase flip errors, whereas dephasing only leads to phase flip errors. This large asymmetry between  $T_1$  and  $T_2$  suggests that bit flip errors occur less frequently than phase flip errors and a well designed quantum code would exploit this asymmetry of errors to provide better performance. In fact, this observation and its consequences for quantum error correction, especially quantum fault tolerance, have prompted investigations from various other researchers [2, 52, 148].

Our goal will be as in [77] to construct asymmetric quantum codes for quantum mem-

---

\*©2008 IEEE. Reprinted from, P. K. Sarvepalli, M. Rötteler, and A. Klappenecker. “Asymmetric quantum LDPC codes”. In *Proc. 2008 IEEE Intl. Symposium on Inform. Theory, Toronto, Canada*, Jul 6–11, pp. , 2008.



ories and at present we do not consider the issue of fault tolerance. We first quantitatively justify how noise processes, characterized in terms of  $T_1$  and  $T_2$ , lead to an asymmetry in the bit flip and phase flip errors. As a concrete illustration of this we consider the amplitude damping and dephasing channel. For this channel we can compute the probabilities of bit flip and phase flips in closed form. In particular, by giving explicit expressions for the ratio of these probabilities in terms of the ratio  $T_1/T_2$ , we show how the channel asymmetry arises.

After providing the necessary background, we give two systematic constructions of asymmetric quantum codes based on BCH and LDPC codes, as an alternative to the randomized construction of [77].

### A. Background

Recall that a quantum channel that maps a state  $\rho$  to

$$(1 - p_x - p_y - p_z)\rho + p_x X \rho X + p_y Y \rho Y + p_z Z \rho Z, \quad (8.1)$$

with  $\mathbb{I} = \begin{bmatrix} 1 & 0 \\ 0 & 1 \end{bmatrix}$ ,  $X = \begin{bmatrix} 0 & 1 \\ 1 & 0 \end{bmatrix}$ ,  $Y = \begin{bmatrix} 0 & -i \\ i & 0 \end{bmatrix}$ ,  $Z = \begin{bmatrix} 1 & 0 \\ 0 & -1 \end{bmatrix}$  is called a *Pauli channel*. For a Pauli channel, one can respectively determine the probabilities  $p_x, p_y, p_z$  that an input qubit in state  $\rho$  is subjected to a Pauli  $X$ ,  $Y$ , or  $Z$  error.

A combined *amplitude damping and dephasing channel*  $\mathcal{E}$  with relaxation time  $T_1$  and dephasing time  $T_2$  that acts on a qubit with density matrix  $\rho = (\rho_{ij})_{i,j \in \{0,1\}}$  for a time  $t$  yields the density matrix

$$\mathcal{E}(\rho) = \begin{bmatrix} 1 - \rho_{11} e^{-t/T_1} & \rho_{01} e^{-t/T_2} \\ \rho_{10} e^{-t/T_2} & \rho_{11} e^{-t/T_1} \end{bmatrix}.$$

This channel is interesting as it models common decoherence processes fairly well. We would like to determine the probability  $p_x$ ,  $p_y$ , and  $p_z$  such that an  $X$ ,  $Y$ , or  $Z$  error occurs

in a combined amplitude damping and dephasing channel. However, it turns out that this question is not well-posed, since  $\mathcal{E}$  is not a Pauli channel, that is, it cannot be written in the form (8.1). However, we can obtain a Pauli channel  $\mathcal{E}_T$  by a technique called twirling [45, 50]. In our case, the twirling consists of conjugating the channel  $\mathcal{E}$  by Pauli matrices and averaging over the results. The resulting channel  $\mathcal{E}_T$  is called the Pauli-twirl of  $\mathcal{E}$  and is explicitly given by

$$\mathcal{E}_T(\rho) = \frac{1}{4} \sum_{A \in \{\mathbb{I}, X, Y, Z\}} A^\dagger \mathcal{E}(A\rho A^\dagger) A.$$

**Theorem VIII.1.** *Given a combined amplitude damping and dephasing channel  $\mathcal{E}$  as above, the associated Pauli-twirled channel is of the form*

$$\mathcal{E}_T(\rho) = (1 - p_x - p_y - p_z)\rho + p_x X\rho X + p_y Y\rho Y + p_z Z\rho Z,$$

where  $p_x = p_y = (1 - e^{-t/T_1})/4$  and  $p_z = 1/2 - p_x - \frac{1}{2}e^{-t/T_2}$ . In particular,

$$\frac{p_z}{p_x} = 1 + 2 \frac{1 - e^{t/T_1(1-T_1/T_2)}}{e^{t/T_1} - 1}.$$

If  $t \ll T_1$ , then we can approximate this ratio as  $2T_1/T_2 - 1$ .

*Proof.* The Kraus operator decomposition [114] of  $\mathcal{E}$  is

$$\mathcal{E}(\rho) = \sum_{k=0}^2 A_k \rho A_k^\dagger, \quad (8.2)$$

where  $A_0 = \begin{bmatrix} 1 & 0 \\ 0 & \sqrt{1-\lambda-\gamma} \end{bmatrix}$ ;  $A_1 = \begin{bmatrix} 0 & 0 \\ 0 & \sqrt{\lambda} \end{bmatrix}$ ;  $A_2 = \begin{bmatrix} 0 & \sqrt{\gamma} \\ 0 & 0 \end{bmatrix}$ , and  $\sqrt{1-\lambda-\gamma} = e^{-t/T_2}$ ,  $1-\gamma = e^{-t/T_1}$ . We can rewrite the Kraus operators  $A_i$  as

$$\begin{aligned} A_0 &= \frac{1 + \sqrt{1-\lambda-\gamma}}{2} \mathbb{I} + \frac{1 - \sqrt{1-\lambda-\gamma}}{2} Z, \\ A_1 &= \frac{\sqrt{\lambda}}{2} \mathbb{I} - \frac{\sqrt{\lambda}}{2} Z, \quad A_2 = \frac{\sqrt{\gamma}}{2} X - \frac{\sqrt{\gamma}}{2i} Y. \end{aligned}$$

Rewriting  $\mathcal{E}(\rho)$  in terms of Pauli matrices yields

$$\begin{aligned}
\mathcal{E}(\rho) &= \frac{2 - \gamma + 2\sqrt{1 - \lambda - \gamma}}{4} \rho + \frac{\gamma}{4} X \rho X + \frac{\gamma}{4} Y \rho Y \\
&+ \frac{2 - \gamma - 2\sqrt{1 - \lambda - \gamma}}{4} Z \rho Z \\
&- \frac{\gamma}{4} \mathbb{I} \rho Z - \frac{\gamma}{4} Z \rho \mathbb{I} + \frac{\gamma}{4i} X \rho Y - \frac{\gamma}{4i} Y \rho X.
\end{aligned} \tag{8.3}$$

It follows that the Pauli-twirl channel  $\mathcal{E}_T$  is of the claimed form, see [45, Lemma 2]. Computing the ratio  $p_z/p_x$  we get

$$\begin{aligned}
\frac{p_z}{p_x} &= \frac{2 - \gamma - 2\sqrt{1 - \lambda - \gamma}}{\gamma} = \frac{1 + e^{-t/T_1} - 2e^{-t/T_2}}{1 - e^{-t/T_1}}, \\
&= 1 + 2 \frac{e^{-t/T_1} - e^{-t/T_2}}{1 - e^{-t/T_1}} = 1 + 2 \frac{1 - e^{t/T_1 - t/T_2}}{e^{t/T_1} - 1} \\
&= 1 + 2 \frac{1 - e^{t/T_1(1 - T_1/T_2)}}{e^{t/T_1} - 1}.
\end{aligned}$$

If  $t \ll T_1$ , then we can approximate the ratio as  $2T_1/T_2 - 1$ , as claimed.  $\square$

Thus, an asymmetry in the  $T_1$  and  $T_2$  times does translate to an asymmetry in the occurrence of bit flip and phase flip errors. Note that  $p_x = p_y$  indicating that the  $Y$  errors are as unlikely as the  $X$  errors. We shall refer to the ratio  $p_z/p_x$  as the channel asymmetry and denote this parameter by  $A$ .

Asymmetric quantum codes use the fact that the phase flip errors are much more likely than the bit flip errors or the combined bit-phase flip errors. Therefore the code has different error correcting capability for handling different type of errors. We require the code to correct many phase flip errors but it is not required to handle the same number of bit flip errors. If we assume a CSS code [35], then we can meaningfully speak of  $X$ -distance and  $Z$ -distance. A CSS stabilizer code that can detect all  $X$  errors up to weight  $d_x - 1$  is said to have an  $X$ -distance of  $d_x$ . Similarly if it can detect all  $Z$  errors upto weight  $d_z - 1$ , then it is said to have a  $Z$ -distance of  $d_z$ . We shall denote such a code by  $[[n, k, d_x/d_z]]_q$

to indicate it is an asymmetric code, see also [145] who was the first to use a notation that allowed to distinguish between  $X$ - and  $Z$ -distances. We could also view this code as an  $[[n, k, \min\{d_x, d_z\}]]_q$  stabilizer code. Further extension of these metrics to an additive non-CSS code is an interesting problem, but we will not go into the details here.

Recall that in the CSS construction a pair of codes are used, one for correcting the bit flip errors and the other for correcting the phase flip errors. Our choice of these codes will be such that the code for correcting the phase flip errors has a larger distance than the code for correcting the bit flip errors. We restate the CSS construction in a form convenient for asymmetric stabilizer codes.

**Lemma VIII.2** (CSS Construction [35]). *Let  $C_x, C_z$  be linear codes over  $\mathbb{F}_q^n$  with the parameters  $[n, k_x]_q$ , and  $[n, k_z]_q$  respectively. Let  $C_x^\perp \subseteq C_z$ . Then there exists an  $[[n, k_x + k_z - n, d_x/d_z]]_q$  asymmetric quantum code, where  $d_x = \text{wt}(C_x \setminus C_z^\perp)$  and  $d_z = \text{wt}(C_z \setminus C_x^\perp)$ .*

If in the above construction  $d_x = \text{wt}(C_x)$  and  $d_z = \text{wt}(C_z)$ , then we say that the code is pure.

In the theorem above and elsewhere in this paper  $\mathbb{F}_q$  denotes a finite field with  $q$  elements. We also denote a  $q$ -ary narrow-sense primitive BCH code of length  $n = q^m - 1$  and design distance  $\delta$  as  $\mathcal{BCH}(\delta)$ .

## B. Asymmetric Quantum Codes from LDPC Codes

In [77], Ioffe and Mézard used a combination of BCH and LDPC codes to construct asymmetric codes. The intuition being that the stronger LDPC code should be used for correcting the phase flip errors and the BCH code can be used for the infrequent bit flips. This essentially reduces to finding a good LDPC code such that the dual of the LDPC code is contained in the BCH code. They solve this problem by randomly choosing codewords in the BCH code which are of low weight (so that they can be used for the parity check ma-

trix of the LDPC code). However, this method leaves open how good the resulting LDPC code is. For instance, the degree profiles of the resulting code are not regular and there is little control over the final degree profiles of the code. Furthermore, it is not apparent what ensemble or degree profiles one will use to analyze the code.

We propose an alternate scheme that uses LDPC codes to construct asymmetric stabilizer codes. We propose two families of quantum codes based on LDPC codes. In the first case we use LDPC codes for both the  $X$  and  $Z$  channel while in the second construction we will use a combination of BCH and LDPC codes. But first, we will need the following facts about generalized Reed-Muller codes, ([80]) and finite geometry LDPC codes, ([98, 150]).

### 1. Finite Geometry LDPC Codes

Let us denote by  $\text{EG}(m, p^s)$  the Euclidean finite geometry over  $\mathbb{F}_{p^s}$  consisting of  $p^{ms}$  points. For our purposes it suffices to use the fact that this geometry is equivalent to the vector space  $\mathbb{F}_{p^s}^m$ . A  $\mu$ -dimensional subspace of  $\mathbb{F}_{p^s}^m$  or its coset is called a  $\mu$ -flat. Assume that  $0 \leq \mu_1 < \mu_2 \leq m$ . Then we denote by  $N_{\text{EG}}(\mu_2, \mu_1, s, p)$  the number of  $\mu_1$ -flats in a  $\mu_2$ -flat and by  $A_{\text{EG}}(m, \mu_2, \mu_1, s, p)$ , the number of  $\mu_2$ -flats that contain a given  $\mu_1$ -flat. These are given by (see [150])

$$N_{\text{EG}}(\mu_2, \mu_1, s, p) = q^{(\mu_2 - \mu_1)} \prod_{i=1}^{\mu_1} \frac{q^{\mu_2 - i + 1} - 1}{q^{\mu_1 - i + 1} - 1}, \quad (8.4)$$

$$A_{\text{EG}}(m, \mu_2, \mu_1, s, p) = \prod_{i=\mu_1+1}^{\mu_2} \frac{q^{m-i+1} - 1}{q^{\mu_2-i+1} - 1}, \quad (8.5)$$

where  $q = p^s$ . Index all the  $\mu_1$ -flats from  $i = 1$  to  $n = N_{\text{EG}}(m, \mu_1, s, p)$  as  $F_i$ . Let  $F$  be a  $\mu_2$ -flat in  $\text{EG}(m, p^s)$ . Then we can associate an incidence vector to  $F$  with respect to the

$\mu_1$  flats as follows.

$$\mathbf{i}_F = \left\{ \begin{array}{l} i_j = 1 \quad \text{if } F_j \text{ is contained in } F \\ i_j = 0 \quad \text{otherwise.} \end{array} \right\}.$$

Index the  $\mu_2$ -flats from  $j = 1$  to  $J = N_{\text{EG}}(m, \mu_2, s, p)$ . Construct the  $J \times n$  matrix  $H_{\text{EG}}^{(1)}(m, \mu_2, \mu_1, s, p)$  whose rows are the incidence vectors of all the  $\mu_2$ -flats with respect to the  $\mu_1$ -flats. This matrix is also referred to as the incidence matrix. Then the type-I Euclidean geometry code from  $\mu_2$ -flats and  $\mu_1$ -flats is defined to be the null space, i. e., Euclidean dual code) of the  $\mathbb{F}_p$ -linear span of  $H_{\text{EG}}^{(1)}(m, \mu_2, \mu_1, s, p)$ . This is denoted as  $C_{\text{EG}}^{(1)}(m, \mu_2, \mu_1, s, p)$ . Let  $H_{\text{EG}}^{(2)}(m, \mu_2, \mu_1, s, p) = H_{\text{EG}}^{(1)}(m, \mu_2, \mu_1, s, p)^t$ . The type-II Euclidean geometry code  $C_{\text{EG}}^{(2)}(m, \mu_2, \mu_1, s, p)$  is defined as the null space of  $H_{\text{EG}}^{(2)}(m, \mu_2, \mu_1, s, p)$ . Let us now consider the  $\mu_2$ -flats and  $\mu_1$ -flats that do not contain the origin of  $\text{EG}(m, p^s)$ . Now form the incidence matrix of the  $\mu_2$ -flats with respect to the  $\mu_1$ -flats not containing the origin. The null space of this incidence matrix gives us a quasi-cyclic code in general, which we denote by  $C_{\text{EG},c}^{(1)}(m, \mu_2, \mu_1, s, p)$ , see [150].

## 2. Generalized Reed-Muller Codes

Let  $\alpha$  be a primitive element in  $\mathbb{F}_{q^m}$ . The cyclic generalized Reed-Muller code of length  $q^m - 1$  and order  $\nu$  is defined as the cyclic code with the generator polynomial whose roots  $\alpha^j$  satisfy  $0 < j \leq m(q - 1) - \nu - 1$ . The generalized Reed-Muller code is the singly extended code of length  $q^m$ . It is denoted as  $\text{GRM}_q(\nu, m)$ . The dual of a GRM code is also a GRM code [17, 31, 80]. It is known that

$$\text{GRM}_q(\nu, m)^\perp = \text{GRM}_q(\nu^\perp, m), \quad (8.6)$$

where  $\nu^\perp = m(q - 1) - 1 - \nu$ .

Let  $C$  be a linear code over  $\mathbb{F}_{q^s}^n$ . Then we define  $C|_{\mathbb{F}_q}$ , the *subfield subcode* of  $C$  over

$\mathbb{F}_q^n$  as the codewords of  $C$  which are entirely in  $\mathbb{F}_q^n$ , (see [76, pages 116-120]). Formally this can be expressed as

$$C|_{\mathbb{F}_q} = \{c \in C \mid c \in \mathbb{F}_q^n\}. \quad (8.7)$$

Let  $C \subseteq \mathbb{F}_{q^l}^n$ . The the *trace code* of  $C$  over  $\mathbb{F}_q$  is defined as

$$\text{tr}_{q^l/q}(C) = \{\text{tr}_{q^l/q}(c) \mid c \in C\}. \quad (8.8)$$

There are interesting relations between the trace code and the subfield subcode. One of which is the following result which we will need later.

**Lemma VIII.3.** *Let  $C \subseteq \mathbb{F}_{q^l}^n$ . Then  $C|_{\mathbb{F}_q}$ , the subfield subcode of  $C$  is contained in  $\text{tr}_{q^l/q}(C)$ , the trace code of  $C$ . In other words*

$$C|_{\mathbb{F}_q} \subseteq \text{tr}_{q^l/q}(C).$$

*Proof.* Let  $c \in C|_{\mathbb{F}_q} \subseteq \mathbb{F}_q^n$  and  $\alpha \in \mathbb{F}_{q^l}$ . Then  $\text{tr}_{q^l/q}(\alpha c) = c \text{tr}_{q^l/q}(\alpha)$  as  $c \in \mathbb{F}_q^n$ . Since trace is a surjective form, there exists some  $\alpha \in \mathbb{F}_{q^l}$ , such that  $\text{tr}_{q^l/q}(\alpha) = 1$ . This implies that  $c \in \text{tr}_{q^l/q}(C)$ . Since  $c$  is an arbitrary element in  $C|_{\mathbb{F}_q}$  it follows that  $C|_{\mathbb{F}_q} \subseteq \text{tr}_{q^l/q}(C)$ .  $\square$

Let  $q = p^s$ , then the Euclidean geometry code of order  $r$  over  $\text{EG}(m, p^s)$  is defined as the dual of the subfield subcode of  $\text{GRM}_q((q-1)(m-r-1), m)$ , [31, page 448]. The type-I LDPC code  $C_{\text{EG}}^{(1)}(m, \mu, 0, s, p)$  code is an Euclidean geometry code of order  $\mu - 1$  over  $\text{EG}(m, p^s)$ , see [150]. Hence its dual is the subfield subcode of  $\text{GRM}_q((q-1)(m-\mu), m)$  code. In other words,

$$C_{\text{EG}}^{(1)}(m, \mu, 0, s, p)^\perp = \text{GRM}_q((q-1)(m-\mu), m)|_{\mathbb{F}_p}. \quad (8.9)$$

Further, Delsarte's theorem [48] tells us that

$$\begin{aligned} C_{\text{EG}}^{(1)}(m, \mu, 0, s, p) &= \text{GRM}_q((q-1)(m-\mu), m)|_{\mathbb{F}_p}^\perp, \\ &= \text{tr}_{q/p}(\text{GRM}_q((q-1)(m-\mu), m)^\perp) \\ &= \text{tr}_{q/p}(\text{GRM}_q(\mu(q-1) - 1, m)). \end{aligned}$$

Hence,  $C_{\text{EG}}^{(1)}(m, \mu, 0, s, p)$  code can also be related to  $\text{GRM}_q(\mu(q-1) - 1, m)$  as

$$C_{\text{EG}}^{(1)}(m, \mu, 0, s, p) = \text{tr}_{q/p}(\text{GRM}_q(\mu(q-1) - 1, m)). \quad (8.10)$$

### 3. New Families of Asymmetric Quantum Codes

With the previous preparation we are now ready to construct asymmetric quantum codes from finite geometry LDPC codes.

**Theorem VIII.4** (Asymmetric EG LDPC Codes). *Let  $p$  be a prime, with  $q = p^s$  and  $s \geq 1, m \geq 2$ . Let  $1 < \mu_z < m$  and  $m - \mu_z + 1 \leq \mu_x < m$ . Then there exists an*

$$[[p^{ms}, k_x + k_z - p^{ms}, d_x/d_z]]_p$$

*asymmetric EG LDPC code, where*

$$k_x = \dim C_{\text{EG}}^{(1)}(m, \mu_x, 0, s, p); \quad k_z = \dim C_{\text{EG}}^{(1)}(m, \mu_z, 0, s, p).$$

*For the distances  $d_x \geq A_{\text{EG}}(m, \mu_x, \mu_x - 1, s, p) + 1$  and  $d_z \geq A_{\text{EG}}(m, \mu_z, \mu_z - 1, s, p) + 1$  hold.*

*Proof.* Let  $C_z = C_{\text{EG}}^{(1)}(m, \mu_z, 0, s, p)$ . Then from equation (8.10) we have

$$C_z = \text{tr}_{q/p}(\text{GRM}_q(\mu_z(q-1) - 1, m)).$$



By Lemma VIII.3 we know that

$$\begin{aligned} C_z &\supseteq \text{GRM}_q(\mu_z(q-1) - 1, m)|_{\mathbb{F}_p}, \\ C_z &\supseteq \text{GRM}_q((q-1)(m - (m - \mu_z + 1)), m)|_{\mathbb{F}_p}, \end{aligned}$$

where the last inclusion follows from the nesting property of the generalized Reed-Muller codes. For any order  $\mu_x$  such that  $m - \mu_z + 1 \leq \mu_x < m$ , let  $C_x = C_{\text{EG}}^{(1)}(m, \mu_x, 0, s, p)$ . Then  $C_x$  is an LDPC code whose dual  $C_x^\perp = \text{GRM}_q((q-1)(m - \mu_x), m)|_{\mathbb{F}_p}$  is contained in  $C_z$ . Thus we can use Lemma VIII.2 to form an asymmetric code with the parameters

$$[[p^{ms}, k_x + k_z - p^{ms}, d_x/d_z]]_p$$

The distance of  $C_z$  and  $C_x$  are at lower bounded as  $d_x \geq A_{\text{EG}}(m, \mu_x, \mu_x - 1, s, p) + 1$  and  $d_z \geq A_{\text{EG}}(m, \mu_z, \mu_z - 1, s, p) + 1$  (see [150]).  $\square$

In the construction just proposed, we should choose  $C_z$  to be a stronger code compared to  $C_x$ . We have given the construction over a nonbinary alphabet even though the case  $p = 2$  might be of particular interest.

We briefly turn our attention back to the depolarizing channel. The LDPC codes designed for the asymmetric channels will not in general perform well on the depolarizing channel. In fact constructing good quantum LDPC codes for the depolarizing channel remains a difficult problem and a satisfactory solution is yet to be advanced. We contribute to the ongoing discussion in this topic by drawing upon the finite geometry LDPC codes as we did for the asymmetric codes. The codes presented in Theorem VIII.4 can under certain conditions lead to LDPC codes that are suitable for use on the depolarizing channel.

**Corollary VIII.5** (EG LDPC Codes for Depolarizing Channel). *Let  $p$  be a prime, with  $q = p^s$  and  $s \geq 1, m \geq 2$ . Let  $\lceil (m+1)/2 \rceil \leq \mu < m$ . Then there exists an  $[[p^{ms}, 2k - p^{ms}, d]]_p$  symmetric EG LDPC code, where  $k = \dim C_{\text{EG}}^{(1)}(m, \mu, 0, s, p)$ . For the distance*

$d \geq A_{\text{EG}}(m, \mu, \mu - 1, s, p) + 1$  holds.

Our next construction makes use of the cyclic finite geometry codes. Our goal will be to find a small BCH code whose dual is contained in a cyclic Euclidean geometry LDPC code. For solving this problem we need to know the cyclic structure of  $C_{\text{EG},c}^{(1)}(m, \mu, 0, s, p)$ . Let  $\alpha$  be a primitive element in  $\mathbb{F}_{p^{ms}}$ . Then the roots of the generator polynomial of  $C_{\text{EG},c}^{(1)}(m, \mu, 0, s, p)$  are given by [79, Theorem 6], see also [81, 104]. Now,

$$Z = \{\alpha^h \mid 0 < \max_{0 \leq l < s} W_{p^s}(hp^l) \leq (p^s - 1)(m - \mu)\},$$

where  $W_q(h)$  is the  $q$ -ary weight of  $h = h_0 + h_1q + \dots + h_kq^{k-1}$ , i. e.,  $W_q(h) = \sum h_i$ . The finite geometry code  $C_{\text{EG},c}^{(1)}(m, \mu, 0, s, p)$  is actually an  $(\mu - 1, p^s)$  Euclidean geometry code. The roots of the generator polynomial of the dual code are given by

$$Z^\perp = \{\alpha^h \mid \min_{0 \leq l < s} W_{p^s}(hp^l) < \mu(p^s - 1)\}.$$

In fact, the dual code is the even-like subcode of a primitive polynomial code of length  $p^{ms} - 1$  over  $\mathbb{F}_p$  and order  $m - \mu$ , whose generator polynomial, by [81, Theorem 6], has the roots

$$Z_p = \{\alpha^h \mid 0 < \min_{0 \leq l < s} W_{p^s}(hp^l) < \mu(p^s - 1)\}.$$

Thus  $Z^\perp = Z_p \cup \{0\}$ . Now by [81, Theorem 11],  $Z_p$  and therefore  $Z^\perp$  contain the sequence of consecutive roots,  $\alpha, \alpha^2, \dots, \alpha^{\delta_0 - 1}$ , where  $\delta_0 = (R + 1)p^{Qs} - 1$  and  $m(p^s - 1) - (m - \mu)(p^s - 1) = Q(p^s - 1) + R$ . Simplifying, we see that  $R = 0$  and  $Q = \mu$  giving  $\delta_0 = p^{\mu s} - 1$ .

It follows that

$$\begin{aligned} C_{\text{EG},c}^{(1)}(m, \mu, 0, s, p)^\perp &= \text{GRM}_q(m, (q - 1)(m - \mu))|_{\mathbb{F}_p} \\ &\subseteq \text{BCH}(\delta_0). \end{aligned}$$

Thus we have solved the problem of construction of the asymmetric stabilizer codes in

a dual fashion to that of [77]. Instead of finding an LDPC code whose parity check matrix is contained in a given BCH code, we have found a BCH code whose parity check matrix is contained in a given finite geometry LDPC code. This gives us the following result.

**Theorem VIII.6** (Asymmetric BCH-LDPC stabilizer codes). *Let  $C_z = C_{\text{EG},c}^{(1)}(m, \mu, 0, s, p)$  and  $\delta \leq \delta_0 = p^{\mu s} - 1$ . Let  $n = p^{m s} - 1$  and  $C_x = \mathcal{BCH}(\delta) \subseteq \mathbb{F}_p^n$ . Then there exists an*

$$[[n, k_x + k_z - n, d_x/d_z]]_p$$

*asymmetric stabilizer code where  $d_z \geq A_{\text{EG}}(m, \mu, \mu - 1, s, p)$ ,  $d_x \geq \delta$  and  $k_x = \dim C_x$ ,  $k_z = \dim C_z$ .*

Perhaps an example will be helpful at this juncture.

**Example VIII.7.** *Let  $m = s = p = 2$  and  $\mu = 1$ . Then  $C_{\text{EG},c}^{(1)}(2, 1, 0, 2, 2)$  is a cyclic code whose generator polynomial has roots given by*

$$\begin{aligned} Z &= \{\alpha^h | 0 < \max_{0 \leq l < 2} W_{2^2}(2^l h) \leq (m - \mu)(p^s - 1) = 3\} \\ &= \{\alpha^1, \alpha^2, \alpha^3, \alpha^4, \alpha^6, \alpha^8, \alpha^9, \alpha^{12}\}. \end{aligned}$$

*As there are 4 consecutive roots and  $|Z| = 8$ , it defines a  $[15, 7, \geq 5]$  code. The roots of the generator polynomial of the dual code are given by*

$$\begin{aligned} Z^\perp &= \{\alpha^h | 0 < \min_{0 \leq l < 2} W_{2^2}(2^l h) \leq \mu(p^s - 1) = (2^2 - 1)\} \\ &= \{\alpha^0, \alpha^1, \alpha^2, \alpha^4, \alpha^5, \alpha^8, \alpha^{10}\}. \end{aligned}$$

*We see that  $Z^\perp$  has two consecutive roots excluding 1, therefore the dual code is contained in a narrow sense BCH code with design distance 3. Note that  $p^{\mu s} - 1 = 3$ . Thus we can choose  $C_x = \mathcal{BCH}(3)$  and  $C_z = C_{\text{EG},c}^{(1)}(2, 1, 0, 2, 2)$  and apply Lemma VIII.2 to construct a  $[[15, 3, 3/5]]_2$  asymmetric code.*

We can also state the above construction as in [77], that is given a primitive BCH code of design distance  $\delta$ , find an LDPC code whose dual is contained in it. It must be pointed out that in case of asymmetric codes derived from LDPC codes, the asymmetry factor  $d_x/d_z$  is not as indicative of the code performance as in the case of bounded distance decoders. For  $m = p = 2$ , we can derive explicit relations for the parameters of the codes.

**Corollary VIII.8.** *Let  $C = C_{\text{EG},c}^{(1)}(2, 1, 0, s, 2)$  and  $\delta = 2t + 1 \leq 2^s - 1$ . Then there exists an*

$$[[2^{2s} - 1, 2^{2s} - 3^s - s(\delta - 1), \delta/2^s + 1]]_2$$

*asymmetric stabilizer code.*

*Proof.* The parameters of  $C$  are  $[2^{2s} - 1, 2^{2s} - 3^s, 2^s + 1]_2$ , see [104]. Since  $C^\perp$  is contained in a BCH code of length  $2^{2s} - 1$  whose design distance  $\delta \leq 2^s - 1$ , we can compute the dimension of the BCH code as  $2^{2s} - 1 - s(\delta - 1)$ , see [107, Corollary 8]. By Lemma VIII.2 the quantum code has the dimension  $2^{2s} - 3^s - s(\delta - 1)$ .  $\square$

**Example VIII.9.** *For  $m = p = 2$  and  $s = 4$  we can obtain a  $[255, 175, 17]$  LDPC code. We can choose any BCH code with design distance  $\delta \leq 2^4 - 1 = 15$  to construct an asymmetric code. Table III lists possible codes.*

### C. Performance Results

We now study the performance of the codes constructed in the previous section. We assume that the overall probability of error in the channel is given by  $p$ , while the individual probabilities of  $X$ ,  $Y$ , and  $Z$  errors are  $p_x = p/(A + 2)$ ,  $p_y = p/(A + 2)$  and  $p_z = pA/(A + 2)$  respectively. The exact performance would require us to simulate a 4-ary channel and also account for the fact that some errors can be estimated modulo the stabilizer. However, we do not account for this and in that sense these results provide an upper

Table III. Asymmetric BCH-LDPC stabilizer codes

$s$	$\delta$	Code $[[n, k, d_x/d_z]]_2$	Asymmetry $d_z/d_x$	Rate
4	15	$[[255, 119, 15/17]]_2$	$\approx 1$	0.467
4	13	$[[255, 127, 13/17]]_2$	$\approx 1.25$	0.498
4	11	$[[255, 135, 11/17]]_2$	$\approx 1.5$	0.529
4	9	$[[255, 143, 9/17]]_2$	$\approx 2$	0.561
4	7	$[[255, 151, 7/17]]_2$	$\approx 2.5$	0.592
4	5	$[[255, 159, 5/17]]_2$	$\approx 3$	0.624
4	3	$[[255, 167, 3/17]]_2$	$\approx 6$	0.655

bound on the actual error rates. The 4-ary channel can be modeled as two binary symmetric channels – one modeling the bit flip channel and the other the phase flip channel. For exact performance, these two channels should be dependent, however, a good approximation is to model the channel as two independent BSCs with cross over probabilities  $p_x + p_y = 2p/(A + 2)$  and  $p_y + p_z = p(A + 1)/(A + 2)$ . In this case the overall error rate in the quantum channel is the sum of the error rates in the two BSCs. While this approach is going to slightly overestimate the error rates, nonetheless it is useful and has been used before [105]. Since the  $X$ -channel uses a BCH code and decoded using a bounded distance decoder, we can just compute  $P_e^x$  the  $X$  error rate, in closed form. The error rate in the  $Z$  channel,  $P_e^z$  is obtained through simulations. The overall error rate is

$$P_e = 1 - (1 - P_e^x)(1 - P_e^z) = P_e^x + P_e^z - P_e^x P_e^z \approx P_e^x + P_e^z.$$

**Decoding LDPC Codes.** The LDPC code was decoded using the an algorithm similar to the hard decision bit flipping algorithm given in [98]. This is an instance of the bit flipping

algorithm originally given by Gallager. The maximum number of iterations for decoding is set to 50. A small modification had to be made to accommodate the special situation of quantum syndrome decoding. By measuring the generators of the stabilizer group, we obtain a classical syndrome, which due to the fact that only  $\pm 1$  eigenspaces occur in all of the generators, is hard information. We use the syndrome as shown in Figure 9 and initialize all the bit nodes with 0 at the start of the algorithm. Then the algorithm proceeds in the usual fashion as in [98]. We implemented this algorithm and ran several simulations which are described next.

In figure 10 we see the performance of  $[[255, 159, 5/17]]$  as the channel asymmetry is varied from 1 to 100. We see that as we increase the asymmetry the code starts to perform better. As the asymmetry is increased eventually the performance of the quantum code approaches the performance of the classical LDPC code.

Tolerating a little rate loss improves the performance as can be seen from figure 11. If we increase the distance of the BCH code the code becomes more tolerant to variations in channel asymmetry as can be seen by the performance of  $[[255, 143, 9/17]]$  in figure 12. This plot also illustrates an important point. Our channel model assumes that as we vary the channel asymmetry we keep the total probability of error in the channel fixed. This implies that while the probability of  $X$  errors goes down, the probability of  $Z$  errors tends to  $p$ , the total probability of error. Hence, the reduction in error rate in the  $X$  channel must more than compensate for the increase in  $Z$  error rate. If on the other hand, we had fixed the probability of error in the  $Z$  channel and varied the channel asymmetry then we would observe a monotonic improvement in the error rate because on one hand the  $Z$  error rate does not change but the  $X$  error rate does. We note that with larger lengths we can get an even steep drop in the error rate as is apparent from the performance of  $[[1023, 731, 11/33]]$  code shown in Figure 13.

The question naturally raises how do these codes compare with the codes proposed

in [77]. Strictly speaking both constructions have regimes where they can perform better than the other. But it appears that the algebraically constructed asymmetric codes have the following benefits with respect to the randomly constructed ones of [77].

- They give comparable performance and higher data rates with shorter lengths.
- The benefits of classical algebraic LDPC codes are inherited, giving for instance lower error floors compared to the random constructions.
- The code construction is systematic.

Our codes also offer flexibility in the rate and performance of the code because we can choose many possible BCH codes for a given finite geometry LDPC code or vice versa. The flip side however is that the codes given here have higher complexity of decoding.

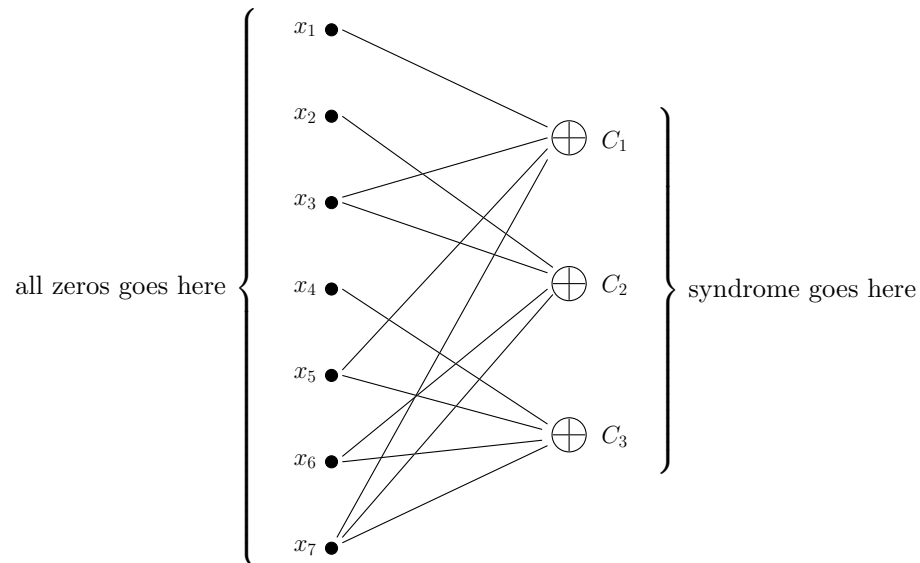

Fig. 9. Modification of the iterative message passing algorithm to the quantum case. The initialization step is different from the classical case as no soft information from the channel is available but rather only hard information about the measured syndrome is available. The algorithm begins with initializing all bit nodes to 0 and the check nodes with the syndrome. From then on, any classically known method for iterative decoding can be applied. In the figure this principle is shown for the example of a classical  $[7,4,3]$  Hamming code. Application to the quantum case is straightforward as the decoding algorithm only works with classical information to compute the most likely error.



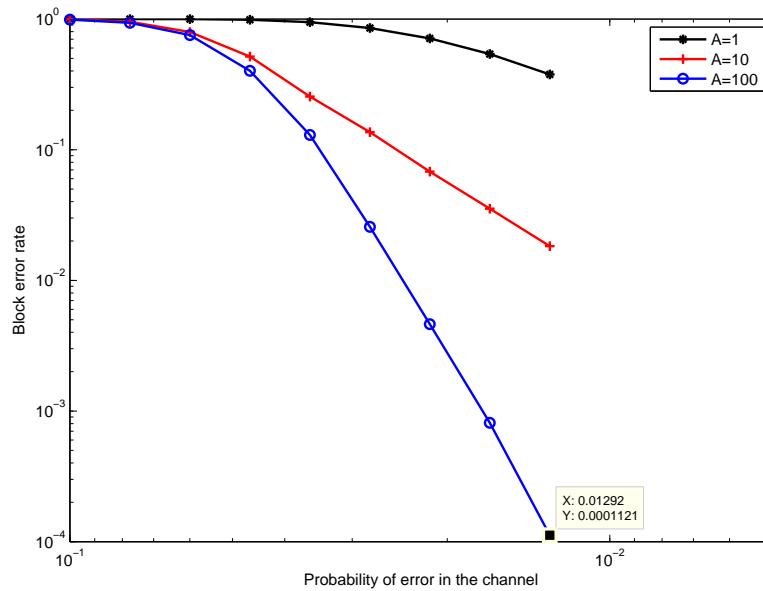

Fig. 10. Performance of a  $[[255, 159, 5/17]]$  code described in the text for choices  $A = 1, 10, 100$  of the channel asymmetry.

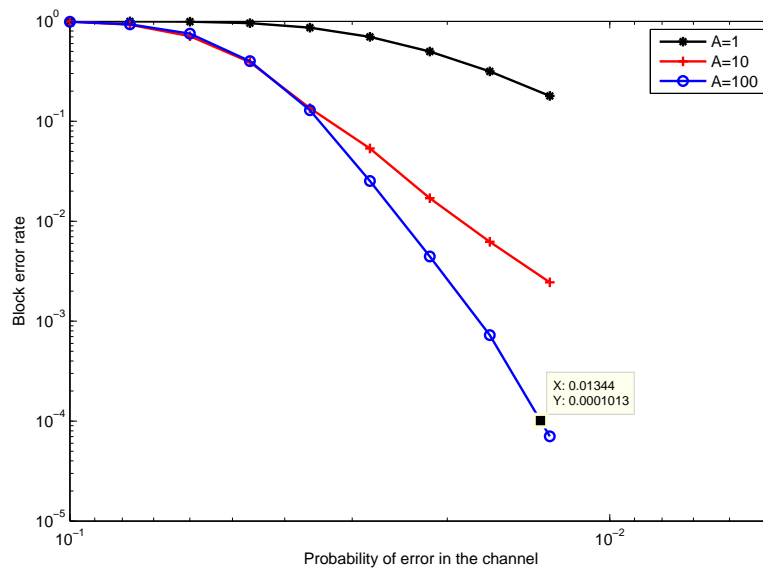

Fig. 11. Performance of a  $[[255, 151, 7/17]]$  code described in the text for choices  $A = 1, 10, 100$  of the channel asymmetry.

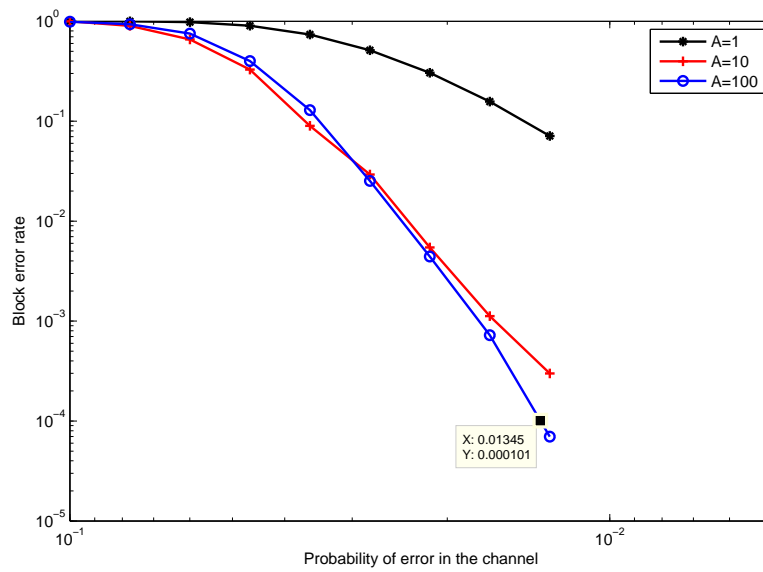

Fig. 12. Performance of a  $[[255, 143, 9/17]]$  code described in the text for choices  $A = 1, 10, 100$  of the channel asymmetry.

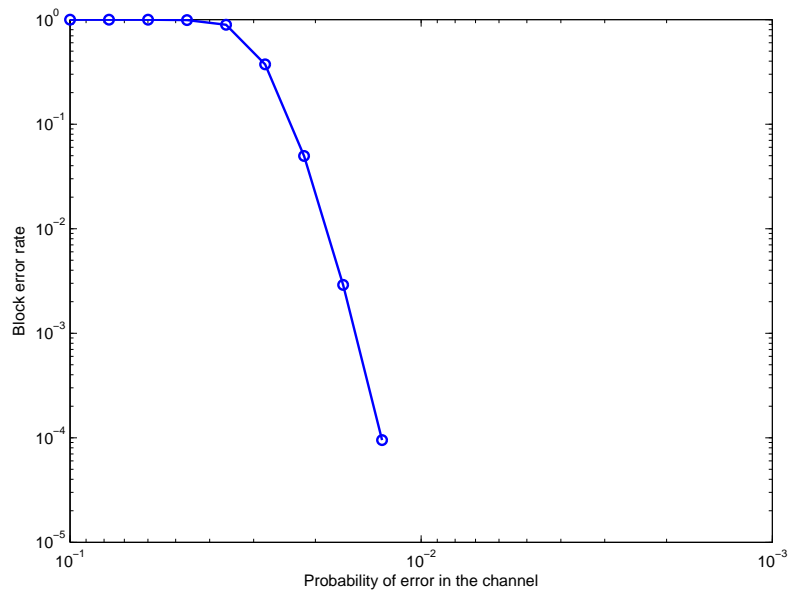

Fig. 13. Performance of  $[[1023, 731, 11/33]]$  code for  $A = 100$ .

## CHAPTER IX

## NEW RESULTS ON BCH CODES\*

The Bose-Chaudhuri-Hocquenghem (BCH) codes [32, 33, 58, 75] are a well-studied class of cyclic codes that have found numerous applications in classical and more recently in quantum information processing. Recall that a cyclic code of length  $n$  over a finite field  $\mathbb{F}_q$  with  $q$  elements, and  $\gcd(n, q) = 1$ , is called a *BCH code with designed distance*  $\delta$  if its generator polynomial is of the form

$$g(x) = \prod_{z \in Z} (x - \alpha^z), \quad Z = C_b \cup \dots \cup C_{b+\delta-2},$$

where  $C_x = \{xq^k \bmod n \mid k \in \mathbb{Z}, k \geq 0\}$  denotes the  $q$ -ary cyclotomic coset of  $x$  modulo  $n$ ,  $\alpha$  is a primitive element of  $\mathbb{F}_{q^m}$ , and  $m = \text{ord}_n(q)$  is the multiplicative order of  $q$  modulo  $n$ . Such a code is called primitive if  $n = q^m - 1$ , and narrow-sense if  $b = 1$ .

An attractive feature of a (narrow-sense) BCH code is that one can derive many structural properties of the code from the knowledge of the parameters  $n$ ,  $q$ , and  $\delta$  alone. Perhaps the most well-known facts are that such a code has minimum distance  $d \geq \delta$  and dimension  $k \geq n - (\delta - 1)\text{ord}_n(q)$ . In this chapter, we will show that a necessary condition for a narrow-sense BCH code which contains its Euclidean dual code is that its designed distance  $\delta = O(qn^{1/2})$ . We also derive a sufficient condition for dual containing BCH codes. Moreover, if the codes are primitive, these conditions are same. These results allow us to derive families of quantum stabilizer codes. Along the way, we find new results concerning the minimum distance and dimension of classical BCH codes.

To put our results into context, we give a brief overview of related work. This chapter

---

\*©2007 IEEE. Reprinted with permission from S. A. Aly, A. Klappenecker and P. K. Sarvepalli, "On quantum and classical BCH codes". *IEEE Trans. Inform. Theory*, vol 53, no. 3, pp. 1183–1188, 2007.

was motivated by problems concerning quantum BCH codes; specifically, our goal was to derive the parameters of the quantum codes as a function of the design parameters. Examples of certain binary quantum BCH codes have been given by many authors, see, for example, [35, 68, 69, 145]. Steane [146] gave a simple criterion to decide when a binary narrow-sense primitive BCH code contains its dual, given the design distance and the length of the code. We generalize Steane's result in various ways, in particular, to narrow-sense (not necessarily primitive) BCH codes over arbitrary finite fields with respect to Euclidean and Hermitian duality. These results allow one to derive quantum BCH codes; however, it remains to determine the dimension, purity, and minimum distance of such quantum codes.

The dimension of a classical BCH code can be bounded by many different standard methods, see [24, 76, 107] and the references therein. An upper bound on the dimension was given by Shparlinski [143], see also [97, Chapter 17]. More recently, the dimension of primitive narrow-sense BCH codes of designed distance  $\delta < q^{\lceil m/2 \rceil} + 1$  was apparently determined by Yue and Hu [156], according to reference [155]. We generalize their result and determine the dimension of narrow-sense BCH codes that are not necessarily primitive for a certain range of designed distances. As desired, this result allows us to explicitly obtain the dimension of the quantum codes without computation of cyclotomic cosets.

The purity and minimum distance of a quantum BCH code depend on the minimum distance and dual distance of the associated classical code. In general, it is a difficult problem to determine the true minimum distance of BCH codes, see [38]. A lower bound on the dual distance can be given by the Carlitz-Uchiyama-type bounds when the number of field elements is prime, see, for example, [107, page 280] and [149]. Many authors have determined the true minimum distance of BCH codes in special cases, see, for instance, [118], [155].

This chapter also extends our previous work on *primitive* narrow-sense BCH codes [4], simplifies some of the proofs and generalizes many of the results to the nonprimitive case.

*Notation.* We denote the ring of integers by  $\mathbf{Z}$  and the finite field with  $q$  elements by  $\mathbb{F}_q$ . We use the bracket notation of Iverson and Knuth that associates to  $[statement]$  the value 1 if  $statement$  is true, and 0 otherwise. For instance, we have  $[k \text{ even}] = k - 1 \bmod 2$  and  $[k \text{ odd}] = k \bmod 2$  for an integer  $k$ . The Euclidean dual code  $C^\perp$  of a code  $C \subseteq \mathbb{F}_q^n$  is given by  $C^\perp = \{y \in \mathbb{F}_q^n \mid x \cdot y = 0 \text{ for all } x \in C\}$ , while the Hermitian dual of  $C \subseteq \mathbb{F}_{q^2}^n$  is defined as  $C^{\perp_h} = \{y \in \mathbb{F}_{q^2}^n \mid y^q \cdot x = 0 \text{ for all } x \in C\}$ . We denote a narrow-sense BCH code of length  $n$  over  $\mathbb{F}_q$  with designed distance  $\delta$  by  $\text{BCH}(n, q; \delta)$ , and we omit the parameter  $q$  if the finite field is clear from the context.

### A. Euclidean Dual Codes

Recall that one can construct quantum stabilizer codes using classical codes that contain their duals. In this section, our goal is to find such classical codes. Steane showed that a primitive, narrow-sense, binary BCH code of length  $2^m - 1$  contains its dual if and only if its designed distance  $\delta$  satisfies  $\delta \leq 2^{\lceil m/2 \rceil} - 1$ , see [146]. We generalize this result in various ways.

**Lemma IX.1.** *Let  $C$  be a cyclic code of length  $n$  over the finite field  $\mathbb{F}_q$  such that  $\gcd(n, q) = 1$ , and let  $Z$  be the defining set of  $C$ . The code  $C$  contains its Euclidean dual code if and only if  $Z \cap Z^{-1} = \emptyset$ , where  $Z^{-1}$  denotes the set  $Z^{-1} = \{-z \bmod n \mid z \in Z\}$ .*

*Proof.* See [70, Theorem 2]. See also [76, Theorem 4.4.11]. □

Let us first consider narrow-sense BCH codes of length  $n$  such that the multiplicative order of  $q$  modulo  $n$  equals 1; for example, Reed-Solomon codes belong to this class of codes. We can avoid some special cases in our subsequent arguments by treating this case separately. Furthermore, the next lemma nicely illustrates the proof technique that will be used throughout this section, so it can serve as a warm-up exercise.

**Lemma IX.2.** *Suppose that  $q$  is a power of a prime and  $n$  is a positive integer such that  $q \equiv 1 \pmod{n}$ . We have  $\text{BCH}(n, q; \delta)^\perp \subseteq \text{BCH}(n, q; \delta)$  if and only if the designed distance  $\delta$  is in the range  $2 \leq \delta \leq \delta_{\max} = \lfloor (n+1)/2 \rfloor$ .*

*Proof.* The defining set  $Z$  of  $\text{BCH}(n, q; \delta)$  is given by  $Z = \{1, \dots, \delta - 1\}$ , since  $q$  has multiplicative order 1 modulo  $n$ , and therefore all cyclotomic cosets are singleton sets. If  $\text{BCH}(n, q; \delta)^\perp \subseteq \text{BCH}(n, q; \delta)$ , then by Lemma IX.1,  $Z \cap Z^{-1} = \emptyset$ . If  $x \in Z$ , then  $n - x \notin Z$  and  $n - x > x$ ; hence,  $\delta_{\max} \leq \lfloor (n+1)/2 \rfloor$ . Conversely, if  $\delta \leq \lfloor (n+1)/2 \rfloor$ , then  $\min Z^{-1} = \min\{n-1, \dots, n-\delta+1\} = n-\delta+1 \geq n - \lfloor (n+1)/2 \rfloor + 1 = \lceil (n+1)/2 \rceil \geq \delta_{\max}$ ; hence,  $Z \cap Z^{-1} = \emptyset$  and Lemma IX.1 implies that  $\text{BCH}(n, q; \delta)^\perp \subseteq \text{BCH}(n, q; \delta)$ .  $\square$

If the multiplicative order  $m$  of  $q$  modulo  $n$  is larger than 1, then the defining set of the code has a more intricate structure, so proofs become more involved. The next theorem gives a sufficient condition on the designed distances for which the dual code of a narrow-sense BCH code is self-orthogonal.

**Theorem IX.3.** *Suppose that  $m = \text{ord}_n(q)$ . If the designed distance  $\delta$  is in the range  $2 \leq \delta \leq \delta_{\max} = \lfloor \kappa \rfloor$ , where*

$$\kappa = \frac{n}{q^m - 1} (q^{\lceil m/2 \rceil} - 1 - (q-2)[m \text{ odd}]), \quad (9.1)$$

*then  $\text{BCH}(n, q; \delta)^\perp \subseteq \text{BCH}(n, q; \delta)$ .*

*Proof.* It suffices to show that  $\text{BCH}(n, q; \delta_{\max})^\perp \subseteq \text{BCH}(n, q; \delta_{\max})$  holds, since  $\text{BCH}(n, q; \delta)$  contains  $\text{BCH}(n, q; \delta_{\max})$ , and the claim follows from these two facts.

Seeking a contradiction, we assume that  $\text{BCH}(n, q; \delta_{\max})$  does not contain its dual. Let  $Z = C_1 \cup \dots \cup C_{\delta_{\max}-1}$  be the defining set of  $\text{BCH}(n, q; \delta_{\max})$ . By Lemma IX.1,  $Z \cap Z^{-1} \neq \emptyset$ , which means that there exist two elements  $x, y \in \{1, \dots, \delta_{\max} - 1\}$  such that

$y \equiv -xq^j \pmod n$  for some  $j \in \{0, 1, \dots, m-1\}$ , where  $m$  is the multiplicative order of  $q$  modulo  $n$ . Since  $\gcd(q, n) = 1$  and  $q^m \equiv 1 \pmod n$ , we also have  $x \equiv -yq^{m-j} \pmod n$ . Thus, exchanging  $x$  and  $y$  if necessary, we can even assume that  $j$  is in the range  $0 \leq j \leq \lfloor m/2 \rfloor$ . It follows from (9.1) that

$$\begin{aligned} 1 &\leq xq^j \leq (\delta_{\max} - 1)q^j \\ &\leq \frac{n}{q^m - 1}(q^m - q^j - q^j(q-2)[m \text{ odd}]) - q^j \\ &< n, \end{aligned}$$

for all  $j$  in the range  $0 \leq j \leq \lfloor m/2 \rfloor$ . Since  $1 \leq xq^j < n$  and  $1 \leq y < n$ , we can infer from  $y \equiv -xq^j \pmod n$  that  $y = n - xq^j$ . But this implies

$$\begin{aligned} y &\geq n - xq^{\lfloor m/2 \rfloor} \\ &\geq n - \frac{n}{q^m - 1}(q^m - q^{\lfloor m/2 \rfloor} - q^{\lfloor m/2 \rfloor}(q-2)[m \text{ odd}]) + q^{\lfloor m/2 \rfloor} \\ &= \frac{n}{q^m - 1}(q^{\lfloor m/2 \rfloor} - 1 + q^{\lfloor m/2 \rfloor}(q-2)[m \text{ odd}]) \\ &\quad + q^{\lfloor m/2 \rfloor} \\ &\geq \delta_{\max}, \end{aligned}$$

contradicting the fact that  $y < \delta_{\max}$ . □

Now we will derive a necessary condition on the design distance of narrow-sense, nonprimitive BCH codes that contain their duals.

**Theorem IX.4.** *Suppose that  $m = \text{ord}_n(q)$ . If the designed distance  $\delta$  exceeds  $\delta_{\max} = \lfloor qn^{1/2} \rfloor$ , then  $\text{BCH}(n, q; \delta)^\perp \not\subseteq \text{BCH}(n, q; \delta)$ .*

*Proof.* Let  $n = n_0 + n_1q + \dots + n_{d-1}q^{d-1}$ , where  $0 \leq n_i \leq q-1$  and  $\delta \geq \delta_{\max} + 1$ . Then

the defining set  $Z \supseteq \{1, \dots, \lfloor qn^{1/2} \rfloor\}$ . We will show that  $Z \cap Z^{-1} \neq \emptyset$ . Let,

$$\begin{aligned} s &= \sum_{i=\lfloor d/2 \rfloor}^{d-1} n_i q^{i-\lfloor d/2 \rfloor}, \\ s &\leq (q-1) \sum_{i=\lfloor d/2 \rfloor}^{d-1} q^{i-\lfloor d/2 \rfloor} = q^{\lfloor d/2 \rfloor} - 1 < q^{\lfloor d/2 \rfloor}. \end{aligned}$$

Since  $q^{d-1} < n < q^d$ , we have  $q^{(d+1)/2} < qn^{1/2} < q^{(d+2)/2}$ . If  $d$  is even then  $\lfloor d/2 \rfloor < (d+1)/2$  and if  $d$  is odd, then  $\lfloor d/2 \rfloor \leq (d+1)/2$ . Hence we have  $s < q^{\lfloor d/2 \rfloor} \leq q^{(d+1)/2} < qn^{1/2}$ .

Therefore  $s \in Z$ . Now consider,

$$\begin{aligned} s' = n - sq^{\lfloor d/2 \rfloor} &= \sum_{i=0}^{d-1} n_i q^i - q^{\lfloor d/2 \rfloor} \sum_{i=\lfloor d/2 \rfloor}^{d-1} n_i q^{i-\lfloor d/2 \rfloor}, \\ &= \sum_{i=0}^{\lfloor d/2 \rfloor - 1} n_i q^i < q^{\lfloor d/2 \rfloor} \\ &< q^{(d+1)/2} < qn^{1/2}. \end{aligned}$$

Hence  $s' \in Z$  and by definition  $s' \in Z^{-1}$ , which implies  $Z \cap Z^{-1} \neq \emptyset$ ; by Lemma IX.1 it follows that  $\text{BCH}(n, q; \delta)^\perp \not\subseteq \text{BCH}(n, q; \delta)$ .  $\square$

The condition we just derived can be strengthened under some restrictions. Especially, if the constant  $\kappa$  in equation (9.1) is integral, then we can derive a necessary and sufficient condition as shown below:

**Theorem IX.5.** *We keep the notation of Theorem IX.4. Suppose that  $\kappa$  is integral, and that  $m \geq 2$ . We have  $\text{BCH}(n, q; \delta)^\perp \subseteq \text{BCH}(n, q; \delta)$  if and only if the designed distance  $\delta$  is in the range  $2 \leq \delta \leq \delta_{\max} = \kappa$ .*

*Proof.* Suppose that  $\text{BCH}(n, q; \delta)^\perp \subseteq \text{BCH}(n, q; \delta)$ . Seeking a contradiction, we assume that  $\delta > \delta_{\max}$ ; thus,  $\delta_{\max}$  is contained in the defining set  $Z$  of  $\text{BCH}(n, q; \delta)$ . If  $m$  is even,



then

$$\begin{aligned} -\delta_{\max}q^{\lfloor m/2 \rfloor} &\equiv -\frac{nq^{\lfloor m/2 \rfloor}}{q^{\lfloor m/2 \rfloor} + 1} \equiv -n + \frac{n}{q^{\lfloor m/2 \rfloor} + 1} \\ &\equiv \delta_{\max} \pmod{n}, \end{aligned}$$

hence,  $\delta_{\max} \in Z \cap Z^{-1} \neq \emptyset$ . If  $m$  is odd, then

$$\begin{aligned} -\delta_{\max}q^{\lfloor m/2 \rfloor} &\equiv -n(q^m - q^{\lceil m/2 \rceil} + q^{\lfloor m/2 \rfloor})/(q^m - 1) \\ &\equiv n(q^{\lceil m/2 \rceil} - q^{\lfloor m/2 \rfloor} - 1)/(q^m - 1) \\ &\equiv s \pmod{n}. \end{aligned}$$

By definition,  $s \in Z^{-1}$ ; furthermore,  $s < \delta_{\max}$ , so  $s \in Z \cap Z^{-1} \neq \emptyset$ . In both cases,  $m$  even and odd, we found that  $Z \cap Z^{-1}$  is not empty, so  $\text{BCH}(n, q; \delta)$  cannot contain its Euclidean dual code, contradiction. The converse follows from Theorem IX.3.  $\square$

As a consequence of Theorem IX.5 we have the following test for primitive narrow-sense BCH codes that contain their duals.

**Corollary IX.6.** *A primitive narrow-sense BCH code of length  $n = q^m - 1$ ,  $m \geq 2$ , over the finite field  $\mathbb{F}_q$  contains its Euclidean dual code if and only if its designed distance  $\delta$  satisfies*

$$2 \leq \delta \leq \delta_{\max} = q^{\lceil m/2 \rceil} - 1 - (q - 2)[m \text{ odd}].$$

We observe that a narrow-sense BCH code containing its Euclidean dual code must have a small designed distance ( $\delta = O(\sqrt{n})$ ), when the multiplicative order of  $q$  modulo  $n$  is greater than one. This raises the question whether one can allow larger designed distances by considering non-narrow-sense BCH codes. Our next result shows that this is not possible, at least in the case of primitive codes.

**Theorem IX.7.** *Let  $C$  be a primitive (not necessarily narrow-sense) BCH code of length*

$n = q^m - 1$  over  $\mathbb{F}_q$  with designed distance  $\delta$ . If  $m > 1$  and  $\delta$  exceeds

$$\delta_{\max} = \begin{cases} q^{m/2} - 1, & m \equiv 0 \pmod{2}, \\ 2(q^{(m+1)/2} - q + 1), & m \equiv 1 \pmod{2}, \end{cases}$$

then  $C$  cannot contain its Euclidean dual.

*Proof.* Let the defining set of  $C$  be  $Z = C_b \cup C_{b+1} \cup \cdots \cup C_{b+\delta-2}$ . We will show that if  $\delta > \delta_{\max}$  then  $Z \cap Z^{-1} \neq \emptyset$ . If  $0 \in Z$ , then  $0 \in Z^{-1}$ , so  $Z \cap Z^{-1} \neq \emptyset$ . Therefore, we can henceforth assume that  $0 \notin Z$ , which implies  $b \geq 1$  and  $b + \delta - 2 < n$ .

1. Suppose that  $m$  is even; thus,  $\delta_{\max} = q^{m/2} - 1$ . If  $\delta > \delta_{\max}$  then the defining set  $Z$  contains an element of the form  $s = \alpha \delta_{\max}$  for some integer  $\alpha$ . However,

$$\begin{aligned} -sq^{m/2} &\equiv -\alpha(q^{m/2} - 1)q^{m/2} \equiv \alpha(q^{m/2} - 1) \\ &\equiv s \pmod{n}. \end{aligned}$$

Hence,  $s \in Z \cap Z^{-1} \neq \emptyset$ .

2. Suppose that  $m > 1$  is odd; thus,  $\delta_{\max} = 2q^{(m+1)/2} - 2q + 2$ . If  $\delta > \delta_{\max}$  then there exists an integer  $\alpha$  such that two multiples of  $\delta' = \delta_{\max}/2$  are contained in the range  $b \leq (\alpha - 1)\delta' < \alpha\delta' \leq b + \delta - 2$ . Since  $b \geq 1$  and  $\alpha\delta' < n$ , it follows that  $2 \leq \alpha \leq q^{(m-1)/2}$ .

The defining set  $Z$  of the code contains the element  $s = \alpha\delta'$ . The number  $s' = \alpha(q^{(m+1)/2} - q^{(m-1)/2} - 1)$  lies in the range  $0 \leq s' \leq s$  and satisfies  $-sq^{(m-1)/2} \equiv s' \pmod{n}$ , so  $s' \in Z^{-1}$ .

Suppose that  $b \leq s'$ . Then  $s' \in Z$ , which implies  $Z \cap Z^{-1} \neq \emptyset$ .

Suppose that  $s' < b$ . Since  $b \leq (\alpha - 1)\delta'$ , we obtain the inequality  $s' < (\alpha - 1)\delta'$ ; solving for  $\alpha$  shows that  $\alpha \geq q$ ; thus,  $q \leq \alpha \leq q^{(m-1)/2}$ . Let  $t' = (\alpha - 1)(q^{(m+1)/2} - 1) + q^{(m-1)/2} - 1$ ; it is easy to check that  $t'$  is in the range  $(\alpha - 1)\delta' \leq t' \leq \alpha\delta'$  when

$\alpha \geq q$ ; thus,  $t' \in Z$ . Further, let  $t = s - (\alpha - q + 1)$ ; since  $t \geq s - \delta'$ , we have  $t \in Z$  as well. Since  $-tq^{(m-1)/2} \equiv t' \pmod{n}$ , we can conclude that  $t' \in Z \cap Z^{-1} \neq \emptyset$ .

Therefore, we can conclude that if the designed distance of  $C$  is greater than  $\delta_{\max}$ , then  $Z \cap Z^{-1} \neq \emptyset$ , which proves the claim thanks to Lemma IX.1.  $\square$

## B. Dimension and Minimum Distance

While the results in the previous section are sufficient to tell us when we can construct quantum BCH codes, they are still unsatisfactory because we do not know the dimension of these codes. To this end, we determine the dimension of narrow-sense BCH codes of length  $n$  with minimum distance  $d = O(n^{1/2})$ . It turns out that these results on dimension also allow us to sharpen the estimates of the true distance of some BCH codes.

First, we make some simple observations about cyclotomic cosets that are essential in our proof.

**Lemma IX.8.** *Let  $n$  be a positive integer and  $q$  be a power of a prime such that  $\gcd(n, q) = 1$  and  $q^{\lfloor m/2 \rfloor} < n \leq q^m - 1$ , where  $m = \text{ord}_n(q)$ . The cyclotomic coset  $C_x = \{xq^j \pmod{n} \mid 0 \leq j < m\}$  has cardinality  $m$  for all  $x$  in the range  $1 \leq x \leq nq^{\lfloor m/2 \rfloor} / (q^m - 1)$ .*

*Proof.* If  $m = 1$ , then  $|C_x| = 1$  for all  $x$  and the statement is trivially true. Therefore, we can assume that  $m > 1$ . Seeking a contradiction, we suppose that  $|C_x| < m$ , meaning that there exists a divisor  $j$  of  $m$  such that  $xq^j \equiv x \pmod{n}$ , or, equivalently, that  $x(q^j - 1) \equiv 0 \pmod{n}$  holds.

Suppose that  $m$  is even. The divisor  $j$  of  $m$  must be in the range  $1 \leq j \leq m/2$ . However,  $x(q^j - 1) \leq nq^{m/2}(q^{m/2} - 1)/(q^m - 1) < n$ ; hence  $x(q^j - 1) \not\equiv 0 \pmod{n}$ , contradicting the assumption  $|C_x| < m$ .

Suppose that  $m$  is odd. The divisor  $j$  of  $m$  must be in the range  $1 \leq j \leq m/3$ . Since  $q^{(m+1)/2} \leq q^{2m/3}$  for  $m \geq 3$ , we have  $x(q^j - 1) \leq nq^{(m+1)/2}(q^{m/3} - 1)/(q^m - 1) \leq$

$nq^{2m/3}(q^{m/3} - 1)/(q^m - 1) < n$ . Therefore,  $x(q^j - 1) \not\equiv 0 \pmod n$ , contradicting the assumption  $|C_x| < m$ .  $\square$

The following observation tells us when some cyclotomic cosets are disjoint.

**Lemma IX.9.** *Let  $n \geq 1$  be an integer and  $q$  be a power of a prime such that  $\gcd(n, q) = 1$  and  $q^{\lfloor m/2 \rfloor} < n \leq q^m - 1$ , where  $m = \text{ord}_n(q)$ . If  $x$  and  $y$  are distinct integers in the range  $1 \leq x, y \leq \min\{\lfloor nq^{\lfloor m/2 \rfloor} / (q^m - 1) - 1 \rfloor, n - 1\}$  such that  $x, y \not\equiv 0 \pmod q$ , then the  $q$ -ary cyclotomic cosets of  $x$  and  $y$  modulo  $n$  are distinct.*

*Proof.* If  $m = 1$ , then clearly  $C_x = \{x\}$ ,  $C_y = \{y\}$  and distinct  $x, y$  implies that  $C_x$  and  $C_y$  are disjoint. If  $m > 1$ , then  $x, y \leq \lfloor nq^{\lfloor m/2 \rfloor} / (q^m - 1) - 1 \rfloor < n - 1$ . The set  $S = \{xq^j \pmod n, yq^j \pmod n \mid 0 \leq j \leq \lfloor m/2 \rfloor\}$  contains  $2(\lfloor m/2 \rfloor + 1) \geq m + 1$  elements, since  $q^{\lfloor m/2 \rfloor} \times \lfloor nq^{\lfloor m/2 \rfloor} / (q^m - 1) - 1 \rfloor < n$  and, thus, no two elements are identified modulo  $n$ . If we assume that  $C_x = C_y$ , then the preceding observation would imply that  $|C_x| = |C_y| \geq |S| \geq m + 1$ , which is impossible since the maximal size of a cyclotomic coset is  $m$ . Hence, the cyclotomic cosets  $C_x$  and  $C_y$  must be disjoint.  $\square$

With these results in hand, we can now derive the dimension of narrow-sense BCH codes.

**Theorem IX.10.** *Let  $q$  be a prime power and  $\gcd(n, q) = 1$  with  $\text{ord}_n(q) = m$ . Then a narrow-sense BCH code of length  $q^{\lfloor m/2 \rfloor} < n \leq q^m - 1$  over  $\mathbb{F}_q$  with designed distance  $\delta$  in the range  $2 \leq \delta \leq \min\{\lfloor nq^{\lfloor m/2 \rfloor} / (q^m - 1) \rfloor, n\}$  has dimension*

$$k = n - m \lceil (\delta - 1)(1 - 1/q) \rceil. \quad (9.2)$$

*Proof.* Let the defining set of  $\text{BCH}(n, q; \delta)$  be  $Z = C_1 \cup C_2 \cdots \cup C_{\delta-1}$ ; a union of at most  $\delta - 1$  consecutive cyclotomic cosets. However, when  $1 \leq x \leq \delta - 1$  is a multiple of  $q$ , then  $C_{x/q} = C_x$ . Therefore, the number of cosets is reduced by  $\lfloor (\delta - 1)/q \rfloor$ . By Lemma IX.9, if

$x, y \not\equiv 0 \pmod{q}$  and  $x \neq y$ , then the cosets  $C_x$  and  $C_y$  are disjoint. Thus,  $Z$  is the union of  $(\delta - 1) - \lfloor (\delta - 1)/q \rfloor = \lceil (\delta - 1)(1 - 1/q) \rceil$  distinct cyclotomic cosets. By Lemma IX.8, all these cosets have cardinality  $m$ . Therefore, the degree of the generator polynomial is  $m \lceil (\delta - 1)(1 - 1/q) \rceil$ , which proves our claim about the dimension of the code.  $\square$

As a consequence of the dimension result, we can tighten the bounds on the minimum distance of narrow-sense BCH codes generalizing a result due to Farr, see [107, p. 259].

**Corollary IX.11.** A BCH( $n, q; \delta$ ) code

- i) with length in the range  $q^{\lfloor m/2 \rfloor} < n \leq q^m - 1$ ,  $m = \text{ord}_n(q)$ ,
- ii) and designed distance in the range  $2 \leq \delta \leq \min\{\lfloor nq^{\lfloor m/2 \rfloor} / (q^m - 1) \rfloor, n\}$
- iii) such that

$$\sum_{i=0}^{\lfloor (\delta+1)/2 \rfloor} \binom{n}{i} (q-1)^i > q^{m \lceil (\delta-1)(1-1/q) \rceil}, \quad (9.3)$$

has minimum distance  $d = \delta$  or  $\delta + 1$ ; if  $\delta \equiv 0 \pmod{q}$ , then  $d = \delta + 1$ .

*Proof.* Seeking a contradiction, we assume that the minimum distance  $d$  of the code satisfies  $d \geq \delta + 2$ . We know from Theorem IX.10 that the dimension of the code is  $k = n - m \lceil (\delta - 1)(1 - 1/q) \rceil$ . If we substitute this value of  $k$  into the sphere-packing bound  $q^k \sum_{i=0}^{\lfloor (d-1)/2 \rfloor} \binom{n}{i} (q-1)^i \leq q^n$ , then we obtain

$$\begin{aligned} \sum_{i=0}^{\lfloor (\delta+1)/2 \rfloor} \binom{n}{i} (q-1)^i &\leq \sum_{i=0}^{\lfloor (d-1)/2 \rfloor} \binom{n}{i} (q-1)^i \\ &\leq q^{m \lceil (\delta-1)(1-1/q) \rceil}, \end{aligned}$$

but this contradicts condition (9.3); hence,  $\delta \leq d \leq \delta + 1$ .

If  $\delta \equiv 0 \pmod{q}$ , then the cyclotomic coset  $C_\delta$  is contained in the defining set  $Z$  of the code because  $C_\delta = C_{\delta/q}$ . Thus, the BCH bound implies that the minimum distance must be at least  $\delta + 1$ .  $\square$

We conclude this section with a minor result on the dual distance of BCH codes which will be needed later for determining the purity of quantum codes.

**Lemma IX.12.** *Suppose that  $C$  is a narrow-sense BCH code of length  $n$  over  $\mathbb{F}_q$  with designed distance  $2 \leq \delta \leq \delta_{\max} = \lfloor n(q^{\lceil m/2 \rceil} - 1 - (q-2)[m \text{ odd}]) / (q^m - 1) \rfloor$ , then the dual distance  $d^\perp \geq \delta_{\max} + 1$ .*

*Proof.* Let  $N = \{0, 1, \dots, n-1\}$  and  $Z_\delta$  be the defining set of  $C$ . We know that  $Z_{\delta_{\max}} \supseteq Z_\delta \supset \{1, \dots, \delta-1\}$ . Therefore  $N \setminus Z_{\delta_{\max}} \subseteq N \setminus Z_\delta$ . Further, we know that  $Z \cap Z^{-1} = \emptyset$  if  $2 \leq \delta \leq \delta_{\max}$  from Lemma IX.1 and Theorem IX.3. Therefore,  $Z_{\delta_{\max}}^{-1} \subseteq N \setminus Z_{\delta_{\max}} \subseteq N \setminus Z_\delta$ .

Let  $T_\delta$  be the defining set of the dual code. Then  $T_\delta = (N \setminus Z_\delta)^{-1} \supseteq Z_{\delta_{\max}}$ . Moreover  $\{0\} \in N \setminus Z_\delta$  and therefore  $T_\delta$ . Thus there are at least  $\delta_{\max}$  consecutive roots in  $T_\delta$ . Thus the dual distance  $d^\perp \geq \delta_{\max} + 1$ .  $\square$

### C. Hermitian Dual Codes

Suppose that  $C$  is a linear code of length  $n$  over  $\mathbb{F}_{q^2}$ . Recall that its Hermitian dual code is defined by  $C^{\perp_h} = \{y \in \mathbb{F}_{q^2}^n \mid y^q \cdot x = 0 \text{ for all } x \in C\}$ , where  $y^q = (y_1^q, \dots, y_n^q)$  denotes the conjugate of the vector  $y = (y_1, \dots, y_n)$ .

**Lemma IX.13.** *Assume that  $\gcd(n, q) = 1$ . A cyclic code of length  $n$  over  $\mathbb{F}_{q^2}$  with defining set  $Z$  contains its Hermitian dual code if and only if  $Z \cap Z^{-q} = \emptyset$ , where  $Z^{-q} = \{-qz \bmod n \mid z \in Z\}$ .*

*Proof.* Let  $N = \{0, 1, \dots, n-1\}$ . If  $g(x) = \prod_{z \in Z} (x - \alpha^z)$  is the generator polynomial of a cyclic code  $C$ , then  $h^\dagger(x) = \prod_{z \in N \setminus Z} (x - \alpha^{-qz})$  is the generator polynomial of  $C^{\perp_h}$ . Thus,  $C^{\perp_h} \subseteq C$  if and only if  $g(x)$  divides  $h^\dagger(x)$ . The latter condition is equivalent to  $Z \subseteq \{-qz \mid z \in N \setminus Z\}$ , which can also be expressed as  $Z \cap Z^{-q} = \emptyset$ .  $\square$

Now similar to Theorem IX.3 we will derive a sufficient condition for BCH codes that contain their Hermitian duals.

**Theorem IX.14.** *Suppose that  $m = \text{ord}_n(q^2)$ . If the designed distance  $\delta$  satisfies  $2 \leq \delta \leq \delta_{\max}$ , where*

$$\delta_{\max} = \left\lfloor \frac{n}{q^{2m} - 1} (q^{m+[m \text{ even}]} - 1 - (q^2 - 2)[m \text{ even}]) \right\rfloor,$$

then  $\text{BCH}(n, q^2; \delta)^{\perp h} \subseteq \text{BCH}(n, q^2; \delta)$ .

*Proof.* Since  $\text{BCH}(n, q^2; \delta)$  contains  $\text{BCH}(n, q^2; \delta_{\max})$ , it suffices to show that the relation  $\text{BCH}(n, q^2; \delta_{\max})^{\perp h} \subseteq \text{BCH}(n, q^2; \delta_{\max})$  holds.

Seeking a contradiction, we assume that  $\text{BCH}(n, q^2; \delta_{\max})$  does not contain its dual. Let  $Z = C_1 \cup C_2 \cup \dots \cup C_{\delta_{\max}-1}$  be the defining set of  $\text{BCH}(n, q^2; \delta_{\max})$ . By Lemma IX.13,  $Z \cap Z^{-q} \neq \emptyset$ , which means that there exist two elements  $x, y \in \{1, \dots, \delta_{\max} - 1\}$  such that  $y = -xq^{2j+1} \pmod n$  for some  $j \in \{0, 1, \dots, m-1\}$ , where  $m = \text{ord}_n(q)$ . Since  $\gcd(q, n) = 1$  and  $q^{2m} \equiv 1 \pmod n$ , we also have  $y \equiv -xq^{2m-2j-1} \pmod n$ , so we can assume without loss of generality that  $j$  lies in the range  $0 \leq j \leq \lfloor (m-1)/2 \rfloor$ . It follows that

$$\begin{aligned} xq^{2j+1} &\leq (\delta_{\max} - 1)q^{2j+1} \\ &= \frac{nq^{2j+1}}{q^{2m} - 1} (q^{m+[m \text{ even}]} - 1 - (q^2 - 2)[m \text{ even}]) - q^{2j+1} \\ &< n \end{aligned}$$

holds for all  $j$  in the range  $0 \leq j \leq \lfloor (m-1)/2 \rfloor$ .

Since  $1 \leq xq^{2j+1} < n$ , the congruence  $y \equiv -xq^{2j+1} \pmod n$  implies that  $y = n -$

$xq^{2j+1}$ . Therefore,  $y \geq n - (\delta_{\max} - 1)q^{2\lfloor(m-1)/2\rfloor+1}$ , which is equivalent to

$$y \geq n - \frac{nq^{2\lfloor(m-1)/2\rfloor+1}}{q^{2m} - 1} (q^{m+\lfloor m \text{ even} \rfloor} - 1 - (q^2 - 2)\lfloor m \text{ even} \rfloor) + q^{2\lfloor(m-1)/2\rfloor+1}.$$

If  $m$  is odd, this yields

$$\begin{aligned} y &\geq n - \frac{nq^m}{q^{2m} - 1} (q^m - 1) + q^m \\ &= \frac{n}{q^{2m-1}} (q^m - 1) + q^m \geq \delta_{\max}. \end{aligned}$$

Similarly, if  $m$  is even, then

$$\begin{aligned} y &\geq \frac{n}{q^{2m} - 1} (q^{m+1} - q^{m-1} - 1) + q^{m-1} \\ &\geq \delta_{\max}. \end{aligned}$$

Both cases contradict the assumption  $0 \leq y < \delta_{\max}$ . Therefore, we can conclude that  $\text{BCH}(n, q; \delta_{\max})$  contains its Hermitian dual code.  $\square$

Arguing as in Theorem IX.4 we can show that a BCH code must have its designed distance  $\delta = O(q^2 n^{1/2})$  if it contains its Hermitian dual. As the arguments are very similar we illustrate it for a simpler case as shown below:

**Lemma IX.15.** *Let  $C \subseteq \mathbb{F}_{q^2}^n$  be a nonnarrow-sense, nonprimitive BCH code of length  $n \equiv 0 \pmod{q^m + 1}$ , where  $m = \text{ord}_n(q^2)$ . If its design distance  $\delta \geq \delta_{\max} = n/(q^m + 1)$ , then  $C$  cannot contain its Hermitian dual.*

*Proof.* The defining set  $Z = C_b \cup \dots \cup C_{b+\delta-2}$  contains  $\{b, \dots, b + \delta - 2\}$ . If  $\delta > \delta_{\max} = n/(q^m + 1)$ , then there exists an element  $s = \alpha\delta_{\max} \in Z$  for some positive integer  $\alpha$ . Then  $-qs(q^2)^{(m-1)/2} \equiv -\alpha nq^m/(q^m + 1) \equiv \alpha n/(q^m + 1) \equiv s \pmod{n}$ . Therefore,  $Z \cap Z^{-q} \neq \emptyset$ ; hence,  $C$  cannot contain its Hermitian dual code.  $\square$



Finally, we conclude this section on Hermitian duals by proving as in the Euclidean case nonnarrow-sense BCH codes that contain their Hermitian duals cannot have too large design distances.

**Theorem IX.16.** *Let  $C \subseteq \mathbb{F}_{q^2}^n$  be a primitive (not necessarily narrow-sense) BCH code of length  $n = q^{2m} - 1$ ,  $m = \text{ord}_n(q)$ , and designed distance  $\delta$ . If  $\delta$  exceeds*

$$\delta_{\max} = \begin{cases} q^m - 1 & \text{if } m \text{ is odd,} \\ 2(q^{m+1} - q^2 + 1) & \text{if } m \neq 2 \text{ is even,} \end{cases}$$

then  $C$  cannot contain its Hermitian dual code.

*Proof.* Suppose that the defining set of  $C$  is given by  $Z = C_b \cup \cdots \cup C_{b+\delta-2}$ , where  $C_x = \{xq^{2j} \bmod n \mid j \in \mathbb{Z}\}$ , and that  $\delta > \delta_{\max}$ . Seeking a contradiction, we assume that  $C^{\perp h} \subseteq C$ , which means that  $Z \cap Z^{-q} = \emptyset$ . It follows that  $0 \notin Z$ , for otherwise  $0 \in Z \cap Z^{-q}$ ; therefore,  $b \geq 1$  and  $b + \delta - 2 < n$ .

If  $m$  is odd, then there exists an integer  $\alpha$  such that  $b \leq \alpha\delta_{\max} \leq b + \delta - 2$ . We have  $-q\alpha\delta_{\max}q^{m-1} \equiv \alpha(1 - q^m)q^m \equiv \alpha(q^m - 1) \equiv \alpha\delta_{\max} \pmod{n}$ ; thus,  $\alpha\delta_{\max} \in Z \cap Z^{-q} \neq \emptyset$ .

If  $m > 2$  is even and  $\delta > \delta_{\max} = 2q^{m+1} - 2q^2 + 2$ , then there exists an integer  $\alpha$  such that two multiples of  $\delta' = \delta_{\max}/2$  are contained in the range  $b \leq (\alpha - 1)\delta' < \alpha\delta' \leq b + \delta - 2$ . Since  $b \geq 1$  and  $\alpha\delta' < n$ , it follows that  $2 \leq \alpha \leq q^{m-1}$  (which holds only if  $m > 2$ ).

Clearly  $s = \alpha\delta' \in Z$ . Let  $s' \equiv -qsq^{m-2} \pmod{n}$ , so  $s' \in Z^{-q}$ , then  $1 \leq s' = \alpha(q^{m+1} - q^{m-1} - 1) \leq s$  for  $m > 2$ .

Suppose that  $b \leq s'$ . Then  $s' \in Z$ , which implies  $Z \cap Z^{-q} \neq \emptyset$ .

Suppose that  $s' < b$ . Since  $b \leq (\alpha - 1)\delta'$ , we obtain the inequality  $s' < (\alpha - 1)\delta'$ ; solving for  $\alpha$  shows that  $\alpha \geq q^2$ ; thus,  $q^2 \leq \alpha \leq q^{m-1}$ . Let  $t' = (\alpha - 1)(q^{m+1} - 1) + q^{(m-1)/2} - 1$ ; it is easy to check that  $t'$  is in the range  $(\alpha - 1)\delta' \leq t' \leq \alpha\delta'$  when  $\alpha \geq q^2$ ; thus,  $t' \in Z$ . Further, let  $t = s - (\alpha - q^2 + 1)$ ; since  $t \geq s - \delta'$ , we have  $t \in Z$  as well. Since  $-qtq^{m-2} \equiv t' \pmod{n}$ , we can conclude that  $t' \in Z \cap Z^{-q} \neq \emptyset$ . Hence, by

Lemma IX.13 we conclude that  $C$  cannot contain its Hermitian dual if its design distance exceeds  $\delta_{\max}$   $\square$

#### D. Families of Quantum BCH Codes

In this section we shall study the construction of (nonbinary) quantum BCH codes. Calderbank, Shor, Rains and Sloane outlined the construction of binary quantum BCH codes in [35]. Grassl, Beth and Pellizari developed the theory further by formulating a nice condition for determining which BCH codes can be used for constructing quantum codes [68,70]. The dimension and the purity of the quantum codes constructed were determined by numerical computations. Steane simplified it further for the special case of binary narrow-sense primitive BCH codes [146] and gave a very simple criterion based on the design distance alone. Very little was done with respect to the nonprimitive and nonbinary quantum BCH codes.

In this section we show how the results we have developed in the previous sections help us to generalize the previous work on quantum codes and give very simple conditions based on design distance alone. Further, we give precisely the dimension and tighten results on the purity of the quantum codes. The reader can refer to Chapters III and IV for constructions on stabilizer codes.

**Theorem IX.17.** *Let  $m = \text{ord}_n(q) \geq 2$ , where  $q$  is a power of a prime and  $\delta_1, \delta_2$  are integers such that  $2 \leq \delta_1 < \delta_2 \leq \delta_{\max}$  where*

$$\delta_{\max} = \frac{n}{q^m - 1} (q^{\lceil m/2 \rceil} - 1 - (q - 2)[m \text{ odd}]),$$

*then there exists a quantum code with parameters*

$$[[n, m(\delta_2 - \delta_1 - \lfloor (\delta_2 - 1)/q \rfloor + \lfloor (\delta_1 - 1)/q \rfloor), \geq \delta_1]]_q$$

pure to  $\delta_2$ .

*Proof.* By Theorem IX.10, there exist BCH codes  $\text{BCH}(n, q; \delta_i)$  with the parameters  $[n, n - m(\delta_i - 1) + m\lfloor(\delta_i - 1)/q\rfloor, \geq \delta_i]_q$  for  $i \in \{1, 2\}$ . Further,  $\text{BCH}(n, q; \delta_2) \subset \text{BCH}(n, q; \delta_1)$ . Hence by the CSS construction there exists a quantum code with the parameters

$$[[n, m(\delta_2 - \delta_1 - \lfloor(\delta_2 - 1)/q\rfloor + \lfloor(\delta_1 - 1)/q\rfloor), \geq \delta_1]]_q.$$

The purity follows due to the fact that  $\delta_2 > \delta_1$  and Lemma IX.12 by which the dual distance of either BCH code is  $\geq \delta_{\max} + 1 > \delta_2$ .  $\square$

When the BCH codes contain their duals, then we can derive the following codes. Note that these cannot be obtained as a consequence of Theorem IX.17.

**Theorem IX.18.** *Let  $m = \text{ord}_n(q)$  where  $q$  is a power of a prime and  $2 \leq \delta \leq \delta_{\max}$ , with*

$$\delta_{\max} = \frac{n}{q^m - 1} (q^{\lceil m/2 \rceil} - 1 - (q - 2)\lceil m \text{ odd} \rceil),$$

*then there exists a quantum code with parameters*

$$[[n, n - 2m\lceil(\delta - 1)(1 - 1/q)\rceil, \geq \delta]]_q$$

*pure to  $\delta_{\max} + 1$*

*Proof.* Theorems IX.3 and IX.10 imply that there exists a classical BCH code with parameters  $[n, n - m\lceil(\delta - 1)(1 - 1/q)\rceil, \geq \delta]_q$  which contains its dual code. By Corollary III.21 an  $[n, k, d]_q$  code that contains its dual code implies the existence of the quantum code with parameters  $[[n, 2k - n, \geq d]]_q$ . The purity follows from Lemma IX.12 by which the dual distance  $\geq \delta_{\max} + 1 > \delta$ .  $\square$

Before we can construct quantum codes via the Hermitian construction, we will need the following lemma.

**Lemma IX.19.** *Suppose that  $C$  is a primitive, narrow-sense BCH code of length  $n = q^{2m} - 1$  over  $\mathbb{F}_{q^2}$  with designed distance  $2 \leq \delta \leq \delta_{\max} = \lfloor n(q^m - 1)/(q^{2m} - 1) \rfloor$ , then the dual distance  $d^\perp \geq \delta_{\max} + 1$ .*

*Proof.* The proof is analogous to the one of Lemma IX.12; just keep in mind that the defining set  $Z_\delta$  is invariant under multiplication by  $q^2$  modulo  $n$ .  $\square$

**Theorem IX.20.** *Let  $m = \text{ord}_n(q^2) \geq 2$  where  $q$  is a power of a prime and  $2 \leq \delta \leq \delta_{\max} = \lfloor n(q^m - 1)/(q^{2m} - 1) \rfloor$ , then there exists a quantum code with parameters*

$$[[n, n - 2m \lceil (\delta - 1)(1 - 1/q^2) \rceil, \geq \delta]]_q$$

*that is pure up to  $\delta_{\max} + 1$ .*

*Proof.* It follows from Theorems IX.10 and IX.14 that there exists a primitive, narrow-sense  $[n, n - 1 - m \lceil (\delta - 1)(1 - 1/q^2) \rceil, \geq \delta]_{q^2}$  BCH code that contains its Hermitian dual code. By Corollary III.19 a classical  $[n, k, d]_{q^2}$  code that contains its Hermitian dual code implies the existence of an  $[[n, 2k - n, \geq d]]_q$  quantum code. By Lemma IX.19 the quantum code is pure to  $\delta_{\max} + 1$ .  $\square$

In the above theorem, quantum codes can also be constructed when the design distance exceeds the given value of  $\delta_{\max}$ , however we do not have exact knowledge of the dimension in all those cases, hence we have not included them to keep the theorem precise.

These are not the only possible families of quantum codes that can be derived from BCH codes. As pointed out in [68], we can expand BCH codes over  $\mathbb{F}_{q^l}$  to get codes over  $\mathbb{F}_q$ . Once again the dimension and duality results of BCH codes makes it very easy to specify such codes. We will just give one example in the Euclidean case. Similar results can be derived for the Hermitian case.

**Theorem IX.21.** Let  $m = \text{ord}_n(q^l)$  where  $q$  is a power of a prime and  $2 \leq \delta \leq \delta_{\max}$ , with

$$\delta_{\max} = \frac{n}{q^{lm} - 1} (q^{l\lceil m/2 \rceil} - 1 - (q^l - 2)[m \text{ odd}]),$$

then there exists a quantum code with parameters

$$[[ln, ln - 2lm\lceil(\delta - 1)(1 - 1/q^l)\rceil, \geq \delta]]_q$$

that is pure up to  $\delta$ .

*Proof.* By Theorem IX.18 there exists a quantum BCH code with parameters  $[[n, n - 2m\lceil(\delta - 1)(1 - 1/q^l)\rceil, \geq \delta]]_{q^l}$ . An  $[[n, k, d]]_{q^l}$  quantum code implies the existence of the quantum code with parameters  $[[ln, lk, \geq d]]_q$  by Lemma III.41 and the code follows.  $\square$

## E. Conclusions

In this chapter we have identified the classes of BCH codes that contain their Euclidean (Hermitian) duals by a careful analysis of the cyclotomic cosets. In the process we have been able to shed more light on the structure of dual containing BCH codes. We were able to derive a formula for the dimension of narrow-sense BCH codes when the designed distance is small. These results allowed us to identify easily which classical BCH codes can be used for construct quantum codes. Further, the parameters of these quantum codes are easily specified in terms of the design distance.

## REFERENCES

- [1] D. Aharonov and M. Ben-Or, “Fault-tolerant quantum computation with constant error,” in *Proc. of the 29th Annual ACM Symposium on Theory of Computation (STOC)*. New York: ACM, 1997, pp. 176–188.
- [2] P. Aliferis and J. Preskill, “Fault-tolerant quantum computation against biased noise,” 2007, arXiv.org:quant-ph/0710.1301.
- [3] S. A. Aly, M. Grassl, M. Rötteler, A. Klappenecker, and P. K. Sarvepalli, “Quantum convolutional BCH codes,” in *Proc. 10th Canadian Workshop on Inform. Theory, Edmonton, Canada, 2007*, pp. 180–183.
- [4] S. A. Aly, A. Klappenecker, and P. K. Sarvepalli, “Primitive quantum BCH codes over finite fields,” in *Proc. 2006 IEEE Intl. Symposium on Information Theory, Seattle, 2006*, pp. 1105–1108.
- [5] —, “Remarkable degenerate quantum stabilizer codes derived from Duadic codes,” in *Proc. 2006 IEEE Intl. Symposium on Information Theory, Seattle, 2006*, pp. 1114–1118.
- [6] —, “Subsystem codes,” in *Forty-fourth Annual Allerton Conference on Communication, Control, and Computing, Monticello, Illinois, 2006*, pp. 528–535.
- [7] —, “Duadic group algebra codes,” in *Proc. 2007 IEEE Intl. Symposium on Information Theory, Nice, France, 2007*, pp. 2096–2100.
- [8] —, “On quantum and classical BCH codes,” *IEEE Trans. on Information Theory*, vol. 53, no. 3, pp. 1183–1188, 2007.

- [9] —, “Quantum convolutional codes from generalized Reed-Solomon codes,” in *Proc. 2007 IEEE Intl. Symposium on Information Theory, Nice, France, 2007*, pp. 821–825.
- [10] V. Arvind and K. Parthasarathy, “A family of quantum stabilizer codes based on the Weyl commutation relations over a finite field,” in *A Tribute to C. S. Seshadri (Chennai, 2002)*, ser. Trends Math. Boston: Birkhäuser, 2003, pp. 133–153.
- [11] A. Ashikhmin and E. Knill, “Nonbinary quantum stabilizer codes,” *IEEE Trans. Inform. Theory*, vol. 47, no. 7, pp. 3065–3072, 2001.
- [12] A. Ashikhmin and S. Litsyn, “Upper bounds on the size of quantum codes,” *IEEE Trans. Inform. Theory*, vol. 45, no. 4, pp. 1206–1215, 1999.
- [13] —, “Foundations of quantum error correction,” in *Recent Trends in Coding Theory and Its Applications*, W. C. W. Li, Ed. Providence, Rhode Island: American Mathematical Society and International Press, 2007, pp. 151–185.
- [14] A. Ashikhmin, A. Barg, E. Knill, and S. Litsyn, “Quantum error detection I: Statement of the problem,” *IEEE Trans. on Information Theory*, vol. 46, no. 3, pp. 778–788, 2000.
- [15] —, “Quantum error detection II: Bounds,” *IEEE Trans. on Information Theory*, vol. 46, no. 3, pp. 789–800, 2000.
- [16] A. Assmus, Jr. and J. Key, *Designs and their codes*. Cambridge: Cambridge University Press, 1992.
- [17] E. Assmus, Jr. and J. Key, “Polynomial codes and finite geometries,” in *Handbook of Coding Theory*, V. Pless and W. Huffman, Eds., vol. II. Amsterdam: Elsevier, 1998, pp. 1269–1343.

- [18] D. Bacon, “Operator quantum error correcting subsystems for self-correcting quantum memories,” *Phys. Rev. A*, vol. 73, no. 012340, 2006.
- [19] D. Bacon and A. Casaccino, “Quantum error correcting subsystem codes from two classical linear codes,” in *Forty-fourth Annual Allerton Conference on Communication, Control, and Computing, Monticello, Illinois, 2006*, pp. 520–527.
- [20] A. Barg, S. Guritman, and J. Simonis, “Strengthening the Gilbert-Varshamov bound,” *Linear Algebra and its Application*, vol. 307, pp. 119–129, 2000.
- [21] H. Barnum, “Quantum message authentication codes,” 2001, quant-ph/0103123 version 2.
- [22] H. Barnum, C. Crepeau, D. Gottesman, A. Smith, and A. Tapp, “Authentication of quantum messages,” in *Proc. 43rd Annual IEEE Symposium on the Foundations of Computer Science (FOCS '02)*. IEEE Press, 2002, pp. 449–458.
- [23] S. Bartlett, H. de Guise, and B. Sanders, “Quantum encodings in spin systems and harmonic oscillators,” *Physical Review A*, vol. 65, no. 052316, 2002.
- [24] E. Berlekamp, *Algebraic Coding Theory*. New York: McGraw-Hill, 1968.
- [25] E. Bernstein and U. Vazirani, “Quantum complexity theory,” in *Proc. 25th Annual ACM Symposium on the Theory of Computing (STOC '93)*. New York: ACM, 1993, pp. 11–20.
- [26] T. Beth and M. Grassl, “The quantum Hamming and hexacodes,” *Fortschr. Phys.*, vol. 46, no. 4-5, pp. 459–491, 1998.
- [27] A. Betten, H. Friepertinger, A. Kerber, A. Wassermann, and K.-H. Zimmermann, *Codierungstheorie – Konstruktion und Anwendung linearer Codes*. Berlin: Springer-Verlag, 1998.



- [28] J. Bierbrauer and Y. Edel, “Quantum twisted codes,” *J. Comb. Designs*, vol. 8, pp. 174–188, 2000.
- [29] G. Birkhoff, *Lattice Theory*, 2nd ed. Providence, Rhode Island: AMS, 1961.
- [30] C. A. Bishop and M. S. Byrd, “Methods for producing decoherence-free states and noiseless subsystems using photonic qutrits,” 2007, eprint: quant-ph/0709.0021.
- [31] R. E. Blahut, *Algebraic Codes for Data Transmission*. Cambridge: University Press, 2003.
- [32] R. C. Bose and D. K. Ray-Chaudhuri, “Further results on error correcting binary group codes,” *Information and Control*, vol. 3, pp. 279–290, 1960.
- [33] —, “On a class of error correcting binary group codes,” *Information and Control*, vol. 3, pp. 68–79, 1960.
- [34] A. Calderbank, E. Rains, P. Shor, and N. Sloane, “Quantum error correction and orthogonal geometry,” *Phys. Rev. Lett.*, vol. 76, pp. 405–409, 1997.
- [35] —, “Quantum error correction via codes over  $GF(4)$ ,” *IEEE Trans. Inform. Theory*, vol. 44, pp. 1369–1387, 1998.
- [36] A. Calderbank and P. Shor, “Good quantum error-correcting codes exist,” *Phys. Rev. A*, vol. 54, pp. 1098–1105, 1996.
- [37] T. Camara, H. Ollivier, and J.-P. Tillich, “Constructions and performance of classes of quantum LDPC codes,” 2005, eprint: quant-ph/0502086.
- [38] P. Charpin, “Open problems on cyclic codes,” in *Handbook of Coding Theory*, V. Pless and C. Huffman, Eds. Amsterdam: Elsevier, 1998, pp. 963–1063.

- [39] H. Chau, “Correcting quantum errors in higher spin systems,” *Phys. Rev. A*, vol. 55, pp. R839–R841, 1997.
- [40] —, “Five quantum register error correction code for higher spin systems,” *Phys. Rev. A*, vol. 56, pp. R1–R4, 1997.
- [41] R. Cleve, “Quantum stabilizer codes and classical linear codes,” *Phys. Rev. A*, vol. 55, no. 6, pp. 4054–4059, 1997.
- [42] R. Cleve and D. Gottesman, “Efficient computations of encodings for quantum error correction,” *Phys. Rev. A*, vol. 56, no. 1, pp. 76–82, 1997.
- [43] G. Cohen, S. Encheva, and S. Litsyn, “On binary constructions of quantum codes,” *IEEE Trans. Inform. Theory*, vol. 45, no. 7, pp. 2495–2498, 1999.
- [44] L. Danielsen and M. Parker, “On the classification of all self-dual additive codes over GF(4) of length up to 12,” 2005, arXiv:math.CO/0504522.
- [45] C. Dankert, R. Cleve, J. Emerson, and E. Livine, “Exact and approximate unitary 2-designs: constructions and applications,” 2006, arXiv.org:quant-ph/0606161.
- [46] G. M. D’Ariano, P. Mataloni, and M. F. Sacchi, “Generating qudits with  $d = 3, 4$  encoded on two-photon states,” 2005, eprint: quant-ph/0503227v2.
- [47] P. Delsarte, “Bounds for unrestricted codes by linear programming,” *Philips Res. Reports*, vol. 27, pp. 272–289, 1972.
- [48] —, “On subfield subcodes of Reed-Solomon codes,” *IEEE Trans. Inform. Theory*, vol. 21, no. 5, pp. 575–576, 1975.
- [49] A. Ekert and C. Macchiavello, “Error correction in quantum communication,” *Phys. Rev. Lett.*, vol. 76, pp. 2585–2588, 1996.

- [50] Emerson, J. and Silva, M. and Ryan, C. and Laforest, M. and Baugh, J. and Cory, D. G. and Laflamme, R., “Symmetrized characterization of noise quantum processes,” *Science*, vol. 317, pp. 1893–1896, 2007.
- [51] B. P. L. *et al.*, “Quantum computing using shortcuts through higher dimensions,” 2008, eprint: quant-ph/0804.0272.
- [52] Z. W. E. Evans, A. M. Stephens, J. H. Cole, and L. C. L. Hollenberg, “Error correction optimisation in the presence of X/Z asymmetry,” 2007, arXiv.org:quant-ph/0709.3875.
- [53] K. Feng, “Quantum codes  $[[6, 2, 3]]_p$ ,  $[[7, 3, 3]]_p$  ( $p \geq 3$ ) exist,” *IEEE Trans. Inform. Theory*, vol. 48, no. 8, pp. 2384–2391, 2002.
- [54] —, “Quantum error-correcting codes,” in *Coding Theory and Cryptology*. Singapore: World Scientific, 2002, pp. 91–142.
- [55] K. Feng and Z. Ma, “A finite Gilbert-Varshamov bound for pure stabilizer quantum codes,” *IEEE Trans. Inform. Theory*, vol. 50, no. 12, pp. 3323–3325, 2004.
- [56] M. Freedman and D. Meyer, “Projective plane and planar quantum codes,” *Found. Comput. Math.*, vol. 1, no. 3, pp. 325–332, 2001.
- [57] D. Gorenstein, R. Lyons, and R. Solomon, *The Classification of the Finite Simple Groups, Number 2*, ser. Mathematical Surveys and Monographs, vol. 40. Providence, Rhode Island: AMS, 1994.
- [58] D. Gorenstein and N. Zierler, “A class of error-correcting codes in  $p^m$  symbols,” *J. Soc. Indust. Appl. Math.*, vol. 9, pp. 207–214, 1961.
- [59] D. Gottesman, “A class of quantum error-correcting codes saturating the quantum Hamming bound,” *Phys. Rev. A*, vol. 54, pp. 1862–1868, 1996.

- [60] —, “Pasting quantum codes,” 1996, eprint: quant-ph/9607027.
- [61] —, “Stabilizer codes and quantum error correction,” 1997, Caltech Ph. D. Thesis, eprint: quant-ph/9705052.
- [62] —, “Fault-tolerant quantum computation with higher-dimensional systems,” *Chaos, Solitons, Fractals*, vol. 10, no. 10, pp. 1749–1758, 1999.
- [63] —, “An introduction to quantum error correction,” in *Quantum Computation: A Grand Mathematical Challenge for the Twenty-First Century and the Millennium*, S. J. Lomonaco, Jr., Ed. Rhode Island: American Mathematical Society, 2002, pp. 221–235, eprint: quant-ph/0004072.
- [64] —, “Quantum error correction and fault-tolerance,” 2005, eprint: quant-ph/0507174.
- [65] D. Gottesman, K. Alexei, and A. Preskill, “Encoding a qubit in an oscillator,” *Physical Review A*, vol. 64, no. 012310, 2001.
- [66] M. Grassl, “Algorithmic aspects of quantum error-correcting codes,” in *The Mathematics of Quantum Computation*, R. Brylinski and G. Chen, Eds. Boca Raton: Chapman & Hall/CRC Press, 2002, pp. 223–252.
- [67] —, “Encoding circuits for quantum error-correcting codes,” 2003, available at <http://iaks-www.ira.uka.de/grassl/QECC/circuits/index.html>.
- [68] M. Grassl and T. Beth, “Quantum BCH codes,” in *Proc. X. Int’l. Symp. Theoretical Electrical Engineering*, Magdeburg, 1999, pp. 207–212.
- [69] —, “Cyclic quantum error-correcting codes and quantum shift registers,” *Proc. Royal Soc. London Series A*, vol. 456, no. 2003, pp. 2689–2706, 2000.

- [70] M. Grassl, T. Beth, and T. Pellizzari, “Codes for the quantum erasure channel,” *Phys. Rev. Lett. A*, vol. 56, no. 1, pp. 33–38, 1997.
- [71] M. Grassl, T. Beth, and M. Rötteler, “On optimal quantum codes,” *Internat. J. Quantum Information*, vol. 2, no. 1, pp. 757–775, 2004.
- [72] M. Grassl, W. Geiselmann, and T. Beth, “Quantum Reed-Solomon codes,” in *Applied Algebra, Algebraic Algorithms and Error-correcting Codes (Honolulu, HI, 1999)*, ser. Lecture Notes in Comput. Sci., vol. 1719. Berlin: Springer, 1999, pp. 231–244.
- [73] M. Grassl, M. Rötteler, and T. Beth, “Efficient quantum circuits for non-qubit quantum error-correcting codes,” *Internat. J. Found. Comput. Sci.*, vol. 14, no. 5, pp. 757–775, 2003.
- [74] L. Grove, *Classical Groups and Geometric Algebra*. Providence, Rhode Island: American Mathematical Society, 2001.
- [75] A. Hocquenghem, “Codes correcteurs d’erreurs,” *Chiffres*, vol. 2, pp. 147–156, 1959.
- [76] W. C. Huffman and V. Pless, *Fundamentals of Error-Correcting Codes*. Cambridge: University Press, 2003.
- [77] L. Ioffe and M. Mézard, “Asymmetric quantum error-correcting codes,” *Phys. Rev. Lett. A*, vol. 75, p. 032345, 2007.
- [78] I. Isaacs, *Character Theory of Finite Groups*. New York: Dover, 1994.
- [79] T. Kasami and S. Lin, “On majority-logic decoding for duals of primitive polynomial codes,” *IEEE Trans. Inform. Theory*, vol. 17, no. 3, pp. 322–331, 1971.

- [80] T. Kasami, S. Lin, and W. W. Peterson, “New generalizations of the Reed-Muller codes Part I : Primitive codes,” *IEEE Trans. Inform. Theory*, vol. 14, no. 2, pp. 189–199, 1968.
- [81] —, “Polynomial codes,” *IEEE Trans. Inform. Theory*, vol. 14, no. 6, pp. 807–814, 1968.
- [82] J. Kempe, “Approaches to quantum error correction,” 2006, quant-ph/0612185.
- [83] A. Ketkar, A. Klappenecker, S. Kumar, and P. K. Sarvepalli, “Nonbinary stabilizer codes over finite fields,” *IEEE Trans. Inform. Theory*, vol. 52, no. 11, pp. 4892–4914, 2006.
- [84] J.-L. Kim, “New quantum-error-correcting codes from Hermitian self-orthogonal codes over  $GF(4)$ ,” in *Proc. of the Sixth Intl. Conference on Finite Fields and Applications, Oaxaca, Mexico, May 21-25*. Springer-Verlag, 2002, pp. 209–213.
- [85] J.-L. Kim and V. Pless, “Designs in additive codes over  $GF(4)$ ,” *Designs, Codes and Cryptography*, vol. 30, pp. 187–199, 2003.
- [86] J.-L. Kim and J. Walker, “Nonbinary quantum error-correcting codes from algebraic curves,” 2004, submitted to a special issue of Com<sup>2</sup>MaC Conference on Association Schemes, Codes and Designs in Discrete Math.
- [87] A. Kitaev, “Quantum computations: algorithms and error correction,” *Russian Math. Surveys*, vol. 52, no. 6, pp. 1191–1249, 1997.
- [88] A. Klappenecker and M. Rötteler, “Beyond stabilizer codes II: Clifford codes,” *IEEE Transaction on Information Theory*, vol. 48, no. 8, pp. 2396–2399, 2002.

- [89] A. Klappenecker and M. Rötteler, “Clifford codes,” in *Mathematics of Quantum Computation*, R. Brylinski and G. Chen, Eds. Boca Raton: Chapman & Hall/CRC Press, 2002, pp. 253–273.
- [90] A. Klappenecker and P. K. Sarvepalli, “Clifford code constructions of operator quantum error-correcting codes,” 2006, accepted subjected to revision, *IEEE Trans. Inform. Theory*.
- [91] —, “On subsystem codes beating the quantum Hamming or Singleton bound,” *Proc. Roy. Soc. London A*, vol. 463, pp. 2887–2905, 2007.
- [92] E. Knill, “Group representations, error bases and quantum codes,” 1996, Los Alamos National Laboratory Report LAUR-96-2807.
- [93] —, “Non-binary unitary error bases and quantum codes,” 1996, Los Alamos National Laboratory Report LAUR-96-2717.
- [94] —, “On protected realizations of quantum information,” 2006, eprint: quant-ph/0603252.
- [95] E. Knill and R. Laflamme, “A theory of quantum error-correcting codes,” *Physical Review A*, vol. 55, no. 2, pp. 900–911, 1997.
- [96] E. Knill, R. Laflamme, A. Ashikhmin, H. Barnum, L. Viola, and W. H. Zurek, “Introduction to quantum error correction,” 2002, quant-ph/0207170.
- [97] S. Konyagin and I. Shparlinksi, *Character Sums with Exponential Functions and their Applications*. Cambridge: Cambridge University Press, 1999.
- [98] Y. Kou, S. Lin, and M. P. C. Fossorier, “Low-density parity check codes based on finite geometries: A rediscovery and new results,” *IEEE Trans. Inform. Theory*, vol. 47, no. 7, pp. 2711–2736, 2001.

- [99] D. W. Kribs, R. Laflamme, and D. Poulin, “Unified and generalized approach to quantum error correction,” *Phys. Rev. Lett.*, vol. 94, no. 180501, 2005.
- [100] D. W. Kribs, R. Laflamme, D. Poulin, and M. Lesosky, “Operator quantum error correction,” 2005, eprint: quant-ph/0504189.
- [101] V. Levenshtein, “Krawtchouk polynomials and universal bounds for codes and designs in Hamming spaces,” *IEEE Trans. Inform. Theory*, vol. 41, no. 5, pp. 1303–1321, 1995.
- [102] R. Li and X. Li, “Binary construction of quantum codes of minimum distance three and four,” *IEEE Trans. Inform. Theory*, vol. 50, no. 6, pp. 1331–1336, 2004.
- [103] R. Lidl and H. Niederreiter, *Finite Fields*, 2nd ed. Cambridge: Cambridge University Press, 1997.
- [104] S. Lin and D. J. Costello, Jr., *Error Control Coding*, 2nd ed. Upper Saddle River, New Jersey: Prentice Hall, 2004.
- [105] D. J. C. MacKay, G. Mitchison, and P. L. McFadden, “Sparse-graph codes for quantum error correction,” *IEEE Trans. Inform. Theory*, vol. 50, no. 10, pp. 2315–2330, 2004.
- [106] F. MacWilliams, “A theorem on the distribution of weights in a systematic code,” *Bell Syst. Tech. J.*, vol. 42, pp. 79–94, 1963.
- [107] F. MacWilliams and N. Sloane, *The Theory of Error-Correcting Codes*. Amsterdam: North-Holland, 1977.
- [108] W. Martin, “A physics-free introduction to quantum error correcting codes,” *Util. Math.*, vol. 65, 2004.



- [109] R. Matsumoto and T. Uyematsu, “Constructing quantum error correcting codes for  $p^m$ -state systems from classical error correcting codes,” *IEICE Trans. Fundamentals*, vol. E83-A, no. 10, pp. 1878–1883, 2000.
- [110] R. McEliece, E. Rodemich, j. H. Rumsey, and L. Welch, “New upper bounds on the rate of a code via the Delsarte-MacWilliams inequalities,” *IEEE Trans. Inform. Theory*, vol. 23, no. 2, p. 157, 1977.
- [111] O. Moreno and C. J. Moreno, “The Macwilliams-Sloane conjecture on the tightness of the Carlitz-Uchiyama bound and the weights of the duals of BCH codes,” *IEEE Trans. Inform. Theory*, vol. 40, no. 2, pp. 1894–1907, 1994.
- [112] O. Moreno, J. P. Pederson, and D. Polemi, “An improved Serre bound for elementary abelian extensions of  $\mathbf{F}_q(x)$  and the generalized Hamming weights of duals of BCH codes,” *IEEE Trans. Inform. Theory*, vol. 44, no. 3, pp. 1291–1293, 1998.
- [113] E. V. Moreva, G. A. Maslennikov, S. S. Straupe, and S. P. Kilik, “Realization of four-state qudits using biphotons,” 2006, eprint: quant-ph/0601091v2.
- [114] M. A. Nielsen and I. L. Chuang, *Quantum Computation and Quantum Information*. Cambridge, UK: Cambridge University Press, 2000.
- [115] M. A. Nielsen and D. Poulin, “Algebraic and information-theoretic conditions for operator quantum error-correction,” 2005, eprint: quant-ph/0506069.
- [116] O. Ore, “Galois connexions,” *Trans. Am. Math. Soc.*, vol. 55, pp. 493–513, 1944.
- [117] R. Pellikaan and X.-W. Wu, “List decoding of  $q$ -ary Reed-Muller codes,” *IEEE Trans. Inform. Theory*, vol. 50, no. 4, pp. 679–682, 2004.
- [118] W. Peterson and W. Weldon Jr., *Error-correcting Codes*. Cambridge: MIT Press, 1972.

- [119] M. S. Postol, “A proposed quantum low density parity check code,” 2001, eprint: quant-ph/0108131.
- [120] D. Poulin, “Stabilizer formalism for operator quantum error correction,” *Phys. Rev. Lett.*, vol. 95, no. 230504, 2005.
- [121] —, “Operator quantum error correction: An overview,” 2006, available at <http://www.ist.caltech.edu/~dpoulin/publications/OQEC.pdf>.
- [122] D. Poulin and Y. Chung, “On the iterative decoding of sparse quantum codes,” 2008, eprint: quant-ph/0801.1241.
- [123] J. Preskill, “Quantum computation,” 2006, <http://www.theory.caltech.edu/people/preskill/ph229/>.
- [124] E. Rains, “Quantum weight enumerators,” *IEEE Trans. Inform. Theory*, vol. 44, no. 4, pp. 1388–1394, 1998.
- [125] —, “Monotonicity of the quantum linear programming bound,” *IEEE Trans. Inform. Theory*, vol. 45, no. 7, pp. 2489–2492, 1999.
- [126] —, “Nonbinary quantum codes,” *IEEE Trans. Inform. Theory*, vol. 45, pp. 1827–1832, 1999.
- [127] —, “Quantum codes of minimum distance two,” *IEEE Trans. Inform. Theory*, vol. 45, no. 1, pp. 266–271, 1999.
- [128] —, “Quantum shadow enumerators,” *IEEE Trans. Inform. Theory*, vol. 45, no. 7, pp. 2361–2366, 1999.
- [129] —, “Polynomial invariants of quantum codes,” *IEEE Trans. Inform. Theory*, vol. 46, no. 1, pp. 54–59, 2000.

- [130] T. C. Ralph, K. J. Resch, and A. Gilchrist, “Efficient Toffoli gates using qudits,” *Phys. Rev. A*, vol. 75, p. 022313, 2007.
- [131] D. Robinson, *A Course in the Theory of Groups*, 2nd ed. New York: Springer, 1995.
- [132] M. Rötteler, M. Grassl, and T. Beth, “On quantum MDS codes,” in *Proc. 2004 IEEE Intl. Symposium on Information Theory, Chicago*, 2004, p. 355.
- [133] P. K. Sarvepalli and A. Klappenecker, “Nonbinary quantum codes from Hermitian curves,” in *Applied Algebra, Algebraic Algorithms, and Error Correcting Codes – 16th International Symposium, AAECC-16, Las Vegas, Nevada, Feb 20-24, 2006, Proceedings*, ser. LNCS, M. Fossorier and et al., Eds. Springer-Verlag, pp. 136–143.
- [134] ———, “Nonbinary quantum Reed-Muller codes,” in *IEEE International Symposium on Information Theory, Adelaide, Australia*, 2005, pp. 1023–1027.
- [135] ———, “Encoding subsystem codes,” 2008, eprint: arXiv:0806.4954.
- [136] P. K. Sarvepalli, M. Rötteler, and A. Klappenecker, “Asymmetric quantum LDPC codes,” in *Proc. 2008 IEEE Intl. Symposium on Information Theory, Toronto, Canada*, 2008, pp. 305–309.
- [137] D. Schlingemann, “Stabilizer codes can be realized as graph codes,” *Quantum Inf. Comput.*, vol. 2, no. 4, pp. 307–323, 2002.
- [138] D. Schlingemann and R. Werner, “Quantum error-correcting codes associated with graphs,” 2000, eprint: quant-ph/00012111.
- [139] G. Seroussi and A. Lempel, “Factorization of symmetric matrices and trace-orthogonal bases in finite fields,” *SIAM J. Computing*, vol. 9, pp. 758–767, 1980.

- [140] P. Shor, “Fault-tolerant quantum computation,” in *Proceedings of the 37th Symposium on the Foundations of Computer Science*. Los Alamitos: IEEE Computer Society Press, 1996, pp. 56–65.
- [141] P. Shor and R. Laflamme, “Quantum analog of the MacWilliams identities in classical coding theory,” *Phys. Rev. Lett.*, vol. 78, pp. 1600–1603, 1997.
- [142] P. W. Shor, “Scheme for reducing decoherence in quantum memory,” *Phys. Rev. A*, vol. 2, pp. 2493–2496, 1995.
- [143] I. Shparlinski, “On the dimension of BCH codes,” *Problemy Peredachi Informatsii*, vol. 25, no. 1, pp. 77–80, 1988, (In Russian).
- [144] A. Steane, “Multiple-particle interference and quantum error correction,” *Proc. Roy. Soc. London A*, vol. 452, pp. 2551–2577, 1996.
- [145] —, “Simple quantum error correcting codes,” *Phys. Rev. Lett.*, vol. 77, pp. 793–797, 1996.
- [146] —, “Enlargement of Calderbank-Shor-Steane quantum codes,” *IEEE Trans. Inform. Theory*, vol. 45, no. 7, pp. 2492–2495, 1999.
- [147] —, “Quantum Reed-Muller codes,” *IEEE Trans. Inform. Theory*, vol. 45, no. 5, pp. 1701–1703, 1999.
- [148] A. M. Stephens, Z. W. E. Evans, S. J. Devitt, and L. C. L. Hollenberg, “Universal quantum computation under asymmetric quantum error correction,” 2007, [arXiv.org:quant-ph/0708.3969](https://arxiv.org/abs/quant-ph/0708.3969).
- [149] H. Stichtenoth and C. Voß, “Generalized Hamming weights of trace codes,” *IEEE Trans. Inform. Theory*, vol. 40, no. 2, pp. 554–558, 1994.

- [150] H. Tang, S. Lin, and K. A. S. Abdel-Ghaffar, "Codes over finite geometries," *IEEE Trans. Inform. Theory*, vol. 51, no. 2, pp. 572–596, 2005.
- [151] A. Thangaraj and S. McLaughlin, "Quantum codes from cyclic codes over  $\text{GF}(4^m)$ ," *IEEE Trans. Inform. Theory*, vol. 47, no. 3, pp. 1176–1178, 2001.
- [152] F. Vatan, V. Roychowdhury, and M. Anantram, "Spatially correlated qubit errors and burst-correcting quantum codes," *IEEE Trans. Inform. Theory*, vol. 45, no. 5, pp. 1703–1708, 1999.
- [153] U. Vazirani, "On the power of quantum computation," *Phil. Tran. Royal Soc. London A*, vol. 356, pp. 1759–1768, 1998.
- [154] L. Xiaoyan, "Quantum cyclic and constacyclic codes," *IEEE Trans. Inform. Theory*, vol. 50, no. 3, pp. 547–549, 2004.
- [155] D.-W. Yue and G.-Z. Feng, "Minimum cyclotomic coset representatives and their applications to BCH codes and Goppa codes," *IEEE Trans. Inform. Theory*, vol. 46, no. 7, pp. 2625–2628, 2000.
- [156] D.-W. Yue and Z.-M. Hu, "On the dimension and minimum distance of BCH codes over  $\text{GF}(q)$ ," *J. Electron.*, vol. 18, pp. 263–269, 1996, (In Chinese).

## VITA

Pradeep Kiran Sarvepalli received his Ph.D. in Computer Science from Texas A&M University (2008). His dissertation was in quantum error correction under the supervision of Dr. Andreas Klappenecker. His primary research interests are quantum computing, coding theory, and circuit design. He received his M.S. in Electrical Engineering from Texas A&M University (2003) and his B.Tech in Electrical Engineering from Indian Institute of Technology, Madras (1997). Before he enrolled at Texas A&M University to pursue his graduate studies, he was an IC Design Engineer at Texas Instruments India, Bangalore, where among other things he designed analog and mixed signal circuits. His permanent address is 23/1235, Sodhan Nagar, Nellore, Andhra Pradesh, India 524 003. He can be reached at sarvepalli.pradeep@gmail.com.