

Large amplitude coherent state superposition generated by a time-separated two-photon subtraction from a continuous wave squeezed vacuum

Masahiro Takeoka,^{1,2} Hiroki Takahashi,^{1,2,3} and Masahide Sasaki^{1,2}

¹ *National Institute of Information and Communications Technology,
4-2-1 Nukui-Kita, Koganei, Tokyo 184-8795, Japan*

² *CREST, Japan Science and Technology Agency,
5 Sanbancho, Chiyoda-ku, Tokyo 102-0075, Japan*

³ *Department of Applied Physics, The University of Tokyo 7-3-1 Hongo, Bunkyo-ku, Tokyo 113-8656, Japan*

(Dated: November 5, 2018)

Theoretical analysis is given for a two-photon subtraction from a continuous wave (cw) squeezed vacuum with finite time separation between two detection events. In the cw photon subtraction process, generated states are inevitably described by temporal multimode states. Our approach is based on analytical formulae that are mathematically simple and provide an intuitive understanding of the multimode structure of the system. We show that, in our process, the photon subtracted squeezed vacuum is generated in two temporal modes and one of these modes acts as an ancillary mode to make the other one a large amplitude coherent state superposition.

PACS numbers: 03.67.Hk, 42.50.Dv

I. INTRODUCTION

Photon subtraction is a useful technique to conditionally manipulate nonclassical state of light. To subtract photons from a traveling wave, one puts a highly transmissive beam splitter (BS) and detects a reflected beam by photo-detectors. Selection of the event such that the detectors observe n photons in total approximately acts as annihilation operations \hat{a}^n to the initial state. Applications of the photon subtraction have been proposed so far, e.g. generation of Schrödinger cat-like states [1], distillation of Gaussian entangled states [2], and loophole free tests of the violation of Bell's inequality [3, 4]. In addition, by adding displacement operations in front of the detectors, one would obtain higher flexibility of the output state synthesis [5, 6, 7].

Here the optical Schrödinger cat state means the superposition of distinct coherent states

$$|C_{\pm}\rangle = \frac{1}{\sqrt{\mathcal{N}_{\pm}}}(|\alpha\rangle \pm |-\alpha\rangle), \quad (1)$$

and an n -photon subtracted squeezed vacuum with even (odd) n is approximately equal to $|C_{+}\rangle$ ($|C_{-}\rangle$). Recently, single-photon subtraction from a squeezed vacuum has been experimentally demonstrated with a pulsed [8] and cw [9, 10] squeezed vacuum, those correspond to the generation of $|C_{-}\rangle$ with $|\alpha|^2 \approx 1$. It should also be noted that an alternative way by using a photon number state and conditional homodyne detection has been proposed and experimentally demonstrated with a pulsed two-photon state [11]. The conditional output corresponds to a superposition of displaced X -squeezed states $\hat{D}(\pm\beta)S(r)|0\rangle$ with $|\beta|^2 \approx 1.2$ which would become $|C_{+}\rangle$ with $|\alpha|^2 \approx 2.6$ after applying appropriate squeezing operation in P -direction. Once such a larger amplitude coherent state superposition becomes directly available, it would be an important resource for the linear optics quantum computation scheme [12].

For cw experiments, one has to take into account a problem of mode mismatch between a squeezed state and photon detection events. While coherence time of the cw squeezed vacuum generated from an optical parametric oscillator (OPO) is given by the inverse of the OPO cavity bandwidth (ζ_0^{-1}), the photon detection usually occurs within almost instantaneous time duration ($\Delta\tau \ll \zeta_0^{-1}$). As a consequence, the conditional output state appears locally around the photon detection time with a nontrivial mode function. General theory to simulate such experiments has been developed in [13, 14] and the optimal mode functions are investigated in detail for the conditional generation of single- and two-photon states from a two-mode squeezed vacuum (non-degenerate OPO) [15, 16].

In this paper, we theoretically investigate a two-photon subtraction from a cw squeezed vacuum generated by a degenerate OPO. For a pulsed scheme (or the original proposal in [1]), it conditionally generates an even parity superposition $|C_{+}\rangle$ with $|\alpha|^2 \approx 1$. Compared to the pulsed scheme, a distinct feature of the cw scheme is that the photon detection events generally occur in different times. We show that, surprisingly, with appropriate time difference Δ , a size of the cat state is drastically increased to $|\alpha|^2 = 2.5 \sim 3$ with the fidelity of $F > 0.9$. It is shown that the time-separated photon subtraction generates a nontrivial two-mode state distributed in two particular temporal modes which allows us to synthesize the output state and results a larger amplitude coherent state superposition in an appropriate temporal mode. Also, contrasted to the previous theoretical analyses of the cw schemes [13, 14, 15, 16], our approach is mostly analytical, which is useful for intuitive understandings of the multimode structure in the generated state and how the size of the cat state is increased via quantum interferences.

The paper is organized as follows. In Sec. II, before treating cw sources, we briefly review the properties

of the photon subtracted squeezed state and coherent state superposition. In Sec. III, we discuss the cw time-separated photon subtraction in detail and show how we can extract a larger coherent state superposition from a temporal multimode photon subtracted state. We also discuss the physical insight of the same scheme from an alternative point of view in Sec. IV, where we show that the two types of quantum interferences play crucial roles to increase the size of the superposed coherent states. Section V concludes the paper.

II. SYNTHESIS OF APPROXIMATE COHERENT STATE SUPERPOSITIONS

Generation of a Schrödinger cat-like state by photon subtraction from a traveling wave squeezed vacuum was proposed in [1] which consists of a small reflectance beam splitter and, in ideal, a photon number resolving detector at the reflected port. When the detector counts n photons, the transmitted state is transformed to $|nPS\rangle \propto \hat{a}^n \hat{S}(-r)|0\rangle$, which approximates $|C_+\rangle$ ($|C_-\rangle$) for even (odd) n , where $\hat{S}(r) = \exp[\frac{r}{2}(\hat{a}^2 - \hat{a}^{\dagger 2})]$ is the squeezing operator and $-r$ represents the squeezing in P direction of the phase space. Asymptotically, for large n , the size of α increases as $|\alpha|^2 = n$.

Since $\hat{S}(r)^\dagger \hat{a} \hat{S}(r) = \hat{a} \cosh r - \hat{a}^\dagger \sinh r$, n -photon subtracted state $\hat{a}^n \hat{S}(-r)|0\rangle$ is rewritten as a squeezed state of a superposition of even or odd number states as

$$\begin{aligned} |nPS\rangle &= \frac{1}{\sqrt{\mathcal{N}_n}} \hat{a}^n \hat{S}(-r)|0\rangle \\ &= \frac{1}{\sqrt{\mathcal{N}_n}} \hat{S}(-r) (\hat{a} \cosh r + \hat{a}^\dagger \sinh r)^n |0\rangle \\ &= \hat{S}(-r) \begin{cases} (c_n^r |n\rangle + c_{n-2}^r |n-2\rangle + \dots + c_0^r |0\rangle) \\ n : \text{even}, \\ (c_n^r |n\rangle + c_{n-2}^r |n-2\rangle + \dots + c_1^r |1\rangle) \\ n : \text{odd}, \end{cases} \end{aligned} \quad (2)$$

where \mathcal{N}_n is a normalization factor and each of c_i^r is a function of r . For example, a single-photon subtracted state is exactly equivalent to a squeezed single-photon state.

Meanwhile, it has recently been predicted that if one could arbitrarily synthesize the superposition ratio c_i in the last line of Eq. (2), approximate $|C_\pm\rangle$ with larger α would be obtainable [7, 11]. To discuss it more precisely, let us consider the state

$$|\psi_n\rangle = \hat{S}(-r)(c_n |n\rangle + c_{n-2} |n-2\rangle \dots), \quad (3)$$

and suppose we can arbitrarily set c_i 's. Since the fidelity between $|C_\pm\rangle$ and $|\psi_n\rangle$ is described as

$$F = |\langle C_\pm | \hat{S}(-r)(c_n |n\rangle + \dots) \rangle|^2, \quad (4)$$

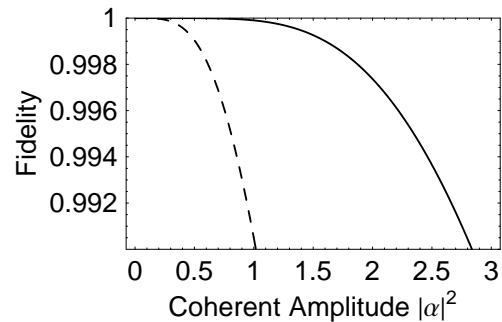

FIG. 1: Fidelity vs the size of the cat state α for $F = |\langle C_+ | \psi_2 \rangle|^2$ (solid line) and $F = |\langle C_+ | 2PS \rangle|^2$ (dashed line).

the optimal coefficients c_i 's maximizing F are proportional to those of the X -squeezed $|C_\pm\rangle$

$$\hat{S}(r)|C_\pm\rangle = \frac{1}{\mathcal{N}_\pm} \hat{S}(r) (|\alpha\rangle \pm |-\alpha\rangle), \quad (5)$$

up to n . Here

$$\begin{aligned} \hat{S}(r)|\pm\alpha\rangle &= (1 - \lambda^2)^{1/4} e^{-(1-\lambda)\alpha^2/2} \sum_{m=0}^{\infty} \frac{1}{\sqrt{m!}} \\ &\times \left(\frac{\lambda}{2}\right)^{n/2} H_m \left(\pm \sqrt{\frac{1-\lambda^2}{2\lambda}} \alpha\right) |m\rangle, \end{aligned} \quad (6)$$

where $\lambda = \tanh r$ and $H_m(x)$ is a Hermite polynomial.

For example, when $n = 2$, the two-photon subtracted state is given by

$$\begin{aligned} |2PS\rangle &\propto \hat{a}^2 \hat{S}(-r)|0\rangle \\ &= \hat{S}(-r) \sinh r \left(\sqrt{2} \sinh r |2\rangle + \cosh r |0\rangle \right). \end{aligned} \quad (7)$$

The squeezed superposition state $|\psi_2\rangle$ is on the other hand found from Eq. (5) to be

$$|\psi_2\rangle \propto \hat{S}(-r) \left(\frac{(1-\lambda^2)\alpha^2 - \lambda}{\sqrt{2}} |2\rangle + |0\rangle \right). \quad (8)$$

The fidelities between these states and $|C_+\rangle$ are plotted in Fig. (1) where note that, for given α , the squeezing parameter r is optimized to maximize the fidelities. It is clearly shown that one can obtain $|C_+\rangle$ with more than twice larger average power ($|\alpha|^2 = 2.5 \sim 3$) if it is possible to synthesize the number state superposition.

In the next section, we show that, with a cw squeezed vacuum source, one can synthesize the superposition by simply having a time separation between two photo-detection events.

III. TIME-SEPARATED PHOTON SUBTRACTION FROM A CW SQUEEZED VACUUM

In this section, we derive an analytical expression of the time-separated two-photon subtracted squeezed vacuum.

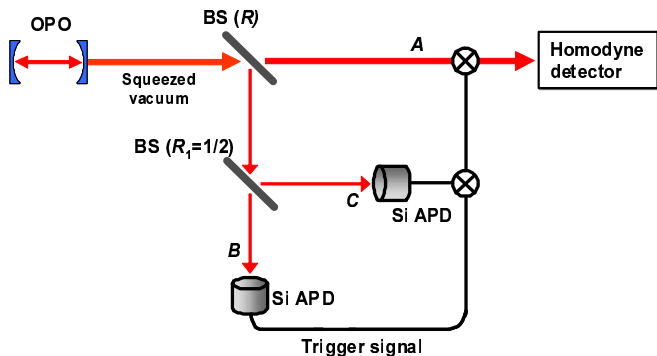

FIG. 2: (Color online) Schematic of the two-photon subtraction from a cw squeezed vacuum.

Schematic is shown in Fig. 2. A cw squeezed vacuum generated from an OPO with the bandwidth ζ_0 is split via a small reflectance BS with the reflectance R and the reflected fraction is guided into two photon detectors in path B and C through a half BS ($R_1 = 1/2$). Choosing the event such that two photons click each of detectors at time $t = t_1$ and t_2 , where $|t_2 - t_1|$ is comparable or smaller than ζ_0^{-1} , one can conditionally obtain a two-photon subtracted state as an output in path A, which is measured by a homodyne detector.

For cw sources, it is important to take into account the mode mismatch between the squeezed vacuum and the photon detection events since the squeezed vacuum is a multi-mode state distributed within a time ζ_0^{-1} , while the photon detections happen almost instantaneously [13, 14, 15, 16]. The conditional output we want to observe is therefore generated in a temporal mode localized around t_1 and t_2 . To detect such state, the homodyne measurement might be a time integrating detection with an appropriate mode function filter. In other words, the homodyne measurement extracts one particular temporal mode from the cw signal.

In the following subsections, we first give a slight modification of the usual input-output theory of the degenerate OPO, and then describe the cw photon subtraction process in Schrödinger picture. Since the purpose of this section is to describe the structure of the time-separated photon subtracted state, we assume that all elements in the scheme are lossless and there is no technical noise. We show that, in an appropriately filtered conditional state, the number state superposition is well synthesized via the time difference of photo-detection events.

A. Squeezing operation via an ideal degenerate OPO

Let us start by briefly reviewing the input-output theory of the degenerate OPO [17]. Denote the positive-frequency part of the field operator in a single transverse

mode of the optical field with a continuous spectrum by

$$\hat{a}(t) = \frac{1}{2\pi} \int_{-\infty}^{\infty} d\Omega \hat{a}(\omega_0 + \Omega) e^{-i(\omega_0 + \Omega)t}. \quad (9)$$

Here $\hat{a}(\omega_0 + \Omega)$ is the annihilation operator for the Fourier component at angular frequency $\omega_0 + \Omega$, where ω_0 is the center angular frequency of the OPO. The operator obeys the continuum commutation relation

$$[\hat{a}(\omega_0 + \Omega), \hat{a}^\dagger(\omega_0 + \Omega')] = 2\pi\delta(\Omega - \Omega'). \quad (10)$$

The time dependent field operator $\hat{a}(t)$ is defined in the interval $(-\infty, \infty)$, and obeys the commutation relation

$$[\hat{a}(t), \hat{a}^\dagger(t')] = \delta(t - t'). \quad (11)$$

These operators should be moved to a rotating frame at the center frequency ω_0 ,

$$\hat{A}(t) = \hat{a}(t)e^{i\omega_0 t} = \frac{1}{2\pi} \int_{-\infty}^{\infty} d\Omega \hat{A}(\Omega) e^{-i\Omega t}, \quad (12)$$

where $\hat{A}(\Omega) = \hat{a}(\omega_0 + \Omega)$.

Following [17], an input-output relation of the lossless OPO is described by the Bogolubov transformation

$$\hat{S}_A^\dagger \hat{A}(\Omega) \hat{S}_A = \mu(\Omega) \hat{A}(\Omega) + \nu(\Omega) \hat{A}^\dagger(-\Omega), \quad (13)$$

where

$$\mu(\Omega) = \frac{\zeta_0^2 + \epsilon^2 + \Omega^2}{(\zeta_0 - i\Omega)^2 - \epsilon^2}, \quad (14)$$

$$\nu(\Omega) = \frac{2\zeta_0\epsilon}{(\zeta_0 - i\Omega)^2 - \epsilon^2}. \quad (15)$$

Here $\zeta_0 \equiv \gamma_T/2$ corresponds to the bandwidth of the OPO output, and γ_T and ϵ are the leakage rate of the OPO output mirror and the parameter proportional to the nonlinear coefficient of the OPO crystal and the pump amplitude, respectively.

The above transformation is rewritten in a useful form by introducing the input field annihilation operator

$$\hat{A}_\theta(\Omega) \equiv \hat{A}(\Omega) e^{i\theta(\Omega)}, \quad (16)$$

with

$$\tan \theta(\Omega) = \frac{2\zeta_0\Omega}{\zeta_0^2 - \epsilon^2 - \Omega^2}, \quad (17)$$

which obeys the communication relation

$$[\hat{A}_\theta(\Omega), \hat{A}_\theta^\dagger(\Omega')] = 2\pi\delta(\Omega - \Omega'). \quad (18)$$

The Bogolubov transformation in Eq. (13) is then rewritten as

$$\hat{S}_A^\dagger \hat{A}(\Omega) \hat{S}_A = \bar{\mu}(\Omega) \hat{A}_\theta(\Omega) + \bar{\nu}(\Omega) \hat{A}_\theta^\dagger(-\Omega), \quad (19)$$

where

$$\bar{\mu}(\Omega) \equiv \mu(\Omega) e^{-i\theta(\Omega)} = \frac{\zeta_0^2 + \epsilon^2 + \Omega^2}{\sqrt{(\zeta_+^2 + \Omega^2)(\zeta_-^2 + \Omega^2)}}, \quad (20)$$

$$\bar{\nu}(\Omega) \equiv \nu(\Omega) e^{-i\theta(\Omega)} = \frac{2\zeta_0\epsilon}{\sqrt{(\zeta_+^2 + \Omega^2)(\zeta_-^2 + \Omega^2)}}, \quad (21)$$

and $\zeta_\pm = \zeta_0 \pm \epsilon$.

B. Schrödinger picture of the two-photon subtraction from a cw squeezed vacuum

Let us now turn to the photon subtraction operations. Denote the time dependent field operator in paths A, B, and C (in a rotating frame) by $\hat{A}(t)$, $\hat{B}(t)$, and $\hat{C}(t)$, respectively (see Fig. 2). A cw squeezed vacuum state generated from a lossless OPO is described by $\hat{S}_A|\mathbf{0}_A\rangle$. After beam splitting it via the two BSs (R and R_1), the quantum state distributed in three paths is described by $\hat{V}_{BC}\hat{V}_{AB}\hat{S}_A|\mathbf{0}_{ABC}\rangle$ where \hat{V}_{AB} is a beam splitting operator transforming the field operator, for example, $\hat{V}_{AB}^\dagger\hat{B}(t)\hat{V}_{AB} = -\sqrt{R}\hat{A}(t) + \sqrt{1-R}\hat{B}(t)$. Suppose the first and second photons are detected at the time $t = t_1$ and t_2 in paths B and C, respectively, while the detectors project the state onto vacua in all other time. We assume that the detector's time resolution is instantaneous i.e. enough shorter than the cavity lifetime ζ_0^{-1} . After such event, the conditional output state in path A is projected onto

$$\begin{aligned} |\rho_{cw}\rangle &\propto \langle \mathbf{0}_{BC} | \hat{C}(t_2) \hat{B}(t_1) \hat{V}_{BC} \hat{V}_{AB} \hat{S}_A | \mathbf{0}_{ABC} \rangle \\ &= \frac{R}{\sqrt{2}} \exp \left[\ln \sqrt{1-R} \int_{-\infty}^{\infty} dt \hat{A}^\dagger(t) \hat{A}(t) \right] \\ &\quad \times \hat{A}(t_2) \hat{A}(t_1) \hat{S}_A | \mathbf{0}_A \rangle \end{aligned} \quad (22)$$

where note that $R_1 = 1/2$. In the limit of small R , the exponential term is approximated to be $\exp[\ln \sqrt{1-R} \int dt \hat{A}^\dagger(t) \hat{A}(t)] \sim 1$ and thus the state is described by a two-photon annihilated squeezed vacuum

$$|\rho_{cw}\rangle \propto \hat{A}(t_2) \hat{A}(t_1) \hat{S}_A | \mathbf{0}_A \rangle. \quad (23)$$

By use of the property of the squeezing operation in Eq. (19), we further obtain

$$\begin{aligned} |\rho_{cw}\rangle &\propto \hat{A}(t_2) \hat{A}(t_1) \hat{S}_A | \mathbf{0}_A \rangle \\ &= \hat{S}_A \left(\int_{-\infty}^{\infty} dt \bar{v}(t-t_2) \hat{A}_\theta^\dagger(t) \int_{-\infty}^{\infty} dt \bar{v}(t-t_1) \hat{A}_\theta^\dagger(t) \right. \\ &\quad \left. + \int_{-\infty}^{\infty} dt \bar{\mu}(t-t_2) \bar{v}(t-t_1) \right) | \mathbf{0}_A \rangle, \end{aligned} \quad (24)$$

where

$$\bar{\mu}(t-t_0) = \frac{1}{2\pi} \int_{-\infty}^{\infty} d\Omega \bar{\mu}(\Omega) e^{-i\Omega(t-t_0)}, \quad (25)$$

$$\bar{v}(t-t_0) = \frac{1}{2\pi} \int_{-\infty}^{\infty} d\Omega \bar{v}(\Omega) e^{-i\Omega(t-t_0)}. \quad (26)$$

Defining the normalized temporal function

$$\psi(t-t_0) \equiv \frac{1}{\sqrt{\mathcal{N}_\nu}} \bar{v}(t-t_0), \quad (27)$$

$$\mathcal{N}_\nu = \frac{\zeta_0 \epsilon}{2} \left(\frac{1}{\zeta_-} - \frac{1}{\zeta_+} \right), \quad (28)$$

the output state is simply described as

$$|\rho_{cw}\rangle \propto \hat{S}_A \left(\mathcal{N}_\nu \hat{A}_2^\dagger \hat{A}_1^\dagger + F_\Delta \right) | \mathbf{0}_A \rangle, \quad (29)$$

where

$$\hat{A}_i^\dagger \equiv \int_{-\infty}^{\infty} dt \psi(t-t_i) \hat{A}_\theta^\dagger(t), \quad (30)$$

$$F_\Delta = \int_{-\infty}^{\infty} dt \bar{\mu}(t-t_2) \bar{v}(t-t_1), \quad (31)$$

and $\Delta = |t_2 - t_1|$ is the time difference between the photon detection events. Note that, in the limit of small ϵ , the temporal mode function is approximated to be $\psi(t) \approx \sqrt{\zeta_0} e^{-\zeta_0 |t|}$ which is a reasonable approximation in the realistic experiments [9, 10]. Now, since $\psi(t-t_i)$'s are nonorthogonal to each other, it is useful to introduce an orthonormal basis in these two-dimensional temporal modes. Let us here recall that we will observe only a single-temporal mode at the final homodyne detection step, which should be a highly nontrivial state. One of the natural choices of the such mode is to include the first term in the right hand side of Eq. (29) as much as possible. Then we arrive at the basis consisting of symmetric and anti-symmetric orthonormal functions defined by

$$\Psi_\pm(t) \equiv \frac{\psi(t-t_2) \pm \psi(t-t_1)}{\sqrt{2(1 \pm I_\Delta)}}, \quad (32)$$

where

$$I_\Delta = \int_{-\infty}^{\infty} dt \psi(t-t_2) \psi(t-t_1) \quad (33)$$

and $\Psi_\pm(t)$ is expected to be the final mode, i.e. the filter function of the homodyne detection. Corresponding field operators and state vectors are also defined as

$$\hat{A}_\pm^\dagger \equiv \int_{-\infty}^{\infty} dt \Psi_\pm(t) \hat{A}_\theta^\dagger(t), \quad (34)$$

and

$$\hat{A}_\pm^\dagger |n_\pm\rangle \equiv \sqrt{n+1} |n+1_\pm\rangle, \quad | \mathbf{0}_A \rangle \equiv |0_+\rangle |0_-\rangle | \mathbf{0}_{\hat{A}} \rangle. \quad (35)$$

Then $|\rho_{cw}\rangle$ is now expressed as

$$\begin{aligned} |\rho_{cw}\rangle &= \frac{\hat{S}_A}{\sqrt{\mathcal{N}}} \left\{ \mathcal{N}_\nu \left(\frac{1+I_\Delta}{2} \hat{A}_+^{\dagger 2} - \frac{1-I_\Delta}{2} \hat{A}_-^{\dagger 2} \right) + F_\Delta \right\} | \mathbf{0}_A \rangle \\ &= \frac{\hat{S}_A}{\sqrt{\mathcal{N}}} \left\{ \frac{\mathcal{N}_\nu(1+I_\Delta)}{\sqrt{2}} |2_+, 0_-\rangle \right. \\ &\quad \left. - \frac{\mathcal{N}_\nu(1-I_\Delta)}{\sqrt{2}} |0_+, 2_-\rangle + F_\Delta |0_+, 0_-\rangle \right\} | \mathbf{0}_{\hat{A}} \rangle, \\ &= \hat{S}_A | \rho_{+-} \rangle | \mathbf{0}_{\hat{A}} \rangle, \end{aligned} \quad (36)$$

where

$$\mathcal{N} = \mathcal{N}_\nu^2 (1 + I_\Delta^2) + F_\Delta^2. \quad (37)$$

Note that, in Eq. (36), the cross-term $\hat{A}_+^\dagger \hat{A}_-^\dagger$ is vanished due to the bunching-like interference of these creation

operators. We will discuss such quantum interference again in the next section.

The conditional output state described by Eq. (36) is understood as the squeezed state of $|\rho_{+-}\rangle|0_{\tilde{A}}\rangle$ where $|\rho_{+-}\rangle$ is the superposition of the two-photon states occupying the temporal mode $\Psi_+(t)$ or $\Psi_-(t)$, respectively, and the vacuum state. Note that when two photons are detected at the same time ($\Delta = 0$), the second term of $|\rho_{+-}\rangle$ vanishes (mode $\Psi_-(t)$ cannot be defined) and thus the ideal two-photon subtracted state is localized into the temporal mode $\Psi_+(t)$. Moreover, as will be shown, when Δ increases, one can observe a larger amplitude coherent state superposition in mode $\Psi_+(t)$. In the following, therefore, we choose $\Psi_+(t)$ as the filter function for the temporal mode of the LO field in the homodyne detector, i.e. the detector's observable is described by the quadrature operator

$$\hat{X}_{HD} \equiv \int_{-\infty}^{\infty} dt \Psi_+(t) \hat{X}(t), \quad (38)$$

(in practice, the integration is carried within a finite time width $T' (\gg \zeta_0^{-1})$).

Let us see the reduced quantum state in mode $\Psi_+(t)$. We first trace out mode \tilde{A} from $|\rho_{cw}\rangle$. The reduced state is then given by

$$\begin{aligned} \hat{\rho}_{+-} &= \text{Tr}_{\tilde{A}}[|\rho_{cw}\rangle\langle\rho_{cw}|] \\ &= (\hat{S}_+ \otimes \hat{S}_-) |\rho_{+-}\rangle\langle\rho_{+-}|, \end{aligned} \quad (39)$$

where \hat{S}_+ and \hat{S}_- are the non-unitary Gaussian operations acting on modes Ψ_+ and Ψ_- separately. Each of \hat{S}_{\pm} can be regarded as a single-mode squeezing operation although the process includes a small coupling with thermal environment (for derivation and characteristics of \hat{S}_{\pm} , see Appendix A).

Let us further trace out mode $\Psi_-(t)$ from $\hat{\rho}_{+-}$. We then obtain

$$\begin{aligned} \hat{\rho}_+ &= \text{Tr}_-[\hat{\rho}_{+-}] \\ &= C_{\phi} \hat{S}_+ |\phi\rangle\langle\phi| + C_v \hat{S}_+ |0\rangle\langle 0|, \end{aligned} \quad (40)$$

where

$$\begin{aligned} |\phi\rangle &= c_2 |2_+\rangle + c_0 |0_+\rangle \\ &= \frac{1}{\sqrt{\mathcal{N}_{\phi}}} \left\{ \frac{\mathcal{N}_{\nu}(1 + I_{\Delta})}{\sqrt{2}} |2_+\rangle + F_{\Delta} |0_+\rangle \right\}, \end{aligned} \quad (41)$$

and

$$\mathcal{N}_{\phi} = \frac{\mathcal{N}_{\nu}}{2} (1 + I_{\Delta})^2 + F_{\Delta}^2. \quad (42)$$

As shown in these equations, the output quantum state observed by the homodyne detector with the filter function $\Psi_+(t)$ is the statistical mixture of the squeezed $|\phi\rangle$ and vacuum. The ratio of the statistical mixing is given by

$$C_{\phi} = \frac{\mathcal{N}_{\phi}}{\mathcal{N}} = \frac{\frac{1}{2}\mathcal{N}_{\nu}^2(1 + I_{\Delta})^2 + F_{\Delta}^2}{\mathcal{N}_{\nu}^2(1 + I_{\Delta}^2) + F_{\Delta}^2}, \quad (43)$$

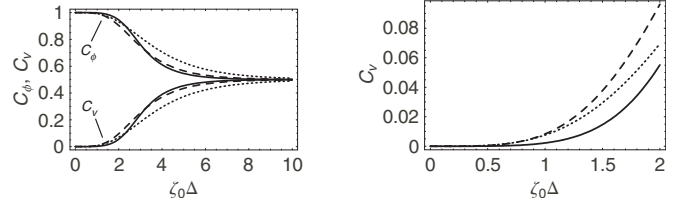

FIG. 3: The upper and lower lines show C_{ϕ} and C_v , respectively with $|\epsilon|/\zeta_0=0.1$ (solid lines), 0.3 (dashed lines), and 0.5 (dotted lines).

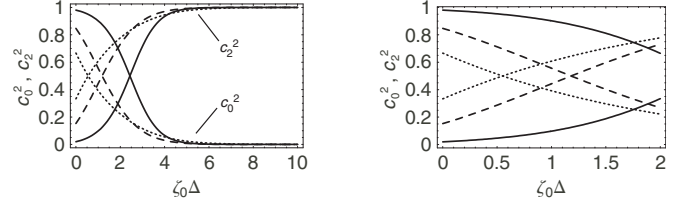

FIG. 4: The upper and lower lines (at $\zeta_0\Delta = 0$) show c_0^2 and c_2^2 , respectively with $|\epsilon|/\zeta_0=0.1$ (solid lines), 0.3 (dashed lines), and 0.5 (dotted lines).

and $C_v = 1 - C_{\phi}$.

In Figs. 3 and 4, we plot C_{ϕ} , C_v , c_2^2 , and c_0^2 , that characterize $\hat{\rho}_+$, as functions of Δ . For large delay ($\Delta \gg 1/\zeta_0$), the output state goes to the mixture of two- and zero-photon state as

$$\hat{\rho}_+ \rightarrow \frac{1}{2} \hat{S}_+ (|2\rangle\langle 2| + |0\rangle\langle 0|), \quad (44)$$

which was already pointed out in the scheme of generating multi-photon state from a cw non-degenerate OPO source [7].

In our scheme, on the other hand, the intermediate delay region ($\Delta \sim \zeta_0^{-1}$) is particularly interesting. Since C_v is almost negligible as shown in Fig. 3, $\hat{\rho}_+$ can be approximated to be

$$\hat{\rho}_+ \approx \hat{S}_+ |\phi\rangle\langle\phi|. \quad (45)$$

On the other hand, Fig. 4 clearly shows that the tuning of Δ around ζ_0^{-1} provides us a wide controllability of the superposition ratio of two- and zero-photon states in $|\phi\rangle$. As discussed in Sec. II, this allows us to generate larger coherent state superposition.

To see the superposition property in phase space, we have calculated the Wigner function of $\hat{\rho}_+$ without any approximation (see Appendix B). Typical Wigner functions are shown in Figs. 5(a)-(c) for different Δ . These figures clearly show that the increase of Δ induces a larger size superposition. Note that the fidelity between the state in Fig. 5(b) and $|C_+\rangle$ with $|\alpha|^2 = 2.6$ is 0.946. Fidelities between $\hat{\rho}_+$ and $|C_+\rangle$'s with different amplitudes are shown in Fig. 6 as a function of Δ . We see that our time-separated two-photon subtraction technique allows us to generate a larger superposition such as

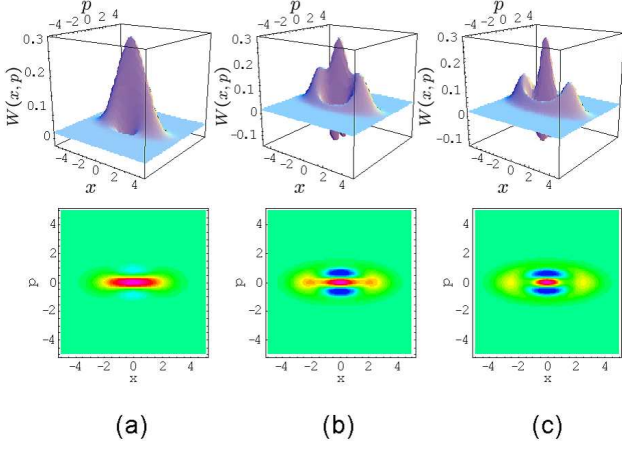

FIG. 5: (Color online) Wigner functions of $\hat{\rho}_+$. $|\epsilon|/\zeta_0 = 0.27$ and (a) $\zeta_0\Delta = 0$, (b) $\zeta_0\Delta = 1.4$, (c) $\zeta_0\Delta = 2.4$. The fidelity between (b) and the ideal cat state with $|\alpha|^2 = 2.6$ is 0.946.

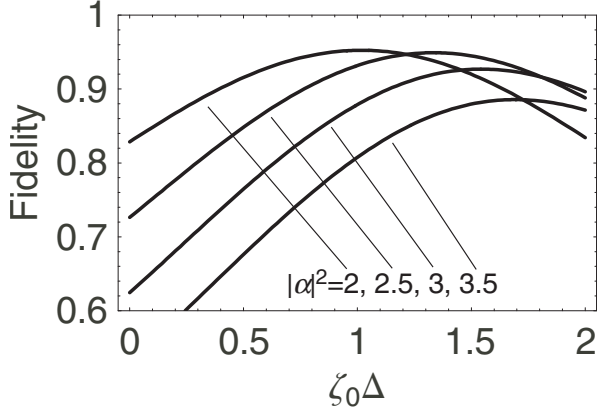

FIG. 6: Fidelity between $\hat{\rho}_+$ and the ideal cat state with $|\alpha|^2 = 2, 2.5, 3,$ and 3.5 (from left to right). $|\epsilon|/\zeta_0 = 0.27$.

$|\alpha|^2 > 2.5$ with high fidelity ($0.9 >$), that is not possible with a normal single-mode (pulsed) two-photon subtraction.

IV. QUANTUM INTERFERENCE OF THE SUBTRACTED PHOTONS

In the previous section, we have observed a bosonic bunching-like effect between \hat{A}_+^\dagger and \hat{A}_-^\dagger that originates from the two-photon subtraction (see Eq. (36)). In this section, we again discuss the cw two-photon subtraction from the viewpoint of quantum interferences. It is natural to expect that the state synthesis is achieved by some quantum interference. Generally, quantum interference occurs when the quantum process or states are going to be intrinsically indistinguishable. We concretely show that, in our case, two types of such interferences con-

tribute to the size increase of the cat state.

Let us reexamine the cw state $|\rho_{cw}\rangle = \frac{1}{\sqrt{\mathcal{N}}}\hat{A}(t_2)\hat{A}(t_1)\hat{S}_A|\mathbf{0}\rangle$ and consider from which mode the subtracted photons ($\hat{A}(t_2)$ and $\hat{A}(t_1)$) originates, $\Psi_+(t)$ or $\Psi_-(t)$. This is clarified by defining the following annihilation operators

$$\hat{A}_{t\pm} \equiv \frac{1}{\sqrt{2}}\left(\hat{A}(t_2) \pm \hat{A}(t_1)\right), \quad (46)$$

where \hat{A}_{t+} (\hat{A}_{t-}) is the annihilation operator which subtracts one photon from the squeezed vacuum in mode $\Psi_+(t)$ ($\Psi_-(t)$).

This is confirmed by directly substituting them as

$$\begin{aligned} |\rho_{cw}\rangle &= \frac{1}{2\sqrt{\mathcal{N}}}\left(\hat{A}_{t+}^2 - \hat{A}_{t-}^2\right)\hat{S}_A|\mathbf{0}\rangle \\ &= \sigma_+\hat{S}_A|\gamma_+\rangle|0_-\rangle|\mathbf{0}_{\bar{A}}\rangle - \sigma_-\hat{S}_A|0_+\rangle|\gamma_-\rangle|\mathbf{0}_{\bar{A}}\rangle, \end{aligned} \quad (47)$$

where we clearly see that \hat{A}_{t+} and \hat{A}_{t-} change the states only in $\Psi_+(t)$ and $\Psi_-(t)$, respectively. Moreover, from the first to second line, we observe a bunching-like quantum interference, i.e. the possibility such that each photon is subtracted from each of $\Psi_{\pm}(t)$ is vanished. Note that

$$\begin{aligned} |\gamma_{\pm}\rangle &= \frac{1}{\sigma_{\pm}}\left\{\sqrt{2}\left(\frac{1 \pm e^{-\zeta-\Delta}}{\zeta_-} - \frac{1 \pm e^{-\zeta+\Delta}}{\zeta_+}\right)|2_{\pm}\rangle\right. \\ &\quad \left. + \left(\frac{1 \pm e^{-\zeta-\Delta}}{\zeta_-} + \frac{1 \pm e^{-\zeta+\Delta}}{\zeta_+}\right)|0_{\pm}\rangle\right\}, \end{aligned} \quad (48)$$

and

$$\begin{aligned} \sigma_{\pm}^2 &= 2\left(\frac{1 \pm e^{-\zeta-\Delta}}{\zeta_-} - \frac{1 \pm e^{-\zeta+\Delta}}{\zeta_+}\right)^2 \\ &\quad + \left(\frac{1 \pm e^{-\zeta-\Delta}}{\zeta_-} + \frac{1 \pm e^{-\zeta+\Delta}}{\zeta_+}\right)^2. \end{aligned} \quad (49)$$

The final state to be measured is obtained by tracing modes \bar{A} and $\Psi_-(t)$ out. If $|0_-\rangle$ and $|\gamma_-\rangle$ in Eq. (47) are orthogonal (distinguishable), the final state is reduced to be a statistical mixture of $|0_+\rangle$ and $|\gamma_+\rangle$. These terms are, however, nonorthogonal, i.e. partially indistinguishable. One therefore may expect that some of the quantum coherence between $|0_+\rangle$ and $|\gamma_+\rangle$ remains. This is the second type of quantum interference. To see this clearer, let us first simplify the equation by taking the approximation of the small squeezing limit. Neglecting the higher order of ϵ/ζ_0 , we have

$$\begin{aligned} |\rho_{cw}\rangle &\approx \sigma_+\hat{S}_A\left(\frac{\epsilon\delta_+}{\zeta_0}\hat{A}_+^{\dagger 2} + 1\right)|0_+\rangle|0_-\rangle|\mathbf{0}_{\bar{A}}\rangle \\ &\quad - \sigma_-\hat{S}_A\left(\frac{\epsilon\delta_-}{\zeta_0}\hat{A}_-^{\dagger 2} + 1\right)|0_+\rangle|0_-\rangle|\mathbf{0}_{\bar{A}}\rangle. \end{aligned} \quad (50)$$

where

$$\sigma_{\pm} \approx \frac{1 \pm e^{-\zeta_0 \Delta}}{2}, \quad (51)$$

$$\delta_{\pm} = 1 \pm \frac{\zeta_0 \Delta e^{-\zeta_0 \Delta}}{1 \pm e^{-\zeta_0 \Delta}}. \quad (52)$$

Note that δ_+ is around $1 \sim 1.25$ and in practice, ϵ/ζ_0 is often regarded as an effective pumping parameter normalized by the OPO threshold. We should argue that the state where the two photons are subtracted at the same time t_1 ($\Delta = 0$) is also given by

$$\frac{1}{\sqrt{\mathcal{N}}} \hat{A}^2(t_1) \hat{S} |\mathbf{0}\rangle \approx \hat{S} \left[\frac{\epsilon}{\zeta_0} \hat{A}_1^{\dagger 2} + 1 \right] |\mathbf{0}\rangle, \quad (53)$$

which corresponds to the original photon subtraction scheme proposed in [1] and here we call it a time-degenerate two-photon subtracted state.

Let us trace modes \hat{A} and $\Psi_-(t)$ out and see the reduced state with finite Δ . Approximating the squeezing operation acting on modes $\Psi_+(t)$ and $\Psi_-(t)$ to be a separable unitary squeezing operator $\hat{S}_+ \otimes \hat{S}_-$ (see Appendix A), we obtain the reduced state as

$$\hat{\rho}_+ \approx (1 - C_v) |\Phi\rangle \langle \Phi| + C_v \hat{S}_+ |0\rangle \langle 0| \hat{S}_+^{\dagger}, \quad (54)$$

where $C_v = \frac{\epsilon^2}{2\zeta_0^2} (1 - I_{\Delta})^2 / \left\{ \frac{\epsilon^2}{\zeta_0^2} (1 + I_{\Delta}^2) + e^{-2\zeta_0 \Delta} \right\}$ and

$$|\Phi\rangle \propto \hat{S}_+ \left(\frac{\epsilon \delta_+}{\zeta_0} \hat{A}_+^{\dagger 2} + 1 \right) |0\rangle - \tanh \left(\frac{\zeta_0 \Delta}{2} \right) \hat{S}_+ |0\rangle, \quad (55)$$

these correspond to Eqs. (40) and (41). Therefore, the component of the cat-like state $|\Phi\rangle$ produced by the time-separated two-photon subtraction stems from the quantum interference (superposition) of the time-degenerate two-photon subtracted state and a squeezed vacuum. That is, the engineering of the state indistinguishability in mode $\Psi_-(t)$ allows us to synthesize the superposition ratio in mode $\Psi_+(t)$, in other words, provides the size controllability of $|\Phi\rangle$ in mode $\Psi_+(t)$. Note that, on the other hand, $|0_-\rangle$ and $|\gamma_-\rangle$ are only *partially* indistinguishable. Their distinguishable part creates the statistical mixture term $\hat{S}_+ |0\rangle \langle 0| \hat{S}_+^{\dagger}$ with the factor of C_v .

V. CONCLUSION

In conclusion, we have theoretically investigated the time-separated two-photon subtraction from a continuous wave squeezed vacuum. In a single-mode theory, a two-photon subtracted squeezed vacuum is regarded as a squeezed state of $c_2^r |2\rangle + c_0^r |0\rangle$ in which, however, the superposition coefficients c_2^r and c_0^r are not optimal to maximize its fidelity to a coherent state superposition.

In case of a cw scheme, one needs a multi-mode theory and we showed that when the time difference of the two photo-detection events is finite but within the coherence

time of the squeezed vacuum, the conditional output is appeared within two temporal modes, as a squeezed superposition of $|20\rangle$, $|02\rangle$, and $|00\rangle$. Such superposition and a careful choice of the single mode function $\Psi_+(t)$ allow us to synthesize the even photon number superposition of the conditional output state and with appropriate parameters it results a generation of cat-like states which have more than 90% fidelity with the coherent state superposition of $|\alpha|^2 > 2.5$. We have also discussed the same issue from the viewpoint of quantum interference, which reveals how the conditional output state of the time-separated photon subtraction is deviated from that of the time-degenerate one, due to the quantum interferences. Our theoretical approach provides analytical expressions of the states, which would be further useful to investigate an intuitive physical picture of more complicated multi-mode cw quantum states.

APPENDIX A: SQUEEZING OPERATION ON TEMPORAL MODES $\Psi_{\pm}(t)$ VIA AN OPTICAL PARAMETRIC OSCILLATOR

In this Appendix, we discuss the input-output relation of the OPO from the input state prepared in modes $\Psi_{\pm}(t)$ to the output state in modes $\Psi_{\pm}(t)$. Namely, we look at the completely positive trace preserving map

$$\hat{S} \hat{\rho}_{+-} = \text{Tr}_{\bar{A}} \left[\hat{S}_A (\hat{\rho}_{+-} \otimes |\mathbf{0}_{\bar{A}}\rangle \langle \mathbf{0}_{\bar{A}}|) \hat{S}_A^{\dagger} \right]. \quad (A1)$$

In the following, we assume that the OPO is lossless and we often use the mode functions $\Psi_{\pm}(\Omega)$ that are the Fourier transformed expressions of $\Psi_{\pm}(t)$.

Let us define the complete orthogonal set $\{\Psi_{\pm}(\Omega), \Psi_i^{(v)}(\Omega)\}_i$ in frequency domain where $\Psi_i^{(v)}(t)$ corresponds to the mode function for the vacuum input. Applying it into the annihilation operator $\hat{A}(\Omega)$, we have

$$\hat{A}(\Omega) = \Psi_+(\Omega) \hat{A}_+ + \Psi_-(\Omega) \hat{A}_- + \sum_i \Psi_i^{(v)}(\Omega) \hat{A}_i^{(v)}, \quad (A2)$$

where

$$\hat{A}_i^{(v)} = \frac{1}{2\pi} \int_{-\infty}^{\infty} d\Omega \Psi_i^*(\Omega) \hat{A}(\Omega), \quad (A3)$$

and again the superscript (v) means that its initial state is a vacuum.

From the Bogolubov transformation of the OPO $\hat{A}^{\text{out}}(\Omega) = \hat{S}_A^{\dagger} \hat{A}^{\text{in}}(\Omega) \hat{S}_A$, which is defined in Eq. (19), we can describe the input-output relation of the OPO

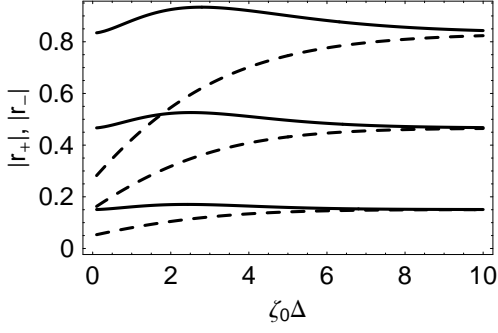

FIG. 7: Squeezing parameters $|r_+|$ (solid lines) and $|r_-|$ (dashed lines). From the lower to upper curves, $|\epsilon|/\zeta_0 = 0.1, 0.3, 0.5$, respectively.

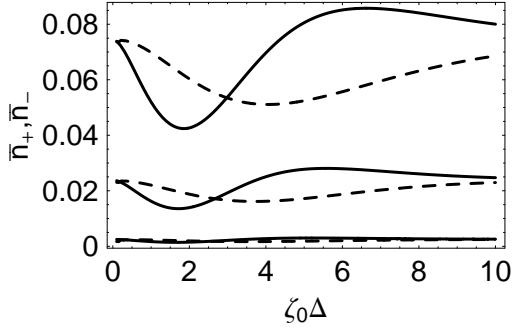

FIG. 8: Thermal photons \bar{n}_+ (solid lines) and \bar{n}_- (dashed lines). From the lower to upper curves, $|\epsilon|/\zeta_0 = 0.1, 0.3, 0.5$, respectively.

with respect to \hat{A}_\pm as

$$\begin{aligned} \hat{A}_\pm^{\text{out}} &= \frac{1}{2\pi} \int_{-\infty}^{\infty} d\Omega \Psi_\pm^*(\Omega) \hat{A}^{\text{out}}(\Omega) \\ &= \frac{1}{2\pi} \int_{-\infty}^{\infty} d\Omega |\Psi_\pm(\Omega)|^2 \left(\bar{\mu}(\Omega) \hat{A}_\pm^{\text{in}} + \bar{\nu}(\Omega) \hat{A}_\pm^{\text{in}\dagger} \right) \\ &\quad + \frac{1}{2\pi} \int_{-\infty}^{\infty} d\Omega \Psi_\pm^*(\Omega) \sum_i \Psi_i^{(v)}(\Omega) \\ &\quad \times \left(\bar{\mu}(\Omega) \hat{A}_i^{(v)} + \bar{\nu}(\Omega) \hat{A}_i^{(v)\dagger} \right). \end{aligned} \quad (\text{A4})$$

Note that we have used the relation

$$\begin{aligned} &\frac{1}{2\pi} \int_{-\infty}^{\infty} d\Omega \bar{\mu}(\Omega) \Psi_+^*(\Omega) \Psi_-(\Omega) \\ &= \frac{1}{2\pi} \int_{-\infty}^{\infty} d\Omega \bar{\nu}(\Omega) \Psi_+^*(\Omega) \Psi_-(\Omega) = 0, \end{aligned} \quad (\text{A5})$$

which implies that the OPO does not couple the modes $\Psi_+(\Omega)$ and $\Psi_-(\Omega)$. It therefore means that the map \hat{S} can be decomposed as

$$\hat{S} = \hat{S}_+ \otimes \hat{S}_-. \quad (\text{A6})$$

The concrete expressions of the maps \hat{S}_\pm are given as follows. Since the OPO includes only Gaussian operations, \hat{S}_\pm can be fully characterized by the real matrices S_\pm, Y_\pm , which describe the input-output relation of the covariance matrix as

$$\Gamma_\pm^{\text{out}} = S_\pm^T \Gamma_\pm^{\text{in}} S_\pm + Y_\pm, \quad (\text{A7})$$

where Γ_\pm^{in} and Γ_\pm^{out} are the covariance matrices of the input and output states, respectively, consisting of the variances of the quadratures, e.g.

$$\Gamma_\pm^{\text{in}} = \frac{1}{2} \begin{bmatrix} \langle \hat{X}_\pm^2 \rangle & \langle \hat{X}_\pm \hat{P}_\pm \rangle \\ \langle \hat{P}_\pm \hat{X}_\pm \rangle & \langle \hat{P}_\pm^2 \rangle \end{bmatrix}. \quad (\text{A8})$$

From Eq. (A4), we find

$$\langle \hat{X}_\pm^{\text{out}2} \rangle = G_X^\pm \langle \hat{X}_\pm^{\text{in}2} \rangle + \frac{1}{2} (F_X^\pm - G_X^\pm), \quad (\text{A9})$$

$$\langle \hat{P}_\pm^{\text{out}2} \rangle = G_P^\pm \langle \hat{P}_\pm^{\text{in}2} \rangle + \frac{1}{2} (F_P^\pm - G_P^\pm), \quad (\text{A10})$$

$$\langle \hat{X}_\pm^{\text{out}} \hat{P}_\pm^{\text{out}} \rangle = G_X^\pm G_P^\pm \langle \hat{X}_\pm^{\text{in}} \hat{P}_\pm^{\text{in}} \rangle, \quad (\text{A11})$$

where

$$\begin{aligned} G_X^\pm &= \frac{1}{2\pi} \int_{-\infty}^{\infty} d\Omega g(\Omega) |\Psi_\pm(\Omega)|^2 \\ &= \frac{4\zeta_0^2 \epsilon^2}{\mathcal{N}_\nu(1 \pm I_\Delta)} \frac{1}{2\pi} \int_{-\infty}^{\infty} d\Omega \frac{1 \pm \cos \Delta\Omega}{(\zeta_+^2 + \Omega^2)^{1/2} (\zeta_-^2 + \Omega^2)^{3/2}}, \end{aligned} \quad (\text{A12})$$

$$\begin{aligned} G_P^\pm &= \frac{1}{2\pi} \int_{-\infty}^{\infty} d\Omega g^{-1}(\Omega) |\Psi_\pm(\Omega)|^2 \\ &= \frac{4\zeta_0^2 \epsilon^2}{\mathcal{N}_\nu(1 \pm I_\Delta)} \frac{1}{2\pi} \int_{-\infty}^{\infty} d\Omega \frac{1 \pm \cos \Delta\Omega}{(\zeta_+^2 + \Omega^2)^{3/2} (\zeta_-^2 + \Omega^2)^{1/2}}, \\ F_X^\pm &= \frac{1}{2\pi} \int_{-\infty}^{\infty} d\Omega g^2(\Omega) |\Psi_\pm(\Omega)|^2 \\ &= \frac{4\zeta_0^2 \epsilon^2}{\mathcal{N}_\nu(1 \pm I_\Delta)} \frac{1}{2\pi} \int_{-\infty}^{\infty} d\Omega \frac{1 \pm \cos \Delta\Omega}{(\zeta_+^2 + \Omega^2)(\zeta_-^2 + \Omega^2)^2} \\ &= \frac{\zeta_0^2 \epsilon^2 \{1 \pm (1 + \zeta_- \Delta) e^{-\zeta_- \Delta}\}}{\zeta_+^3 \mathcal{N}_\nu(1 \pm I_\Delta)} \end{aligned} \quad (\text{A13})$$

$$\begin{aligned} F_P^\pm &= \frac{1}{2\pi} \int_{-\infty}^{\infty} d\Omega g^{-2}(\Omega) |\Psi_\pm(\Omega)|^2 \\ &= \frac{4\zeta_0^2 \epsilon^2}{\mathcal{N}_\nu(1 \pm I_\Delta)} \frac{1}{2\pi} \int_{-\infty}^{\infty} d\Omega \frac{1 \pm \cos \Delta\Omega}{(\zeta_+^2 + \Omega^2)^2 (\zeta_-^2 + \Omega^2)}, \\ &= \frac{\zeta_0^2 \epsilon^2 \{1 \pm (1 + \zeta_+ \Delta) e^{-\zeta_+ \Delta}\}}{\zeta_+^3 \mathcal{N}_\nu(1 \pm I_\Delta)}, \end{aligned} \quad (\text{A14})$$

and

$$g(\Omega) = \bar{\mu} + \bar{\nu} = \sqrt{\frac{\zeta_+^2 + \Omega^2}{\zeta_-^2 + \Omega^2}}. \quad (\text{A15})$$

Then we obtain

$$S_\pm = \begin{bmatrix} G_X^\pm & 0 \\ 0 & G_P^\pm \end{bmatrix}, \quad (\text{A16})$$

$$Y_\pm = \begin{bmatrix} F_X^\pm - G_X^\pm & 0 \\ 0 & F_P^\pm - G_P^\pm \end{bmatrix}. \quad (\text{A17})$$

The above OPO process includes squeezing operation and the coupling with a squeezed thermal environment. The effective squeezing parameters r_{\pm} can be defined as

$$r_{\pm} \equiv -\frac{1}{2} \ln \frac{G_X^{\pm}}{G_P^{\pm}}, \quad (\text{A18})$$

and how the process is deviated from a unitary squeezing is roughly estimated by looking at the numbers of the thermal photons \bar{n}_{\pm}

$$\bar{n}_{\pm} \equiv G_X^{\pm} G_P^{\pm} - 1. \quad (\text{A19})$$

Figs. 7 and 8 plot r_{\pm} and \bar{n}_{\pm} , respectively, which clearly show that the OPO process with respect to each of Ψ_{\pm} can almost be regarded as a single-mode unitary squeezing.

APPENDIX B: WIGNER FUNCTION OF $\hat{\rho}_+$

The Wigner function of $\hat{\rho}_+$ in Eq. (40), where \hat{S}_+ is applied on the non-Gaussian state $C_{\phi}|\phi\rangle\langle\phi| + C_v|0\rangle\langle 0|$, is derived from its characteristic function. The characteristic function $\chi_+(u, v)$ is calculable with the help of the Bogolubov transformation in Eq. (A4) as

$$\begin{aligned} \chi_+(u, v) &= \text{Tr} \left[\hat{\rho}_+ e^{i(u\hat{X}_+ + v\hat{P}_+)} \right] \\ &= \text{Tr} \left[|\rho_{cw}\rangle\langle\rho_{cw}| e^{i(u\hat{X}_+ + v\hat{P}_+)} \right] \\ &= \langle\rho_{+-}| \langle\mathbf{0}_{\bar{A}}| \left(\hat{S}_A^{\dagger} e^{i(u\hat{X}_+ + v\hat{P}_+)} \hat{S}_A \right) |\rho_{+-}\rangle |\mathbf{0}_{\bar{A}}\rangle \\ &= C_{\phi} \chi_{\phi} (G_X^+ u, G_P^+ v) \\ &\quad \times \chi_0 \left(\sqrt{F_X^+ - G_X^{+2}} u, \sqrt{F_P^+ - G_P^{+2}} v \right) \\ &\quad + C_v \chi_0 \left(\sqrt{F_X^+} u, \sqrt{F_P^+} v \right), \end{aligned} \quad (\text{B1})$$

where

$$\begin{aligned} \chi_{\phi}(u, v) &= \left\{ 1 - \frac{c_0 c_2}{\sqrt{2}} (u^2 - v^2) + \frac{1}{4} (u^2 + v^2)^2 \right\} \\ &\quad \times \exp \left[-\frac{1}{4} (u^2 + v^2) \right], \end{aligned} \quad (\text{B2})$$

$$\chi_0(u, v) = \exp \left[-\frac{1}{4} (u^2 + v^2) \right]. \quad (\text{B3})$$

Then its Fourier transformation gives the Wigner function

$$\begin{aligned} W_+(x, p) &= \frac{1}{\pi \sqrt{F_X^+ F_P^+}} \left[1 + C_{\phi} \left\{ -\frac{3c_2^2}{2} \left(\frac{G_X^{+4}}{F_X^{+2}} + \frac{G_P^{+4}}{F_P^{+2}} \right) + \frac{G_X^{+2}}{F_X^{+2}} \left(\sqrt{2} c_2 (c_0 + \sqrt{2} c_2) - \frac{3c_2^2 G_X^{+2}}{F_X^+} \right) (2x^2 - F_X^+) \right. \right. \\ &\quad - \frac{G_P^{+2}}{F_P^{+2}} \left(\sqrt{2} c_2 (c_0 - \sqrt{2} c_2) + \frac{3c_2^2 G_P^{+2}}{F_P^+} \right) (2p^2 - F_P^+) + \frac{c_2^2 G_X^{+2} G_P^{+2}}{F_X^{+2} F_P^{+2}} (2x^2 - F_X^+) (2p^2 - F_P^+) \\ &\quad \left. \left. + 2c_2^2 \left(\frac{G_X^{+4}}{F_X^{+4}} x^4 + \frac{G_P^{+4}}{F_P^{+4}} p^4 \right) \right\} \right] \exp \left[-\frac{x^2}{F_X^+} - \frac{p^2}{F_P^+} \right]. \end{aligned} \quad (\text{B4})$$

ACKNOWLEDGMENTS

This work was supported by a MEXT Grant-in-Aid for Scientific Research (B) 19340115, and a MEXT Grant-

in-Aid for Young Scientists (B) 19740253.

-
- [1] M. Dakna, T. Anhut, T. Opatrny, L. Knöll, and D.-G. Welsch, *Phys. Rev. A* **55**, 3184 (1997).
- [2] D. E. Browne, J. Eisert, S. Scheel, and M. B. Plenio, *Phys. Rev. A* **67**, 062320 (2003).
- [3] H. Nha and H. J. Carmichael, *Phys. Rev. Lett.* **93**, 020401 (2004).
- [4] R. García-Patrón, J. Fiurásek, N. J. Cerf, J. Wenger, R. Tualle-Brouri, and P. Grangier, *Phys. Rev. Lett.* **93**, 130409 (2004).
- [5] J. Fiurásek, R. García-Patrón, and N. J. Cerf, *Phys. Rev. A* **72**, 033822 (2005).
- [6] M. Takeoka and M. Sasaki, *Phys. Rev. A* **75**, 064302 (2007).
- [7] A. E. B. Nielsen and K. Mølmer, *Phys. Rev. A* **76**, 043840 (2007).
- [8] A. Ourjoumtsev, R. Tualle-Brouri, J. Laurat, and P. Grangier, *Science* **312**, 83 (2006).
- [9] J. S. Neergaard-Nielsen, B. M. Nielsen, C. Hettich, K. Mølmer, E. S. Polzik, *Phys. Rev. Lett.* **97**, 083604 (2006).
- [10] K. Wakui, H. Takahashi, A. Furusawa, and M. Sasaki, *Opt. Express* **15**, 3568 (2007).
- [11] A. Ourjoumtsev, H. Jeong, R. Tualle-Brouri, and P. Grangier, *Nature* **448**, 784 (2007).
- [12] T. C. Ralph, A. Gilchrist, G. J. Milburn, W. J. Munro, and S. Glancy, *Phys. Rev. A* **68**, 042319 (2003).
- [13] M. Sasaki and S. Suzuki, *Phys. Rev. A* **73**, 043807 (2006).
- [14] K. Mølmer, *Phys. Rev. A* **73**, 063804 (2006).
- [15] A. E. B. Nielsen and K. Mølmer, *Phys. Rev. A* **75**, 023806 (2007).
- [16] A. E. B. Nielsen and K. Mølmer, *Phys. Rev. A* **75**, 043801 (2007).
- [17] M. J. Collett and C. W. Gardiner, *Phys. Rev. A* **30**, 1386 (1984).