

CRYPTO EXOTIC OSCILLATOR AND PT SYMMETRY

Subir Ghosh¹

Physics and Applied Mathematics Unit,
Indian Statistical Institute, 203 B. T. Road, Kolkata 700108, India

and

Sujoy Kumar Modak²

S. N. Bose National Centre for Basic Sciences,
JD Block, Sector III, Salt Lake, Kolkata-700098, India.

Abstract:

We study complexified Harmonic Oscillator with a *position dependent mass*, referred to in the present paper as Exotic Oscillator (EO), in arbitrary dimensions. The real space EO has an interesting dynamics: in the equation of motion the full Hamiltonian operator appears in place of the frequency parameter in a Harmonic Oscillator. We reveal some generic features in the constraint structure of these Crypto-gauge invariant models. Lastly we discuss the classical trajectories of complexified EO for real energy, concentrating on the PT -symmetry aspect.

We utilize the formalism developed by Smilga [6] who exploited the "Crypto"-gauge invariance of the complexified models to generate trajectories, in the context of anharmonic oscillators. It was shown in [6] that the dynamics of Crypto-oscillators were same as that of the complex oscillators, for PT -symmetric models. The similar phenomenon can be tested for the Crypto EO model presented here.

¹subir_ghosh2@rediffmail.com

²sujoy@bose.res.in

1. INTRODUCTION

It came as a surprise when the early works [1] showed that certain quantum theories with complex Hamiltonian have real spectra. Subsequently this observation was explained [2, 3] from the fact that these systems enjoyed the combined PT (parity and time reversal) symmetry. The consistency of these models as quantum systems was established [4] by constructing a positive definite inner product that generates unitary evolution. Later on there has been a lot of activity [5] in the study of different aspects of PT -symmetric models.

These models are referred as "Crypto"-Hermitian models by Smilga [6]. In [6] Smilga has also provided an alternative explanation to this behavior (of having real energy eigenvalues for a complex Hamiltonian): Crypto-gauge invariance. However, in an important earlier work by Mostafazadeh [7], it was observed in a general context that the real part of the Hamiltonian can generate the dynamics in a real phase space and that the imaginary part of the Hamiltonian, treated as a constraint, can generate symmetry transformations. The usage of certain class of coordinates in previous works [8] in related problems was also explained in [7].

The idea is to complexify a real Hamiltonian system and subsequently treat the real part of the complex \mathcal{H} as the Hamiltonian H of the enlarged system with twice the original number of degrees of freedom. By virtue of Cauchy-Riemann condition (for \mathcal{H}) and Hamiltonian equations of motion it is possible to show that both the real part H and the imaginary part G of \mathcal{H} (where $\mathcal{H} = H + iG$), are *separately conserved*. Hence G acts as a First Class Constraint (FCC) (see Section 3 for a brief discussion on Dirac's [9] constraint analysis) and in particular $G = 0$ forces the energy to be real. This FCC, present in all such complexified systems, and the gauge symmetry induced by it [9], is termed as Crypto-gauge symmetry [6]. In [6] it has been shown that specific features of some complexified models, (analyzed in terms of real variables), can be matched with their PT -symmetric counterpart in the complex plane [3].

The study of Smilga [6] was generalized to more than one dimension in [10] for the complexified harmonic oscillator. It was shown that this straightforward generalization yielded a richer and qualitatively different constraint structure with both FCC and Second Class Constraint (SCC) [9] being present (see Section 3). The additional constraints, besides $G = 0$, emerge from the demand that like energy, the angular momenta should also have real spectra. An interesting feature was revealed in this study [10]: the number of FCCs and SCCs are such that the degrees of freedom count before and complexification remains unchanged. The present work with a different model - the Complex Exotic Oscillator - (or equivalently Harmonic Oscillator with a position dependent mass), also behaves in this way and it is clear that this feature is generic. Recall that Cauchy-Riemann condition (for \mathcal{H}) and Hamiltonian equations of motion were all that were needed to show that both the real part H and the imaginary part G of \mathcal{H} (where $\mathcal{H} = H + iG$), were separately conserved and one can interpret $G = 0$ as a constraint. In particular it was an FCC and induced the "Crypto"-gauge invariance. However, we still have not been able provide an analogous proof for the rest of the constraint algebra in higher dimensions.

Exotic Oscillator (EO) - the parent model of the present study - has an interesting history. Similar models have been studied before in the guise of a Harmonic Oscillator with a position dependent mass [11, 12, 13]. The model has also been quantized [12]. Our present work deals with the classical setup. We will complexify the EO to obtain the Crypto-EO and show that in higher (three) dimensions the constraint structure is same as that of the Crypto Harmonic

Oscillator [10]. The major part of the paper deals with the Crypto EO obtained from the one dimensional EO. We plot the trajectories of the path for fixed energy. We will find the trajectories of [6] for Crypto Harmonic Oscillator as a special case. However in the present case the paths are much more complicated.

The paper is organized as follows: in Section **2** we describe the EO in arbitrary dimensions. In Section **3** we introduce the Crypto EO by complexification and, after a brief digression of Dirac formulation of constrained systems, discuss the constraint structure of the Crypto EO in three dimensions. Section **4** is devoted to the study of the trajectories for the Crypto EO, constructed from one dimensional EO. Section **5** consists of discussions and conclusions.

2. THE EXOTIC OSCILLATOR

We start by describing the Exotic Oscillator (EO). Consider the Hamiltonian,

$$H = \frac{1}{2}(p^2 - b(xp)^2), \quad (1)$$

where $(xp) = x_i p_i$, $x^2 = x_i x_i$, $p^2 = p_i p_i$; $i = 1, \dots, n$ and we consider the particle mass to be unity. With p_i denoting the conjugate momenta, the canonical Poisson brackets are,

$$\{x_i, p_j\} = \delta_{ij}, \quad \{x_i, x_j\} = \{p_i, p_j\} = 0.$$

From the Hamiltonian equations of motion,

$$\dot{x}_i = \{x_i, H\} = p - b(xp)x_i; \quad \dot{p}_i = \{p_i, H\} = b(xp)p_i, \quad (2)$$

we recover the dynamics:

$$\ddot{x}_i = -2b\left(\frac{1}{2}(p - b(xp)x_i)^2\right)x_i = -(2bH)x_i. \quad (3)$$

The somewhat dramatic name of the system is now clear! It is "Oscillator" because $\ddot{x}_i \sim x_i$ and "Exotic" since the full operator H appears in the place where the frequency parameter resides for a normal Harmonic Oscillator ³.

It is important to note that the above system (1,2) is classically symmetric under the PT -transformations given below:

$$x_i(t) \rightarrow -x_i^*(-t), \quad p_i(t) \rightarrow p_i^*(-t). \quad (4)$$

The above Hamiltonian (1) can be obtained from the following Lagrangian by a conventional Legendre transformation:

$$L = \frac{1}{2}\dot{x}^2 + \frac{b(x\dot{x})^2}{2(1 - bx^2)}, \quad (5)$$

³For the sake of curiosity, we note that in general, for

$$H = \left[\frac{1}{2}(p^2 - b(xp)^2)\right]^\nu \equiv h^\nu \Rightarrow \ddot{x}_i = -(2\nu^2 b h^{(2\nu-1)})x_i$$

for a constant ν .

$$p_i = \frac{\partial L}{\partial \dot{x}_i} = (\delta_{ij} + \frac{bx_i x_j}{1 - bx^2}) \dot{x}_j, \quad (6)$$

$$H = (p\dot{x}) - L = \frac{1}{2}(p^2 - b(xp)^2). \quad (7)$$

To get an idea about the behaviour of the EO let us try a solution,

$$x_i = A_i \text{Sin}(\omega t). \quad (8)$$

Putting it back in (6) we get,

$$p_i = \frac{\omega \text{Cos}(\omega t)}{1 - bA^2 \text{Sin}^2(\omega t)} A_i; \quad A^2 = A_i A_i. \quad (9)$$

Substitute this back in the equation of motion (6). It is a solution only if the following condition holds,

$$bA^2 = 1. \quad (10)$$

For this condition and the solution (8), H in (1) is also time independent,

$$H = \frac{1}{2}\omega^2 A^2 = \frac{\omega^2}{2b}. \quad (11)$$

Hence we have found a classical solution $x_i = A_i \text{Sin}(\omega t)$ that is bounded with the parameter space of A_i being a (hyper-)sphere,

$$A^2 = \frac{1}{b}. \quad (12)$$

However, notice that the phase space motion of EO is unbounded since

$$p_i = \frac{\omega}{\text{Cos}(\omega t)} A_i. \quad (13)$$

Let us perform a quick comparison with the normal HO,

$$H = \frac{1}{2}(p^2 + ax^2), \quad \dot{x}_i = p_i, \quad \dot{p}_i = -ax_i, \quad (14)$$

and in the same way as above, we try a solution

$$x_i = A_i \text{Sin}(\omega t). \quad (15)$$

which leads to the condition

$$\omega^2 = a \quad (16)$$

and the energy becomes $H = \frac{1}{2}\omega^2 A^2$. Hence for HO There is no restriction on amplitude A_i but frequency ω is not arbitrary. It depends on the parameter a present in the Hamiltonian (14). This is in contrast to the EO case (as shown above) where is no restriction on frequency ω but the amplitudes A_i are not arbitrary. It depends on the parameter b present in the Hamiltonian (1). Also, the phase space trajectories are bounded and unbounded for Harmonic Oscillator and EO respectively.

In the present work we will consider some aspects of phase space profile when we complexify the EO. This needs a stabilizing term for the EO and the simplest remedy is to introduce an Harmonic Oscillator potential with strength a ,

$$H = \frac{1}{2}[p^2 - b(xp)^2 + ax^2]. \quad (17)$$

In this case the equation of motion is,

$$\ddot{x}_i = -[2bH + a(1 - 2bx^2)]x_i. \quad (18)$$

Now we can compare the relative effects of of the two interaction terms simply by tuning the parameters a and b . Clearly this extended system also enjoys the PT -symmetry. In the next section we deal with the Crypto extension of EO and classify the constraints.

For the rest of the work, we now restrict to three dimensions with

$$H = \frac{1}{2}[p^2 - b(xp)^2], \quad \{x_i, p_j\} = \delta_{ij}; \quad \{x_i, x_j\} = \{p_i, p_j\} = 0, \quad i = 1, 2, 3. \quad (19)$$

The angular momentum L_i is conserved:

$$L_i = \epsilon_{ijk}x_jp_k, \quad \dot{L}_i = \{L_i, H\} = 0. \quad (20)$$

Note that for the particular solution (8) $L_i = 0$.

3.THE CRYPTO (COMPLEX) EXOTIC OSCILLATOR

We consider the Crypto (or complex) EO in the prescribed way by replacing x_i, p_i by z_i, π_i , in the Hamiltonian (17),

$$H(\pi_i, z_i) = \frac{1}{2}[\pi^2 - b(z\pi)^2 + az^2]. \quad (21)$$

with the identification of z_i, π_i in terms of real canonical degrees of freedom $(x_i, y_i; p_i, q_i)$,

$$z_i = x_i + iy_i; \quad \pi_i = p_i - iq_i. \quad (22)$$

The only non-vanishing Poisson brackets are,

$$\{x_i, p_j\} = \delta_{ij} \quad ; \quad \{y_i, q_j\} = \delta_{ij}. \quad (23)$$

The complex Hamiltonian \mathcal{H} in (17) now reads,

$$\mathcal{H}(\pi_i, z_i) = H(p_i, q_i; x_i, y_i) + iG(p_i, q_i; x_i, y_i) \quad (24)$$

where the real and imaginary parts are respectively,

$$H = \frac{1}{2}[(p^2 - q^2) + a(x^2 - y^2) - b[(xp)^2 + (yq)^2 - (xq)^2 - (yp)^2 + 2(xp)(yq) + 2(xq)(yp)]], \quad (25)$$

$$G = -(pq) + a(xy) - b[(xp)(yp) - (xp)(xq) + (yp)(yq) - (xq)(yq)]. \quad (26)$$

In order to restrict the classical Hamiltonian to the real space, we impose the constraint,

$$G \approx 0, \quad (27)$$

where the weak equality is interpreted in the sense of Dirac [9]. As noted in [6] G (Poisson)commutes with H ,

$$\{G, H\} = 0. \quad (28)$$

Using (23) this can be checked explicitly. This is expected since it was shown [6] to be valid in a model independent way. Following the previous work by one of us [10] we now construct the operator L_i ,

$$L^i = \epsilon^{ijk} z^j \pi^k = L_R^i + iL_G^i, \quad (29)$$

$$L_R^i = \epsilon^{ijk} (x^j p^k + y^j q^k); \quad L_G^i = \epsilon^{ijk} (y^j p^k - x^j q^k). \quad (30)$$

We identify L_R^i as the angular momentum and impose further constraints

$$L_G^i \approx 0 \quad (31)$$

to ensure that the angular momenta, just like energy, are real. The consistency of our definitions is demonstrated by noting,

$$\{L_R^i, H\} = 0$$

that is angular momenta are conserved. Also they preserve the conventional $SO(3)$ algebra,

$$\{L_R^i, L_R^j\} = \epsilon^{ijk} L_R^k.$$

Since we now have more than one constraint in our system, we have to carry out the full constraint analysis, as formulated by Dirac [9]. We briefly list the salient points of Dirac's Hamiltonian analysis of constraints.

First of all one has to obtain the full set of linearly independent constraints $\chi_i \approx 0$ such that the system is stable under time translation: $\{\chi_i, H\} \approx 0$. Secondly one needs to classify the set $\chi_i = (\psi_j, \phi_k)$ such that ψ_j commute with *all* the constraints: $\{\psi_j, \chi_i\} \approx 0$ and ϕ_k 's are non-commuting: $\{\phi_k, \phi_l\} \neq 0$. The set of constraints ψ_j are termed as First Class Constraints (FCC) [9] and ϕ_k 's are termed as Second Class Constraints (SCC). FCC's are associated with gauge symmetries and SCC's are accommodated in the system by modifying the symplectic structure leading to Dirac brackets [9] that replace the canonical Poisson brackets.

Next we carry out the constraint analysis with the four constraints,

$$G \approx 0; \quad L_G^i \approx 0, i = 1, 2, 3.$$

First we check stability of the system of constraints against time translation:

$$\{G, H\} = 0; \quad \{L_G^i, H\} = 0, \quad (32)$$

ensuring that there are no further constraints. Next we find the constraint algebra:

$$\{L_G^i, G\} = 0, \quad (33)$$

$$\{L_G^i, L_G^j\} = -\epsilon^{ijk} L_R^k. \quad (34)$$

From (33) we conclude that G is an FCC but (34) indicates the presence of SCCs in the system. Furthermore we also know that there can not be an odd number of SCCs (three in the present case) and so there has to be another FCC. Taking help from the rest of the algebra

$$\{L_R^i, G\} = 0 \quad ; \quad \{L_G^i, L_R^j\} = \epsilon^{ijk} L_G^k \quad (35)$$

we find that the following combination,

$$W \equiv L_R^i L_G^i \approx 0, \quad (36)$$

constitutes the other SCC. Hence we conclude that the system has two FCCs $G \approx 0$, $W \approx 0$ and two SCCs which we can choose as L_G^1, L_G^2 with the non-vanishing bracket

$$\{L_G^1, L_G^2\} = -L_R^3. \quad (37)$$

There are two generic features that are common both in the one dimensional model [6] and its higher dimensional extensions studied here (see also [10]):

First one is the fact that the constraint that is generated from the reality of angular momentum commutes with H . This property might be a particular feature of the Crypto-oscillator model. Remember that for the constraint G that originated from the complex Hamiltonian, one can exploit the Cauchy-Riemann conditions to show $\{G, H\} = 0$ in a model independent way. It will be interesting to see if our result has a deeper significance [10].

The second point is related to the degrees of freedom count [10]. Notice that in [6] in one dimension, one extra degree of freedom was introduced due to complexification and it can be removed by the single FCC G . This is because the additional two variables (y, q) in phase space can be removed by the FCC G and a suitable gauge choice (the so called unitary gauge). this property is preserved in three dimensions as well but in a more interesting and non-trivial way.

Let us consider the degrees of freedom count in presence of the constraints. In three dimensions we have introduced three additional degrees of freedom and they can be accounted for by the two FCCs (each removing one degree of freedom) and the pair of SCC (the latter together removes one degree of freedom). In this sense the parity is once again restored between the number of degrees of freedom in the original system and the constrained Crypto system [10].

Lastly, it is also interesting to study of equation of motion:

$$\ddot{x}_i = -[a + 2bH - 2abx^2 + 2aby^2]x_i + 2b[G - 2a(xy)]y_i \quad (38)$$

Notice that for $a = 0$, that is without the Harmonic Oscillator potential term we obtain,

$$\ddot{x}_i = -[2bH]x_i + 2b[G]y_i.$$

This means that even for the Crypto EO, the characteristic feature of the dynamics is preserved on the constraint surface where $G = 0$.

4. TRAJECTORIES FOR ONE-DIMENSIONAL CRYPTO EXOTIC OSCILLATOR

We study the Crypto extension of EO (17) in one dimension,

$$H = \frac{1}{2}p^2(1 - bx^2) + \frac{a}{2}x^2. \quad (39)$$

Obviously the system is considerably simplified. With the canonical Poisson brackets, $\{x, p\} = 1$ we compute the equation of motion:

$$\ddot{x} = -2[bH - a(bx^2 - \frac{1}{2})]x. \quad (40)$$

Obviously for $b = 0$ we recover the one dimensional HO and with $a = 0$ the dynamics is that of the one dimensional EO given by

$$\ddot{x} = -[2bH]x$$

We now extend the system to complex domain,

$$\mathcal{H} = \frac{1}{2}\pi^2(1 - bz^2) + \frac{a}{2}z^2 \quad (41)$$

$$z = x + iy ; \quad \pi = p - iq, \quad (42)$$

with the only non-zero brackets,

$$\{x, p\} = \{y, q\} = 1. \quad (43)$$

Once again H is broken into real and imaginary parts,

$$\begin{aligned} \mathcal{H} &= \frac{1}{2}(p - iq)^2[1 - b(x + iy)^2] + \frac{a}{2}(x + iy)^2 \\ &= \frac{1}{2} [a(x^2 - y^2) + (p^2 - q^2)[1 - b(x^2 - y^2)] - 4bxy pq] + i [xy[a - b(p^2 - q^2)] - pq[1 - b(x^2 - y^2)]] \\ &\equiv H(x, p, y, q) + iG(x, p, y, q). \end{aligned} \quad (44)$$

Thus the real part H becomes the Hamiltonian

$$\mathcal{H} = \frac{1}{2} [a(x^2 - y^2) + (p^2 - q^2)[1 - b(x^2 - y^2)] - 4bxy pq], \quad (45)$$

and G - the imaginary part of \mathcal{H} becomes the constraint,

$$G = 0. \quad (46)$$

In one dimension G is the only FCC since $\{G, H\} = 0$.

The Hamiltonian equations of motion are,

$$\dot{x} = p[1 - b(x^2 - y^2)] - 2bxyq, \quad (47)$$

$$\dot{p} = bx(p^2 - q^2) + 2bypq - ax, \quad (48)$$

$$\dot{y} = -q[1 - b(x^2 - y^2)] - 2bxyp, \quad (49)$$

$$\dot{q} = -by(p^2 - q^2) + 2bpxq + ay. \quad (50)$$

For constant energy $H = E$ the variables (x, p, y, q) , must satisfy the conditions,

$$E = \frac{1}{2} [a(x^2 - y^2) + (p^2 - q^2)[1 - b(x^2 - y^2)] - 4bxyqp], \quad (51)$$

$$xy[a - b(p^2 - q^2)] - pq[1 - b(x^2 - y^2)] = 0. \quad (52)$$

These will help us in determining consistent boundary conditions when we compute and sketch the trajectories (albeit numerically).

We now discuss some features of the trajectories. From the richness and variety of the profiles shown below, it is clear that a more thorough and systematic analysis needs to be done than what we have presented here.

In the energy expression (51) there are three parameters E , a and b . Another free parameter c will appear from our choice of boundary conditions. Throughout our analysis we will keep $|E| = \frac{1}{2}$ (since both positive and negative values of energy can be considered) and put $a = 1$ (that is strength of the stabilizing harmonic potential is fixed to unity). This will allow us to vary b (the strength of the exotic term $(xp)^2$) and c , the parameter that comes from fixing the boundary conditions, mentioned above.

In **Figure 1.1** and **Figure 1.2**, we study the phase space trajectories (x in abscissa and p in ordinate) of the *real* exotic oscillator (39),

$$H = \frac{1}{2}p^2(1 - bx^2) + \frac{a}{2}x^2$$

for positive and negative values of b respectively. For our choice of parameters, b has an upper bound $+1$ for positive values but there is no restriction on b for negative values. $b = 0$ denotes the normal ellipse and b is varied within $1 > b > 0$ in **Figure 1.1**, and in **Figure 1.2** b goes up to $b = -1500$.

Now we come to rest of the figures where the Crypto version of the Exotic Oscillator is studied. From comparing the works of [6] (that deals with Crypto-models) and [3] (that studies PT -symmetric models, it is clear that in our case the nature of the trajectories, as far as PT -symmetry is concerned, can be ascertained from the geometrical symmetry of the profiles. In all the figures we plot x in abscissa and y in ordinate following our convention $z = x + iy$. Hence, similar to [3] where real and complex parts of the coordinate were plotted in abscissa and ordinate respectively, *trajectories that are PT -symmetric will be invariant under reflection about the ordinate*. Note that this is same as the trajectories studied in [6] as well. In **Figure 2.1** we first reproduce the simple nested ellipses for the normal Crypto-oscillator ($b = 0$) and then give similar examples in **Figure 2.2** for Crypto EO for positive non-zero b and $E = +\frac{1}{2}$. Trajectory for $E = +\frac{1}{2}$ and negative b is depicted in **Figures 3**. In **Figures 4** we study similar example for $E = -\frac{1}{2}$. In **Figures (5.1 to 5.3)** we show the effect of changing b for a fixed

initial condition and $E = +\frac{1}{2}$. **Figures (6.1 to 6.3)** give the results for different b 's and $E = -\frac{1}{2}$. The generic form of the initial condition for these trajectories is for positive and negative energies are

$$x = c, p = 0, y = 0, q = \sqrt{\frac{c^2 - 1}{1 - bc^2}},$$

$$x = c, p = 0, y = 0, q = \sqrt{\frac{c^2 + 1}{1 - bc^2}},$$

respectively, where c is the free parameter we choose. All the trajectories of this species are PT -symmetric closed orbits. It is curious to note that the trajectory for $b = 0.2499$ in **Figure 5.2** is identical to the limiting double cardioid depicted in [3] for $H = p^2 + x^2(ix)^\epsilon$, $\epsilon = 2$.

In **Figures (7.1 to 7.6)** we chose a structurally different initial condition of the form

$$x = 1, p = c, y = 1, q = \sqrt{c^2 + \frac{1 + 4b}{1 + 4b^2}},$$

$$x = 1, p = c, y = 1, q = \sqrt{\frac{b - 1}{c(4b^2 - 1)}},$$

for positive and negative energies respectively. We notice that the orbits are not PT -symmetric and not closed as well. In some cases they oscillate between the turning points.

5.DISCUSSIONS

We have studied the complexified (or Crypto extension) of a Harmonic Oscillator with a specific form of position dependent mass. We have referred to it as Crypto Exotic Oscillato. Our motivation for studying this particular form of effective-mass oscillator (in real space) is due to the fact that it is a PT -symmetric model (in the classical sense). It has an interesting form of Hamiltonian dynamics and furthermore is exactly solvable as a quantum system.

As an open issue, it will be interesting to see if the trajectories presented here are reproduced for the same model treated as a complex system along the lines of [3]. We conclude with the hope that other oscillator models, also relevant in the context of PT -symmetric quantum mechanics [13], will be analyzed exploiting the Crypto-formalism.

6.ACKNOWLEDGMENT

One of the authors (SKM) thanks the Council of Scientific and Industrial Research (CSIR), Government of India, for financial support.

References

- [1] D.C.McGarvey, *J.Math.Anal.Appl.* 4 (1962) 366; M.G.Gasymov, *Funct.Anal.Appl.* 14 (1980) 11; E.Calicetti, S.Graffi and M.Maioli, *Comm.Math.Phys.* 75 (1980) 51; A.Andrianov, *Ann.Phys.* 140 (1982) 82; T.Hollowood, *Nucl.Phys.* B384 (1992) 523; F.G.Scholtz, H.B.Geyer and F.J.H.Hahne, *Ann.Phys.* 213 (1992) 74; for a recent discussion see T.Curtright and L.Mezincescu, arXiv:quant-phys/0507015.
- [2] C.M.Bender and S.Boettcher, *Phys.Rev.Lett.* 80 (1998) 5243, for a recent review see C.M.Bender, hep-th/0703096.
- [3] C.M.Bender, S.Boettcher P.N.Meisinger, *J.Math.Phys.* 40 (1999) 2201.
- [4] A.Mostafazadeh, *J.Math.Phys.* 43 (2002) 205; *ibid* 2814; *ibid* 3944.
- [5] B.Bagchi and C.Quesne, *Phys.Lett.* A301 (2002)173; A.Mostafazadeh, *J.Math.Phys.* 43 (2002) 205; B.Bagchi and R.Roy Choudhury, *J.Phys.A:Math.Gen.* 33 (2000)L1; A.Sinha, G.Levai and P.Roy, *Phy.Lett.* A322 (2004) 78; M.Zonjil, *J.Math.Phys.* 46 (2005) 062109; F.G.Scholtz and H.B.Geyer, *J.Phys.A:Math.Gen.* 39 (2006)10189; R.Banerjee and P.Mukherjee, *J.Phys.A35* (2002) 5591 (arXiv:quant-ph/0108055).
- [6] A.V.Smilga, arXiv:0706.4064 (to appear in *J.Phys. A*).
- [7] A.Mostafazadeh, *Phys.Lett.* A357 (2006) 177.
- [8] A.L.Xavier Jr. and M.A.M. de Aguiar, *Ann.Phys. (NY)* 252 (1996)458; R.S.Kauschal and H.J.Kosch, *Phys.Lett.* A276 (2000)47; R.S.Kauschal and S.Singh, *Ann.Phys. (NY)* 288 (2001)253.
- [9] P.A.M.Dirac, *Lectures on Quantum Mechanics*, Yeshiva University Press, New York, 1964.
- [10] S.Ghosh and B.R.Majhi, *J.Phys. A* XX (arXiv:0709.4325).
- [11] P.M.Mathews and M.Lakshmanan, *Quart.Appl.Math.* 32 (1974) 215.
- [12] J.F.Carinena, M.F.Ranada, M.Santander and M.Senthilvelan, *Nonlinearity* 17 (2004) 1941 (arXiv:math-ph/0406002); J.F.Carinena, M.F.Ranada and M.Santander, arXiv:math-ph/0501106, arXiv:math-ph/0505028.
- [13] B.Roy and P.Roy, *J.Phys.A* 38 (2005) 11019; C.Tezcan and R.Sever, arXiv:0709.2789.

Figure1.1

Distortion of the (x,p) phase diagram $1 > b > 0$

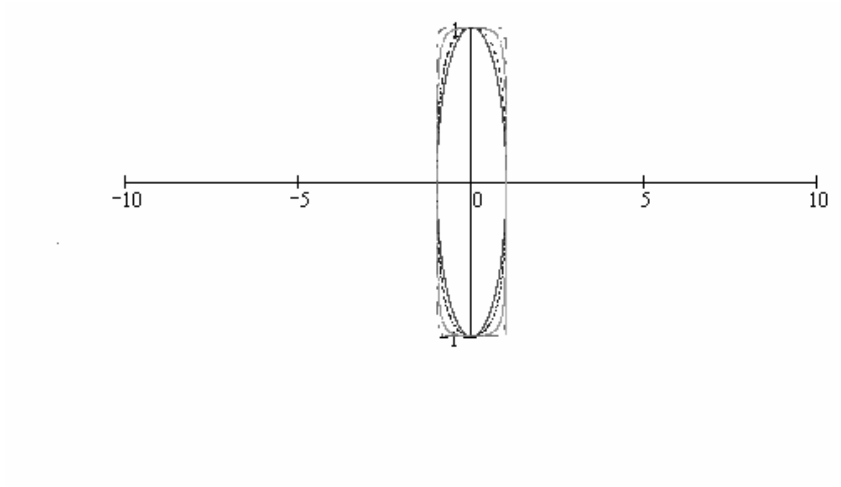

Figure1.2
Distortion of the (x,p) phase diagram for negative values of b

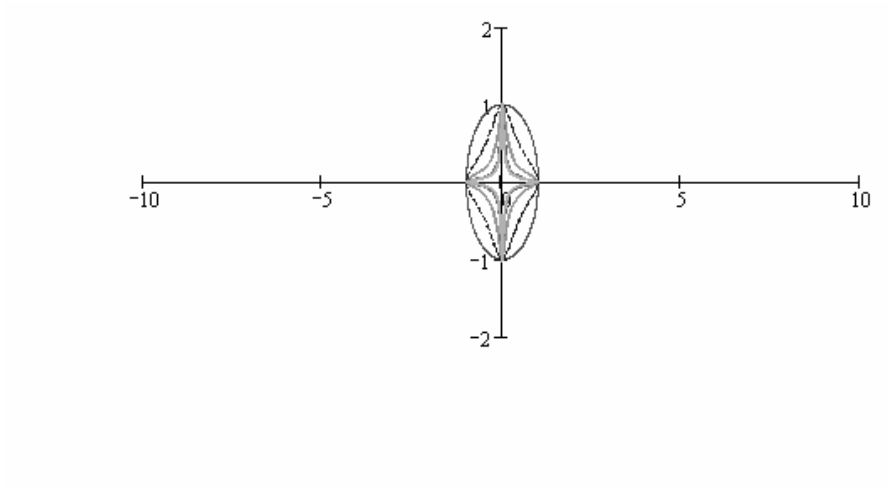

Figure 2.1
(Positive Energy $E = \frac{1}{2}$, $b=0$)

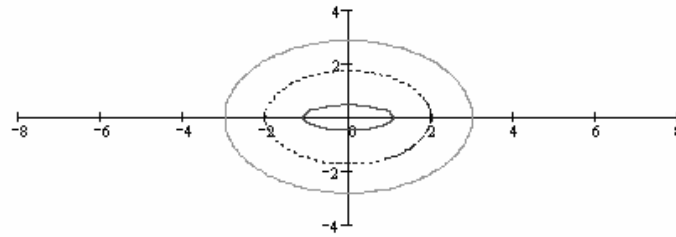

Figure 2.2
($E=1/2$, $b=0.8$)

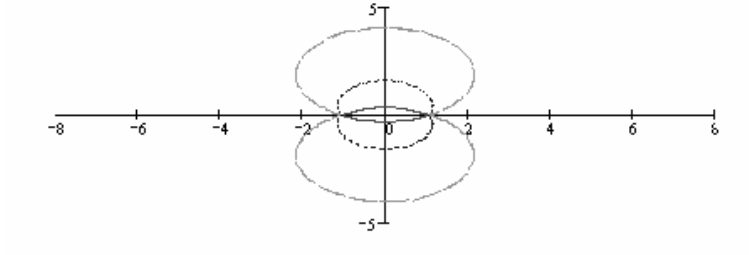

Figure 3
($E=0.5$, $b=-10.0$)

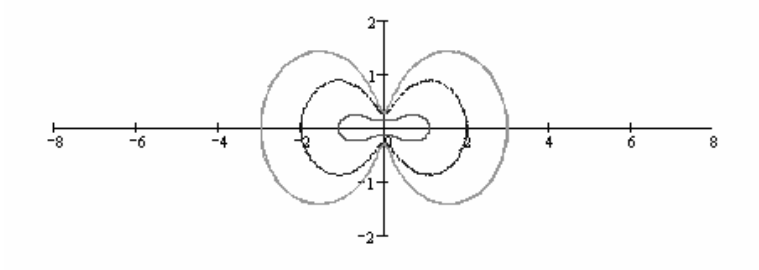

Figure 4
($E = -0.5$, $b = 5$)

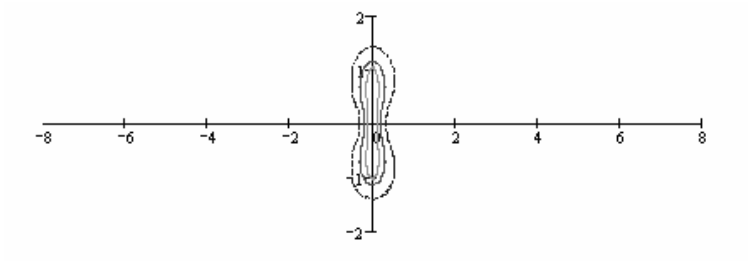

Figure 5.1
($E = 0.5, C=2, b= 0.2$)

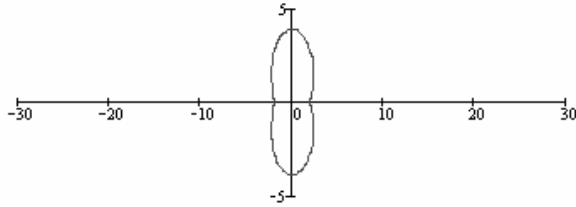

Figure 5.2
($E=0.5$, $C=2$, $b=0.2499$)

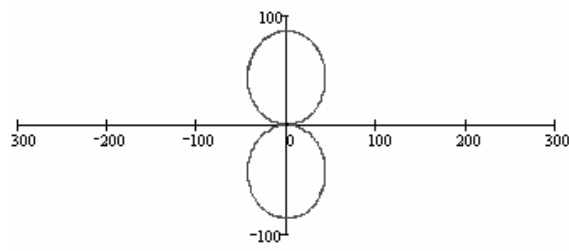

Figure 5.3
($E=0.5$, $C=2$, $b=-10000$)

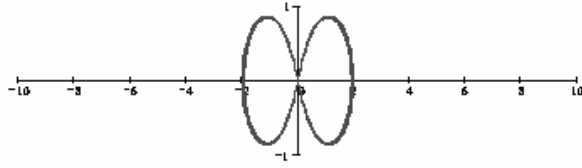

Figure 6.1
($E = -0.5$, $C = 2$, $b = 0.2$)

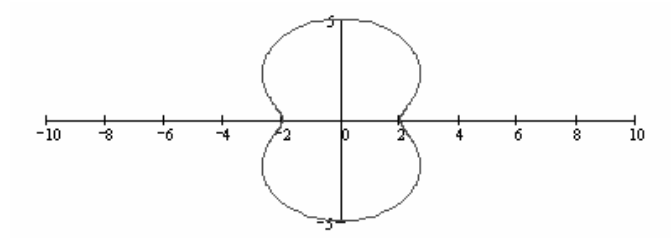

Figure 6.2
($E = -0.5$, $C = 2$, $b = 0.2499$)

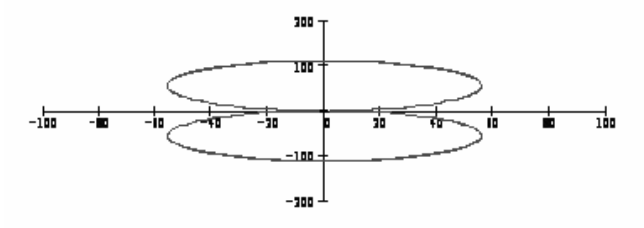

Figure 6.3
($E = -0.5$, $C = 2$, $b = -10000$)

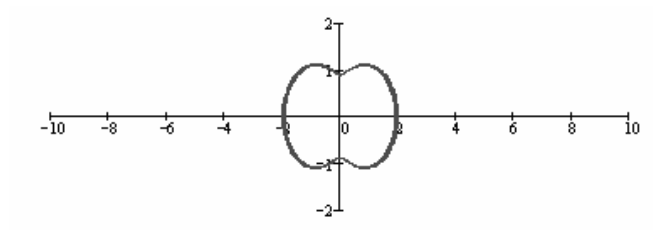

Figure 7.1
($E = +0.5$, $C = 0.06$, $b = 0.5$)

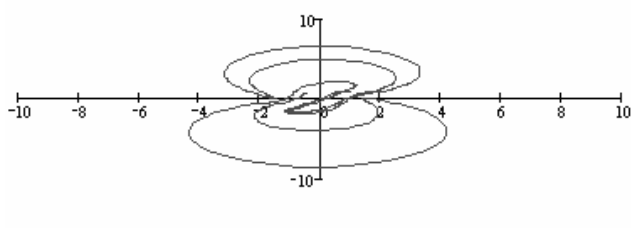

Figure 7.2
($E = +0.5$, $C = 0.06$, $b = 1$)

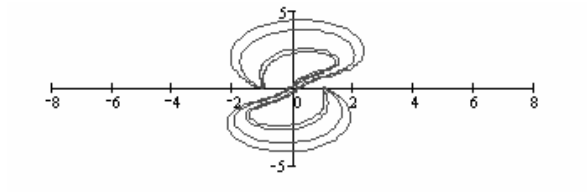

Figure 7.3
($E = +0.5$, $C = 0.07$, $b = 1$)

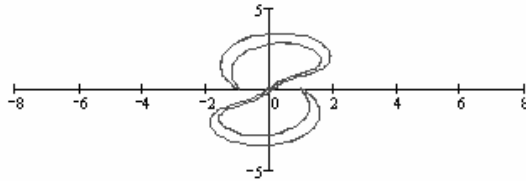

Figure 7.4
($E = -0.5$, $C = -0.09$, $b = -0.09$)

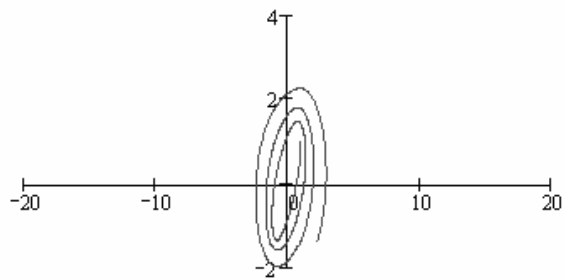

Figure7.5
($E = -0.5$, $C = 0.21$, $b = -1.0$)

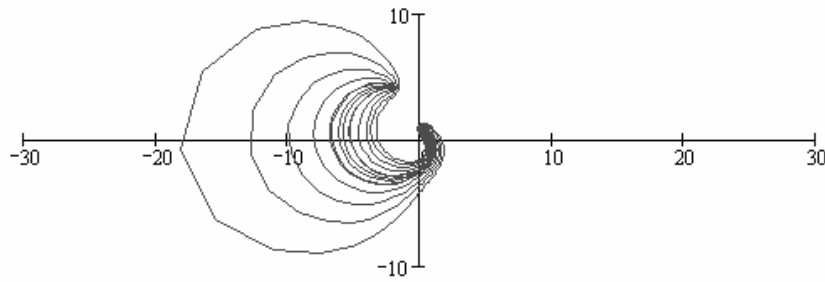

Figure7.6
($E = -0.5$, $C = 0.21$, $b = -5.0$)

