

Particle-hole symmetry and the dirty boson problem

Peter B. Weichman¹ and Ranjan Mukhopadhyay²

¹*BAE Systems, Advanced Information Technologies,*

6 New England Executive Park, Burlington, MA 01803

²*Department of Physics, Clark University, Worcester, MA 01610*

(Dated: November 8, 2018)

We study the role of particle-hole symmetry on the universality class of various quantum phase transitions corresponding to the onset of superfluidity at zero temperature of bosons in a quenched random medium. To obtain a model with an exact particle-hole symmetry it is necessary to use the Josephson junction array, or quantum rotor, Hamiltonian, which may include disorder in both the site energies and the Josephson couplings between wavefunction phase operators at different sites. The functional integral formulation of this problem in d spatial dimensions yields a $(d + 1)$ -dimensional classical XY-model with extended disorder, constant along the extra imaginary time dimension—the so-called *random rod problem*. Particle-hole symmetry may then be broken by adding nonzero site energies, which may be uniform or site-dependent. We may distinguish three cases: (i) exact particle-hole symmetry, in which the site energies all vanish, (ii) *statistical* particle-hole symmetry in which the site energy distribution is symmetric about zero, vanishing on average, and (iii) complete absence of particle-hole symmetry in which the distribution is generic. We explore in each case the nature of the excitations in the non-superfluid Mott insulating and Bose glass phases. We show, in particular, that, since the boundary of the Mott phase can be derived exactly in terms of that for the pure, non-disordered system, that there can be no direct Mott-superfluid transition. Recent Monte Carlo data to the contrary can be explained in terms of rare region effects that are inaccessible to finite systems. We find also that the Bose glass compressibility, which has the interpretation of a *temporal* spin stiffness or superfluid density, is positive in cases (ii) and (iii), but that it vanishes with an essential singularity as full particle-hole symmetry is restored. We then focus on the critical point and discuss the relevance of type (ii) particle-hole symmetry breaking perturbations to the random rod critical behavior, identifying a nontrivial crossover exponent. This exponent cannot be calculated exactly but is argued to be positive and the perturbation therefore relevant. We argue next that a perturbation of type (iii) is irrelevant to the resulting type (ii) critical behavior: the statistical symmetry is *restored* on large scales close to the critical point, and case (ii) therefore describes the dirty boson fixed point. Using various duality transformations we verify all of these ideas in one dimension. To study higher dimensions we attempt, with partial success, to generalize the Dorogovtsev-Cardy-Boyanovsky double epsilon expansion technique to this problem. We find that when the dimension of time $\epsilon_\tau < \epsilon_\tau^c \simeq \frac{8}{29}$ is sufficiently small a type (ii) symmetry breaking perturbation is *irrelevant*, but that for sufficiently large $\epsilon_\tau > \epsilon_\tau^c$ particle-hole asymmetry is a *relevant* perturbation and a new stable fixed point appears. Furthermore, for $\epsilon_\tau > \epsilon_\tau^{c2} \approx \frac{2}{3}$, this fixed point is stable also to perturbations of type (iii): at $\epsilon = \epsilon_\tau^{c2}$ the generic type (iii) fixed point *merges* with the new fixed point. We speculate, therefore, that this new fixed point becomes the dirty boson fixed point when $\epsilon_\tau = 1$. We point out, however, that $\epsilon_\tau = 1$ may be quite special. Thus, although the qualitative renormalization group flow picture the double epsilon expansion technique provides is quite compelling, one should remain wary of applying it quantitatively to the dirty boson problem.

PACS numbers: 64.60.Fr, 67.40.-w, 72.15.Rn, 74.78.-w,

I. INTRODUCTION

Quantum phase transitions at zero temperature are driven entirely by quantum fluctuations in the ground state wavefunction. In many cases a crucial requirement is the presence of quenched disorder. Examples include random magnets with various kinds of site, bond,¹ or field² disorder; the transitions between plateaux in the two-dimensional quantized Hall effects;³ metal-insulator,⁴ metal-superconductor, and superconductor-insulator⁵ transitions in disordered electronic systems; and the onset of superfluidity of ⁴He in porous media.⁶

In this article, we will study the quantum transitions between the superfluid (SF), the localized Bose

glass (BG), and Mott insulating (MI) phases, motivated mainly by the problem of superfluidity of ⁴He in porous media. However, as is often the case in the study of critical phenomena, the universality class of this transition, or a straightforward generalization of it, also includes other physical phenomena, such as many aspects of quantum magnetism and superconductivity.

There have been a number of approaches to studying the SF-BG transition: mean field theories,⁷ strong coupling,⁸ large N ,⁹ real space methods,¹⁰ quantum Monte Carlo calculations,^{11,12,13,14} double dimensional-ity epsilon-expansions,^{15,16,17} real space renormalization group in the limit of strong disorder in one dimension,¹⁸ renormalization group in fixed dimension,¹⁹ and in $1 + \epsilon$

dimensions.²⁰ However, none of the above methods provide a controlled analytical approach to the critical point for $d > 1$.

A satisfactory dimensionality expansion about the upper critical dimension for the superfluid to Bose glass transition (analogous to the epsilon expansion about $d = 4$ for classical spin problems) does not appear to exist. In particular, we previously found¹⁷ that the approach based on a simultaneous expansion in both the dimension, ϵ_τ , of imaginary time (physically equal to unity), and the deviation, $\epsilon = 4 - D$, of the total space-time dimensionality, $D = d + \epsilon_\tau$, from four¹⁵ does not yield a perturbatively accessible renormalization group fixed point, and therefore does not produce a systematic expansion for the dirty boson problem. Nevertheless it does give one a fairly detailed picture of the renormalization group fixed point and the flow structures, and produce an uncontrolled expansion for the dirty boson problem, though further work needs to be done in order to understand the analytic structure of the theory as a function of ϵ_τ . Therefore, in spite of its poor convergence, the double dimensionality expansion still appears to provide the most flexible analytic approach to the study of the SF–BG transition, including insight into the symmetries of the fixed point. As detailed below, attention to the role of particle-hole symmetry, especially, is essential to generating correct RG flow structures. In three (and higher) dimensions, the double dimensionality expansion is the only method that has been able, with partial success, to access the critical fixed point and obtain critical exponents.¹⁷

A. Particle-hole symmetry

As stated, it will transpire that an essential ingredient that is necessary in order to correctly understand the physics of the SF–BG transition is an extra “hidden” symmetry, which we call *particle-hole* symmetry, that is present at the critical point, but not necessarily away from it. To make this notion precise, we compare the following two lattice models of superfluidity: the first is the usual lattice boson Hamiltonian,

$$\begin{aligned} \mathcal{H}_B = & -\frac{1}{2} \sum_{i,j} J_{ij} [a_i^\dagger a_j + a_j^\dagger a_i] + \sum_i (\varepsilon_i - \mu) \hat{n}_i \\ & + \frac{1}{2} \sum_{i,j} V_{ij} \hat{n}_i (\hat{n}_j - \delta_{ij}), \end{aligned} \quad (1.1)$$

where $J_{ij} = J_{ji}$ is the hopping matrix element between sites i and j , which we will allow to have a random component; μ is the chemical potential whose zero we fix by choosing the diagonal components, J_{ii} , of J_{ij} in such a way that $\sum_j J_{ij} = 0$ for each i ; ε_i is a random site energy with *mean zero*; $V_{ij} = V_{ji}$ is the pair interaction potential, assumed for simplicity to be *nonrandom* and translation invariant; the only nonzero commutation re-

lations are $[a_i, a_j^\dagger] = \delta_{ij}$, and $\hat{n}_i \equiv a_i^\dagger a_i$ is the number operator at site i .

The second model is the Josephson junction array Hamiltonian,

$$\begin{aligned} \mathcal{H}_J = & - \sum_{i,j} \tilde{J}_{ij} \cos(\hat{\phi}_i - \hat{\phi}_j) + \sum_i (\tilde{\varepsilon}_i - \tilde{\mu}) \tilde{n}_i \\ & + \frac{1}{2} \sum_{i,j} U_{ij} \tilde{n}_i \tilde{n}_j, \end{aligned} \quad (1.2)$$

with analogous parameters, but now the commutation relations $[\hat{\phi}_i, \tilde{n}_j] = i\delta_{ij}$. These two Hamiltonians are, in fact, very closely related. It is easy to check that if N_0 is any positive integer then

$$\begin{aligned} a_i^\dagger &= (N_0 + \tilde{n}_i)^{\frac{1}{2}} e^{i\hat{\phi}_i} \\ a_i &= e^{-i\hat{\phi}_i} (N_0 + \tilde{n}_i)^{\frac{1}{2}} \end{aligned} \quad (1.3)$$

satisfy the correct Bose commutation relations, and we identify $\hat{n}_i = N_0 + \tilde{n}_i$. Note, however, that the commutation relations between $\hat{\phi}_i$ and \tilde{n}_i permit \tilde{n}_i to have any integer eigenvalue, positive or negative, whereas the eigenvalues of \hat{n}_i must be non-negative. Therefore it is only when N_0 is large, and the fluctuations in \tilde{n}_i are small compared to N_0 , that \mathcal{H}_J and \mathcal{H}_B may be compared quantitatively: inside the hopping term we may approximate $a_i^\dagger \approx N_0^{\frac{1}{2}} e^{i\hat{\phi}_i}$, $a_i \approx N_0^{\frac{1}{2}} e^{-i\hat{\phi}_i}$ and make the identifications

$$\tilde{J}_{ij} = N_0 J_{ij}; \quad U_{ij} = V_{ij}; \quad \tilde{\varepsilon}_i = \varepsilon_i; \quad \tilde{\mu} = \mu - N_0 \hat{V}_0 + \frac{1}{2} V_0, \quad (1.4)$$

where $V_0 = V_{ii}$ and $\hat{V}_0 = \sum_j V_{ij}$, and there exists an overall additive constant term $E_0 N = (\frac{1}{2} N_0 \hat{V}_0 - \frac{1}{2} V_0 - \mu) N_0 N$, where N is the number of lattice sites.

Despite this asymptotic equivalence at large N_0 , the Josephson Hamiltonian (1.2) has an exact discrete symmetry which the boson Hamiltonian lacks. Thus the constant shift, $\tilde{n}'_i = \tilde{n}_i + n_0$, where n_0 is any integer, has no effect on the commutation relations or the eigenvalue spectrum of the \tilde{n}_i . The Hamiltonian correspondingly transforms as

$$\mathcal{H}_J\{\tilde{n}'_i\} = \mathcal{H}_J\{\tilde{n}_i\} + n_0 \hat{U}_0 \sum_i \tilde{n}_i + N \varepsilon^0(n_0, \tilde{\mu}), \quad (1.5)$$

where $\varepsilon^0(n_0, \tilde{\mu}) = n_0(\frac{1}{2} n_0 \hat{U}_0 - \tilde{\mu})$, and $\hat{U}_0 = \sum_j U_{ij}$. The free energy density, $f_J = -\frac{1}{\beta N} \ln [\text{tr} e^{-\beta \mathcal{H}_J}]$, where $\beta = 1/k_B T$, transforms as

$$f_J(\tilde{\mu}) = f_J(\tilde{\mu} - n_0 \hat{U}_0) + \varepsilon^0(n_0, \tilde{\mu}) \quad (1.6)$$

independent of the \tilde{J}_{ij} and $\tilde{\varepsilon}_i$. This implies that the only effect of a shift $n_0 \hat{U}_0$ in the chemical potential is a trivial additive term in the free energy which is linear in $\tilde{\mu}$. This term serves only to increase the overall density, $n = -\frac{\partial f_J}{\partial \tilde{\mu}}$, by n_0 but otherwise has no effect whatsoever

on the phase diagram, which therefore will be precisely periodic in $\tilde{\mu}$, with period \tilde{U}_0 .

Consider next the transformation $\tilde{n}'_i = -\tilde{n}_i$, $\hat{\phi}'_i = -\hat{\phi}_i$. The Hamiltonian transforms as

$$\mathcal{H}_J[\tilde{n}'_i, \hat{\phi}'_i, \tilde{\varepsilon}_i - \tilde{\mu}] = \mathcal{H}_J[\tilde{n}_i, \hat{\phi}_i, -(\tilde{\varepsilon}_i - \tilde{\mu})], \quad (1.7)$$

so that

$$f_J(\tilde{\mu}, \{\tilde{\varepsilon}_i\}) = f_J(-\tilde{\mu}, \{-\tilde{\varepsilon}_i\}). \quad (1.8)$$

Combining the two symmetries (1.6) and (1.8) we see that if all $\tilde{\varepsilon}_i = 0$, then for $\tilde{\mu} = \tilde{\mu}_k \equiv \frac{1}{2}k\tilde{U}_0$, where k is any integer, the Hamiltonian possesses a special *particle-hole symmetry*, namely invariance under the transformation $\tilde{n}'_i = k - \tilde{n}_i$, $\hat{\phi}'_i = -\hat{\phi}_i$. At $\tilde{\mu} = \tilde{\mu}_k$ the density is precisely $\frac{1}{2}k$ per site, and the thermodynamics is symmetric under addition and removal of particles (the removal of particles being synonymous with the addition of holes). If the ε_i are nonzero, but have a symmetric probability distribution, $p\{\tilde{\varepsilon}_i\} = p\{-\tilde{\varepsilon}_i\}$, then the exact particle-hole symmetry is lost, but there still exists a *statistical* particle-hole symmetry at the same special values $\tilde{\mu}_k$ of $\tilde{\mu}$: self averaging will ensure that $f_J(\tilde{\mu}_k, \{\tilde{\varepsilon}_i\}) = f_J(\tilde{\mu}_k, \{-\tilde{\varepsilon}_i\})$. The lattice boson Hamiltonian (1.1) clearly can never possess either form of particle-hole symmetry since the hopping term mixes the number and phase in an inextricable fashion.

B. Phase diagrams

In Fig. 1 we sketch zero temperature phase diagrams, with and without various types of disorder, in the $\tilde{\mu}$ - J_0 plane, where J_0 is a measure of the overall strength of the hopping matrix (e.g., $J_0 = \frac{1}{N} \sum_{i \neq j} \tilde{J}_{ij}$), in the simplest case of onsite repulsion only:²¹ $U_{ij} = U_0 \delta_{ij}$. This phase diagram has been discussed in detail previously^{6,11} for the lattice boson Hamiltonian, \mathcal{H}_B . Here we emphasize the features unique to \mathcal{H}_J , namely the periodicity in $\tilde{\mu}$, and the special points $\tilde{\mu}_k$ corresponding to local extrema in the phase boundaries.

1. Phase diagram for the pure system

In Fig. 1(a) we show the phase diagram in the absence of all disorder. For $J_{ij} \equiv 0$ the site occupancies are good quantum numbers and each site has precisely n_0 particles for $n_0 - \frac{1}{2} < \tilde{\mu}/U_0 < n_0 + \frac{1}{2}$. The points $\tilde{\mu}/U_0 = k + \frac{1}{2}$ for integer k are 2^N fold degenerate with either k or $k + 1$ particles placed independently on each site. For $J_{ij} > 0$ communication between sites occurs and the effective wavefunction for each particle spreads to neighboring sites (see Fig. 2). We denote by $\xi(J_0)$ (to be defined carefully later) the range of this spread. One can show within perturbation theory,⁶ however, that for

sufficiently small, short ranged J_{ij} , there is a finite energy gap for addition of particles, and the overall density remains *fixed* at n_0 for a finite range of $\tilde{\mu}$.

Consider first $\tilde{\mu} \neq 0$. Then only at a critical value $J_{0,c}(\tilde{\mu})$ of J_0 does the system favor adding extra particles (or holes). Equivalently, for a given J_0 there is an interval $\tilde{\mu}_-(J_0) < \tilde{\mu} < \tilde{\mu}_+(J_0)$ of fixed density n_0 . These extra particles may be thought of as a dilute Bose fluid moving atop the essentially inert background density, n_0 (see Fig. 2). The physics is identical to that of a dilute Bose gas in the continuum, and is well described by the Bogoliubov model.²² From this one concludes that the system immediately becomes superfluid (recall that we assume $T = 0$) with a superfluid density $\rho_s \sim n - n_0 \sim J_0 - J_{0,c}$, and an order parameter $\psi_0 \equiv \langle e^{i\hat{\phi}_i} \rangle \sim (n - n_0)^{\frac{1}{2}} \sim (J - J_{0,c})^{\frac{1}{2}}$. The characteristic length in this phase is $\xi_0 = J_0^{\frac{1}{2}} / [\tilde{\mu} - \tilde{\mu}_{\pm}(J_0)]^{\frac{1}{2}} \sim (n - n_0)^{-\frac{1}{2}} \sim (J_0 - J_{0,c})^{-\frac{1}{2}}$ and represents the distance between “uncondensed” particles: $n - n_0 - |\psi_0|^2 \sim \xi_0^{-d}$. This zero-temperature superfluid onset transition is therefore trivial, in the sense that all exponents are mean-field-like. In fact, historically this onset was never really viewed as an example of a phase transition.

Furthermore, although all quantities vary continuously as J_0 decreases toward $J_{0,c}$, the actual onset point is entirely noncritical. Thus, for a given value of J_0 within a Mott lobe, the interval $\tilde{\mu}_-(J_0) < \tilde{\mu} < \tilde{\mu}_+(J_0)$ represents a *single* unique (incompressible) thermodynamic state. Incompressibility implies that for the given (integer) density, the value of the chemical potential is ambiguous. One might just as well set $\tilde{\mu} = n_0 U_0$, its value at the center of the lobe. The correlation length, $\xi(\tilde{\mu}, J_0)$, is *independent* of $\tilde{\mu}$, and remains perfectly finite in the Mott phase at $J_{0,c}(\tilde{\mu})$. In this sense the transition has some elements of a first order phase transition.

The more important transition is the one occurring at fixed density, $n = n_0$, at $\tilde{\mu} = n_0 U_0$ through the tip of the Mott lobe at $J_{0,c}(0)$. At this transition $\xi(J_0) \sim (J_{0,c} - J_0)^{-\nu_{\text{pure}}}$ diverges continuously with a characteristic exponent, ν_{pure} . One may show (see Ref. 6 and below) that the transition is precisely in the universality class of the *classical* $(d + 1)$ -dimensional XY-model. What distinguishes this transition from the previous ones is precisely particle-hole symmetry: superfluidity is achieved not by adding a small density of particles or holes atop the inert background, but by the buildup of superfluid fluctuations *within* the background, to the point where particles and holes *simultaneously* overcome the potential barrier U_0 and hop coherently without resistance. The exponent ν_{pure} exhibits itself in the phase diagram as well: a scaling argument shows that the shape of the Mott lobe is singular near its tip,⁶ $\mu_{\pm}(J_0) \sim \pm(J_{0,c} - J_0)^{\nu_{\text{pure}}}$. In $d = 2$, $\nu_{\text{pure}} \simeq \frac{2}{3}$, while in $d \geq 3$, $\nu_{\text{pure}} = \frac{1}{2}$. This will be discussed in a more general scaling context in Sec. IV B.

We have already observed that the lattice boson Hamiltonian (1.1) never has an exact particle-hole symmetry.

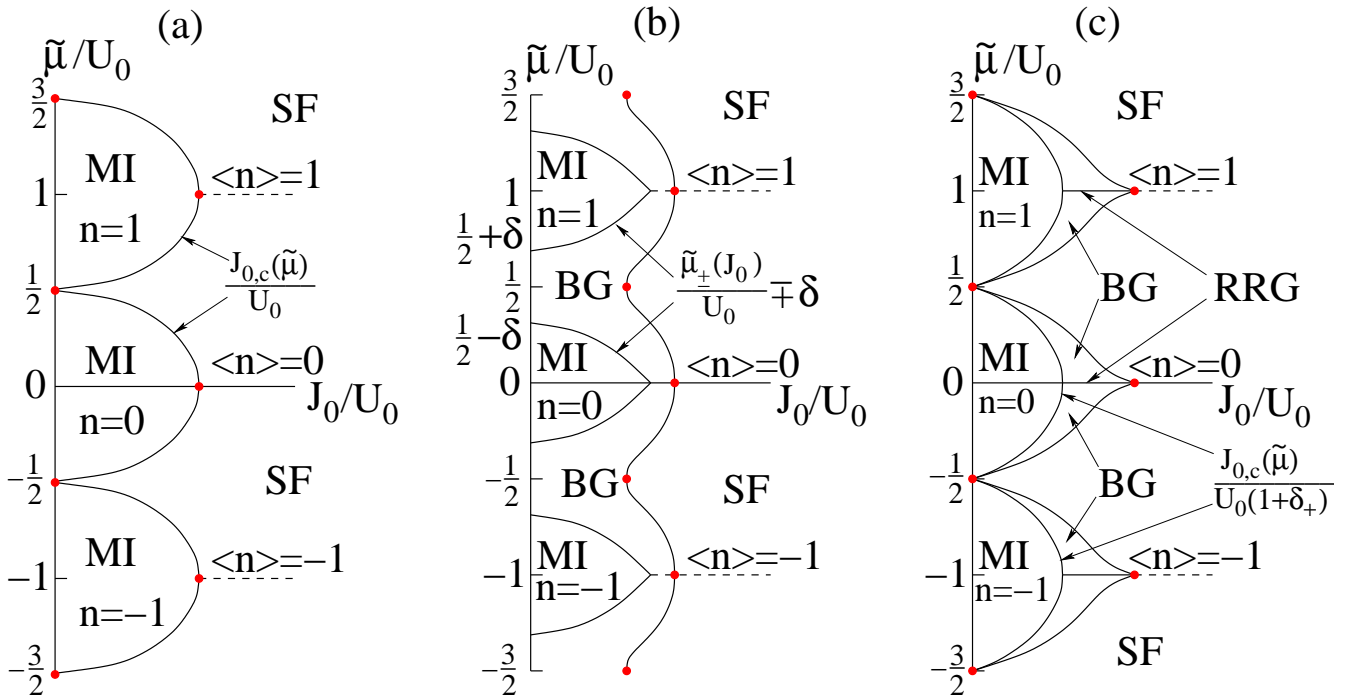

FIG. 1: (Color online) Schematic zero temperature phase diagram for the Josephson junction model. (a) The model without disorder, showing the periodic sequence of Mott lobes (MI) and the superfluid phase (SF). The transitions to superfluidity at the tips of the Mott lobes, $J = J_c^0$, are special and are in the universality class of the $(d + 1)$ -dimensional XY-model. The points $\mu_k/U_0 = k/2$ have an exact particle-hole symmetry. As described in the text, there is a corresponding singularity, determined by the correlation length exponent ν_{d+1}^{XY} , in the shape of the lobe near its tip. (b) The model with site energy disorder whose distribution is supported on the interval $-\Delta_\epsilon \leq \tilde{\epsilon}_i \leq \Delta_\epsilon$, showing the now shrunken (or even absent, if the disorder is sufficiently strong, $\delta \equiv \Delta_\epsilon/U_0 \geq \frac{1}{2}$) Mott lobes, and the new Bose glass phase that now intervenes between them and the superfluid phase. As indicated, the boundaries of the Mott lobes are determined entirely by δ and their pure system counterparts. The transition to superfluidity now takes place only from the Bose glass phase (BG), and it is believed that the nature of this transition is independent of where it occurs, even at the special points μ_k which now have only a statistical particle-hole symmetry. (c) Phase diagram for the model with only nearest neighbor bond disorder, $\tilde{J}_{ij} = J_0(1 + \Delta J_{ij})$ whose distribution has support $-\delta_- \leq \Delta J_{ij} \leq \delta_+$, with $\delta_- \leq 1$, showing again shrunken Mott lobes (which will vanish entirely if ΔJ_{ij} is unbounded from above). The boundaries of the Mott lobes are now determined entirely by δ_+ and their pure system counterparts. At integer filling the Bose Glass phase turns into an incompressible random rod glass (RRG). The transition is in the universality class of the $(d + 1)$ -dimensional classical random rod problem. Away from integer filling the compressibility turns on continuously, and the Bose glass phase reappears. The transition is once more in the universality class of the generic Bose glass to superfluid transition. The random rod temporal correlation length exponent $\nu_{\tau,0} = z_0\nu_0$ (expected to be greater than unit in $d = 3^{15}$) now describes the shape of critical line near the commensurate point. In a neighborhood of half filling (half-integer μ/U_0), whose size must depend on the precise distribution of ΔJ_{ij} , for $d > 1$,²⁵ the system remains superfluid all the way down to $J_0 = 0$: in the absence of site disorder the exact particle-hole symmetry that is restored at half filling guarantees delocalized excitations.

Nevertheless, one still has Mott lobes (now asymmetric and decreasing in size with increasing n_0) for each integer density, and a unique extremal point, $[J_{0,c}(n_0), \mu_c(n_0)]$, at which one exits the Mott lobe at fixed density $n = n_0$. One may show⁶ that the transition through these extremal points is still in the $(d + 1)$ -dimensional XY universality class, and that particle-hole symmetry must therefore be asymptotically restored *at* the critical point. The difference now is that there is a nontrivial balance between the densities of particle and hole excitations, and the interactions between them. The position of the critical point is no longer fixed by an explicit symmetry, but must be located by carefully tuning both the hopping

parameter and the chemical potential.

This phenomenon of “asymptotic symmetry restoration” at a critical point is actually fairly common (and we shall encounter it again below). For example, though the usual Ising model of magnetism has an up-down spin symmetry, the usual liquid-vapor or binary liquid critical points do not. However the Ising model correctly describes the universality class of the transition, and one concludes that the up-down symmetry must be restored near the critical point. Similarly, the p -state clock model with Hamiltonian

$$\mathcal{H} = -J \sum_{\langle ij \rangle} \cos \left[\frac{2\pi}{p} (q_i - q_j) \right], \quad q_i = 1, 2, \dots, p, \quad (1.9)$$

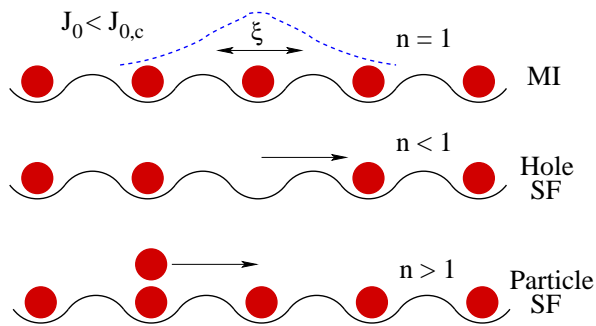

FIG. 2: (Color online) Schematic illustration of lattice bosons near unit filling $n = 1$ at some value of the hopping amplitude in the interval $0 < J_0 < J_{0,c}$. In the Mott insulating phase ($n = 1$), the effective wavefunction of each particle spreads only a finite distance $\xi(J_0)$, and the state is insulating. For $n > 1$ ($n < 1$), the extra particles (holes) travel freely within the essentially inert background, and the state is superfluid for arbitrarily small $|n - 1|$.

which may be thought of as a kind of discrete XY -model, has for sufficiently large p (specifically, $p > 4$ in $d = 2$; clearly $p = 2$ corresponds to the Ising model and $p = 3$ to the three-state Potts model) a transition precisely in the XY -model universality class. Note, however, that in the *ordered* phase, corresponding to the zero temperature fixed point, the order parameter will (for $d > 2$) spontaneously align along one of the p equivalent directions, q_i , breaking the XY -symmetry and generating a mass for the spin-wave spectrum (more interestingly, in $d = 2$ a power-law ordered Kosterlitz-Thouless phase exists for a finite temperature interval below the transition, with a second transition to a long-range ordered phase taking place only at a lower temperature²³). This latter property is not relevant in the present case since breaking particle-hole symmetry does not break the symmetry of the order parameter: the nature of the superfluid phase is unaffected.

2. Phase diagrams with disorder

We will consider two types of disorder: (i) onsite disorder in the $\tilde{\varepsilon}_i$, and (ii) disorder in the hopping parameters, \tilde{J}_{ij} . If $\tilde{\mu} \neq \tilde{\mu}_k$ for any k , that is if particle-hole symmetry is broken, we expect the two types of disorder to yield the same type of phase transition. In renormalization group language, each in isolation will generate the other under renormalization. If $\tilde{\mu} = \tilde{\mu}_k$ and the $\tilde{\varepsilon}_i$ have a symmetric distribution about zero so that the Hamiltonian possesses a statistical particle-hole symmetry, the obvious question is whether or not the transition in this case is different from the one in the presence of generic nonsymmetric disorder. We shall argue below that it is *not*, i.e., that breaking particle-hole symmetry *locally* is not substantially different from breaking it *globally*, and that in fact statistical particle-hole symmetry is asymp-

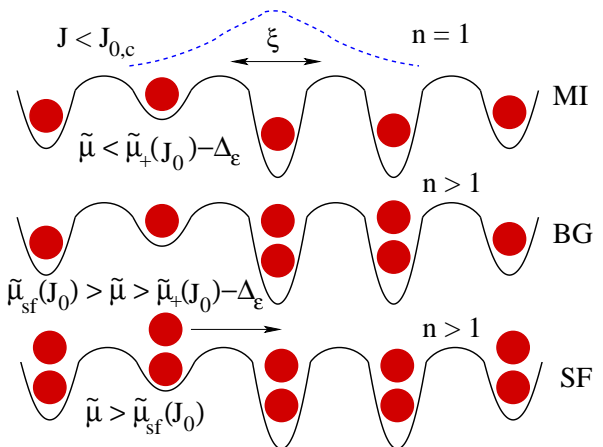

FIG. 3: (Color online) Schematic illustration of lattice bosons near unit filling in the presence of bounded disorder. If the disorder is not too strong ($\Delta_\varepsilon < U_0/2$), there is still a Mott phase with a finite energy gap for adding or removing particles. Unlike in the pure case (Fig. 2), superfluidity is not generated immediately with the addition of particles. For sufficiently small $n - 1$, the additional particles are Anderson localized by the residual random background potential of the effectively inert layer. The finite compressibility distinguishes this Bose glass phase from the Mott phase. The superfluid critical point $\tilde{\mu}_{sf}(J_0)$ occurs only once the added particles have sufficiently smoothed the background potential that its lowest lying states become extended.

totically restored at the critical point.²⁴ Only if $\tilde{\mu} = \tilde{\mu}_k$ and $\tilde{\varepsilon}_i \equiv 0$ does the disorder fully respect particle-hole symmetry. We shall see that in this case the transition is entirely different, lying in the same universality class as the classical $(d + 1)$ -dimensional XY -model with *columnar* bond disorder, precisely the kind of system addressed in Ref. 15.

In Fig. 1(b) we sketch the phase diagram in the presence of site disorder, whose distribution is supported on the finite interval $-\Delta_\varepsilon \leq \varepsilon_i \leq \Delta_\varepsilon$. We see that the Mott lobes have shrunk (and may in fact disappear altogether for sufficiently strong disorder), and a new *Bose glass* phase separates these lobes from the superfluid phase.⁶ In this new phase the compressibility is finite, but the particles do not hop large distances due to localization effects: particles on top of the inert background still see a residual random potential, whose lowest energy states will be localized (Fig. 3). As particles are added to the system, bosons will tend to fill these states until the residual random potential has been smoothed out sufficiently that extended states can form, finally producing superfluidity.⁶ As argued above, the nature of the superfluid transition is the same everywhere along transition line.

As indicated in the figure, the boundaries of the Mott lobes are determined entirely by the pure system, together with Δ_ε .⁸ The upper half of the boundary, $\tilde{\mu}_+(J_0, \Delta_\varepsilon) = \tilde{\mu}_+(J_0, 0) - \Delta_\varepsilon$, is pushed down by Δ_ε , while the lower half, $\tilde{\mu}_-(J_0, \Delta_\varepsilon) = \tilde{\mu}_-(J_0, 0) + \Delta_\varepsilon$, is pushed up by Δ_ε . This result, which relies on the exis-

tence of large, rare regions of nearly uniform superfluid, will be derived in Sec. III.

Finally, in Fig. 1(c) we sketch the phase diagram in the presence of bond disorder. For simplicity we consider here only nearest neighbor hopping parameterized in the form $\tilde{J}_{ij} = J_0(1 + \Delta J_{ij})$, with $[\Delta J_{ij}]_{\text{av}} = 0$, whose distribution is supported on a finite interval $-\delta_- \leq \Delta J_{ij} \leq \delta_+$, with $\delta_- \leq 1$. The Mott lobes have again shrunk (and may in fact disappear altogether for unbounded disorder, $\delta_+ \rightarrow \infty$), and glassy phases again separate these lobes from the superfluid phase. At non-integer density, the glassy phase is the compressible Bose glass. However, the existence of an exact particle-hole symmetry at integer density changes the nature of the glassy phase there, turning it into an *incompressible* random rod glass (RRG). In both cases, localization effects destroy superfluidity over a finite interval.⁶ As argued above, at non-integer density, the universality class of the BG–SF transition is of the same as for the site disorder model, while at integer density the RRG–SF transition is in the special random rod universality class.

The random rod *temporal* correlation length exponent $\nu_{\tau,0} = z_0\nu_0$ exhibits itself in the phase diagram: as also discussed in Sec. IV B, the superfluid transition line has a singularity, $\mu_{\pm}(J_0) \sim \pm(J_c^{\text{RR}} - J_0)^{z_0\nu_0}$, in the neighborhood of the particle-hole symmetric points (note that $z_{\text{pure}} = 1$). One expects $\nu_{\tau,0} > 1$ in $d = 3$, yielding the pictured cusps.

The boundaries of the Mott lobes are again determined entirely by the pure system, together with δ_+ . The boundary, $J_{0,c}(\tilde{\mu}, \delta_+) = J_{0,c}(\tilde{\mu}, 0)/(1 + \delta_+)$, is this time scaled to the left by Δ_j^+ . The result again relies on the existence of large, rare regions of nearly uniform superfluid, and will also be derived in Sec. III.

At half filling, where $\tilde{\mu} = \tilde{\mu}_k = (k + \frac{1}{2})U_0$ is a half-integer, an exact particle-hole symmetry is restored, and, for $d > 1$,²⁵ the superfluid phase can penetrate all the way to zero hopping. In general the superfluid phase will survive on a finite interval in density (which maps into the single point $\tilde{\mu} = \tilde{\mu}_k$ at $J_0 = 0$) around half filling, whose size depends on the precise distribution of \tilde{J}_{ij} .²⁶

C. Criticality and restoration of statistical particle-hole symmetry

In Sec. II various functional integral representations of the Hamiltonians (1.1) and (1.2) will be introduced. In order to discuss, in the most transparent fashion, the role of various symmetries at the superfluid transition, we summarize in Table I the basic classical continuum ψ^4 models that may be abstracted from these representations. The phase of $\psi = |\psi|e^{i\phi}$ represents the Josephson phases in (1.2). The control parameter r_0 represents the hopping strength J_0 , while g_0 represents the chemical potential $\tilde{\mu}$. Quenched hopping and site energy disorder are correspondingly represented, respectively, by the random fields $\delta r(\mathbf{x})$ and $\delta g(\mathbf{x})$. The fact that they

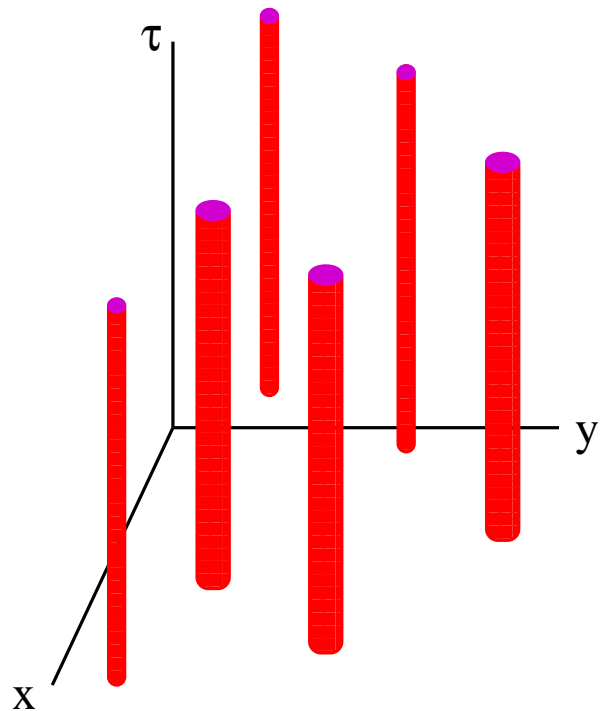

FIG. 4: (Color online) Schematic illustration of random rod-like structure generated by quenched disorder in quantum models. The cylinders represent, for example, a picture of random regions of enhanced or suppressed hopping strength.

are τ -independent generates rod-like disorder (Fig. 4). These models are intended to be used in the vicinity of the $n = 0$ Mott lobe, hence g_0 in the neighborhood of zero, since fluctuations in the amplitude $|\psi|$ destroy any translation symmetry in g_0 , analogous to (1.6), and the nonzero lobes are no longer symmetric.

The Lagrangian $\mathcal{L}_0 = \mathcal{L}_1(g_0 = 0)$ generates the classical $(d + 1)$ -dimensional XY critical behavior along the line $\tilde{\mu} = 0$ in Fig. 1(a): the superfluid transition occurs for decreasing r_0 at a critical value $r_{0,c}$. Nonzero g_0 in \mathcal{L}_1 generates the remainder of the Mott lobe, $r_{0,c}(g_0)$, corresponding to the remainder of the phase diagram in Fig. 1(a). The transition at nonzero g_0 is in the universality class of the dilute Bose gas superfluid onset transition (described by the Bogoliubov model) in d dimensions.²⁷ The usual coherent state representation of the (continuum version of the) boson Hamiltonian (1.1) is obtained by dropping the $|\partial_\tau \psi|^2$ term in \mathcal{L}_1 and setting $g_0 = 1$. This demonstrates explicitly the lack of a simple interpolation between the particle-hole symmetric and asymmetric models in the original boson Hamiltonian.

The Lagrangian $\mathcal{L}_2 = \mathcal{L}_3(g_0 = 0)$ incorporates hopping disorder in the form of τ -independent disorder δr in r_0 , and represents the previously analyzed (particle-hole symmetric) random rod model.¹⁵ The model describes the transitions along the line $g_0 = 0$ in Fig. 1(c), including the incompressible random rod glass (RRG) separating the tip of the Mott lobe from the superfluid phase.

Pure PH-sym [($d + 1$)-dimensional XY model]:

$$\mathcal{L}_0 = - \int d^d x \int d\tau \left\{ \frac{1}{2} |\nabla \psi|^2 + \frac{1}{2} |\partial_\tau \psi|^2 + \frac{1}{2} r_0 |\psi|^2 + \frac{1}{4} u_0 |\psi|^4 \right\}$$

Pure PH-asym [d -dimensional dilute Bose gas]:

$$\mathcal{L}_1 = - \int d^d x \int d\tau \left\{ \frac{1}{2} |\nabla \psi|^2 - \frac{1}{2} \psi^* (\partial_\tau - g_0)^2 \psi + \frac{1}{2} r_0 |\psi|^2 + \frac{1}{4} u_0 |\psi|^4 \right\}$$

PH-sym RR [($d + 1$)-dimensional classical random rod model]:

$$\mathcal{L}_2 = - \int d^d x \int d\tau \left\{ \frac{1}{2} |\nabla \psi|^2 + \frac{1}{2} |\partial_\tau \psi|^2 + \frac{1}{2} [r_0 + \delta r(\mathbf{x})] |\psi|^2 + \frac{1}{4} u_0 |\psi|^4 \right\}$$

PH-asym RR [($d + 1$)-dimensional incommensurate random rod model]:

$$\mathcal{L}_3 = - \int d^d x \int d\tau \left\{ \frac{1}{2} |\nabla \psi|^2 - \frac{1}{2} \psi^* (\partial_\tau - g_0)^2 \psi + \frac{1}{2} [r_0 + \delta r(\mathbf{x})] |\psi|^2 + \frac{1}{4} u_0 |\psi|^4 \right\}$$

Statistical PH-sym [commensurate dirty boson problem]:

$$\mathcal{L}_4 = - \int d^d x \int d\tau \left\{ \frac{1}{2} |\nabla \psi|^2 - \frac{1}{2} \psi^* [\partial_\tau - \delta g(\mathbf{x})]^2 \psi + \frac{1}{2} [r_0 + \delta r(\mathbf{x})] |\psi|^2 + \frac{1}{4} u_0 |\psi|^4 \right\}$$

Generic PH-asym [incommensurate dirty boson problem]:

$$\mathcal{L}_5 = - \int d^d x \int d\tau \left\{ \frac{1}{2} |\nabla \psi|^2 - \frac{1}{2} \psi^* [\partial_\tau - g_0 - \delta g(\mathbf{x})]^2 \psi + \frac{1}{2} [r_0 + \delta r(\mathbf{x})] |\psi|^2 + \frac{1}{4} u_0 |\psi|^4 \right\}$$

TABLE I: ψ^4 representation of models with various types of disorder and various degrees of particle-hole symmetry. The coefficients of $|\nabla \psi|^2$ and $|\partial_\tau \psi|^2$ have been normalized to $\frac{1}{2}$. The control parameters r_0 and g_0 are analogous to J_0 and $\tilde{\mu}$, respectively. Disorder in the hopping strengths is represented by δr , while that in the site energies is represented by δg . Both are independent of τ . In field theoretic treatments, both are taken as quenched Gaussian random fields with zero mean and delta-function correlations characterized by variances Δ_r and Δ_g , respectively. Disorder in the other parameters (including the unit gradient-squared coefficients) may also be introduced, but produces no new critical behavior.

Nonzero g_0 in \mathcal{L}_3 generates the remainder of the phase diagram in Fig. 1(c). We will show in Sec. III that the breaking of particle-hole symmetry implies that the RRG becomes the compressible Bose glass exists at all nonzero g_0 —in the renormalization group sense, nonzero g_0 , together with nonzero δr , generates a finite δg even if it vanishes to begin with.

Under the condition that the distribution of δg is symmetric, the Lagrangian $\mathcal{L}_4 = \mathcal{L}_5(g_0 = 0)$ maintains a statistical particle-hole symmetry. It is believed, however, that the superfluid transition at zero and nonzero g_0 are in the same universality class. In renormalization group language, g_0 must flow to zero at large scales, so that \mathcal{L}_4 , not \mathcal{L}_5 , describes the critical fixed point. This is the technical definition of the restoration of statistical particle-hole symmetry. We will confirm this picture within the double-epsilon expansion in Sec. VI.

The significance of this symmetry restoration at the critical point is the following. In Ref. 16 only the boson Hamiltonian (1.1), and corresponding coherent state Lagrangian, was considered, and a fixed point sought only in the space of parameters accessible to this Hamiltonian. Such a fixed point can therefore never possess a statistical particle-hole symmetry. However if the true fixed point does possess this symmetry, it is clear that it must then lie outside the space of boson Hamiltonians of the form (1.1) (or Lagrangians without a $|\partial_\tau \psi|^2$ term). Accessing this fixed point requires an enlargement of the parameter space so that both particle-hole symmetric and asymmet-

ric problems may be treated within the same model. The Josephson junction array Hamiltonian, (1.2), from which all of the Lagrangians listed in Table I may be derived, satisfies this requirement.

Using \mathcal{L}_4 and \mathcal{L}_5 , we shall see in Sec. VI that, indeed, a new statistically particle-hole symmetric dirty boson fixed point can be identified, and that all technical problems encountered in Ref. 16 may then be avoided. Specifically, certain diagrams that were ignored in Ref. 16 are in fact important and accomplish the required enlargement of the parameter space. There is, however, a price: this new fixed point is not perturbatively accessible within the double epsilon expansion. Thus, the random rod problem may be analyzed for small ϵ in $d = 4 - \epsilon - \epsilon_\tau$ dimensions if the dimension, ϵ_τ , of time is also small.¹⁵ We find, however, that for small ϵ and ϵ_τ , site disorder is *irrelevant* at the random rod fixed point, and that *full* particle-hole symmetry is therefore restored on large scales close to criticality. This remains true for sufficiently small $\epsilon_\tau < \epsilon_\tau^c(D)$, with $\epsilon_\tau^c(D) = O(1)$. Only for $\epsilon_\tau > \epsilon_\tau^c(D)$ does a new fixed point appear which breaks full particle-hole symmetry. Extrapolation of the critical behavior associated with this new fixed point, though uncontrolled, shows significant similarities to some features of the known behavior at $\epsilon_\tau = 1$. To lowest nontrivial order in ϵ_τ we find $\epsilon_\tau^c(D = 4) \simeq \frac{8}{29}$ ($D = 4$, hence $\epsilon = 0$, corresponding to $d = 3$ at $\epsilon_\tau = 1$). This value of ϵ_τ^c is significantly less than unity, and leads us to hope that estimates based on these extrapolations from small ϵ_τ are

not too unreasonable.

D. Outline

The outline of the remainder of this paper is as follows. In Sec. II we introduce various useful functional integral formulations for the thermodynamics of the Hamiltonians (1.1) and (1.2). We begin in Sec. III by considering the role of particle-hole symmetry in the nature of the excitation spectra of the glassy phases. Using a phenomenological model in which we view the structure of the random rod and Bose glass phases as a set of random sized, randomly placed, isolated superfluid droplets, we focus on the density and compressibility and examine how they vanish as full particle-hole symmetry is restored. The droplet model also confirms the relation between the boundaries of the pure and disordered Mott lobes in Figs. 1. In Sec. IV we begin focusing on the critical point through various phenomenological scaling arguments. In particular we identify a new crossover exponent that describes the relevance of particle-hole symmetry breaking perturbations to the random rod critical behavior. We revisit the original arguments^{6,28} for the dynamical exponent scaling equality $z = d$, showing that they can be violated, and hence that z may remain an independent exponent.²⁹ This is consistent with recent quantum Monte Carlo simulations in $d = 2$ that find $z = 1.40 \pm 0.02$.¹⁴ We also discuss the asymptotic restoration of statistical particle-hole symmetry at the dirty boson critical point. In Sec. V we illustrate all of these ideas using an exactly soluble one-dimensional model. The analysis is very similar to that of the Kosterlitz-Thouless transition in the classical two-dimensional XY-model. In Sec. VI we generalize the previous analyses to general $\epsilon_\tau \neq 1$, observing along the way some apparent pathologies that make $\epsilon_\tau = 1$ very special, leading one to question how smooth the limit $\epsilon_\tau \rightarrow 1$ might be. For example, the Bose glass phase has finite compressibility for $\epsilon_\tau = 1$, but is incompressible for all $\epsilon_\tau < 1$. It is distinguished from the Mott phase only by having a divergent order parameter susceptibility, χ_s . We then introduce the Dorogovtsev-Cardy-Boyanovsky double epsilon expansion formalism¹⁵ and derive the results outlined in the previous subsection. Finally, two appendices outline the derivations of various path integral formulations and duality transformations used in the body of the paper.

II. FUNCTIONAL INTEGRAL FORMULATIONS

In order to obtain a formulation of the problem more amenable to analytic treatment, we turn to functional integral representations of the partition function. It will turn out to be important to have an *exact* representation. Representations which involve dividing the Hamiltonian into two pieces, $\mathcal{H} = \mathcal{H}_0 + \mathcal{H}_1$, then using the

Kac-Hubbard-Stratanovich transformation to decouple \mathcal{H}_1 , generate effective classical actions with an infinite number of terms, which must be truncated at some finite order.⁶ In addition, such representations work only when $\tilde{\mu}$ lies within a Mott phase when $J_0 = 0$, and hence break down for unbounded, e.g., Gaussian, distributions of site energies. We turn instead to representations obtained from the Trotter decomposition (see App. A).

A. Lattice boson model

For the lattice boson model, the coherent state representation is most appropriate, and yields a classical Lagrangian

$$\mathcal{L}_B = \int_0^\beta d\tau \left[\sum_i \psi_i^*(\tau) \partial_\tau \psi_i(\tau) - \mathcal{H}_B\{\psi_i^*(\tau), \psi_i(\tau)\} \right], \quad (2.1)$$

where $\mathcal{H}\{\psi_i^*(\tau), \psi_i(\tau)\}$ is obtained by substituting the classical complex variable $\psi_i(\tau)$ for the boson site annihilation operator a_i [and $\psi_i^*(\tau)$ for the creation operator a_i^\dagger] wherever it appears in the (normally ordered form of the) quantum Hamiltonian. The partition function is given by $Z = \text{tr}^\psi[e^{\mathcal{L}}]$, where $\text{tr}^\psi[\cdot]$ is an unrestricted integral over all complex fields, $\psi_i(\tau)$. Notice that the only term that couples different time slices is the ‘‘Berry phase’’ $\psi^* \partial_\tau \psi$ term which arises from the overlap of two coherent states at neighboring times. This should be contrasted with the spatial coupling, $\frac{1}{2} \sum_{i,j} J_{ij} \psi_i^* \psi_j$ (essentially a discrete version of $\psi^* \nabla^2 \psi$), which appears in \mathcal{H}_B . The imaginary time dimension is therefore highly anisotropic. This anisotropy is increased further if disorder is present since the ϵ_i and J_{ij} are τ -independent: the disorder appears in perfectly correlated *columns*, rather than as point-like defects, in $(d+1)$ -dimensional space-time.

If the $\psi^* \partial_\tau \psi$ term were replaced by $\psi^* \partial_\tau^2 \psi$, only the disorder would contribute to the anisotropy (the fact that the coefficients of $\psi^* \partial_\tau^2 \psi$ and $\psi^* \nabla^2 \psi$ are different is not important, and may be cured by a simple rescaling). The model becomes precisely a special case in the family of classical models with rod-like disorder treated in Ref. 15. The linear time derivative term in (2.1) is more singular than a term with a second derivative in time. It should therefore not be too surprising that its presence leads to new critical behavior.

Yet another crucial property of the $\psi^* \partial_\tau \psi$ term is that it is purely imaginary:

$$\left[\int_0^\beta d\tau \psi^* \partial_\tau \psi \right]^* = - \int_0^\beta d\tau \psi^* \partial_\tau \psi, \quad (2.2)$$

where integration by parts and periodic boundary conditions have been used. Therefore the statistical factor, $e^{\mathcal{L}_B}$, used to compute the thermodynamics is in general

a complex number, and leads to interference between different configurations of the $\psi_i(\tau)$. Unlike that with coupling $\psi^* \partial_\tau^2 \psi$, the resulting model therefore does not correspond to any classical model with a well defined real Hamiltonian in one higher dimension. In fact, it is precisely this property that reflects the particle-hole asymmetry in the model. Interchanging particles and holes is equivalent to interchanging $\psi_i^*(\tau)$ and $\psi_i(\tau)$. The $\psi^* \partial_\tau \psi$ term changes sign under this operation, while $\mathcal{H}_B[\psi^*, \psi]$ is unaffected. Thus although \mathcal{L}_B is invariant under the combination (known as *time reversal*) of complex conjugation and $\tau \rightarrow -\tau$, the boson model always violates each separately.

B. Josephson model

Consider now the canonical coordinate Lagrangian for the Josephson array model (see App. A for a derivation):

$$\begin{aligned} \mathcal{L}_J = & \int_0^\beta d\tau \left\{ \sum_{i,j} \tilde{J}_{ij} \cos[\phi_i(\tau) - \phi_j(\tau)] \right. \\ & \left. + \frac{1}{2} \sum_{i,j} (U^{-1})_{ij} \left[i\dot{\phi}_i(\tau) + \tilde{\mu} - \tilde{\epsilon}_i \right] \left[i\dot{\phi}_j(\tau) + \tilde{\mu} - \tilde{\epsilon}_j \right] \right\}, \end{aligned} \quad (2.3)$$

with partition function $Z = \text{tr}^\phi e^{\mathcal{L}_J}$. Notice that the linear time derivative, $\dot{\phi}_i$, now appears in a much more symmetric looking fashion. If $\tilde{\mu} - \tilde{\epsilon}_i \equiv 0$, \mathcal{L}_J is particle-hole symmetric and real:

$$\begin{aligned} \mathcal{L}_J[\tilde{\mu} + \tilde{\epsilon}_i \equiv 0] = & \int_0^\beta d\tau \left[\sum_{i,j} \tilde{J}_{ij} \cos[\phi_i(\tau) - \phi_j(\tau)] \right. \\ & \left. - \frac{1}{2} \sum_{i,j} (U^{-1})_{ij} \dot{\phi}_i(\tau) \dot{\phi}_j(\tau) \right], \end{aligned} \quad (2.4)$$

and takes precisely the form of a classical XY -model in $(d+1)$ dimensions.

The periodicity, (1.6), of the phase diagram is a consequence of the periodicity of the ϕ_i in τ : substituting $\tilde{\mu} - n_0 \tilde{U}_0$ for $\tilde{\mu}$ and multiplying out the $(U^{-1})_{ij}$ term yields

$$\begin{aligned} \mathcal{L}_J[\tilde{\mu} - n_0 \tilde{U}_0] = & \mathcal{L}_J[\tilde{\mu}] - in_0 \int_0^\beta d\tau \sum_i \dot{\phi}_i(\tau) \\ & + \beta N \epsilon^0(n_0, \tilde{\mu}). \end{aligned} \quad (2.5)$$

However $\int_0^\beta d\tau \dot{\phi}_i(\tau) = 2\pi m_i$ and $e^{i2\pi m_i n_0} = 1$, so the second term simply drops out of the statistical factor, $e^{\mathcal{L}_J}$, and we recover the free energy identity (1.6). Notice that if $\tilde{\mu} - \tilde{\epsilon}_i \equiv \frac{1}{2} \tilde{U}_0$, we obtain a statistical factor

$$e^{\mathcal{L}_J[\tilde{\mu} - \tilde{\epsilon}_i = \frac{1}{2} \tilde{U}_0]} = (-1)^{\sum_i m_i} e^{\mathcal{L}_J[\tilde{\mu} - \tilde{\epsilon}_i = 0] + \beta N \epsilon^0(\frac{1}{2}, 0)}, \quad (2.6)$$

which, though real, is not always positive. Although this Lagrangian is also particle-hole symmetric, it too does not correspond to the Hamiltonian of any classical model. This model is very different from that with $\tilde{\mu} - \tilde{\epsilon}_i \equiv 0$. For example, as shown in Fig. 1(c), it always has superfluid order at $T = 0$, for arbitrarily small J_{ij} , as opposed to (2.4) which orders only for sufficiently large J_{ij} .⁶

C. Josephson model for general ϵ_τ

For later reference, note that, in contrast to (2.1), the Lagrangian (2.3) has an obvious generalization to noninteger dimensions of time.³⁰ If ϵ_τ is the dimension of time, we simply write

$$\mathcal{L}_J^{(\epsilon_\tau)} = \int_0^\beta d^{\epsilon_\tau} \tau \left\{ \sum_{i,j} \tilde{J}_{ij} \cos[\phi_i(\boldsymbol{\tau}) - \phi_j(\boldsymbol{\tau})] + \frac{1}{2} \sum_{i,j} (U^{-1})_{ij} [i\nabla_\tau \phi_i(\boldsymbol{\tau}) + \boldsymbol{\mu} - \boldsymbol{\epsilon}_i] \cdot [i\nabla_\tau \phi_j(\boldsymbol{\tau}) + \boldsymbol{\mu} - \boldsymbol{\epsilon}_j] \right\}, \quad (2.7)$$

where $\boldsymbol{\tau}$, $\boldsymbol{\mu}$ and $\boldsymbol{\epsilon}_i$ are ϵ_τ -dimensional vectors: $\boldsymbol{\tau} = (\tau_1, \dots, \tau_{\epsilon_\tau})$, etc.

Renormalization group calculations are performed most conveniently on Lagrangians, such as (2.1), which are polynomials in unbounded, continuous fields and their gradients. Therefore we would like to convert (2.7) to such a model, while retaining the essential physics. If we write $\psi_i(\boldsymbol{\tau}) = e^{i\phi_i(\boldsymbol{\tau})}$, then (2.7) may be written

$$\mathcal{L}_J^{(\epsilon_\tau)} = \int_0^\beta d^{\epsilon_\tau} \tau \left\{ \sum_{i,j} \tilde{J}_{ij} [\psi_i^*(\boldsymbol{\tau}) \psi_j(\boldsymbol{\tau}) + \text{c.c.}] + \frac{1}{2} \sum_{i,j} (U^{-1})_{ij} \psi_i^*(\boldsymbol{\tau}) (\nabla_\tau + \boldsymbol{\mu} - \boldsymbol{\epsilon}_i) \psi_i(\boldsymbol{\tau}) \cdot \psi_j^*(\boldsymbol{\tau}) (\nabla_\tau + \boldsymbol{\mu} - \boldsymbol{\epsilon}_j) \psi_j(\boldsymbol{\tau}) \right\}. \quad (2.8)$$

For onsite interactions only, $U_{ij} = U_0 \delta_{ij}$, the second term simplifies to

$$\int d^{\epsilon_\tau} \tau \frac{1}{2U_0} \sum_i \psi_i^*(\boldsymbol{\tau}) (\nabla_\tau + \boldsymbol{\mu} - \boldsymbol{\epsilon}_i)^2 \psi_i(\boldsymbol{\tau}), \quad (2.9)$$

which is conveniently quadratic in ψ . We now relax the assumption $|\psi_i| = 1$, employing instead the usual

$r|\psi|^2 + v|\psi|^4$ Landau-Ginzburg-Wilson weighting factor, obtaining finally

$$\begin{aligned} \mathcal{L}_\psi^{(\epsilon_\tau)} = & \int d^\epsilon \tau \left\{ \frac{1}{2} \sum_{i,j} \tilde{J}_{ij} [\psi_i^*(\tau) \psi_j(\tau) + c.c.] \right. \\ & + \frac{1}{2U_0} \sum_i \psi_i^*(\tau) (\nabla_\tau + \boldsymbol{\mu} - \boldsymbol{\epsilon}_i)^2 \psi_i(\tau) \\ & \left. - \sum_i [r|\psi_i(\tau)|^2 + v|\psi_i(\tau)|^4] \right\}. \quad (2.10) \end{aligned}$$

This model retains the exact particle-hole symmetry at $\boldsymbol{\mu} + \boldsymbol{\epsilon}_i \equiv 0$, but loses the precise periodicity of the phase diagram when $\epsilon_\tau = 1$: thus the second term in (2.5) now becomes

$$n_0 \int_0^\beta d\tau \sum_i \psi_i^* \partial_\tau \psi_i, \quad (2.11)$$

[compare the first term in (2.1)] which reduces to the previous form if $|\psi_i| = 1$. However if $|\psi_i|$ fluctuates, as in (2.10), this term is no longer a perfect time derivative and will not integrate to a simple integer result. We will therefore only use (2.10) near $\tilde{\mu} = 0$ when we study the role of particle-hole symmetry near the phase transition.

D. Continuum models

The field theoretic LGW-type Lagrangians listed in Table I follow (for $\epsilon_\tau = 1$, but with obvious generalizations to general ϵ_τ) from the continuum limit of (2.10) (and its various special cases), in which the nearest neighbor hopping term maps to $|\nabla\psi|^2$. Space and time are also rescaled to produce unit coefficients of the $\partial_\tau\psi|^2$ and $|\nabla\psi|^2$ terms. As a result, the hopping disorder now maps to disorder in the $|\psi|^2$ coefficient. As is standard, the mapping is not exact, but is intended only to produce a minimal model that preserves the basic symmetries of the original, so that its phase transitions lie in the correct universality class. The control parameters r_0 and g_0 have only a rough correspondence with J_0 and $\tilde{\mu}$, but nevertheless generate phase diagrams with the same topology.

III. PARTICLE-HOLE SYMMETRY AND THE EXCITATION SPECTRUM OF THE GLASSY PHASES

In this section we will consider the nature of the non-superfluid phases in the presence of the two types of disorder, ϵ_i and J_{ij} (to simplify the notation we henceforth drop the tildes on the Josephson junction model parameters). Recall that for the boson problem the ϵ_i produce a Bose glass phase,⁶ with a finite compressibility and a finite density of excitation states at zero energy. We shall contrast this with the case of the particle-hole symmetric, random J_{ij} model, which we will show has a vanishing

compressibility and an excitation spectrum with an exponentially small density of states, $\rho(\epsilon) \sim e^{-\epsilon_0/\epsilon}$, i.e. a “soft gap.” We will show that the compressibility is precisely the spin-wave stiffness in the time direction, which therefore vanishes in the “symmetric glass,” but is finite in the Bose glass. This yields an upper bound $z_0 \leq d$ for the dynamical exponent at the particle-hole symmetric transition. An effective *lower bound* on z_0 may be obtained by demanding that particle-hole asymmetry be a *relevant* operator at the symmetric transition. This is a necessary condition in order that the particle-hole asymmetric transition be in a different universality class from the symmetric one. We will obtain estimates for this lower bound within the double ϵ -expansion in Sec. VI.

A. Superfluid densities or helicity moduli

We begin by defining the superfluid density—the “helicity modulus,” or “spin wave stiffness,” in classical spin models. This quantity is computed from the change in free energy under a change in boundary conditions. Consider a box-shaped system with sides L_α , $\alpha = 1, \dots, D$. We are interested in $D = d+1$ and $L_D = \beta$. We say that ψ obeys θ_α -boundary conditions if

$$\begin{aligned} \psi(x_1, \dots, x_\alpha + L_\alpha, \dots, x_D) &= e^{i\theta} \psi(x_1, \dots, x_\alpha, \dots, x_D) \\ \psi(x_1, \dots, x_\beta + L_\beta, \dots, x_D) &= \psi(x_1, \dots, x_\beta, \dots, x_D), \\ &\beta \neq \alpha \end{aligned} \quad (3.1)$$

i.e., a twist angle θ is imposed in the α direction, while periodic boundary conditions are maintained in all other directions. Let

$$f^{\theta_\alpha} = -\frac{1}{V_D} \ln \text{tr} \left(e^{\mathcal{L}^{\theta_\alpha}} \right), \quad V_D \equiv \prod_{\beta=1}^D L_\beta, \quad (3.2)$$

where $\mathcal{L}^{\theta_\alpha}$ is the Lagrangian, be the free energy obtained using θ_α -boundary conditions. We may define

$$\tilde{\psi}(x_1, \dots, x_D) = e^{-i\theta x_\alpha / L_\alpha} \psi(x_1, \dots, x_D), \quad (3.3)$$

which obeys periodic boundary conditions in all directions. In all cases of interest one may write

$$\mathcal{L}^{\theta_\alpha}[\psi] = \mathcal{L}^0[\tilde{\psi}] + \delta\mathcal{L}[\tilde{\psi}; \theta/L_\alpha] \quad (3.4)$$

where $\delta\mathcal{L}$ may be expanded as a Taylor series in powers of θ/L_α , and superscript “0” denotes periodic boundary conditions. Thus

$$\delta f^{\theta_\alpha} \equiv f^{\theta_\alpha} - f^0 = -\frac{1}{V_D} \left[\langle \delta\mathcal{L} \rangle + \frac{1}{2} \langle \delta\mathcal{L}^2 \rangle_c + \dots \right], \quad (3.5)$$

where $\langle \delta\mathcal{L}^2 \rangle_c = \langle \delta\mathcal{L}^2 \rangle - \langle \delta\mathcal{L} \rangle^2$, and the averages are with respect to $\mathcal{L}^0[\tilde{\psi}]$. Equation (3.5) yields a series of terms in powers of θ/L_α , and we use the notation

$$\delta f^{\theta_\alpha} = -\frac{i\theta}{L_\alpha} \rho_\alpha + \frac{1}{2} \left(\frac{\theta}{L_\alpha} \right)^2 \Upsilon_\alpha + \dots \quad (3.6)$$

to define the coefficients in this series. This only makes sense for $|\theta| \leq \pi$, since it is clear from the definition that $f^{\theta\alpha}$ is periodic in θ_α with period 2π . We shall see that the first term, which in most previous cases was completely *absent*, arises from particle-hole asymmetry. The second term defines the *helicity modulus*, Υ_α , in the direction α .

1. Boson model helicity modulus

Let us now turn to specific cases with Lagrangians defined by (2.1) and (2.3). In both cases, when α is a spatial coordinate ($\alpha = 1, \dots, d$) the sensitivity to boundary conditions comes only from the hopping term so that for the boson model [see (1.1) and (2.1)],

$$\begin{aligned} \delta\mathcal{L}_B &= \frac{1}{2} \int_0^\beta d\tau \sum_{i,j} J_{ij} \left[\tilde{\psi}_i^* (e^{i\theta(x_i^\alpha - x_j^\alpha)/L_\alpha} - 1) \tilde{\psi}_j + \text{c.c.} \right] \\ &= \frac{i\theta}{2L_\alpha} \int_0^\beta d\tau \sum_{i,j} J_{ij} (x_i^\alpha - x_j^\alpha) [\tilde{\psi}_i^* \tilde{\psi}_j - \text{c.c.}] \\ &\quad - \frac{\theta^2}{4L_\alpha^2} \int_0^\beta d\tau \sum_{i,j} J_{ij} (x_i^\alpha - x_j^\alpha)^2 [\tilde{\psi}_i^* \tilde{\psi}_j + \text{c.c.}] \\ &\quad + O(\theta^3/L_\alpha^3), \end{aligned} \quad (3.7)$$

which, due to the assumed vanishing of the net current under periodic boundary conditions, yields $\rho_\alpha = 0$, $\alpha = 1, \dots, d$, and

$$\begin{aligned} \Upsilon_\alpha &= \frac{1}{4} \int_0^\beta d\tau \sum_{i,j,k} \left[J_{ij} (x_i^\alpha - x_j^\alpha) J_{k0} x_k^\alpha \right. \\ &\quad \times \langle [\psi_i^*(\tau) \psi_j(\tau) - \text{c.c.}] [\psi_k^*(0) \psi_0(0) - \text{c.c.}] \rangle_{\text{av}} \\ &\quad \left. + \frac{1}{2} \sum_i \left[J_{i0} (x_i^\alpha)^2 \langle \psi_i^*(0) \psi_0(0) + \text{c.c.} \rangle \right]_{\text{av}} \right], \\ &\quad \alpha = 1, \dots, d, \end{aligned} \quad (3.8)$$

where $[\cdot]_{\text{av}}$ denotes an average over the disorder (we assume self averaging). For nonrandom J_{ij} , with nearest neighbor hopping J only, (3.8) reduces to

$$\begin{aligned} \Upsilon_\alpha &= J^2 a^2 \int_0^\beta d\tau \sum_i \left[\langle [\psi_i^*(\tau) \partial_\alpha \psi_i(\tau) - \psi_i(\tau) \partial_\alpha \psi_i^*(\tau)] \right. \\ &\quad \times \left. [\psi_0^*(0) \partial_\alpha \psi_0(0) - \psi_0(0) \partial_\alpha \psi_0^*(0)] \rangle_{\text{av}} \right. \\ &\quad \left. + J a^2 \langle \psi_{\tilde{\mathbf{x}}_\alpha}^* \psi_0 + \psi_0^* \psi_{\tilde{\mathbf{x}}_\alpha} \rangle_{\text{av}} \right], \quad \alpha = 1, \dots, d, \end{aligned} \quad (3.9)$$

where $\partial_\alpha \psi_i \equiv \psi_{i+\tilde{\mathbf{x}}_\alpha} - \psi_i$, a is the lattice spacing, and, in an obvious notation, $i + \tilde{\mathbf{x}}_\alpha$ labels the nearest neighbor lattice site in direction α . We recognize this as the discrete version of the usual definition of Υ_α in terms of the current-current correlation function.

2. Josephson model helicity modulus

The Josephson Lagrangian yields precisely the same expressions if one identifies $\psi_i(\tau) = e^{i\phi_i(\tau)}$. Thus, (3.8) becomes

$$\begin{aligned} \Upsilon_\alpha &= - \int_0^\beta d\tau \sum_{i,j,k} \left[J_{ij} (x_i^\alpha - x_j^\alpha) J_{k0} x_k^\alpha \right. \\ &\quad \times \langle \sin[\phi_i(\tau) - \phi_j(\tau)] \sin[\phi_k(0) - \phi_0(0)] \rangle_{\text{av}} \\ &\quad \left. + \sum_i J_{i0} (x_i^\alpha)^2 \langle \cos[\phi_i(0) - \phi_0(0)] \rangle_{\text{av}} \right], \\ &\quad \alpha = 1, \dots, d \end{aligned} \quad (3.10)$$

and (3.9) becomes

$$\begin{aligned} \Upsilon_\alpha &= -4J^2 a^2 \int_0^\beta d\tau \sum_i \left[\langle \sin[\phi_{i+\tilde{\mathbf{x}}_\alpha}(\tau) - \phi_i(\tau)] \right. \\ &\quad \times \left. \sin[\phi_{\tilde{\mathbf{x}}_\alpha}(0) - \phi_0(0)] \rangle_{\text{av}} \right. \\ &\quad \left. + 2J a^2 \langle \cos[\phi_{\tilde{\mathbf{x}}_\alpha}(0) - \phi_0(0)] \rangle_{\text{av}} \right], \\ &\quad \alpha = 1, \dots, d \end{aligned} \quad (3.11)$$

3. Temporal helicity modulus and compressibility

Consider next the stiffness in the time direction. We will show that it is precisely the compressibility, $\kappa \equiv -\frac{\partial^2 f}{\partial \mu^2}$. To see this, note that only terms with time derivatives are sensitive to θ_τ -boundary conditions. In the Bose case, Eq. (2.1), we obtain

$$\delta\mathcal{L} = \frac{i\theta}{\beta} \int_0^\beta d\tau \tilde{\psi}_i^*(\tau) \tilde{\psi}_i(\tau) \quad (3.12)$$

which corresponds precisely to an imaginary shift, $\mu' = \mu + i\frac{\theta}{\beta}$, in the chemical potential. Similarly, for the Josephson case, Eq. (2.3), we define $\tilde{\phi}_i(\tau) = \phi_i(\tau) - \frac{\theta}{\beta}\tau$, leading to exactly the same chemical potential shift. Thus in both \mathcal{L}_B and \mathcal{L}_J the time derivatives appear with the chemical potential in just the right way to give rise to what amounts to the Josephson relation between the time derivative of the phase and changes in the chemical potential. We immediately conclude that the series (3.6) takes the form

$$\begin{aligned} \delta f^{\theta\tau} &= \frac{i\theta}{\beta} \frac{\partial f^0}{\partial \mu} + \frac{1}{2} \left(\frac{i\theta}{\beta} \right)^2 \frac{\partial^2 f^0}{\partial \mu^2} + \dots \\ &= -\frac{i\theta}{\beta} \rho + \frac{1}{2} \left(\frac{\theta}{\beta} \right)^2 \kappa + \dots \end{aligned} \quad (3.13)$$

where $\rho = -\frac{\partial f^0}{\partial \mu}$ is the number density, and, as promised, we identify $\Upsilon_\tau = \kappa$.

Classical intuition tells us that Υ_α should be nonzero only when the model has long range order in the phase

of the order parameter, i.e. only in the superfluid phase. Although this statement is true for the spatial directions, $\alpha = 1, \dots, d$, this is not necessarily true for $\alpha = \tau$. Our intuition regarding ${}^4\text{He}$ in porous media would lead us to be very surprised if the system were incompressible, $\kappa = 0$, throughout the nonsuperfluid phase. Thus there should be no barrier to the continuous addition of particles to the system, even when it is completely localized (only Mott phases, in which disorder is unimportant, are incompressible because the density is pinned at special values commensurate with the lattice⁶). The Bose glass phase is therefore rather special in that the order parameter has a *temporal stiffness*, $\Upsilon_\tau = \kappa > 0$, even when there is no spatial stiffness, $\Upsilon_x \propto \rho_s = 0$. Our classical intuition breaks down because the Lagrangian is typically not real and, as discussed earlier, does not have a proper classical interpretation. The droplet model picture developed below will make clear the origin of this special partial order.

The particle-hole symmetric model described by (2.4), however, *does* have a classical interpretation, and despite the fact that the J_{ij} are random and the model anisotropic (the disorder being fixed in time) it would be surprising if the disordered phase possessed long range order in time. Thus we expect κ to vanish when ρ_s does, so that the glassy disordered phase is incompressible. This is permitted because the particle-hole symmetry now dictates that the density be an integer. What distinguishes this glassy phase from the Mott phase, however, is that κ is not zero for an entire interval of μ , but vanishes only for the special value $\mu = 0$ where particle-hole symmetry holds.

4. Continuum model helicity moduli

For the continuum models listed in Table I, the simple squared gradient term produces in all cases the isotropic result

$$\Upsilon_\alpha = [\langle |\psi|^2 \rangle]_{\text{av}} \quad (3.14)$$

$$+ \int d^d x \int_0^\beta d\tau [\langle \psi^* \partial_\alpha \psi(\mathbf{x}, \tau) \psi^* \partial_\alpha \psi(\mathbf{0}, 0) \rangle]_{\text{av}}$$

for the spatial helicity moduli. The temporal phase twist response is given by (3.14) with g_0 replacing μ : $\rho = -\frac{\partial f^0}{\partial g_0}$, $\Upsilon_\tau = \kappa = -\frac{\partial^2 f^0}{\partial g_0^2}$. Clearly, for \mathcal{L}_0 , \mathcal{L}_2 , and \mathcal{L}_4 , one should set $g_0 = 0$ after taking the derivatives.

B. Droplet model of the glassy phases

Let us now understand in detail how these two different behaviors merge with each other in the full phase diagram, Fig. 1, and in particular confirm the positions of the Mott phase boundaries. Consider therefore the particle-hole symmetric model (2.4) with, for concreteness, $J_{ij} = J_0(1 + \Delta J_{ij}) > 0$, nonzero on nearest neighbor

bonds only, with all ΔJ_{ij} *independent* random variables with zero mean. Let J_c be its critical point, and let J_c^0 be the critical point when all $\delta J_{ij} = 0$ (note that it is entirely possible that $J_c < J_c^0$, since random fluctuations can sometimes *compete* with Mott phase commensuration effects and thereby enhance superfluid order¹¹). In the latter, nonrandom case, the transition is from a Mott insulating phase for $J_0 < J_c^0$ to a superfluid phase for $J_0 > J_c^0$. Suppose now that $0 < \Delta J_{ij} \leq \delta_+$ is bounded from above (as well as, trivially, from below) with δ_+ the essential supremum (i.e., the largest value of ΔJ_{ij} achievable with finite probability density). Then for J_0 such that $J_0 + \delta_+ < J_c^0$, all J_{ij} are smaller than J_c^0 , and the system must have a Mott gap—reducing any set of the J_{ij} from an initially uniform value in the Mott phase can only enhance its stability. However, for $J_c > J_0 > J_c^0/(1 + \delta_+)$ one will form, via probabilistic fluctuations, exponentially rare, but arbitrarily large regions of bonds in which all $J_{ij} > J_c^0$. These regions therefore represent finite droplets of superfluid—increasing any set of the J_{ij} from an initially uniform value within the superfluid phase can only enhance the stability of the superfluid phase phase. It is here that the τ -independence of the J_{ij} becomes critical—in the classical interpretation these droplets are one-dimensional cylinders (see Fig. 4) with arbitrarily large cross-section, made of material that would be ferromagnetically ordered in the bulk. The fact that these regions are already infinite along one dimension clearly enhances magnetic ordering more than would finite (zero-dimensional) pieces of ferromagnet. We shall see now that these droplets generate Griffiths singularities³² that close the Mott gap. It then follows that the Mott phase boundary must lie precisely at $J_c^0/(1 + \delta_+)$, as shown in Fig. 1(c).

C. Correlations and excitations in the random bond model

Consider a superfluid droplet with (spatial) volume V , which will occur roughly with density $e^{-p_0 V}$, for some constant p_0 . The behavior of $V \times \infty$ cylinders of magnet has been discussed in detail by Fisher and Privman,³³ who were concerned with finite size scaling theory of ferromagnets with a continuous $O(n)$ symmetry below their bulk critical points. Their main result (which will be rederived in a more general context below) was that the correlation length, ξ_{\parallel} , along the cylinder is governed by the bulk helicity modulus along the same direction:

$$\xi_{\parallel} = \frac{2\Upsilon(T)V}{(n-1)k_B T}. \quad (3.15)$$

In our case, $k_B T = 1$, $n = 2$ and $\Upsilon(T) \equiv \Upsilon_\tau(J_0)$. The correlation function, $G_0(\tau)$, along the cylinder then varies as

$$G_0(\tau) \sim e^{-|\tau|/\xi_{\parallel}}, \quad |\tau| \gg \xi_{\parallel}. \quad (3.16)$$

There is some ambiguity in what we should take for V and $\Upsilon_\tau(J)$ in (3.15): the droplets are neither perfectly spherical, nor is J_{ij} uniform throughout the droplet. Thus V should be some effective volume, while $\Upsilon_\tau(J_0)$ should be the bulk temporal helicity modulus associated with some effective uniform $J_0 > J_c^0$, say roughly the average of J_{ij} over the droplet. None of these ambiguities change the order of magnitude estimates made below.

1. Stretched exponential correlations in the symmetric glass

The full temporal correlation function, $G(\tau)$, is obtained by averaging $G_0(\tau)$ over all droplets (considered independent in the present picture). We therefore estimate

$$G(\tau) \approx \int dV \int d\Upsilon_\tau p(V, \Upsilon_\tau) G_0(\tau), \quad (3.17)$$

where $p(V, \Upsilon_\tau)$ is the probability density for droplets of volume V and bulk helicity modulus Υ_τ ,

$$p(V, \Upsilon_\tau) \sim e^{-V/V_0(\Upsilon_\tau)}. \quad (3.18)$$

The coefficient $V_0(\Upsilon_\tau)$, which we interpret as the “typical” droplet size for a given Υ_τ , will depend on the detailed shape of the tail of the probability distribution for $J_{ij} > J_c^0$. Using (3.15), for large τ we may perform the integral over V using the saddle point method. The integration will be dominated by V near the solution of $\frac{d}{dV}(V/V_0 + \tau/2\Upsilon_\tau V) = 0$. This yields

$$G(\tau) \sim \int d\Upsilon_\tau e^{-\sqrt{2\tau/\Upsilon_\tau V_0(\Upsilon_\tau)}}, \quad \tau \rightarrow \infty. \quad (3.19)$$

The coefficient $\Upsilon_\tau V_0(\Upsilon_\tau)$ will have a minimum at some value, $\tilde{\Upsilon}_\tau(J_0)$, corresponding to the most probable large droplets, and this will govern the asymptotic behavior of the integral (3.19) to yield finally,

$$G(\tau) \sim e^{-\sqrt{\tau/\tau_0(J_0)}}, \quad \tau_0(J_0) = \frac{1}{2} \tilde{\Upsilon}_\tau V_0(\tilde{\Upsilon}_\tau). \quad (3.20)$$

The droplets therefore yield a *stretched* exponential behavior, to be contrasted with the purely exponential behavior in the Mott phase.³¹ From (3.20) we may derive the quantum mechanical single-particle density of states,^{6,22} $\rho_1(\epsilon)$, defined as the inverse Laplace transform of $G(\tau)$:

$$G(\tau) = \int_0^\infty d\epsilon \rho_1(\epsilon) e^{-\epsilon|\tau|}. \quad (3.21)$$

It is easy to see that exponential decay in $G(\tau)$ requires a *gap* in $\rho_1(\epsilon)$,

$$\rho_1(\epsilon) = 0, \quad \epsilon < \epsilon_c \Leftrightarrow G(\tau) \sim e^{-\epsilon_c|\tau|}, \quad (3.22)$$

while slower than exponential decay permits $\rho_1(\epsilon) > 0$ for all $\epsilon > 0$. The form (3.20) yields

$$\rho_1(\epsilon) \sim e^{-\frac{1}{4\tau_0(J)\epsilon}}, \quad \epsilon \rightarrow 0^+, \quad (3.23)$$

a “soft gap.” The non-exponential form of (3.20) and the gap free form of (3.23) are known as Griffiths singularities,³² and define the RRG phase for J_0 within some interval above $J_c^0 < J_c^0 - \Delta_J^+ < J_c$.

2. Lack of a direct Mott–superfluid transition

The fact that there cannot be a direct Mott–SF transition (i.e., $J_c = J_c^0$) follows from the fact that the correlation lengths in both the superfluid droplets and in the “background” Mott phase (defined, for example, as the region between droplets in which all J_{ij} are some specified finite distance below J_c^0) are finite.

The superfluid transition can occur only if the droplets grow to be large enough, and/or close enough together, that they begin to coalesce. Thus, we have treated the droplets as independent, but there will actually be exponentially small interactions $\sim e^{-d(J_0)/\xi(J_0)}$ between them due to the finite background correlation length, where $d(J_0)$ is the typical droplet separation [which diverges exponentially as $J_0 \rightarrow J_c^0/(1 + \delta_+)$] and $\xi(J_0)$ is the effective correlation length in the surrounding Mott phase (which remains finite in this same limit). These couplings will increase the correlation length slightly, but only when J_0 is sufficiently large [a finite distance above $J_c^0/(1 + \delta_+)$], and $d_0(J_0)$ sufficiently small, will the superfluid droplets effectively overlap, and the correlation length diverge. This defines J_c , which, as noted earlier, could lie below J_c^0 for certain disorder distributions.

3. Correlations, excitations and compressibility at small nonzero μ : Bose glass onset

Now consider the compressibility. Its computation requires the addition of a small uniform chemical potential, μ . As alluded to earlier, we expect $\rho_1(\epsilon)$ to be *finite* at $\epsilon = 0$ in the presence of μ , signifying a Bose glass, and implying power law behavior for $G(\tau)$:³¹

$$G(\tau) \approx \rho_1(0; \mu)/\tau, \quad \tau \rightarrow \infty, \quad (3.24)$$

though we shall see that $\rho_1(0; \mu)$ is exponentially small in $\frac{1}{\mu}$.

Such behavior lies far outside any classical intuition. To see how it comes about we must generalize the ideas of Ref. 33 to this case. Fortunately this is relatively straightforward: a compact statement of the Fisher-Privman result is that long time correlations along $V \times \infty$ cylinders (for $n = 2$) are governed by an effective one-dimensional classical action

$$S_{\text{eff}}^0 = -\frac{1}{2} V \Upsilon_\tau \int_0^\beta d\tau [\partial_\tau \phi(\tau)]^2, \quad (3.25)$$

where $\phi(\tau)$ is a coarse-grained phase. This immediately yields

$$G_0(\tau) \equiv \langle e^{i[\phi(\tau) - \phi(0)]} \rangle = e^{-\frac{1}{2} \langle [\phi(\tau) - \phi(0)]^2 \rangle}, \quad (3.26)$$

which, upon using

$$\frac{1}{2}\langle[\phi(\tau) - \phi(0)]^2\rangle = \int_{-\infty}^{\infty} \frac{1 - e^{i\omega\tau}}{\omega^2} \frac{d\omega}{\Upsilon_\tau V} = \frac{|\tau|}{2\Upsilon_\tau V}, \quad (3.27)$$

yields (3.15) and (3.16).

Now we must generalize (3.25) to finite μ . This is accomplished using (3.6): effective long wavelength, long time “hydrodynamic” fluctuations in the phase ϕ are governed by precisely the same elastic moduli that govern equilibrium twists in the phase. Thus in (3.6) one simply replaces $\frac{\theta}{L_\alpha}$ by $\partial_\alpha\phi$ and integrates over all space. If, as in the present case, the twists in different directions, α , linearly superimpose [this may be checked directly from (3.7), where now one defines $\tilde{\psi} = e^{-i\sum_\alpha\theta_\alpha x_\alpha/L_\alpha}\psi$, with ψ obeying θ_α -boundary conditions simultaneously in each direction], one simply sums over all directions α to obtain the final result:

$$S_{\text{eff}} = - \sum_{\alpha=1}^D \int d^d x d\tau \left[-i\rho_\alpha \partial_\alpha \phi + \frac{1}{2} \Upsilon_\alpha (\partial_\alpha \phi)^2 \right]. \quad (3.28)$$

In the case where the interactions are spatially isotropic one has $\rho_\alpha = 0$ and $\Upsilon_\alpha = \Upsilon$ for $\alpha = 1, \dots, d$. With the identifications (3.13) for $\alpha = \tau$ we have

$$S_{\text{eff}} = - \int d^d x d\tau \left[-i\rho \partial_\tau \phi + \frac{1}{2} \kappa (\partial_\tau \phi)^2 + \frac{1}{2} \Upsilon |\nabla \phi|^2 \right]. \quad (3.29)$$

The validity of this hydrodynamic form in the presence of disorder relies on a hidden assumption that no new, unforeseen low energy excitations develop, e.g., in the amplitude, rather than just the phase, of the order parameter. This appears unlikely, and there are concrete proposals for such excitations (but see Ref. 12 for some discussion on this point in the context of interpreting quantum Monte Carlo data).

For $V \times \infty$ cylindrical geometries, the effective one dimensional result, (3.15) and (3.16), is obtained by assuming that for each τ , $\phi(\mathbf{x}, \tau)$ is essentially constant in space, and hence that only the temporal fluctuations are important. More formally, the finiteness of V implies an energy gap in the spatial spin-wave spectrum, between uniform $\phi(\mathbf{x})$ and the next excited state in which ϕ twists by 2π from one side of the system to the other, of order $V^{-2/d}$. The temporal spectrum has no such gap (the frequency, ω , in (3.27) is continuous), and therefore the asymptotic long time, large distance behavior may be obtained by assuming $\phi(\mathbf{x}, \tau) = \phi(\tau)$ only. The $|\nabla\phi|^2$ term in (3.28) may be treated as an additive constant that drops out of any temporal average, and we obtain the proper generalization of (3.24):

$$S_{\text{eff}}^{(1)} = -V \int_0^\beta d\tau \left[\frac{1}{2} \kappa (\partial_\tau \phi)^2 - i\rho \partial_\tau \phi \right]. \quad (3.30)$$

All the effects of particle-hole asymmetry are in the ρ term.

Let us now study the consequences of (3.30). First, when ρV is an integer (i.e., the density in the bulk is commensurate with the droplet volume, V) the 2π -periodic boundary conditions on ϕ imply that the ρ term simply drops out of the statistical factor, $e^{S_{\text{eff}}^{(1)}}$. This implies that only the fractional part, $\rho V \bmod 1$, matters in (3.30). One must be careful to distinguish ρ and κ from the *actual* density and compressibility of the droplet of volume V . The values of ρ and κ are appropriate to a bulk superfluid system with some effective $J > J_c^0$. The bulk compressibility, $\kappa_0(J)$, of such a system is finite and nonzero. When $\mu = 0$ the density is $\rho = 0$ (or, more generally, some integer), so for small μ ,

$$\begin{aligned} \rho &= \kappa_0(J)\mu + O(\mu^2) \\ \kappa &= \kappa_0(J) + O(\mu). \end{aligned} \quad (3.31)$$

The actual values of ρ and κ in the droplet are now computed from (3.30) as follows: the free energy density is given by

$$f = f_0 - \frac{1}{\beta V} \text{tr}^\phi \left[e^{-S_{\text{eff}}^{(1)}} \right], \quad (3.32)$$

in which f_0 is the *bulk* free energy density corresponding to the input parameters, κ and ρ . Thus, for example, at a given value of the chemical potential, $\mu = \mu_0$, we have

$$- \left(\frac{\partial f_0}{\partial \mu} \right)_{\mu=\mu_0} = \rho(\mu_0) \equiv \rho^0, \quad \left(\frac{\partial^2 f}{\partial \mu^2} \right) = \kappa(\mu_0) \equiv \kappa^0, \quad (3.33)$$

and hence, correct to quadratic order in $\mu - \mu_0$, we may take

$$f_0(\mu) = f_0(\mu_0) - \rho^0(\mu - \mu_0) - \frac{1}{2} \kappa^0 (\mu - \mu_0)^2. \quad (3.34)$$

The effective action must also be correct to quadratic order, therefore for the purposes of computing the full free energy, consistency requires that in $S_{\text{eff}}^{(1)}$ we take $\kappa \equiv \kappa^0$ and $\rho = \rho^0 + \kappa^0(\mu - \mu_0)$. For the purposes of computing derivatives with respect to μ , the only μ -dependence in the fluctuation part of the free energy is now in ρ . We obtain

$$\begin{aligned} f &= f_0 - \frac{1}{\beta V} \ln \left[\sum_{m=-\infty}^{\infty} \text{tr}^{\phi^m} \left\{ e^{S_{\text{eff}}^{(1)}} \right\} \right] \\ &= f_0 - \frac{1}{\beta V} \ln \left[\sum_{m=-\infty}^{\infty} e^{2\pi i m \rho V} \text{tr}^{\phi^m} \left\{ e^{S_{\text{eff}}^{(0)}} \right\} \right], \end{aligned} \quad (3.35)$$

where tr^{ϕ^m} means that we impose the temporal boundary condition $\phi(\beta) = \phi(0) + 2\pi m$. Now define $\tilde{\phi}(\tau) = \phi(\tau) - 2\pi m\tau/\beta$, so that $\tilde{\phi}(\beta) = \tilde{\phi}(0)$, to obtain

$$\begin{aligned} f &= f_0 - \frac{1}{\beta V} \ln \left[\sum_{m=-\infty}^{\infty} e^{i2\pi m \rho V} e^{-2\pi^2 m^2 \kappa^0 / \beta} \right. \\ &\quad \left. \times \text{tr}^{\tilde{\phi}} \left\{ e^{-S_{\text{eff}}^{(0)}[\tilde{\phi}]} \right\} \right] \\ &= f_0 + f_{00}[\kappa^0] - \frac{1}{\beta V} \ln \left[\sum_{l=-\infty}^{\infty} e^{-\frac{\beta}{2\kappa^0 V} (\rho V - l)^2} \right], \end{aligned} \quad (3.36)$$

where we have used (see App. B)

$$\sum_{m=-\infty}^{\infty} e^{i2\pi mx} \frac{e^{-m^2/2K}}{\sqrt{2\pi K}} = \sum_{l=-\infty}^{\infty} e^{-2\pi^2 K(x-l)^2}, \quad (3.37)$$

with $K = \beta/4\pi^2\kappa^0 V$, and

$$f_{00}[\kappa^0] = \ln \left[\sqrt{\frac{\beta}{2\pi\kappa^0 V}} \text{tr}^{\tilde{\phi}} \left\{ e^{S_{\text{eff}}^{(0)}[\tilde{\phi}]} \right\} \right] \quad (3.38)$$

is independent of $\mu - \mu_0$. In the limit $\beta \rightarrow \infty$ only the term with minimal $(x-l)^2$, i.e. $-\frac{1}{2} \leq x-l \leq \frac{1}{2}$, contributes (at the boundaries, two neighboring terms are degenerate). Let $l_0(\kappa^0, \mu)$ be this minimizing value of l . We then obtain finally,

$$f = f_0 + f_{00} + \frac{1}{\kappa^0 V} (\rho V - l_0)^2, \quad (3.39)$$

and the actual density in the droplet is

$$-\frac{\partial f}{\partial \mu} = \rho - \frac{1}{V} (\rho V - l_0) = \frac{l_0}{V}. \quad (3.40)$$

There are exactly l_0 particles in the droplet for the interval of μ such that $|\rho(\mu)V - l_0| < \frac{1}{2}$, and we have established the desired result that the droplet is incompressible on this same interval.

Consider next the temporal correlation function, given by

$$\begin{aligned} G_{\rho}^{(0)}(\tau - \tau') &= \langle e^{i[\phi(\tau) - \phi(\tau')]} \rangle \\ &= \frac{\text{tr}^{\phi} \left[e^{S_{\text{eff}}^{(1)}} e^{i[\phi(\tau) - \phi(\tau')]} \right]}{\text{tr}^{\phi} \left[e^{S_{\text{eff}}^{(1)}} \right]} \\ &= \frac{\sum_{m=-\infty}^{\infty} e^{i2\pi m \rho V} \text{tr}^{\phi^m} \left[e^{S_{\text{eff}}^{(0)}} e^{i[\phi(\tau) - \phi(\tau')]} \right]}{\sum_{m=-\infty}^{\infty} e^{i2\pi m \rho V} \text{tr}^{\phi^m} \left[e^{S_{\text{eff}}^{(0)}} \right]}. \end{aligned} \quad (3.41)$$

Defining the same periodic field, $\tilde{\phi}(\tau)$, we obtain

$$\begin{aligned} G_{\rho}^{(0)}(\tau - \tau') &= \langle e^{i[\phi(\tau) - \phi(\tau')]} \rangle_{S_{\text{eff}}^{(0)}} \\ &\times \frac{\sum_{m=-\infty}^{\infty} e^{i2\pi m(\rho V + \frac{\tau - \tau'}{\beta})} e^{-2\pi^2 m^2 \kappa^0 V / \beta}}{\sum_{m=-\infty}^{\infty} e^{i2\pi m \rho V} e^{-2\pi^2 m^2 \kappa^0 V / \beta}} \\ &= e^{-|\tau - \tau'|/2\kappa^0 V} e^{-(\tau - \tau')(\rho V \bmod 1)/\kappa^0 V}, \quad \beta \rightarrow \infty, \end{aligned} \quad (3.42)$$

where we have used (3.37). Once again, in the limit $\beta \rightarrow \infty$ only the term with $-\frac{1}{2} \leq \rho V - l \equiv \rho V \bmod 1 \leq \frac{1}{2}$, contributes. One sees now that $G_{\rho}(\tau)$ decays exponentially for both $\tau \rightarrow \pm\infty$, but at different rates:

$$\begin{aligned} G_{\rho}^{(0)}(\tau) &= e^{-(1 \pm \gamma)|\tau|/2\kappa^0 V}, \quad \tau \rightarrow \pm\infty \\ -1 < \gamma &\equiv 2(\rho V \bmod 1) \leq 1. \end{aligned} \quad (3.43)$$

This exponential decay signifies an energy gap, proportional to $\frac{1}{\kappa^0 V}$, for adding a particle, and is equivalent to the incompressibility result above. However, for large V this gap is very small, and one need only increase μ (and hence ρ) by a small amount to add a single particle to the droplet.

For given μ the number of particles in the droplet will be $l = \lfloor \rho V \rfloor$, the greatest integer less than or equal to ρV . Since there exist arbitrarily large droplets, an arbitrarily small change in μ will add particles to the system in precisely those droplets with volume $V \geq \frac{1}{\rho} \approx \frac{1}{\kappa^0 \mu}$. Focusing on μ near zero (where $\kappa^0 = \kappa_0$), we may estimate the total density as

$$\begin{aligned} \rho_{\text{tot}} &\sim \int dV d\kappa_0 p(V, \kappa_0) \frac{[\kappa_0 \mu V]}{V} \\ &\sim \bar{\kappa}_0 \mu \int_{V > \frac{1}{\kappa_0 \mu}} dV e^{-V/V_0(\bar{\kappa}_0)} \\ &\sim \bar{\kappa}_0 \mu e^{-1/\bar{\kappa}_0 \mu V_0(\bar{\kappa}_0)}, \end{aligned} \quad (3.44)$$

where $\bar{\kappa}_0$ is defined analogously to $\bar{\Upsilon}_{\tau}$ in (3.20). In the derivation of this formula we have assumed that $\mu > 0$, but the result is valid also for $\mu < 0$ if μ is replaced by $|\mu|$ in the exponent (only). The total compressibility may be estimated as

$$\kappa_{\text{tot}} \sim \left(\bar{\kappa}_0 + \frac{1}{V_0 |\mu|} \right) e^{-1/\bar{\kappa}_0 V_0(\bar{\kappa}_0) |\mu|}, \quad (3.45)$$

which also vanishes exponentially as $|\mu| \rightarrow 0$.

Finally we may use the above results to estimate the total temporal correlation function and to exhibit the finite density of states, (3.24), at $\bar{\epsilon} = 0$. Once again, the total correlation function, $G_{\rho}(\tau)$ is the average of $G_{\rho}^{(0)}(\tau)$ over all droplets:

$$G_{\rho}(\tau) = \int dV d\kappa_0 p(V, \kappa_0) G_{\rho}^{(0)}(\tau; \kappa_0, V). \quad (3.46)$$

For large τ and small $\rho > 0$, only large volumes contribute to the integral. It is clear from (3.43) that $G_{\rho}^{(0)}(\tau)$ decays most slowly when ρV is close to half-integer, and those droplets with such ‘‘resonant’’ values of V will contribute the leading large τ -dependence. The smallest resonant volume (into which a single particle will be added) is precisely $V = \frac{1}{2\rho}$, and contributions from higher order resonances, $V = \frac{3}{2\rho}, \frac{5}{2\rho}, \dots$, will be exponentially smaller in $\frac{1}{\rho}$. Thus

$$\begin{aligned} G_{\rho}(\tau) &\sim \int dV d\kappa_0 p(V, \kappa_0) e^{-|\tau|/2\kappa_0 V} e^{-\gamma\tau/2\kappa_0 V} \\ &\sim e^{-1/2\bar{\kappa}_0 |\mu| V_0(\bar{\kappa}_0)} \int_0^{\delta} \frac{dx}{\bar{\kappa}_0 |\mu|} e^{-\frac{1}{4}x|\mu\tau|}, \end{aligned} \quad (3.47)$$

where $x = |\rho V - \frac{1}{2}|$ and $\delta < \frac{1}{2}$ is a cutoff and we have replaced V by its smallest resonant value, $\frac{1}{2\rho} \approx \frac{1}{2\kappa_0 \mu}$, everywhere except in $\gamma = 2(\rho V \bmod 1)$. The integration

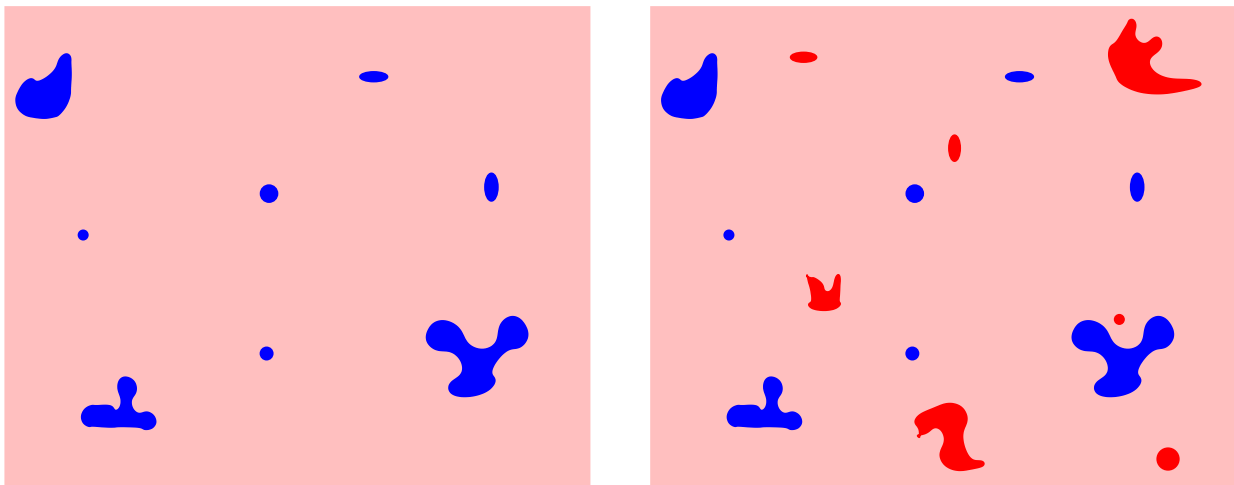

FIG. 5: (Color online) Schematic illustration of the droplet model of the Bose glass phase for the random site energy model. **Left:** Exiting the Mott lobe at fixed $J_0 < J_0^M$ below its tip with increasing $\mu > \mu_+(J_0) - \Delta$ [or decreasing $\mu < \mu_-(J_0, \Delta) = \mu_-(J_0) + \Delta$]. For arbitrarily small $\epsilon = \mu - \mu_-(J_0, \Delta)$ there will be an (exponentially small) density of droplets with volume large enough that the energy gap to adding a particle is smaller than ϵ . **Right:** Exiting the Mott lobe from its tip at fixed $\mu = 0$ with increasing $J_0 > J_0^M$, in the statistically particle-hole symmetric model. For arbitrarily small $\Delta J = J_0 - J_0^M(\Delta)$ there will similarly be arbitrarily large droplets whose local chemical potential magnitude is above the energy gap required to add a particle (previous droplets from the left illustration), or remove a particle (additional droplets).

is now trivial, and we obtain

$$G_\rho(\tau) \sim \frac{4}{\bar{\kappa}_0 \mu^2 |\tau|} \left[1 - e^{-\frac{1}{4} \delta |\mu \tau|} \right] e^{-1/2 \bar{\kappa}_0 |\mu| V_0(\bar{\kappa}_0)}. \quad (3.48)$$

This reproduces the $\frac{1}{\tau}$ behavior (3.24), predicted for the Bose glass phase with

$$\rho_1(\epsilon = 0) \sim \frac{4}{\bar{\kappa}_0 \mu^2} e^{-1/2 \bar{\kappa}_0 |\mu| V_0(\bar{\kappa}_0)}. \quad (3.49)$$

Note that the power law prefactors (in μ) of the exponential must not be taken seriously because we have made a very crude estimate for the probability function $p(V, \kappa_0)$. Recall that $\bar{\kappa}_0$ is the “most probable” compressibility for large droplets.

One direct consequence of the slow power law decay of temporal correlations, (3.24) or (3.48), is a divergent superfluid susceptibility,⁶

$$\begin{aligned} \chi_s &= \int d^d x \int d\tau G(\mathbf{x}, \tau) \\ &\sim V_0(\bar{\kappa}_0) \int d\tau G_\rho(\tau) \rightarrow \infty. \end{aligned} \quad (3.50)$$

This provides another signature, in addition to the finite compressibility, distinguishing the Bose glass from the Mott phases.

To summarize, we have seen that for the particle-hole symmetric model the correlation function, $G(\tau)$, has stretched exponential behavior coming from large rare regions in which $J > J_c^0$. This is known as a Griffiths singularity³², and this kind of effect is ubiquitous in random systems. Since $G(\tau)$ still decays faster than any

power law, the effects of these singularities are obviously physically rather subtle. In contrast, when $\mu \neq 0$ the model no longer has a classical interpretation, and the behavior is far more singular: for given μ , *finite* droplets of size $V \approx \frac{1}{2} \bar{\kappa}_0 |\mu|$ give rise to power law decay of $G_\rho(\tau)$ —no longer do the singularities occur only in the limit $V \rightarrow \infty$. Quantum mechanically, we understand this as being a consequence of the existence of arbitrarily low energy single particle excitations, arising from superfluid droplets with very small energy gaps for the addition of an extra particle. It is interesting to see this derived explicitly from the interference terms in the Lagrangian [see (3.35)-(3.43)].

D. Droplets in the random site energy model

1. MI-BG phase boundary

Consider now the random site energy model, with uniform (nonrandom) hopping J_{ij} . Above, we studied the crossover between the RRG and BG phases with application of a small uniform μ , with J_0 beyond the tip of the Mott lobe. Here we begin by considering $J_0 < J_0^M(\Delta)$ below the tip of the Mott lobe (to be computed below), and consider, for specificity, the transition to the BG phase with increasing μ (identical arguments, with particles replaced by holes, go through for the transition with decreasing μ).

For $\mu < \mu_+(J_0) - \Delta$, all local chemical potentials $\mu - \epsilon_i$ lie below the Mott gap $\mu_+(J_0)$, and no extra particles can enter the system (if a uniform chemical potential μ lies below the Mott gap, then reducing it on some sites

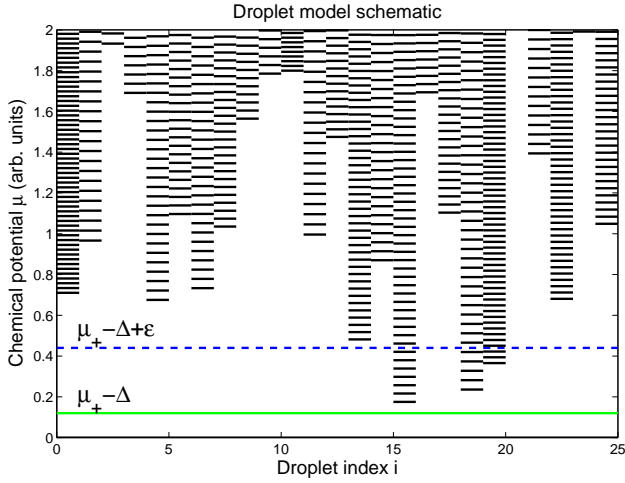

FIG. 6: (Color online) Schematic illustration of spectrum of droplet excitations. Droplets are assumed to be well separated, and independent (see Fig. 5). The horizontal axis is some convenient droplet index. The vertical axis shows the critical chemical potential levels (in some arbitrary units) at which a new particle is added for each droplet. The lower bound of the excitation spectrum lies at the Mott phase boundary $\mu_+(J_0) - \Delta$ (solid horizontal line). For any $\epsilon \equiv \mu - \mu_+(J_0) + \Delta > 0$ (dashed horizontal line), there will be a finite (but exponentially small) density of large droplets with local chemical potential lying sufficiently far above $\mu_+(J_0)$ that one or more extra particles are added. The total number of particles added is given by counting the number of “occupied” levels below μ . For a given droplet, while the lowest excitation depends primarily on the local chemical potential, subsequent particles are added in sequence, with gaps scaling as $1/\kappa_+ V$ where V is the droplet volume, and $\kappa_+(J_0, \mu_+)$ is the bulk compressibility of the pure (superfluid) phase just above Mott phase boundary. In an infinite system there are infinitely many droplets, implying a continuous distribution of excitation energies, and the bulk density will increase continuously with increasing $\epsilon > 0$.

cannot reduce the gap³⁴). Thus, $\mu_+(J_0) - \Delta$ is a lower bound for the Mott phase boundary.

Another large rare region argument now shows that it is also an upper bound. Let $\epsilon = \mu - \mu_+(J_0) + \Delta > 0$ be positive, but arbitrarily small. Then there will be a finite density $\sim e^{-V/V_0(\epsilon)}$ of arbitrarily large, but very rare regions of volume V , in which all of the site energies are larger than, say, $\Delta - \epsilon/2$ —see the left panel of Fig. 5. The scale V_0 will diverge as $\epsilon \rightarrow 0$ in a fashion determined by the shape of the tail of the distribution. The region will then look like a finite size droplet with local chemical potential larger than $\mu_+(J_0)$ by at least $\epsilon/2$ [additional near-uniformity constraints may be imposed on the site energies if necessary to make the droplet as homogeneous as desired, but this will not be critical to the argument as it entails only an adjustment of the definition of $V_0(\epsilon)$].

Let $\kappa_+(J_0)$ be the (finite) compressibility of a homogeneous system just above the Mott lobe. From the Bogoliubov theory of the dilute Bose gas of quasiparticle excitations, one may estimate $\kappa_+ \sim m/\hbar^2 \xi(J_0)^{d-2}$ (re-

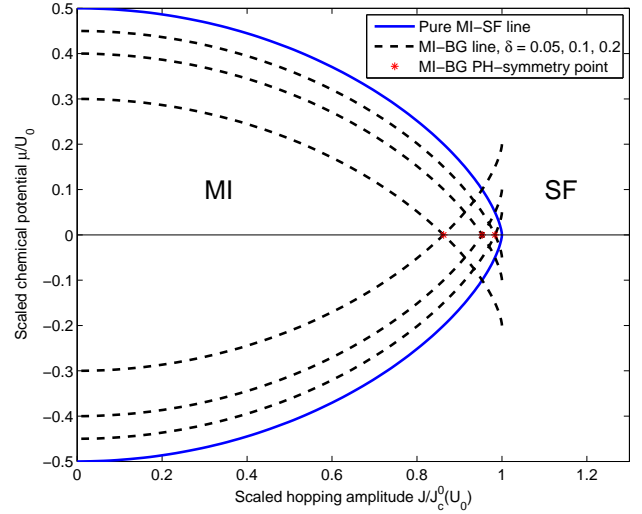

FIG. 7: (Color online) Mott lobe boundaries as a function of disorder. The phase boundary is determined by that of the pure system and the half-width Δ of the disorder distribution: $\mu_{\pm}(J_0, \Delta) = \mu_{\pm}(J_0, 0) \mp \Delta$. The tip of the Mott lobe, where a statistical particle-hole symmetry obtains, occurs at $J_0 = J_0^M(\Delta)$ defined by $\mu_{\pm}(J_0) = \Delta$.

placed by a logarithmic form in $d = 2^{35}$), where $\xi(J_0)$ estimates the diameter of the quasiparticles which determines the s-wave scattering length.²² Then the added number of particles may be estimated as $l = [\epsilon \kappa_+ V/2]$ [compare (3.43) and below]. Thus, if $V > 2/\kappa_+ \epsilon$ the droplet will have at least one extra particle, and additional particles are added each with energy gap $2/\kappa_+ V$. Note that one should have as well $V \gg \xi(J_0)^d$, the quasiparticle volume, for this dilute Bose gas argument to make sense. The droplet excitation spectrum following from these arguments is illustrated in Fig. 6.

A calculation identical in form to (3.44) and (3.45) (with μ replaced by $\epsilon/2$) can now be used to show that the bulk compressibility is finite, though exponentially small in $1/\epsilon$. This finally demonstrates that $\mu = \mu_+(J_0) - \Delta$ is also a lower bound on the Bose glass phase boundary, and hence is, in fact, the phase boundary. The resulting shrinking of the pure system Mott lobe is illustrated in Fig. 7 for various values of $\delta = \Delta/U_0$. Note that the pure system $\mu_{\pm}(J_0) \sim |J_0 - J_c^0|^{\nu_0}$ critical singularity⁶ is replaced by a slope discontinuity at the tip of the Mott lobe, $J_0 = J_0^M$ [defined by $\mu_{\pm}(J_0^M) = \Delta$].

2. Statistical particle-hole symmetry

Since we assume that the random site energies ϵ_i have a symmetric distribution, the line $\mu = 0$, passing through the tip of the Mott lobe, has a statistical particle-hole symmetry (see the discussion in Sec. II). Does this change the nature of the Bose-glass phase along this line, $J_0 > J_0^M$?

It is clear that the answer must be no: for any

$J_0 > J_0^M$, hence $\delta\mu \equiv \Delta - |\mu_{\pm}(J_0)| > 0$, we will be able to find an interpenetrating, but independent, distribution of droplets of arbitrarily large size in which all $\epsilon_i < -\mu_+(J_0) - \delta\mu/2$, or all $\epsilon_i > -\mu_-(J_0) + \delta\mu/2$. The former will have additional particles, while the latter will have a particle deficit (additional holes)—right panel of Fig. 5. Precisely at $\mu = 0$, symmetry implies that the overall density is still fixed at the Mott value. The previous analysis, generating finite compressibility and nonzero energy density of excitation states, then goes through precisely as before, but now with ϵ replaced by $\delta\mu$, and a different volume scale, $V_0(\bar{\kappa}_{\pm}, \delta\mu)$, now depending on $\delta\mu$.

Thus, at least at this qualitative level, statistical particle-hole symmetry differs from generic particle-hole *asymmetry* only in that there are now two sets of droplets (particle droplets and hole droplets) contributing independently to the excitation spectrum. It seems very unlikely then that the nature of the superfluid transition would be any different either. We shall address this issue further in Sec. IV.

3. Lack of a direct Mott–superfluid transition

Using arguments similar to that presented in Sec. III C 2, we can rule out a direct MI–SF transition in this model as well. The excited droplets, containing a dilute superfluid of excitations, have been treated as independent. There will, however, be exponentially decaying interactions $\sim e^{-d/\xi(J_0)}$ between them, where d is the typical droplet separation, and $\xi(J_0)$ is the correlation length in the background insulating Mott phase. Even for very large d (exponentially large in $1/\epsilon$), it is not immediately obvious that there might be some (exponentially) small hopping of quasiparticles between droplets, generating bulk superfluid coherence. However, the excitation spectrum of each individual droplet is discrete, and the usual Anderson localization arguments imply that for small ϵ the competition between hopping distance and energy level matching implies that the excited states remain strongly localized to the neighborhood of their droplets. Stated slightly differently, for ϵ not too large, the excited particles see a residual random potential whose effective low lying single particle states must be localized. Identical arguments, applied to the two sets of droplets, imply that there can be no direct transition through the statistical particle-hole symmetric tip of the Mott lobe either.

In apparent violation of these, essentially rigorous, arguments, there have been some recent Monte Carlo simulations claiming to see a direct MI–SF transition, over a finite segment of the Mott lobe around $\mu = 0$, for sufficiently weak disorder,¹³ and even claiming evidence for new multicritical behavior at the endpoints of this segment. However, it is well known that rare region effects are invisible to Monte Carlo simulations,^{8,11} which are, by necessity, limited to finite volumes with at most a few thousand sites.

Note, in addition, that since the boundary of the Mott phase is known exactly, a direct transition would imply that the SF phase moves in to take over *all* of what used to be the pure system Mott phase. Although disorder can indeed increase the stability of the superfluid over the MI,¹¹ that it would eat up the putative intervening BG phase entirely is disproven by the rare region arguments.

At the risk of belaboring the point, notice also how extraordinarily sensitive to the type of disorder the direct MI–SF transition would have to be if it existed. Consider a model in which the usual top-hat disorder model of sufficiently small half-width Δ is augmented by an additional Gaussian disorder with the same width Δ , but with a miniscule relative amplitude—say 10^{-9} . Since the onsite potentials are now unbounded (though one would have to survey billions of sites to know it) the MI phase no longer exists. However, by any conceivable measure, the total disorder is still small, but a direct MI–SF transition would now require a SF phase all the way down to $J_0 = 0$. In other words, a one-in-a-billion change must cause the phase boundary to move an infinite distance (on the natural scale of $1/J_0$). It is obvious, however, that the simulations would see no change at all with the infinitesimal added Gaussian.

Regarding the apparent multicritical scaling, it is very easy to find apparent scaling of data over the limited ranges of system sizes that are available, if one has a sufficient number of free parameters available to fit (the transition point, and the exponents ν and z in this case). A more likely explanation for the apparent scaling is a combination of finite size effects, and a crossover from the pure system critical behavior to dirty boson critical behavior at weak disorder. The latter implies a crossover scaling variable of the form $\Delta/|J_0 - J_c^0|^\phi$, where ϕ is a crossover exponent quantifying the instability of the pure MI–SF transition to small disorder. At small μ , this crossover will also mix with the pure system particle-hole symmetry-breaking scaling variable $\mu/|J_0 - J_c^0|^{\nu_0}$. For small Δ and limited system sizes, these scaling variables will saturate before the asymptotic BG–SF dirty boson criticality can become visible very close to $J_{0,c}(\mu)$. The corresponding multi-crossover scaling form, which will be discussed in more detail in Sec. IV B below, could easily mimic multicriticality.

IV. PARTICLE-HOLE SYMMETRY AND SCALING NEAR CRITICALITY

In order to discuss scaling it is convenient (but by no means necessary) to use the ψ^4 Lagrangian, (2.10), further simplified by taking the continuum limit and dropping all unnecessary dimensionful coefficients. To begin

we take $\epsilon_\tau = 1$ only, and consider the Lagrangian,

$$\begin{aligned} \mathcal{L}_c = & - \int d^d x \int d\tau \left[\frac{1}{2} |\nabla \psi|^2 - \frac{1}{2} \psi^* [\partial_\tau - g(\mathbf{x})]^2 \psi \right. \\ & \left. + \frac{1}{2} r(\mathbf{x}) |\psi|^2 + \frac{1}{4} u |\psi|^4 \right], \end{aligned} \quad (4.1)$$

equivalent to \mathcal{L}_5 in Table I with $g(\mathbf{x}) = g_0 + \delta g(\mathbf{x})$ and $r(\mathbf{x}) = r_0 + \delta r(\mathbf{x})$. The phase transition occurs when the control parameter r_0 becomes sufficiently negative. As described earlier, when $g \equiv 0$ the particle-hole symmetric problem is recovered. If the $|\partial_\tau \psi|^2$ term is dropped and we take $g \equiv 1$, we obtain the closest approximation to the boson coherent state Lagrangian, (2.1), which was the starting point for the work in Ref. 16. We shall see that the $|\partial_\tau \psi|^2$ term, which was ignored in Ref. 16, is actually crucial for a correct understanding of the critical behavior. When $g \equiv 0$ one obtains precisely the random rod model studied in Ref. 15.

As part of our scaling discussion, we will revisit previous arguments⁶ for the scaling relation $z = d$ for the dynamical exponent for the dirty boson problem. Recent quantum Monte Carlo results contradict this relation, finding $z = 1.40 \pm 0.02$ in $d = 2$.¹⁴ We will show that all of the previous arguments, when looked at more carefully, in fact *place no constraint* on the exponent z .²⁹ Lacking deeper arguments, it would appear that z remains an independent exponent, undetermined by any scaling relation.³⁶

A. Scaling of superfluid density and compressibility

Recall that, as described in Sec. III A, the superfluid density, ρ_s , and compressibility, κ , measure the system response to twists, spatial and temporal respectively, in the superfluid order parameter. As in (3.3), we introduce

$$\tilde{\psi}(\mathbf{x}, \tau) = e^{-i(\mathbf{k}_0 \cdot \mathbf{x} + \omega_0 \tau)} \psi(\mathbf{x}, \tau), \quad (4.2)$$

and impose periodic boundary conditions on $\tilde{\psi}(\mathbf{x}, \tau)$, identifying $\omega_0 = \theta_0/\beta$ and $\mathbf{k}_0 = (\theta_1/L_1, \dots, \theta_d/L_d)$. Analogously to (3.4), one obtains

$$\mathcal{L}_c^{\mathbf{k}_0, \omega_0}[\psi] = \mathcal{L}_c^0[\tilde{\psi}] + \delta \mathcal{L}_c[\tilde{\psi}] \quad (4.3)$$

with

$$\begin{aligned} \delta \mathcal{L}_c[\tilde{\psi}] = & - \int d^d x \int d\tau \left\{ \frac{1}{2} (k_0^2 + \omega_0^2) |\tilde{\psi}|^2 \right. \\ & \left. - i \omega_0 \tilde{\psi}^* [\partial_\tau - g(\mathbf{x})] \tilde{\psi} + i \mathbf{k}_0 \cdot \tilde{\psi}^* \nabla \tilde{\psi} \right\}. \end{aligned} \quad (4.4)$$

The expansion of the free energy (3.5) in powers of k_0 and ω_0 takes the form

$$\delta f(k_0, \omega_0) = -i\rho\omega_0 + \frac{1}{2}(\kappa\omega_0^2 + \Upsilon k_0^2) + O(\omega_0^3, \omega_0 k_0^2), \quad (4.5)$$

In addition to the result (3.14) for the helicity modulus, one may then identify

$$\begin{aligned} \kappa & \equiv \Upsilon_\tau = [\langle |\psi|^2 \rangle]_{\text{av}} + \int d^d x \int d\tau \\ & \quad \times [\langle \psi^* (\partial_\tau - g) \psi \rangle(\mathbf{x}, \tau) \langle \psi^* (\partial_\tau - g) \psi \rangle(\mathbf{0}, 0)]_c]_{\text{av}} \\ \rho & \equiv \rho_\tau = -[\langle \psi^* (\partial_\tau - g) \psi \rangle]_{\text{av}}. \end{aligned} \quad (4.6)$$

The spatial isotropy of (4.1) implies that $\Upsilon_\alpha \equiv \Upsilon$ is independent of the direction α . The subscript “ c ” on the right hand side of the second equation indicates a cummulant average, i.e., that the product of the averages, namely ρ^2 , should be subtracted from the integrand. We shall ultimately require these expressions only when $g \equiv 0$, where $\rho \equiv 0$ as well.

1. Random rod critical point scaling

Let us first consider the scaling of ρ_s and κ for the classical random rod problem, $g(x) \equiv 0$. Note that $\mathbf{k}_0 \cdot \tilde{\psi}^* \nabla \tilde{\psi}$ and $\omega_0 \tilde{\psi}^* \partial_\tau \tilde{\psi}$ are *symmetry breaking perturbations*: the first breaks the $\mathbf{x} \leftrightarrow -\mathbf{x}$ spatial inversion symmetry, and the second breaks the time inversion symmetry $\tau \leftrightarrow -\tau$ symmetries of random rod Lagrangian. The latter corresponds precisely to particle-hole symmetry.

Critical universality classes are, by definition, insensitive to most changes in the detailed parameters of the Hamiltonian, but symmetry breaking perturbations are often an exception, leading to changes in the asymptotic critical behavior. One therefore expects k_0, ω_0 to be *relevant* perturbations to the random rod problem, entering the thermodynamics through scaling combinations that diverge as the critical point is approached. Since k_0 is an inverse length and ω_0 is an inverse time, one expects them to be scaled by the corresponding divergent correlation length and time, respectively. This motivates the following form for the singular part of the free energy:

$$f_s(k_0, \omega_0) \approx A |\delta|^{2-\alpha} \Phi(k_0 \xi, \omega_0 \xi_\tau), \quad (4.7)$$

where $\xi \approx \xi_0 |\delta|^{-\nu_0}$ and $\xi_\tau \approx \xi_{\tau,0} |\delta|^{-\nu_{\tau 0}}$ are the correlation lengths in the spatial and temporal directions, respectively, A is a nonuniversal amplitude, and the *dynamical exponent* is defined by $z_0 = \nu_{\tau 0}/\nu_0$. The subscript 0 on the exponents indicate that they are those appropriate to the classical random rod problem, and the generic auxiliary parameter, δ is $r_0 - r_{0,c}$ in (4.1), but more generally is any parameter such as chemical potential, pressure, strength of disorder, film thickness, or magnetic field, which moves the system through the phase transition at $T = 0$, defined to occur at $\delta = 0$. We assume that $\delta > 0$ corresponds to the disordered phase and $\delta < 0$ to the ordered (superfluid or superconducting) phase.³⁷ The two scaling arguments $k_0 \xi$ and $\omega_0 \xi_\tau$ indeed diverge as $\delta \rightarrow 0$ for arbitrarily small k_0 and ω_0 , consistent with their expected relevance.

Although (4.8) motivates the correct result, the fact that ω_0 and k_0 are infinitesimal in the zero temperature

thermodynamic limit, $\beta, L_\alpha \rightarrow \infty$, means that a little more care is required to construct a rigorous scaling formulation. More properly, the boundary condition dependence appears in a finite size scaling ansatz for the free energy,³⁸

$$\delta f^\theta \approx \beta^{-1} L^{-d} \Phi_0^\theta [\delta(L/\xi_0)^{1/\nu_0}, \delta(\beta/\xi_{\tau,0})^{1/\nu_{\tau_0}}]. \quad (4.8)$$

The existence of a nonzero stiffness (in the ordered phase), i.e., via (3.6), a leading finite-size correction of order L^{-2} or β^{-2} , now requires that the scaling function obey $\Phi_0^\theta(x, y) \approx x^{d\nu_0} y^{z_0\nu_0} (\Phi_1^\theta x^{-2\nu_0} + \Phi_2^\theta y^{-2z_0\nu_0})$ for large x, y , (and $\delta < 0$), yielding

$$\begin{aligned} \Upsilon &\approx \xi_0^{2-d} \xi_{\tau,0}^{-1} (\Phi_1^\theta/2\pi^2\theta^2) \delta^{v_0} \\ \kappa &\approx \xi_0^{-d} \xi_{\tau,0} (\Phi_2^\theta/2\pi^2\theta^2) \delta^{v_{\tau_0}} \end{aligned} \quad (4.9)$$

with the *Josephson scaling relations*,⁶

$$\begin{aligned} v_0 &= (d + z_0 - 2)\nu_0 = 2 - \alpha_0 - 2\nu_0 \\ v_{\tau_0} &= (d - z_0)\nu_0 = 2 - \alpha_0 - 2z_0\nu_0, \end{aligned} \quad (4.10)$$

and requiring in addition that $\Phi_{1,2}^\theta \propto \theta^2$. We emphasize that the crucial assumption is that the leading boundary condition dependence is all in the singular, i.e., finite size scaling part, of the free energy. We can make this assumption only because k_0 and ω_0 introduce relevant perturbations which fundamentally alter the symmetry of the Lagrangian. Further support for this assumption is that we expect all stiffnesses to vanish identically in the disordered phase of the classical model: thus Υ and κ can have no analytic contributions at all.

2. Dirty boson critical point scaling: revisiting $z = d$

Now, we can try to extend the above arguments for nonzero g , following Ref. 6. Thus, one may posit identical forms (4.7) or (4.8) for the singular part of the free energy, but with exponents and scaling functions appropriate to the dirty boson critical point. One obtains then

$$\begin{aligned} \Upsilon &\sim |\delta|^v, \quad v = 2 - \alpha - 2\nu = (d + z - 2)\nu \\ \kappa &\sim |\delta|^{v_\tau}, \quad v_\tau = 2 - \alpha - 2z\nu = (d - z)\nu. \end{aligned} \quad (4.11)$$

For $g \neq 0$, both the Bose glass and superfluid phases are compressible, so it is expected that the compressibility remains finite right through the transition. This leads to the prediction $z = d$.

However, although the result for Υ is believed to be correct, there are a number of questionable assumptions underlying the argument above for κ , as we shall now discuss. For $g \neq 0$, the density of the Bose glass phase varies smoothly with g_0 (the control parameter analogous to the chemical potential μ). A temporal twist only perturbs slightly the term, $g\psi^*\partial_\tau\psi$, that is *already present* in the Lagrangian, and is therefore not expected to produce a new relevant perturbation. Thus, the scaling variable *cannot* be $\omega_0\xi_\tau$. Rather ω_0 produces only an infinitesimal

shift $g_0 \rightarrow g_0 - i\omega_0$, which, through the above analyticity argument (including also the possibility of complex shifts), alters the free energy in a completely predictable fashion unrelated to scaling. By way of contrast, spatial twists still represent a relevant perturbation, and we therefore predict a scaling form at $\omega_0 = 0$:

$$\delta f^\theta = \beta^{-1} L^{-d} \Phi^\theta [\delta(L/\xi_0)^{1/\nu}, \delta(\beta/\xi_{\tau,0})^{1/\nu_\tau}], \quad (4.12)$$

with $\Phi(x, y) \approx \Phi_1 x^{(d-2)\nu} y^{z\nu}$ for large x, y , yielding $\Upsilon \approx (\Phi_1^\theta/2\pi^2\theta^2)\delta^v$, with $v = (d + z - 2)\nu = 2 - \alpha - 2\nu$ as before. We expect only small subleading corrections in $y^{z\nu}$: since no temporal twist has been imposed, there can be no $O(\beta^{-1}, \beta^{-2})$ corrections.

Now, if we include a finite ω_0 , the basic change in (4.12) is that $g_0 \rightarrow g_0 - i\omega_0$ everywhere, and in addition one must include changes arising from boundary condition dependence of the analytic part of the free energy. One obtains

$$\begin{aligned} \delta f^\theta &= \beta^{-1} L^{-d} \Phi^\theta [\delta_\theta(L/\xi_0)^{1/\nu}, \delta_\theta(\beta/\xi_{\tau,0})^{1/\nu_\tau}] \\ &+ f^0(r_0, g_0 - i\omega_0) - f^0(r_0, g_0), \end{aligned} \quad (4.13)$$

where f^0 is the free energy density in the absence of all twists (i.e., under fully periodic boundary conditions), including both analytic and singular parts, and $\delta_\theta = r_0 - r_{0,c}(g_0 - i\omega_0) \approx \delta + i\omega_0 r'_{0,c}(g_0)$ is the perturbed deviation from the critical line $r_{c,0}(g_0)$. Most importantly, Φ^θ is the *same function* as that in (4.12), and therefore produces only small corrections in $(\beta/\xi_\tau)^{-1}$. The scaling function itself therefore contributes only vanishing corrections to κ in the limit $\beta \rightarrow \infty$.

All contributions to κ are therefore contained in f^0 , and arise from (a) its analytic part, (b) the (linear) ω_0 dependence of δ_θ in its singular part.³⁹ Regarding (b), the leading singular part of f^0 is of the form $f_{\text{sing}}^0 \sim |\delta_\theta|^{2-\alpha}$. The g_0 -dependence of $r_{0,c}$ couples derivatives with respect to g_0 to those with respect to δ , and one obtains therefore contributions $\rho_{\text{sing}} \sim |\delta_\theta|^{1-\alpha}$ to the density and $\kappa_{\text{sing}} \sim |\delta_\theta|^{-\alpha}$ to the compressibility. The hyperscaling relation $\alpha = 2 - (d + z)\nu$ implies that $\alpha < 0$ under the rather weak condition that $\nu > 2/(d + z)$ (which by all evidence to date appears to be strongly satisfied,⁴⁰) and the singular parts of ρ and κ are expected to vanish at criticality. Put slightly differently, given that κ is already nonzero in the Bose glass phase, signifying the existence of long range temporal correlations on both sides of the transition, it would not be surprising to find that the critical singularity, signifying the adjustment of the density of states $\rho_1(\epsilon = 0)$ as the density of large droplets increases, leads to only small corrections to κ .

Regarding (a), the analytic part of the free energy has an expansion

$$\begin{aligned} f_a^0(r_0, g_0) &= -\rho_c(r_0)[g_0 - g_{0,c}(r_0)] \\ &- \frac{1}{2}\kappa_c(r_0)[g_0 - g_{0,c}(r_0)]^2 + \dots, \end{aligned} \quad (4.14)$$

about the transition line $g_{0,c}(r_0)$, where $\rho_c(r_0)$ and $\kappa_c(r_0)$ are now recognized as the finite values of ρ and κ at the

transition. These finite values are predicted irrespective of the value of the exponent z , now seen as unconstrained by the present arguments. Note further that since the leading ω_0 -dependence is linear, if the leading boundary condition dependence were indeed through the scaling combination $\omega_0 \xi_\tau$ (or, more properly, the finite size scaling variable $\delta/\beta^{1/z\nu}$), the leading contribution to the density must take the form $\rho \sim |\delta|^{d\nu}$, contradicting the fact that the density must be finite at the transition.

To end this discussion, it is worth emphasizing why the arguments above fail for the classical random rod model, $g(\mathbf{x}) \equiv 0$. The key point is that $r_{0,c}(g_0)$ is singular at the special value $g_0 = 0$, and δ_θ is no longer an analytic function of ω_0 . Essentially, the special symmetry at $g_0 \equiv 0$ implies that δ and μ are “orthogonal” thermodynamic coordinates and the derivatives with respect to μ that define $\kappa \equiv \kappa_s$ do not mix with derivatives with respect to δ . We have already seen, therefore, that $\kappa \equiv 0$ in the disordered phase. We therefore expect κ to rise continuously from zero for $\delta < 0$, with the exponent $\nu_\tau > 0$. This implies that $z \leq d$ in this case (equality is still permitted and would imply a discontinuity in κ at $\delta = 0$, which indeed is the case in $d = 1$ —see Sec. V). Note that for homogeneous classical disorder, where the coefficient r in (4.1) depends on *both* \mathbf{x} and τ , we will have isotropic scaling, $z = 1$. The rod disorder should increase z .

3. Scaling of correlations

Let us now consider the two-point correlation function,

$$G(\mathbf{x}, \tau) = [\langle \psi(\mathbf{x}, \tau) \psi(\mathbf{0}, 0) \rangle_c]_{\text{av}}, \quad (4.15)$$

whose Fourier transform is normally assumed to scale in the form,

$$\hat{G}(\mathbf{k}, \omega) \approx C |\delta|^{-\gamma} \hat{g}(k\xi, \omega\xi_\tau), \quad (4.16)$$

where γ is the susceptibility exponent. At small k, ω in the superfluid phase, the dynamics is governed by the hydrodynamic Lagrangian (3.29). Since this is now a bulk Lagrangian, with ρ the actual bulk density, with 2π -periodic boundary conditions on the phase ϕ , the $i\rho\partial_\tau\phi$ term integrates to $2\pi i n \rho V = 2\pi i N$, and therefore drops out of $e^{S_{\text{eff}}}$. Recalling that at hydrodynamic scales, $\psi = \psi_0 e^{i\phi}$ where ψ_0 is the order parameter, the resulting Gaussian Lagrangian yields

$$\begin{aligned} G(\mathbf{x}, \tau) &\approx |\psi_0|^2 \left[e^{-\frac{1}{2} \langle [\phi(\mathbf{x}, \tau) - \phi(\mathbf{0}, 0)]^2 \rangle} - e^{-\langle [\phi(\mathbf{0}, 0)]^2 \rangle} \right] \\ &\approx |\psi_0|^2 \langle \phi(\mathbf{x}, \tau) \phi(\mathbf{0}, 0) \rangle, \end{aligned} \quad (4.17)$$

in which fluctuations about the ordered state are assumed small. In Fourier space one therefore obtains

$$\hat{G}(\mathbf{k}, \omega) \approx \frac{|\psi_0|^2}{\Upsilon k^2 + \kappa \omega^2}. \quad (4.18)$$

If one naively matches (4.16) and (4.17), one concludes that $\hat{g}(x, y) \approx (g_1 x^2 + g_2 y^2)$ for small x, y and hence that

$$\frac{\Upsilon}{|\psi_0|^2} \approx \frac{g_1 \xi_0^2}{C |\delta|^{2\nu-\gamma}}, \quad \frac{\kappa}{|\psi_0|^2} \approx \frac{g_2 \xi_{\tau,0}^2}{C |\delta|^{2z\nu-\gamma}}. \quad (4.19)$$

Using the well known scaling relation $\alpha + 2\beta + \gamma = 2$, one recovers (4.11).

However, (4.19) is really just a disguised version of the free energy argument. Thus, S_{eff} assumes that the energetics of global phase twists also describes slowly varying local phase twists. Thus, locally we replace \mathbf{k}_0 by $\nabla\phi$ and ω_0 by $\partial_\tau\phi$, then integrate over space-time. Once again, (4.16)–(4.19) are expected to be valid for the random rod problem. However, for the dirty boson problem, if κ arises from the nonscaling part of the free energy, it is unlikely that it can now arise from the scaling part of the two-point function. Thus, in place of (4.16), we propose instead the scaling form

$$\hat{G}(\mathbf{k}, \omega) \approx \frac{|\psi_0|^2}{D |\delta|^{2-\alpha} \hat{\Gamma}(k\xi, \omega\xi_\tau) + \hat{\Gamma}_a(\mathbf{k}, \omega)}, \quad (4.20)$$

where Γ_a is analytic. Although we presently have no theoretical support for this “self-energy” scaling form, we appeal to the similarity of the denominator to (4.13). If one matches (4.16) to (4.18), one now assumes that $\Gamma(x, y) \approx \gamma_1 x^2$ for small x, y while $\Gamma_a(\mathbf{k}, \omega) \approx \kappa \omega^2$ for small k, ω . The x^2 term yields $\Upsilon \approx D \gamma_1 \xi_0^2 |\delta|^\nu$, with ν given by (4.11) as required. From the analytic term we recover a finite κ without any scaling constraint on z . Standard static scaling, without any unusual analytic corrections, is recovered for $\omega = 0$.

To summarize key the results of this subsection, the leading behavior of κ is governed by the analytic part of the free energy, and is unconstrained (by any argument so far presented) by the dynamical exponent z .²⁹ The critical behavior of κ is governed by the exponent α , and yields only subleading corrections to the analytic behavior.

B. Crossover exponent associated with particle-hole symmetry breaking

Since we expect the presence of $g(\mathbf{x})$ to change the universality class of the the phase transition, there must be an associated positive crossover exponent, ϕ_g , which quantifies the instability of the classical random rod fixed point with respect to this term. What is the value of ϕ_g , and what conditions does it place on the values of the classical fixed point exponents?

To begin to answer this question, let us write $\mathcal{L}_c = \mathcal{L}_0 + \mathcal{L}_g$, where

$$\mathcal{L}_g = \int d^d x \int d\tau \left[\frac{1}{2} g(\mathbf{x})^2 |\psi|^2 - g(\mathbf{x}) \psi^* \partial_\tau \psi \right]. \quad (4.21)$$

We assume (see below) that $[g(\mathbf{x})]_{\text{av}} = 0$, $[g(\mathbf{x})g(\mathbf{x}')]_{\text{av}} = \Delta_g \varphi(\mathbf{x} - \mathbf{x}')$, which implies a statistical particle-hole

symmetry, and that $g(\mathbf{x})$ and $r(\mathbf{x})$ are statistically independent. The correlation function takes the form $\varphi(\mathbf{x}) = \delta(\mathbf{x})$ for uncorrelated disorder, but for reasons that will become evident below, we shall allow more general long-range power-law correlated disorder with

$$\varphi(\mathbf{x}) \sim |\mathbf{x}|^{-(d+a)} \quad (4.22)$$

for large $|\mathbf{x}|$ and some exponent a . The crossover exponent, ϕ_g , which in general will be a function of a , is defined by the following scaling form, valid for small Δ_g :

$$f_s \approx A|\delta_g|^{2-\alpha_0} \Phi_g \left(\frac{B\Delta_g}{|\delta_g|^{\phi_g}} \right) \quad (4.23)$$

where α_0 is the random rod (quantum) specific heat exponent, and the subscript on δ_g is to serve as a reminder that Δ_g will also generate a shift in the position of the critical point: $\delta_g = \delta + c_1\Delta_g + \dots$. The value of ϕ_g may

now be inferred from the derivative

$$\left(\frac{\partial f_s}{\partial \Delta_g} \right)_{\Delta_g=0} \approx A|\delta|^{2-\alpha_0} [B|\delta|^{-\phi_g} - (2-\alpha_0)c_1|\delta|^{-1}], \quad |\delta| \rightarrow 0, \quad (4.24)$$

where we choose A and B so that $\Phi_g(0) = \Phi'_g(0) = 1$. Note the very singular $|\delta|^{-1}$ term generated by the shift, which may often dominate the $|\delta|^{-\phi_g}$ term of interest. Now, this derivative may also be calculated directly within perturbation theory:

$$f(\Delta_g) - f(0) = -\frac{1}{V_D} \left[\langle \mathcal{L}_g \rangle_0 + \frac{1}{2} [\langle \mathcal{L}_g^2 \rangle_0 - \langle \mathcal{L}_g \rangle_0^2] + O(g^3) \right] \quad (4.25)$$

where the averages are with respect to \mathcal{L}_0 . Assuming that $g(\mathbf{x})$ and $r(\mathbf{x})$ self average, we obtain

$$\begin{aligned} f(\Delta_g) - f(0) &= -\frac{1}{V_D} \left[\langle \mathcal{L}_g \rangle_0 + \frac{1}{2} \langle \mathcal{L}_g^2 \rangle_0 + O(g^4) \right] \\ &= -\frac{1}{2} \Delta_g \varphi(\mathbf{0}) [\langle |\psi(\mathbf{0}, 0)|^2 \rangle_0]_{\text{av}} - \frac{1}{2} \Delta_g \int d\tau \int d^d x \varphi(\mathbf{x}) [\langle \psi^* \partial_\tau \psi(\mathbf{x}, \tau) \psi^* \partial_\tau \psi(\mathbf{0}, 0) \rangle_0]_{\text{av}} + O(\Delta_g^2), \end{aligned} \quad (4.26)$$

where independence of $g(\mathbf{x})$ and $r(\mathbf{x})$ has been used. Thus

$$-2 \left(\frac{\partial f}{\partial \Delta_g} \right)_{\Delta_g=0} = \varphi(\mathbf{0}) \varepsilon_0 + \int d\tau \int d^d x \varphi(\mathbf{x}) \mathcal{G}_g(\mathbf{x}, \tau) \quad (4.27)$$

where $\varepsilon_0 = [\langle |\psi|^2 \rangle_0]_{\text{av}}$, and we have defined the correlation function

$$\mathcal{G}_g(\mathbf{x}, \tau) = [\langle \psi^* \partial_\tau \psi(\mathbf{x}, \tau) \psi^* \partial_\tau \psi(\mathbf{0}, 0) \rangle_0]_{\text{av}}. \quad (4.28)$$

Let us define the Fourier transforms

$$\begin{aligned} \hat{\varphi}(\mathbf{k}) &= \int d^d x e^{i\mathbf{k}\cdot\mathbf{x}} \varphi(\mathbf{x}) \\ \hat{\mathcal{G}}_g(\mathbf{k}, \omega) &= \int d\tau \int d^d x e^{i(\mathbf{k}\cdot\mathbf{x} + \omega\tau)} \mathcal{G}_g(\mathbf{x}, \tau). \end{aligned} \quad (4.29)$$

Then when $g(\mathbf{x}) \equiv 0$ we have from (4.6),

$$\Upsilon_\tau = \varepsilon_0 + \hat{\mathcal{G}}_g(\mathbf{0}, 0) \sim |\delta|^{(d-z_0)\nu_0}, \quad (4.30)$$

where the exponents are appropriate to the random rod problem. More generally we expect a scaling form for small $|\mathbf{k}|$ and ω :

$$\Upsilon_\tau(\mathbf{k}, \omega) \equiv \varepsilon_0 + \hat{\mathcal{G}}_g(\mathbf{k}, \omega) \approx A_1 |\delta|^{(d-z_0)\nu_0} \mathcal{Y}(k\xi, \omega\xi_\tau) \quad (4.31)$$

where for $\delta > 0$ we have $\lim_{w, s \rightarrow 0} \mathcal{Y}(w, s) = 0$ while for $\delta < 0$ we have $\lim_{w, s \rightarrow 0} \mathcal{Y}(w, s) = 1$. Thus,

$$\begin{aligned} -2 \left(\frac{\partial f}{\partial \Delta_g} \right)_{\Delta_g=0} &= \varphi(\mathbf{0}) \varepsilon_0 + \int_{\mathbf{k}} \hat{\varphi}(\mathbf{k}) \hat{\mathcal{G}}_g(\mathbf{k}, \omega = 0) \\ &= \int_{\mathbf{k}} \hat{\varphi}(\mathbf{k}) \Upsilon_\tau(\mathbf{k}, 0), \end{aligned} \quad (4.32)$$

where we have used the convenient shorthand notation $\int_{\mathbf{k}} \equiv \int \frac{d^d k}{(2\pi)^d}$, $\int_\omega \equiv \int \frac{d\omega}{2\pi}$, etc. For uncorrelated disorder, $\hat{\varphi}(\mathbf{k}) \equiv 1$, while for power law correlated behavior, $\hat{\varphi}(\mathbf{k}) \approx c_a k^a + c_0 + \dots$ as $k \rightarrow 0$, where a was defined in (4.22). The final k -integral must be treated carefully to extract its δ -dependence. Let us rewrite

$$\tilde{\mathcal{Y}}(w) = w^{z_0-d} \mathcal{Y}(w, 0), \quad \tilde{\mathcal{Y}}(w \rightarrow \infty) \rightarrow y_0 > 0, \quad (4.33)$$

where the finite limit follows from the requirement that $\Upsilon(\mathbf{k}, 0)$ should be a well defined function of \mathbf{k} alone (in this case a power law $\propto y_0 k^{d-z}$) when $\delta = 0$. Clearly one cannot simply scale ξ out of the integral in (4.15) since the resulting integral over $\hat{\varphi}(w/\xi) w^{d-z} \tilde{\mathcal{Y}}_\pm(w)$ will not converge. Rather, one must first subtract out the large w behavior. Let us write

$$\tilde{\mathcal{Y}}(w) \approx y_0 + y_1 w^{-\omega_1} + y_2 w^{-\omega_2} + y_3 w^{-\omega_3} + \dots \quad (4.34)$$

where the source of the spectrum of exponents, $0 < \omega_1 < \omega_2 < \omega_3 < \dots$, will be discussed below. Each term

$y_j w^{-\omega_j}$ yields a contribution

$$\int_{\mathbf{k}} \hat{\varphi}(\mathbf{k}) y_j k^{d-z_0} (k\xi)^{-\omega_j} = b_j |\delta|^{\omega_j \nu} \\ b_j \equiv \xi_0^{-\omega_j} y_j \int_{\mathbf{k}} \hat{\varphi}(\mathbf{k}) k^{-\omega_j + d - z_0}, \quad (4.35)$$

so long as $\omega_j < \omega_{\max}(a) \equiv 2d - z_0 + \min\{a, 0\}$ (i.e., the integral converges at small k ; convergence at large k being ensured by the implicit lattice cutoff, $k < k_\Lambda \sim \frac{\pi}{a}$). Let us define the subtracted scaling function,

$$\delta \tilde{\mathcal{Y}}(w) = \tilde{\mathcal{Y}}(w) - \sum_{\omega_j < \omega_{\max}(a)} y_j w^{-\omega_j}. \quad (4.36)$$

Then

$$\int_{\mathbf{k}} \hat{\varphi}(\mathbf{k}) \tilde{\mathcal{Y}}(k\xi) k^{d-z_0} \approx \sum_{\omega_j < \omega_{\max}(a)} b_j |\delta|^{\omega_j \nu} \\ + \int_{\mathbf{k}} k^{d-z_0} \hat{\varphi}(\mathbf{k}) \delta \tilde{\mathcal{Y}}(k\xi), \quad (4.37)$$

where the last term may be evaluated as

$$\int_{\mathbf{k}} k^{d-z_0} \hat{\varphi}(\mathbf{k}) \delta \tilde{\mathcal{Y}}(k\xi) \approx b_a |\delta|^{(2d-z_0+a)\nu} + b_0 |\delta|^{(2d-z_0)\nu}, \\ b_a \equiv c_a \int_{\mathbf{w}} w^{d-z_0+a} \delta \tilde{\mathcal{Y}}(w) \\ b_0 \equiv c_0 \int_{\mathbf{w}} w^{d-z_0} \delta \tilde{\mathcal{Y}}(w). \quad (4.38)$$

In fact $b_0 = 0$ in our case because, tracing through the definitions, the integral is dominated by the large τ limit of $\mathcal{G}_g(\mathbf{0}, \tau)$, which is proportional to the square of $\langle \psi^* \partial_\tau \psi \rangle_0$. The latter vanishes by particle-hole symmetry of the random rod model.

Now, the origin of the exponents ω_j is as follows: the operator

$$P \equiv \int d^d x \int d\tau \int d\tau' \psi^* \partial_\tau \psi(\mathbf{x}, \tau) \psi^* \partial_{\tau'} \psi(\mathbf{x}, \tau') \quad (4.39)$$

will have an operator product expansion in terms of eigenoperators of a renormalization group transformation near the critical fixed point of interest: $P = h_1 O_1 + h_2 O_2 + h_3 O_3 + \dots$, and O_i is assumed to have renormalization group eigenvalue λ_i . This implies that $\langle P \rangle \sim h_1 |\delta|^{(d+z_0-\lambda_1)\nu} + h_2 |\delta|^{(d+z_0-\lambda_2)\nu} + \dots$. But since $\langle P \rangle = \int_{\mathbf{k}} \tilde{\mathcal{Y}}(k\xi) k^{d-z_0}$, comparison with (4.34) and (4.35) implies that $\omega_j = d + z_0 - \lambda_j$. The ω_j therefore reflect the renormalization group transformation properties of P near the fixed point.

We can now understand the crossover exponent, ϕ_g . Comparing (4.24) and (4.37) together with (4.38) (with $b_0 = 0$), we see that

$$2 - \alpha_0 - \phi_g = \nu \min\{\omega_j, 2d - z_0 + a\} \\ \Rightarrow \lambda_g \equiv \frac{\phi_g}{\nu} = \max\{\lambda_j, 2z_0 - d - a\}. \quad (4.40)$$

The crossover exponent is therefore either $\phi_g = \lambda_1 \nu$, or for small enough a , $\phi_g = (2z_0 - d - a)\nu$. Thus

$$\lambda_g = \begin{cases} 2z_0 - d - a, & a < 2z_0 - d - \lambda_1 \\ \lambda_1, & a > 2z_0 - d - \lambda_1, \end{cases} \quad (4.41)$$

implying

$$\phi_g > 0 \Leftrightarrow \begin{cases} z_0 > \frac{d+a}{2}, & a < 2z_0 - d - \lambda_1 \\ \lambda_1 > 0, & a > 2z_0 - d - \lambda_1. \end{cases} \quad (4.42)$$

In particular, for short range correlated disorder, where in effect $a \rightarrow \infty$, we require $\lambda_1 > 0$ in order that dirty boson disorder destabilize the random rod fixed point. The exponent λ_1 is a nontrivial exponent, and we shall compute it within the ϵ, ϵ_τ -expansion.¹⁵

A naive estimate for λ_1 is obtained by supposing that the equality $2z_0 - d - a = \lambda_1$ should occur when $a \simeq 0$, yielding $\lambda_1 \simeq 2z_0 - d$ which becomes positive for $z_0 > \frac{d}{2}$. Note that this same estimate would have been obtained from the second term in (4.21) if we had assumed $b_0 \neq 0$. As an aside, this estimate is actually exact in the corresponding derivation of the Harris criterion for classical disordered magnets. There the correlation function $\langle |\psi(\mathbf{x})|^2 |\psi(\mathbf{y})|^2 \rangle_0$ appears. Since $\langle \psi^2 \rangle_0$ does not vanish, neither does the coefficient analogous to b_0 . This gives rise to a free energy contribution $\langle |\psi|^2 \rangle_0^2 \sim \delta^{2-2\alpha_0}$ which leads immediately to the Harris criterion, $\phi_g = \alpha_0$.

In fact, we shall find that $\lambda_1 > 2z_0 - d$, i.e., a drops out at some negative value, and ϕ_g becomes positive for z_0 larger than a value somewhat *less* than $\frac{d}{2}$. The random rod result $z_0 = 1$ in $d = 1$ is consistent with this criterion, although this case is somewhat special because the random rod fixed point is the *same* as the pure fixed point in $d = 1$ (i.e., random rod disorder is irrelevant, though boson disorder is relevant). The generalized Harris criterion¹⁵ indicates that rod disorder is irrelevant when $\alpha_{\text{pure}} + \nu_{\text{pure}} < 0$. Using hyperscaling (valid here for $d < 3$), and the fact that $z = 1$ at the pure fixed point, this requires $\nu_{\text{pure}} > \frac{2}{d}$ (compare the less stringent requirement, $\nu_{\text{pure}} > \frac{2}{d_{\text{tot}}}$ with $d_{\text{tot}} = d + 1$, for the usual Harris criterion for point disorder). For $d = 1$, $\nu_{\text{pure}} \rightarrow \infty$, while for $d = 2$, $\nu_{\text{pure}} \simeq \frac{2}{3}$, so the pure fixed point becomes unstable to rod disorder somewhere in between $d = 1$ and $d = 2$. In all cases where rod disorder is irrelevant, one then trivially has $z_0 > \frac{d}{2}$, and dirty boson disorder will certainly be relevant.

We now turn to the question of the relevance of $g_0 \equiv [g(\mathbf{x})]_{\text{av}}$, i.e., of full breaking of particle-hole symmetry. If one carries through a naive scaling analysis using $\mathcal{L}_{g_0} = \int d^d x \int d\tau (\frac{1}{2} g_0^2 |\psi|^2 - g_0 \psi^* \partial_\tau \psi)$ in place of (4.21), one obtains $\partial f / \partial g_0 = 0$, while

$$-\frac{\partial^2 f}{\partial g_0^2} = \varepsilon_0 + \hat{\mathcal{G}}_g(\mathbf{0}, 0) = \Upsilon_\tau \sim |\delta|^{(d-z_0)\nu_0}. \quad (4.43)$$

If the g_0 -dependence of the singular part of the free energy scales in the form

$$f_s = A' \delta^{(d+z_0)\nu} \Phi_{g_0} \left(\frac{g_0}{|\delta|^{\phi_{g_0}}} \right), \quad (4.44)$$

it is tempting to identify the crossover exponent ϕ_{g_0} via

$$2 - \alpha_0 - 2\phi_{g_0} = (d - z_0)\nu \Rightarrow \phi_{g_0} = z_0\nu \quad (4.45)$$

which is always strongly positive. In the absence of all disorder, this is the correct exponent (with $z_{\text{pure}} = 1$, and $\nu_{\text{pure}} = \nu_{d+1}^{\text{XY}}$) describing the crossover from the $(d + 1)$ -dimensional XY behavior at the tip of the Mott lobe, to the generic onset of superfluidity in a dilute Bose gas as the density is increased from zero away from the tip. This same exponent describes the shape of the pure system Mott lobes near their tips, Fig. 1(a): since the transition line is defined by some critical value x_c of the scaling function argument $x = g_0/|\delta|^{\phi_{g_0}}$, this leads to $g_{0,c} \approx x_c|\delta|^{\phi_{g_0}}$, i.e.,⁶

$$\mu_c(J_0) \sim |J_0 - J_c^0|^{\nu_{d+1}^{\text{XY}}}. \quad (4.46)$$

The same argument implies that

$$\mu_c(J_0) \sim |J_0 - J_c^{\text{RR}}|^{z_0\nu_0} \quad (4.47)$$

near the random rod critical points in Fig. 1(c). It is likely that $z_0\nu_0 > 1$ in $d = 3$, leading to the pictured cusps.¹⁵

One must be careful in interpreting the result (4.45) in the presence of random rod disorder. The random rod problem leads to an incompressible glassy phase [see Fig. 1(c)]. Perturbing the random rod critical point with either g_0 or Δ_g therefore not only changes the critical behavior, but also the nature of the glassy phase. The difference between ϕ_g in (4.40) and ϕ_{g_0} in (4.45) therefore reflects the different rates at which the crossover to the Bose glass phase occurs under the influence of the two perturbations, with g_0 clearly having the stronger effect.

We emphasize that the two crossover exponents describe, in renormalization group language, the rate at which one is initially driven away from the random rod fixed point in the two orthogonal directions described by g_0 and Δ_g . They tell one nothing about the eventual termination of the flows on some new stable fixed point. We have argued physically, supported by the droplet picture of Sec. III, that although initially growing rapidly, g_0 must vanish again as the dirty boson fixed point is approached, its main role being to induce a finite value of Δ_g under renormalization. Quantifying this expected *irrelevance* of g_0 (i.e., $\phi_{g_0} < 0$) at the commensurate dirty boson fixed point,⁴¹ would require an analysis of the right hand side of (4.43) in the presence of a finite value of Δ_g . We saw in the previous subsection that in this case $\tilde{\Upsilon}_\tau = \kappa$ is dominated by analytic terms in the free energy, and hence that ϕ_{g_0} is related to subleading terms in the singular part of the free energy that cannot be inferred from a simple scaling analysis. In Sec. VI we will obtain ϕ_{g_0} within the ϵ, ϵ_τ -expansion, and demonstrate explicitly the manner in which particle-hole asymmetry becomes irrelevant at the commensurate fixed point for sufficiently large ϵ_τ .

V. CALCULATIONS IN ONE DIMENSION

A. Sine-Gordon model

In this section we review and expand upon the analysis of one-dimensional versions of the dirty boson problem, with emphasis on the weak disorder limit.^{6,42} In App. B we derive various dual representations for the one-dimensional Lagrangian based on the discrete-time Villain representation, (B4). We shall analyze the sine-Gordon version, (B14) with (B15):

$$\begin{aligned} \mathcal{L}_{\text{SG}} = & -\frac{1}{2} \sum_{\mathbf{R}} \left[\frac{1}{K_I} (\partial_T S_{\mathbf{R}})^2 + V_0 (\partial_I S_{\mathbf{R}})^2 \right] \\ & + \sum_{\mathbf{R}} \mu_I (\partial_I S_{\mathbf{R}}) + 2y_0 \sum_{\mathbf{R}} \cos(2\pi S_{\mathbf{R}}), \end{aligned} \quad (5.1)$$

where we have assumed that $V_{IJ} \equiv V_0 \delta_{IJ}$ is diagonal. Here $\mathbf{R} = (I, T)$, with integer I, T , are points on a discrete space-time (dual) lattice, $-\infty < S_{\mathbf{R}} < \infty$ are continuous spin variables, the discrete derivatives are defined by $\partial_I S_{\mathbf{R}} = S_{(I+1, T)} - S_{(I, T)}$, $\partial_T S_{\mathbf{R}} = S_{(I, T+1)} - S_{(I, T)}$, and the cosine term represents an external periodic potential which prefers integer values of $S_{\mathbf{R}}$. This model has the physical interpretation of a fluctuating interface, represented by the ‘‘height’’ variables $S_{\mathbf{R}}$. The coefficient K_I is proportional to the Josephson coupling [see equation (B1)]. In the absence of μ_I , which has the interpretation of a random tilt potential, the phase transition in this model is from a flat phase at large $1/K_I$, where $S_{\mathbf{R}}$ has only small fluctuations about some integer value and exponentially decaying correlations, to a rough phase, at large K_I , in which the interface wanders and has logarithmically divergent height-height correlations. This rough phase corresponds to the superfluid phase in the boson model, and the renormalized, long wavelength value of y_0 vanishes. In the presence of the random tilting potential, μ_I , the rough phase is qualitatively unchanged, but the flat phase is no longer necessarily quite so flat: see below.

Let us decompose $\mu_I = \mu_0 + \delta\mu_I$ into a uniform part μ_0 and a random part with $[\delta\mu_I]_{\text{av}} = 0$. Thus, nonzero μ_0 represents the breaking of particle-hole symmetry. When $\mu_0 = 0$ the interface will be globally flat. For sufficiently large $\mu_0 > \mu_{0,c}$, where $\mu_{0,c}$ represents the Mott gap (which will vanish for some combination of sufficiently large $\delta\mu_I$, large K_I , small V_0 and small y_0) the interface will acquire a global tilt, with $[(S_{\mathbf{R}} - S_{\mathbf{R}'}')]_{\text{av}} = Q_0(I - I')$. The exact form of the slope function

$$Q_0(\mu_0, K_0, V_0, y_0) = [(\partial_I S_{\mathbf{R}})]_{\text{av}} = -\frac{\partial f_{\text{SG}}}{\partial \mu_0}, \quad (5.2)$$

which is proportional to the density difference from the Mott phase, can be computed perturbatively in powers of y_0 (see below). In the special case $\mu_I/V_0 = \frac{1}{2}$, the spatial derivative terms in (5.1) may be combined in the form $V_0(\partial_I S_{\mathbf{R}} - \frac{1}{2})^2$, and there is an exact degeneracy between $\partial_I S_{\mathbf{R}} = 0, 1$ (the integer values preferred by the

cosine term). This is the particle-hole symmetric model at half filling, $Q_0 = \frac{1}{2}$.^{18,25,43}

B. Perturbation theory in the superfluid phase

Let us define the random walk

$$w_I = \frac{1}{V_0} \sum_{J=0}^I \delta\mu_J, \quad (5.3)$$

(defined to be minus the sum from $J = I$ to 0 for $I < 0$), and let

$$\tilde{S}_{\mathbf{R}} = S_{\mathbf{R}} - Q_0 I - w_I, \quad \mathbf{R} = (I, T). \quad (5.4)$$

With this choice, one will have $[\langle \tilde{S}_{\mathbf{R}} - \tilde{S}_{\mathbf{R}'} \rangle]_{\text{av}} \equiv 0$. The sine-Gordon Lagrangian takes the form

$$\begin{aligned} \mathcal{L}_{SG} = & \frac{1}{2} \sum_{\mathbf{R}} \left[\frac{1}{K_I} (\partial_T \tilde{S}_{\mathbf{R}})^2 + V_0 (\partial_I \tilde{S}_{\mathbf{R}})^2 \right] \\ & - 2y_0 \sum_{\mathbf{R}} \cos[2\pi(\tilde{S}_{\mathbf{R}} + w_I + Q_0 I)] \\ & + E_0 \beta L, \end{aligned} \quad (5.5)$$

where the constant term is

$$\begin{aligned} E_0 = & -\frac{1}{\beta L} \sum_{\mathbf{R}} \frac{(Q_0 V_0 + \delta\mu_I)(2\mu_0 - Q_0 V_0 + \delta\mu_I)}{2V_0} \\ = & -\frac{[\delta\mu_I^2]_{\text{av}}}{2V_0} - \mu_0 Q_0 + \frac{1}{2} V_0 Q_0^2. \end{aligned} \quad (5.6)$$

In (5.4) we have dropped a sub-extensive boundary term $-(\mu_0 - Q_0 V_0) \sum_{\mathbf{R}} \partial_I \tilde{S}_{\mathbf{R}}$ since $\sum_{\mathbf{R}} \partial_I \tilde{S}_{\mathbf{R}} = \sum_T (\tilde{S}_{L,T} - \tilde{S}_{0,T}) = O(\sqrt{\beta L})$, and therefore yields vanishing contribution in the thermodynamic limit. This term may in fact be made to vanish identically by choosing periodic boundary conditions for $\tilde{S}_{\mathbf{R}}$.

The explicit dependence on μ_0 is only in the last (constant) term of (5.5), and it follows from (5.2) that Q_0 may be determined by minimizing the free energy at fixed μ_0 :

$$\left(\frac{\partial f_{SG}}{\partial Q_0} \right)_{\mu_0} = 0. \quad (5.7)$$

When $y_0 = 0$ the condition (5.7) yields $Q_0 = \mu_0/V_0$ and the $\delta\mu_I$ yield only a trivial additive constant to the free energy. In this limit, for $K_I \equiv K_0$ fixed, the two-point correlation function is given by

$$\begin{aligned} G(\mathbf{R} - \mathbf{R}') & \equiv \frac{1}{2} \langle (\tilde{S}_{\mathbf{R}} - \tilde{S}_{\mathbf{R}'})^2 \rangle_0 \\ & \approx \frac{1}{2\pi} \sqrt{\frac{K_0}{V_0}} \ln \left[\frac{\rho(\mathbf{R} - \mathbf{R}')}{\rho_0} \right], \quad \rho \rightarrow \infty, \end{aligned} \quad (5.8)$$

where,

$$\rho(\mathbf{R} - \mathbf{R}') = \left[\frac{1}{K_0 V_0} (I - I')^2 + K_0 V_0 (T - T')^2 \right]^{\frac{1}{2}} \quad (5.9)$$

is the appropriately rescaled distance, and $\rho_0 = O(1)$ is a constant scale factor. When K_I fluctuates, its disorder average must be included. The result is still (5.8), but K_0 then becomes a complicated effective parameter. The generalized Harris criterion (Ref. 15 and Sec. IV) implies that disorder in the coefficient K_0 is an *irrelevant* perturbation at the pure (2D XY) critical point at integer filling in $d = 1$, so we will, for the rest of this section, simply take $K_I \equiv K_0$ when considering the influence of the $\delta\mu_I$.

Let us then consider the y_0 term as a perturbation on the quadratic term in \mathcal{L}_{SG} . Deep in the superfluid/rough phase, where K_0/V_0 is large, this is a well defined expansion. It is also well defined when Q_0 is not too small: the cosine term in (5.4) then oscillates very rapidly from site to site, and effectively averages itself out. This corresponds to the region between Mott lobes in Fig. 1. The condition (5.7) leads to

$$Q_0 = \frac{\mu_0}{V_0} - C_0(\mu_0, K_0, V_0, \Delta) y_0^2 + O(y_0^4), \quad (5.10)$$

where the positive coefficient of the correction term is given by

$$C_0 = \frac{4\pi}{V_0} \sum_{\mathbf{R}} I [\langle \sin[2\pi(S_{\mathbf{R}} - S_0 + w_I + Q_0 I)] \rangle_0]_{\text{av}}, \quad (5.11)$$

in which the thermodynamic average is with respect to the Gaussian Lagrangian $\mathcal{L}_{SG}(y_0 = 0)$. To evaluate this further we assume that the $\delta\mu_I$ are independent, with a symmetric distribution. Let us define a measure of the disorder strength, Δ , via

$$\left[e^{i \frac{2\pi}{V_0} \delta\mu_I} \right]_{\text{av}} \equiv e^{-2\pi^2 \Delta^2}. \quad (5.12)$$

Then,

$$C_0 = \frac{4\pi}{V_0} \sum_{\mathbf{R}} e^{-4\pi^2 G(\mathbf{R})} e^{-2\pi^2 \Delta^2 |I|} I \sin(2\pi\mu_0 I/V_0). \quad (5.13)$$

The sum over I clearly converges. Using (5.8), it is easily seen that the sum over T converges so long as $\omega_0 \equiv 2\pi\sqrt{K_0/V_0} > 1$. We shall see below that the superfluid phase is defined by $\omega_0 > 3$, so this condition is indeed met.

The corrugation due to y_0 therefore slows the rate of climb of the interface from its unperturbed rate, μ/V_0 . When K_0/V_0 and μ_0 become small this perturbation theory breaks down—a signal of the phase transition into the Bose glass phase.

C. Stability of the superfluid phase

We consider now the stability of the superfluid phase to y_0 . In Ref. 6 this analysis was performed using Kosterlitz-Thouless-type renormalization group methods. Here we will take a less sophisticated route and adapt the scaling approach described in Sec. IV B. This calculation will

also allow us to examine the effects of finite μ_0 on this stability. The latter will allow an explicit confirmation of the irrelevance of full particle-hole symmetry breaking at the commensurate (statistically particle-hole symmetric) critical point.

We consider the relevance of the cosine term on the fixed line, characterized by the long-range correlations (5.8). To this end, define the local operator

$$O_{\mathbf{R}} = \cos \left[2\pi(\tilde{S}_{\mathbf{R}} + w_I + Q_0 I) \right], \quad (5.14)$$

and introduce a ‘‘temperature’’ variable, analogous to δ in Sec. IV, by adding a mass term

$$\frac{1}{2}t \sum_{\mathbf{R}} \tilde{S}_{\mathbf{R}}^2 \quad (5.15)$$

to \mathcal{L}_{SG} . By this device we may discuss the relevance of the y_0 term to the critical behavior as $t \rightarrow 0$. To this end, we postulate a scaling form for the singular part of the free energy,

$$f_s(y_0) \approx At^{2-\alpha} \Phi \left(\frac{By_0^2}{t\phi_y} \right) \quad (5.16)$$

so that

$$\frac{1}{2} \left(\frac{\partial^2 f_s}{\partial y_0^2} \right)_{y_0=0} \approx ABt^{2-\alpha-\phi_y} \Phi'(0). \quad (5.17)$$

The superfluid phase always occurs at $y_0 = 0$, so there will be no shift in the critical value $t = 0$. As usual, the y_0 term is relevant if $\phi_y > 0$.

The derivative in (5.17) may be computed in terms of the average

$$\begin{aligned} \left(\frac{\partial^2 f_{SG}}{\partial y_0^2} \right)_{y_0=0} &= -\frac{4}{\beta L} \left[\left\langle \left(\sum_{\mathbf{R}} O_{\mathbf{R}} \right)^2 \right\rangle_0 \right]_{\text{av}} \\ &= -4 \sum_{\mathbf{R}} e^{-2\pi^2 \Delta^2 |I|} e^{-4\pi^2 G(\mathbf{R}, t)} \cos(2\pi Q_0 I), \end{aligned} \quad (5.18)$$

where (5.12) has been used, and where

$$\begin{aligned} G(\mathbf{R}, t) &= \left[\left(-\frac{1}{K_0} \partial_T^2 - V_0 \partial_I^2 + t \right) \delta_{\mathbf{R}\mathbf{R}'} \right]_{\mathbf{R}, \mathbf{0}}^{-1} \\ &\approx \int_{k, \omega} \frac{1 - e^{i(kI + \omega T)}}{\omega^2 / K_0 + V_0 k^2 + t}, \quad |\mathbf{R}| \rightarrow \infty. \end{aligned} \quad (5.19)$$

For $t \rightarrow 0$, $G(\mathbf{R}, t)$ has the logarithmic form (5.7). For finite t one may write

$$e^{-4\pi^2 G(\mathbf{R}, t)} \approx [\rho(\mathbf{R})/\rho_0]^{-\omega_0} E[\rho(\mathbf{R})^2 t / \rho_0^2], \quad |\mathbf{R}| \rightarrow \infty, \quad (5.20)$$

where $\omega_0 = 2\pi\sqrt{K_0/V_0}$ determines the power law decay of correlations at criticality (i.e., in the superfluid phase) and the scaling function $E(w)$ decays exponentially for large w [this can be seen explicitly by writing $G(\mathbf{R}, t) =$

$G(\mathbf{R}, 0) + \delta G(\mathbf{R}, t)$ and using (5.19)] and $E(0) = 1$. This exhibits the scaling of the correlations when $y_0 = 0$, and and since ρ scales with \sqrt{t} one immediately identifies the correlation length exponent $\nu = \frac{1}{2}$.

In addition to the subleading singular part we seek, (5.18) contains analytic terms in t , whose Taylor coefficients may be evaluated by taking derivatives of (5.18) with respect to t at $t = 0$. Let n be the first positive integer such that the n th derivative of (5.18) diverges as $t \rightarrow 0$. Since each derivative of (5.20) with respect to t brings a factor of $\rho(\mathbf{R})^2 \sim |\mathbf{R}|^2$ out of the scaling function, this divergence arises from a failure of the integral to converge at infinity. The leading singularity may therefore be computed exactly by considering only the large $|\mathbf{R}|$ asymptotic behavior of the integrand. In this limit one may perform the strongly convergent sum over I by setting $I = 0$ inside G . Defining,

$$D_0 = -8 \sum_I \cos(2\pi Q_0 I) e^{-2\pi^2 \Delta^2 |I|}, \quad (5.21)$$

one finds

$$\begin{aligned} \frac{\partial^n}{\partial t^n} \left(\frac{\partial^2 f_{SG}}{\partial y_0^2} \right)_{y_0=0} &\approx 2D_0 \int_{T_1}^{\infty} dT \left(\frac{K_0 V_0 T^2}{\rho_0^2} \right)^{n_0 - \omega_0/2} \\ &\quad \times E^{(n)}(K_0 V_0 T^2 t / \rho_0^2) \\ &\approx E_0 D_0 t^{(\omega_0 - 1)/2 - n}, \end{aligned} \quad (5.22)$$

where $E^{(n)}(x)$ is the n th derivative of $E(x)$, $T_1 = O(1)$ is a lower cutoff [whose arbitrariness yields only subleading corrections to the last line of (5.22)], and with coefficient

$$E_0 = \frac{\rho_0}{\sqrt{K_0 V_0}} \int_0^{\infty} u^{2n_0 - \omega_0} E^{(n)}(u^2) du. \quad (5.23)$$

It is clear at this point that the $n \geq 0$ we seek is the first integer for which $\omega_0 - 2n - 1 < 0$. One finally obtains the singular part

$$\left(\frac{\partial^2 f_{SG}}{\partial y_0^2} \right)_{y_0=0, \text{sing}} = E_0 D_0 \frac{\Gamma[(\omega_0 + 1)/2 - n]}{\Gamma[(\omega_0 + 1)/2]} t^{(\omega_0 - 1)/2} \quad (5.24)$$

From (5.7) and (5.8) we see that, up to scale factors, space-time is isotropic. Thus $z = 1$ and hyperscaling yields $2 - \alpha = 2\nu$, so that from (5.17) we may finally identify

$$\phi_y = \frac{3 - \omega_0}{2} = \frac{3}{2} - \pi \sqrt{K_0/V_0}. \quad (5.25)$$

Hence y_0 becomes relevant when $\sqrt{K_0/V_0} < \frac{3}{2\pi}$. This should be compared to the analogous result, $\sqrt{K_0/V_0} < \frac{2}{\pi}$, for the usual Kosterlitz-Thouless transition where $\mu_I \equiv 0$. Thus, the interface roughens *earlier* (i.e., at smaller K_0), meaning that superfluidity is *more* stable, in the presence of disorder. For $\sqrt{K_0/V_0} > \frac{3}{2\pi}$, y_0 is irrelevant and may be set to zero to calculate universal quantities near the phase transition. At the critical point

one has $\omega \equiv \omega_c = 3$, which should be compared to the Kosterlitz-Thouless value, $\omega_c = 4$. One may then, for example, invert the duality transformation in this limit to obtain the actual superfluid correlation function. One finds that (B4), with (B16), takes the form

$$\tilde{\mathcal{L}}_J(y_0 \rightarrow 0) = -\frac{1}{2} \sum_{\mathbf{r}} \left[K_0 (\tilde{\phi}_{\mathbf{r}+\hat{x}} - \tilde{\phi}_{\mathbf{r}})^2 + \frac{1}{V_0} (\tilde{\phi}_{\mathbf{r}+\hat{z}} - \tilde{\phi}_{\mathbf{r}})^2 \right], \quad (5.26)$$

where $\mathbf{r} = (i, \tau)$ is the direct lattice integer position vector and where now $-\infty < \tilde{\phi}_{\mathbf{r}} < \infty$ is a continuous phase variable [since (B16) forces $\nabla \times \mathbf{m} \equiv 0$ as $y \rightarrow 0$, we may write $\mathbf{m} = \nabla p$, where p is an integer scalar field, then define $\tilde{\phi}_{\mathbf{r}} = \phi_{\mathbf{r}} - 2\pi p_{\mathbf{r}}$]. Thus

$$\mathcal{G}(\mathbf{r}) \equiv \langle e^{i(\phi_{\mathbf{r}} - \phi_{\mathbf{0}})} \rangle = \langle e^{i(\tilde{\phi}_{\mathbf{r}} - \tilde{\phi}_{\mathbf{0}})} \rangle \sim \tilde{\rho}(\mathbf{r})^{-\eta}, \quad \eta = \frac{1}{\omega}, \quad (5.27)$$

where $\tilde{\rho}(\mathbf{r})$ is the same as $\rho(\mathbf{r})$ in (5.6), but with $K_0 V_0$ replaced by $\frac{1}{K_0 V_0}$. The exponent η is defined in such a way that $\mathcal{G}(i, \tau = 0) \sim |i|^{-(d+z-2+\eta)}$ at criticality. Equation (5.27) then follows since $d = z = 1$ and $\tilde{\rho}(i, \tau = 0) \propto |i|$ for large $|i|$. At the critical point we have $\eta = \frac{1}{3}$, which should be compared to the usual Kosterlitz-Thouless value, $\eta = \frac{1}{4}$.

The above calculation was performed at $y_0 = 0$. When $y_0 > 0$, in the region where it is irrelevant, the parameters K_0 and V_0 in the Lagrangians (5.5) and (5.26) must be renormalized to values $K_R(y_0)$ and $V_R(y_0)$ before setting $y_0 = 0$ in the derivation of (5.27). Thus $\omega = 2\pi\sqrt{K_R/V_R}$ and $\phi_y = \frac{3}{2} - \pi\sqrt{K_R/V_R}$, but the relation $\eta = \frac{1}{\omega}$ is still exact. The parameters K_R and V_R are the exact, long wavelength (hydrodynamic) interface stiffness moduli that a bulk experimental probe would measure, and are directly analogous to the superfluid density and compressibility in the superfluid problem—see (3.29). The above analysis shows that when the ratio $\sqrt{V_R/K_R}$ exceeds the universal value $\frac{2\pi}{3}$, y_0 becomes relevant, and simple renormalization of the Gaussian Lagrangian (5.26) is invalid. We then expect $V_R/K_R \rightarrow \infty$, and the interface becomes localized. At the critical point separating the localized and delocalized phases, the interface is still delocalized, with the universal parameter values quoted above. Using renormalization group techniques, all of these results may be confirmed by constructing the detailed flows around this fixed point.^{6,42}

D. Restoration of particle-hole symmetry in 1D

Recall now the discussion in Secs. IC and IVB of asymptotic restoration of statistical particle-hole symmetry—namely the irrelevance of μ_0 in the presence of nonzero $\delta\mu_I$. This is seen trivially in the 1D case because the critical fixed point occurs at $y_0 = 0$, at which point the mapping $S_{\mathbf{R}} = \tilde{S}_{\mathbf{R}}$, Eq. (5.4) with $Q_0 = \mu_0$,

entirely eliminates μ_0 , as well as all the $\delta\mu_I$, from (5.5), except for the analytic additive term (5.6). One therefore obtains in this case a rather extreme form of irrelevance, in which the influence of μ_0 does not decay with a characteristic exponent $\phi_{g_0} < 0$, but actually disappears entirely.

More generally, when both μ_0 and y_0 are nonzero, the fact that μ_0 appears only in the cosine term in (5.5) means that its influence must vanish on large length scales whenever y_0 is irrelevant. Examining the scaling analysis (5.17)–(5.25), used to determine the range of this irrelevance, one sees that μ_0 (via Q_0) appears only in the cosine factor in (5.21). This factor is completely dominated by the exponential decay due to the fluctuating part of the μ_I , and is therefore of no real consequence, producing only analytic corrections multiplying the leading singularity, and therefore having no influence on the value of the crossover exponent ϕ_y . The ultimate origin of this result can be seen in (5.14): only the value of $\theta_I \equiv w_I \bmod 2\pi$ is important, and when the variance measure, Δ , of $\delta\mu_I$ is sufficiently large this field is basically uniformly distributed over the interval $[0, 2\pi)$, irrespective of the “mean drift” $\mu I/V_0$.

Note, finally, that the irrelevance of a uniform μ_0 has no bearing on the value the dynamical exponent z , and it can easily be verified that the finite piece in the compressibility comes purely from the analytic part of the free energy, especially the term (5.6). Thus, although $z = d = 1$ in this case, one may view this as a ‘coincidence’ that has no bearing on the general mechanism, discussed in detail in Sec. IV A 2, by which κ remains finite through the Bose glass–superfluid transition.

VI. THE EPSILON EXPANSION

In this final section we turn from exact calculations in one dimension to approximate calculations in higher dimensions, expanding on, and providing more context for, our previous work.¹⁷ Unlike the classical point disorder problem, the classical random rod problem [(2.4), or (4.1) with $g(\mathbf{x}) \equiv 0$ but $r(\mathbf{x})$ random], does not have a simple epsilon expansion about $d = 4$. Rather, as shown in Refs. 15, one must consider also the limit in which the dimension, ϵ_τ of the rods is small, and perform a double expansion in $\epsilon = 4 - D$ and ϵ_τ (recall that $D = d + \epsilon_\tau$ is the total dimensionality). The exponents take mean-field values, $z = 1$, $\nu = \frac{1}{2}$, $\eta = 0$, etc., at $\epsilon = \epsilon_\tau = 0$, and deviations from these values may be computed as two-variable power series in ϵ and ϵ_τ .

Our purpose in this section is to extend this technique to the dirty boson problem. We saw in Sec. IVB that a certain nontrivial crossover exponent ϕ_g must be positive if, as expected, particle-hole symmetric disorder is to lead to new critical behavior, different from that of the classical random rod problem. This result was confirmed explicitly for $d = 1$ in Sec. V: there, random rod disorder was found to be an *irrelevant* perturbation on

the pure (Kosterlitz-Thouless, 2D XY) critical behavior, whereas dirty boson-type disorder was found to be *relevant*, leading to new critical behavior. We shall find that for *small* ϵ_τ , particle-hole symmetric disorder is an irrelevant perturbation on the random rod problem, and therefore that the crossover exponent *changes sign*, from negative to positive, at a certain value, $\epsilon_\tau = \epsilon_\tau^c(D)$. To first order in ϵ_τ we obtain the estimate $\epsilon_\tau^c(D=4) = \frac{8}{29}$ ($D=4$ yielding $d=3$ at $\epsilon_\tau=1$). For $\epsilon_\tau > \epsilon_\tau^c$ there are then two fixed points, the stable dirty boson fixed, and the unstable random rod fixed point. This then establishes the nonperturbative nature of the dirty boson fixed point.

A. Scaling for general ϵ_τ

Let us begin by extending the scaling arguments to noninteger ϵ_τ . We consider the following generalization of (4.1) (or, equivalently, of \mathcal{L}_5 in Table I):

$$\mathcal{L}_c = - \int d^d x \int d^{\epsilon_\tau} \tau \left\{ \frac{1}{2} |\nabla \psi|^2 - \frac{1}{2} \psi^* [\nabla_\tau - \mathbf{g}(\mathbf{x})]^2 \psi + \frac{1}{2} r(\mathbf{x}) |\psi|^2 + \frac{1}{4} u |\psi|^4 \right\}, \quad (6.1)$$

where $\mathbf{g}(\mathbf{x})$ is an ϵ_τ -dimensional vector. This form is based on (2.9), with the same simplifications used in (4.1). We write $\mathbf{g}(\mathbf{x}) = \mathbf{g}_0 + \delta \mathbf{g}(\mathbf{x})$, and assume that $\delta \mathbf{g}(\mathbf{x})$ is isotropically distributed in τ space. This yields the correct $\epsilon_\tau = 1$ limit, and ensures that the free energy depends only on $g_0 \equiv |\mathbf{g}_0|$. Clearly, $\mathbf{g}_0 = 0$ is the generalization of statistically particle-hole symmetric disorder. As before, we also write $r(\mathbf{x}) = r_0 + \delta r(\mathbf{x})$, with $[\delta r]_{\text{av}} = 0$, and r_0 is the control parameter.

1. Stiffness constants and hydrodynamic action

The evaluation of the stiffness constants, (3.14) and (4.6), is slightly more complicated now: although the spatial stiffnesses, Υ_α , are as before, the temporal stiffness now takes on a tensor character. Consider a θ -boundary condition in the τ -subspace:

$$\psi(\mathbf{x}, \tau + \beta \hat{\tau}_\mu) = e^{i\theta_\mu} \psi(\mathbf{x}, \tau), \quad \mu = 1, \dots, \epsilon_\tau. \quad (6.2)$$

Defining the periodic field, $\tilde{\psi} = e^{-i\theta \cdot \tau / \beta} \psi$, and substituting into (6.1), we find that

$$\mathcal{L}_c[\psi; \mathbf{g}_0] = \mathcal{L}_c[\tilde{\psi}; \mathbf{g}_0 - i\theta / \beta]. \quad (6.3)$$

The free energy, $f^\theta = -\beta^{-\epsilon_\tau} L^{-d} \ln \{ \text{tr} [e^{\mathcal{L}_c[\psi]}] \}$, is therefore shifted by

$$\begin{aligned} \delta f^\theta &\equiv f^\theta - f^0 = f^0(\mathbf{g}_0 - i\theta / \beta) - f^0(\mathbf{g}_0) \\ &= (-i\theta / \beta) \cdot \frac{\partial f^0}{\partial \mathbf{g}_0} \\ &\quad + \frac{1}{2} (-i\theta / \beta) \cdot \frac{\partial^2 f^0}{\partial \mathbf{g}_0 \partial \mathbf{g}_0} \cdot (-i\theta / \beta) + O[(|\theta| / \beta)^3]. \end{aligned} \quad (6.4)$$

Isotropy implies that

$$\begin{aligned} \frac{\partial f^0}{\partial \mathbf{g}_0} &= -\rho_0 \hat{\mathbf{g}}_0 \\ \frac{\partial^2 f^0}{\partial \mathbf{g}_0 \partial \mathbf{g}_0} &= -\frac{\rho_0}{g_0} (\mathbb{1} - \hat{\mathbf{g}}_0 \hat{\mathbf{g}}_0) - \kappa_0 \hat{\mathbf{g}}_0 \hat{\mathbf{g}}_0, \end{aligned} \quad (6.5)$$

where we have defined the scalar quantities

$$\rho_0 = -\frac{\partial f^0}{\partial g_0}, \quad \kappa_0 = -\frac{\partial^2 f^0}{\partial g_0^2}, \quad (6.6)$$

and (6.4) reduces to

$$\begin{aligned} \delta f^\theta &= \frac{i}{\beta} (\boldsymbol{\theta} \cdot \hat{\mathbf{g}}_0) \rho_0 + \frac{1}{2\beta^2} [|\boldsymbol{\theta}|^2 - (\boldsymbol{\theta} \cdot \hat{\mathbf{g}}_0)^2] \frac{\rho_0}{g_0} \\ &\quad + \frac{|\boldsymbol{\theta}|^2}{2\beta^2} \kappa_0 + O[(|\boldsymbol{\theta}| / \beta)^3]. \end{aligned} \quad (6.7)$$

It is straightforward to write down expressions for ρ_0 and κ_0 analogous to (4.6), but we will require only

$$\begin{aligned} \kappa_0(g_0 = 0) &\equiv \Upsilon_\tau = [\langle |\psi|^2 \rangle]_{\text{av}} \\ &\quad + \int d^d x \int d^{\epsilon_\tau} \tau [\langle \psi^* \partial_{\tau_1} \psi(\mathbf{x}, \tau) \psi^* \partial_{\tau_1} \psi(\mathbf{0}, \mathbf{0}) \rangle]_{\text{av}}, \end{aligned} \quad (6.8)$$

where τ_1 is any given direction in τ -space. The long wavelength action generalizing (3.29) then takes the form

$$\begin{aligned} S_{\text{eff}} &= - \int d^d x \int d^{\epsilon_\tau} \tau \left[\frac{1}{2} \Upsilon |\nabla \phi|^2 + \frac{\rho_0}{2g_0} [|\nabla_\tau \phi|^2 - (\hat{\mathbf{g}}_0 \cdot \nabla_\tau \phi)^2] \right. \\ &\quad \left. + \frac{1}{2} \kappa_0 (\hat{\mathbf{g}}_0 \cdot \nabla_\tau \phi)^2 + i\rho_0 (\hat{\mathbf{g}}_0 \cdot \nabla_\tau \phi) \right]. \end{aligned} \quad (6.9)$$

Note that when $g_0 \rightarrow 0$ we have $\rho_0 / g_0 \rightarrow \kappa_0(g_0 = 0) \equiv \Upsilon_\tau$, and S_{eff} reduces to the more familiar form

$$S_{\text{eff}}(g_0 = 0) = -\frac{1}{2} \int d^d x \int d^{\epsilon_\tau} \tau (\Upsilon |\nabla \phi|^2 + \Upsilon_\tau |\nabla_\tau \phi|^2). \quad (6.10)$$

Defining the frequency variables $\omega_\parallel = \hat{\mathbf{g}}_0 \cdot \boldsymbol{\omega}$ and $\boldsymbol{\omega}_\perp = \boldsymbol{\omega} - \omega_\parallel \hat{\mathbf{g}}_0$, and following the derivation of (4.18), equation (6.9) yields a long wavelength, low frequency Green function

$$\begin{aligned} \hat{G}(\mathbf{k}, \omega) &\equiv \langle |\hat{\psi}(\mathbf{k}, \boldsymbol{\omega})|^2 \rangle_{S_{\text{eff}}} \\ &\approx \frac{|\psi_0|^2}{(\rho_0 / g_0) |\boldsymbol{\omega}_\perp|^2 + \kappa_0 \omega_\parallel^2 + \Upsilon |\mathbf{k}|^2}, \end{aligned} \quad (6.11)$$

where $\psi_0 = [\langle \psi(\mathbf{x}, \tau) \rangle]_{\text{av}} \sim |\delta|^\beta$ is the order parameter, and for slow variations, $\psi(\mathbf{x}, \tau) \approx \psi_0 e^{i\phi(\mathbf{x}, \tau)}$. In deriving this form we have neglected the surface term, $i\rho_0 \hat{\mathbf{g}}_0 \cdot \nabla_\tau \phi$, relative to the others. This is valid in the superfluid phase where ϕ has only small fluctuations about the long range ordered value, which we have taken to be $\phi \equiv 0$. As we saw in Sec. III C 3, in the disordered Bose glass phase this term does become important (see also below).

2. Dynamical exponents and scaling

Equation (6.11) determines the correlations in the hydrodynamic limit, even near the critical point. One could propose a scaling function of the form:

$$G(\mathbf{k}, \boldsymbol{\omega}) \approx G_0 \xi^{2-\eta} g(k\xi, \omega_\perp \xi_\tau^\perp, \omega_\parallel \xi_\tau^\parallel), \quad (6.12)$$

where \mathbf{k} , ω_\perp and ω_\parallel appear scaled by their appropriate correlation lengths, ξ , $\xi_\tau^\parallel \sim \xi^{z_\parallel}$ and $\xi_\tau^\perp \sim \xi^{z_\perp}$, where, for $g_0 \neq 0$, we have allowed for different scalings parallel and perpendicular to \mathbf{g}_0 . When $g_0 = 0$ we expect $\xi_\tau^\parallel = \xi_\tau^\perp \equiv \xi_\tau$ and $z_\parallel = z_\perp \equiv z$. To be consistent with (6.11), equation (6.12) requires that

$$g(x, y, z) \approx \frac{1}{g_x x^2 + g_\perp y^2 + g_\parallel z^2}, \quad x, y, z \rightarrow 0, \quad (6.13)$$

in which g_x , g_\perp and g_\parallel are universal numbers. Thus

$$\begin{aligned} \Upsilon &\approx G_0^{-1} |\psi_0|^2 g_x \xi^\eta \\ \kappa_0 &\approx G_0^{-1} |\psi_0|^2 g_\parallel (\xi_\tau^\parallel)^2 \xi^{-2+\eta} \\ \rho_0/g_0 &\approx G_0^{-1} |\psi_0|^2 g_\perp (\xi_\tau^\perp)^2 \xi^{-2+\eta} \end{aligned} \quad (6.14)$$

[compare (4.18) and (4.19)]. The hyperscaling relation is now $2 - \alpha = [d + z_\parallel + (\epsilon_\tau - 1)z_\perp]\nu$. Along with the usual scaling relations, $\alpha + 2\beta + \gamma = 2$ and $\gamma = (2 - \eta)\nu$, this immediately implies that $\Upsilon \sim |\delta|^\nu$, $\kappa_0 \sim |\delta|^{v_\parallel}$ and $\rho_0/g_0 \sim |\delta|^{v_\perp}$, where $\delta = r_0 - r_{0,c}(g_0)$ is the deviation from criticality, and the implied exponent relations

$$\begin{aligned} v &= [d + (\epsilon_\tau - 1)z_\perp + z_\parallel - 2]\nu \\ v_\parallel &= [d + (\epsilon_\tau - 1)z_\perp - z_\parallel]\nu \\ v_\perp &= [d + (\epsilon_\tau - 3)z_\perp + z_\parallel]\nu, \end{aligned} \quad (6.15)$$

generalize (4.11). If $z_\perp = z_\parallel = z$, then $v = (d + \epsilon_\tau - 2)\nu$ and $v_\parallel = v_\perp \equiv v_\tau = [d + (\epsilon_\tau - 2)z]\nu$. If κ_0 remains finite through the transition even for noninteger ϵ_τ , then we would predict

$$z = \frac{d}{2 - \epsilon_\tau}. \quad (?) \quad (6.16)$$

This is the natural generalization of the proposed scaling relation $z = d$ at $\epsilon_\tau = 1$.^{6,28}

However, as discussed in Ref. 29 and Sec. IV A 2, this argument actually fails for $\epsilon_\tau = 1$, and there is no reason to expect it to fare any better for general ϵ_τ . In particular, the absorption of the twisted boundary condition into the simple shift, (6.3) and (6.4), of \mathbf{g}_0 again implies that, at least for $g_0 \neq 0$, the critical behavior of ρ_0 and κ_0 is not tied, as in (6.12), to the correlation times, but only to derivatives with respect to g_0 . Thus, although the relation for v in (6.15) is expected to be correct, the relations for v_\parallel and v_\perp are not. Rather, as discussed above (4.14), the leading singular contribution to ρ_0 and

κ_0 will come from the g_0 dependence of $r_{0,c}(g_0)$, leading to

$$\rho_{0,s} \sim |\delta|^{1-\alpha}, \quad \kappa_{0,s} \sim |\delta|^{-\alpha}. \quad (6.17)$$

We will see that the renormalization group analysis generates an independent value for z , disagreeing, in particular, with (6.16), confirming again that there is no $|\delta|^{v_\tau}$ contribution to the compressibility.

3. Relevance of particle-hole symmetry breaking

We next calculate the crossover exponent ϕ_g associated with nonzero $\delta \mathbf{g}$ at $g_0 = 0$, for general ϵ_τ . The calculation is essentially identical to that leading to (4.40). The perturbation, (4.21), now becomes

$$\mathcal{L}_{\mathbf{g}} = \int d^d x \int d^{\epsilon_\tau} \tau \left\{ \frac{1}{2} |\mathbf{g}(\mathbf{x})|^2 |\psi|^2 - \psi^* [\mathbf{g}(\mathbf{x}) \cdot \nabla_\tau] \psi \right\}. \quad (6.18)$$

We assume $[g_\mu(\mathbf{x})g_\nu(\mathbf{x})]_{\text{av}} = \Delta_g \phi(\mathbf{x} - \mathbf{x}') \delta_{\mu\nu}$, where ϕ is a delta function for short range correlated disorder, and varies as $x^{-(d+a)}$ for large x for power law correlated disorder. Equation (4.32) now becomes

$$-2 \left(\frac{\partial f}{\partial \Delta_g} \right)_{\Delta_g=0} = \epsilon_\tau \int_{\mathbf{k}} \hat{\phi}(\mathbf{k}) \Upsilon_\tau(\mathbf{k}, \mathbf{0}) \quad (6.19)$$

in which $\Upsilon_\tau(\mathbf{k}, \boldsymbol{\omega})$ is defined by (4.28)–(4.31), but, as in (6.8), with time derivatives $\partial_\tau \rightarrow \partial_{\tau_1}$ in (4.28), and random rod compressibility exponent $v_{\tau,0}(\epsilon_\tau) = [d + (\epsilon_\tau - 2)z]\nu_0$ replacing $(d - z_0)\nu_0$ in the scaling form (4.31).

As in (4.33) and (4.34), $\tilde{\mathcal{Y}}(w)$ will have a similar spectrum of exponents, $0 < \omega_1(\epsilon_\tau) < \omega_2(\epsilon_\tau) < \omega_3(\epsilon_\tau) < \dots$, now depending on ϵ_τ . This leads in the same way to (4.37) and (4.38), still with $b_0 \equiv 0$, and a term $b_a |\delta|^{[2d + (\epsilon_\tau - 2)z_0]\nu}$. We then find

$$\phi_g/\nu_0 = \begin{cases} 2z_0 - d - a, & a < 2z_0 - d - \lambda_1(\epsilon_\tau) \\ \lambda_1(\epsilon_\tau), & a > 2z_0 - d - \lambda_1(\epsilon_\tau) \end{cases} \quad (6.20)$$

essentially as before [see (4.41)], but now with $\lambda_j = d + \epsilon_\tau z - \omega_j$ and all exponents evaluated at the random rod fixed point in ϵ_τ time dimensions.

We shall compute $\lambda_1(\epsilon_\tau)$ to $O(\epsilon_\tau)$ below. From the naive (and, as we shall see, incorrect) estimate, $\lambda_1 = 2z_0 - d$, we again have $\lambda_1 > 0$ for $z > \frac{d}{2}$. Since $z = 1$ at $\epsilon_\tau = 0$, we expect, as stated earlier, $\lambda_1 < 0$ for small ϵ_τ , becoming positive only for $\epsilon_\tau > \epsilon_\tau^c > 0$. We shall find that for $\epsilon_\tau > \epsilon_\tau^c$ a new stable fixed point with $\Delta_g^* > 0$ bifurcates away from the random rod fixed point (with $\Delta_g^* = 0$). The exponent z_0 is substantially *smaller* than $\frac{d}{2}$ at this point, violating (6.16) for any $\epsilon_\tau > 0$. Assuming that this new fixed point may indeed be identified with the true dirty boson fixed point when $\epsilon_\tau = 1$, we conclude again that (6.16) is incorrect. Below we shall generalize the analysis of the excitation spectrum of the Bose glass phase in Sec. III to general ϵ_τ . For $\epsilon_\tau < 1$, the issue of whether the Bose glass phase is compressible turns out to be rather subtle.

B. Phase diagrams for general ϵ_τ

To understand the phase diagram for general ϵ_τ it is instructive to first consider the mean field approximation, in the form of the infinite range hopping model ($J_{ij} = J_0/N$ for all i, j , where N is the number of sites). In the absence of disorder, and with onsite repulsion only, the mean-field approximation to the Lagrangian (2.7) takes the form

$$\mathcal{L}_{\text{MF}} = \int d^{\epsilon_\tau} \tau \left\{ \frac{J_0}{N} \sum_{i,j} \cos[\phi_i(\boldsymbol{\tau}) - \phi_j(\boldsymbol{\tau})] - \frac{1}{2U_0} \sum_i (\nabla_\tau \phi_i - i\boldsymbol{\mu})^2 \right\}, \quad (6.21)$$

with temporal periodic boundary conditions

$$\phi_i(\boldsymbol{\tau} + \beta \hat{\mathbf{e}}_\alpha) = \phi_i(\boldsymbol{\tau}) + 2\pi n_\alpha, \quad (6.22)$$

in which the decoupling has reduced the phase variable trace to one over a single variable $\phi(\boldsymbol{\tau})$, which includes a sum over all possible boundary conditions (6.22). The constant $a = \frac{1}{2} J d^{\epsilon_\tau} \tau$ incorporates the discretization of the $\boldsymbol{\tau}$ -integral, and the measures $DM(\boldsymbol{\tau})$, $D\phi(\boldsymbol{\tau})$ incorporate any normalization factors needed to make sense of the continuum limit.

2. Saddle point evaluation

In the thermodynamic limit, $N \rightarrow \infty$, a saddle point evaluation of (6.24) becomes exact. Since the superfluid order parameter is homogeneous and static, the lowest-energy saddle point must be a time independent field, $M(\boldsymbol{\tau}) \equiv M_0$, which can be chosen real. Near the critical point M_0 will be small, and $S_{\text{MF}}[M_0]$ has a Landau expansion,

$$\begin{aligned} f_{\text{MF}}(M_0) &\equiv -\beta^{-\epsilon_\tau} S_{\text{MF}}[M_0] \\ &= f_0(\boldsymbol{\mu}, J_0) + \frac{1}{2} r_0(\boldsymbol{\mu}, J_0) |M_0|^2 \\ &\quad + \frac{1}{4} u_0(\boldsymbol{\mu}, J_0) |M_0|^4 + \dots \end{aligned} \quad (6.26)$$

The connection between M_0 and the order parameter $\psi_0 = \langle \frac{1}{N} \sum_j e^{i\phi_j} \rangle$ is obtained by adding a term $-\frac{1}{2} \int d^{\epsilon_\tau} \tau \sum_j (h^* e^{i\phi_j} + h e^{-i\phi_j})$ to \mathcal{L}_{MF} . Since this term is local, the KHS transformation simply yields the replacement $M \rightarrow \tilde{M} \equiv M + h/J_0$ inside the logarithmic

for any set of integers $\mathbf{n} = \{n_\alpha\}_{\alpha=1}^{\epsilon_\tau}$.

1. Kac-Hubbard-Stratanovich transformation

A complex Kac-Hubbard-Stratanovich (KHS) field $M(\boldsymbol{\tau})$ may now be introduced to decouple the hopping term. Using the identity

$$e^{a|z|^2/N} = \frac{aN}{\pi} \int d^2\psi e^{-a(\psi z^* + \psi^* z + N|\psi|^2)}, \quad (6.23)$$

where the integral is over the real and imaginary parts of ψ , the partition function can be written in the form

$$Z_{\text{MF}} = \int DM(\boldsymbol{\tau}) e^{N S_{\text{MF}}[M]}, \quad (6.24)$$

in which the integral is over all ϵ_τ -dimensional complex functions $M(\boldsymbol{\tau})$, weighted by the effective action

$$S_{\text{MF}}[M] = -\frac{J_0}{2} \int d^{\epsilon_\tau} \tau |M(\boldsymbol{\tau})|^2 + \ln \left[\int D\phi(\boldsymbol{\tau}) e^{-\int d^{\epsilon_\tau} \tau \left\{ \frac{1}{2U_0} [\nabla_\tau \phi(\boldsymbol{\tau}) - i\boldsymbol{\mu}]^2 + \frac{J_0}{2} [M^*(\boldsymbol{\tau}) e^{i\phi(\boldsymbol{\tau})} + M(\boldsymbol{\tau}) e^{-i\phi(\boldsymbol{\tau})}] \right\}} \right] \quad (6.25)$$

mic term in (6.25). In terms of \tilde{M} , the first term in (6.25) becomes $\frac{1}{2} J_0 |M|^2 = \frac{1}{2} J_0 |\tilde{M} - h|^2$, and the free energy is obtained by minimizing $\tilde{f}_{\text{MF}}(M_0, h) = f_{\text{MF}}(M_0) - \frac{1}{2} (h^* \tilde{M}_0 + h \tilde{M}_0^*) + |h|^2 / 2J_0$. One therefore obtains $\psi_0 = -2(\partial f_{\text{MF}} / \partial h)_{h=0} = M_0$. Therefore M_0 is in fact the order parameter in this theory.

Assuming only that $u_0 > 0$, the transition line occurs at $r_0 = 0$, and the superfluid phase corresponds to $r_0 < 0$. To obtain the phase diagram, we therefore need only compute r_0 , which is given by

$$\begin{aligned} r_0 &= J_0 - J_0^2 \int d^{\epsilon_\tau} \tau \langle \cos[\phi(\boldsymbol{\tau})] \cos[\phi(\mathbf{0})] \rangle_0 \\ &= J_0 - \frac{1}{2} J_0^2 \text{Re} \int d^{\epsilon_\tau} \tau \langle e^{i[\phi(\boldsymbol{\tau}) - \phi(\mathbf{0})]} \rangle_0 \end{aligned} \quad (6.27)$$

in which the average is with respect to the M_0 -independent $\frac{1}{2U_0} [\nabla_\tau \phi(\boldsymbol{\tau}) - i\boldsymbol{\mu}]^2$ term. To further evaluate r_0 , we first account for the boundary conditions by changing to the periodic variable

$$\tilde{\phi}(\boldsymbol{\tau}) = \phi(\boldsymbol{\tau}) - \frac{2\pi \mathbf{n} \cdot \boldsymbol{\tau}}{\beta}. \quad (6.28)$$

It follows that $\phi(\boldsymbol{\tau}) - \phi(\mathbf{0}) = \tilde{\phi}(\boldsymbol{\tau}) - \tilde{\phi}(\mathbf{0}) + 2\pi \mathbf{n} \cdot \boldsymbol{\tau} / \beta$, $\nabla_\tau \phi(\boldsymbol{\tau}) = \nabla_\tau \tilde{\phi}(\boldsymbol{\tau}) + 2\pi \mathbf{n} / \beta$, and $\int d^{\epsilon_\tau} \tau \nabla_\tau \tilde{\phi} = 0$, and one therefore obtains

$$\begin{aligned} \langle e^{i[\phi(\boldsymbol{\tau}) - \phi(\mathbf{0})]} \rangle_0 &= \frac{\sum_{\mathbf{n}} e^{-\beta \epsilon_\tau (2\pi \mathbf{n} / \beta - i\boldsymbol{\mu})^2 / 2U_0} e^{2\pi i \mathbf{n} \cdot \boldsymbol{\tau} / \beta}}{\sum_{\mathbf{n}} e^{-\beta \epsilon_\tau (2\pi \mathbf{n} / \beta - i\boldsymbol{\mu})^2 / 2U_0}} \\ &\quad \times e^{-\frac{1}{2} \langle [\phi(\boldsymbol{\tau}) - \phi(\mathbf{0})]^2 \rangle_{00}}, \end{aligned} \quad (6.29)$$

in which $\langle \cdot \rangle_{00}$ is an average with respect to the Gaussian term $(\nabla_{\tau} \tilde{\phi})^2 / 2U_0$, and we have used property $\langle e^{iX} \rangle = e^{-\langle X^2 \rangle / 2}$, valid for any Gaussian random variable X . The remaining average is the inverse Fourier transform of $U_0/|\boldsymbol{\omega}|^2$, namely the Green function for the Laplacian in ϵ_{τ} dimensions:

$$\frac{1}{2} \langle [\phi(\boldsymbol{\tau}) - \phi(\mathbf{0})]^2 \rangle_{00} = U_0 A(\epsilon_{\tau}) |\boldsymbol{\tau}|^{2-\epsilon_{\tau}}$$

$$A(\epsilon_{\tau}) = \frac{\Gamma(\epsilon_{\tau}/2)}{2(2-\epsilon_{\tau})\pi^{\epsilon_{\tau}/2}}. \quad (6.30)$$

Note that $A(1) = \frac{1}{2}$.

For the \mathbf{n} -sums we make use of the identity (3.37). The ratio of \mathbf{n} -sums in (6.29) becomes

$$\frac{\sum_{\mathbf{l}} e^{-\frac{1}{2}U_0\beta^{2-\epsilon_{\tau}}(1+\boldsymbol{\mu}/U_0\beta^{1-\epsilon_{\tau}}+\boldsymbol{\tau}/\beta)^2}}{\sum_{\mathbf{l}} e^{-\frac{1}{2}U_0\beta^{2-\epsilon_{\tau}}(1+\boldsymbol{\mu}/U_0\beta^{1-\epsilon_{\tau}})^2}} \rightarrow e^{-(\boldsymbol{\mu}-U_0\beta^{1-\epsilon_{\tau}}\mathbf{l}_0)\cdot\boldsymbol{\tau}} \quad (6.31)$$

in which the right hand side is valid for $\beta \rightarrow \infty$, and $\mathbf{l}_0(\boldsymbol{\mu})$ is the value of \mathbf{l} that minimizes $(\boldsymbol{\mu} + U_0\beta^{1-\epsilon_{\tau}}\mathbf{l}_0)^2$. For $\epsilon_{\tau} < 1$ one clearly obtains $\mathbf{l}_0 = \mathbf{0}$, while in the special case $\epsilon_{\tau} = 1$ one obtains the periodic form $l_0(\mu) = [\frac{\mu}{U_0} + \frac{1}{2}]$. Adopting the convention $-\frac{1}{2} < \mu/U_0 \bmod 1 \leq \frac{1}{2}$, we finally obtain,

$$\langle e^{i[\phi(\boldsymbol{\tau}) - \phi(\mathbf{0})]} \rangle_0 = \begin{cases} e^{-U_0 A(\epsilon_{\tau}) |\boldsymbol{\tau}|^{2-\epsilon_{\tau}} - \boldsymbol{\mu} \cdot \boldsymbol{\tau}}, & \epsilon_{\tau} < 1 \\ e^{-\frac{1}{2}U_0 |\boldsymbol{\tau}| - U_0(\boldsymbol{\mu}/U_0 \bmod 1) \cdot \boldsymbol{\tau}}, & \epsilon_{\tau} = 1, \end{cases} \quad (6.32)$$

which should be compared to the droplet model calculation (3.42), (3.43).

3. Superfluid transition line

Substituting (6.32) into (6.27), one obtains the following equation for the transition line:

$$\frac{2}{J_{0,c}(|\boldsymbol{\mu}|)} = \int d\boldsymbol{\tau} \tau e^{-U_0 A(\epsilon_{\tau}) |\boldsymbol{\tau}|^{2-\epsilon_{\tau}} - \boldsymbol{\mu} \cdot \boldsymbol{\tau}}$$

$$= 2\pi^{\epsilon_{\tau}/2} \int_0^{\infty} d\tau \tau^{\epsilon_{\tau}-1} e^{-U_0 A(\epsilon_{\tau}) \tau^{2-\epsilon_{\tau}}}$$

$$\times \left(\frac{2}{|\boldsymbol{\mu}| \tau} \right)^{\frac{\epsilon_{\tau}-2}{2}} I_{\frac{\epsilon_{\tau}-2}{2}}(|\boldsymbol{\mu}| \tau), \quad (6.33)$$

where $I_{\nu}(z)$ is the modified Bessel function. Note that $(z/2)^{-\nu} I_{\nu}(z)$ is analytic at the origin, taking the value $1/\Gamma(\nu+1)$ there, and that $I_{-\frac{1}{2}}(z) = \sqrt{2/\pi z} \cosh(z)$ reduces (6.33) to the correct result at $\epsilon_{\tau} = 1$. Note that for $\epsilon_{\tau} > 1$ the integral (6.33) diverges for $\boldsymbol{\mu} \neq \mathbf{0}$, indicating a divergent compressibility. Thus, only $\epsilon \leq 1$ displays the physics of interest to us.

Using the Taylor expansion of the Bessel function,⁴⁴

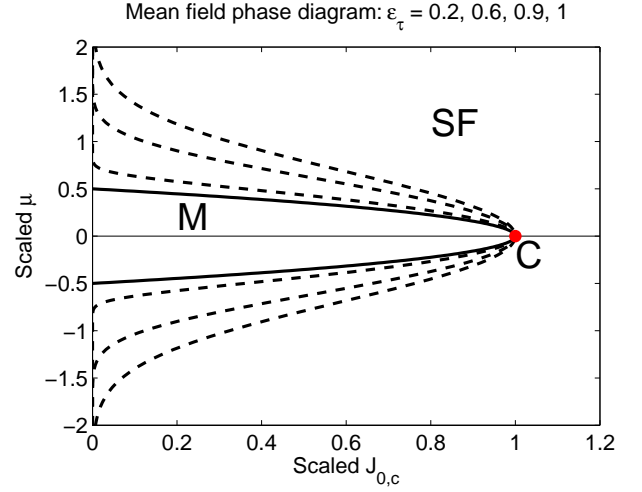

FIG. 8: (Color online) Mean field phase diagram for the Josephson junction model, showing Mott (M) and superfluid (SF) phases, with particle-hole symmetric transition point (C) for $\epsilon_{\tau} = 0.2, 0.6, 0.9, 1$. Larger ϵ_{τ} correspond to smaller Mott lobes. For $\epsilon_{\tau} < 1$ (dashed lines) there is a single Mott lobe persisting for arbitrarily large μ . For $\epsilon_{\tau} = 1$ the Mott lobe shown (solid line) is actually repeated periodically. The scaled axis variables are $J_{0,c}(|\boldsymbol{\mu}|)/J_{0,c}(0)$ and $\bar{\mu}$, as defined in (6.34).

one obtains,

$$\frac{J_{0,c}(0)}{J_{0,c}(|\boldsymbol{\mu}|)} = \sum_{k=0}^{\infty} \frac{\Gamma\left(\frac{\epsilon_{\tau}+2k}{2-\epsilon_{\tau}}\right)}{\Gamma\left(\frac{\epsilon_{\tau}}{2-\epsilon_{\tau}}\right)} \frac{\Gamma\left(\frac{\epsilon_{\tau}}{2}\right)}{k! \Gamma\left(k + \frac{\epsilon_{\tau}}{2}\right)} \bar{\mu}^{2k}$$

$$\bar{\mu} \equiv \frac{|\boldsymbol{\mu}|}{2[U_0 A(\epsilon_{\tau})]^{1/(2-\epsilon_{\tau})}}$$

$$\frac{J_{0,c}(0)}{[U_0 A(\epsilon_{\tau})]^{1/(2-\epsilon_{\tau})}} = \frac{2\Gamma\left(\frac{2+\epsilon_{\tau}}{2}\right)}{\pi^{\frac{\epsilon_{\tau}}{2}} \Gamma\left(\frac{2}{2-\epsilon_{\tau}}\right)}. \quad (6.34)$$

It follows that $J_{0,c}(0) \rightarrow 2$ as $\epsilon_{\tau} \rightarrow 0$, and $J_{0,c}(0) \rightarrow U_0/2$ as $\epsilon_{\tau} \rightarrow 1$.

For $\epsilon_{\tau} = 1$ the result (6.33) is valid only for the central Mott lobe. The remainder are constructed by periodic repetition. For this case, the integral can be computed analytically for arbitrary μ , and one obtains,⁶

$$\frac{J_{0,c}(\mu)}{U_0} = \frac{1}{2} \left[1 - \left(\frac{2\mu}{U_0} \right)^2 \right]. \quad (6.35)$$

For $\epsilon_{\tau} < 1$ the $|\boldsymbol{\tau}|^{2-\epsilon_{\tau}}$ term dominates the exponent in (6.33) for large $\boldsymbol{\tau}$, and the integral converges for arbitrarily large $|\boldsymbol{\mu}|$. A saddle point estimate yields

$$J_{0,c} \sim \exp \left[-(1-\epsilon_{\tau}) \left(\frac{2\bar{\mu}}{2-\epsilon_{\tau}} \right)^{\frac{2-\epsilon_{\tau}}{1-\epsilon_{\tau}}} \right], \quad \bar{\mu} \gg 1, \quad (6.36)$$

where non-exponential prefactors have been dropped. In Fig. 8 we plot numerical solutions of (6.34) for the phase boundary for different values of ϵ_{τ} .

Since in mean field theory, every site gets effectively decoupled, it is very easy to incorporate the effect of site disorder within this formalism. The generalization of the mean field action is

$$S_{\text{MF}}^{\text{dis}}[M] = \int d^{\epsilon_\tau} \varepsilon p(|\varepsilon|) S_{\text{MF}}[M; \boldsymbol{\mu} - \varepsilon], \quad (6.37)$$

where $p(|\varepsilon|)$ is the (assumed isotropic) single site distribution for the site disorder ε , and $S_{\text{MF}}[M; \boldsymbol{\mu} - \varepsilon]$ is the pure action (6.25) with $\boldsymbol{\mu} \rightarrow \boldsymbol{\mu} - \varepsilon$. It follows that the phase boundary is now defined by:

$$\frac{2}{J_{0,c}^{\text{dis}}(|\boldsymbol{\mu}|)} = \int d^{\epsilon_\tau} \tau \int d^{\epsilon_\tau} \varepsilon p(|\varepsilon|) e^{-A(\varepsilon_\tau) U_0 |\tau|^{2-\epsilon_\tau} - (\boldsymbol{\mu} - \varepsilon) \cdot \boldsymbol{\tau}}. \quad (6.38)$$

For $\epsilon_\tau = 1$, it is assumed here that $|\boldsymbol{\mu} - \varepsilon| < U_0/2$ for all allowed values of ε , otherwise the mod factor in (6.33) enters.

The result (6.38), even for $\epsilon_\tau = 1$, does not reproduce the result $\mu_c(J_0; \Delta) = \mu_c(J_0; 0) - \Delta$ (except at $J_0 = 0$), where Δ is the maximum value of $|\varepsilon|$ supported by p , obtained from the rare region arguments in Sec. III D. In fact, the integral (6.38) is smaller than it would be if all the weight of p were to lie at $\varepsilon = -\Delta \hat{\boldsymbol{\mu}}$ (whence $|\boldsymbol{\mu}| \rightarrow |\boldsymbol{\mu}| + \Delta$), implying that $J_{0,c}^{\text{dis}}(|\boldsymbol{\mu}|)$ is larger, leading to enlarged Mott lobes: $\mu_c(J_0; \Delta) \geq \mu_c(J_0; 0) - \Delta$.

In the presence of disorder, (6.38) implies that the Mott lobes shrink, but in a nontrivial way that depends on the detailed shape of p , not just its support. This is an artifact of mean field theory, which couples all sites equally, whereas the rare region argument result relied on local interactions in spatially separated, noninteracting droplets. Moreover, the coupling constant J_0/N in (6.21) is scaled by the total number of sites. Therefore, even if one were to view all sites with values of ε_i in some small region of size $(\Delta\varepsilon)^{\epsilon_\tau}$ as a droplet, its critical point would have to be scaled by the relative number of sites in the droplet, i.e., by $1/p(|\varepsilon|)(\Delta\varepsilon)^{\epsilon_\tau}$, in order to obtain a consistent result. This roughly explains the form of (6.38).

For $\epsilon_\tau = 1$, the Mott lobes still disappear entirely for $\Delta > U_0/2$. However, for $\epsilon_\tau < 1$, the fact that the Mott lobe extends to arbitrarily large $|\boldsymbol{\mu}|$ means that it will survive for arbitrarily large Δ as well, including unbounded disorder.

4. Mott phase compressibility

Computation of the density and compressibility within the Mott lobe requires the M -independent part of the free energy f_0 in (6.26). Using (6.25) and (6.28) one obtains $f_0 = f_{00} + \Delta f_0$, where

$$\begin{aligned} f_{00} &= -\frac{1}{\beta^{\epsilon_\tau}} \ln \left[\int D\tilde{\phi}(\tau) e^{-\frac{1}{2\beta U_0} \int d^{\epsilon_\tau} \tau (\nabla_\tau \tilde{\phi})^2} \right] \\ &= -\frac{1}{2} \int \frac{d^{\epsilon_\tau} \omega}{(2\pi)^{\epsilon_\tau}} \ln \left(\frac{2\pi U_0}{|\omega|^2} \right) \end{aligned} \quad (6.39)$$

is the $\boldsymbol{\mu}$ -independent Gaussian contribution, and

$$\begin{aligned} \Delta f_0 &= -\frac{1}{\beta^{\epsilon_\tau}} \ln \left[\sum_{\mathbf{n}} e^{-\beta^{\epsilon_\tau} (2\pi \mathbf{n} / \beta - i\boldsymbol{\mu})^2} \right] \\ &= -\frac{|\boldsymbol{\mu}|^2}{2U_0} - \frac{\epsilon_\tau}{2\beta^{\epsilon_\tau}} \ln \left(\frac{\beta^{2-\epsilon_\tau} U_0}{2\pi} \right) \\ &\quad - \frac{1}{\beta^{\epsilon_\tau}} \ln \left[\sum_{\mathbf{l}} e^{-U_0 \beta^{2-\epsilon_\tau} (1 - \beta^{1-\epsilon_\tau} \boldsymbol{\mu} / U_0)^2 / 2} \right] \\ &\rightarrow \begin{cases} \frac{1}{2} U_0 l_0(\boldsymbol{\mu})^2 - l_0(\boldsymbol{\mu}) \boldsymbol{\mu}, & \epsilon_\tau = 1 \\ 0, & \epsilon_\tau < 1 \end{cases} \end{aligned} \quad (6.40)$$

in which, once again, $l_0(\boldsymbol{\mu}) = \left[\frac{\boldsymbol{\mu}}{U_0} + \frac{1}{2} \right]$ (nonzero only for $\epsilon_\tau = 1$) is the integer that minimizes $(l - \boldsymbol{\mu}/U_0)^2$, and the last line follows for $\beta \rightarrow \infty$. The derivative with respect to $\boldsymbol{\mu}$ therefore recovers the Mott lobe integer density $\rho = l_0(\boldsymbol{\mu})$ for $\epsilon_\tau = 1$ and $\rho = 0$ for $\epsilon_\tau < 1$. The vanishing compressibility follows immediately.

In the presence of disorder, $l_0(\boldsymbol{\mu} - \varepsilon)$ is unchanged within a (smaller) Mott lobe, so $\Delta f_0^{\text{dis}}(\boldsymbol{\mu}) = \int d^{\epsilon_\tau} \varepsilon p(|\varepsilon|) \Delta f_0(\boldsymbol{\mu} - \varepsilon) = \Delta f_0(\boldsymbol{\mu})$ is also unchanged, and identical results follow for the density and compressibility.

5. Phase diagram for finite range hopping

In both pure and disordered cases, the fact that $M_0 \approx \sqrt{-r_0/u_0}$ is nonzero immediately outside of the Mott phase boundary, with unchanged mean field critical behavior, implies that there is no glassy phase in mean field theory. Only for finite-ranged hopping will a finite width Bose glass phase appear between the Mott and superfluid phases, as in Fig. 1(b).

In considering the interpolation between small ϵ_τ and $\epsilon_\tau = 1$ it is clear that it makes sense only to consider the zero density Mott lobe. The renormalization group treatment in Sec. VI D will therefore focus on the vicinity of the commensurate transition at $|\boldsymbol{\mu}| = 0$. The mean field calculations give one some confidence that the critical behavior near this point will vary continuously with ϵ_τ , and that extrapolations from small values to the physical value $\epsilon_\tau = 1$ will be at least qualitatively valid.

C. Droplet model for general ϵ_τ

In order to gain insight into the nature of the Bose glass phase for general ϵ_τ , we next generalize the droplet model of Sec. III. The identical rare region argument as for $\epsilon_\tau = 1$ implies that the Mott phase boundary occurs at $\mu_\pm(J_0, \Delta) = \mu_\pm(J_0, 0) \mp \Delta$, where Δ is the maximum supported value of ε_i . For $|\boldsymbol{\mu}| > |\mu_\pm(J_0, \Delta)|$ there will be no droplets. We consider then the effective action (6.9) in a finite superfluid droplet, with spatial volume V , in which ϕ is

assumed constant in space [compare (3.30)]:

$$S_{\text{eff}}^{(1)} = V \int d^{\epsilon_\tau} \tau \left[\frac{1}{2} \kappa (\nabla_\tau \phi)^2 + i \boldsymbol{\rho} \cdot \nabla_\tau \phi \right] \quad (6.41)$$

in which, as before, $\boldsymbol{\rho}$, κ are the bulk density and compressibility if the droplet were extended into an infinite homogeneous medium. The usual 2π -periodic boundary conditions on ϕ apply.

1. Droplet density and compressibility

Let us first generalize the free energy calculation, (3.32). By performing a calculation identical to (6.39) and (6.40), the generalization of (3.36) in the vicinity of chemical potential $\boldsymbol{\mu}_0$ then reads

$$f = f_0(|\boldsymbol{\mu}|) + f_{00}(\kappa^0) - \frac{1}{\beta^{\epsilon_\tau} V} \ln \left[\sum_1 e^{-\beta^{2-\epsilon_\tau} (\beta^{\epsilon_\tau-1} \boldsymbol{\rho} V - 1)^2 / 2\kappa^0 V} \right], \quad (6.42)$$

in which the functions f_0 and f_{00} are defined analogously to (3.34) and (3.36):

$$f_{00}(\kappa_0) = -\frac{1}{2} \int \frac{d^{\epsilon_\tau} \boldsymbol{\omega}}{(2\pi)^{\epsilon_\tau}} \ln \left(\frac{2\pi}{\kappa^0 V |\boldsymbol{\omega}|^2} \right) \quad (6.43)$$

is the free energy associated with the $\frac{1}{2} \kappa^0 (\nabla_\tau \tilde{\phi})^2$ term [compare (6.39)], and

$$f_0(|\boldsymbol{\mu}|) = f_0(|\boldsymbol{\mu}_0|) - |\boldsymbol{\rho}^0| (|\boldsymbol{\mu}| - |\boldsymbol{\mu}_0|) - \frac{1}{2} \kappa^0 (|\boldsymbol{\mu}| - |\boldsymbol{\mu}_0|)^2, \quad (6.44)$$

is the analytic background free energy in the neighborhood of $\boldsymbol{\mu}_0$. In the limit $\beta \rightarrow \infty$, for $\epsilon_\tau = 1$, one recovers the discrete particle addition result (3.39) and (3.40). For $\epsilon_\tau < 1$ only the $\mathbf{1} = \mathbf{0}$ term in (6.42) survives, and one obtains

$$f = f_0 + f_{00} + \frac{|\boldsymbol{\rho}|^2}{2\kappa^0}. \quad (6.45)$$

Noting that $\frac{\partial \boldsymbol{\rho}}{\partial \boldsymbol{\mu}} = \kappa \mathbf{1}$, one obtains

$$\begin{aligned} \boldsymbol{\rho}_{\text{drop}}(\boldsymbol{\mu}_0) &= - \left(\frac{\partial f}{\partial \boldsymbol{\mu}} \right)_{\boldsymbol{\mu}=\boldsymbol{\mu}_0} \\ &= \boldsymbol{\rho}^0 - \frac{1}{\kappa^0} \boldsymbol{\rho}^0 \cdot \left(\frac{\partial \boldsymbol{\rho}}{\partial \boldsymbol{\mu}} \right)_{\boldsymbol{\mu}=\boldsymbol{\mu}_0} \\ &= \boldsymbol{\rho}^0 - \boldsymbol{\rho}^0 = \mathbf{0}. \end{aligned} \quad (6.46)$$

The superfluid droplet therefore has vanishing density, and hence, like the Mott phase, is *incompressible*, for arbitrary $\boldsymbol{\mu}$ and V . We conclude that for $\epsilon_\tau < 1$ both the Mott phase and the Bose glass phase are incompressible, and κ (and $\boldsymbol{\rho}$) will become nonzero only as one crosses into the superfluid phase.

2. Droplet temporal correlations and superfluid susceptibility

One must therefore seek a different measure to distinguish the Mott and Bose glass phases for $\epsilon_\tau < 1$. We examine, therefore, the temporal correlation function and superfluid susceptibility.

By following through the derivation (3.41)–(3.43) for $\epsilon_\tau < 1$, analogous to the survival of only the $\mathbf{1} = \mathbf{0}$ term in the free energy series (6.42), the $\beta \rightarrow \infty$ limit for the temporal correlation function leads to the simple result

$$\begin{aligned} G_\rho^{(0)}(\boldsymbol{\tau} - \boldsymbol{\tau}') &= \left\langle e^{i[\phi(\boldsymbol{\tau}) - \phi(\boldsymbol{\tau}')]} \right\rangle_{S_{\text{eff}}^{(1)}} \\ &= G_0(\boldsymbol{\tau} - \boldsymbol{\tau}') e^{-\boldsymbol{\rho} \cdot (\boldsymbol{\tau} - \boldsymbol{\tau}') / \kappa} \end{aligned} \quad (6.47)$$

in which

$$G_0(\boldsymbol{\tau}) = e^{-A(\epsilon_\tau) |\boldsymbol{\tau}|^{2-\epsilon_\tau} / \kappa V} \quad (6.48)$$

is the Gaussian correlation at $\boldsymbol{\rho} = \mathbf{0}$, with coefficient $A(\epsilon_\tau)$ defined by (6.30)—compare (6.32).

Clearly the G_0 factor, which decays faster than exponentially, dominates the asymptotic behavior at large $|\boldsymbol{\tau} - \boldsymbol{\tau}'|$, but for large κV this may not occur until $|\boldsymbol{\tau} - \boldsymbol{\tau}'|$ is extremely large. To quantify this, we compute the droplet averaged correlation function

$$\begin{aligned} G_\rho(\boldsymbol{\tau}) &= \int dV d\kappa p(V, \kappa) G_\rho^{(0)}(\boldsymbol{\tau}) \\ &\approx e^{-\Delta \boldsymbol{\mu} \cdot \boldsymbol{\tau}} \int dV d\kappa p(V, \kappa) G_0(\boldsymbol{\tau}) \end{aligned} \quad (6.49)$$

where $p(V, \kappa)$ is the probability density for a droplet of size V and bulk compressibility κ . The last line holds in the vicinity of the Mott lobe boundary, where $\boldsymbol{\rho} \approx \kappa_0 \Delta \boldsymbol{\mu}$, where $\Delta \boldsymbol{\mu} = \boldsymbol{\mu} - \boldsymbol{\mu}_c(J_0, \Delta)$ is the deviation from the phase boundary, and $\kappa_0(J_0)$ is the compressibility just inside the background superfluid phase—compare (3.31). Therefore $\boldsymbol{\rho} \cdot \boldsymbol{\tau} / \kappa \approx \Delta \boldsymbol{\mu} \cdot \boldsymbol{\tau}$ is approximately independent of κ .

For large $|\boldsymbol{\tau}|$, the integral (6.49) is dominated by large volumes for which $p(V, \kappa) \sim e^{-V/V_0(\kappa)}$, where $V_0(\kappa)$ is a characteristic scale for droplets with background compressibility κ . A steepest decent evaluation of (6.49) then leads to

$$G_\rho(\boldsymbol{\tau}) \sim e^{-\Delta \boldsymbol{\mu} \cdot \boldsymbol{\tau}} e^{-(|\boldsymbol{\tau}|/\tau_0)^{1-\epsilon_\tau/2}}, \quad (6.50)$$

where $\tau_0(J_0) = [\kappa_0 V_0(\kappa_0) / 4A(\epsilon_\tau)]^{1/(1-\epsilon_\tau)}$, and various non-exponential prefactors have been dropped. The $(|\boldsymbol{\tau}|/\tau_0)^{1-\epsilon_\tau/2}$ exponent reproduces (3.20) at $\Delta \boldsymbol{\mu} = \mathbf{0}$ and $\epsilon_\tau = 1$. This is quite a remarkable result: Although the temporal correlations decay at infinity within any given droplet, the large droplet tail of the distribution causes the droplet averaged correlation function to *diverge* in directions such that $\Delta \boldsymbol{\mu} \cdot \boldsymbol{\tau} \rightarrow -\infty$. This strongly distinguishes the Bose glass phase from the Mott phase.

A related quantity is the superfluid susceptibility,

$$\chi_s = \left(\frac{\partial \psi_0}{\partial h} \right)_{h=0} = \int d^d x \int d^{\epsilon_\tau} \tau G(\mathbf{x}, \boldsymbol{\tau}). \quad (6.51)$$

The saddle point estimate of the contribution from a single droplet is given by,

$$\begin{aligned} \chi_{\text{drop}}(V) &\approx V \int d^{\epsilon_\tau} \tau G_\rho^{(0)}(\boldsymbol{\tau}) \\ &\sim e^{(1-\epsilon_\tau)\kappa_0 \frac{3-\epsilon_\tau}{1-\epsilon_\tau} \left[\frac{|\Delta\mu|}{(2-\epsilon_\tau)} \right]^{\frac{2-\epsilon_\tau}{1-\epsilon_\tau}} \left[\frac{V}{A(\epsilon_\tau)} \right]^{\frac{1}{1-\epsilon_\tau}}}, \end{aligned} \quad (6.52)$$

which grows faster than exponentially in V , and is therefore dominated by large droplets. The total susceptibility

$$\chi_s \sim \int dV e^{-V/V_0(\kappa_0)} \chi_{\text{drop}}(V) \rightarrow \infty, \quad (6.53)$$

therefore diverges, providing a more direct signature of the Bose glass phase.

3. Droplet model conclusions: $\epsilon_\tau < 1$ vs. $\epsilon_\tau = 1$

The droplet model exhibits some strong differences in the physics of the Bose glass phase, all related to the physics of superfluid droplets, between $\epsilon_\tau = 1$ and $\epsilon_\tau < 1$ that may raise questions about the smoothness of the limit $\epsilon_\tau \rightarrow 1$.

The vanishing density and compressibility in the Bose glass phase implies that there should be no analytic background contribution to κ for $\epsilon_\tau < 1$. Thus (6.17), with some exponent $\alpha(\epsilon_\tau) < 0$, is expected to describe the critical behavior of the full compressibility, not just its singular part. This means that the analytic contribution to the density and compressibility must appear *discontinuously* at $\epsilon_\tau = 1$.

Due to droplet incompressibility, the mechanism leading to a divergent susceptibility for $\epsilon_\tau < 1$ is also rather different than that for $\epsilon_\tau = 1$. As discussed in Sec. III C 3, for the latter, the temporal correlations decay as a slow $1/\tau$ power law—see (3.24) and (3.48)—due to the spectrum of *finite sized* droplets that are very close to adding or giving up an extra particle. For $\epsilon_\tau < 1$, the long-time correlations are dominated by large droplets, and it is the resulting stretched exponential behavior that generates the divergent susceptibility.

These strong differences do not require that critical exponents, such as α , be discontinuous, but one could certainly imagine some kind of nonanalytic behavior, as when one approaches an upper or lower critical dimension of a transition. We shall see below that, at least, the qualitative features of the critical behavior do behave as functions of ϵ_τ in the expected fashion. Since the expansion is around $\epsilon_\tau = 0$, it has absolutely nothing to say about possible singularities at $\epsilon_\tau = 1$. However, the results do lend some support to it as an analytic tool for exploring some features of the Bose glass–superfluid transition in higher dimensions where numerical results are not yet available.

D. Renormalization group calculations

1. Replicated Lagrangian

In this final section, we revisit the renormalization group calculation carried out in Ref. 16, but now with explicit attention to issues of particle-hole symmetry. To this end, we use the standard replica trick on \mathcal{L}_c in (6.1) to average over the disorder,⁴⁵ and obtain the replicated Lagrangian, $\mathcal{L}_c^{(p)} = \mathcal{L}_1^{(p)} + \mathcal{L}_2^{(p)}$, where $p \rightarrow 0$ is the number of replicas, and

$$\mathcal{L}_1^{(p)} = - \sum_{\alpha=1}^p \int d^d x \int d^{\epsilon_\tau} \tau \left[\frac{1}{2} e_\tau |\nabla_\tau \psi_\alpha|^2 + \mathbf{g}_0 \cdot \psi^* \nabla_\tau \psi_\alpha + \frac{1}{2} e_x |\nabla \psi_\alpha|^2 + \frac{1}{2} r_0 |\psi_\alpha|^2 + \frac{1}{4} u |\psi_\alpha|^4 \right] \quad (6.54)$$

$$\begin{aligned} \mathcal{L}_2^{(p)} &= \frac{1}{2} \sum_{\alpha, \beta=1}^p \int d^d x \int d^{\epsilon_\tau} \tau \int d^{\epsilon_\tau} \tau' [\tilde{\Delta}_r |\psi_\alpha(\mathbf{x}, \boldsymbol{\tau})|^2 |\psi_\beta(\mathbf{x}, \boldsymbol{\tau}')|^2 \\ &\quad + \Delta_g [\psi^* \nabla_\tau \psi - \mathbf{g}_0 |\psi|^2](\mathbf{x}, \boldsymbol{\tau}) \cdot [\psi^* \nabla_{\tau'} \psi - \mathbf{g}_0 |\psi|^2](\mathbf{x}, \boldsymbol{\tau}')]. \end{aligned} \quad (6.55)$$

In the end we will take $e_\tau = e_x = 1$, but in setting up the RG calculation it is useful to leave them as free parameters. For simplicity we have taken $\delta \mathbf{g}(\mathbf{x})$ and $\delta \tilde{r}(\mathbf{x}) \equiv \delta r(\mathbf{x}) - \delta \mathbf{g}(\mathbf{x})^2$ to be independent Gaussian ran-

dom fields with

$$\begin{aligned} [\delta \mathbf{g}(\mathbf{x})]_{\text{av}} &= \mathbf{0}, \quad [\delta \mathbf{g}_\mu(\mathbf{x}) \delta \mathbf{g}_\nu(\mathbf{x}')]_{\text{av}} = \Delta_g \delta(\mathbf{x} - \mathbf{x}') \delta_{\mu\nu} \\ [\delta \tilde{r}(\mathbf{x})]_{\text{av}} &= 0, \quad [\delta \tilde{r}(\mathbf{x}) \delta \tilde{r}(\mathbf{x}')]_{\text{av}} = \tilde{\Delta}_r \delta(\mathbf{x} - \mathbf{x}'). \end{aligned} \quad (6.56)$$

The analysis in Ref. 16 was carried out with \mathbf{g}_0 finite and $\Delta_g = 0$, but $\tilde{\Delta}_r > 0$. However, considerations of particle-hole symmetry now lead us to seek fixed points

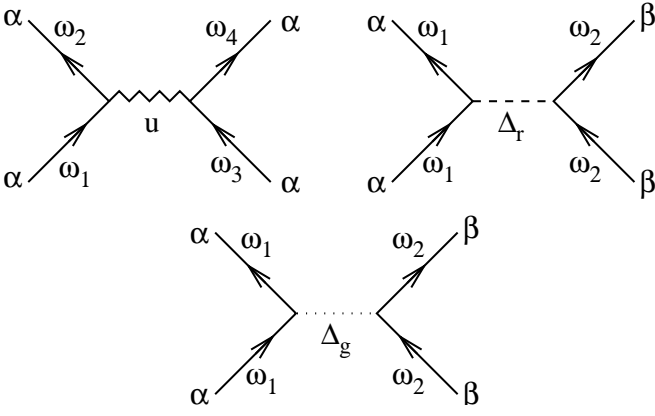

FIG. 9: Vertices corresponding to u , Δ_r and Δ_g , where α, β are replica indices, and the u vertex also enforces energy conservation, $\omega_1 - \omega_2 + \omega_3 - \omega_4 = 0$.

with $\mathbf{g}_0 = 0$ and $\Delta_g > 0$.

In Fourier space we have

$$\begin{aligned} \mathcal{L}_2^{(p)} = & \frac{1}{2} \sum_{\alpha, \beta=1}^p \int_{\mathbf{k}_1} \int_{\mathbf{k}_2} \int_{\mathbf{k}_3} \int_{\mathbf{k}_4} \delta(\mathbf{k}_1 - \mathbf{k}_2 + \mathbf{k}_3 - \mathbf{k}_4) \\ & \times \int_{\omega} \int_{\omega'} [\Delta_r - 2i\Delta_g \mathbf{g}_0 \cdot \omega - \Delta_g \omega \cdot \omega'] \\ & \times \psi_{\alpha}^*(\mathbf{k}_1, \omega) \psi_{\alpha}(\mathbf{k}_2, \omega) \psi_{\beta}^*(\mathbf{k}_3, \omega') \psi_{\beta}(\mathbf{k}_4, \omega'), \end{aligned} \quad (6.57)$$

where $\Delta_r \equiv \tilde{\Delta}_r + \mathbf{g}_0^2 \Delta_g$. Nominally, by naive power counting, it would appear that the leading term at low frequencies should be the Δ_r term, and one might expect the other two frequency dependent terms to be strongly irrelevant. This will turn out to be true for small ϵ_{τ} , where naive power counting is almost valid. However, because ω and ω' refer to different replicas, α and β , these terms break particle-hole symmetry, and are not as strongly irrelevant as one might expect (as compared to, for example, ω^2 corrections to the $|\psi|^4$ coefficient, u), and, in fact, will be seen to become relevant beyond a critical value of ϵ_{τ} .

We shall also begin by setting $\mathbf{g}_0 = 0$. By power counting, the $\mathbf{g}_0 \cdot \psi^* \nabla_{\tau} \psi$ term (focused on in Ref. 16) again appears strongly relevant compared to the $e_{\tau} |\nabla_{\tau} \psi|^2$, and the $\Delta_g \mathbf{g}_0 (\psi^* \nabla_{\tau} \psi) |\psi|^2$ appears strongly relevant compared to the $\Delta_g (\psi^* \nabla_{\tau} \psi) \cdot (\psi^* \nabla_{\tau} \psi)$ term. Again, although relevant at small ϵ_{τ} , there is a (different) critical value beyond which these terms become irrelevant.

2. Recursion relations

We shall perform a standard Wilson momentum shell renormalization group transformation⁴⁶ in which successive shells in k -space are integrated out. For each such \mathbf{k} all frequencies, ω , are integrated out. Since the frequency

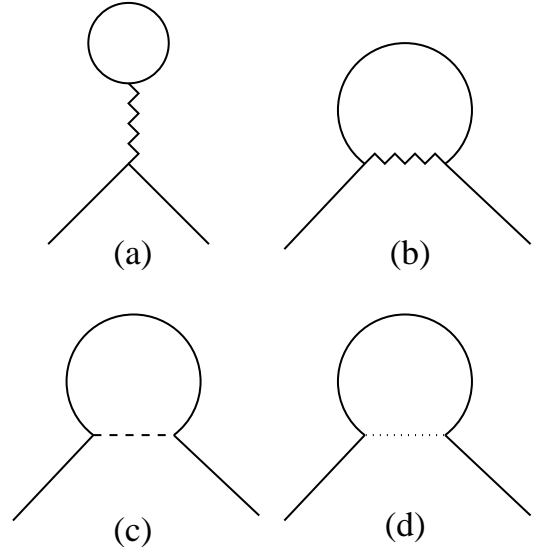

FIG. 10: Diagrams that contribute to the propagator renormalization.

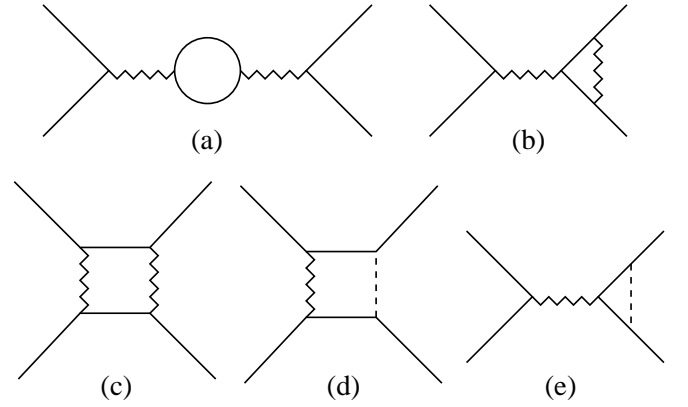

FIG. 11: Diagrams that contribute to the renormalization of u .

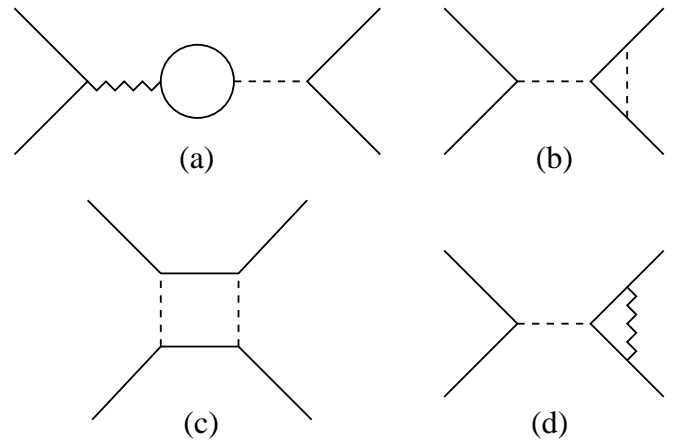

FIG. 12: Diagrams that contribute to the renormalization of Δ_r .

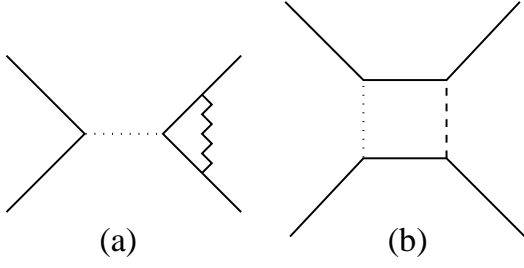

FIG. 13: Diagrams that contribute to the renormalization of Δ_g .

is unbounded, the Brillouin zone is really a hypercylinder. After each integration, we rescale \mathbf{k} and $\boldsymbol{\omega}$ in order to maintain the same wavevector cutoff, k_Λ . The spin rescaling factor and the dynamical exponent, z , are determined in the usual way by setting e_x and e_τ equal to unity.

In Fig. 9 are shown the four basic diagrammatic vertices corresponding to u , Δ_r , and Δ_g , while in Figs. 10–13 are shown the lowest order diagrams that then contribute to the renormalization of the propagator and of the vertices themselves. Note that there are a number of “missing” diagrams not included because they do not contribute in the replica limit, $p \rightarrow 0$. We obtain, then, in a straightforward way the recursion relations:

$$\frac{d\bar{r}}{dl} = 2\bar{r} + \frac{2(m+1)\bar{u}}{1+\bar{r}} - \frac{2\bar{\Delta}_r}{1+\bar{r}} + O(\bar{u}^2, \bar{\Delta}_r^2, \bar{\Delta}_g^2) \quad (6.58)$$

$$\frac{d\bar{u}}{dl} = \epsilon\bar{u} - 2(m+4)\bar{u}^2 + 12\bar{u}\bar{\Delta}_r + O(\bar{u}^3, \dots) \quad (6.59)$$

$$\frac{d\bar{\Delta}_r}{dl} = (\epsilon + \epsilon_\tau)\bar{\Delta}_r + 8\bar{\Delta}_r^2 - 4(m+1)\bar{u}\bar{\Delta}_r + O(\bar{u}^3, \dots) \quad (6.60)$$

$$\begin{aligned} \frac{d\bar{\Delta}_g}{dl} &= \bar{\Delta}_g(\epsilon + \epsilon_\tau + 10\bar{\Delta}_r - 2\bar{\Delta}_g - 2) \\ &\equiv \lambda_g \bar{\Delta}_g - 2\bar{\Delta}_g^2, \end{aligned} \quad (6.61)$$

where m is the number of boson species ($m = 1$ physically), $\bar{r} = r_0/k_\Lambda^2$, $\bar{u} = K_d u/4$, $\bar{\Delta}_r = K_d \Delta_r$, $\bar{\Delta}_g = k_\Lambda^2 K_d \Delta_g$ are appropriately rescaled by the cutoff, and $K_d = 2/(4\pi)^{d/2} \Gamma(d/2)$ is $(2\pi)^{-d}$ times the area of the unit sphere in d -dimensions. The conditions $e_x = e_\tau = 1$ lead to the identifications

$$z = 1 + \bar{\Delta}_r + \bar{\Delta}_g, \quad \eta = 0. \quad (6.62)$$

3. Dirty bosons fixed point

Note that $\bar{\Delta}_g$ does not enter any recursion relations except its own at this order. If one sets $\bar{\Delta}_g = 0$ one obtains the usual Boyanovsky-Cardy lowest order recursion

relations,¹⁵ with fixed point

$$\begin{aligned} \bar{r}^* &= -\frac{3m\epsilon + (5m+2)\epsilon_\tau}{8(2m-1)}, \quad \bar{u}^* = \frac{\epsilon + 3\epsilon_\tau}{4(2m-1)} \\ \bar{\Delta}_g^* &= 0, \quad \bar{\Delta}_r^* = \frac{(2-m)\epsilon + (m+4)\epsilon_\tau}{8(2m-1)}, \end{aligned} \quad (6.63)$$

correct to linear order in ϵ and ϵ_τ . For sufficiently small ϵ, ϵ_τ we see that $\lambda_g^* < 0$ and, consistent with the previous power counting estimates, this fixed point is stable against the perturbation $\bar{\Delta}_g$. However, for

$$\epsilon_\tau > \epsilon_\tau^c \equiv \frac{8(2m-1) - 3(m+2)\epsilon}{13m+16} \quad (6.64)$$

this fixed point becomes unstable. Setting $m = 1$ and $\epsilon = 0$ (so that $\epsilon_\tau = 1$ corresponds to $d = 3$) we find

$$\epsilon_\tau^c = \frac{8}{29}, \quad (6.65)$$

which is actually quite small, and is therefore a potentially reasonable estimate. Using (6.61) and (6.62) at $\bar{\Delta}_g = 0$, one may write $\lambda_g = 2z - d + 8\bar{\Delta}_r$. The last term shows the rather large deviation from the naive result $\lambda_g = 2z - d$, discussed in Sec. VIA 3. The latter would have led to the estimate $\epsilon_\tau^c = \frac{8}{9}$, which is uncomfortably close to unity, considering how poorly controlled this expansion is for larger ϵ_τ .¹⁵

For $\epsilon_\tau > \epsilon_\tau^c$, there is now a new stable finite $\bar{\Delta}_g$ fixed point,

$$\bar{\Delta}_g^* = \frac{1}{2}(\epsilon + \epsilon_\tau + 10\bar{\Delta}_r^* - 2) = \frac{13m+16}{4(2m-1)}(\epsilon_\tau - \epsilon_\tau^c), \quad (6.66)$$

which bifurcates continuously away from the random rod fixed point. The corresponding dynamical exponent,

$$z = 1 + \bar{\Delta}_r^* + \bar{\Delta}_g^* = \frac{(m+4)\epsilon + (7m+10)\epsilon_\tau}{4(2m-1)}, \quad \epsilon_\tau > \epsilon_\tau^c, \quad (6.67)$$

is substantially *larger* than the random rod value. For $m = 1$, $\epsilon = 0$, and $\epsilon_\tau = 1$ one obtains $z = \frac{17}{4}$, which should be considered a very crude extrapolation. The “thermal” eigenvalue, determining ν , is

$$\begin{aligned} \frac{1}{\nu} &= 2 - 2(m+1)\bar{u}^* + 2\bar{\Delta}_r^* \\ &= 2 - \frac{(m+4)\epsilon + (7m+10)\epsilon_\tau}{8(2m-1)}, \end{aligned} \quad (6.68)$$

while, as stated above, $\eta = 0$. These results are both unchanged from their random rod values at this order.

4. Relevance of particle-hole symmetry breaking

Finally, let us include the \mathbf{g}_0 term. To linear order the flow equation for $g_0 = |\mathbf{g}_0|$ is found to be

$$\frac{dg_0}{dl} = g_0[1 + \bar{\Delta}_r - \bar{\Delta}_g]. \quad (6.69)$$

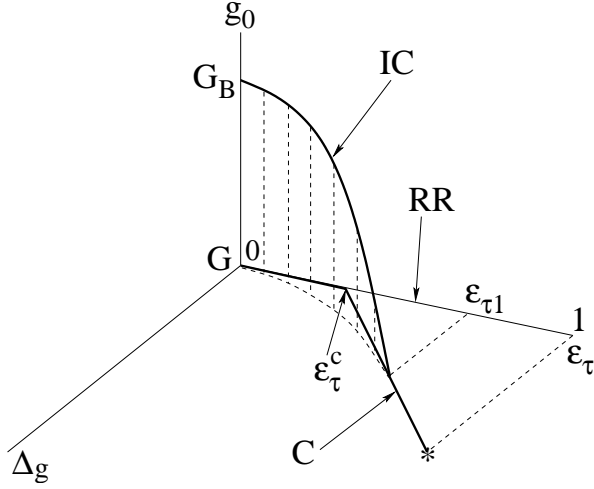

FIG. 14: Proposed behavior of the random rod (RR), commensurate (statistically particle-hole symmetric) dirty boson (C), and incommensurate (fully particle-hole asymmetric) dirty boson (IC) fixed points as functions of ϵ_τ . The Δ_r axis has been suppressed. Here G and G_B are commensurate and incommensurate Gaussian fixed points. The commensurate fixed point bifurcates away from the random rod fixed point at $\epsilon_\tau^c \simeq \frac{8}{29}$. At $\epsilon_\tau = \epsilon_{\tau 1} \simeq \frac{2}{3}$, C and IC merge and at $\epsilon_\tau = 1$, C is the stable fixed point that describes the physical dirty boson problem.

Consistent with the power counting estimates, g_0 is strongly relevant for small ϵ_τ , and is always relevant at the random rod fixed point, $\bar{\Delta}_g = 0$. However, g_0 becomes *irrelevant* at the dirty boson fixed point for

$$\epsilon_\tau \geq \epsilon_{\tau 1} \equiv \frac{4(2m-1)}{3(1+m-\epsilon)}. \quad (6.70)$$

For $m = 1$ and $\epsilon = 0$ one obtains $\epsilon_{\tau 1} = \frac{2}{3}$. This is again an uncontrolled estimate, but does indeed indicate that the statistical particle-hole symmetry is restored prior to $\epsilon_\tau = 1$.

For $\epsilon_\tau < \epsilon_{\tau 1}$ there is a new incommensurate fixed point at nonzero g_0 . In order to locate it one should choose z to keep g_0 , rather than e_τ , fixed during the RG flow. The flow equation for Δ_g then becomes

$$\frac{d\bar{\Delta}_g}{dl} = \bar{\Delta}_g[\epsilon + \epsilon_\tau - 4 + 8\bar{\Delta}_r] + 8\bar{\Delta}_r^2, \quad (6.71)$$

while the remaining flow equations are identical to those in Ref. 16. The fixed point found in that work did not account for Δ_g , but we see that if $\bar{\Delta}_r = O(\epsilon, \epsilon_\tau)$ then $\bar{\Delta}_g = O(\epsilon^2, \epsilon\epsilon_\tau, \epsilon_\tau^2)$, so the results given there are indeed correct to $O(\epsilon, \epsilon_\tau)$. However, as ϵ_τ grows, so does $\bar{\Delta}_g^*$, eventually leading to the merging with the dirty boson fixed point.

The technical problems encountered in Ref. 16 are also overcome in our analysis. Specifically, the $|\nabla_\tau \psi|^2$ term, which was also previously ignored, has the flow equation

$$\frac{de_\tau}{dl} = -(1 + \bar{\Delta}_r)e_\tau + \bar{\Delta}_g, \quad (6.72)$$

implying that it is of the same order as $\bar{\Delta}_g^*$ at the fixed point. A nonzero e_τ fixes the convergence problems, and allows one to remove an unphysical frequency cutoff ω_Λ .

Finally, to see how the two fixed points merge, we write down flow equations in the intermediate region, $\epsilon_{\tau 1} > \epsilon_\tau > \epsilon_\tau^c$, where one must consider both e_τ and $\bar{g}_0 \equiv k_\Lambda g_0$. We choose z so that $e_\tau + \bar{g}_0 \equiv 1$ remains fixed. The flow equation for g_0 is then

$$\frac{dg_0}{dl} = (2 + 2\bar{\Delta}_r - z)g_0 \quad (6.73)$$

with

$$z = (1 + \bar{\Delta}_r \bar{\Delta}_g) + (1 + \bar{\Delta}_r)\bar{g}_0. \quad (6.74)$$

At the fixed point we therefore find

$$\bar{g}_0^* = \frac{1 + \bar{\Delta}_r^* - \bar{\Delta}_g^*}{1 + \bar{\Delta}_r^*}, \quad (6.75)$$

which vanishes precisely when g_0 becomes irrelevant at the dirty boson fixed point.

The entire proposed fixed point structure as a function of ϵ_τ is summarized in Fig. 14). For small ϵ_τ the unstable random fixed point and stable fully particle-hole asymmetric fixed points exist. For $\epsilon_\tau^c < \epsilon_\tau < \epsilon_{\tau 1}$ there are three fixed points, with the new commensurate dirty boson fixed point being more stable than the random rod fixed point, but less stable than the asymmetric fixed point. Finally, for $\epsilon_\tau > \epsilon_{\tau 1}$ the incommensurate fixed point merges with the dirty boson fixed point, which is then completely stable. This provides a detailed scenario by which statistical particle-hole symmetry is restored. We caution, however, that due both to the uncontrolled nature of the double ϵ -expansion at the dirty boson fixed point, and the special nature of $\epsilon_\tau = 1$, extrapolation of these results to $\epsilon_\tau = 1$ should be treated as, at best, qualitative estimates. The general scenario we propose, however, seems very natural and illuminating.

APPENDIX A: FUNCTIONAL INTEGRALS BASED ON THE TROTTER DECOMPOSITION

Given a Hamiltonian, \mathcal{H} , thermodynamics is obtained from the partition function $Z = \text{tr} [e^{-\beta\mathcal{H}}]$. The Trotter decomposition involves identifying a convenient complete set of states $\{|\alpha\rangle\}$, writing $e^{-\beta\mathcal{H}} = [e^{-\Delta\tau\mathcal{H}}]^M$, where $M = \beta/\Delta\tau$, and inserting the states $|\alpha\rangle$ between each element of the product:

$$Z = \sum_{\alpha_0} \sum_{\alpha_1} \dots \sum_{\alpha_{M-1}} \langle \alpha_0 | e^{-\Delta\tau\mathcal{H}} | \alpha_1 \rangle \langle \alpha_1 | e^{-\Delta\tau\mathcal{H}} | \alpha_2 \rangle \dots \times \langle \alpha_{M-1} | e^{-\Delta\tau\mathcal{H}} | \alpha_0 \rangle. \quad (A1)$$

Often one can decompose $\mathcal{H} = \mathcal{H}_0 + \mathcal{H}_1$, and choose the $|\alpha\rangle$'s to be eigenstates of \mathcal{H}_0 . This is especially convenient when $\mathcal{H} = \mathcal{H}[\{\hat{q}_i\}, \{\hat{p}_i\}]$ is written in terms of a set of N

canonically conjugate positions, \hat{q}_i , and momenta, \hat{p}_i , and takes the special form

$$\mathcal{H} = \mathcal{H}_0[\{\hat{q}_i\}] + \mathcal{H}_1[\{\hat{p}_i\}] \quad (\text{A2})$$

in which \mathcal{H}_1 is a quadratic polynomial in the \hat{p}_i :

$$\mathcal{H}_1 = \frac{1}{2} \sum_{i,j} S_{ij} \hat{p}_i \hat{p}_j + \sum_i t_i \hat{p}_i. \quad (\text{A3})$$

The $|\alpha\rangle$'s are then taken to be product eigenstates of the positions \hat{q}_i : $|q\rangle \equiv |q_1, \dots, q_N\rangle = \otimes_{i=1}^N |q_i\rangle$ with $\hat{q}_i |q\rangle = q_i |q\rangle$. We also define product eigenstates of the momenta, $|p\rangle \equiv |p_1, \dots, p_N\rangle = \otimes_{i=1}^N |p_i\rangle$, with $\hat{p}_i |p\rangle = p_i |p\rangle$. From the canonical commutation relations, $[\hat{q}_i, \hat{p}_i] = i\delta_{ij}$, which in turn imply

$$\begin{aligned} [\hat{q}_i, e^{-i\lambda\hat{p}_j}] &= \lambda e^{-i\lambda\hat{p}_j} \delta_{ij} \\ [e^{i\lambda\hat{q}_i}, \hat{p}_j] &= -\lambda e^{i\lambda\hat{q}_i} \delta_{ij}, \end{aligned} \quad (\text{A4})$$

we immediately infer that

$$\begin{aligned} e^{-i\lambda\hat{p}_j} |q_j\rangle &= |q_j + \lambda\rangle \\ e^{i\lambda\hat{q}_j} |p_j\rangle &= |p_j + \lambda\rangle. \end{aligned} \quad (\text{A5})$$

From this we obtain the *wavefunctions*

$$\begin{aligned} \langle q_i | p_i \rangle &= \langle q_i = 0 | e^{iq_i \hat{p}_i} | p_i \rangle = e^{iq_i p_i} \langle q_i = 0 | e^{ip_i \hat{q}_i} | p_i = 0 \rangle \\ &= \frac{1}{\mathcal{N}} e^{iq_i p_i}, \end{aligned} \quad (\text{A6})$$

where $\frac{1}{\mathcal{N}} \langle q_i = 0 | p_i = 0 \rangle$ normalizes the wavefunction. Note that if the q_i are periodic variables, defined only modulo 2π , say, then $|q_i\rangle \equiv |q_i + 2\pi\rangle$ are identified. This requires the same periodicity of the wavefunctions, and determines the allowed eigenvalues, p_i —which therefore must be integers in this case, and one obtains $\mathcal{N} = \sqrt{2\pi}$ as well.

With the shorthands $\hat{q} = \{\hat{q}_i\}$, $\hat{p} = \{\hat{p}_i\}$, etc., we may now compute, for small $\Delta\tau$,

$$\begin{aligned} \langle q | e^{-\Delta\tau \mathcal{H}} | q' \rangle &\approx \langle q | e^{-\Delta\tau \mathcal{H}_0(\hat{q})} e^{-\Delta\tau \mathcal{H}_1(\hat{p})} | q' \rangle \\ &= e^{-\Delta\tau \mathcal{H}_0(q)} \sum_p \langle q | p \rangle \langle p | e^{-\Delta\tau \mathcal{H}_1(\hat{p})} | q' \rangle \\ &= e^{-\Delta\tau \mathcal{H}_0(q)} \sum_p e^{-\Delta\tau \mathcal{H}_1(p)} \langle q | p \rangle \langle p | q' \rangle \\ &= \frac{e^{-\Delta\tau \mathcal{H}_0(q)}}{\mathcal{N}^N} \sum_p e^{-\Delta\tau \mathcal{H}_1(p)} e^{i \sum_i p_i (q_i - q'_i)}, \end{aligned} \quad (\text{A7})$$

and we are now left only with computing the inverse Fourier transform of the Gaussian function $e^{-\Delta\tau \mathcal{H}_1(p)}$. To do this, we first complete the square:

$$\begin{aligned} \mathcal{H}_1[\hat{p}] &= \frac{1}{2} \sum_{i,j} S_{ij} (\hat{p}_i + \nu_i) (\hat{p}_j + \nu_j) - \frac{1}{2} \sum_{i,j} \nu_i \nu_j \\ \nu_i &\equiv \sum_j (S^{-1})_{ij} t_j; \quad t_i = \sum_j S_{ij} \nu_j. \end{aligned} \quad (\text{A8})$$

We specialize now to the case of integer p_i . Using the formula

$$\begin{aligned} \sum_{p_i=-\infty}^{\infty} &= \int_{-\infty}^{\infty} dp_i \sum_{n_i=-\infty}^{\infty} \delta(p_i - n_i) \\ &= \int_{-\infty}^{\infty} dp_i \sum_{m_i=-\infty}^{\infty} e^{i2\pi m_i p_i}, \end{aligned} \quad (\text{A9})$$

one obtains

$$\begin{aligned} &\frac{1}{\mathcal{N}^N} \sum_p e^{i \sum_i p_i (q_i - q'_i)} e^{-\Delta\tau \mathcal{H}_1(p)} \\ &= \sum_m \int \frac{dp}{\mathcal{N}^N} e^{i \sum_i p_i (q_i - q'_i + 2\pi m_i)} e^{-\Delta\tau \mathcal{H}_1(p)} \quad (\text{A10}) \\ &= \sum_m e^{\frac{1}{2} \Delta\tau \sum_{i,j} S_{ij} \nu_i \nu_j - i \sum_i \nu_i (q_i - q'_i + 2\pi m_i)} \\ &\quad \times \int \frac{d\bar{p}}{\mathcal{N}^N} e^{-\frac{1}{2} \Delta\tau \sum_{i,j} S_{ij} \bar{p}_i \bar{p}_j + i \sum_i \bar{p}_i (q_i - q'_i + 2\pi m_i)} \\ &= \frac{1}{\mathcal{N}(\Delta\tau)} \sum_m e^{\frac{1}{2} \Delta\tau \sum_{i,j} S_{ij} \nu_i \nu_j - \sum_i \nu_i (q_i - q'_i + 2\pi m_i)} \\ &\quad \times e^{-\frac{1}{2\Delta\tau} \sum_{i,j} (S^{-1})_{ij} (q_i - q'_i + 2\pi m_i) (q_j - q'_j + 2\pi m_j)} \end{aligned}$$

where, in the second equality, we have changed variables to $\bar{p}_i = p_i + \nu_i$, and $\mathcal{N}(\Delta\tau) = \sqrt{\det(\Delta\tau S)}$.

Now consider the limit $\Delta\tau \rightarrow 0$. For given $\{q_i\}$ only a *single* term in the m -sum will survive, namely that which minimizes the exponent. Furthermore, only if $q_i - q'_i + 2\pi m_i = O(\Delta\tau^{\frac{1}{2}})$ will the term contribute to the path integral, (A1). Therefore, modulo 2π , $q_i(\tau)$ becomes a continuous function in the limit $\Delta\tau \rightarrow 0$, and $q_i - q'_i + 2\pi m_i \rightarrow -\Delta\tau \dot{q}_i$. Clearly we will nearly always have $m_i = 0$, with $m_i = \pm 1$ every so often when the periodic boundary conditions are enforced (for example, when $q_i = 2\pi^-$ and $q'_i = 0^+$, or vice versa). When $\Delta\tau \rightarrow 0$ we may equivalently define a continuous function $q_i(\tau)$, taking arbitrary real values, and then sum over all boundary conditions $q_i(\tau) = q_i(0) + 2\pi m_i$, with m_i running over all integers. Thus, we finally have, as $\Delta\tau \rightarrow 0$:

$$\begin{aligned} &\langle q | e^{-\Delta\tau \mathcal{H}_1(\hat{p})} | q' \rangle \\ &= \frac{1}{\mathcal{N}(\Delta\tau)} e^{-\frac{1}{2} \Delta\tau \sum_{i,j} (S^{-1})_{ij} \dot{q}_i \dot{q}_j} \quad (\text{A11}) \\ &\quad \times e^{-i \Delta\tau \sum_i \nu_i \dot{q}_i + \frac{1}{2} \Delta\tau \sum_{i,j} S_{ij} \nu_i \nu_j} \\ &= \frac{1}{\mathcal{N}(\Delta\tau)} e^{-\frac{1}{2} \Delta\tau \sum_{i,j} (S^{-1})_{ij} (\dot{q}_i + it_i) (\dot{q}_j + it_j)}, \end{aligned}$$

and

$$\begin{aligned} Z &= \frac{1}{\sqrt{\det(S)}} \int \mathcal{D}q(\tau) \exp \left\{ - \int_0^\beta d\tau \left[\mathcal{H}_0[q(\tau)] \right. \right. \\ &\quad \left. \left. + \frac{1}{2} \sum_{i,j} (S^{-1})_{ij} (\dot{q}_i + it_i) (\dot{q}_j + it_j) \right] \right\}, \end{aligned} \quad (\text{A12})$$

where $\int \mathcal{D}q(\tau)$ is a functional integral over all paths with a uniform (Wiener) measure.

Equation (A12) now leads directly to the path integral representation for the Josephson Hamiltonian (2.3), with \hat{q} replaced by $\hat{\phi}$ and \hat{p} replaced by \hat{n} . The term $\mathcal{H}(\hat{q})$ is just the Josephson cosine coupling term.

If, instead of canonical coordinates, $\mathcal{H} = \mathcal{H}[a^\dagger, a]$ is written instead in terms of raising and lowering operators, another convenient complete set of states is that of the coherent states,

$$\begin{aligned} |\alpha\rangle &= \sum_{n=0}^{\infty} \frac{\alpha^n}{\sqrt{n!}} |n\rangle, \quad a|\alpha\rangle = \alpha|\alpha\rangle \\ \langle\alpha|\alpha'\rangle &= \sum_{n=0}^{\infty} \frac{(\alpha^* \alpha')^n}{n!} e^{-\frac{1}{2}|\alpha|^2 - \frac{1}{2}|\alpha'|^2} \\ &= e^{\alpha^* \alpha' - \frac{1}{2}|\alpha|^2 - \frac{1}{2}|\alpha'|^2}. \end{aligned} \quad (\text{A13})$$

Thus, for any normally ordered operator, $O(a^\dagger, a)$, we have

$$\langle\alpha|O(a^\dagger, a)|\alpha'\rangle = O(\alpha^*, \alpha')\langle\alpha|\alpha'\rangle, \quad (\text{A14})$$

and hence for $\Delta\tau \rightarrow 0$

$$\begin{aligned} \langle\alpha|e^{-\Delta\tau\mathcal{H}[a^\dagger, a]}|\alpha'\rangle &\approx \langle\alpha|(1 - \Delta\tau\mathcal{H}[a^\dagger, a])|\alpha'\rangle \\ &\approx \langle\alpha|\alpha'\rangle e^{-\Delta\tau\mathcal{H}[\alpha^*, \alpha']}. \end{aligned} \quad (\text{A15})$$

Recognizing that

$$\begin{aligned} \sum_n \left[\alpha_n^* \alpha_{n+1} - \frac{1}{2}|\alpha_n|^2 - \frac{1}{2}|\alpha_{n+1}|^2 \right] \\ = \Delta\tau \sum_n \alpha_n^* \left(\frac{\alpha_{n+1} - \alpha_n}{\Delta\tau} \right), \end{aligned} \quad (\text{A16})$$

where the periodic boundary conditions in imaginary time have been used, we arrive at (2.1) (with ψ replacing α) when $\Delta\tau \rightarrow 0$.

APPENDIX B: DUALITY TRANSFORMATIONS

In order to obtain a model amenable to analysis in one dimension one must derive a *dual representation* for the Josephson Lagrangian, (2.3). In Ref. 6 this was done in a somewhat *ad hoc* fashion using the Haldane representation for one-dimensional bosons. Here we perform the duality transformation directly, on a variant of the Josephson Lagrangian (2.3), in a much more transparent manner, following closely the analogous derivation for the two-dimensional *XY*-model and its associated Kosterlitz-Thouless transition.²³

The transformation is best carried out in discrete time. The continuous time limit is mathematically well defined but, as we shall see, physically less transparent: one runs into logarithmically divergent coupling constants, just as in the Trotter decomposition of the quantum Ising model

in a transverse field.⁴⁷ These are consequence of the usual exponential weighting times in continuous time, discrete state Markov processes. In order to avoid introducing the probabilistic formalism necessary for dealing with the continuum limit we shall maintain a discrete time variable.

We begin by introducing the Villain, or periodic Gaussian form, of the *XY*-coupling:²³

$$e^{-K_0(1-\cos(\phi))} \rightarrow \sum_{m=-\infty}^{\infty} e^{-\frac{1}{2}K(\phi-2\pi m)^2} \equiv e^{V_0(\phi, K)}, \quad (\text{B1})$$

which allows the duality transformation to be carried out *exactly*. We will consider only the case where J_{ij} in (2.3) is nearest neighbor, but possibly random. In (B1) $K_0 = J_{ij}\Delta\tau$ for the bond $\langle ij \rangle$, and therefore already includes the effect of discretizing the τ -integral in (2.3). There are two limits in which K and K_0 may be quantitatively compared. For large K_0 the variable ϕ will have only small fluctuations about zero, and only the curvature, K_0 , near the minimum of the cosine potential at $\phi = 0$ is important. In this limit only the $m = 0$ term contributes to the Villain form, and the two potentials therefore match when $K \approx K_0$. Conversely, when K_0 is small, ϕ fluctuates strongly, and many m contribute to the Villain sum. It is then convenient to use the Fourier representation²³

$$e^{V_0(\phi, K)} = \sum_{l=-\infty}^{\infty} \frac{e^{-l^2/2K}}{\sqrt{2\pi K}} e^{il\phi}, \quad (\text{B2})$$

where now, for small K , only the $l = 0, \pm 1$ terms are important. This yields

$$V_0(\phi, K) \approx -\frac{1}{2} \ln(2\pi K) + 2e^{-\frac{1}{2K}} \cos(\phi), \quad K \rightarrow 0, \quad (\text{B3})$$

and hence the correspondence $K \approx 1/2 \ln(2/K_0)$ in this limit. Now, the continuum limit, $\Delta\tau \rightarrow 0$, corresponds to $K_0 \rightarrow 0$, and therefore (B3) is appropriate. This yields $K \approx -1/2 \ln(\bar{J}_{ij}\Delta\tau)$ as $\Delta\tau \rightarrow 0$ —the logarithmic behavior alluded to above. We shall keep $\Delta\tau$ small but finite, setting aside the question of its optimal value, which would have to be addressed for *quantitative* comparison of the Josephson and Villain forms of our model. For our purposes it is important only that the discrete and continuous time versions lie in the same universality class.

Using (B1) we then define the Villain form of the Josephson Lagrangian, (2.3):

$$\begin{aligned} e^{\bar{\mathcal{L}}_J[\phi]} &\equiv \sum_{\mathbf{m}} e^{\bar{\mathcal{L}}_J[\phi, \mathbf{m}]} \\ \bar{\mathcal{L}}_J &\equiv -\frac{1}{2} \sum_{\mathbf{r}, \alpha \neq 0} K_i^\alpha (\partial_\alpha \phi_{\mathbf{r}} - 2\pi m_{\mathbf{r}}^\alpha)^2 \\ &\quad - \frac{1}{2} \sum_{i, j, \tau} (\mathbf{V}^{-1})_{ij} (\partial_\tau \phi_{i\tau} - i\nu_i - 2\pi m_{i\tau}^0) \\ &\quad \times (\partial_\tau \phi_{j\tau} - i\nu_j - 2\pi m_{j\tau}^0), \end{aligned} \quad (\text{B4})$$

where $\partial_\alpha \phi_{\mathbf{r}} \equiv \phi_{\mathbf{r}+\hat{\alpha}} - \phi_{\mathbf{r}}$ and $\mathbf{m}_{\mathbf{r}} = (m_{\mathbf{r}}^0, m_{\mathbf{r}}^1, \dots, m_{\mathbf{r}}^d)$ is a $(d+1)$ -dimensional integer vector field defined at each space-time lattice site $\mathbf{r} \equiv (i, \tau)$, and the index $\alpha = 0, 1, \dots, d$ runs over the neighboring sites in the $\hat{\alpha} \equiv \hat{\mathbf{x}}_\alpha$ direction, with $\hat{\mathbf{x}}_0 = \hat{\boldsymbol{\tau}}$. Until further notice there is no restriction on the dimensionality, d . The parameters K_i^α , V_{ij} and ν_i are, respectively, the Villain analogues of $J_{ij}\Delta\tau$, $U_{ij}\Delta\tau$ and $\mu_i\Delta\tau$ in (2.3).

Since $e^{\tilde{\mathcal{L}}_J}$ is separately periodic in all the differences $\partial_\alpha \phi_{\mathbf{r}}$ we may write it as a Fourier series,

$$e^{\tilde{\mathcal{L}}_J[\phi]} = \frac{1}{\mathcal{M}} \sum_{\mathbf{n}} e^{i \sum_{\mathbf{r}, \alpha} n_{\mathbf{r}}^\alpha (\phi_{\mathbf{r}+\hat{\alpha}} - \phi_{\mathbf{r}})} e^{\tilde{\mathcal{L}}_J[\mathbf{n}]}, \quad (\text{B5})$$

where

$$\frac{1}{\mathcal{M}} e^{\tilde{\mathcal{L}}_J[\mathbf{n}]} = \prod_{\mathbf{r}, \alpha} \int_0^{2\pi} \frac{d\theta_{\mathbf{r}}^\alpha}{2\pi} e^{-i \sum_{\mathbf{r}, \alpha} n_{\mathbf{r}}^\alpha \theta_{\mathbf{r}}^\alpha} e^{-\tilde{\mathcal{L}}_J[\phi_{\mathbf{r}+\hat{\alpha}} - \phi_{\mathbf{r}} \rightarrow \theta_{\mathbf{r}}^\alpha]} \quad (\text{B6})$$

so that

$$\hat{\mathcal{L}}_J[\mathbf{n}] = -\frac{1}{2} \sum_{i, \tau, \alpha \neq 0} \frac{(n_{i\tau}^\alpha)^2}{K_i^\alpha} - \frac{1}{2} \sum_{i, j} V_{ij} n_{i\tau}^0 n_{j\tau}^0 + \sum_{i\tau} \nu_i n_{i\tau}^0, \quad (\text{B7})$$

and the normalization is

$$\mathcal{M} = \sqrt{\det(2\pi \mathbf{V})} \prod_{i, \tau, \alpha \neq 0} \frac{2\pi}{K_i^\alpha}. \quad (\text{B8})$$

To derive (B7) we have used the identity

$$\int_{-\infty}^{\infty} \frac{du}{2\pi} e^{-imu} e^{-\frac{1}{2}K(u+iv)^2} = \frac{1}{\sqrt{2\pi K}} e^{-mv} e^{-m^2/2K} \quad (\text{B9})$$

and its higher-dimensional generalizations. The partition function now becomes

$$Z = \text{tr}^\phi e^{\tilde{\mathcal{L}}_J[\phi]} = \frac{1}{\mathcal{M}} \sum_{\mathbf{n}} \prod_{\mathbf{r}} \delta_{\nabla \cdot \mathbf{n}_{\mathbf{r}}, 0} e^{-\hat{\mathcal{L}}_J[\mathbf{n}]}, \quad (\text{B10})$$

where $\nabla \cdot \mathbf{n}$ is the discrete space-time divergence,

$$\nabla \cdot \mathbf{n}_{\mathbf{r}} = \sum_{\alpha} (n_{\mathbf{r}}^\alpha - n_{\mathbf{r}-\hat{\alpha}}^\alpha). \quad (\text{B11})$$

This formulation is entirely real, and is therefore a convenient basis for Monte Carlo simulations of the dirty boson problem.⁴⁸

Let us now restrict attention to $d=1$. One may then solve the constraint $\nabla \cdot \mathbf{n} = 0$ by introducing a *dual lattice* integer field, $S_{\mathbf{R}}$, such that

$$\mathbf{n}_{\mathbf{r}} = (\nabla \times S)_{\mathbf{r}} \equiv (S_{\mathbf{R}-\hat{\mathbf{x}}} - S_{\mathbf{R}}, S_{\mathbf{R}} - S_{\mathbf{R}-\hat{\boldsymbol{\tau}}}), \quad (\text{B12})$$

where the dual lattice bond connecting $\mathbf{R} - \hat{\boldsymbol{\tau}}$ to \mathbf{R} is the one that cuts the real lattice bond connecting \mathbf{r} to $\mathbf{r} + \hat{\mathbf{x}}$, while that connecting $\mathbf{R} - \hat{\mathbf{x}}$ to \mathbf{R} cuts the one connecting \mathbf{r} to $\mathbf{r} + \hat{\boldsymbol{\tau}}$, i.e., $\mathbf{R} \equiv (I, T) = \mathbf{r} + \frac{1}{2}(\hat{\mathbf{x}} + \hat{\boldsymbol{\tau}})$. Thus the α -component of the discrete curl of a scalar is

the difference between its values on the two dual sites that border the bond from \mathbf{r} to $\mathbf{r} + \hat{\alpha}$. The field $S_{\mathbf{R}}$ is defined uniquely up to an overall additive constant, and the constrained trace over the $\mathbf{n}_{\mathbf{r}}$ is precisely equivalent to the free trace over the $S_{\mathbf{R}}$. One therefore obtains

$$Z = \frac{1}{\mathcal{M}} \sum_S e^{\hat{\mathcal{L}}_J[\nabla \times S]} \quad (\text{B13})$$

with

$$\begin{aligned} \hat{\mathcal{L}}_J[\nabla \times S] &= -\frac{1}{2} \sum_{\mathbf{R}} \frac{1}{K_I} (\partial_{\boldsymbol{\tau}} S_{\mathbf{R}})^2 \\ &\quad - \frac{1}{2} \sum_{I, J, T} V_{IJ} (\partial_x S_{IT}) (\partial_x S_{JT}) \\ &\quad + \sum_{\mathbf{R}} \nu_I (\partial_x S_{\mathbf{R}}). \end{aligned} \quad (\text{B14})$$

Here $\partial_\alpha S_{\mathbf{R}} = S_{\mathbf{R}} - S_{\mathbf{R}-\hat{\alpha}}$, K_I is the Villain coupling on the real lattice bond that cuts $(\mathbf{R} - \hat{\boldsymbol{\tau}}, \mathbf{R})$, and similarly for ν_I and V_{IJ} . Note that in this representation the Lagrangian is purely real and has a very natural classical interpretation, namely that of a three-dimensional interface model. The field $S_{\mathbf{R}}$ represents the height of a surface over a two-dimensional plane. The first two terms in $\hat{\mathcal{L}}_J$ determine the energy cost for steps in the τ and x directions, respectively. In this case the energy associated with steps in the τ direction is random, but only in the spatial index. The last term represents a random tilting potential which *favours* steps in the x direction with the same sign as ν_I . It is precisely this breaking of the symmetry between left and right steps that reflects the broken particle-hole symmetry in the original quantum Hamiltonian. Note that in this dual model the symmetry being broken is associated with parity ($x \rightarrow -x$) rather than time reversal ($\tau \rightarrow -\tau$).

The more common sine-Gordon representation is obtained from (B5) by softening the integer constraint on the $S_{\mathbf{R}}$. Thus $\sum_{S_{\mathbf{R}}=-\infty}^{\infty} = \int_{-\infty}^{\infty} dS_{\mathbf{R}} \sum_{h_{\mathbf{R}}=-\infty}^{\infty} \delta(S_{\mathbf{R}} - h_{\mathbf{R}})$ is replaced by $\int dS_{\mathbf{R}} q(S_{\mathbf{R}})$, where $q(t)$ is periodic with period one, and is peaked around $t=0$. The sine-Gordon model (5.1) results from the choice

$$q(t) = e^{2y_0 \cos(2\pi t)} \quad (\text{B15})$$

where y_0 is called the fugacity. The integer constraint is recovered in the limit $y_0 \rightarrow \infty$. For small y_0 (see below) this term may be obtained directly by including a term

$$\ln(y_0) \sum_{\mathbf{R}} (\nabla \times \mathbf{m})_{\mathbf{R}}^2 \quad (\text{B16})$$

in the original Lagrangian, (B4). The discrete curl of a vector field is a scalar field on the dual lattice obtained by summing the vector field around the dual lattice plaquette,

$$(\nabla \times \mathbf{m})_{\mathbf{R}} = m_{\mathbf{r}}^1 + m_{\mathbf{r}+\hat{\mathbf{x}}}^0 - m_{\mathbf{r}+\hat{\boldsymbol{\tau}}}^1 - m_{\mathbf{r}}^0, \quad (\text{B17})$$

and is precisely the *vorticity* on that plaquette.

Finally, the Coulomb gas representation is obtained either from the sine-Gordon representation by expanding the exponential in (B15) and integrating out the $S_{\mathbf{R}}$, or from the discrete version (B14), by substituting $\sum_{l_{\mathbf{R}}=-\infty}^{\infty} e^{i2\pi l_{\mathbf{R}} S_{\mathbf{R}}}$ for $\sum_{h_{\mathbf{R}}=-\infty}^{\infty} \delta(S_{\mathbf{R}} - h_{\mathbf{R}})$:

$$\begin{aligned} Z &= \text{tr}^l \text{tr}^S \left[e^{2\pi i \sum_{\mathbf{R}} l_{\mathbf{R}} S_{\mathbf{R}}} e^{\hat{\mathcal{L}}_J[\nabla \times S]} \right] \\ &= \text{tr}^l \left[e^{\mathcal{L}_C[l]} \right], \end{aligned} \quad (\text{B18})$$

where [we include the term (B15) for completeness],

$$\begin{aligned} \mathcal{L}_C[l] &= \frac{1}{2} \sum_{\mathbf{R}, \mathbf{R}'} \mathcal{G}_{\mathbf{R}\mathbf{R}'} (2\pi l_{\mathbf{R}} + i\partial_x \nu_I) (2\pi l_{\mathbf{R}'} + i\partial_x \nu_{I'}) \\ &+ \ln(y_0) \sum_{\mathbf{R}} l_{\mathbf{R}}^2, \end{aligned} \quad (\text{B19})$$

and $\mathcal{G}_{\mathbf{R}\mathbf{R}'}$ is the inverse of the quadratic form:

$$(\mathcal{G}^{-1})_{\mathbf{R}\mathbf{R}'} = \frac{1}{K_I} (\partial_T \partial_{T'} \delta_{\mathbf{R}\mathbf{R}'} + (\partial_I \partial_{I'} V_{II'}) \delta_{TT'}). \quad (\text{B20})$$

For diagonal $V_{IJ} = V_0 \delta_{IJ}$ and fixed $K_I \equiv K_0$, $\mathcal{G}_{\mathbf{R}\mathbf{R}'}$ is, modulo a trivial rescaling, the inverse of the two-dimensional lattice Laplacian, and yields the usual logarithmic Coulomb interaction at large distances. So long as V_{IJ} is short ranged and $K_I = K_0 + \delta K_I$ with $\delta K_I / K_I \ll 1$, $\mathcal{G}_{\mathbf{R}\mathbf{R}'}$ will remain Coulomb-like at large distances. Note that \mathcal{L}_C is once again complex, with $\partial_x \nu$ playing the role of complex offset charges.

The sine-Gordon form yields the same Coulomb gas form (B19), except that the values of $l_{\mathbf{R}}$ are restricted to 0, ± 1 only. When y_0 is small, large values of $l_{\mathbf{R}}$ are suppressed anyway, and the difference between (B15) and (B16) is negligible.

-
- ¹ See, e.g., N. Read and S. Sachdev, Phys. Rev. Lett. **62**, 1694 (1989); A. V. Chubukov and S. Sachdev, Phys. Rev. Lett. **71**, 169 (1993); J. Miller and D. A. Huse, Phys. Rev. Lett. **70**, 3147 (1993).
- ² See, e.g., J. A. Hertz, Physica Scripta **T10**, 1 (1985) and references therein.
- ³ H. P. Wei, D. C. Tsui, M. A. Paalanen and A. M. M. Pruisken, Phys. Rev. Lett. **61**, 1294 (1988); A. M. M. Pruisken, Phys. Rev. Lett. **61**, 1297 (1988); S. C. Zhang, T. H. Hansson and S. Kivelson, Phys. Rev. Lett. **62**, 82 (1989); N. Read, Phys. Rev. Lett. **62**, 86 (1989); X.-G. Wen and Y.-S. Wu, Phys. Rev. Lett. **70**, 1501 (1993).
- ⁴ See, e.g., P. A. Lee and T. V. Ramakrishnan, Rev. Mod. Phys. **57**, 287 (1985).
- ⁵ See, e.g., (a) D. B. Haviland, Y. Liu and A. M. Goldman, Phys. Rev. Lett. **62**, 2180 (1989); (b) A. F. Hebard and M. A. Paalanen, Phys. Rev. Lett. **65**, 927 (1990); (c) M. P. A. Fisher, Phys. Rev. Lett. **65**, 923 (1990). See also A. M. Goldman and N. Markovic, Physics Today, November 1998, pp. 39-44, and references therein.
- ⁶ M. P. A. Fisher, P. B. Weichman, G. Grinstein and D. S. Fisher, Phys. Rev. B **40**, 546 (1989).
- ⁷ F. Pazmandi, G. T. Zimanyi and R. Scalettar, Phys. Rev. Lett. **75**, 1356 (1995); K. Sheshadri, H. R. Krishnamurthy, R. Pandit, and T. V. Ramakrishnan, Phys. Rev. Lett. **75**, 4075 (1995). The mean field approximation fails to produce a Bose glass phase except as a line separating the Mott insulating and superfluid phases. It does, however, produce a region of quasi-localized superfluid phase, with exponentially small couplings between well separated superfluid droplets, which should be the seed of the Bose-glass phase, and thus cross over to the truly localized non-superfluid phase, when fluctuations about the mean field ground state are taken into account.
- ⁸ J. K. Freericks and H. Monien, Europhys. Lett. **24**, 545 (1994); Phys. Rev. B **53**, 2691 (1996); M. Niemeier, J. K. Freericks, and H. Monien, Phys. Rev. B **60**, 2357 (1999).
- ⁹ Y. Tu and P. B. Weichman, Phys. Rev. Lett. **73**, 6 (1994); Y. B. Kim and X. G. Wen, Phys. Rev. B **49**, 4043 (1994). M. B. Hastings, Phys. Rev. B **64**, 024517 (2001).
- ¹⁰ L. Zhang and M. Ma, Phys. Rev. B **45**, 4855 (1992); K. G. Singh and D. S. Rokhsar, Phys. Rev. B **46**, 3002 (1992).
- ¹¹ Many authors have explored various models in one and two dimensions using quantum Monte Carlo techniques: See, e.g., (a) R. T. Scalettar, G. G. Batrouni and G. T. Zimanyi, Phys. Rev. Lett. **66**, 3144 (1991); (b) W. Krauth, N. Trivedi and D. M. Ceperley, Phys. Rev. Lett. **67**, 2307 (1991). (c) M. Wallin, E. S. Sørensen, S. M. Girvin, and A. P. Young, Phys. Rev. B **49**, 12115 (1994). (d) S. Zhang, N. Kawashima, J. Carlson and J. E. Gubernatis, Phys. Rev. Lett. **74**, 1500 (1995); (e) F. Alet and E. S. Sørensen, Phys. Rev. E **67**, 015701(R) (2003); (f) N. Prokof'ev and B. Svistunov, Phys. Rev. Lett. **92**, 015703 (2004).
- ¹² M. Makivic, N. Trivedi and S. Ullah, Phys. Rev. Lett. **71**, 2307 (1993). There is, however, some argument over the interpretation of the unusual values of the exponents obtained in this work: see P. B. Weichman, Phys. Rev. Lett. **74**, 1038 (1995); N. Trivedi and M. Makivic, Phys. Rev. Lett. **74**, 1039 (1995).
- ¹³ J.-W. Lee, M.-C. Cha, and D. Kim, Phys. Rev. Lett. **87**, 247006 (2001); J.-W. Lee and M.-C. Cha Phys. Rev. B **72**, 212515 (2005).
- ¹⁴ A. Priyadarshree, S. Chandrasekharan, J.-W. Lee, and H. U. Baranger, Phys. Rev. Lett. **97**, 115703 (2006).
- ¹⁵ (a) S. N. Drogovtsev, Phys. Lett. **76A**, 169 (1980); (b) D. Boyanovsky and J. L. Cardy, Phys. Rev. B **26**, 154 (1982); Erratum, Phys. Rev. B **27**, 6971 (1983); (c) I. D. Lawrie and V. V. Prudvikov, J. Phys. C **17**, 1655 (1984).
- ¹⁶ P. B. Weichman and K. Kim, Phys. Rev. B **40**, 813 (1989).
- ¹⁷ R. Mukhopadhyay and P. B. Weichman, Phys. Rev. Lett.

- 76**, 2977 (1996).
- ¹⁸ E. Altman, Y. Kafri, A. Polkovnikov, and G. Refael, Phys. Rev. Lett. **93**, 150402 (2004); arXiv:0711.2070v1 [cond-mat.dis-nn].
- ¹⁹ I. F. Herbut, Phys. Rev. B **57**, 1303 (1998).
- ²⁰ I. F. Herbut, Phys. Rev. B **58**, 971 (1998). The $1+\epsilon$ expansion developed here consists of computing the RG flows in 1-D, and inserting the engineering dimensions to generalize the recursion relations to higher dimensions. However, in the absence of a form for the Hamiltonian for noninteger $d > 1$, there is presently no rigorous support for this approach.
- ²¹ Further neighbor interactions substantially increase the complexity of the phase diagram in the absence of the random site energies, ϵ_i . One can, in principle, generate Mott insulating phases with arbitrary rational densities (“charge density wave” states). The superfluid transitions from these states are surprisingly complex: for a review, see L. Balents, L. Bartosch, A. Burkov, S. Sachdev, and K. Sengupta, Prog. Theor. Phys. Suppl. **160**, 314 (2005). Generically, only the integer fillings are stable against small disorder since the fractional fillings necessarily break the lattice translation symmetry, leading to multiply degenerate ground states related by a discrete translation. It is not hard to see that arbitrarily small random ϵ_i will always generate rare regions where it is energetically favorable to form two such states with a domain wall between. If one allows further neighbor hopping matrix elements, J_{ij} , with various signs, one can also generate *supersolid* phases which break *both* lattice translational symmetry and XY-phase symmetry, i.e., superfluid charge density waves: for some recent work see, e.g., P. Sengupta, L. P. Pryadko, F. Alet, M. Troyer, and G. Schmid, Phys. Rev. Lett. **94**, 207202 (2005); G. G. Batrouni, F. Hbert, and R. T. Scalettar; and references therein.
- ²² See, e.g., A. L. Fetter and J. D. Walecka, *Quantum Theory of Many Particle Systems* (McGraw Hill, 1971), Chaps. 10, 14. For a more modern view, see P. B. Weichman, Phys. Rev. B **38**, 8739 (1988).
- ²³ See, e.g., J. V. Jose, L. P. Kadanoff, S. Kirkpatrick and D. R. Nelson, Phys. Rev. B **16**, 1217 (1977), and references therein.
- ²⁴ This idea has been used to explain the vanishing of the Hall conductivity at magnetic field-tuned superconducting transitions: See M. P. A. Fisher, Physica A **177**, 553 (1991); A. T. Dorsey and M. P. A. Fisher, Phys. Rev. Lett. **68**, 694 (1992).
- ²⁵ In $d = 1$ arbitrarily weak hopping disorder in the spin- $\frac{1}{2}$ XXZ chain with vanishing axial magnetic field²⁶ leads to an insulating phase consisting of bound (ferromagnetic) singlet pairs—a *random singlet glass*: see D. S. Fisher, Phys. Rev. B **50**, 3799 (1994). In the 1D boson problem this means that the superfluid transition takes place at finite $J_{0,c}(\tilde{\mu}_k) > 0$ even at half-integer filling,¹⁸ and Fig. 1(c) must be adjusted accordingly, with a line of random singlet glass (identified by both an infinite superfluid susceptibility,³¹ and an infinite compressibility, $\kappa \rightarrow \infty$ ¹⁸) at $\tilde{\mu} = \tilde{\mu}_k$ on the interval $0 \leq J_0 < J_{0,c}(\tilde{\mu}_k)$.
- ²⁶ In the limit of small J_0/U_0 , only site occupancies of k and $k + 1$ contribute between Mott lobes, and (1.1) or (1.2) may be mapped onto a spin- $\frac{1}{2}$ XXZ model $\mathcal{H}_{\frac{1}{2}} = -\sum_{\langle i,j \rangle} J_{ij} [\hat{\sigma}_i^x \hat{\sigma}_j^x + \hat{\sigma}_i^y \hat{\sigma}_j^y] - h \sum_i \sigma_i^z$, in which $h \propto \mu - (k + \frac{1}{2})U_0$ vanishes at half-filling [see, Ref.⁴⁷, as well as M. E. Fisher, Rep. Prog. Phys. **30**, 615 (1967)]. If $h = 0$, the energetics, for $d > 1$,²⁵ favors spins aligned in the plane. So long as the model is not singular, in the sense that there is finite probability p_0 that a given J_{ij} vanishes, the model will have long range superfluid order, $\psi_0 \equiv [(\hat{\sigma}_i^x + i\hat{\sigma}_i^y)]_{av} \neq 0$. Moreover, in this $J_0/U_0 \rightarrow 0$ limit, J_0 is the only energy scale, and the quantum state must be independent of J_0 , showing that superfluidity survives for arbitrarily small J_0 . If p_0 lies above the bond percolation threshold, the lattice will break up into finite, non-communicating droplets, and bulk superfluidity is suppressed entirely. For nonzero h , roughly speaking, those sites where h/\bar{J}_i lies above some threshold of order unity, where $\bar{J}_i = \frac{1}{2} \sum_j J_{ij}$, will align with h along z (or $-z$, for $h < 0$). For sufficiently large $|h|$, depending on the precise distribution of J_{ij} , the z -aligned spin clusters will percolate, and superfluidity will be destroyed. The resulting state is the spin- $\frac{1}{2}$ analogue of the Bose glass phase, and the remaining isolated planar ordered clusters (those with anomalously small h/\bar{J}_i) are the superfluid droplets of Sec. III. The two Mott phases correspond to $|h|$ sufficiently large that *all* spins are z -aligned (or anti-aligned).
- ²⁷ For a detailed discussion of the onset transition, see, e.g., P. B. Weichman, Phys. Rev. B **38**, 8739 (1988).
- ²⁸ D. S. Fisher and M. P. A. Fisher, Phys. Rev. Lett. **61**, 1847 (1988).
- ²⁹ P. B. Weichman and R. Mukhopadhyay, Phys. Rev. Lett. **98**, 245701 (2007).
- ³⁰ There are, however, also not so obvious fractional time dimension generalizations of (2.1): see Ref. 16.
- ³¹ The superfluid susceptibility, defined by $\chi_s = (\partial\psi_0/\partial h_s)_{h_s=0}$, where h_s is a symmetry breaking field entering via coupling $-h_s \sum_i (\hat{a}_i + \hat{a}_i^\dagger)$ added to (1.1), or $-h_s \sum_i \cos(\hat{\phi}_i)$ added to (1.2), is related to the full space-time pair correlation function via $\chi_s = \int d^d x \int d\tau G(\mathbf{x}, \tau)$. Although $G(\mathbf{x}, \tau)$ decays exponentially in space, with a finite correlation length, its more singular temporal behavior leads to distinct behaviors in the different insulating phases. The stretched exponential decay (3.20) is integrable, so χ_s is finite in the random rod glass (as well as in the Mott phases). However, the power law decay (3.24) in time leads to a logarithmic divergence of χ_s , so that the Bose glass phase is characterized by vanishing superfluid order, but an infinite superfluid susceptibility.⁶
- ³² R. B. Griffiths, Phys. Rev. Lett. **23**, 17 (1969).
- ³³ M. E. Fisher and V. Privman, Phys. Rev. B **32**, 447 (1985).
- ³⁴ The random site energies may be thought of as locally reducing the local chemical potential $\mu - \varepsilon_i = \mu + \Delta - (\Delta + \varepsilon_i)$ from a uniform value $\mu + \Delta$. A free energy convexity argument shows that that such a reduction can only reduce, or at best maintain, the particle density. Since, by assumption, $\mu + \Delta < \mu_+(J_0)$ lies within the Mott phase, the density will remain fixed at the Mott integer value.
- ³⁵ D. S. Fisher and P. C. Hohenberg, Phys. Rev. B **37**, 4936 (1988).
- ³⁶ There are dynamical scaling breakdown issues at the finite T lambda transition [described by the classical Model F equations: P. C. Hohenberg and B. I. Halperin, Rev. Mod. Phys. **49**, 435 (1977)] as well, where the finite κ argument now yields $z = d/2$. However, violations are possible (and believed to occur in $d = 3$) where there exist two different dynamical exponents z_1, z_2 satisfying $z_1 + z_2 = d$. Only the mean $(z_1 + z_2)/2 = d/2$ enters the corresponding hydro-

dynamic correlation function [V. Dohm, Phys. Rev. B **44** 2697 (1991)].

- ³⁷ There are actually two distinct sets of scaling functions and amplitudes in (4.7), one for $\delta > 0$ and one for $\delta < 0$. For notational simplicity we shall not make this distinction explicit since ρ_s (and κ in the random rod problem case) are nonzero only in the superfluid phase.
- ³⁸ No nonuniversal amplitude A is required in this formulation due to quantum hyperuniversality: see K. Kim and P. B. Weichman, Phys. Rev. B **43**, 13583 (1991).
- ³⁹ The definition of the superfluid density (4.8) in terms of finite size scaling of twisted boundary conditions, was first proposed by M. E. Fisher, M. N. Barber and D. Jasnow, Phys. Rev. A **8**, 1111 (1973). Amazingly, the last section of this paper, containing a discussion of how finite size scaling might lead to violations of the Josephson relation, proposes a mechanism very similar to ours: anomalously strong boundary condition dependence of t_θ , the distance from the critical point, on the twist wavevector, k_0 . If $t_\theta - t \sim k_0^2$ they find $\nu = 1 - \alpha$. Here we find an even more anomalous linear dependence of $\delta_\theta - \delta$ on ω_0 , leading to $\nu_\tau = -\alpha$. We are unaware of any classical model where the original proposed violation occurs, but a candidate would presumably be a transition between two different phases with finite superfluid density.
- ⁴⁰ A famous theorem [J. T. Chayes, L. Chayes, D. S. Fisher and T. Spencer, Phys. Rev. Lett. **57**, 2999 (1986); Commun. Math. Phys. **120** 501 (1989)] requires that $\nu_{fs} > 2/d$, where ν_{fs} is a correlation exponent defined through finite size scaling, and it is commonly assumed that under most conditions that $\nu = \nu_{fs}$. However, it has been argued more recently [F. Pazmandi, R. Scalettar, and G. T. Zimanyi, Phys. Rev. Lett. **79**, 5130 (1997)] that ν_{fs} generally places no constraints on the value of ν . Nevertheless, analytic results in $d = 1$ (Ref. 6) and quantum Monte Carlo data in

$d = 2$ (Ref. 11) are consistent with this inequality.

- ⁴¹ Irrelevance of g_0 means that it drops out completely sufficiently close to the dirty boson critical point, ruling out in yet a different way, any scaling (4.7) of shifts $g_0 \rightarrow g_0 - i\omega_0$ with ξ_τ .
- ⁴² T. Giamarchi and H. J. Schulz, Europhys. Lett. **3**, 1287 (1987); Phys. Rev. B **37**, 325 (1988).
- ⁴³ In this interface picture, the singlet glass phase at half filling²⁵ corresponds to sufficiently small $K_0 = [K_I]_{av}$ in which the hierarchy of different values of K_I (organized from smallest to largest) generates an unusual hierarchy of long-range spatial correlations where all sites divide up into (possibly well separated) pairs. Although the individual tilts $\partial_I S_{(I,T)}$, $\partial_{I'} S_{(I',T)}$ at two such sites I, I' fluctuate strongly, as a function of T , between 0 and 1, the sum $\partial_I S_{(I,T)} + \partial_{I'} S_{(I',T)}$ remains close to unity—the path integral analogue of the quantum state $\frac{1}{\sqrt{2}}(|0, 1\rangle + |1, 0\rangle)$.¹⁸ This pairing reduces the interface tilt fluctuations at large distances, reducing the roughness below that of the superfluid phase. Since our main concern in this paper is with the neighborhood of integer filling, we shall not pursue the physics of this singlet glass any further here.
- ⁴⁴ I. S. Gradshteyn and I. M. Ryzhik, *Table of Integrals, Series and Products*, (Academic Press, New York, 1980).
- ⁴⁵ See, e.g., A. Aharony, Phys. Rev. B **12**, 1038 (1975); see also in “Phase Transitions and Critical Phenomena,” edited by C. Domb and M. S. Green (Academic, London, 1976), Vol. 6, Chap. 6.
- ⁴⁶ See, e.g., K. G. Wilson and J. Kogut, Physics Reports **12C**, 75 (1974).
- ⁴⁷ See, e.g., M. Suzuki, Prog. Theor. Phys. **56**, 1454 (1976).
- ⁴⁸ See, e.g., E. S. Sørensen, M. Wallin, S. M. Girvin and A. P. Young, Phys. Rev. Lett. **69**, 828 (1992).