

The Unruh effect and its applications

Luís C. B. Crispino*

Faculdade de Física, Universidade Federal do Pará, Campus Universitário do Guamá, 66075-900, Belém, Pará, Brazil

Atsushi Higuchi†

Department of Mathematics, University of York, Heslington, York YO10 5DD, United Kingdom

George E. A. Matsas‡

Instituto de Física Teórica, Universidade Estadual Paulista, Rua Pamplona 145, 01405-900, São Paulo, SP, Brazil

(Dated: February 2, 2008)

It has been thirty years since the discovery of the Unruh effect. It has played a crucial role in our understanding that the particle content of a field theory is observer dependent. This effect is important in its own right and as a way to understand the phenomenon of particle emission from black holes and cosmological horizons. Here, we review the Unruh effect with particular emphasis to its applications. We also comment on a number of recent developments and discuss some controversies. Effort is also made to clarify what seems to be common misconceptions.

PACS numbers: 03.70.+k, 04.70.Dy, 04.62.+v

Contents

I. Introduction	1	1. Inertial observer perspective	29
II. The Unruh effect	3	2. Rindler observer perspective	30
A. Free scalar field in curved spacetime	3	C. Bremsstrahlung	33
B. Rindler wedges	6	1. Inertial observer perspective	33
C. Two dimensional example	7	2. Rindler observer perspective	34
D. Massive scalar field in Rindler wedges	9	IV. Experimental proposals	37
E. Bogolubov coefficients and the Unruh effect	11	A. Electrons in particle accelerators	37
F. Completeness of the Rindler modes in Minkowski spacetime	13	B. Electrons in Penning traps	40
G. Unruh effect and quantum field theory in the expanding degenerate Kasner universe	14	C. Atoms in microwave cavities	40
H. Unruh effect and classical field theory	15	D. Backreaction radiation in ultraintense lasers and related topics	41
I. Unruh effect for interacting theories and in other spacetimes	16	E. Thermal spectra in hadronic collisions	42
III. Applications	19	F. Unruh and Moore (dynamical Casimir) effects	42
A. Unruh-DeWitt detectors	19	V. Recent developments	43
1. Uniformly accelerated detectors in Minkowski vacuum: Inertial observer perspective	19	A. Entanglement and Rindler observers	43
2. Uniformly accelerated detectors in Minkowski vacuum: Rindler observer perspective	21	B. Decoherence of accelerated detectors	44
3. Rindler particles with frequency $\omega < m$	22	C. Generalized second law of thermodynamics and the “self-accelerating box paradox”	44
4. Static detectors in a thermal bath of Minkowski particles	24	D. Entropy and Rindler observers	45
5. About the discussion whether or not uniformly accelerated sources radiate	24	E. Einstein equations as an equation of state?	45
6. Other results concerning the Unruh-DeWitt detector	25	F. Miscellaneous topics	45
7. Circularly moving detectors with constant velocity in the Minkowski vacuum	26	VI. Concluding remarks	46
B. Weak decay of non-inertial protons	28	Acknowledgments	46
		A. Derivation of the positive-frequency solutions in the right Rindler wedge	46
		References	47

*Electronic address: crispino@ufpa.br

†Electronic address: ah28@york.ac.uk

‡Electronic address: matsas@ift.unesp.br

I. INTRODUCTION

It has been thirty years since the discovery of the *Unruh effect* (Unruh, 1976) which can be also found under the name of *Davies-Unruh*, *Fulling-Davies-Unruh*, and

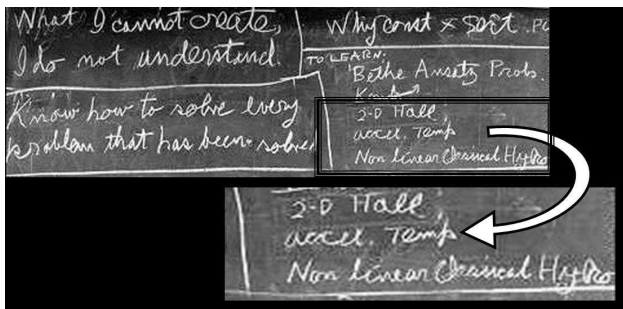

FIG. 1 Part of Feynman’s blackboard at California Institute of Technology at the time of his death in 1988. At the right-hand side one can find “accel. temp.” as one of the issues “to learn”.

Unruh-Davies-DeWitt-Fulling effect. This is a conceptually subtle quantum field theory result, which has played a crucial role in our understanding that the particle content of a field theory is observer dependent in a sense to be made precise later (Fulling, 1973) [see also Unruh (1977)]. This effect is important in its own right and as a tool to investigate other phenomena such as the thermal emission of particles from black holes (Hawking, 1974, 1975) and cosmological horizons (Gibbons and Hawking, 1977). It is interesting that the Unruh effect was on Feynman’s list of things to learn in his later years (see Fig. 1). In short, the Unruh effect expresses the fact that *uniformly accelerated observers* in Minkowski spacetime, i.e. linearly accelerated observers with constant proper acceleration (also called *Rindler observers*), associate a thermal bath of *Rindler particles* (also called *Fulling-Rindler particles*) to the *no-particle state* of inertial observers (also called *Minkowski vacuum*). Rindler particles are associated with positive-energy modes as defined by *Rindler observers* in contrast to Minkowski particles, which are associated with positive-energy modes as defined by inertial observers. Unruh (1976) also provides an explanation for the conclusion obtained by Davies (1975) that an observer undergoing uniform acceleration $a = \text{const}$ in Minkowski spacetime would see a fixed inertial mirror to emit thermal radiation with temperature $a\hbar/(2\pi kc)$, and the reason why this is not in contradiction with energy conservation. Although there are some accounts in the literature discussing the Unruh effect,¹ we believe that this review will be a useful contribution for the reasons we list below.

Firstly, some authors have recently questioned the existence of the Unruh effect (Narozhny *et al.*, 2002, 2004). We believe there are two main sources of confusion, which need to be clarified in order to address these objections. One is that it has not been made clear that the heuristic

expression of the Minkowski vacuum as a superposition of Rindler states makes sense outside as well as inside the two Rindler wedges. Although this point is not central to the Unruh effect (Fulling and Unruh, 2004), it will be useful to point out that this heuristic expression in fact makes sense in the whole of Minkowski spacetime. Another common source of confusion is that the Unruh effect is sometimes tacitly assumed to be the equivalence of the *excitation rate* of a detector when it is (i) uniformly accelerated in the Minkowski vacuum and (ii) static in a thermal bath of Minkowski particles (rather than of Rindler particles). There is no such equivalence in general, although this showed up by coincidence in some early examples in the literature (see discussion in Sec. III.A.4). We emphasize that this point does not contradict the fact that the *detailed balance relation* satisfied by static detectors in a thermal bath of Minkowski particles is in general also valid for uniformly accelerated ones in the Minkowski vacuum (Unruh, 1976). The identification of the Unruh effect with the behavior of accelerated detectors seems to have generated sometimes unnecessary confusion. It is worthwhile to emphasize that the Unruh effect is a quantum field theory result, which does not depend on the introduction of the detector concept. In this sense, it is better to see the detailed balance relation satisfied by uniformly accelerated detectors as a *natural consequence or application* rather than a *definition* of the Unruh effect. In order to exemplify the meaning of the Unruh effect as the equivalence between the Minkowski vacuum and a thermal bath of Rindler particles, we collect and discuss a number of illustrative physical applications.

The Unruh effect has also been connected with the long-standing discussion about whether or not sources² *uniformly accelerated* from the null past infinity to the null future infinity radiate with respect to inertial observers. Although some aspects of this issue are surely worthwhile to be investigated and the corresponding discussion can be enriched by considering the Unruh effect, it is useful to keep in mind that the Unruh effect does not depend on a consensus on this issue which seems to be mostly semantic [see Fulling (2005) for a brief discussion on it and related references]. We comment briefly on this issue in Sec. III.A.5.

Secondly, there have been several recent proposals to detect the Unruh effect in the laboratory and it is useful to review and assess them. We shall emphasize that, although it is certainly fine to interpret laboratory observables from the point of view of uniformly accelerated observers, the Unruh effect itself does not need experimental confirmation any more than free quantum field theory does.³

¹ See, e.g., Birrell and Davies (1982); Fulling and Ruijsenaars (1987); Ginzburg and Frolov (1987); Sciama *et al.* (1981); Takagi (1986); Wald (1994).

² Throughout this review we will use the word “sources” to mean *scalar sources, particle detectors or electric charges* depending on the context where it appears.

³ This statement should be understood in the sense that we are dealing with mathematical constructions that stand on their

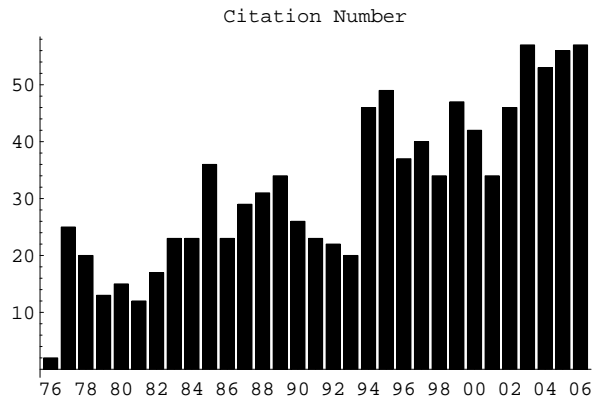

FIG. 2 Histogram depicting the number of citations of Unruh (1976) over the years.

Finally, there has been an increasing interest in the Unruh effect (see Fig. 2) because of its connection with a number of contemporary research topics.⁴ The thermodynamics of black holes and the corresponding information puzzle is one of them. It will be beneficial, therefore, to review the literature on the generalized second law,⁵ quantum information,⁶ and related topics with the Unruh effect as the central theme.

The review is organized as follows. In Section II we review the derivation of the Unruh effect, emphasizing the fact that the quantum field expanded by the Rindler modes can be used in the whole of Minkowski spacetime, partly to respond to the recent criticisms mentioned above. We also touch upon more rigorous approaches such as the Bisognano-Wichmann theorem in algebraic field theory and general theorems on field theories in spacetimes with bifurcate Killing horizons. A brief discussion of the Unruh effect in interacting field theories is also included. In Section III we present in detail some typical examples which illustrate the physical content of the Unruh effect. We start by reviewing the behavior of accelerated detectors which can be also used to describe the physics of accelerated atomic systems. Then, we analyze the weak decay of accelerated protons and the bremsstrahlung from accelerated charged particles. Section IV is dedicated to the discussion of some experimental proposals for laboratory signatures of the Unruh effect in particle accelerators, in microwave cavities, in the presence of ultra-intense lasers,

own. The assertions follow from the definitions and so do not need to be experimentally verified. The fact that “Rindler and Minkowski perspectives” give consistent physical predictions is a consequence of the validity of these constructions.

⁴ The data in Fig. 2 should not be used to infer any relative or absolute measure of the importance of the Unruh effect. It has been introduced only as an illustration on the increasing interest in this issue.

⁵ See, e.g., Unruh and Wald (1982, 1983); Wald (2001).

⁶ See, e.g., Bousso (2002); Peres and Terno (2004).

in the vicinity of accelerated boundaries, and in hadronic processes. In Section V we comment on some recent developments concerning the Unruh effect, which include the possible reduction in fidelity of teleportation when one party is accelerated, the decoherence of accelerated systems and the possible observer-dependence of the entropy concept. We conclude the review with a summary in Section VI. Throughout this review we use natural units $\hbar = c = G = k = 1$ and signature $(+ - - -)$ unless stated otherwise.

It would be impossible to give a completely balanced account of so much work in the literature concerning the Unruh effect. This review heavily reflects our own experience with the Unruh effect, and we fear that we may have overlooked some important related papers. However, we hope at least to have included a sufficient number of papers to allow the readers to trace back to most of the important related results.

II. THE UNRUH EFFECT

A. Free scalar field in curved spacetime

Even though the Unruh effect is about quantum field theory (QFT) in flat spacetime, it is useful to review briefly the general framework of non-interacting QFT in curved spacetime. We treat only the simplest theory, i.e. the theory of a Hermitian scalar field satisfying the Klein-Gordon equation. We present it in a schematic and heuristic way as is done in Birrell and Davies (1982). A mathematically more satisfactory treatment can be found, e.g., in Wald (1994).

Let us first remind the reader of some important features of QFT in Minkowski spacetime. In this spacetime the scalar field is expanded in terms of the energy-momentum eigenfunctions, and the vacuum state is defined as the state annihilated by all *annihilation operators*, i.e. the coefficient operators of the *positive-frequency* eigenfunctions defined to be those proportional to $e^{-ik_0 t}$ with $k_0 > 0$, where t is the time parameter. The coefficient operators of the *negative-frequency* modes proportional to $e^{ik_0 t}$ are the *creation operators*, and the states obtained by applying creation operators on the vacuum state are identified with states containing particles. Notice that the time-translation symmetry, which enables one to define positive- and negative-frequency solutions to the Klein-Gordon equation, plays a crucial role in the definition of the vacuum state and the Fock space of particles. Therefore, in a general curved spacetime with no isometries, there is no reason to expect the existence of a preferred vacuum state or a useful concept of particles.

For simplicity we specialize to $(D + 1)$ -dimensional spacetimes whose metric takes the form

$$ds^2 = [N(x)]^2 dt^2 - G_{ab}(x) dx^a dx^b, \quad (2.1)$$

where $x = (t, \mathbf{x})$. The coefficient $N(x)$ is called the *lapse function* (Arnowitt *et al.*, 1962) and G_{ab} is the metric on

the spacelike hypersurface of constant t . (All spacetimes we consider in this review have a metric of this form.) In this spacetime the minimally-coupled⁷ massive Klein-Gordon equation $(\nabla_\mu \nabla^\mu + m^2)\phi = 0$, which arises as the Euler-Lagrange equation from the Lagrangian density,

$$\mathcal{L} = \sqrt{-g}(\nabla_\mu \phi \nabla^\mu \phi - m^2 \phi^2)/2, \quad (2.2)$$

takes the form

$$\partial_t(N^{-1}\sqrt{G}\partial_t\phi) - \partial_a(N\sqrt{G}G^{ab}\partial_b\phi) + N\sqrt{G}m^2\phi = 0, \quad (2.3)$$

where the space indices a and b run from 1 to D .

Given two complex solutions $f_A(x)$ and $f_B(x)$ to the Klein-Gordon equation, we define the Klein-Gordon current

$$J_{(f_A, f_B)}^\mu(x) \equiv f_A^*(x)\nabla^\mu f_B(x) - f_B(x)\nabla^\mu f_A^*(x). \quad (2.4)$$

Then, one can readily show that $\nabla_\mu J_{(f_A, f_B)}^\mu(x) = 0$. Hence, the quantity

$$(f_A, f_B)_{\text{KG}} \equiv i \int d^D \mathbf{x} \sqrt{G} n_\mu J_{(f_A, f_B)}^\mu \quad (2.5)$$

is independent of t , where n_μ is the future-directed unit vector normal to the hypersurface Σ of constant t . (The integral here and throughout this subsection (Sec. II.A) is over the hypersurface Σ .) We call this quantity the Klein-Gordon inner product of f_A and f_B . For the metric (2.1) it takes the following form:

$$(f_A, f_B)_{\text{KG}} = i \int d^D \mathbf{x} \sqrt{G} N^{-1} (f_A^* \partial_t f_B - f_B \partial_t f_A^*). \quad (2.6)$$

The conjugate momentum density $\pi(x)$ is defined as $\pi \equiv \partial \mathcal{L} / \partial \dot{\phi}$, where $\dot{\phi} \equiv \partial_t \phi$. For the metric (2.1) one finds

$$\pi(x) = N^{-1} \sqrt{G} \dot{\phi}(x). \quad (2.7)$$

Note that, if we let $p_A(x)$ and $p_B(x)$ be the conjugate momentum density for the solutions $f_A(x)$ and $f_B(x)$, respectively, then the Klein-Gordon inner product can be expressed as

$$(f_A, f_B)_{\text{KG}} = i \int d^D \mathbf{x} [f_A^*(x) p_B(x) - p_A^*(x) f_B(x)]. \quad (2.8)$$

We assume that the Klein-Gordon equation determines the classical field $\phi(x)$ uniquely given a (well-behaved) initial data (ϕ, π) on a hypersurface of constant t . This property is known to hold if the spacetime is globally

hyperbolic with $t = \text{const}$ hypersurfaces as the spacelike Cauchy surfaces.⁸

The quantization of the field ϕ proceeds as follows. We denote the field operators corresponding to ϕ and π by $\hat{\phi}$ and $\hat{\pi}$, respectively. One imposes the following equal-time canonical commutation relations:

$$[\hat{\phi}(t, \mathbf{x}), \hat{\phi}(t, \mathbf{x}')] = [\hat{\pi}(t, \mathbf{x}), \hat{\pi}(t, \mathbf{x}')] = 0, \quad (2.9)$$

$$[\hat{\phi}(t, \mathbf{x}), \hat{\pi}(t, \mathbf{x}')] = i\delta^D(\mathbf{x}, \mathbf{x}'), \quad (2.10)$$

where the delta-function $\delta^D(\mathbf{x}, \mathbf{x}')$ is defined by

$$\int d^D \mathbf{x} f(\mathbf{x}) \delta^D(\mathbf{x}, \mathbf{x}') = f(\mathbf{x}'). \quad (2.11)$$

Note here that there is no density factor \sqrt{G} on the left-hand side. For arbitrary complex-valued solutions $f_A(x)$ and $f_B(x)$ to the Klein-Gordon equation (2.3) (with a suitable integrability conditions) one finds

$$[(f_A, \hat{\phi})_{\text{KG}}, (\hat{\phi}, f_B)_{\text{KG}}] = (f_A, f_B)_{\text{KG}}, \quad (2.12)$$

from the equal-time canonical commutation relations (2.9) and (2.10) by using Eq. (2.7).

Now, assume that there is a complete set of solutions, $\{f_i, f_i^*\}$, to the Klein-Gordon equation (2.3) satisfying

$$(f_i, f_j)_{\text{KG}} = -(f_i^*, f_j^*)_{\text{KG}} = \delta_{ij}, \quad (2.13)$$

$$(f_i^*, f_j)_{\text{KG}} = (f_i, f_j^*)_{\text{KG}} = 0. \quad (2.14)$$

We assume here that the indices labeling the solutions are discrete for simplicity of the discussion but its extension to the cases with continuous labels is straightforward. In Minkowski spacetime one chooses the positive-frequency modes as f_i 's and, consequently, the negative-frequency modes as f_i^* 's. In a general globally-hyperbolic curved spacetime without isometries, there are infinitely many ways of choosing the functions f_i 's.

Expanding the quantum field $\hat{\phi}(x)$ as

$$\phi(x) = \sum_i [\hat{a}_i f_i(x) + \hat{a}_i^\dagger f_i^*(x)], \quad (2.15)$$

one finds

$$\hat{a}_i = (f_i, \phi)_{\text{KG}}, \quad \hat{a}_i^\dagger = (\phi, f_i)_{\text{KG}}. \quad (2.16)$$

One can readily show, by using Eqs. (2.12), (2.13) and (2.14), that

$$[\hat{a}_i, \hat{a}_j] = [\hat{a}_i^\dagger, \hat{a}_j^\dagger] = 0, \quad [\hat{a}_i, \hat{a}_j^\dagger] = \delta_{ij}. \quad (2.17)$$

⁷ It is customary to allow the field to couple to the scalar curvature. Thus, the general Klein-Gordon equation takes the form $(\nabla_\mu \nabla^\mu + \xi R + m^2)\phi = 0$. The minimally-coupled scalar field has $\xi = 0$ by definition.

⁸ A *Cauchy surface* is a closed hypersurface which is intersected by each inextendible timelike curve once and only once. A spacetime is said to be *globally hyperbolic* if it possesses a Cauchy surface. See, e.g., Wald (1984).

Conversely, if these commutation relations are satisfied, then the equal-time canonical commutation relations (2.9) and (2.10) follow. To prove this, one first shows that any two complex-valued solutions $f_A(x)$ and $f_B(x)$ to the Klein-Gordon equation (2.3) satisfy Eq. (2.12) by expanding them in terms of $f_i(x)$ and $f_i^*(x)$ and using the commutators (2.17). Then, for example, by letting $f_A(t, \mathbf{x}) = f_B^*(t, \mathbf{x})$ and $p_A(t, \mathbf{x}) = -p_B^*(t, \mathbf{x})$, at a given time t and evaluating the Klein-Gordon inner products in Eq. (2.12) at time t , one obtains

$$\begin{aligned} & \int d^D \mathbf{x} d^D \mathbf{x}' f_B(t, \mathbf{x}) p_B(t, \mathbf{x}') \left[\hat{\phi}(t, \mathbf{x}), \hat{\pi}(t, \mathbf{x}') \right] \\ &= i \int d^D \mathbf{x} f_B(t, \mathbf{x}) p_B(t, \mathbf{x}). \end{aligned} \quad (2.18)$$

Since $f_B(t, \mathbf{x})$ and $p_B(t, \mathbf{x})$ are arbitrary, one can conclude that Eq. (2.10) holds at time t . Eq. (2.9) can be derived in a similar manner.

The operators \hat{a}_i and \hat{a}_i^\dagger are called the *annihilation and creation operators*, respectively. The vacuum state $|0\rangle$ is defined by requiring $\hat{a}_i|0\rangle = 0$. The Fock space of states is obtained by applying the creation operators \hat{a}_i^\dagger on the vacuum state $|0\rangle$. We call the operator $\hat{N}_i = \hat{a}_i^\dagger \hat{a}_i$ (with no summation on the right-hand side) the *number operator* in the mode ‘ i ’. However, note that, since it is not always easy to construct a (theoretical) detector model which is excited when the eigenvalue of \hat{N}_i changes from 1 to 0, say, the operator \hat{N}_i does not necessarily lead to a useful particle concept.

Since the coefficient operators \hat{a}_i of the functions f_i annihilate the vacuum state $|0\rangle$, the choice of the functions f_i satisfying Eqs. (2.13) and (2.14) determines the vacuum state. For this reason we call the functions f_i the *positive-frequency modes* and their complex conjugates f_i^* the *negative-frequency modes* in analogy with the case in Minkowski spacetime. Thus, the choice of the positive-frequency modes determines the vacuum state. In a general curved spacetime there is no privileged choice of the positive-frequency modes, and consequently, there is no privileged vacuum state unlike in Minkowski spacetime, as we mentioned before.

Now, suppose that two complete sets of positive-frequency modes $\{f_i^{(1)}\}$ and $\{f_I^{(2)}\}$ satisfy the Klein-Gordon inner-product relations (2.13) and (2.14), where the lower-case letters i, j are replaced by the upper-case equivalents I, J for $f_I^{(2)}$. Since both sets are complete, the modes $f_I^{(2)}$ can be expressed as linear combinations of $f_i^{(1)}$ and $f_i^{(1)*}$ and vice versa. Thus,

$$f_I^{(2)} = \sum_i \left[\alpha_{Ii} f_i^{(1)} + \beta_{Ii} f_i^{(1)*} \right], \quad (2.19)$$

$$f_I^{(2)*} = \sum_i \left[\alpha_{Ii}^* f_i^{(1)*} + \beta_{Ii}^* f_i^{(1)} \right]. \quad (2.20)$$

By noting that

$$\alpha_{Ii} = (f_i^{(1)}, f_I^{(2)})_{\text{KG}} = (f_I^{(2)}, f_i^{(1)})_{\text{KG}}^*, \quad (2.21)$$

$$\beta_{Ii} = -(f_i^{(1)*}, f_I^{(2)})_{\text{KG}} = (f_I^{(2)*}, f_i^{(1)})_{\text{KG}}, \quad (2.22)$$

one can express $f_i^{(1)}$ as a linear combination of $f_I^{(2)}$ and $f_I^{(2)*}$ as

$$f_i^{(1)} = \sum_I \left[\alpha_{Ii}^* f_I^{(2)} - \beta_{Ii} f_I^{(2)*} \right], \quad (2.23)$$

$$f_i^{(1)*} = \sum_I \left[\alpha_{Ii} f_I^{(2)*} - \beta_{Ii}^* f_I^{(2)} \right]. \quad (2.24)$$

The scalar field $\hat{\phi}(x)$ can be expanded using either of the two sets $\{f_i^{(1)}\}$ and $\{f_I^{(2)}\}$:

$$\begin{aligned} \hat{\phi}(x) &= \sum_i \left[\hat{a}_i^{(1)} f_i^{(1)} + \hat{a}_i^{(1)\dagger} f_i^{(1)*} \right] \\ &= \sum_I \left[\hat{a}_I^{(2)} f_I^{(2)} + \hat{a}_I^{(2)\dagger} f_I^{(2)*} \right]. \end{aligned} \quad (2.25)$$

Using the expansion given by Eqs. (2.19) and (2.20), and comparing the coefficients of $f_i^{(1)}$ and $f_i^{(1)*}$, we find

$$\hat{a}_i^{(1)} = \sum_I (\alpha_{Ii} \hat{a}_I^{(2)} + \beta_{Ii}^* \hat{a}_I^{(2)\dagger}), \quad (2.26)$$

and similarly by using Eqs. (2.23) and (2.24) we have

$$\hat{a}_I^{(2)} = \sum_i (\alpha_{Ii}^* \hat{a}_i^{(1)} - \beta_{Ii}^* \hat{a}_i^{(1)\dagger}). \quad (2.27)$$

This transformation, which mixes annihilation and creation operators, is called a *Bogolubov transformation*, and the coefficients α_{Ii} and β_{Ii} are called the *Bogolubov coefficients*. The Bogolubov transformation found its first major application to QFT in curved spacetime in the derivation of particle creation in expanding universes (Parker, 1968; Sexl and Urbantke, 1969).

The vacuum states $|0_{(1)}\rangle$ and $|0_{(2)}\rangle$ corresponding to the two sets of positive-frequency modes $\{f_i^{(1)}\}$ and $\{f_I^{(2)}\}$, respectively, are distinct if β_{Ii} do not vanish for all I and i . For example, the expectation value of the number operator $\hat{N}_i^{(1)} = \hat{a}_i^{(1)\dagger} \hat{a}_i^{(1)}$ for the state $|0_{(1)}\rangle$ is zero by definition but for the state $|0_{(2)}\rangle$ it can be calculated by using Eq. (2.26) as

$$\langle 0_{(2)} | N_i^{(1)} | 0_{(2)} \rangle = \sum_I |\beta_{Ii}|^2. \quad (2.28)$$

We similarly find for the number operator $N_I^{(2)} = \hat{a}_I^{(2)\dagger} \hat{a}_I^{(2)}$,

$$\langle 0_{(1)} | N_I^{(2)} | 0_{(1)} \rangle = \sum_i |\beta_{Ii}|^2. \quad (2.29)$$

Although the choice of the vacuum state is not unique in general, *there is a natural vacuum state if the spacetime is static*, i.e. if the spacetime metric is of the form (2.1) with the lapse function $N(x)$ and the metric G_{ab} being independent of t .⁹ In such a case the equation for determining the mode functions becomes

$$\partial_t^2 f_i = NG^{-1/2} \partial_a (NG^{1/2} G^{ab} \partial_b f_i) - N^2 m^2 f_i. \quad (2.30)$$

Then, it is natural to let the positive-frequency solutions f_i have a t -dependence of the form $e^{-i\omega_i t}$, where ω_i are positive constants interpreted as the energy of the particle with respect to the (future-directed) Killing vector¹⁰ $\partial/\partial t$. If the spacetime is globally hyperbolic and static, then this choice of positive-frequency modes leads to a well-defined and natural vacuum state that preserves the time-translation symmetry. We call this state the *static vacuum*.

Minkowski spacetime has global timelike Killing vector fields, which generate time translations in various inertial frames. The sets of positive-frequency modes corresponding to these Killing vectors are the same and are the usual positive-frequency modes proportional to $e^{-ik_0 t}$ with $k_0 > 0$, where t is the time parameter with respect to one of the inertial frames. Thus, all these Killing vector fields define the same vacuum state.¹¹

Now, in the region defined by $|t| < z$ in Minkowski spacetime (here, z is one of the space coordinates), the boost Killing vector $z(\partial/\partial t) + t(\partial/\partial z)$, i.e. the vector with t - and z -components being z and t , respectively, is timelike and future-directed. Hence, this region, called the *right Rindler wedge*, is a static spacetime with this Killing vector playing the role of time translation. Thus, one can define the corresponding static vacuum state. As was observed by Fulling (1973), this vacuum state is not the same as the state obtained by restricting the usual Minkowski vacuum to this region. This observation is crucial in understanding the Unruh effect, as we shall explain in the next subsections.

B. Rindler wedges

As we have seen in the previous subsection, one has a natural static vacuum state in a static globally hyperbolic spacetime. Minkowski spacetime with the metric

$$ds^2 = dt^2 - dx^2 - dy^2 - dz^2 \quad (2.31)$$

⁹ In fact, if a globally hyperbolic spacetime is stationary, i.e. if the metric is t -independent with $(\partial/\partial t)^\mu$ being everywhere timelike but with the cross term g_{ti} , $i \neq t$, not necessarily vanishing, one has a natural vacuum state in this spacetime under certain conditions (Ashtekar and Magnon, 1975; Kay, 1978).

¹⁰ A Killing vector K^μ is a vector satisfying $\nabla_\mu K_\nu + \nabla_\nu K_\mu = K^\alpha \partial_\alpha g_{\mu\nu} + g_{\alpha\nu} \partial_\mu K^\alpha + g_{\mu\alpha} \partial_\nu K^\alpha = 0$. In a coordinate system such that $K^\mu = (\partial/\partial \theta)^\mu$, one has $\partial g_{\mu\nu}/\partial \theta = 0$. See, e.g., Wald (1984).

¹¹ It has been shown by Chmielowski (1994) that two commuting global timelike Killing vector fields define the same vacuum state.

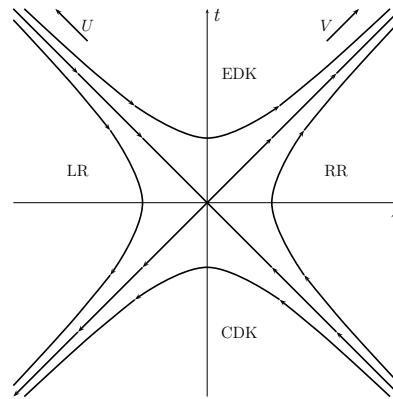

FIG. 3 The regions with $|t| < z$, $|t| < -z$, $t > |z|$ and $t < -|z|$, denoted RR, LR, EDK and CDK, respectively, are the left Rindler wedge, right Rindler wedge, expanding degenerate Kasner universe and contracting degenerate Kasner universe, respectively. The curves with arrows are integral curves of the boost Killing vector $z(\partial/\partial t) + t(\partial/\partial z)$. The direction of increasing $U = t - z$ and that of increasing $V = t + z$ are also indicated.

is of course a static globally hyperbolic spacetime. As mentioned above, the part of this spacetime defined by $|t| < z$, called the *right Rindler wedge*, is also a static globally hyperbolic spacetime. The region with the condition $|t| < -z$ is called the *left Rindler wedge*, and is also a static globally hyperbolic spacetime. The region with $t > |z|$, also a globally hyperbolic spacetime though not a static one, is called the *expanding degenerate Kasner universe* and the globally hyperbolic spacetime with the condition $t < -|z|$ is called the *contracting degenerate Kasner universe*. These regions are shown in Fig. 3.

Minkowski spacetime is invariant under the boost

$$t \mapsto t \cosh \beta + z \sinh \beta, \quad (2.32)$$

$$z \mapsto t \sinh \beta + z \cosh \beta, \quad (2.33)$$

where β is the boost parameter. These transformations are generated by the Killing vector $z(\partial/\partial t) + t(\partial/\partial z)$. The boost invariance of Minkowski spacetime motivates the following coordinate transformation:

$$t = \rho \sinh \eta, \quad z = \rho \cosh \eta, \quad (2.34)$$

where ρ and η takes any real value. Then, the Killing vector is $\partial/\partial \eta$, and the metric takes the form

$$ds^2 = \rho^2 d\eta^2 - d\rho^2 - dx^2 - dy^2. \quad (2.35)$$

This metric is independent of η as expected. The world lines with fixed values of ρ , x , y are the trajectories of the boost transformation given by Eqs. (2.32) and (2.33). Each world line has a constant proper acceleration given by $\rho^{-1} = \text{const}$.

The coordinates (η, ρ, x, y) cover only the regions with $z^2 > t^2$, i.e. the left and right Rindler wedges, as can readily be seen from Eq. (2.34). To discuss QFT in the

right Rindler wedge, it is convenient to make a further coordinate transformation $\rho = a^{-1}e^{a\xi}$, $\eta = a\tau$, i.e.

$$t = a^{-1}e^{a\xi} \sinh a\tau, \quad z = a^{-1}e^{a\xi} \cosh a\tau, \quad (2.36)$$

where a is a positive constant (Rindler, 1966). Then, the metric takes the form

$$ds^2 = e^{2a\xi}(d\tau^2 - d\xi^2) - dx^2 - dy^2. \quad (2.37)$$

This coordinate system will be useful because the world line with $\xi = 0$ has a constant acceleration of a . The coordinates $(\bar{\tau}, \bar{\xi})$ for the left Rindler wedge are given by

$$t = a^{-1}e^{a\bar{\xi}} \sinh a\bar{\tau}, \quad z = -a^{-1}e^{a\bar{\xi}} \cosh a\bar{\tau}. \quad (2.38)$$

The Killing vector $z(\partial/\partial t) + t(\partial/\partial z)$ is timelike in the two Rindler wedges and spacelike in the degenerate Kasner universes. It becomes null on the hypersurfaces $t = \pm z$ dividing Minkowski spacetime into the four regions. These hypersurfaces are examples of *Killing horizons*, which are defined as null hypersurfaces to which the Killing field is normal (Wald, 1994).

Since the right (or left) Rindler wedge is a static spacetime in its own right, it has a natural static vacuum state as we noted before. *The Unruh effect is defined in this review as the fact that the usual vacuum state for QFT in Minkowski spacetime restricted to the right Rindler wedge is a thermal state with τ playing the role of time, and similarly for the left Rindler wedge.* The correlation between the right and left Rindler wedges in the usual Minkowski vacuum state plays an important role in the Unruh effect.

C. Two dimensional example

The two dimensional massless scalar field in Minkowski spacetime is problematic because of infrared divergences (Coleman, 1973). Nevertheless, this theory is a very good model for explaining the Unruh effect, and it is not necessary to deal with the infrared divergences for this purpose. It also turns out that the Unruh effect in scalar field theory in higher dimensions can be derived in essentially the same manner as in this model.

The massless scalar field in two dimensions, $\hat{\Phi}(t, z)$, satisfies

$$(\partial^2/\partial t^2 - \partial^2/\partial z^2)\hat{\Phi} = 0. \quad (2.39)$$

This field can be expanded as

$$\hat{\Phi}(t, z) = \int_0^\infty \frac{dk}{\sqrt{4\pi k}} \left(\hat{b}_{-k} e^{-ik(t-z)} + \hat{b}_{+k} e^{-ik(t+z)} + \hat{b}_{-k}^\dagger e^{ik(t-z)} + \hat{b}_{+k}^\dagger e^{ik(t+z)} \right). \quad (2.40)$$

The annihilation and creation operators satisfy

$$[\hat{b}_{\pm k}, \hat{b}_{\pm k'}^\dagger] = \delta(k - k') \quad (2.41)$$

with all other commutators vanishing. By using the definitions

$$U = t - z, \quad V = t + z, \quad (2.42)$$

we can write

$$\hat{\Phi}(t, z) = \hat{\Phi}_-(U) + \hat{\Phi}_+(V), \quad (2.43)$$

where

$$\hat{\Phi}_+(V) = \int_0^\infty dk \left[\hat{b}_{+k} f_k(V) + \hat{b}_{+k}^\dagger f_k^*(V) \right] \quad (2.44)$$

with

$$f_k(V) = (4\pi k)^{-1/2} e^{-ikV}, \quad (2.45)$$

and similarly for $\hat{\Phi}_-(U)$. Since the left and right-moving sectors of the field, $\hat{\Phi}_+(V)$ and $\hat{\Phi}_-(U)$, do not interact with one another, we discuss only the left-moving sector $\hat{\Phi}_+(V)$. (Thus, we will discuss the Unruh effect for the theory consisting only of the left-moving sector.) The Minkowski vacuum state $|0_M\rangle$ is defined by $\hat{b}_{+k}|0_M\rangle = 0$ for all k .

Using the metric in the right Rindler wedge given by Eq. (2.37), one finds a field equation of the same form as Eq. (2.39):

$$(\partial^2/\partial \tau^2 - \partial^2/\partial \xi^2)\hat{\Phi} = 0. \quad (2.46)$$

(This is a result of the conformal invariance of the massless scalar field theory in two dimensions.) The solutions to this differential equation can be classified again into the left- and right-moving modes which depend only on $v = \tau + \xi$ and $u = \tau - \xi$, respectively. These variables are related to U and V as follows:

$$U = t - z = -a^{-1}e^{-au}, \quad (2.47)$$

$$V = t + z = a^{-1}e^{av}. \quad (2.48)$$

The Lagrangian density is invariant under the coordinate transformation $(t, z) \mapsto (\tau, \xi)$. As a result, by going through the quantization procedure laid out in Sec. II.A one finds exactly the same theory as in the whole of Minkowski spacetime with (t, z) replaced by (τ, ξ) . Thus, we have, for $0 < V$,

$$\hat{\Phi}_+(V) = \int_0^\infty d\omega \left[\hat{a}_{+\omega}^R g_\omega(v) + \hat{a}_{+\omega}^{R\dagger} g_\omega^*(v) \right], \quad (2.49)$$

where

$$g_\omega(v) = (4\pi\omega)^{-1/2} e^{-i\omega v}, \quad (2.50)$$

and where

$$[\hat{a}_{+\omega}^R, \hat{a}_{+\omega'}^{R\dagger}] = \delta(\omega - \omega') \quad (2.51)$$

with all other commutators vanishing. Notice that the functions $g_\omega(v)$ are eigenfunctions of the boost generator $\partial/\partial \tau$.

The field $\hat{\Phi}_+(V)$ can be expressed in the left Rindler wedge with the condition $V < 0 < U$, by using the left Rindler coordinates $(\bar{\tau}, \bar{\xi})$ defined by Eq. (2.38). Defining $\bar{v} = \bar{\tau} - \bar{\xi}$, one obtains Eqs. (2.49)–(2.51) with v replaced by \bar{v} and with the annihilation and creation operators $\hat{a}_{+\omega}^R$ and $\hat{a}_{+\omega}^{R\dagger}$ replaced by a new set of operators $\hat{a}_{+\omega}^L$ and $\hat{a}_{+\omega}^{L\dagger}$. The variable \bar{v} is related to V by

$$V = -a^{-1}e^{-a\bar{v}}. \quad (2.52)$$

The static vacuum state in the left and right Rindler wedges, the Rindler vacuum state $|0_R\rangle$, is defined by $\hat{a}_{+\omega}^R|0_R\rangle = \hat{a}_{+\omega}^L|0_R\rangle = 0$ for all ω .

To understand the Unruh effect we need to find the Bogolubov coefficients $\alpha_{\omega k}^R$, $\beta_{\omega k}^R$, $\alpha_{\omega k}^L$ and $\beta_{\omega k}^L$, where

$$\theta(V)g_\omega(v) = \int_0^\infty \frac{dk}{\sqrt{4\pi k}} (\alpha_{\omega k}^R e^{-ikV} + \beta_{\omega k}^R e^{ikV}), \quad (2.53)$$

$$\theta(-V)g_\omega(\bar{v}) = \int_0^\infty \frac{dk}{\sqrt{4\pi k}} (\alpha_{\omega k}^L e^{-ikV} + \beta_{\omega k}^L e^{ikV}). \quad (2.54)$$

Here, $\theta(x) = 0$ if $x < 0$ and $\theta(x) = 1$ if $x > 0$, i.e. θ is the Heaviside function. To find $\alpha_{\omega k}^R$ we multiply Eq. (2.53) by $e^{ikV}/2\pi$, $k > 0$, and integrate over V . Thus, we find

$$\begin{aligned} \alpha_{\omega k}^R &= \sqrt{4\pi k} \int_0^\infty \frac{dV}{2\pi} g_\omega(V) e^{ikV} \\ &= \sqrt{\frac{k}{\omega}} \int_0^\infty \frac{dV}{2\pi} (aV)^{-i\omega/a} e^{ikV}. \end{aligned} \quad (2.55)$$

We introduce a cut-off for this integral for large V by letting $V \rightarrow V + i\varepsilon$, $\varepsilon \rightarrow 0+$.¹² Then, changing the integration path to the positive imaginary axis by letting $V = ix/k$, we find

$$\begin{aligned} \alpha_{\omega k}^R &= \frac{ie^{\pi\omega/2a}}{\sqrt{\omega k}} \left(\frac{a}{k}\right)^{-i\omega/a} \int_0^\infty \frac{dx}{2\pi} x^{-i\omega/a} e^{-x} dx \\ &= \frac{ie^{\pi\omega/2a}}{2\pi\sqrt{\omega k}} \left(\frac{a}{k}\right)^{-i\omega/a} \Gamma(1 - i\omega/a). \end{aligned} \quad (2.56)$$

To find the coefficients $\beta_{\omega k}^R$ we replace e^{ikV} in Eq. (2.55) by e^{-ikV} . Then, the appropriate substitution is $V = -ix/k$. As a result we obtain

$$\beta_{\omega k}^R = -\frac{ie^{-\pi\omega/2a}}{2\pi\sqrt{\omega k}} \left(\frac{a}{k}\right)^{-i\omega/a} \Gamma(1 - i\omega/a). \quad (2.57)$$

A similar calculation leads to

$$\alpha_{\omega k}^L = -\frac{ie^{\pi\omega/2a}}{2\pi\sqrt{\omega k}} \left(\frac{a}{k}\right)^{i\omega/a} \Gamma(1 + i\omega/a), \quad (2.58)$$

$$\beta_{\omega k}^L = \frac{ie^{-\pi\omega/2a}}{2\pi\sqrt{\omega k}} \left(\frac{a}{k}\right)^{i\omega/a} \Gamma(1 + i\omega/a). \quad (2.59)$$

We find that these coefficients obey the following relations crucial to the derivation of the Unruh effect:

$$\beta_{\omega k}^L = -e^{-\pi\omega/a} \alpha_{\omega k}^{R*}, \quad \beta_{\omega k}^R = -e^{-\pi\omega/a} \alpha_{\omega k}^{L*}. \quad (2.60)$$

By substituting these relations in Eqs. (2.53) and (2.54) we find that the following functions are linear combinations of positive-frequency modes e^{-ikV} in Minkowski spacetime:

$$G_\omega(V) = \theta(V)g_\omega(v) + \theta(-V)e^{-\pi\omega/a}g_\omega^*(\bar{v}), \quad (2.61)$$

$$\bar{G}_\omega(V) = \theta(-V)g_\omega(\bar{v}) + \theta(V)e^{-\pi\omega/a}g_\omega^*(v). \quad (2.62)$$

One can show that these functions are purely positive-frequency solutions in Minkowski spacetime by analyticity argument as well: since a positive-frequency solution is analytic in the lower-half plane on the complex V -plane, the solution $g_\omega(v) = (4\pi\omega)^{-1/2}(V)^{-i\omega/a}$, $V > 0$, should be continued to the negative real line avoiding the singularity at $V = 0$ around a small circle in the lower half-plane, thus leading to $(4\pi\omega)^{-1/2}e^{-\pi\omega/a}(-V)^{-i\omega/a}$ for $V < 0$. This was the original argument by Unruh (1976).

Eqs. (2.61) and (2.62) can be inverted as

$$\theta(V)g_\omega(v) \propto G_\omega(V) - e^{-\pi\omega/a}\bar{G}_\omega^*(V), \quad (2.63)$$

$$\theta(-V)g_\omega(\bar{v}) \propto \bar{G}_\omega(V) - e^{-\pi\omega/a}G_\omega^*(V). \quad (2.64)$$

By substituting these equations in

$$\begin{aligned} \hat{\Phi}_+(V) &= \int_0^\infty d\omega \left\{ \theta(V)[\hat{a}_{+\omega}^R g_\omega(v) + \hat{a}_{+\omega}^{R\dagger} g_\omega^*(v)] \right. \\ &\quad \left. + \theta(-V)[\hat{a}_{+\omega}^L g_\omega(\bar{v}) + \hat{a}_{+\omega}^{L\dagger} g_\omega^*(\bar{v})] \right\}, \end{aligned} \quad (2.65)$$

we find that the integrand here is proportional to

$$\begin{aligned} G_\omega(V)[\hat{a}_{+\omega}^R - e^{-\pi\omega/a}\hat{a}_{+\omega}^{L\dagger}] \\ + \bar{G}_\omega(V)[\hat{a}_{+\omega}^L - e^{-\pi\omega/a}\hat{a}_{+\omega}^{R\dagger}] + \text{H.c.} \end{aligned}$$

Since the functions $G_\omega(V)$ and $\bar{G}_\omega(V)$ are positive-frequency solutions (with respect to the usual time translation) in Minkowski spacetime, the operators $\hat{a}_{+\omega}^R - e^{-\pi\omega/a}\hat{a}_{+\omega}^{L\dagger}$ and $\hat{a}_{+\omega}^L - e^{-\pi\omega/a}\hat{a}_{+\omega}^{R\dagger}$ annihilate the Minkowski vacuum state $|0_M\rangle$. Thus,

$$(\hat{a}_{+\omega}^R - e^{-\pi\omega/a}\hat{a}_{+\omega}^{L\dagger})|0_M\rangle = 0, \quad (2.66)$$

$$(\hat{a}_{+\omega}^L - e^{-\pi\omega/a}\hat{a}_{+\omega}^{R\dagger})|0_M\rangle = 0. \quad (2.67)$$

These relations uniquely determine the Minkowski vacuum $|0_M\rangle$ as we explain below.

To explain how the state $|0_M\rangle$ is formally expressed in the Fock space on the Rindler vacuum state $|0_R\rangle$ and to show that the state $|0_M\rangle$ is a thermal state when it is probed only in the right (or left) Rindler wedge, we use the approximation where the Rindler energy levels ω are

¹² A cut-off of this kind is always understood in these calculations in field theory, as exemplified by the definition of the delta function $\delta(k) = \int (dx/2\pi) e^{ikx - \varepsilon|x|} = (2\pi i)^{-1} [(k - i\varepsilon)^{-1} - (k + i\varepsilon)^{-1}]$.

discrete.¹³ Thus, we write ω_i in place of ω and let

$$[\hat{a}_{+\omega_i}^R, \hat{a}_{+\omega_j}^{R\dagger}] = [\hat{a}_{+\omega_i}^L, \hat{a}_{+\omega_j}^{L\dagger}] = \delta_{ij} \quad (2.68)$$

with all other commutators among $\hat{a}_{+\omega_i}^R$, $\hat{a}_{+\omega_i}^L$ and their Hermitian conjugates vanishing. Using the discrete version of Eqs. (2.66) and the commutators (2.68), we find

$$\begin{aligned} \langle 0_M | \hat{a}_{+\omega_i}^{R\dagger} \hat{a}_{+\omega_i}^R | 0_M \rangle &= e^{-2\pi\omega_i/a} \langle 0_M | \hat{a}_{+\omega_i}^{L\dagger} \hat{a}_{+\omega_i}^L | 0_M \rangle \\ &+ e^{-2\pi\omega_i/a}. \end{aligned} \quad (2.69)$$

The same relation with $\hat{a}_{+\omega_i}^R$ and $\hat{a}_{+\omega_i}^{R\dagger}$ replaced by $\hat{a}_{+\omega_i}^L$ and $\hat{a}_{+\omega_i}^{L\dagger}$, respectively and vice versa, can be found using Eq. (2.67). By solving these two relations as simultaneous equations, we find

$$\begin{aligned} \langle 0_M | \hat{a}_{+\omega_i}^{R\dagger} \hat{a}_{+\omega_i}^R | 0_M \rangle &= \langle 0_M | \hat{a}_{+\omega_i}^{L\dagger} \hat{a}_{+\omega_i}^L | 0_M \rangle \\ &= (e^{2\pi\omega_i/a} - 1)^{-1}. \end{aligned} \quad (2.70)$$

Hence, the expectation value of the Rindler-particle number is that of a Bose-Einstein particle in a thermal bath of temperature $T = a/2\pi$. This indicates that the Minkowski vacuum can be expressed as a thermal state in the Rindler wedge with the boost generator as the Hamiltonian.

Eq. (2.70) can be expressed without discretization. Define

$$\hat{a}_{+f}^R \equiv \int_0^\infty d\omega f(\omega) \hat{a}_{+\omega}^R, \quad (2.71)$$

where $\int_0^\infty d\omega |f(\omega)|^2 = 1$. Then,

$$\langle 0_M | \hat{a}_{+f}^{R\dagger} \hat{a}_{+f}^R | 0_M \rangle = \int_0^\infty d\omega \frac{|f(\omega)|^2}{e^{2\pi\omega/a} - 1}. \quad (2.72)$$

Exactly the same formula applies to the left Rindler number operator.

It should be emphasized that showing the correct properties of the expectation value of the number operators $\hat{a}_{+f}^{R\dagger} \hat{a}_{+f}^R$ and $\hat{a}_{+f}^{L\dagger} \hat{a}_{+f}^L$ is not enough to conclude that the Minkowski vacuum state restricted to the right or left Rindler wedge is a thermal state. It is necessary to show that the probability of each right/left Rindler-energy eigenstate corresponds to the grand canonical ensemble if the other Rindler wedge is disregarded. One can show this fact by using the discrete version of Eqs. (2.66) and (2.67). First we note that these equations imply

$$(\hat{a}_{+\omega_i}^{R\dagger} \hat{a}_{+\omega_i}^R - \hat{a}_{+\omega_i}^{L\dagger} \hat{a}_{+\omega_i}^L) | 0_M \rangle = 0. \quad (2.73)$$

Thus, the number of the left Rindler particles is the same as that of the right Rindler particles for each ω_i . This implies that we can write

$$| 0_M \rangle \propto \prod_i \sum_{n_i=0}^\infty \frac{K_{n_i}}{n_i!} (\hat{a}_{+\omega_i}^{R\dagger} \hat{a}_{+\omega_i}^L)^{n_i} | 0_R \rangle. \quad (2.74)$$

One can readily find the recursion formula satisfied by K_{n_i} using the discrete version of Eqs. (2.66) and (2.67). The result is

$$K_{n_i+1} - e^{-\pi\omega_i/a} K_{n_i} = 0. \quad (2.75)$$

Hence, $K_{n_i} = e^{-\pi n_i \omega_i/a} K_0$ and

$$| 0_M \rangle = \prod_i \left(C_i \sum_{n_i=0}^\infty e^{-\pi n_i \omega_i/a} | n_i, R \rangle \otimes | n_i, L \rangle \right), \quad (2.76)$$

where $C_i = \sqrt{1 - \exp(-2\pi\omega_i/a)}$. Here the state with n_i left-moving particles with Rindler energy ω_i in each of the left and right Rindler wedges is denoted $| n_i, R \rangle \otimes | n_i, L \rangle$, i.e.

$$\prod_i | n_i, R \rangle \otimes | n_i, L \rangle \equiv \left\{ \prod_i \frac{1}{n_i!} (\hat{a}_{+\omega_i}^{R\dagger} \hat{a}_{+\omega_i}^L)^{n_i} \right\} | 0_R \rangle. \quad (2.77)$$

If one probes only the right Rindler wedge, then the Minkowski vacuum is described by the density matrix obtained by tracing out the left Rindler states, i.e.

$$\hat{\rho}_R = \prod_i \left(C_i^2 \sum_{n_i=0}^\infty \exp(-2\pi n_i \omega_i/a) | n_i, R \rangle \langle n_i, R | \right). \quad (2.78)$$

This is the density matrix for the system of free bosons with temperature $T = a/2\pi$. Thus, the Minkowski vacuum state $| 0_M \rangle$ for the left-moving particles restricted to the left (or right) Rindler wedge is the thermal state with temperature $T = a/2\pi$ with the boost generator normalized on $z^2 - t^2 = 1/a^2$ as the Hamiltonian. This is the Unruh effect for the left-moving sector. It is clear that the Unruh effect for the right-moving sector can be derived in a similar manner.

D. Massive scalar field in Rindler wedges

The Unruh effect for scalar field theory in four-dimensional Minkowski spacetime can be derived in the same way as for the two-dimensional example. Nevertheless, in view of the skepticism on the Unruh effect expressed recently by some authors (Belinskii *et al.*, 1997; Fedotov *et al.*, 1999; Narozhny *et al.*, 2002, 2004; Oriti, 2000) we review the Unruh effect in this theory (Fulling, 1973; Unruh, 1976), drawing attention to some aspects that appear to have caused the skepticism. [See Fulling and Unruh (2004) for an explanation as to why this skepticism is unfounded.]

The free quantized massive scalar field $\hat{\Phi}(t, z, \mathbf{x}_\perp)$, $\mathbf{x}_\perp \equiv (x, y)$, can be expanded as

$$\hat{\Phi}(t, z, \mathbf{x}_\perp) = \int d^3\mathbf{k} (\hat{a}_{\mathbf{k}_z \mathbf{k}_\perp}^M f_{\mathbf{k}_z \mathbf{k}_\perp} + \hat{a}_{\mathbf{k}_z \mathbf{k}_\perp}^{M\dagger} f_{\mathbf{k}_z \mathbf{k}_\perp}^*), \quad (2.79)$$

where the positive-frequency mode functions are

$$f_{\mathbf{k}_z \mathbf{k}_\perp}(t, z, \mathbf{x}_\perp) = [(2\pi)^3 2k_0]^{-1/2} e^{-ik_0 t + ik_z z + i\mathbf{k}_\perp \cdot \mathbf{x}_\perp} \quad (2.80)$$

¹³ We comment on how one can discuss thermal states in field theory without discretization in Sec. III.

with $\mathbf{k}_\perp \equiv (k_x, k_y)$ and $k_0 \equiv \sqrt{k_z^2 + \mathbf{k}_\perp^2 + m^2}$. The Klein-Gordon inner product can readily be calculated as

$$(f_{k_z \mathbf{k}_\perp}, f_{k'_z \mathbf{k}'_\perp})_{\text{KG}} = \delta(k_z - k'_z) \delta^2(\mathbf{k}_\perp - \mathbf{k}'_\perp), \quad (2.81)$$

$$(f_{k_z \mathbf{k}_\perp}^*, f_{k'_z \mathbf{k}'_\perp}^*)_{\text{KG}} = 0. \quad (2.82)$$

Hence, quantizing the scalar field $\hat{\Phi}(t, z, \mathbf{x}_\perp)$ by imposing the equal-time commutation relations (2.9) and (2.10), we find

$$[\hat{a}_{k_z \mathbf{k}_\perp}^M, \hat{a}_{k'_z \mathbf{k}'_\perp}^{M\dagger}] = \delta(k_z - k'_z) \delta^2(\mathbf{k}_\perp - \mathbf{k}'_\perp) \quad (2.83)$$

with all other commutators among annihilation and creation operators vanishing.

The field equation in the right Rindler wedge with the metric (2.37) can readily be found from Eq. (2.30) by letting $N = e^{a\xi}$ and the metric of the hypersurfaces with constant τ be diagonal with $G_{\xi\xi} = e^{2a\xi}$ and $G_{xx} = G_{yy} = 1$. Thus,

$$\frac{\partial^2 \hat{\Phi}}{\partial \tau^2} = \left[\frac{\partial^2}{\partial \xi^2} + e^{2a\xi} \left(\frac{\partial^2}{\partial x^2} + \frac{\partial^2}{\partial y^2} \right) - m^2 e^{2a\xi} \right] \hat{\Phi}. \quad (2.84)$$

The positive-frequency solutions are chosen to be proportional to $e^{-i\omega\tau}$, where ω is a positive constant. This choice corresponds to the static vacuum state with respect to the τ -translation, i.e. the Rindler vacuum state. It is also clear that one may assume that they are proportional to $e^{i\mathbf{k}_\perp \cdot \mathbf{x}_\perp}$. Thus, we write the positive-frequency modes as

$$v_{\omega \mathbf{k}_\perp}^R = \frac{1}{2\pi\sqrt{2\omega}} g_{\omega k_\perp}(\xi) e^{-i\omega\tau + i\mathbf{k}_\perp \cdot \mathbf{x}_\perp} \quad (2.85)$$

with the function $g_{\omega k_\perp}(\xi)$ satisfying

$$\left[-\frac{d^2}{d\xi^2} + e^{2a\xi}(k_\perp^2 + m^2) \right] g_{\omega k_\perp}(\xi) = \omega^2 g_{\omega k_\perp}(\xi). \quad (2.86)$$

This equation is analogous to a time-independent Schrödinger equation with an exponential potential. Thus, the physically relevant solutions $g_{\omega \mathbf{k}_\perp}(\xi)$ tend to zero as $\xi \rightarrow +\infty$ and oscillate like $e^{\pm i\omega\xi}$ as $\xi \rightarrow -\infty$. Note in particular that there is no distinction between the left- and right-moving modes. We choose $g_{\omega k_\perp}(\xi)$ to satisfy, for $\xi < 0$ and $|\xi| \gg 1$,

$$g_{\omega k_\perp}(\xi) \approx \frac{1}{\sqrt{2\pi}} (e^{i[\omega\xi + \gamma(\omega)]} + e^{-i[\omega\xi + \gamma(\omega)]}), \quad (2.87)$$

where $\gamma(\omega)$ is a real constant. This choice of normalization implies [see, e.g., Fulling (1989)]

$$\int_{-\infty}^{\infty} d\xi g_{\omega k_\perp}^*(\xi) g_{\omega' k'_\perp}(\xi) = \delta(\omega - \omega'). \quad (2.88)$$

We present the derivation of this formula in Appendix A for completeness. As a result we have

$$(v_{\omega \mathbf{k}_\perp}^R, v_{\omega' \mathbf{k}'_\perp}^R)_{\text{KG}} = \delta(\omega - \omega') \delta^2(\mathbf{k}_\perp - \mathbf{k}'_\perp), \quad (2.89)$$

$$(v_{\omega \mathbf{k}_\perp}^{R*}, v_{\omega' \mathbf{k}'_\perp}^{R*})_{\text{KG}} = 0. \quad (2.90)$$

The Klein-Gordon inner product here is defined taking the hypersurface Σ in Eq. (2.5) to be a $\tau = \text{const}$ Cauchy surface of the right Rindler wedge. It can also be defined taking Σ to be the entire $t = 0$ hypersurface of the Minkowski spacetime by defining $v_{\omega \mathbf{k}_\perp}^R = 0$ in the left Rindler wedge (and on the plane $t = z = 0$ for definiteness). The functions $g_{\omega k_\perp}(\xi)$ satisfying the differential equation (2.86) and normalization condition (2.87) are

$$g_{\omega k_\perp}(\xi) = \left[\frac{2\omega \sinh(\pi\omega/a)}{\pi^2 a} \right]^{1/2} K_{i\omega/a} \left(\frac{\kappa}{a} e^{a\xi} \right) \quad (2.91)$$

with $\kappa \equiv (k_\perp^2 + m^2)^{1/2}$, where $K_\nu(x)$ is the modified Bessel function (Gradshteyn and Ryzhik, 1980). Hence,

$$v_{\omega \mathbf{k}_\perp}^R = \left[\frac{\sinh(\pi\omega/a)}{4\pi^4 a} \right]^{1/2} K_{i\omega/a} \left(\frac{\kappa}{a} e^{a\xi} \right) e^{i\mathbf{k}_\perp \cdot \mathbf{x}_\perp - i\omega\tau}. \quad (2.92)$$

We present the derivation of this result in Appendix A as well. Thus, we can expand the field $\hat{\Phi}$ in the right Rindler wedge as

$$\hat{\Phi}(\tau, \xi, \mathbf{x}_\perp) = \int_{-\infty}^{\infty} d\omega \int d^2 \mathbf{k}_\perp (\hat{a}_{\omega \mathbf{k}_\perp}^R v_{\omega \mathbf{k}_\perp}^R + \hat{a}_{\omega \mathbf{k}_\perp}^{R\dagger} v_{\omega \mathbf{k}_\perp}^{R*}). \quad (2.93)$$

Then, according to the general results presented in Sec. II.A, we have

$$[\hat{a}_{\omega \mathbf{k}_\perp}^R, \hat{a}_{\omega' \mathbf{k}'_\perp}^{R\dagger}] = \delta(\omega - \omega') \delta^2(\mathbf{k}_\perp - \mathbf{k}'_\perp) \quad (2.94)$$

with all other commutators among $\hat{a}_{\omega \mathbf{k}_\perp}^R$ and $\hat{a}_{\omega \mathbf{k}_\perp}^{R\dagger}$ vanishing.

Quantization of the field $\hat{\Phi}$ in the left Rindler wedge proceeds in exactly the same way. The positive-frequency modes $v_{\omega \mathbf{k}_\perp}^L(\bar{\tau}, \bar{\xi}, \mathbf{x}_\perp)$ are obtained from $v_{\omega \mathbf{k}_\perp}^R(\tau, \xi, \mathbf{x}_\perp)$ simply by replacing τ and ξ by $\bar{\tau}$ and $\bar{\xi}$, respectively. The coefficient operators $\hat{a}_{\omega \mathbf{k}_\perp}^L$ and $\hat{a}_{\omega \mathbf{k}_\perp}^{L\dagger}$ satisfy the commutation relations

$$[\hat{a}_{\omega \mathbf{k}_\perp}^L, \hat{a}_{\omega' \mathbf{k}'_\perp}^{L\dagger}] = \delta(\omega - \omega') \delta^2(\mathbf{k}_\perp - \mathbf{k}'_\perp) \quad (2.95)$$

with all other commutators vanishing. Thus, one can expand the field $\hat{\Phi}$ in the left and right Rindler wedges as

$$\hat{\Phi} = \int_0^{+\infty} d\omega \int d^2\mathbf{k}_\perp \left[\hat{a}_{\omega\mathbf{k}_\perp}^R v_{\omega\mathbf{k}_\perp}^R(\tau, \xi, \mathbf{x}_\perp) + \hat{a}_{\omega\mathbf{k}_\perp}^{R\dagger} v_{\omega\mathbf{k}_\perp}^{R*}(\tau, \xi, \mathbf{x}_\perp) + \hat{a}_{\omega\mathbf{k}_\perp}^L v_{\omega\mathbf{k}_\perp}^L(\bar{\tau}, \bar{\xi}, \mathbf{x}_\perp) + \hat{a}_{\omega\mathbf{k}_\perp}^{L\dagger} v_{\omega\mathbf{k}_\perp}^{L*}(\bar{\tau}, \bar{\xi}, \mathbf{x}_\perp) \right]. \quad (2.96)$$

The Rindler vacuum state $|0_R\rangle$ is defined by requiring that $\hat{a}_{\omega\mathbf{k}_\perp}^R|0_R\rangle = \hat{a}_{\omega\mathbf{k}_\perp}^L|0_R\rangle = 0$ for all ω and \mathbf{k}_\perp . As it stands, this expansion makes sense only in the Rindler wedges. However, it will be shown that the modes $v_{\omega\mathbf{k}_\perp}^R$ and $v_{\omega\mathbf{k}_\perp}^L$ can naturally be extended to the whole of Minkowski spacetime [see Eqs. (2.112), (2.113) and (2.114)]. After this extension we shall see that Eq. (2.96) gives just another valid mode expansion of the field $\hat{\Phi}$ in Minkowski spacetime.¹⁴ In particular, in Sec. II.F the two-point function calculated using this expansion in the state $|0_M\rangle$ will be shown to give the standard result in Minkowski spacetime.

E. Bogolubov coefficients and the Unruh effect

In this subsection we find the Bogolubov coefficients between the two expansions of the massive scalar field $\hat{\Phi}$ in Minkowski spacetime and derive the Unruh effect, i.e. the fact that the Minkowski vacuum state is a thermal state with temperature $T = a/2\pi$ on the right or left Rindler wedge.

It is clear that the Bogolubov coefficients between modes with different \mathbf{k}_\perp are zero. Thus, we can write in general

$$v_{\omega\mathbf{k}_\perp}^R = \int_{-\infty}^{\infty} \frac{dk_z}{\sqrt{4\pi k_0}} \left[\alpha_{\omega k_z k_\perp}^R e^{-ik_0 t + ik_z z} + \beta_{\omega k_z k_\perp}^R e^{ik_0 t - ik_z z} \right] \frac{e^{i\mathbf{k}_\perp \cdot \mathbf{x}_\perp}}{2\pi}, \quad (2.97)$$

$$v_{\omega\mathbf{k}_\perp}^L = \int_{-\infty}^{\infty} \frac{dk_z}{\sqrt{4\pi k_0}} \left[\alpha_{\omega k_z k_\perp}^L e^{-ik_0 t + ik_z z} + \beta_{\omega k_z k_\perp}^L e^{ik_0 t - ik_z z} \right] \frac{e^{i\mathbf{k}_\perp \cdot \mathbf{x}_\perp}}{2\pi}. \quad (2.98)$$

We are assuming here that the modes $v_{\omega\mathbf{k}_\perp}^R$ and $v_{\omega\mathbf{k}_\perp}^L$ have been suitably extended to the whole of Minkowski spacetime. The relation between (τ, ξ) and (t, z) given by Eq. (2.36) is the same as that between $(\bar{\tau}, \bar{\xi})$ and $(t, -z)$ given by Eq. (2.38). Hence, $v_{\omega\mathbf{k}_\perp}^L$ is obtained from $v_{\omega\mathbf{k}_\perp}^R$ by letting $z \mapsto -z$. From this observation we find the following relations:

$$\alpha_{\omega k_z k_\perp}^L = \alpha_{\omega -k_z k_\perp}^R, \quad \beta_{\omega k_z k_\perp}^L = \beta_{\omega -k_z k_\perp}^R. \quad (2.99)$$

These Bogolubov coefficients will be found explicitly later, but it is clear from the discussion of the mass-

less scalar field theory in two dimensions that the Unruh effect will follow if

$$(\hat{a}_{\omega\mathbf{k}_\perp}^R - e^{-\pi\omega/a} \hat{a}_{\omega-\mathbf{k}_\perp}^{L\dagger})|0_M\rangle = 0, \quad (2.100)$$

$$(\hat{a}_{\omega\mathbf{k}_\perp}^L - e^{-\pi\omega/a} \hat{a}_{\omega-\mathbf{k}_\perp}^{R\dagger})|0_M\rangle = 0. \quad (2.101)$$

[See the corresponding equations (2.66) and (2.67) in the two-dimensional model.] These relations in turn will result if the following modes are purely positive-frequency in Minkowski spacetime:

$$w_{-\omega\mathbf{k}_\perp} \equiv \frac{v_{\omega\mathbf{k}_\perp}^R + e^{-\pi\omega/a} v_{\omega-\mathbf{k}_\perp}^{L*}}{\sqrt{1 - e^{-2\pi\omega/a}}}, \quad (2.102)$$

$$w_{+\omega\mathbf{k}_\perp} \equiv \frac{v_{\omega\mathbf{k}_\perp}^L + e^{-\pi\omega/a} v_{\omega-\mathbf{k}_\perp}^{R*}}{\sqrt{1 - e^{-2\pi\omega/a}}}. \quad (2.103)$$

[See the corresponding equations (2.61) and (2.62) in the two-dimensional model.] This fact in turn will follow if

$$\beta_{\omega k_z k_\perp}^R = -e^{-\pi\omega/a} \alpha_{\omega k_z k_\perp}^{L*}, \quad \beta_{\omega k_z k_\perp}^L = -e^{-\pi\omega/a} \alpha_{\omega k_z k_\perp}^{R*}. \quad (2.104)$$

[See the corresponding equation (2.60).] We shall show Eq. (2.104) by explicit evaluation of the Bogolubov coefficients, which were originally computed by Fulling (1973).

To calculate the Bogolubov coefficients it is convenient to examine the behavior of the solutions on the future Killing horizon, $t = z, t > 0$. There we have

$$v_{\omega\mathbf{k}_\perp}^R \rightarrow \int_{-\infty}^{\infty} \frac{dk_z}{\sqrt{4\pi k_0}} \times \left[\alpha_{\omega k_z k_\perp}^R e^{-i(k_0 - k_z)V/2} + \beta_{\omega k_z k_\perp}^R e^{i(k_0 - k_z)V/2} \right] \frac{e^{i\mathbf{k}_\perp \cdot \mathbf{x}_\perp}}{2\pi}. \quad (2.105)$$

On the other hand, using the small-argument approximation (A10) for the modified Bessel function, we have for $\xi \rightarrow -\infty$

$$v_{\omega\mathbf{k}_\perp}^R \rightarrow \frac{i}{4\pi} [a \sinh(\pi\omega/a)]^{-1/2} e^{i\mathbf{k}_\perp \cdot \mathbf{x}_\perp} \times \left(\frac{(\kappa/2a)^{i\omega/a} e^{-i\omega u}}{\Gamma(1 + i\omega/a)} - \frac{(\kappa/2a)^{-i\omega/a} e^{-i\omega v}}{\Gamma(1 - i\omega/a)} \right), \quad (2.106)$$

where we recall $\kappa = (k_\perp^2 + m^2)^{1/2}$. The first term inside the parentheses in this equation oscillates infinitely many times as $u \rightarrow \infty$, where the future Killing horizon is, and is bounded. Such a term should be regarded as zero. Hence, the Bogolubov coefficient $\alpha_{\omega k_z k_\perp}^R$ is obtained by

¹⁴ This point is emphasized in Birrell and Davies (1982).

multiplying Eq. (2.106) by $e^{i(k_0-k_z)V/2}$ and integrating over V as

$$\begin{aligned}\alpha_{\omega k_z k_\perp}^R &= -\frac{i(\kappa/2a)^{-i\omega/a}(k_0-k_z)}{4\sqrt{\pi a k_0} \sinh(\pi\omega/a)\Gamma(1-i\omega/a)} \\ &\times \int_0^\infty dV (aV)^{-i\omega/a} e^{i(k_0-k_z)V/2} \\ &= \frac{e^{\pi\omega/2a}}{\sqrt{4\pi k_0 a} \sinh(\pi\omega/a)} \left(\frac{k_0+k_z}{k_0-k_z}\right)^{-i\omega/2a},\end{aligned}\quad (2.107)$$

where we have used $\kappa = \sqrt{(k_0-k_z)(k_0+k_z)}$. Note that we have implicitly chosen a particular (and natural) extension of the modes $v_{\omega \mathbf{k}_\perp}^R$ to the whole of Minkowski spacetime. [Otherwise it should not be possible to find the coefficients Bogolubov coefficients $\alpha_{\omega k_z k_\perp}^R$ and $\beta_{\omega k_z k_\perp}^R$ in Eq. (2.97)]. In particular, we have excluded any delta-function contribution at $V = 0$.

By multiplying Eq. (2.106) by $e^{-i(k_0-k_z)V/2}$ and integrating over V we find

$$\beta_{\omega k_z k_\perp}^R = -\frac{e^{-\pi\omega/2a}}{\sqrt{4\pi k_0 a} \sinh(\pi\omega/a)} \left(\frac{k_0+k_z}{k_0-k_z}\right)^{-i\omega/2a}.\quad (2.108)$$

Introducing the *rapidity* $\vartheta(k_z)$ defined as

$$\vartheta(k_z) \equiv \frac{1}{2} \log \left(\frac{k_0+k_z}{k_0-k_z} \right),\quad (2.109)$$

and using Eq. (2.99), we have

$$\begin{aligned}\alpha_{\omega k_z k_\perp}^R &= \alpha_{\omega -k_z k_\perp}^L \\ &= \frac{e^{-i\vartheta(k_z)\omega/a}}{\sqrt{2\pi k_0 a} (1 - e^{-2\pi\omega/a})},\end{aligned}\quad (2.110)$$

$$\begin{aligned}\beta_{\omega k_z k_\perp}^R &= \beta_{\omega -k_z k_\perp}^L \\ &= -\frac{e^{-\pi\omega/a} e^{-i\vartheta(k_z)\omega/a}}{\sqrt{2\pi k_0 a} (1 - e^{-2\pi\omega/a})}.\end{aligned}\quad (2.111)$$

Hence, Eq. (2.104) is satisfied and as a result the vacuum state $|0_M\rangle$ restricted to the left (or right) Rindler wedge is a thermal state with temperature $T = a/2\pi$ with the boost generator normalized on $t^2 - z^2 = 1/a^2$ as the Hamiltonian.

Although we have now established the Unruh effect, it is useful to examine the modes natural to the Rindler wedges further for later discussion. The purely positive-frequency modes in Minkowski spacetime defined by Eqs. (2.102) and (2.103) are

$$\begin{aligned}w_{\pm\omega \mathbf{k}_\perp} &= \int_{-\infty}^\infty \frac{dk_z}{\sqrt{8a\pi k_0}} e^{\pm i\vartheta(k_z)\omega/a} e^{-ik_0 t + ik_z z} \\ &\times \frac{e^{i\mathbf{k}_\perp \cdot \mathbf{x}_\perp}}{2\pi}.\end{aligned}\quad (2.112)$$

The modes $v_{\omega \mathbf{k}_\perp}^R$ and $v_{\omega \mathbf{k}_\perp}^L$, which vanish in the left and right Rindler wedges, respectively, are expressed in terms

of these modes as

$$v_{\omega \mathbf{k}_\perp}^R = \frac{w_{-\omega \mathbf{k}_\perp} - e^{-\pi\omega/a} w_{+\omega -\mathbf{k}_\perp}^*}{\sqrt{1 - e^{-2\pi\omega/a}}},\quad (2.113)$$

$$v_{\omega \mathbf{k}_\perp}^L = \frac{w_{+\omega \mathbf{k}_\perp} - e^{-\pi\omega/a} w_{-\omega -\mathbf{k}_\perp}^*}{\sqrt{1 - e^{-2\pi\omega/a}}}.\quad (2.114)$$

These formulas and Eq. (2.112) give the modes $v_{\omega \mathbf{k}_\perp}^R$ and $v_{\omega \mathbf{k}_\perp}^L$ as distributions in the whole of Minkowski spacetime. One can verify that the modes $w_{\pm\omega \mathbf{k}_\perp}$ satisfy

$$(w_{\pm\omega \mathbf{k}_\perp}, w_{\pm\omega' \mathbf{k}'_\perp})_{\text{KG}} = \delta(\omega - \omega') \delta^2(\mathbf{k}_\perp - \mathbf{k}'_\perp),\quad (2.115)$$

$$(w_{\pm\omega \mathbf{k}_\perp}^*, w_{\pm\omega' \mathbf{k}'_\perp}^*)_{\text{KG}} = -\delta(\omega - \omega') \delta^2(\mathbf{k}_\perp - \mathbf{k}'_\perp)\quad (2.116)$$

with all other Klein-Gordon inner products among $w_{\pm\omega \mathbf{k}_\perp}$ and their complex conjugates vanishing. Here the Klein-Gordon inner product is defined as an integral over the $t = 0$ hypersurface in Minkowski spacetime. The following formula, which can be shown by using $d\vartheta(k_z) = dk_z/k_0$, is useful in calculating these Klein-Gordon inner products:

$$\int_{-\infty}^\infty \frac{dk_z}{2\pi a k_0} e^{i\vartheta(k_z)(\omega - \omega')/a} = \delta(\omega - \omega').\quad (2.117)$$

It is worth emphasizing that these modes form a complete set of solutions to the Klein-Gordon equation, not only in the left and right Rindler wedges but also in the whole of Minkowski spacetime. This fact can readily be seen by inverting the relation (2.112):

$$\begin{aligned}&\frac{1}{\sqrt{2k_0}(2\pi)^3} e^{-ik_0 t + ik_z z + i\mathbf{k}_\perp \cdot \mathbf{x}_\perp} \\ &= \frac{1}{\sqrt{2\pi a k_0}} \int_0^\infty d\omega [e^{i\vartheta(k_z)\omega/a} w_{-\omega \mathbf{k}_\perp} \\ &\quad + e^{-i\vartheta(k_z)\omega/a} w_{+\omega \mathbf{k}_\perp}].\end{aligned}\quad (2.118)$$

One may object to this conclusion as do Belinskii *et al.* (1997) because the modes $w_{\pm\omega \mathbf{k}_\perp}$ were originally defined only on the left and right Rindler wedges, which are open regions; in particular, these modes are not defined on the plane $t = z = 0$. However, the formula (2.112) gives the positive-frequency modes $w_{\pm\omega \mathbf{k}_\perp}$ in terms of the momentum eigenfunctions unambiguously as a distribution over the whole of Minkowski spacetime. In other words, if $f(t, \mathbf{x})$ is a compactly-supported smooth function on Minkowski spacetime, whose support may intersect the plane $t = z = 0$, the mode functions $w_{\pm\omega \mathbf{k}_\perp}$ smeared with f is well defined and unique. That is,

$$\begin{aligned}\hat{f}^R(\pm\omega, \mathbf{k}_\perp) &\equiv \int d^4x w_{\pm\omega \mathbf{k}_\perp}^*(t, z, \mathbf{x}_\perp) f(t, z, \mathbf{x}_\perp) \\ &= \int_{-\infty}^\infty \frac{dk_z}{\sqrt{2\pi a k_0}} e^{\mp i\vartheta(k_z)\omega/a} \hat{f}^M(k_z, \mathbf{k}_\perp),\end{aligned}\quad (2.119)$$

where

$$\hat{f}^M(k_z, \mathbf{k}_\perp) \equiv \frac{1}{\sqrt{(2\pi)^3 2k_0}} \int d^4x e^{ik_0 t - i\mathbf{k}\cdot\mathbf{x}} f(t, \mathbf{x}). \quad (2.120)$$

We have used $w_{\pm\omega\mathbf{k}_\perp}^*$ rather than $w_{\pm\omega\mathbf{k}_\perp}$ here for later convenience. Note that the function $\hat{f}^M(k_z, \mathbf{k}_\perp)$ tends to 0 as $k_z \rightarrow \pm\infty$ faster than any powers of $|k_z|^{-1}$ due to the smoothness of $f(t, \mathbf{x})$. This implies that the integral in Eq. (2.119) is absolutely convergent. [In fact Eq. (2.119) should be taken as the definition of the modes $w_{\pm\omega\mathbf{k}_\perp}^*$ as distributions over the full Minkowski spacetime.]

Since the modes $w_{\pm\omega\mathbf{k}_\perp}$ and $w_{\pm\omega\mathbf{k}_\perp}^*$ form a complete set of solutions in Minkowski spacetime, the Rindler modes $v_{\omega\mathbf{k}_\perp}^R$ and $v_{\omega\mathbf{k}_\perp}^L$ and their complex conjugates form a complete set as is clear from Eqs. (2.102) and (2.103). Related comments will be made in the next two subsections.

F. Completeness of the Rindler modes in Minkowski spacetime

In the previous subsection we commented that the Rindler modes form a complete set of solutions to the Klein-Gordon equation in Minkowski spacetime. To emphasize this point again we show in this subsection that the Wightman two-point function is correctly reproduced everywhere in Minkowski spacetime even if we use the Rindler modes. It is our hope that the calculation here will dispel any suspicion that the Rindler modes may be

incomplete due to the singularity on the hypersurfaces $t = \pm z$.

The two-point function in the Minkowski vacuum state is well known to be

$$\begin{aligned} \Delta(x; x') &= \langle 0_M | \hat{\Phi}(x) \hat{\Phi}(x') | 0_M \rangle \\ &= \int \frac{dk_z d^2\mathbf{k}_\perp}{2k_0 (2\pi)^3} e^{-ik\cdot(x-x')}, \end{aligned} \quad (2.121)$$

where $x = (t, z, \mathbf{x}_\perp)$ and similarly for x' . To calculate the two-point functions with the Rindler modes we use the expansion (2.96) with the Rindler modes $v_{\omega\mathbf{k}_\perp}^L$ and $v_{\omega\mathbf{k}_\perp}^R$ given by Eqs. (2.112), (2.113) and (2.114). By Eqs. (2.100) and (2.101) we see that the Rindler annihilation operators can be written as

$$\hat{a}_{\omega\mathbf{k}_\perp}^R = \frac{\hat{b}_{-\omega\mathbf{k}_\perp} + e^{-\pi\omega/a} \hat{b}_{+\omega-\mathbf{k}_\perp}^\dagger}{\sqrt{1 - e^{-2\pi\omega/a}}}, \quad (2.122)$$

$$\hat{a}_{\omega\mathbf{k}_\perp}^L = \frac{\hat{b}_{+\omega\mathbf{k}_\perp} + e^{-\pi\omega/a} \hat{b}_{-\omega-\mathbf{k}_\perp}^\dagger}{\sqrt{1 - e^{-2\pi\omega/a}}}, \quad (2.123)$$

where the operators $b_{\pm\omega\mathbf{k}_\perp}$ annihilate the Minkowski vacuum $|0_M\rangle$ and have the following standard commutation relations:

$$[b_{\pm\omega\mathbf{k}_\perp}, b_{\pm\omega'\mathbf{k}'_\perp}^\dagger] = \delta(\omega - \omega') \delta^2(\mathbf{k}_\perp - \mathbf{k}'_\perp) \quad (2.124)$$

with all other commutators vanishing. Eqs. (2.122) and (2.123) can be used to find the following expectation values:

$$\langle 0_M | a_{\omega\mathbf{k}_\perp}^{R\dagger} a_{\omega'\mathbf{k}'_\perp}^R | 0_M \rangle = \langle 0_M | a_{\omega\mathbf{k}_\perp}^{L\dagger} a_{\omega'\mathbf{k}'_\perp}^L | 0_M \rangle = (e^{2\pi\omega/a} - 1)^{-1} \delta(\omega - \omega') \delta^2(\mathbf{k}_\perp - \mathbf{k}'_\perp), \quad (2.125)$$

$$\langle 0_M | a_{\omega\mathbf{k}_\perp}^R a_{\omega'\mathbf{k}'_\perp}^{R\dagger} | 0_M \rangle = \langle 0_M | a_{\omega\mathbf{k}_\perp}^L a_{\omega'\mathbf{k}'_\perp}^{L\dagger} | 0_M \rangle = (1 - e^{-2\pi\omega/a})^{-1} \delta(\omega - \omega') \delta^2(\mathbf{k}_\perp - \mathbf{k}'_\perp), \quad (2.126)$$

$$\langle 0_M | a_{\omega\mathbf{k}_\perp}^L a_{\omega'\mathbf{k}'_\perp}^R | 0_M \rangle = \langle 0_M | a_{\omega\mathbf{k}_\perp}^{L\dagger} a_{\omega'\mathbf{k}'_\perp}^{R\dagger} | 0_M \rangle = (e^{\pi\omega/a} - e^{-\pi\omega/a})^{-1} \delta(\omega - \omega') \delta^2(\mathbf{k}_\perp + \mathbf{k}'_\perp). \quad (2.127)$$

The vacuum expectation values of the other products of two creation/annihilation operators vanish. Then, the two-point function of the field $\hat{\Phi}(x)$ given in Eq. (2.96) is

$$\begin{aligned} \Delta(x; x') &= \int_0^\infty d\omega \int d^2\mathbf{k}_\perp \left\{ [v_{\omega\mathbf{k}_\perp}^R(x) v_{\omega\mathbf{k}_\perp}^{R*}(x') + v_{\omega\mathbf{k}_\perp}^L(x) v_{\omega\mathbf{k}_\perp}^{L*}(x')] (1 - e^{-2\pi\omega/a})^{-1} \right. \\ &\quad + [v_{\omega\mathbf{k}_\perp}^{R*}(x) v_{\omega\mathbf{k}_\perp}^R(x') + v_{\omega\mathbf{k}_\perp}^{L*}(x) v_{\omega\mathbf{k}_\perp}^L(x')] (e^{2\pi\omega/a} - 1)^{-1} \\ &\quad + 2 [v_{\omega\mathbf{k}_\perp}^R(x) v_{\omega-\mathbf{k}_\perp}^L(x') + v_{\omega\mathbf{k}_\perp}^{R*}(x) v_{\omega-\mathbf{k}_\perp}^{L*}(x')] (e^{\pi\omega/a} - e^{-\pi\omega/a}) \\ &\quad \left. + 2 [v_{\omega\mathbf{k}_\perp}^L(x) v_{\omega-\mathbf{k}_\perp}^R(x') + v_{\omega\mathbf{k}_\perp}^{L*}(x) v_{\omega-\mathbf{k}_\perp}^{R*}(x')] (e^{\pi\omega/a} - e^{-\pi\omega/a}) \right\}. \end{aligned} \quad (2.128)$$

This expression can be simplified using Eqs (2.113) and (2.114) as

$$\Delta(x; x') = \int_0^\infty d\omega \int d^2\mathbf{k}_\perp [w_{+\omega\mathbf{k}_\perp}(x) w_{+\omega\mathbf{k}_\perp}^*(x') + w_{-\omega\mathbf{k}_\perp}(x) w_{-\omega\mathbf{k}_\perp}^*(x')], \quad (2.129)$$

where $w_{\pm\omega\mathbf{k}_\perp}$ are given by Eq. (2.112). Thus,

$$\Delta(x; x') = \frac{1}{32\pi^4 a} \int_{-\infty}^\infty d\omega \int_{-\infty}^\infty \frac{dk_z}{k_0} \int_{-\infty}^\infty d\vartheta(k'_z) \int d^2\mathbf{k}_\perp e^{i[\vartheta(k_z) - \vartheta(k'_z)]\omega/a} e^{-ik_0 t + ik'_0 t' + ik_z z - ik'_z z' + i\mathbf{k}_\perp \cdot (\mathbf{x}_\perp - \mathbf{x}'_\perp)}. \quad (2.130)$$

The ω - and $\vartheta(k'_z)$ -integration can readily be performed, and we find that the two-point function indeed takes the form given by Eq. (2.121).

The expression (2.129) is undefined if either of the two points is on the hyperplane $t = \pm z$. However, since the two-point function $\Delta(x; x')$ is defined as a distribution, it is well defined on the whole of Minkowski spacetime if the following integral exists for all compactly-supported functions $f(x)$ and $g(x)$:

$$F(f, g) \equiv \int d^4x d^4x' f^*(x) g(x') \Delta(x; x'). \quad (2.131)$$

We find using Eq. (2.129)

$$\begin{aligned} F(f, g) &= \int_0^\infty d\omega \int d^2\mathbf{k}_\perp \\ &\times \left[\hat{f}^{R*}(-\omega, \mathbf{k}_\perp) \hat{g}^R(-\omega, \mathbf{k}_\perp) \right. \\ &\left. + \hat{f}^{R*}(+\omega, \mathbf{k}_\perp) \hat{g}^R(+\omega, \mathbf{k}_\perp) \right], \quad (2.132) \end{aligned}$$

where \hat{f}^R is defined by Eq. (2.119), and \hat{g}^R is defined similarly. It can readily be shown that this agrees with the standard expression for the smeared two-point function,

$$F(f, g) = \int d^3\mathbf{k} \hat{f}^{M*}(\mathbf{k}) \hat{g}^M(\mathbf{k}), \quad (2.133)$$

where \hat{f}^M is defined by Eq. (2.120) and the Fourier transform \hat{g}^M is defined similarly.

G. Unruh effect and quantum field theory in the expanding degenerate Kasner universe

In this subsection we review the relation between the modes in the Rindler wedges and those in the expanding degenerate Kasner universe. It is well known that there is a choice of the positive-frequency modes in the degenerate Kasner universes that gives a state identical to the Minkowski vacuum (Fulling *et al.*, 1974). We first show that these positive-frequency modes are in fact the modes $w_{\pm\omega\mathbf{k}_\perp}$ in the Rindler wedges (Gerlach, 1988). Then, we show that the Rindler vacuum state $|0_R\rangle$ is identical to one of the states in the expanding degenerate Kasner universe found in the literature (Birrell and Davies, 1982; Fulling *et al.*, 1974).

We introduce the following coordinate transformation:

$$t = T \cosh a\zeta, \quad z = T \sinh a\zeta. \quad (2.134)$$

With $T > 0$ the coordinate system $(T, \zeta, \mathbf{x}_\perp)$ covers the region with the condition $t > |z|$, i.e. the expanding degenerate Kasner universe. Then, the Minkowski metric becomes

$$ds^2 = dT^2 - a^2 T^2 d\zeta^2 - dx^2 - dy^2. \quad (2.135)$$

The hyperplanes of constant T are spacelike, and the variable T plays the role of time. Hence, the $T = \text{const}$ space expands in the ζ -direction linearly. We note that

$$\frac{t+z}{t-z} = e^{2a\zeta}, \quad (2.136)$$

and that $(t^2 - z^2)^{1/2} = T$.

Let us change the integration variable in the expression (2.112) for modes $w_{\pm\omega\mathbf{k}_\perp}$ from k_z to the rapidity $\vartheta = \vartheta(k_z)$ [see Eq. (2.109)]. Then, we have

$$k_0 = \kappa \cosh \vartheta, \quad k_z = \kappa \sinh \vartheta, \quad (2.137)$$

where $\kappa = (k_\perp^2 + m^2)^{1/2}$ as before. Thus, we obtain, using Eq. (2.136) after shifting of the integration variable as $\vartheta \rightarrow \vartheta + a\zeta$,

$$\begin{aligned} w_{\pm\omega\mathbf{k}_\perp} &= \frac{e^{i\mathbf{k}_\perp \cdot \mathbf{x}_\perp \pm i\omega\zeta}}{2\pi} \int_{-\infty}^{\infty} \frac{d\vartheta}{\sqrt{8a\pi}} e^{\pm i\omega\vartheta/a} \\ &\times \exp(-i\kappa T \cosh \vartheta). \quad (2.138) \end{aligned}$$

The ϑ -integral is the same for both signs of $e^{\pm i\omega\vartheta/a}$ because the imaginary part of the integrand is odd in ϑ . Adopting the minus sign and using the formula (Gradshteyn and Ryzhik, 1980)

$$H_\nu^{(2)}(x) = -\frac{e^{i\nu\pi/2}}{\pi i} \int_{-\infty}^{\infty} e^{-ix \cosh t - \nu t} dt \quad (2.139)$$

with $\nu = i\omega/a$, we find

$$w_{\pm\omega\mathbf{k}_\perp} = -i \frac{e^{i\mathbf{k}_\perp \cdot \mathbf{x}_\perp \pm i\omega\zeta}}{2\pi\sqrt{8a}} e^{\pi\omega/2a} H_{i\omega/a}^{(2)}(\kappa T). \quad (2.140)$$

These modes are well known to form a complete set of positive-frequency modes which correspond to the Minkowski vacuum state (Fulling *et al.*, 1974).

Now, from Eq. (2.113) we find that the positive-frequency modes with respect to the boost generator in the right Rindler wedge corresponding to the Rindler vacuum state take the following form in the expanding degenerate Kasner universe:

$$\begin{aligned} v_{\omega\mathbf{k}_\perp}^R &= -i \frac{e^{-i\omega\zeta} e^{i\mathbf{k}_\perp \cdot \mathbf{x}_\perp}}{2\pi\sqrt{8a}(e^{\pi\omega/a} - e^{-\pi\omega/a})} \\ &\times \left\{ e^{\pi\omega/a} H_{i\omega/a}^{(2)}(\kappa T) + \left[H_{i\omega/a}^{(2)}(\kappa T) \right]^* \right\}. \quad (2.141) \end{aligned}$$

Then, recalling the fact that $[H_\nu^{(2)}(x)]^* = H_{-\nu}^{(1)}(x)$ if ν is purely imaginary and if x is real and using the formulas (Gradshteyn and Ryzhik, 1980)

$$e^{\nu\pi i} H_{-\nu}^{(2)}(z) = H_\nu^{(2)}(z), \quad (2.142)$$

$$H_\nu^{(1)}(z) + H_\nu^{(2)}(z) = 2J_\nu(z) \quad (2.143)$$

with $\nu = -i\omega/a$ in Eq. (2.141), we find

$$v_{\omega\mathbf{k}_\perp}^R = -i \frac{e^{-i\omega\zeta} e^{i\mathbf{k}_\perp \cdot \mathbf{x}_\perp}}{2\pi\sqrt{4a} \sinh(\pi\omega/a)} J_{-i\omega/a}(\kappa T). \quad (2.144)$$

In exactly the same manner we find that the left Rindler modes $v_{\omega\mathbf{k}_\perp}^L$ are given by Eq. (2.144) with $e^{-i\omega\zeta}$ replaced by $e^{i\omega\zeta}$ in the expanding degenerate Kasner universe. These modes have been identified as the positive-frequency modes corresponding to a state which is inequivalent to the Minkowski vacuum (Birrell and Davies, 1982; Fulling *et al.*, 1974). Thus, the Rindler vacuum state $|0_R\rangle$ is in fact one of the states in the expanding degenerate Kasner universes given in the literature.

H. Unruh effect and classical field theory

Although the Unruh effect, like the Hawking effect, is a quantum effect, its derivation does not involve any loop calculations. It is also the result of properties of classical solutions to the field equation. These observations naturally lead to the following question: “Are there any aspects of the Unruh effect that can be described entirely in the framework of classical field theory?” In this context, it is useful to note that, although the Unruh temperature $T = \hbar a/(2\pi c)$ (at $\xi = 0$) is proportional to \hbar , since the energy of a particle can be written as $E = \hbar\omega$, where ω is the angular frequency, the Boltzmann factor $\exp(-E/T) = \exp(-2\pi\omega c/a)$ is independent of \hbar . This is consistent with the fact that the Bogolubov transformation encoding the Unruh effect is derived using only classical solutions. It is indeed possible to define some quantities in classical field theory which exhibit what one may call the classical Unruh effect (Higuchi and Matsas, 1993) as we briefly describe here.¹⁵

We consider the classical scalar field ϕ in Minkowski spacetime satisfying $(\square + m^2)\phi = 0$. The energy-momentum tensor is

$$T_{\mu\nu} = \nabla_\mu\phi\nabla_\nu\phi - g_{\mu\nu}(\nabla_\alpha\phi\nabla^\alpha\phi - m^2\phi^2)/2. \quad (2.145)$$

Now, if X^μ is a Killing vector, then the current $J_{(X)}^\mu$ defined by

$$J_{(X)}^\mu = X_\nu T^{\mu\nu} \quad (2.146)$$

is conserved because of the Killing equation and the equation $\nabla_\mu T^{\mu\nu} = 0$. Hence, the energy associated with the Killing vector X^μ defined by

$$E_X = \int d\Sigma n_\mu J_{(X)}^\mu, \quad (2.147)$$

where Σ is a Cauchy hypersurface and n_μ is the future-directed unit vector normal to Σ , is conserved. If T^μ

is the time-translation vector, then the energy E_T with $X^\mu = T^\mu$ is the ordinary energy. If $R^\mu = a[z(\partial/\partial t)^\mu + t(\partial/\partial z)^\mu]$, i.e. the boost Killing vector (normalized at $\xi = 0$), then E_R with $X^\mu = R^\mu$ is the Rindler energy.

It is convenient for our purposes to rewrite the energy E_X as

$$E_X = (i/2)(\phi, X^\mu\nabla_\mu\phi)_{KG}. \quad (2.148)$$

This can readily be established, by using the equality

$$\begin{aligned} & \phi\nabla_\mu(X^\alpha\nabla_\alpha\phi) - X^\alpha\nabla_\alpha\phi\nabla_\mu\phi + 2X^\alpha T_{\alpha\mu} \\ &= \nabla^\alpha[\phi(X_\alpha\nabla_\mu\phi - X_\mu\nabla_\alpha\phi)]. \end{aligned} \quad (2.149)$$

Now, one can divide the scalar field into the positive- and negative-frequency parts with respect to the time-translation Killing vector as

$$\phi(x) = \phi^{(T+)}(x) + \phi^{(T-)}(x), \quad (2.150)$$

where the negative-frequency part is the complex conjugate of the positive-frequency part, $\phi^{(T-)}(x) = [\phi^{(T+)}(x)]^*$, and where the positive-frequency part is given as

$$\phi^{(T+)}(x) = \int \frac{d^3\mathbf{k}}{\sqrt{2k_0}(2\pi)^{3/2}} c_T(\mathbf{k}) e^{-ik_0 t + i\mathbf{k}_\perp \cdot \mathbf{x}_\perp}, \quad (2.151)$$

for some function $c_T(\mathbf{k})$. Then, since $T^\mu\partial_\mu = \partial_t$, we find the energy by using Eq. (2.148) as

$$E_T = \int d^3\mathbf{k} k_0 |c_T(\mathbf{k})|^2. \quad (2.152)$$

It is natural to define the quantity N_T by dividing the integrand $k_0 |c_T(\mathbf{k})|^2$ by k_0 as

$$N_T = \int d^3\mathbf{k} |c_T(\mathbf{k})|^2, \quad (2.153)$$

because the expected quantum-mechanical particle number is N_T/\hbar . We call N_T the *classical Minkowski particle number*. It is clear that

$$N_T = (\phi^{(T+)}, \phi^{(T+)})_{KG}. \quad (2.154)$$

Now, if the field ϕ vanishes in the left Rindler wedge, then it can be expanded in terms of the right Rindler modes $v_{\omega\mathbf{k}_\perp}^R$. Thus, we have

$$\phi(x) = \phi^{(R+)}(x) + \phi^{(R-)}(x), \quad (2.155)$$

where the positive-frequency part with respect to the boost Killing vector R^μ is defined by

$$\phi^{(R+)}(x) = \int_0^\infty d\omega \int d^2\mathbf{k}_\perp c_R(\omega, \mathbf{k}_\perp) v_{\omega\mathbf{k}_\perp}^R \quad (2.156)$$

for some function $c_R(\omega, \mathbf{k}_\perp)$, and the negative-frequency part is $\phi^{(R-)}(x) = [\phi^{(R+)}(x)]^*$. The Rindler energy is found by letting $X^\mu = R^\mu$ in Eq. (2.148) as

$$E_R = \int_0^\infty d\omega \int d^2\mathbf{k}_\perp \omega |c_R(\omega, \mathbf{k}_\perp)|^2. \quad (2.157)$$

¹⁵ However, we find the claim by Barut and Dowling (1990) that the Unruh effect can be explained without invoking a thermal bath rather misleading. If one were to describe physics in the Rindler wedge with the boost generator as the Hamiltonian, then the thermal bath with the temperature $a/2\pi$ would definitely be a necessary ingredient.

We can define the *classical Rindler particle number* as

$$N_R \equiv \int_0^\infty d\omega \int d^2\mathbf{k}_\perp |c_R(\omega, \mathbf{k}_\perp)|^2. \quad (2.158)$$

Then we have

$$N_R = (\phi^{(R+)}, \phi^{(R+)})_{\text{KG}}. \quad (2.159)$$

It is possible to express the Minkowski particle number N_T in terms of $c_R(\omega, \mathbf{k}_\perp)$ as follows. From Eq. (2.113) we find

$$\begin{aligned} \phi &= \int_0^\infty d\omega \int d^2\mathbf{k}_\perp [c_R(\omega, \mathbf{k}_\perp)v_{\omega\mathbf{k}_\perp}^R + c_R^*(\omega, \mathbf{k}_\perp)v_{\omega\mathbf{k}_\perp}^{R*}] \\ &= \phi^{(T+)} + \phi^{(T-)}, \end{aligned} \quad (2.160)$$

where

$$\begin{aligned} \phi^{(T+)} &= \int_0^\infty d\omega \int d^2\mathbf{k}_\perp \left[\frac{c_R(\omega, \mathbf{k}_\perp)}{\sqrt{1 - e^{-2\pi\omega/a}}} w_{-\omega\mathbf{k}_\perp} \right. \\ &\quad \left. - \frac{e^{-\pi\omega/a} c_R^*(\omega, \mathbf{k}_\perp)}{\sqrt{1 - e^{-2\pi\omega/a}}} w_{+\omega\mathbf{k}_\perp} \right]. \end{aligned} \quad (2.161)$$

Then, using Eq. (2.115), we obtain the classical Minkowski particle number as

$$\begin{aligned} N_T &= (\phi^{(T+)}, \phi^{(T+)})_{\text{KG}} \\ &= \int_0^\infty d\omega \int d^2\mathbf{k}_\perp |c_R(\omega, \mathbf{k}_\perp)|^2 \coth \frac{\pi\omega}{a}. \end{aligned} \quad (2.162)$$

Comparing this expression with that for the classical Rindler particle number (2.158), we find that the Fourier components with respect to the Rindler time τ of the classical Minkowski particle number is enhanced by a factor of $\coth(\pi\omega/a)$ in comparison to those of the classical Rindler particle number. We refer the reader to Higuchi and Matsas (1993) for the interpretation of this formula in the context of the Unruh effect.

I. Unruh effect for interacting theories and in other spacetimes

In this subsection we briefly mention some works which extend the Unruh effect to interacting field theory and other spacetimes.

Let us first discuss the work of Bisognano and Wichmann (1975, 1976), who derived the Unruh effect for (interacting) quantum field theory satisfying Wightman axioms (Jost, 1965; Streater and Wightman, 1964; Wightman, 1956). The Unruh effect was not presented as the main result in their work, and it was only several years after its publication that its connection to the Unruh effect was discovered by Sewell, who also extended their derivation of the Unruh effect to a class of spacetimes including Schwarzschild and de Sitter spacetimes (Sewell, 1982).

In order to discuss the work of Bisognano and Wichmann, it is necessary to review a mathematically more satisfactory way to define a thermal state in quantum field theory, which is called the KMS condition (Haag *et al.*, 1967). [The initials KMS stand for Kubo (1957) and Martin and Schwinger (1959).] We first explain (one version of) the KMS condition for a quantum system with a finite number of energy levels with a Hamiltonian \hat{H} and a complete set of eigenstates $|n\rangle$ with energy E_n . The expectation value of an operator \hat{A} in a thermal state with inverse temperature $\beta = 1/T$ is

$$\langle \hat{A} \rangle_\beta = \frac{\sum_n e^{-\beta E_n} \langle n | \hat{A} | n \rangle}{\sum_m e^{-\beta E_m}} = \frac{\text{Tr}(e^{-\beta \hat{H}} \hat{A})}{\text{Tr}(e^{-\beta \hat{H}})}. \quad (2.163)$$

Let \mathcal{H} be the Hilbert space spanned by $|n\rangle$. This thermal state is realized as a pure state in the Hilbert space $\mathcal{H} \otimes \mathcal{H}$ as

$$|\beta\rangle = \frac{\sum_n e^{-\beta E_n/2} |n\rangle \otimes |n\rangle}{\sqrt{\sum_m e^{-\beta E_m}}}, \quad (2.164)$$

if the operators \hat{A} on \mathcal{H} are identified with $\hat{A}^{(e)} = \hat{I} \otimes \hat{A}$, where \hat{I} is the identity operator. That is,

$$\langle \beta | \hat{A}^{(e)} | \beta \rangle = \langle \hat{A} \rangle_\beta. \quad (2.165)$$

The time-evolution operator is taken to be

$$\exp(-i\hat{H}^{(e)}\tau) = \exp(i\hat{H}\tau) \otimes \exp(-i\hat{H}\tau). \quad (2.166)$$

Now, let us define an anti-unitary involution $\hat{J}^{(e)}$ by

$$\hat{J}^{(e)} \alpha |n\rangle \otimes |m\rangle = \alpha^* |m\rangle \otimes |n\rangle, \quad (2.167)$$

where α is any c-number. Then, the operator $\hat{J}^{(e)}$ commutes with the time-evolution operator:

$$\hat{J}^{(e)} \exp(-i\hat{H}^{(e)}\tau) = \exp(-i\hat{H}^{(e)}\tau) \hat{J}^{(e)}, \quad \forall \tau \in \mathbb{R}. \quad (2.168)$$

One can also show by an explicit calculation that, for any operator \hat{A} given by a matrix as $\hat{A}|n\rangle = \sum_m |m\rangle A_{mn}$,

$$\exp(-\hat{H}^{(e)}\beta/2) \hat{A}^{(e)} |\beta\rangle = \hat{J}^{(e)} \hat{A}^{(e)\dagger} |\beta\rangle. \quad (2.169)$$

It can readily be seen that, in our model with a finite number of energy levels, Eq. (2.169) implies that the state $|\beta\rangle$ must be given by Eq. (2.164) up to an overall phase factor.

In algebraic field theory a state¹⁶ that allows a Hilbert space representation satisfying the conditions (2.168) and (2.169) is called a KMS state at inverse temperature β . Thus, the Unruh effect in algebraic field theory is the statement that the Minkowski vacuum restricted to the

¹⁶ In algebraic field theory “a state” means, roughly speaking, “a density matrix” in general.

right Rindler wedge is a KMS state at inverse temperature $\beta = 2\pi/a$ if the time-evolution is identified with a boost, which is the τ -translation in the Rindler coordinates (2.36). Remarkably, the doubling of the Hilbert space and the involution $\hat{J}^{(e)}$ in the above construction, which might look somewhat artificial in the context of statistical mechanics, naturally arise here. Thus, given the QFT in the right Rindler wedge with a boost generator as the Hamiltonian we ‘extend’ it by including the left Rindler wedge and operators acting there. The extended boost generator automatically takes the form (2.166) since the corresponding Killing vector field is past-directed in the left Rindler wedge.

In the two-dimensional model (with only the left movers) the involution $\hat{J}^{(e)}$ is defined by requiring

$$\hat{J}^{(e)}|0_M\rangle = |0_M\rangle, \quad (2.170)$$

$$\hat{J}^{(e)}\hat{a}_{+\omega}^R\hat{J}^{(e)} = \hat{a}_{+\omega}^L, \quad (2.171)$$

$$\hat{J}^{(e)}\hat{a}_{+\omega}^{R\dagger}\hat{J}^{(e)} = \hat{a}_{+\omega}^{L\dagger}. \quad (2.172)$$

Note that $[\hat{J}^{(e)}]^2 = \hat{I} \otimes \hat{I}$. The involution $\hat{J}^{(e)}$ is in fact the *PCT* transformation, i.e. the anti-unitary transformation $\hat{\Phi}(t, z) \mapsto \hat{\Phi}(-t, -z)$ in this two-dimensional model. For the four-dimensional scalar field it is the π -rotation about the z -axis times the *PCT* transformation [see Bisognano and Wichmann (1975)]. With these definitions one can readily verify that Eqs. (2.66) and (2.67) imply Eq. (2.169). The commutation relation (2.168) follows from the fact that the Lorentz boost commutes the *PCT* transformation.

The derivation of the Unruh effect by Bisognano and Wichmann (1975) using the algebraic approach was for any interacting scalar field satisfying the Wightman axioms. They also generalized this result to quantum fields of arbitrary spins (Bisognano and Wichmann, 1976). They showed that the Minkowski vacuum restricted to the right or left Rindler wedge is a KMS state as explained above. For the four-dimensional scalar field theory, for example, if $\exp(-i\hat{K}\alpha)$ is the boost operator corresponding to

$$t \mapsto t(\alpha) \equiv t \cosh \alpha a + z \sinh \alpha a, \quad (2.173)$$

$$z \mapsto z(\alpha) \equiv t \sinh \alpha a + z \cosh \alpha a, \quad (2.174)$$

then, for $\alpha = i\pi/a$, one has $(t, z) \mapsto (-t, -z)$. Bisognano and Wichmann proved, roughly speaking, that this fact translates to

$$\begin{aligned} & \exp(-\hat{K}\pi/a)\hat{\Phi}(t^{(1)}, z^{(1)}, \mathbf{x}_\perp^{(1)}) \dots \hat{\Phi}(t^{(n)}, z^{(n)}, \mathbf{x}_\perp^{(n)})|0_M\rangle \\ &= \hat{\Phi}(-t^{(1)}, -z^{(1)}, \mathbf{x}_\perp^{(1)}) \dots \hat{\Phi}(-t^{(n)}, -z^{(n)}, \mathbf{x}_\perp^{(n)})|0_M\rangle, \end{aligned} \quad (2.175)$$

where $|0_M\rangle$ is a unique Poincaré invariant vacuum, which is assumed to exist, if $(t^{(i)}, z^{(i)}, \mathbf{x}_\perp^{(i)})$, $i = 1, 2, \dots, n$, are spatially separated points in the right Rindler wedge.¹⁷

¹⁷ Bisognano and Wichmann showed that the rigorous version of

Then, they converted the relation (2.175) to the KMS condition (2.169) with $\hat{H}^{(e)} = \hat{K}$, $\beta = 2\pi/a$ and with $\hat{J}^{(e)}$ being the *PCT* operator times the π -rotation about the z -axis for operators $\hat{A}^{(e)}$ acting in the left Rindler wedge by a result similar to the Reeh-Schlieder theorem (Reeh and Schlieder, 1961).¹⁸ [See Kay (1985) for a discussion of the Bisognano-Wichmann theorem in the context of free field theory.]

Let us describe how Eq. (2.175) can be derived in the simplest case with $n = 1$ and with free (four-dimensional) scalar field. Using $\hat{K}|0_M\rangle = 0$ and $\hat{a}_{k_z \mathbf{k}_\perp}^M|0_M\rangle = 0$, we have for a real parameter α

$$\begin{aligned} & \exp(i\alpha\hat{K})\hat{\Phi}(t, z, \mathbf{x}_\perp)|0_M\rangle \\ &= \hat{\Phi}(t(\alpha), z(\alpha), \mathbf{x}_\perp)|0_M\rangle \\ &= \int \frac{d^3\mathbf{k}}{\sqrt{(2\pi)^3 2k_0}} e^{i(k_0 z - k_z t) \sinh \alpha a - i\mathbf{k}_\perp \cdot \mathbf{x}_\perp} \\ & \times e^{i(k_0 t - k_z z) \cosh \alpha a} \hat{a}_{k_z \mathbf{k}_\perp}^{M\dagger}|0_M\rangle, \end{aligned} \quad (2.176)$$

where $t(\alpha)$ and $z(\alpha)$ are defined by Eqs. (2.173) and (2.174), respectively. It can be shown that the variable α can be analytically continued from 0 to $i\pi/a$ if $z > |t|$, i.e. if the point (t, z, \mathbf{x}_\perp) is in the right Rindler wedge.¹⁹ Thus,

$$\exp(-\hat{K}\pi/a)\hat{\Phi}(t, z, \mathbf{x}_\perp)|0_M\rangle = \hat{\Phi}(-t, -z, \mathbf{x}_\perp)|0_M\rangle, \quad (2.177)$$

if the point (t, z, \mathbf{x}_\perp) is in the right Rindler wedge. This is indeed Eq. (2.175) with $n = 1$ for a free field. Noting that the point $(-t, -z, \mathbf{x}_\perp)$ is in the left Rindler wedge and using the expansion (2.96) of the field $\hat{\Phi}$ in terms of the Rindler modes, one can readily deduce from Eq. (2.177) the relations (2.100) and (2.101), which were crucial in showing the Unruh effect.

Unruh and Weiss (1984) derived the Unruh effect for the scalar field theory with arbitrary potential term $V(\hat{\Phi})$ in the path integral approach. [They also discussed the Unruh effect for spinors. See also Gibbons and Perry (1976).] Here we present their argument, for the two-dimensional scalar field for simplicity of notation, in a slightly modified manner. What needs to be shown is

Eq. (2.175) makes sense, i.e. that states obtained by multiplying $|0_M\rangle$ by a finite number of operators of the form $\int d^4x f(x)\hat{\Phi}(x)$, where $f(x)$ has support in the right Rindler wedge, is in the domain of the operator $\exp(-\beta\hat{K})$ for $0 \leq \beta \leq \pi/a$.

¹⁸ This theorem states, roughly speaking, that any state in the Hilbert space of the scalar field theory can be approximated by applying polynomials of operators of the form $\int d^4x f(x)\hat{\Phi}(x)$ on the vacuum state $|0_M\rangle$, where $f(x)$ have support in a finite spacetime region.

¹⁹ To be precise, one needs to consider the inner product of the state in Eq. (2.176) with a normalized one-particle state. Note that the modulus of $e^{i(k_0 z - k_z z) \sinh \alpha a}$ in this equation is always less than or equal to 1 if α is between 0 and $i\pi/a$. This fact is essential in showing that this analytic continuation is possible.

that

$$\langle 0_M | T \left[\hat{\Phi}(x) \hat{\Phi}(x') \right] | 0_M \rangle = \frac{\text{Tr} \left\{ e^{-\beta \hat{K}} T \left[\hat{\Phi}(x) \hat{\Phi}(x') \right] \right\}}{\text{Tr}(e^{-\beta \hat{K}})}, \quad (2.178)$$

where the trace is over all states, \hat{K} is the boost operator defined above and $\beta = 2\pi/a$. The argument for a similar equality involving an n -point function with arbitrary n is almost identical.

The Lagrangian density for the scalar field with potential $V(\phi)$ is

$$\mathcal{L} = [(\partial\phi/\partial t)^2 - (\partial\phi/\partial z)^2]/2 - V(\phi). \quad (2.179)$$

In the Rindler coordinates given by Eq. (2.34) with $\eta = a\tau$, i.e.

$$t = \rho \sinh a\tau, \quad z = \rho \cosh a\tau, \quad (2.180)$$

this Lagrangian density is given by

$$\mathcal{L} = a\rho \left[\frac{1}{2a^2\rho^2} \left(\frac{\partial\phi}{\partial\tau} \right)^2 - \frac{1}{2} \left(\frac{\partial\phi}{\partial\rho} \right)^2 - V(\phi) \right]. \quad (2.181)$$

Define the Euclidean action by letting $\tau = -i\tau_e$ as

$$\begin{aligned} S_E^R(\beta) &\equiv - \int_0^\beta d\tau_e \int_0^\infty d\rho \mathcal{L}_{(\tau=-i\tau_e)} \\ &= \int_0^\beta a d\tau_e \int_0^\infty d\rho \rho \\ &\quad \times \left[\frac{1}{2} \left(\frac{\partial\phi}{\partial\rho} \right)^2 + \frac{1}{2\rho^2} \left(\frac{1}{a} \frac{\partial\phi}{\partial\tau_e} \right)^2 + V(\phi) \right], \end{aligned} \quad (2.182)$$

where $\phi(\tau_e + \beta, \rho) = \phi(\tau_e, \rho)$. It is well known [see, e.g., Bernard (1974)] that the right-hand side of Eq. (2.178) for an arbitrary value of β is obtained by the analytic continuation $\tau_e = i\tau$ of the following expression:

$$\begin{aligned} D_\beta(x_e, x'_e) &\equiv \frac{\int_{\phi(\tau_e=0)=\phi(\tau_e=\beta)} [D\phi] \phi(x_e) \phi(x'_e) \exp[-S_E^R(\beta)]}{\int_{\phi(\tau_e=0)=\phi(\tau_e=\beta)} [D\phi] \exp[-S_E^R(\beta)]}, \end{aligned} \quad (2.183)$$

where $x_e = (t_e, z_e)$ is obtained from Eq. (2.180) as

$$t_e = \rho \sin a\tau_e, \quad z_e = \rho \cos a\tau_e. \quad (2.184)$$

These equations show that the Euclideanized right Rindler wedge is the two-dimensional Euclidean space expressed in polar coordinates if $0 \leq a\tau_e \leq 2\pi$, i.e. if $\beta = 2\pi/a$. Thus, one has

$$\begin{aligned} S_E^R(2\pi/a) &= S_E \\ &\equiv \int_{-\infty}^\infty dt_e \int_{-\infty}^\infty dz_e \\ &\quad \times \left[\left(\frac{\partial\phi}{\partial t_e} \right)^2 + \left(\frac{\partial\phi}{\partial z_e} \right)^2 + V(\phi) \right]. \end{aligned} \quad (2.185)$$

Hence,

$$D_{2\pi/a}(x_e; x'_e) = \frac{\int [D\phi] \phi(x_e) \phi(x'_e) \exp(-S_E)}{\int [D\phi] \exp(-S_E)}. \quad (2.186)$$

It is well known that the time-ordered two-point function in (two-dimensional) Minkowski spacetime, i.e. the left-hand side of Eq. (2.178), is obtained from the right-hand side of Eq. (2.186) by the analytic continuation $t_e = it$. Since both sides of Eq. (2.178) are obtained by the analytic continuation of the same function $D_{2\pi/a}(x_e; x'_e)$ with $x_e = (t_e, z_e) = (it, z)$, Eq. (2.178) holds.

The analog of the Unruh effect in Schwarzschild spacetime was first derived by Hartle and Hawking (1976) using analytic properties of the time-ordered two-point function for scalar and other free fields. They showed that the physically-acceptable²⁰ vacuum state invariant under the time-translation in the Kruskal extension (Kruskal, 1960) of Schwarzschild spacetime with mass M is a thermal state of temperature $1/8\pi M$. This result obviously has very close connection to the Hawking effect (Hawking, 1974). A similar method was used by Gibbons and Hawking (1977) to show that the physically-acceptable de Sitter-invariant vacuum state of the free scalar field in de Sitter spacetime with Hubble constant H is a thermal state of temperature $H/2\pi$ of the theory inside the cosmological horizon with the de Sitter boost generator fixing the horizon as the Hamiltonian. Narnhofer *et al.* (1996) found that an accelerated detector with acceleration a in de Sitter spacetime responds as if it was in a thermal bath of temperature $(H^2 + a^2)^{1/2}/2\pi$, and Deser and Levin (1997) obtained a similar result in anti-de Sitter spacetime. Interestingly, they found that the temperature is equal to the Unruh temperature corresponding to the acceleration of the detector in 5-dimensional Minkowski spacetime in which (anti-)de Sitter spacetime is embedded. Jacobson (1998) gives a simple explanation of these results, and Buchholz and Schlemmer (2007) discuss them in the context of their definition of a local temperature. For some work related to the response rate of the Unruh-DeWitt detector in de Sitter spacetime, see, e.g., Higuchi (1987) and Garbrecht and Prokopec (2004a,b). The Bisognano-Wichmann result was also extended to Schwarzschild and de Sitter spacetimes by Sewell as mentioned before.

Kay and Wald (1991) proved the analog of the Unruh effect in a class of spacetimes with bifurcate Killing horizons (Boyer, 1969) adopting the viewpoint that Hadamard states are the only physical states for the free scalar field theory. They showed that the Wightman two-

²⁰ The condition for ‘‘physical acceptability’’ here is essentially the so-called *Hadamard condition*. See Wald (1978) and Fulling *et al.* (1978) for an early use of this condition.

point function $\Delta(x; x')$ on the horizon satisfies

$$\partial_U \partial_{U'} \Delta(U, s; U', s') = -\frac{1}{4\pi} \frac{1}{(U - U' - i\varepsilon)^2} \delta^2(s, s') \quad (2.187)$$

with $x = (U, s)$, where s parametrizes the null geodesics on the Killing horizon and where U is an affine parameter on each geodesic, for a Hadamard state invariant under the Killing symmetry. This formula allowed them to show that, if such a state exists, it must be unique. Then they applied essentially the same argument as for the massless scalar field theory in the two-dimensional Rindler wedges to derive the Unruh-like effect. [See also Kay (1993, 2001) for further developments and a brief account of this result.]

III. APPLICATIONS

In this section we review some works using the Unruh effect to examine some selected phenomena. We begin by discussing each phenomenon using plain quantum field theory adapted to inertial observers, and then we show how the same observables can be recalculated from the point of view of Rindler observers with the help of the Unruh effect. The first example is connected with the excitation of accelerated detectors and atoms, the second one with the weak decay of non-inertial protons and the third one with the interpretation of the radiation emitted by charges from the point of view of uniformly accelerated observers. In particular we clarify the traditional question whether or not uniformly accelerated charges emit radiation from the point of view coaccelerated observers.

A. Unruh-DeWitt detectors

Models of photon detectors have been discussed for some time in quantum optics (Glauber, 1963). Unruh (1976) has introduced a detector model consisting of a small box containing a non-relativistic particle satisfying the Schrödinger equation. The system is said to have detected a quantum if the particle in the box jumps from the ground state to some excited state. In the same paper, Unruh also discusses a relativistic detector model [see also Sanchez (1981) for a similar model]. Here, we consider in more detail the detector model introduced by DeWitt (1979), which consists of a *two-level point monopole*. We call generically two-level point monopoles as *Unruh-DeWitt detectors* following the literature. A discussion on particle detectors with finite spatial extent can be found in Grove and Ottewill (1983).

Particle detectors have often been used to probe the Unruh thermal bath. Sometimes, however, distinct detector designs may lead to contrasting conclusions about the same given feature of the bath. For instance, Israel and Nester (1983), Sanchez (1985), Hinton *et al.* (1983) and Hinton (1983) have argued that the Unruh

thermal bath is anisotropic while Kolbenstvedt (1987), Gerlach (1983) and Grove and Ottewill (1985) have argued the opposite. It is not surprising that, in general, directionally sensitive detectors will respond differently if they are given distinct orientations. Nevertheless, the Unruh thermal bath is as isotropic as a thermal bath in equilibrium in a general static spacetime can be in the sense that Killing observers will see no net energy flux, etc. in any space direction, as is well known. In general, the temperature $\beta^{-1}|_i$ measured by a Killing observer following a curve i generated by a Killing vector will be position dependent. Two Killing observers following curves $i = 1, 2$ will have their temperatures related as

$$\beta^{-1}|_1 / \beta^{-1}|_2 = [(\zeta_\mu \zeta^\mu)|_2 / (\zeta_\mu \zeta^\mu)|_1]^{1/2},$$

where ζ^μ is the Killing vector tangent to the world line of the corresponding observer (Tolman, 1934).

Let us consider a two-level Unruh-DeWitt detector in Minkowski spacetime. The detector will be represented by a Hermitian operator \hat{m} acting on a two-dimensional Hilbert space. The excited state, $|E\rangle$, and the unexcited state, $|E_0\rangle$, are assumed to be eigenstates of the detector's Hamiltonian \hat{H} :

$$\hat{H}|E\rangle = E|E\rangle, \quad \hat{H}|E_0\rangle = E_0|E_0\rangle \quad (3.1)$$

with eigenvalues E and E_0 , respectively ($E > E_0$). The monopole is time evolved as usual:

$$\hat{m}(\tau) \equiv e^{i\hat{H}\tau} \hat{m}_0 e^{-i\hat{H}\tau}, \quad (3.2)$$

where τ is the detector's proper time. The matrix element $q \equiv \langle E | \hat{m}_0 | E_0 \rangle$ depends on the detector design.²¹

Now, let us couple our Unruh-DeWitt detector to a real massive scalar field $\hat{\Phi}(x)$ satisfying the Klein-Gordon equation $\square \hat{\Phi} + m^2 \hat{\Phi} = 0$ through the interaction action

$$\hat{S}_I = \int_{-\infty}^{\infty} d\tau \hat{m}(\tau) \hat{\Phi}[x(\tau)], \quad (3.3)$$

where $x^\mu(\tau)$ is the detector's world line. Next, we analyze the response of the detector from the point of view of inertial and Rindler observers separately. Related investigations for detectors coupled with electromagnetic and Dirac fields can be found in Boyer (1980, 1984) and Iyer and Kumar (1980), respectively.

1. Uniformly accelerated detectors in Minkowski vacuum: Inertial observer perspective

In Cartesian coordinates, $x^\mu = (t, x, y, z)$, of Minkowski spacetime the world line $x^\mu = x^\mu(\tau)$ of a uniformly accelerated detector along the z -axis with proper

²¹ Two-level point monopoles have been also successfully used to model the excitation and deexcitation of atoms (Audretsch and Müller, 1994b; Zhu and Yu, 2007).

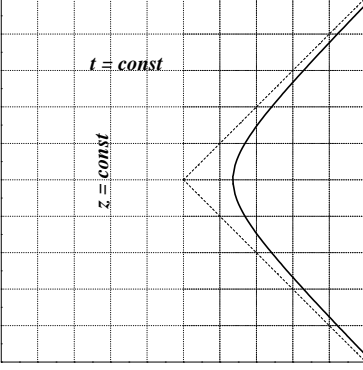

FIG. 4 The world line of a uniformly accelerated detector moving along the z -axis in the Minkowski spacetime covered with Cartesian coordinates is shown.

acceleration a is given by

$$t(\tau) = a^{-1} \sinh a\tau, \quad z(\tau) = a^{-1} \cosh a\tau \quad (3.4)$$

and $x(\tau), y(\tau) = \text{const}$ (see Fig. 4).

Let us expand $\hat{\Phi}(x)$ in terms of positive- and negative-energy eigenstates of the Hamiltonian $\hat{H} = i\partial/\partial t$, associated with inertial observers, as [see Sec. (II.D)]

$$\hat{\Phi}(x) = \int d^3\mathbf{k} (u_{\mathbf{k}} \hat{a}_{\mathbf{k}}^M + \text{H.c.}), \quad (3.5)$$

where

$$u_{\mathbf{k}} = [2\omega(2\pi)^3]^{-1/2} e^{-ik_{\mu}x^{\mu}} \quad (3.6)$$

with $k^{\mu} = (\omega, \mathbf{k})$, $\omega = \sqrt{\mathbf{k}^2 + m^2}$ and

$$[\hat{a}_{\mathbf{k}}^M, \hat{a}_{\mathbf{k}'}^{M\dagger}] = \delta^3(\mathbf{k} - \mathbf{k}').$$

The proper excitation rate, i.e. the excitation probability divided by the total detector *proper* time T , associated with the uniformly accelerated detector in the inertial vacuum is given by²²

$$\text{exc}R = T^{-1} \int d^3\mathbf{k} |\text{exc}\mathcal{A}_{\mathbf{k}}^{\text{em}}|^2, \quad (3.7)$$

where the excitation amplitude is (up to an arbitrary phase)

$$\begin{aligned} \text{exc}\mathcal{A}_{\mathbf{k}}^{\text{em}} &= i\langle E| \otimes \langle \mathbf{k}_M | \hat{S}_I | 0_M \rangle \otimes | E_0 \rangle \\ &= \frac{q}{(16\pi^3\omega)^{1/2}} \int_{-\infty}^{\infty} d\tau \exp(i\Delta E\tau) \\ &\times \exp[i(\omega/a) \sinh a\tau - (ik_z/a) \cosh a\tau] \end{aligned} \quad (3.8)$$

²² Often, the excitation rate is alternatively expressed in terms of the golden rule (3.52).

with $\Delta E \equiv E - E_0$. We have adopted here the subscript M to label states defined by inertial observers in Minkowski spacetime. (Note here that we are using the convention that space components of the momentum k^{μ} are given with lower indices. That is, k_x, k_y and k_z are the x - y - and z -components, respectively, of the contravariant vector k^{μ} .) We note that because Eq. (3.3) is linear in $\hat{\Phi}[x(\tau)]$, the detector excitation is accompanied by the emission of a particle²³ with momentum \mathbf{k} . By using Eq. (3.8) in Eq. (3.7), we obtain

$$\text{exc}R \equiv \int d^2\mathbf{k}_{\perp} R^{\perp}, \quad (3.9)$$

where $\mathbf{k}_{\perp} = (k_x, k_y)$ denotes the transverse momentum with respect to the direction of the acceleration, the quantity R^{\perp} is given by

$$\begin{aligned} R^{\perp} &= \frac{|q|^2}{16\pi^3 T} \int_{-\infty}^{\infty} \frac{dk_z}{\omega} \int_{-\infty}^{\infty} d\tau' \int_{-\infty}^{\infty} d\tau'' e^{i\Delta E(\tau' - \tau'')} \\ &\times e^{i\omega[\sinh a\tau' - \sinh a\tau'']/a} e^{-ik_z[\cosh a\tau' - \cosh a\tau'']/a} \\ &= \frac{|q|^2}{16\pi^3 T} \int_{-\infty}^{\infty} \frac{dk_z}{\omega} \int_{-\infty}^{\infty} d\tau \int_{-\infty}^{\infty} d\sigma e^{i\Delta E\sigma} \\ &\times e^{(2i/a) \sinh a\sigma(\omega \cosh a\tau - k_z \sinh a\tau)}, \end{aligned}$$

and we have defined $\tau \equiv (\tau' + \tau'')/2$ and $\sigma \equiv \tau' - \tau''$. Because the interaction is kept turned on for an arbitrarily long time interval, the total time T diverges. To obtain explicitly the excitation rate per unit time, the total time T must be canceled by factoring out the divergent part $\int_{-\infty}^{\infty} d\tau$ from the integrals above. To this end, we first note that the momentum of the emitted particle is boosted due to the nonzero velocity of the detector, which is τ -dependent. Hence, it is expected that the integrand can be made τ -independent by boosting back the momentum variables. Motivated by this physical picture, we introduce a new momentum variable as

$$k_z \mapsto k'_z \equiv k_z \cosh a\tau - \omega \sinh a\tau, \quad (3.10)$$

which can be inverted as

$$k'_z \mapsto k_z = k'_z \cosh a\tau + \omega' \sinh a\tau. \quad (3.11)$$

Here $\omega' \equiv [(k'_z)^2 + k_{\perp}^2 + m^2]^{1/2}$ can be expressed as

$$\omega' = \omega \cosh a\tau - k_z \sinh a\tau,$$

where $k_{\perp} \equiv \sqrt{(k_x)^2 + (k_y)^2}$. It can be shown that $dk'_z/\omega' = dk_z/\omega$. This transformation indeed allows us to factor out $T = \int_{-\infty}^{\infty} d\tau$, and we obtain

$$R^{\perp} = \frac{|q|^2}{16\pi^3} \int_{-\infty}^{\infty} \frac{dk'_z}{\omega'} \int_{-\infty}^{\infty} d\sigma e^{i\Delta E\sigma} e^{(2i\omega'/a) \sinh(a\sigma/2)}. \quad (3.12)$$

²³ This combination, i.e. excitation with particle emission, can be also observed in the anomalous Doppler effect where atoms move in media with refractive index n with velocity $v > 1/n$ (Frolov and Ginzburg, 1986).

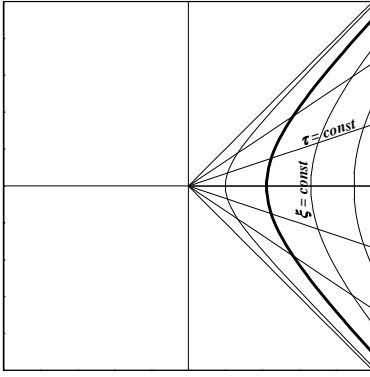

FIG. 5 The world line of a uniformly accelerated detector moving along the z -axis in Minkowski spacetime covered with Rindler coordinates is shown.

By making now a further change of variables as

$$\begin{aligned} k'_z &\mapsto \zeta \equiv (\omega' + k'_z)/\sqrt{k_\perp^2 + m^2} \\ \sigma &\mapsto \lambda \equiv \exp(a\sigma/2), \end{aligned} \quad (3.13)$$

we obtain

$$\begin{aligned} R^\perp &= \frac{|q|^2}{8\pi^3 a} \int_1^\infty \frac{d\zeta}{\zeta} \int_0^\infty d\lambda \lambda^{2i\Delta E/a-1} \\ &\times \exp[i(k_\perp^2 + m^2)^{1/2}(\lambda - \lambda^{-1})(\zeta + \zeta^{-1})/(2a)]. \end{aligned}$$

Now, we make the change of variables $\{\zeta, \lambda\} \mapsto \{\kappa, \varpi\}$ with $\kappa = \zeta\lambda$ and $\varpi = \zeta/\lambda$, and write

$$\begin{aligned} R^\perp &= \frac{|q|^2}{16\pi^3 a} \left| \int_0^\infty \frac{d\kappa}{\kappa^{1-i\Delta E/a}} e^{i(k_\perp^2 + m^2)^{1/2}(\kappa - \kappa^{-1})/(2a)} \right|^2 \\ &= \frac{|q|^2 e^{-\pi\Delta E/a}}{4\pi^3 a} \left\{ K_{i\Delta E/a}[(k_\perp^2 + m^2)^{1/2}/a] \right\}^2, \end{aligned} \quad (3.14)$$

where $K_\nu(x)$ is the modified Bessel function (Gradshteyn and Ryzhik, 1980). (We recall here that the function $K_{i\lambda}(x)$ is real if x and λ are real.) Finally, we obtain for the proper excitation rate (3.9)

$$\begin{aligned} \text{exc}R &= \frac{|q|^2 a e^{-\pi\Delta E/a}}{2\pi^2} \int_0^\infty d\mu \mu \\ &\times \left(K_{i\Delta E/a}[\sqrt{\mu^2 + (m/a)^2}] \right)^2. \end{aligned} \quad (3.15)$$

The angular distribution of the corresponding emitted particles in the massless case can be found in Kolbenstvedt (1988). Next, we shall reproduce this detector response from the point of view of Rindler observers and discuss it.

2. Uniformly accelerated detectors in Minkowski vacuum: Rindler observer perspective

The spacetime appropriate for investigating the excitation rate of our detector with proper acceleration a from

the point of view of uniformly accelerated observers is the Rindler wedge. We choose the right Rindler wedge ($z > |t|$) to work with, where we recall that it has a global timelike isometry associated with the Killing field $z\partial/\partial t + t\partial/\partial z$. By covering it with Rindler coordinates (τ, ξ, y, z) ($-\infty < \tau, \xi, x, y < +\infty$), which are related with (t, x, y, z) by Eq. (2.36), we obtain the line element of the Rindler wedge as written in Eq. (2.37).

The world lines of the Rindler observers are given by $\xi, x, y = \text{const}$ and are hyperbolas in the two-dimensional diagram of Minkowski spacetime with x and y suppressed (see Fig. 5). The corresponding four-velocity and four-acceleration are $u^\mu = e^{-a\xi}(1, 0, 0, 0)$ and $a^\mu = e^{-2a\xi}(0, a, 0, 0)$, respectively, where $a^\mu = u^\nu \nabla_\nu u^\mu$ [see, e.g., Wald (1984)]. Thus, the proper acceleration of the Rindler observers is $\sqrt{-a^\mu a_\mu} = ae^{-a\xi} = \text{const}$. Our uniformly accelerated detector with proper acceleration a will lie at $\xi = 0$ (for some $x, y = \text{const}$).

Next, we expand $\hat{\Phi}(x)$ in terms of positive- and negative-energy eigenstates of the Hamiltonian $\hat{H} = i\partial/\partial\tau$, associated with the Rindler observers, as [see Sec. (II.D)]

$$\hat{\Phi}(x) = \int d\omega d^2\mathbf{k}_\perp [v_{\omega\mathbf{k}_\perp}^R \hat{a}_{\omega\mathbf{k}_\perp}^R + \text{H.c.}], \quad (3.16)$$

where

$$v_{\omega\mathbf{k}_\perp}^R = \left[\frac{\sinh(\pi\omega/a)}{4\pi^4 a} \right]^{1/2} K_{i\omega/a} \left[\frac{\sqrt{k_\perp^2 + m^2}}{ae^{-a\xi}} \right] e^{i\mathbf{k}_\perp \cdot \mathbf{x}_\perp - i\omega\tau} \quad (3.17)$$

are Klein-Gordon orthonormalized, and we recall that the creation and annihilation operators of Rindler particles satisfy the commutation relations

$$[\hat{a}_{\omega\mathbf{k}_\perp}^R, \hat{a}_{\omega'\mathbf{k}'_\perp}^{R\dagger}] = \delta(\omega - \omega')\delta^2(\mathbf{k}_\perp - \mathbf{k}'_\perp). \quad (3.18)$$

The Rindler vacuum $|0_R\rangle$ is defined by $\hat{a}_{\omega\mathbf{k}_\perp}^R |0_R\rangle = 0$. A detector lying at rest within a uniformly accelerated cavity prepared in the Rindler vacuum is not excited (Levin *et al.*, 1992).²⁴ We emphasize that the quantum numbers $\{\omega, \mathbf{k}_\perp\}$ associated with the timelike and spacelike global Killing fields $\partial/\partial\tau$ and $\partial/\partial x$, $\partial/\partial y$, respectively, are independent of each other (see Sec. III.A.3).

Before we analyze the behavior of the detector in the *Minkowski* vacuum, we formally consider the detector's excitation probability with simultaneous emission of a Rindler particle in the *Rindler* vacuum. The amplitude associated with this process in first order of perturbation is

$$\text{exc} \mathcal{A}_{\omega\mathbf{k}_\perp}^{\text{em}} \equiv i \langle E | \otimes \langle \omega\mathbf{k}_\perp |_R \langle \hat{S}_I | 0_R \rangle \otimes | E_0 \rangle, \quad (3.19)$$

²⁴ An account on vacuum states in static spacetimes with horizons can be found in Fulling (1977).

where we recall that we use Eq. (3.16) in \hat{S}_I as given in Eq. (3.3). The differential probability associated with this amplitude is

$$dW^{\text{em}} = |\text{exc}\mathcal{A}_{\omega\mathbf{k}_\perp}^{\text{em}}|^2 d^2\mathbf{k}_\perp d\omega. \quad (3.20)$$

Now, we should take into account the fact that due to the Unruh effect the Minkowski vacuum corresponds to a thermal bath of Rindler particles. We emphasize that *the Minkowski vacuum is indistinguishable from the thermal bath built on the Rindler vacuum as long as the detector stays in the Rindler wedge* since the Minkowski vacuum is a linear combination of products of the left and right Rindler states. For this reason, the detector's excitation rate with simultaneous emission of a Rindler particle into the *Minkowski* vacuum is given by Eq. (3.20) combined with the proper thermal factor [see Eq. (4.9) in Higuchi *et al.* (1992a) for more details]:

$$\text{exc}R^{\text{em}} = T^{-1} \int dW^{\text{em}} [1 + n(\omega)], \quad (3.21)$$

where

$$n(\omega) = 1/[\exp(\beta\omega) - 1] \quad (3.22)$$

is the Rindler scalar particle number density in the momentum space. Here $\beta^{-1} = a/2\pi$ is the Unruh temperature as measured by Rindler observers at $\xi = 0$. The first and second terms in the square brackets in Eq. (3.21) are associated with spontaneous and induced emission, respectively.

Similarly, one can calculate the detector's excitation rate with simultaneous absorption of a Rindler particle from the Unruh thermal bath as

$$\text{exc}R^{\text{abs}} = T^{-1} \int dW^{\text{abs}} n(\omega), \quad (3.23)$$

where

$$dW^{\text{abs}} \equiv |\text{exc}\mathcal{A}_{\omega\mathbf{k}_\perp}^{\text{abs}}|^2 d^2\mathbf{k}_\perp d\omega \quad (3.24)$$

and

$$\text{exc}\mathcal{A}_{\omega\mathbf{k}_\perp}^{\text{abs}} \equiv i\langle E| \otimes \langle 0_R | \hat{S}_I | \omega\mathbf{k}_\perp R \rangle \otimes | E_0 \rangle \quad (3.25)$$

is the excitation amplitude with absorption of a Rindler particle $|\omega\mathbf{k}_\perp R\rangle$. The excitation amplitudes (3.19) and (3.25) can be shown to be

$$\begin{aligned} \text{exc}\mathcal{A}_{\omega\mathbf{k}_\perp}^{\text{em(abs)}} &= q \int_{-\infty}^{\infty} d\tau \exp[i\mathbf{k}_\perp \cdot \mathbf{x}_\perp + i(\Delta E + (-)\omega)\tau] \\ &\times \left[\frac{\sinh(\pi\omega/a)}{4\pi^4 a} \right]^{1/2} K_{i\omega/a} \left(\frac{(k_\perp^2 + m^2)^{1/2} e^{a\xi}}{a} \right) \end{aligned} \quad (3.26)$$

up to some multiplicative phase. It is easy to verify in this case that $\text{exc}\mathcal{A}_{\omega\mathbf{k}_\perp}^{\text{em}} = 0$, as expected, since uniformly accelerated detectors are static according to Rindler observers. Hence, according to these observers the only

contribution to the detector response comes from the absorption of Rindler particles from the Unruh thermal bath.

Now, since in first order of perturbation there is no interference, the total detector excitation rate in the *Minkowski* vacuum is

$$\text{exc}R = \text{exc}R^{\text{em}} + \text{exc}R^{\text{abs}}. \quad (3.27)$$

By using Eq. (3.26) to calculate Eq. (3.27), we get Eq. (3.15), as expected. Of course, inertial and Rindler observers must agree on the value of scalar observables, such as the *proper* excitation rate of a given detector, although they can differ in how they describe the phenomenon. Because inertial and Rindler observers would expand the quantum fields with different sets of normal modes, they would end up extracting different particle contents from the same field theory. As a result, it is natural for *inertial* and *Rindler* observers to describe the detector excitation as being accompanied by the *emission* of a *Minkowski* particle and by the *absorption* of a *Rindler* particle from the *Unruh thermal bath* (Unruh and Wald, 1984), respectively. This conclusion can be generalized for detectors confined in the Rindler wedge following *general world lines* by saying that the detector excitation which is associated with the emission of a Minkowski particle as described by *inertial* observers corresponds in this case to the absorption *or* emission of a Rindler particle from *or* to the Unruh thermal bath according to Rindler observers (Matsas, 1996).

Let us comment on one possible source of confusion concerning the Unruh-DeWitt detector. A naive (and wrong) application of the equivalence principle might lead to the conclusion that an inertial detector which has the same velocity as an accelerated one at a certain time would detect Unruh radiation. This is of course not the case: no detector in an inertial motion detects any Unruh radiation.

Before proceeding further, we note for later purposes that in the particular case with $m = 0$, Eq. (3.15) takes the form

$$\text{exc}R^{m=0} = \frac{|q|^2}{2\pi} \frac{\Delta E}{e^{\beta\Delta E} - 1}. \quad (3.28)$$

3. Rindler particles with frequency $\omega < m$

Here we discuss in more detail the existence of Rindler particles with frequencies $\omega < m$, which was crucial in the whole discussion above (notice, e.g., that the range of the ω integrations in Eqs. (3.21) and (3.23) is $0 < \omega < +\infty$). The standard theory of quantum fields uses the fact that Minkowski spacetime is invariant under time and space translations. The linear three-momentum (k_x, k_y, k_z) associated with the translational isometries on the space-like hypersurfaces $t = \text{const}$ constitutes a suitable set of quantum numbers to label free particles. In this simple case, the dispersion relation $E \equiv \hbar\omega = \sqrt{|\mathbf{p}c|^2 + m^2 c^4}$

imposes a simple constraint between the particle mass m , momentum \mathbf{p} and energy E , and, thus, free particles with well-defined linear momenta must have total energy $E \geq mc^2$. Moreover, in the classical context of General Relativity, the detection *in loco* of *point* particles satisfying $E < mc^2$ by direct capture is ruled out by the fact that an observer with four-velocity u^μ intercepting a particle with four-momentum $p^\mu = mv^\mu$ assigns to the particle an energy $E = mv^\mu u_\mu \geq mc^2$.

On the other hand, it is well known that the field quantization carried over arbitrary spacetime does not lead in general to any dispersion relation connecting the frequency with other quantum numbers, avoiding thus the flat spacetime constraint $E \geq mc^2$. This can be understood by recalling that, strictly speaking, the concept of *point particle* has no place in Quantum Field Theory. This raises the following question: What is the probability density associated with the detection of particles with $E < mc^2$, i.e. $\omega < m$, at different space points of the Rindler wedge? By answering this question, we can also extract some information about the particle distribution of the Hawking radiation near the event horizon of black holes. Indeed, much insight into the Hawking effect can be obtained in the simplified context provided by the Rindler wedge as we shall see next. [We refer the reader to Castiñeiras *et al.* (2002) for more details.]

Let us start by considering the line element of a two-dimensional Schwarzschild spacetime:

$$ds^2 = (1 - 2M/r) dt^2 - (1 - 2M/r)^{-1} dr^2. \quad (3.29)$$

This can be seen as describing a two-dimensional black hole²⁵ with mass M . Close to the horizon, $r \approx 2M$, it can be written as

$$ds^2 = (\rho/4M)^2 dt^2 - d\rho^2, \quad (3.30)$$

where $\rho(r) \equiv \sqrt{8M(r - 2M)}$. (Note that in these coordinates the horizon is at $\rho = 0$.) One can identify Eq. (3.30) with the line element of the Rindler wedge (2.37) with $x, y = \text{const}$ by letting $t = 4Ma\tau$ and $\rho = e^{a\xi}/a$ provided that $0 < \rho < +\infty$ and $-\infty < t < +\infty$.

From here to the end of this subsection we shall be considering the spacetime of the Rindler wedge with line element (3.30), where $0 < \rho < +\infty$ and $-\infty < t < +\infty$. Now, let us choose a *fiducial observer* at $\rho = \rho_0 = 4M$, whose proper time is t [see Eq. (3.30)], with respect to whom the particle's energy is to be measured. He/she defines the total probability $P_\omega(\rho_d)$ of detecting a particle at some point $\rho = \rho_d$ with energy ω per (detector) proper

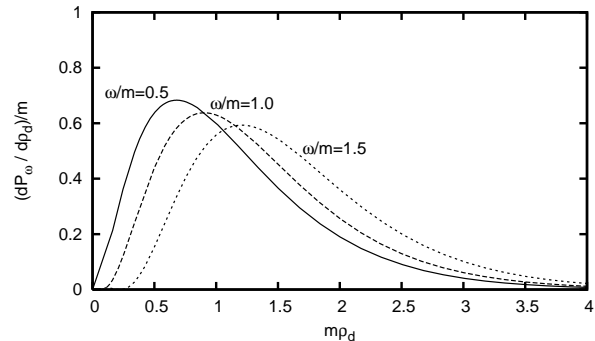

FIG. 6 We plot the probability density $d\mathcal{P}_\omega/d\rho_d$ for different ω/m ratios, where we have let $Mm = 1/4$. We note that the smaller the ω/m ratio, the closer to the horizon (on average) the particle lies, where the “gravitational potential” is lower.

time s_d^{tot} as $\Gamma_\omega(\rho_d) \equiv P_\omega(\rho_d)/s_d^{\text{tot}}$. Then, the normalized probability density is

$$\frac{d\mathcal{P}_\omega}{d\rho_d} \equiv \Gamma_\omega(\rho_d) \left[\int_0^{+\infty} \Gamma_\omega(\rho'_d) d\rho'_d \right]^{-1}, \quad (3.31)$$

where $(d\mathcal{P}_\omega/d\rho_d)d\rho_d$ is the probability that a particle with energy ω is found between ρ_d and $\rho_d + d\rho_d$. Observers far away from the horizon will be able to interact only with the “tail” of the “wave functions” associated with particles with small ω/m . The smaller the ω/m , the more difficult it is to detect these particles.

Now, in order to interpret Eq. (3.31) in the frame work of General Relativity, let us first consider a row of detectors, each of them lying at different ρ_d , and define the *average detection position*

$$\langle \rho_d \rangle \equiv \int_0^{+\infty} d\rho_d \rho_d \frac{d\mathcal{P}_\omega}{d\rho_d}. \quad (3.32)$$

By using Eq. (3.31), this can be shown to be (see Fig. 6)

$$\begin{aligned} \langle \rho_d \rangle &= \frac{\pi \tanh(4\pi M\omega)(64M^2\omega^2 + 1)}{64mM\omega} \\ &\approx \pi M\omega/m \quad (\omega \gg a), \end{aligned} \quad (3.33)$$

where $a \equiv 1/4M$ is the proper acceleration of the fiducial observer. On the other hand, from General Relativity, a classical particle with mass m lying at rest at some point ρ_p has, according to our fiducial observer at $\rho_0 = 4M$, energy $\omega = m\rho_p/4M$. By considering that the particle may have some kinetic energy in addition, the total energy would be $\omega \geq m\rho_p/4M$. From this equation, we obtain

$$\rho_p \leq 4M\omega/m \equiv \rho_p^{\text{max}}. \quad (3.34)$$

This is expected to agree with $\langle \rho_d \rangle$, i.e. $\langle \rho_d \rangle \leq \rho_p^{\text{max}}$, at least in the “high-frequency” regime $\omega \gg a$ (where the quantum and classical behaviors may be compared). This conclusion is indeed in agreement with Eqs. (3.33)

²⁵ The vacuum expectation value of the energy-momentum tensor for a massless scalar field in this spacetime was analyzed by Davies *et al.* (1976) [see also Davies (1976) and Davies and Fulling (1977a)]. See Christensen and Fulling (1977) for a comprehensive discussion on this issue and Candelas and Dowker (1979) for further considerations.

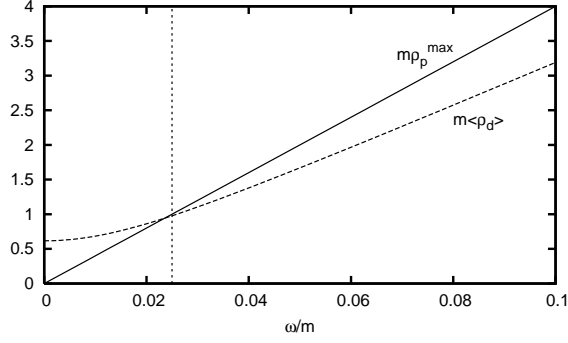

FIG. 7 $\langle \rho_d \rangle$ is shown to be smaller than $\rho_p^{\max} \equiv 4M\omega/m$ in the “high-frequency” regime $\omega > (4M)^{-1}$ (i.e. at the right of the vertical broken line) just as expected. (We have let $mM = 10$ here but this nice agreement is verified for any mM .)

and (3.34) as seen in Fig. 7. In summary, the smaller the ω/m ratio, the more likely the observer is to detect the particle closer to the horizon.

4. Static detectors in a thermal bath of Minkowski particles

Now, we shall show explicitly that the response rate (3.15) does not correspond to the one obtained when the detector lies at rest in a plain thermal bath of Minkowski particles heated up to the Unruh temperature $\beta^{-1} = a/(2\pi)$. In the latter case, the excitation rate is obtained by replacing Eq. (3.7) by

$$\text{exc}R^\beta \equiv T^{-1} \int d^3\mathbf{k} [|\text{exc}\mathcal{A}_{\mathbf{k}}^{\text{em}}|^2 [1 + n(\omega)] + |\text{exc}\mathcal{A}_{\mathbf{k}}^{\text{abs}}|^2 n(\omega)], \quad (3.35)$$

where $n(\omega) = 1/(\exp(\beta\omega) - 1)$ and

$$\begin{aligned} \text{exc}\mathcal{A}_{\mathbf{k}}^{\text{em}} &\equiv i\langle E | \otimes \langle \mathbf{k}_M | \hat{S}_I | 0_M \rangle \otimes | E_0 \rangle, \\ \text{exc}\mathcal{A}_{\mathbf{k}}^{\text{abs}} &\equiv i\langle E | \otimes \langle 0_M | \hat{S}_I | \mathbf{k}_M \rangle \otimes | E_0 \rangle \end{aligned}$$

are the excitation amplitudes with emission and absorption of Minkowski particles $|\mathbf{k}_M\rangle$, respectively. In this case, the excitation amplitudes can be shown to be (up to an arbitrary multiplicative phase)

$$\text{exc}\mathcal{A}_{\mathbf{k}}^{\text{em(abs)}} = q\delta(\omega + (-)\Delta E)/\sqrt{4\pi\omega}, \quad (3.36)$$

where we have assumed with no loss of generality that the detector is at the origin $\mathbf{x} = 0$. Clearly, $\text{exc}\mathcal{A}_{\mathbf{k}}^{\text{em}} = 0$. Hence, the only contribution to the detector response is associated with the absorption of a Minkowski particle. By substituting Eq. (3.36) in Eq. (3.35), we obtain

$$\text{exc}R^\beta = \frac{|q|^2 \Delta E \theta(\Delta E - m)}{2\pi e^{\beta\Delta E} - 1}. \quad (3.37)$$

The presence of the step function $\theta(\Delta E - m)$ expresses the fact that the detector can only be excited if its energy

gap is large enough to absorb massive scalar particles from the thermal bath. Clearly $\text{exc}R^\beta$ in Eq. (3.37) with $\beta^{-1} = a/(2\pi)$ and $\text{exc}R$ in Eq. (3.15) are distinct. Indeed, there is no *a priori* reason why they should be the same. Incidentally, in the case $m = 0$, Eqs. (3.37) and (3.28) equal each other. However, this is a coincidence, which has to do with the particular design of the detector and not with the Unruh effect. As we have seen, what the Unruh effect does say is something else. In particular, we have shown in Sec. III.A.2 how to recover Eq. (3.15) from the point of view of Rindler observers.

In spite of the model dependence of the response rate, the Unruh effect allows one to establish a relationship between the excitation and deexcitation rates (assuming that they are well defined), which is independent of the detector model. Because of unitarity, the absolute value of the excitation amplitude (associated with the absorption of a Rindler particle),

$$|\text{exc}\mathcal{A}^{\text{abs}}| \equiv |\langle E | \otimes \langle 0_R | \hat{S}_I | \omega \mathbf{k}_\perp R \rangle \otimes | E_0 \rangle| \propto \delta(\omega - \Delta E), \quad (3.38)$$

must equal the absolute value of the deexcitation amplitude (associated with the emission of a Rindler particle),

$$|\text{deexc}\mathcal{A}^{\text{em}}| \equiv |\langle E_0 | \otimes \langle \omega \mathbf{k}_\perp R | \hat{S}_I | 0_R \rangle \otimes | E \rangle| \propto \delta(\omega - \Delta E). \quad (3.39)$$

Hence, we obtain from the discussion in Sec. III.A.2 that the ratio of the excitation and deexcitation rates must be given by

$$\frac{\text{exc}R}{\text{deexc}R} = \frac{n(\Delta E)}{1 + n(\Delta E)} = e^{-\beta\Delta E}. \quad (3.40)$$

This quite universal relation is also called *principle of detailed balance*, and clearly holds for detectors lying at rest in a thermal bath of Minkowski particles at the same temperature²⁶ provided that $\Delta E \geq m$. For $\Delta E < m$, the ratio $\text{exc}R/\text{deexc}R$ is not well defined for the thermal bath in Minkowski spacetime since the excitation and deexcitation rates vanish. It is worthwhile to emphasize, however, that deviations from the hyperbolic motion because of backreaction or other effects will in general disturb Eq. (3.40) with no contradiction to the Unruh effect, contrary to some recent claims (Belinskii *et al.*, 1997; Fedotov *et al.*, 1999).

5. About the discussion whether or not uniformly accelerated sources radiate

Some controversy has appeared in the literature about whether or not uniformly accelerated detectors and

²⁶ Boyer (1980, 1984) has concluded in the context of *stochastic electrodynamics* that a classical electric dipole oscillator accelerating through *classical electromagnetic zero-point radiation* responds as would a dipole oscillator in an inertial frame in classical thermal radiation with temperature $a/(2\pi)$ in agreement with Eq. (3.40) [see also Cole (1985)].

sources emit radiation according to inertial observers.²⁷ This is sometimes called *Unruh radiation* (although, this terminology has also been used to mean something else [see Sec. IV.D]). Indeed, the conclusion that the excitation of a uniformly accelerated detector is accompanied by the emission of a Minkowski particle according to inertial observers and absorption of a Rindler particle from the Unruh thermal bath according to Rindler observers (Unruh and Wald, 1984) was not unanimously accepted in the beginning (Padmanabhan, 1985). Grove (1986) claimed that a constantly accelerated object would emit negative- rather than positive-energy radiation as seen by inertial observers. Similar conclusions were reached by Massar *et al.* (1993). Later, the excitation of uniformly accelerated detectors in the Minkowski vacuum was said to give rise to no energy flux²⁸ according to inertial observers, supporting previous conclusion due to Raine *et al.* (1991). More recently Parentani (1995) and Massar and Parentani (1996) stated that, although the mean flux vanishes, once the thermal equilibrium is reached, each detector transition is indeed accompanied by the emission of a Minkowski particle.

The controversy above was revisited by Unruh (1992), who concluded that uniformly accelerated oscillators do alter the measurable properties of the field. Ascribing these changes to “*radiation*” or “*vacuum fluctuation*” would be a terminology issue. This viewpoint is in agreement with Audretsch and Müller (1994a) who argued that the key to the seemingly contradictory results lies in the distinction between the different questions stated implicitly in the various approaches.²⁹

6. Other results concerning the Unruh-DeWitt detector

The emission rates obtained in the previous subsections, which use detectors accelerated uniformly for all times, should be seen as approximations to those obtained in real physical situations where the detectors are accelerated and interacting for long enough. Svaiter and Svaiter (1992) considered the Unruh-DeWitt detector that was turned on only for a finite time. This model might appear physical but they obtained a transition probability which was logarithmically divergent although the transition rate, the time-derivative of the transition probability, was found to be finite. [See also Sriramkumar and Padmanabhan (1996).]

In order to find the cause of this divergence and confirm that the transition rate obtained with uniform ac-

celeration is a good approximation to that for a detector model turned on only for a finite time, Higuchi *et al.* (1993) modified the interaction action (3.3) as follows:

$$\hat{S}_I = \int_{-\infty}^{\infty} d\tau c(\tau) \hat{m}(\tau) \hat{\Phi}[x(\tau)] \quad (3.41)$$

where the function

$$c(\tau) \equiv \begin{cases} e^{\alpha(\tau+T)} & \tau < -T \\ 1 & -T \leq \tau \leq T \\ e^{-\alpha(\tau-T)} & \tau > T \end{cases}, \quad (3.42)$$

with $\alpha = \text{const}$, has been inserted to switch on and off the detector continuously as $\tau \rightarrow -\infty$ and $\tau \rightarrow \infty$, respectively. The field $\hat{\Phi}(x)$ is assumed to be a *massless* scalar field for simplicity. The excitation rate is calculated in the Rindler frame. Eq. (3.27) for the interaction (3.41) takes the form

$$\begin{aligned} \text{exc}R_T &= \text{exc}R_T^{\text{em}} + \text{exc}R_T^{\text{abs}} \\ &= |q|^2 (I^{\text{sp}} + I^{\text{in}} + I^{\text{abs}}) / (4\pi^2 T^{\text{tot}}), \end{aligned} \quad (3.43)$$

where $T^{\text{tot}} \equiv 2T$. Here

$$I^{\text{sp}} = \int_0^{\infty} d\omega \omega B(\omega), \quad (3.44)$$

$$I^{\text{in}} = \int_0^{\infty} d\omega g(\omega) B(\omega), \quad (3.45)$$

$$I^{\text{abs}} = \int_0^{\infty} d\omega g(\omega) B(-\omega), \quad (3.46)$$

are associated with the spontaneous emission, induced emission and absorption probabilities, respectively, with

$$\begin{aligned} B(\omega) &\equiv \frac{4 \sin^2(\omega + \Delta E)T}{(\omega + \Delta E)^2} - \frac{4 \sin^2(\omega + \Delta E)T}{\alpha^2 + (\omega + \Delta E)^2} \\ &+ \frac{4\alpha^2 \cos 2(\omega + \Delta E)T}{[\alpha^2 + (\omega + \Delta E)^2]^2} \\ &+ \frac{4\alpha^3 \sin 2(\omega + \Delta E)T}{(\omega + \Delta E)[\alpha^2 + (\omega + \Delta E)^2]^2}, \end{aligned} \quad (3.47)$$

and $g(\omega) \equiv \omega n(\omega) = \omega [e^{2\pi\omega/a} - 1]^{-1}$. It is easy to see that the integrands for I^{sp} , I^{in} and I^{abs} in Eqs. (3.44)-(3.46) do not diverge at any value of ω . Also, the integrands for I^{in} and I^{abs} tend to zero exponentially as $\omega \rightarrow \infty$, and the leading term of the asymptotic expansion (for $\omega \gg \Delta E, \alpha, a$) of the integrand for I^{sp} is $4\alpha^2 \omega^{-3} \cos^2 \omega T$. Thus, $\text{exc}R_T$ in Eq. (3.43) is clearly finite. Now, suppose we switch on and off the detector instantaneously, in such a way that it only interacts with the field during the interval $-T < \tau < T$. This setup corresponds to the limit $\alpha \rightarrow +\infty$ [see Eq. (3.42)]. In this regime the integrand for I^{sp} behaves asymptotically like $4\omega^{-1} \sin^2 \omega T$, giving rise to a logarithmic ultraviolet divergence in $\text{exc}R_T$ found by Svaiter and Svaiter. In a physical situation where we have a finite α and large T (i.e. $T \gg a^{-1}, \alpha^{-1}, \Delta E^{-1}$), one finds

$$\text{exc}R_T \approx \frac{|q|^2}{2\pi} \frac{\Delta E}{e^{\beta \Delta E} - 1}, \quad (3.48)$$

²⁷ See Sec. III.C.1 for some related remarks concerning electric charges.

²⁸ See, e.g., Ford and O’Connell (2006); Hinterleitner (1993); Hu and Roura (2004); Hu *et al.* (2004). A reply to Hu and Roura (2004) can be found in Scully *et al.* (2004). See also Sec. IV.C for some further remarks.

²⁹ More discussions on this issue can be found in Lin and Hu (2006).

recovering the Planckian excitation rate (3.28). Thus, the logarithmic divergence appears when we take the $\alpha \rightarrow +\infty$ limit with finite T . This divergence would not appear if we took $T \rightarrow +\infty$ from the beginning. In this case the absence of the logarithmic divergence could be attributed to the fact that the switching on and off would be moved away to infinite past and future, respectively.

The good ultraviolet behavior of the detector's total excitation probability ${}^{\text{exc}}R_T$ does not depend sensitively on the particular choice of the function $c(\tau)$ provided that $c(\tau)$ is at least continuous. It would be interesting to see if the results obtained for finite-time *detectors* and for finite-lifetime *observers* (Martinetti and Rovelli, 2003) are related.

Recently Louko and Satz (2006) have found a formula for the excitation rate of the Unruh-DeWitt detector with any trajectory in Minkowski spacetime for the massless scalar field, building on works by Schlicht (2004) and Langlois (2005, 2006). If the trajectory is $x^\mu(\tau)$, where τ is the proper time, and if the detector is turned on at $\tau = \tau_0$, then the Louko-Satz formula for the excitation rate at proper time τ is

$$R_{\text{LS}} = |q|^2 \left\{ -\frac{\Delta E}{4\pi} + \frac{1}{2\pi^2} \int_0^{\tau-\tau_0} ds \left[\frac{1}{s^2} - \frac{\cos(s\Delta E)}{(\Delta x)^2} \right] + \frac{1}{2\pi^2(\tau-\tau_0)} \right\}, \quad (3.49)$$

where $\Delta x^\mu \equiv x^\mu(\tau) - x^\mu(\tau - s)$. The transition probability obtained by integrating R_{LS} from τ_0 to a given time is indeed logarithmically divergent because of the last term. In the limit $\tau_0 \rightarrow -\infty$ they find

$$\lim_{\tau_0 \rightarrow -\infty} R_{\text{LS}} = |q|^2 \left\{ -\frac{\Delta E}{2\pi} \theta(-\Delta E) + \frac{1}{2\pi^2} \int_0^\infty ds \cos(s\Delta E) \left[\frac{1}{s^2} - \frac{1}{(\Delta x)^2} \right] \right\}, \quad (3.50)$$

where $\theta(x)$ is the Heaviside function. Louko and Satz have used this formula to compute the excitation rate for a trajectory which is inertial for $\tau \rightarrow -\infty$ and uniformly accelerated with acceleration a for $\tau \rightarrow +\infty$, verifying that it vanishes as $\tau \rightarrow -\infty$ and converges to the rate (3.28) as $\tau \rightarrow +\infty$.³⁰ Very recent discussions on the excitation of Unruh-DeWitt detectors with arbitrary trajectories can be found in Obadia and Milgrom (2007) and Satz (2007). We also note that Bièvre and Merkli (2006) have shown that a uniformly accelerated Unruh-DeWitt detector will asymptotically have the Gibbs state with the Unruh temperature irrespective of its initial state.

³⁰ Note that R_{LS} and its $\tau_0 \rightarrow -\infty$ limit can become negative at some τ . This may be due to the fact that quantum interference prevents one from determining the exact time when the detector clicks.

7. Circularly moving detectors with constant velocity in the Minkowski vacuum

As we have seen, the Unruh effect is concerned with *uniformly accelerated observers*. In spite of this, some interesting questions can be addressed for the case of observers in uniform circular motion.

Let us start by considering a circularly moving Unruh-DeWitt detector³¹ (Letaw and Pfautsch, 1980) in Minkowski spacetime³² at the radius $r = r_0$ with angular velocity $\Omega \equiv d\theta/dt > 0$. Using the interaction action (3.3), we may write the detector excitation amplitude as

$$\begin{aligned} {}^{\text{exc}}\mathcal{A}_{\mathbf{k}} &= i \langle E | \otimes \langle \mathbf{k}_M | \hat{S}_I | 0_M \rangle \otimes | E_0 \rangle \\ &= iq \int_{-\infty}^{\infty} d\tau \exp(i\Delta E \tau) \langle \mathbf{k}_M | \hat{\Phi}[x^\mu(\tau)] | 0_M \rangle, \end{aligned} \quad (3.51)$$

where τ is the detector proper time. Thus, the proper excitation rate (3.7) can be given as (Brout *et al.*, 1995)

$${}^{\text{exc}}R_{\text{circ}}^{m=0} = |q|^2 \int_{-\infty}^{\infty} d\sigma \exp(-i\Delta E \sigma) G^+[x(\tau), x(\tau')], \quad (3.52)$$

where $\sigma \equiv \tau - \tau'$. Here

$$G^+[x^\mu(\tau), x^\mu(\tau')] = \langle 0_M | \hat{\Phi}[x^\mu(\tau)] \hat{\Phi}[x^\mu(\tau')] | 0_M \rangle \quad (3.53)$$

is the (positive-frequency) Wightman function [see, e.g., Fulling (1989)] for the massless scalar field in Minkowski spacetime. In Cartesian coordinates this is written as

$$G^+[x^\mu(\tau), x^\mu(\tau')] = -1/(4\pi^2[(t-t'-i\epsilon)^2 - (x-x')^2 - (y-y')^2 - (z-z')^2]), \quad (3.54)$$

which can be derived using the field expansion (3.5)-(3.6) in terms of positive- and negative-energy modes with respect to inertial observers, as is well known. We may write the world line of this detector as

$$t = \gamma\tau, \quad x = r_0 \cos(\Omega\gamma\tau), \quad y = r_0 \sin(\Omega\gamma\tau), \quad z = \text{const}, \quad (3.55)$$

where we impose the condition $r_0\Omega < 1$ so that the world line is timelike and $\gamma = (1 - r_0^2\Omega^2)^{-1/2}$ is the Lorentz factor. The proper acceleration of such a detector is $a \equiv \sqrt{-a_\mu a^\mu} = \Omega^2 \gamma^2 r_0$. Then, the proper excitation rate can be written as

$$\begin{aligned} {}^{\text{exc}}R_{\text{circ}}^{m=0} &= \frac{|q|^2}{4\pi^2} \int_{-\infty}^{\infty} d\sigma e^{-i\Delta E \sigma} \\ &\times [-\gamma^2(\sigma - i\epsilon)^2 + 4r_0^2 \sin^2(\Omega\gamma\sigma/2)]^{-1}. \end{aligned} \quad (3.56)$$

³¹ For other stationary world lines, see Letaw (1981) in conjunction with Letaw and Pfatsch (1982), and a recent work by Korsbakken and Leinaas (2004).

³² The symbols r and θ correspond to the usual polar coordinates.

This non-vanishing excitation rate has been evaluated numerically by Letaw and Pfautsch (1980) and Letaw (1981) [see also Kim *et al.* (1987) for some further discussion]. For ultra-relativistic detectors ($\gamma \gg 1$), one obtains

$$\text{exc}R_{\text{circ}}^{m=0} \approx \frac{|q|^2 a e^{-\sqrt{12}\Delta E/a}}{4\pi\sqrt{12}}. \quad (3.57)$$

An attempt to give a physical interpretation of this formula in terms of the depolarization of electrons in particle accelerators will be discussed in Sec. IV.A.

Now, one could think of recalculating the excitation rate above from the point of view of observers corotating with the detector. A major difficulty appears, however. In order to extract a natural particle content from the field theory, a global timelike Killing vector field K associated with the rotating observers would be necessary [see, e.g., Wald (1994)]. If such a Killing vector existed, then the eigenvalue equation $iK\phi^\pm = \pm\omega\phi^\pm$ would separate positive-frequency modes (ϕ^+) from negative-frequency ones (ϕ^-) (where K is assumed to be future directed). The four-velocity of a circularly moving observer at $r = r_0$ with $\Omega = d\theta/dt = \text{const}$ can be written as

$$u = d/d\tau = \gamma K,$$

where

$$K = (\partial/\partial t) + \Omega(\partial/\partial\theta) \quad (3.58)$$

is the associated Killing field. We notice now that for $r\Omega > 1$, K is spacelike. Thus, K fails to be a *global* timelike Killing field. If one ignored this fact and used K to extract naively the particle content of the field theory, circularly moving observers would end up with identifying their vacuum state with the Minkowski vacuum itself (Letaw and Pfautsch, 1980). This would lead to a puzzling situation since we know from Eq. (3.56) that detectors carried by circularly moving observers do have a nonzero excitation rate. Thus, either we have a suitable way to extract the particle content from the theory (Ashtekar and Magnon, 1975; Kay, 1978) or it may be better not to introduce such a concept at all.³³

In contrast to the case considered above, we now turn to a related but quite distinct physical situation, where the detector response *can* be naturally interpreted in terms of the particle content defined by the rotating observers. We consider the rotating detector with angular velocity $\Omega = \text{const}$ confined inside a limiting surface (Davies *et al.*, 1996; Levin *et al.*, 1993). We assume a cylindrical surface at $r = \rho$ with $\rho < 1/\Omega$ and

Dirichlet boundary conditions imposed on the scalar field $\phi(t, r = \rho, \theta, z) = 0$.

The positive-frequency orthonormal modes with respect to inertial observers are

$$u_{mnk_z} = C_{mn} J_m(\alpha_{mn} r/\rho) e^{im\theta} e^{ik_z z} e^{-i\omega_{mn} t}. \quad (3.59)$$

Here $m \in \mathbb{Z}$, $n \in \mathbb{N}_+$, α_{mn} is the n -th (non-vanishing) zero of the Bessel function $J_m(x)$ ($J_m(\alpha_{mn}) = 0$), and the following dispersion relation is satisfied:

$$\omega_{mn} = \sqrt{\alpha_{mn}^2/\rho^2 + k_z^2} > 0. \quad (3.60)$$

The normalization constant

$$C_{mn} = (2\pi\rho\sqrt{\omega_{mn}} |J_{m+1}(\alpha_{mn})|)^{-1} \quad (3.61)$$

has been chosen so that the modes u_{mnk_z} satisfy the orthonormality condition with respect to the Klein-Gordon inner product:

$$(u_{mnk_z}, u_{m'n'k'_z})_{\text{KG}} = \delta_{mm'} \delta_{nn'} \delta(k_z - k'_z). \quad (3.62)$$

[See Eq. (2.6) for the definition of the Klein-Gordon inner product.] The corresponding Wightman function (3.53) is

$$\begin{aligned} G^+(x^\mu, x'^\mu) &= \sum_{m=-\infty}^{+\infty} \sum_{n=1}^{+\infty} \int_{-\infty}^{+\infty} dk_z C_{mn}^2 J_m(\alpha_{mn} r/\rho) \\ &\quad \times J_m(\alpha_{mn} r'/\rho) \\ &\quad \times e^{im(\theta-\theta')} e^{ik_z(z-z')} e^{-i\omega_{mn}(t-t')}. \end{aligned} \quad (3.63)$$

In order to calculate the response rate (3.52) we substitute the world line of the rotating detector

$$t = \gamma\tau, \quad r = r_0 = \text{const}, \quad \theta = \Omega t, \quad z = \text{const} \quad (3.64)$$

in Eq. (3.63), obtaining

$$\begin{aligned} G^+(x^\mu, x'^\mu) &= \sum_{m=-\infty}^{+\infty} \sum_{n=1}^{+\infty} \int_{-\infty}^{+\infty} dk_z C_{mn}^2 J_m^2(\alpha_{mn} r_0/\rho) \\ &\quad \times e^{-i(\omega_{mn} - m\Omega)\gamma\sigma}. \end{aligned} \quad (3.65)$$

By substituting Eq. (3.65) into Eq. (3.52), we get

$$\begin{aligned} \text{exc}R_{\text{circ}}^{m=0} &= |q|^2 \sum_{m=-\infty}^{+\infty} \sum_{n=1}^{+\infty} \int_{-\infty}^{+\infty} dk_z C_{mn}^2 J_m^2(\alpha_{mn} r_0/\rho) \\ &\quad \times \int_{-\infty}^{+\infty} d\sigma e^{-i[\Delta E + (\omega_{mn} - m\Omega)\gamma]\sigma}. \end{aligned} \quad (3.66)$$

The result of the integration over σ is proportional to $\delta(\Delta E - (m\Omega - \omega_{mn})\gamma)$. Assuming $\Omega > 0$, we find that no contribution comes from $m \leq 0$ in the sum of Eq. (3.66) (where we recall that $\Delta E > 0$). Now, for $m > 0$ there will be a lowest value of ω_{mn} for each m , namely α_{m1}/ρ [corresponding to the first (non-vanishing) zero of the Bessel function $J_m(x)$ and $k_z = 0$]. Then, a necessary condition for a mode with a given m to contribute in the

³³ We recall that a detector acts as a “vacuum fluctuometer” and that its response must not depend on the definition of the particle (Grove and Ottewill, 1983).

sum is that $\Omega\rho > \alpha_{m1}/m$. However, since $\alpha_{mn} > m$ [see, e.g., Abramowitz and Stegun (1965)], there is no integer value for m that satisfies this condition because of our original constraint that $\rho < 1/\Omega$. We conclude, thus, that the detector has a *vanishing response* when it is confined inside the limiting surface. [The same conclusion would hold if we had chosen Neumann rather than Dirichlet boundary conditions (Davies *et al.*, 1996)].

Now, let us show that in this case, namely for $\rho < 1/\Omega$, it is possible to interpret the vanishing response in terms of the particle content defined by the rotating observers confined inside the boundary with angular velocity Ω . This is so because in this case the Killing vector field K associated with these observers is globally timelike. Let us rewrite Eq. (3.59) as

$$\tilde{u}_{mnk_z} = C_{mn} J_m(\alpha_{mn} r / \rho) e^{im\theta'} e^{ik_z z} e^{-i\tilde{\omega}_{mn} t} \quad (3.67)$$

with $\tilde{\omega}_{mn} = \omega_{mn} - m\Omega > 0$, which are also positive-frequency modes with respect to the corotating observers. We have defined $\theta' \equiv \theta - \Omega t$, and t can be interpreted here as the proper time of a rotating observer with angular velocity Ω lying at $r = 0$, i.e. $K = \partial/\partial t|_{\theta'=\text{const}}$. Clearly, by determining the Bogolubov transformation among the ‘‘inertial’’ modes (3.59) and ‘‘rotating’’ modes (3.67) [see Eq. (2.20)], we obtain

$$\beta_{(i)(i')} = (\tilde{u}_{(i)}^*, u_{(i')})_{\text{KG}} = 0, \quad (3.68)$$

where (i) stands for the set (m, n, k_z) . We conclude, thus, that there is no mixing between positive- and negative-energy modes between the two sets [see, e.g., Birrell and Davies (1982)]. As a result, the Minkowski vacuum coincides with the vacuum state defined by the rotating observers, who would correctly conclude that the response rate of the corotating detectors confined inside the limiting surface vanishes. A similar analysis can be performed for the case of a compact space, like the one with topology $S^2 \times \mathbb{R}^2$, or the Einstein static universe, wherein the field is automatically confined (Davies *et al.*, 1996).³⁴

B. Weak decay of non-inertial protons

As a second example, we discuss the weak decay of non-inertial protons. Although inertial protons are stable according to the standard particle model (Yao *et al.*, 2006), non-inertial protons are not. This is so because the accelerating agent provides the required extra energy for the proton to decay. To the best of our knowledge, the first to consider the weak decay of accelerated protons were Ginzburg and Zharkov (1964), who described

the baryons by classical currents while treating the other particles as quantized fields. At about the same time, Zharkov (1965) investigated the weak and strong proton decays (and other processes) in the presence of a background electromagnetic field A_μ by using the formalism of Nikishov and Ritus (1964a,b) [see also Ritus (1969)], treating all particles as quantum fields. More recently the weak decay of non-inertial protons under the influence of a gravitational field was studied by Müller (1997), Vanzella and Matsas (2000) and Fregolente *et al.* (2006).

Here we review a model of the weak decay of uniformly accelerated protons from the point of view of inertial and Rindler observers. For the sake of simplicity we present a model with a two-dimensional spacetime and massless neutrinos (using four-component spinors for the leptons) (Matsas and Vanzella, 1999; Vanzella and Matsas, 2001), but a four-dimensional comprehensive calculation with massive neutrinos can be found in Suzuki and Yamada (2003). We evaluate the proton proper decay rate with respect to inertial and Rindler observers and show that the results obtained are in agreement when the Unruh effect is taken into account in spite of the fact that uniformly accelerated protons are static according to Rindler observers. It will be interesting to see that what inertial observers interpret as being

$$(i) p^+ \rightarrow n^0 e^+ \nu,$$

are interpreted by Rindler observers as being the combination of the following channels

$$(ii) p^+ e^- \rightarrow n^0 \nu, \quad (iii) p^+ \bar{\nu} \rightarrow n^0 e^+, \quad (iv) p^+ e^- \bar{\nu} \rightarrow n^0,$$

where the e^- 's and $\bar{\nu}$'s on the left-hand side are Rindler electrons and antineutrinos, respectively, absorbed from the Unruh thermal bath. In our procedure, we take into account the proton-neutron mass difference by introducing a *semiclassical* rather than *classical* current. The current is ‘‘classical’’ in the sense that the proton-neutron is associated with a well defined world line and ‘‘quantum’’ in the sense that it behaves as a two-level quantum system.

The trajectory of a proton with proper acceleration $a = \text{const}$ along the z -axis in Minkowski spacetime is given in Cartesian coordinates by $z = \sqrt{t^2 + a^{-2}}$. This can be written more simply as $\rho = a^{-1} = \text{const}$, where we are introducing a new set of Rindler coordinates (ρ, η) which are related with (t, z) by

$$t = \rho \sinh \eta, \quad z = \rho \cosh \eta, \quad (3.69)$$

and $0 < \rho < +\infty$, $-\infty < \eta < +\infty$ [see Eq. (2.34)]. Thus, we describe our uniformly accelerated proton through the vector current

$$j^\mu = q u^\mu \delta(\rho - a^{-1}), \quad (3.70)$$

where q will be associated with a small coupling constant and u^μ is the nucleon's ‘‘two-velocity’’: $u^\mu = (a, 0)$ and

³⁴ Other investigations on the response of particle detectors in spacetimes with non-trivial topology and endowed with boundaries can be found in Copeland *et al.* (1984), Abe (1990), Langlois (2005, 2006) and Davies *et al.* (1989).

$u^\mu = (\sqrt{a^2 t^2 + 1}, at)$ in Rindler and Minkowski coordinates, respectively.

The current (3.70) is suitable for describing stable accelerated protons but must be improved to allow proton-decay processes. For this purpose, we consider the nucleon as a two-level system. In this model, neutrons $|n\rangle$ and protons $|p\rangle$ are going to be seen as excited and unexcited states of the nucleon, respectively, and are assumed to be eigenstates of the nucleon Hamiltonian \hat{H} :

$$\hat{H}|n\rangle = m_n|n\rangle, \quad \hat{H}|p\rangle = m_p|p\rangle, \quad (3.71)$$

where m_n and m_p are the neutron and proton masses, respectively. Accordingly, to consider nucleon decay processes, we replace q in Eq. (3.70) by the Hermitian monopole

$$\hat{q}(\tau) \equiv e^{i\hat{H}\tau} \hat{q}_0 e^{-i\hat{H}\tau}, \quad (3.72)$$

where $|\langle m_p | \hat{q}_0 | m_n \rangle| \equiv G_F$, which is dimensionless, plays the role of an effective Fermi constant. As a result, the current (3.70) will be replaced by

$$\hat{j}^\mu = \hat{q}(\tau) u^\mu \delta(\rho - a^{-1}). \quad (3.73)$$

1. Inertial observer perspective

Let us first analyze the weak-decay process (i) of uniformly accelerated protons in the inertial frame. We shall describe electrons and neutrinos as fermionic fields:

$$\hat{\Psi}(t, z) = \sum_{\sigma=\pm} \int_{-\infty}^{\infty} dk \left(\hat{b}_{k\sigma} \psi_{k\sigma}^{(+\omega)}(t, z) + \hat{d}_{k\sigma}^\dagger \psi_{-k-\sigma}^{(-\omega)}(t, z) \right), \quad (3.74)$$

where $\hat{b}_{k\sigma}$ and $\hat{d}_{k\sigma}^\dagger$ are annihilation and creation operators of fermions and antifermions, respectively, with momentum k and polarization σ . In the inertial frame, the frequency, momentum and mass m are related in the usual way as $\omega = \sqrt{k^2 + m^2} > 0$, and $\psi_{k\sigma}^{(+\omega)}$ and $\psi_{k\sigma}^{(-\omega)}$ are positive- and negative-frequency solutions of the Dirac equation $i\gamma^\mu \partial_\mu \psi_{k\sigma}^{(\pm\omega)} - m\psi_{k\sigma}^{(\pm\omega)} = 0$. By using the γ^μ matrices in the Dirac representation [see, e.g., Itzykson and Zuber (1980)], we find

$$\psi_{k+}^{(\pm\omega)}(t, z) = \frac{e^{i(\mp\omega t + kz)}}{\sqrt{2\pi}} \begin{pmatrix} \pm\sqrt{(\omega \pm m)/2\omega} \\ 0 \\ k/\sqrt{2\omega(\omega \pm m)} \\ 0 \end{pmatrix} \quad (3.75)$$

and

$$\psi_{k-}^{(\pm\omega)}(t, z) = \frac{e^{i(\mp\omega t + kz)}}{\sqrt{2\pi}} \begin{pmatrix} 0 \\ \pm\sqrt{(\omega \pm m)/2\omega} \\ 0 \\ -k/\sqrt{2\omega(\omega \pm m)} \end{pmatrix}. \quad (3.76)$$

In order to keep a unified procedure for inertial and accelerated frame calculations, we have orthonormalized the modes (3.75)-(3.76) according to the same inner-product definition that will be used in Sec. III.B.2:

$$\begin{aligned} (\psi_{k\sigma}^{(\pm\omega)}, \psi_{k'\sigma'}^{(\pm\omega')}) &\equiv \int_{\Sigma} d\Sigma_\mu \bar{\psi}_{k\sigma}^{(\pm\omega)} \gamma^\mu \psi_{k'\sigma'}^{(\pm\omega')} \\ &= \delta(k - k') \delta_{\sigma\sigma'} \delta_{\pm\omega \pm\omega'}, \end{aligned} \quad (3.77)$$

where $\bar{\psi} \equiv \psi^\dagger \gamma^0$. (In this section, we have chosen $t = \text{const}$ for the hypersurface Σ .) Then, the canonical anticommutation relations for fields and conjugate momenta lead to the following simple anticommutation relations for creation and annihilation operators:

$$\{\hat{b}_{k\sigma}, \hat{b}_{k'\sigma'}^\dagger\} = \{\hat{d}_{k\sigma}, \hat{d}_{k'\sigma'}^\dagger\} = \delta(k - k') \delta_{\sigma\sigma'}, \quad (3.78)$$

$$\{\hat{b}_{k\sigma}, \hat{b}_{k'\sigma'}\} = \{\hat{d}_{k\sigma}, \hat{d}_{k'\sigma'}\} = \{\hat{b}_{k\sigma}, \hat{d}_{k'\sigma'}\} = \{\hat{b}_{k\sigma}, \hat{d}_{k'\sigma'}^\dagger\} = 0. \quad (3.79)$$

Next, we model the relevant weak interaction by coupling the electron and neutrino fields, $\hat{\Psi}_e$ and $\hat{\Psi}_\nu$, minimally to the nucleon current (3.73) using the parity-conserving Fermi action

$$\hat{S}_I = \int d^2x \sqrt{-g} \hat{j}_\mu (\hat{\Psi}_\nu \gamma^\mu \hat{\Psi}_e + \hat{\Psi}_e \gamma^\mu \hat{\Psi}_\nu), \quad (3.80)$$

where g is the determinant of the spacetime metric components $g_{\mu\nu}$. Note that the second term inside the parentheses on the right-hand side of Eq. (3.80) does not contribute to the process (i). The vacuum transition amplitude is given by

$$\mathcal{A}_{(i)}^{p \rightarrow n} = \langle n | \otimes \langle e_{k_e \sigma_e}^+, \nu_{k_\nu \sigma_\nu} \rangle_M | \hat{S}_I | 0_M \rangle \otimes | p \rangle. \quad (3.81)$$

By using the current (3.73) in Eq. (3.80) and recalling that \hat{S}_I acts also on the nucleon states in Eq. (3.81), we obtain

$$\begin{aligned} \mathcal{A}_{(i)}^{p \rightarrow n} &= G_F \int_{-\infty}^{\infty} dt \int_{-\infty}^{\infty} dz \frac{e^{i\Delta m \tau} \delta(z - \sqrt{t^2 + a^{-2}})}{az} \\ &\quad \times u_\mu \langle e_{k_e \sigma_e}^+, \nu_{k_\nu \sigma_\nu} \rangle_M | \hat{\Psi}_\nu \gamma^\mu \hat{\Psi}_e | 0_M \rangle, \end{aligned} \quad (3.82)$$

where $\Delta m \equiv m_n - m_p$, $\tau = a^{-1} \sinh^{-1}(at)$ is the proton-neutron proper time and we recall that in Minkowski coordinates the two-velocity is $u^\mu = (\sqrt{a^2 t^2 + 1}, at)$ [see below Eq. (3.70)]. By using the fermionic field (3.74) in Eq. (3.82) and carrying out the integral over z , we obtain

$$\begin{aligned} \mathcal{A}_{(i)}^{p \rightarrow n} &= \frac{-(G_F/4\pi) \delta_{\sigma_e, -\sigma_\nu}}{\sqrt{\omega_\nu \omega_e (\omega_\nu + m_\nu) (\omega_e - m_e)}} \int_{-\infty}^{\infty} d\tau e^{i(\Delta m \tau + a^{-1}(\omega_e + \omega_\nu) \sinh a\tau - a^{-1}(k_e + k_\nu) \cosh a\tau)} \\ &\times \{[(\omega_\nu + m_\nu)(\omega_e - m_e) + k_\nu k_e] \cosh a\tau - [(\omega_\nu + m_\nu)k_e + (\omega_e - m_e)k_\nu] \sinh a\tau\}. \end{aligned}$$

Thus, the differential transition rate $d^2 \mathcal{P}_{\text{in}}^{p \rightarrow n} / dk_e dk_\nu = \sum_{\sigma_e = \pm} \sum_{\sigma_\nu = \pm} |\mathcal{A}_{(i)}^{p \rightarrow n}|^2$ calculated in the inertial frame is

$$\begin{aligned} \frac{d^2 \mathcal{P}_{\text{in}}^{p \rightarrow n}}{dk_e dk_\nu} &= \frac{G_F^2}{4\pi^2 \omega_\nu \omega_e} \int_{-\infty}^{\infty} ds \int_{-\infty}^{\infty} d\xi e^{i(\Delta m \xi + 2a^{-1} \sinh(a\xi/2)[(\omega_\nu + \omega_e) \cosh as - (k_\nu + k_e) \sinh as])} \\ &\times [(\omega_\nu \omega_e + k_\nu k_e) \cosh 2as - (\omega_e k_\nu + \omega_\nu k_e) \sinh 2as - m_\nu m_e \cosh a\xi]. \end{aligned} \quad (3.83)$$

Next, by defining

$$k_{e(\nu)} \rightarrow k'_{e(\nu)} = -\omega_{e(\nu)} \sinh(as) + k_{e(\nu)} \cosh(as),$$

we are able to perform the integral in the s variable, and the differential transition rate (3.83) can be cast in the form

$$\begin{aligned} \frac{1}{T} \frac{d^2 \mathcal{P}_{\text{in}}^{p \rightarrow n}}{dk'_e dk'_\nu} &= \frac{G_F^2}{4\pi^2 \omega'_e \omega'_\nu} \int_{-\infty}^{\infty} d\xi e^{i\Delta m \xi + i2a^{-1}(\omega'_e + \omega'_\nu) \sinh(a\xi/2)} \\ &\times (\omega'_\nu \omega'_e + k'_\nu k'_e - m_\nu m_e \cosh a\xi), \end{aligned} \quad (3.84)$$

where $T \equiv \int_{-\infty}^{\infty} ds$ is the total proper time and $\omega'_{e(\nu)} \equiv \sqrt{k'^2_{e(\nu)} + m^2_{e(\nu)}}$.

The total transition rate $\Gamma_{\text{in}}^{p \rightarrow n} = \mathcal{P}_{\text{in}}^{p \rightarrow n} / T$ is obtained after integrating Eq. (3.84) over both momentum variables. For this purpose it is useful to make the change of variables $k'_{e(\nu)} \rightarrow \tilde{k}_{e(\nu)} \equiv k'_{e(\nu)} / a$ and $\xi \rightarrow \lambda \equiv e^{a\xi/2}$. (Note that $\tilde{k}_{e(\nu)}$ is dimensionless.) Thus, we obtain

$$\begin{aligned} \Gamma_{\text{in}}^{p \rightarrow n} &= \frac{G_F^2 a}{2\pi^2} \int_{-\infty}^{\infty} \frac{d\tilde{k}_e}{\tilde{\omega}_e} \int_{-\infty}^{\infty} \frac{d\tilde{k}_\nu}{\tilde{\omega}_\nu} \int_0^\infty \frac{d\lambda}{\lambda^{1-2i\Delta m/a}} \\ &\times [\tilde{\omega}_\nu \tilde{\omega}_e + \tilde{k}_\nu \tilde{k}_e - m_\nu m_e (\lambda^2 + \lambda^{-2}) / (2a^2)] \\ &\times \exp[i(\tilde{\omega}_e + \tilde{\omega}_\nu)(\lambda - \lambda^{-1})] \end{aligned} \quad (3.85)$$

with $\tilde{\omega}_{e(\nu)} \equiv (\tilde{k}_{e(\nu)}^2 + m_{e(\nu)}^2 / a^2)^{1/2}$. Let us assume at this point $m_\nu \rightarrow 0$. In this case, using (3.871.3-4) in Gradshteyn and Ryzhik (1980), we perform the integration over λ and obtain the following final expression for the proton decay rate:

$$\begin{aligned} \Gamma_{\text{in}}^{p \rightarrow n} &= \frac{G_F^2 \tilde{m}_e a}{2\pi^{3/2} e^{\pi \Delta m}} \\ &\times G_{1\ 3}^{3\ 0} \left(\tilde{m}_e^2 \left| \begin{array}{c} 1 \\ -1/2, 1/2 + i\widetilde{\Delta m}, 1/2 - i\widetilde{\Delta m} \end{array} \right. \right), \end{aligned} \quad (3.86)$$

where G_{pq}^{mn} is the Meijer function (Gradshteyn and Ryzhik, 1980), $\widetilde{\Delta m} \equiv \Delta m / a$ and $\tilde{m}_e \equiv m_e / a$. In Fig. 8 the proton mean proper lifetime $\tau_p = 1 / \Gamma_{\text{in}}^{p \rightarrow n}$ in this model is plotted.

2. Rindler observer perspective

In order to re-analyze the proton decay from the point of view of Rindler observers, it is useful to review the quantization of the fermionic field in the Rindler wedge (Bautista, 1993; Candelas and Deutsch, 1978; Járegui *et al.*, 1991; Soffel *et al.*, 1980).

The line element of the Rindler wedge in terms of the Rindler coordinates (ρ, η) given in Eq. (3.69) is written as [see Eq. (2.35)]

$$ds^2 = \rho^2 d\eta^2 - d\rho^2. \quad (3.87)$$

Now, the Dirac equation in a general spacetime covered with arbitrary coordinates is written as $(i\gamma_R^\mu \tilde{\nabla}_\mu - m)\psi_{\omega\sigma} = 0$, where $\gamma_R^\mu \equiv (e_\alpha)^\mu \gamma^\alpha$ are the Dirac matrices in curved spacetime, $\tilde{\nabla}_\mu \equiv \partial_\mu + \Gamma_\mu$ and $\Gamma_\mu = \frac{1}{8}[\gamma^\alpha, \gamma^\beta](e_\alpha)^\lambda \nabla_\mu (e_\beta)_\lambda$ are the Fock-Kondratenko connections. (The γ^μ are the usual flat-spacetime Dirac matrices.) In the Rindler wedge the relevant tetrads are $(e_0)^\mu = \rho^{-1} \delta_0^\mu$, $(e_i)^\mu = \delta_i^\mu$. As a consequence, the Dirac equation takes the form

$$(i\partial/\partial\eta)\psi_{\omega\sigma} = (\gamma^0 m \rho - i\alpha_3/2 - i\rho\alpha_3\partial/\partial\rho)\psi_{\omega\sigma}, \quad (3.88)$$

where $\alpha_i \equiv \gamma^0 \gamma^i$.

We shall express the fermionic field as

$$\hat{\Psi}(\eta, \rho) = \sum_{\sigma=\pm} \int_0^\infty d\omega \left(\hat{b}_{\omega\sigma} \psi_{\omega\sigma}(\eta, \rho) + \hat{d}_{\omega\sigma}^\dagger \psi_{-\omega-\sigma}(\eta, \rho) \right), \quad (3.89)$$

where $\psi_{\omega\sigma} = f_{\omega\sigma}(\rho) e^{-i\omega\eta/a}$ are positive-energy solutions for $\omega > 0$ and negative-energy solutions for $\omega < 0$ with respect to the boost Killing field $\partial/\partial\eta$ with polarization $\sigma = \pm$. From Eq. (3.88) we obtain

$$\hat{H}_\rho f_{\omega\sigma} = \omega f_{\omega\sigma}, \quad (3.90)$$

where $\hat{H}_\rho \equiv a(m\rho\gamma^0 - i\alpha_3/2 - i\rho\alpha_3\partial/\partial\rho)$. Now, by ‘‘squaring’’ Eq. (3.90) and defining two-component spinors χ_j ($j = 1, 2$) through

$$f_{\omega\sigma}(\rho) \equiv \begin{pmatrix} \chi_1(\rho) \\ \chi_2(\rho) \end{pmatrix}, \quad (3.91)$$

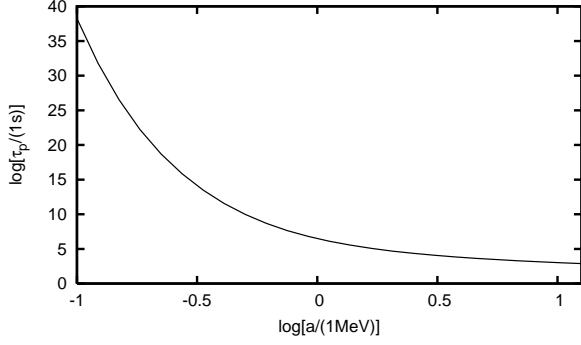

FIG. 8 The proton mean proper lifetime is plotted as a function of the proper acceleration a for $G_F = 10^{-12}$. (This value of G_F approximately reproduces the inertial neutron proper lifetime of 900 seconds in this model.) Note that $\tau_p \rightarrow +\infty$ for inertial protons ($a \rightarrow 0$).

we obtain

$$\left(\rho \frac{d}{d\rho} \rho \frac{d}{d\rho}\right) \chi_1 = \left(m^2 \rho^2 + \frac{1}{4} - \frac{\omega^2}{a^2}\right) \chi_1 - \frac{i\omega}{a} \sigma_3 \chi_2, \quad (3.92)$$

$$\left(\rho \frac{d}{d\rho} \rho \frac{d}{d\rho}\right) \chi_2 = \left(m^2 \rho^2 + \frac{1}{4} - \frac{\omega^2}{a^2}\right) \chi_2 - \frac{i\omega}{a} \sigma_3 \chi_1. \quad (3.93)$$

Next, we introduce the definition $\phi^\pm \equiv \chi_1 \mp \chi_2$ and define ξ^\pm and ζ^\pm through

$$\phi^\pm \equiv \begin{pmatrix} \xi^\pm(\rho) \\ \zeta^\pm(\rho) \end{pmatrix}. \quad (3.94)$$

In terms of these variables Eqs. (3.92)-(3.93) become

$$\left(\rho \frac{d}{d\rho} \rho \frac{d}{d\rho}\right) \xi^\pm = (m^2 \rho^2 + (i\omega/a \pm 1/2)^2) \xi^\pm, \quad (3.95)$$

$$\left(\rho \frac{d}{d\rho} \rho \frac{d}{d\rho}\right) \zeta^\pm = (m^2 \rho^2 + (i\omega/a \mp 1/2)^2) \zeta^\pm. \quad (3.96)$$

The solutions of these differential equations can be written in terms of Hankel functions $H_{i\omega/a \pm 1/2}^{(j)}(im\rho)$, $j = 1, 2$, or modified Bessel functions $K_{i\omega/a \pm 1/2}(m\rho)$, $I_{i\omega/a \pm 1/2}(m\rho)$. Hence, by using Eqs. (3.91) and (3.94), and requiring that the solutions satisfy the first-order equations (3.90), we obtain

$$f_{\omega+}(\rho) = A_+ \begin{pmatrix} K_{i\omega/a+1/2}(m\rho) + iK_{i\omega/a-1/2}(m\rho) \\ 0 \\ K_{i\omega/a-1/2}(m\rho) - iK_{i\omega/a+1/2}(m\rho) \\ 0 \end{pmatrix},$$

$$f_{\omega-}(\rho) = A_- \begin{pmatrix} 0 \\ K_{i\omega/a+1/2}(m\rho) + iK_{i\omega/a-1/2}(m\rho) \\ 0 \\ K_{i\omega/a+1/2}(m\rho) - iK_{i\omega/a-1/2}(m\rho) \end{pmatrix}.$$

Note that solutions involving $I_{i\omega/a \pm 1/2}$ turn out to be non-normalizable and thus must be discarded. In order to find the normalization constants

$$A_+ = A_- = [m \cosh(\pi\omega/a)/(2\pi^2 a)]^{1/2}, \quad (3.97)$$

we have used (Birrell and Davies, 1982)

$$(\psi_{\omega\sigma}, \psi_{\omega'\sigma'}) \equiv \int_{\Sigma} d\Sigma_{\mu} \bar{\psi}_{\omega\sigma} \gamma_R^{\mu} \psi_{\omega'\sigma'} = \delta(\omega - \omega') \delta_{\sigma\sigma'}, \quad (3.98)$$

[see also Eq. (3.77)], where $\bar{\psi} \equiv \psi^{\dagger} \gamma^0$ and Σ is set to be the line $\eta = \text{const}$. Thus, the normal modes of the fermionic field (3.89) are

$$\begin{aligned} \psi_{\omega+} &= [m \cosh(\pi\omega/a)/(2\pi^2 a)]^{1/2} e^{-i\omega\eta/a} \\ &\times \begin{pmatrix} K_{i\omega/a+1/2}(m\rho) + iK_{i\omega/a-1/2}(m\rho) \\ 0 \\ -K_{i\omega/a+1/2}(m\rho) + iK_{i\omega/a-1/2}(m\rho) \\ 0 \end{pmatrix} \end{aligned} \quad (3.99)$$

and

$$\begin{aligned} \psi_{\omega-} &= [m \cosh(\pi\omega/a)/(2\pi^2 a)]^{1/2} e^{-i\omega\eta/a} \\ &\times \begin{pmatrix} 0 \\ K_{i\omega/a+1/2}(m\rho) + iK_{i\omega/a-1/2}(m\rho) \\ 0 \\ K_{i\omega/a+1/2}(m\rho) - iK_{i\omega/a-1/2}(m\rho) \end{pmatrix}. \end{aligned} \quad (3.100)$$

As a consequence, the canonical anticommutation relations for the fields and conjugate momenta imply that the annihilation and creation operators satisfy the following anticommutation relations:

$$\{\hat{b}_{\omega\sigma}, \hat{b}_{\omega'\sigma'}^{\dagger}\} = \{\hat{d}_{\omega\sigma}, \hat{d}_{\omega'\sigma'}^{\dagger}\} = \delta(\omega - \omega') \delta_{\sigma\sigma'}, \quad (3.101)$$

$$\{\hat{b}_{\omega\sigma}, \hat{b}_{\omega'\sigma'}\} = \{\hat{d}_{\omega\sigma}, \hat{d}_{\omega'\sigma'}\} = \{\hat{b}_{\omega\sigma}, \hat{d}_{\omega'\sigma'}\} = \{\hat{b}_{\omega\sigma}, \hat{d}_{\omega'\sigma'}^{\dagger}\} = 0. \quad (3.102)$$

Now, we are in the position to turn our attention to the inverse β -decay of accelerated protons from the point of view of Rindler observers. In particular, the mean proper lifetime must be the same as the one obtained in Sec. III.B.1, but the corresponding particle interpretation changes significantly. As will be shown, the proton decay, which is represented in the inertial frame in terms of Minkowski particles by process (i), will be represented in the uniformly accelerated frame as the combination of the processes (ii), (iii) and (iv) in terms of Rindler particles [see above Eq. (3.69)]. These processes are characterized by the conversion of protons to neutrons due to the absorption of e^- and/or $\bar{\nu}$ and emission of ν , e^+ or no particle, from and to the Unruh thermal bath. Note that process (i) in terms of Rindler particles is forbidden because the proton is static in the Rindler frame.

Let us calculate first the transition amplitude for process (ii):

$$\mathcal{A}_{(ii)}^{p \rightarrow n} = \langle n | \otimes \langle \nu_{\omega\nu\sigma\nu} | \hat{S} | e_{\omega_e - \sigma_e}^- \rangle \otimes | p \rangle, \quad (3.103)$$

where \hat{S}_I is given by Eq. (3.80) with γ^μ replaced by γ_R^μ and our current is given by Eq. (3.73). Thus, we obtain [we recall that in Rindler coordinates $u^\mu = (a, 0)$]

$$\begin{aligned} \mathcal{A}_{(ii)}^{p \rightarrow n} &= \frac{G_F}{a} \int_{-\infty}^{\infty} d\eta \exp(i\Delta m \eta/a) \\ &\times \langle \nu_{\omega_\nu, \sigma_\nu, R} | \hat{\Psi}_\nu^\dagger(\eta, a^{-1}) \hat{\Psi}_e(\eta, a^{-1}) | e_{\omega_{e^-}, \sigma_{e^-}, R}^- \rangle, \end{aligned} \quad (3.104)$$

where we note that the second term in the parentheses of Eq. (3.80) does not contribute. Next, by using Eq. (3.89), we obtain

$$\begin{aligned} \mathcal{A}_{(ii)}^{p \rightarrow n} &= \frac{G_F}{a} \int_{-\infty}^{\infty} d\eta \exp(i\Delta m \eta/a) \\ &\times \delta_{\sigma_{e^-}, \sigma_\nu} \psi_{\omega_\nu, \sigma_\nu}^\dagger(\eta, a^{-1}) \psi_{\omega_{e^-}, \sigma_{e^-}}(\eta, a^{-1}). \end{aligned} \quad (3.105)$$

Using now Eq. (3.99) and Eq. (3.100) and performing the integral, we obtain

$$\begin{aligned} \mathcal{A}_{(ii)}^{p \rightarrow n} &= \frac{4G_F}{\pi a} \sqrt{m_e m_\nu \cosh(\pi \omega_{e^-}/a) \cosh(\pi \omega_\nu/a)} \\ &\times \text{Re}[K_{i\omega_\nu/a-1/2}(m_\nu/a) K_{i\omega_{e^-}/a+1/2}(m_e/a)] \\ &\times \delta_{\sigma_{e^-}, \sigma_\nu} \delta(\omega_{e^-} - \omega_\nu - \Delta m). \end{aligned} \quad (3.106)$$

The corresponding differential transition rate per absorbed and emitted particle energies is given by

$$\frac{1}{T} \frac{d^2 \mathcal{P}_{(ii)}^{p \rightarrow n}}{d\omega_{e^-} d\omega_\nu} = \frac{1}{T} \sum_{\sigma_{e^-} = \pm} \sum_{\sigma_\nu = \pm} |\mathcal{A}_{(ii)}^{p \rightarrow n}|^2 n_F(\omega_{e^-}) [1 - n_F(\omega_\nu)], \quad (3.107)$$

where $n_F(\omega) \equiv 1/(1 + e^{2\pi\omega/a})$ is the fermionic thermal factor associated with the Unruh thermal bath and $T = 2\pi\delta(0)$ is the total nucleon proper time. By using Eq. (3.106) in Eq. (3.107), we obtain

$$\begin{aligned} \frac{1}{T} \frac{d^2 \mathcal{P}_{(ii)}^{p \rightarrow n}}{d\omega_{e^-} d\omega_\nu} &= \frac{4G_F^2 m_e m_\nu}{\pi^3 a^2} e^{-\pi\Delta m/a} \delta(\omega_{e^-} - \omega_\nu - \Delta m) \\ &\times \{ \text{Re}[K_{i\omega_\nu/a-1/2}(m_\nu/a) K_{i\omega_{e^-}/a+1/2}(m_e/a)] \}^2. \end{aligned} \quad (3.108)$$

By integrating Eq. (3.108) over ω_ν , we obtain the following transition rate associated with process (ii):

$$\begin{aligned} \Gamma_{(ii)}^{p \rightarrow n} &= \frac{4G_F^2 m_e m_\nu}{\pi^3 a^2 e^{\pi\Delta m/a}} \int_{\Delta m}^{\infty} d\omega_{e^-} \\ &\times \{ \text{Re}[K_{i(\omega_{e^-} - \Delta m)/a-1/2}(m_\nu/a) K_{i\omega_{e^-}/a+1/2}(m_e/a)] \}^2. \end{aligned}$$

We recall that Rindler frequencies may take arbitrary positive real values (see Sec. III.A.3). Analogous calculations lead to the following transition rates for pro-

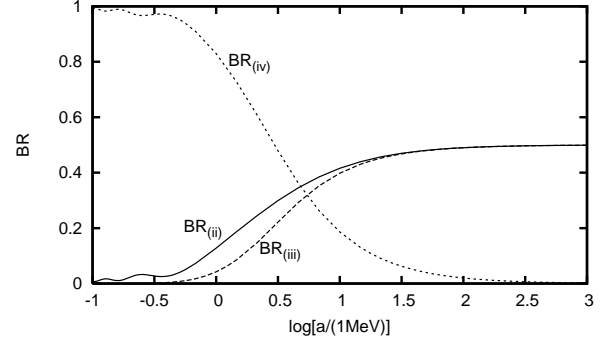

FIG. 9 Branching ratios $BR_{(ii)}$, $BR_{(iii)}$ and $BR_{(iv)}$ are plotted. Process (iv) dominates over processes (ii) and (iii) for small accelerations, while processes (ii) and (iii) dominate over process (iv) for high accelerations.

cesses (iii) and (iv):

$$\begin{aligned} \Gamma_{(iii)}^{p \rightarrow n} &= \frac{4G_F^2 m_e m_\nu}{\pi^3 a^2 e^{\pi\Delta m/a}} \int_0^{\infty} d\omega_{e^+} \\ &\times \{ \text{Re}[K_{i(\omega_{e^+} + \Delta m)/a+1/2}(m_\nu/a) K_{i\omega_{e^+}-1/2}(m_e/a)] \}^2, \\ \Gamma_{(iv)}^{p \rightarrow n} &= \frac{4G_F^2 m_e m_\nu}{\pi^3 a^2 e^{\pi\Delta m/a}} \int_0^{\Delta m} d\omega_{e^-} \\ &\times \{ \text{Re}[K_{i(\omega_{e^-} - \Delta m)/a-1/2}(m_\nu/a) K_{i\omega_{e^-}+1/2}(m_e/a)] \}^2. \end{aligned}$$

The proton decay rate is given by adding up all contributions: $\Gamma_{\text{acc}}^{p \rightarrow n} = \Gamma_{(ii)}^{p \rightarrow n} + \Gamma_{(iii)}^{p \rightarrow n} + \Gamma_{(iv)}^{p \rightarrow n}$, namely

$$\begin{aligned} \Gamma_{\text{acc}}^{p \rightarrow n} &= \frac{4G_F^2 m_e m_\nu \exp(-\pi\Delta m/a)}{\pi^3 a^2} \int_{-\infty}^{\infty} d\omega \\ &\times \{ \text{Re}[K_{i(\omega - \Delta m)/a-1/2}(m_\nu/a) K_{i\omega/a+1/2}(m_e/a)] \}^2. \end{aligned}$$

It is interesting to note that although transition rates have fairly distinct interpretations in the inertial and accelerated frames, mean proper lifetimes are scalars and must be the same in both frames. *Indeed, by taking the limit $m_\nu \rightarrow 0$ and plotting $\tau_p(a) = 1/\Gamma_{\text{acc}}^{p \rightarrow n}$ as a function of acceleration, we do reproduce Fig. 8.*³⁵ In Fig. 9 we plot the branching ratios

$$BR_{(ii)} \equiv \frac{\Gamma_{(ii)}^{p \rightarrow n}}{\Gamma_{\text{acc}}^{p \rightarrow n}}, \quad BR_{(iii)} \equiv \frac{\Gamma_{(iii)}^{p \rightarrow n}}{\Gamma_{\text{acc}}^{p \rightarrow n}}, \quad BR_{(iv)} \equiv \frac{\Gamma_{(iv)}^{p \rightarrow n}}{\Gamma_{\text{acc}}^{p \rightarrow n}}.$$

We note that for small accelerations where “few” high-energy particles are available in the Unruh thermal bath, process (iv) dominates over processes (ii) and (iii), while

³⁵ At first, the decay rates calculated from the point of view of inertial and uniformly accelerated observers were shown to be equal only numerically and the equality was limited by the machine precision (Vanzella and Matsas, 2001). The precise analytic equivalence was derived soon afterward by Suzuki and Yamada (2003).

for high accelerations processes (ii) and (iii) dominate over process (iv). This is an interesting example of how inertial and Rindler observers may differ in the phenomenon description, although they must agree on the output of the experiments associated with scalar observables.

C. Bremsstrahlung

In our next example we use the Unruh effect to discuss how the bremsstrahlung from a uniformly accelerated charge is described in the Rindler frame, addressing also the celebrated question whether or not uniformly accelerated electric charges radiate with respect to co-accelerated observers.³⁶ It will turn out that the Rindler photons with “zero energy”, which are characterized by their transverse momenta, play a central role. Our discussion closely follows Higuchi *et al.* (1992a,b) and does not assume that the reader is familiar with quantization of the electromagnetic field.

A point charge uniformly accelerated along the z -axis in the Cartesian coordinate system can be represented in the Rindler coordinates (2.36) by $\xi = x = y = 0$. The corresponding conserved current ($\nabla_\mu j^\mu = 0$) is, then, given by

$$j^\tau = q\delta(\xi)\delta(x)\delta(y), \quad j^\xi = j^x = j^y = 0. \quad (3.109)$$

Let us analyze the emission of photons with fixed transverse momentum $\mathbf{k}_\perp = (k_x, k_y)$. The fact that \mathbf{k}_\perp is invariant under boosts in the z -direction allows us to directly compare the emission and absorption rates corresponding to Minkowski and Rindler photons with the same transverse momentum.

We shall quantize the electromagnetic field defined by the Lagrangian density

$$\mathcal{L} = -\sqrt{-g}[(1/4)F_{\mu\nu}F^{\mu\nu} + (2\alpha)^{-1}(\nabla^\mu A_\mu)^2] \quad (3.110)$$

with the corresponding field equations in the Feynman gauge ($\alpha = 1$) being

$$\nabla^\mu F_{\mu\nu} + \nabla_\nu(\nabla^\mu A_\mu) = \nabla_\mu \nabla^\mu A_\nu = 0, \quad (3.111)$$

and calculate the response rate of the charge with respect to both inertial and Rindler observers.

1. Inertial observer perspective

According to inertial observers, we write the quantized electromagnetic field $\hat{A}_\mu(x)$ as

$$\hat{A}_\mu(x) = \int \frac{d^3\mathbf{k}}{2(2\pi)^3 k_0} \sum_{\lambda=0}^3 \left[a^{(\lambda)}(\mathbf{k}) \epsilon_\mu^{(\lambda)}(\mathbf{k}) e^{-ik_\nu x^\nu} + \text{H.c.} \right] \quad (3.112)$$

with $k_0 \equiv \sqrt{k_z^2 + k_\perp^2}$, where λ labels the mode polarization. We shall adopt here the notation used in Itzykson and Zuber (1980).

We assign λ the value 0 for what we call the non-physical modes, 1 or 2 for the physical modes and 3 for the pure-gauge modes. The pure-gauge modes are those which can be written as $A_\mu^{(3,\mathbf{k})} = \nabla_\mu \Phi$ for some scalar field $\Phi(x)$ and satisfies the Lorenz condition

$$\nabla_\mu A^\mu = 0. \quad (3.113)$$

The physical modes satisfy the Lorenz condition and are not pure gauge. Finally the non-physical modes do not satisfy the Lorenz condition. Accordingly, we choose the polarization vectors $\epsilon_\mu^{(\lambda)}$ as

$$\epsilon^{(0)\mu} = (-1, 0, 0, 1)/\sqrt{2}, \quad (3.114)$$

$$\epsilon^{(1)\mu} = (0, 1, 0, 0), \quad (3.115)$$

$$\epsilon^{(2)\mu} = (0, 0, 1, 0), \quad (3.116)$$

$$\epsilon^{(3)\mu} = (1, 0, 0, 1)/\sqrt{2}, \quad (3.117)$$

in the Cartesian frame chosen such that $k^\mu = (|\mathbf{k}|, 0, 0, |\mathbf{k}|)$ (where the first component is the time component).

The amplitude of emission of a photon with momentum \mathbf{k} and polarization λ by the accelerated charge in the Minkowski vacuum is

$$\begin{aligned} \mathcal{A}^{(\lambda,\mathbf{k})} &= \langle \mathbf{k}, \lambda_M | i \int d^4x j^\mu(x) \hat{A}_\mu(x) | 0_M \rangle \\ &= i \int d^4x j^\mu(x) \epsilon_\mu^{(\lambda)}(\mathbf{k}) e^{i(\omega t - \mathbf{k} \cdot \mathbf{x})}. \end{aligned} \quad (3.118)$$

The Cartesian components of the current (3.109) can be written as

$$j^\mu = qa(z, 0, 0, t) \delta(\xi) \delta(x) \delta(y), \quad (3.119)$$

where $\delta(\xi) = \delta[z - (t^2 + a^{-2})^{1/2}]/(az)$.

Next, we can express the total probability of emission of photons with fixed transverse momentum \mathbf{k}_\perp , divided by the total proper time $T = 2\pi\delta(0)$ of the accelerated charge during which the interaction remains turned on, as

$$\text{in} R_{k_\perp}^{\text{tot}} = \sum_{\lambda=1}^2 \int_{-\infty}^{\infty} d\tilde{k}_z |\mathcal{A}^{(\lambda,\mathbf{k})}|^2 / T, \quad (3.120)$$

where $d\tilde{k}_z \equiv dk_z / [(2\pi)^3 2k_0]$, and the sum runs only over the physical polarizations $\lambda = 1, 2$. Using Eq. (3.118) in

³⁶ For a series of recent papers which include a critical historical description on hyperbolically moving charges in the context of classical electrodynamics see Eriksen and Grøn (2000a,b,c, 2002, 2004).

Eq. (3.120), one has

$$\begin{aligned} \text{in}R_{k_\perp}^{\text{tot}} &= \int_{-\infty}^{\infty} d\tilde{k}_z \int d^4x \int d^4x' e^{i\omega(t-t') - i\mathbf{k}\cdot(\mathbf{x}-\mathbf{x}')} \\ &\quad \times j^\mu(x) j^\nu(x') \sum_{\lambda=1}^2 \epsilon_\mu^{(\lambda)}(\mathbf{k}) \epsilon_\nu^{(\lambda)}(\mathbf{k}). \end{aligned} \quad (3.121)$$

Now, we note the identity

$$\sum_{\lambda=1}^2 \epsilon_\mu^{(\lambda)} \epsilon_\nu^{(\lambda)} = -\epsilon_\mu^{(0)} \epsilon_\nu^{(3)} - \epsilon_\mu^{(3)} \epsilon_\nu^{(0)} - \eta_{\mu\nu}, \quad (3.122)$$

where $\eta_{\mu\nu}$ is the metric of Minkowski spacetime. Because of the current conservation $\partial_\mu j^\mu = 0$, and due to the fact that $\epsilon_\mu^{(3)}$ is proportional to k_μ , the first two terms in Eq. (3.122) do not contribute when one substitutes it in Eq. (3.121). Hence, as is well known,

$$\begin{aligned} \text{in}R_{k_\perp}^{\text{tot}} &= -\frac{1}{T} \int d\tilde{k}_z \int d^4x \int d^4x' j^\mu(x) j_\mu(x') \\ &\quad \times \exp[i\omega(t-t') - i\mathbf{k}\cdot(\mathbf{x}-\mathbf{x}')]. \end{aligned} \quad (3.123)$$

Next, by substituting the current (3.119) in this formula, we obtain

$$\begin{aligned} \text{in}R_{k_\perp}^{\text{tot}} &= -\frac{q^2}{T} \int_{-\infty}^{\infty} d\tau' \int_{-\infty}^{\infty} d\tau'' \cosh a(\tau' - \tau'') \\ &\quad \times \int_{-\infty}^{\infty} d\tilde{k}_z \exp[-(ik_z/a)(\cosh a\tau' - \cosh a\tau'')] \\ &\quad \times \exp[(ik_0/a)(\sinh a\tau' - \sinh a\tau'')], \end{aligned}$$

where we have made the coordinate transformation $t = a^{-1} \sinh a\tau$. Now, it is necessary again to factor out the total proper time $T = \int_{-\infty}^{\infty} d\tau$, where $\tau = (\tau' + \tau'')/2$. To this end, we use the momentum transformation (3.10) with $m = 0$. Then, we find

$$\begin{aligned} \text{in}R_{k_\perp}^{\text{tot}} &= -q^2 \int_{-\infty}^{\infty} d\tilde{k}'_z \int_{-\infty}^{\infty} d\sigma \cosh a\sigma \\ &\quad \times \exp\left[\frac{2ik'_0}{a} \sinh \frac{a\sigma}{2}\right], \end{aligned} \quad (3.124)$$

where $d\tilde{k}'_z \equiv dk'_z / [(2\pi)^3 2k'_0]$ and $\sigma \equiv \tau' - \tau''$. To evaluate this integral we cut off the contribution from large $|\sigma|$ smoothly by letting $\sigma \rightarrow \sigma + 2i\epsilon$ (where ϵ is an infinitesimal positive number) in the exponent, and taking the limit $\epsilon \rightarrow 0$ in the end. (Otherwise this integral would be indefinite.) Then, by introducing another change of variables as $s_\pm = [(k'_0 \pm k'_z)/k_\perp] e^{\pm a\sigma/2}$, and using the formula (Gradshteyn and Ryzhik, 1980)

$$\int_0^\infty dx x^{\nu-1} \exp\left[\frac{i\mu}{2} \left(x - \frac{\beta^2}{x}\right)\right] = 2\beta^\nu e^{i\nu\pi/2} K_\nu(\beta\mu), \quad (3.125)$$

where $\text{Im } \mu > 0$, $\text{Im}(\beta^2\mu) < 0$, we obtain

$$\text{in}R_{k_\perp}^{\text{tot}} d^2\mathbf{k}_\perp = \frac{q^2}{4\pi^3 a} |K_1(k_\perp/a)|^2 d^2\mathbf{k}_\perp. \quad (3.126)$$

This is the total emission rate of Minkowski particles associated with a uniformly accelerated charge. A similar discussion as the one commented on in Sec. III.A.5 concerning whether or not uniformly accelerated electric charges radiate can be traced back up to about half a century ago [see Fulton and Rohrlich (1960) and references therein]. We recall that the radiation reaction force on a uniformly accelerated electric charge vanishes. The classical radiation reaction force is known to have some unusual features (Barut, 1980) but it was recently shown to be in agreement with quantum field theory (Higuchi, 2002; Higuchi and Martin, 2004, 2005; Krivitskii and Tsytovich, 1991). Clearly, no problems arise when one deals with physical situations where electric charges are accelerated for a finite time interval (Jackson, 1999). Accordingly, Eq. (3.126) should be seen as approximating the one obtained when an electric charge is uniformly accelerated for long enough.

2. Rindler observer perspective

Now, we shall evaluate the response rate associated with the current (3.109) according to Rindler observers by considering the Unruh thermal bath. The response will consist of emission and absorption of photons to and from the Unruh thermal bath. It is clear that the rate of spontaneous emission is zero because the current (3.109) is static. However, it does not imply that the rates of induced emission and absorption vanish as well. This is because these rates are proportional to the number of photons present in the thermal bath which couple to the current (3.109). Since the number of *zero-energy* (Rindler) photons in the (Unruh) thermal bath, which are the relevant ones in this case, is infinite, the rates of induced emission and absorption are *indefinite*. Hence one needs to *regularize* the current (3.109) to make both its strength of coupling to the field and the relevant photon number finite. (The regulator is removed in the end.)

Let us discuss our regularization procedure in two steps. First we modify Eq. (3.109) by considering a charge oscillating with frequency E

$$j^\tau = \sqrt{2}q \cos E\tau \delta(\xi) \delta(x) \delta(y), \quad j^\xi = j^x = j^y = 0, \quad (3.127)$$

and take the limit $E \rightarrow 0$ in the end (Kolbenstvedt, 1988). The factor $\sqrt{2}$ appears because the radiation rate, in first order of perturbation, is proportional to the square of the charge. When the oscillation is slow, i.e. when $E \ll a, k_\perp$, the charge is expected to interact with the field as if it were a constant charge at each τ . (We assume continuity of the rate in the limit $E \rightarrow 0$.) Hence, the τ -average of the square of the charge must be set equal to q^2 and, therefore, the factor $\sqrt{2}$ is necessary.

Now, the current (3.127) does not satisfy electromagnetic charge conservation. For this reason we replace this current by an oscillating dipole arrangement with a charge at $\xi = 0$ and the other one at infinity (which is

omitted here because it does not affect the final result) described by

$$j^\tau = \sqrt{2}q \cos(E\tau) \delta(\xi) \delta^2(\mathbf{x}_\perp), \quad (3.128)$$

$$j^\xi = \sqrt{2}qE \sin(E\tau) e^{-2a\xi} \theta(\xi) \delta^2(\mathbf{x}_\perp), \quad (3.129)$$

$$j^x = j^y = 0. \quad (3.130)$$

The current j^ξ flowing to $\xi = \infty$ will not contribute to the final results. Its only importance is to keep the condition $\nabla^\mu j_\mu = 0$ valid and make the computation gauge independent even before taking the limit $E \rightarrow 0$.

Next, we analyze the interaction of the source (3.128)–(3.130) with the Maxwell field in the Rindler wedge. For this purpose we need to expand the electromagnetic field by the positive- and negative-frequency modes defined with respect to the Rindler time τ . We again deal with the Lagrangian density for the electromagnetic field in the Feynman gauge given by Eq. (3.110) with $\alpha = 1$, and the field equations in the Feynman gauge given by Eq. (3.111) considered now in the Rindler wedge. The presence of ∂_τ , ∂_x and ∂_y as Killing fields makes it sufficient to look for solutions of Eq. (3.111) of the form

$$A_\mu^{(\lambda, \omega, \mathbf{k}_\perp)}(x) = f_\mu^{(\lambda, \omega, k_\perp)}(\xi) e^{i(\mathbf{k}_\perp \cdot \mathbf{x}_\perp - \omega\tau)}. \quad (3.131)$$

Then, we expand the electromagnetic quantum field in terms of annihilation and creation operators as

$$\begin{aligned} \hat{A}_\mu(x) &= \int d^2\mathbf{k}_\perp \int_0^\infty d\omega \\ &\times \sum_{\lambda=0}^3 \left\{ \hat{a}_{(\lambda, \omega, \mathbf{k}_\perp)} A_\mu^{(\lambda, \omega, \mathbf{k}_\perp)}(x) + \text{H.c.} \right\}, \end{aligned} \quad (3.132)$$

where $A_\mu^{(\lambda, \omega, \mathbf{k}_\perp)}(x)$ are solutions of the form given in Eq. (3.131). These modes are conveniently expressed in terms of the solutions of the scalar field equation $\square\phi = 0$ [see Candelas and Deutsch (1977)]. For each set of quantum numbers the solution, which does not diverge as $\xi \rightarrow +\infty$, is obtained by letting $m = 0$ in Eq. (2.92):

$$\begin{aligned} \phi^{(\omega, \mathbf{k}_\perp)} &= \left[\frac{\sinh(\pi\omega/a)}{4\pi^4 a} \right]^{1/2} K_{i\omega/a}[(k_\perp/a) e^{a\xi}] \\ &\times e^{i\mathbf{k}_\perp \cdot \mathbf{x}_\perp - i\omega\tau}. \end{aligned} \quad (3.133)$$

One can choose a set of independent normal modes as

$$A_\mu^{(0, \omega, \mathbf{k}_\perp)} = C^{(0, \omega, \mathbf{k}_\perp)}(0, 0, k_x \phi, k_y \phi), \quad (3.134)$$

$$A_\mu^{(1, \omega, \mathbf{k}_\perp)} = C^{(1, \omega, \mathbf{k}_\perp)}(0, 0, k_y \phi, -k_x \phi), \quad (3.135)$$

$$A_\mu^{(2, \omega, \mathbf{k}_\perp)} = C^{(2, \omega, \mathbf{k}_\perp)}(\partial_\xi \phi, -i\omega \phi, 0, 0), \quad (3.136)$$

$$A_\mu^{(3, \omega, \mathbf{k}_\perp)} = C^{(3, \omega, \mathbf{k}_\perp)}(-i\omega \phi, \partial_\xi \phi, ik_x \phi, ik_y \phi), \quad (3.137)$$

where $A_\mu = (A_\tau, A_\xi, A_x, A_y)$, $C^{(\lambda, \omega, \mathbf{k}_\perp)}$ are normalization constants, and $\phi \equiv \phi^{(\omega, \mathbf{k}_\perp)}$. The modes $A_\mu^{(0, \omega, \mathbf{k}_\perp)}$ are

the non-physical modes because $\nabla^\mu A_\mu^{(0, \omega, \mathbf{k}_\perp)} \neq 0$. It can readily be shown that the modes $A_\mu^{(\lambda, \omega, \mathbf{k}_\perp)}$ with $\lambda = 1, 2$ satisfy the Lorenz condition $\nabla^\mu A_\mu^{(\lambda, \omega, \mathbf{k}_\perp)} = 0$. Thus, these are the physical modes. The modes $A_\mu^{(3, \omega, \mathbf{k}_\perp)} \propto \nabla_\mu \phi^{(\omega, \mathbf{k}_\perp)}$ are the pure-gauge modes.

The normalization constants $C^{(i)}$ can be determined from the canonical commutation relations of the fields by requiring suitable commutation relations for the operators $a_{(i)}$ and $a_{(i)}^\dagger$. [Here the label (i) represents $(\lambda, \omega, \mathbf{k}_\perp)$.] In this context, it is convenient to introduce the generalized Klein-Gordon inner product

$$(A^{(i)}, A^{(j)})_{\text{KG}} \equiv \int_\Sigma d\Sigma_\mu W^\mu[A^{(i)}, A^{(j)}] \quad (3.138)$$

between any two modes $A_\mu^{(i)}$ and $A_\mu^{(j)}$, where the integration is performed on some Cauchy surface Σ for the Rindler wedge, e.g., any hypersurface $\tau = \text{const}$, and where

$$W^\mu[A^{(i)}, A^{(j)}] \equiv \frac{i}{\sqrt{-g}} (A_\nu^{(i)*} \pi^{(j)\mu\nu} - A_\nu^{(j)} \pi^{(i)\mu\nu*}) \quad (3.139)$$

with $\pi^{(i)\mu\nu} \equiv \partial\mathcal{L}/\partial\partial_\mu A_\nu|_{A_\mu=A_{(i)\mu}}$. The $\pi^{(i)\mu\nu}$ are calculated in the Feynman gauge to be

$$\pi^{(i)\mu\nu} = \sqrt{-g} [\nabla^\nu A^{(i)\mu} - \nabla^\mu A^{(i)\nu} - g^{\mu\nu} \nabla_\alpha A^{(i)\alpha}]. \quad (3.140)$$

It can be seen [see, e.g., Friedman (1978)] that the field equations ensure conservation of the current (3.139), and thus the inner product (3.138) is independent of the choice of the Cauchy surface Σ .

From the canonical commutation relations one finds

$$[(A^{(i)}, \hat{A})_{\text{KG}}, (\hat{A}, A^{(j)})_{\text{KG}}] = (A^{(i)}, A^{(j)})_{\text{KG}}. \quad (3.141)$$

[See Eq. (2.12).] This equation and Eq. (3.132) imply that

$$(A^{(i)}, A^{(l)})_{\text{KG}} [\hat{a}_{(l)}, \hat{a}_{(l')}^\dagger] (A^{(l')}, A^{(j)})_{\text{KG}} = (A^{(i)}, A^{(j)})_{\text{KG}}, \quad (3.142)$$

where we have used the fact that positive- and negative-frequency modes can be shown to be orthogonal to each other. The schematic summation over l represents integrations over ω and \mathbf{k}_\perp as well as the summation over λ . Next, define the matrix $M^{(i)(j)} \equiv (A^{(i)}, A^{(j)})_{\text{KG}}$. Then, Eq. (3.142) implies [see, e.g., Higuchi (1989)]

$$[\hat{a}_{(i)}, \hat{a}_{(j)}^\dagger] = (M^{-1})_{(i)(j)}, \quad (3.143)$$

where $(M^{-1})_{(i)(j)}$ is defined by

$$(M^{-1})_{(i)(l)} M^{(l)(j)} = \delta^{\lambda\lambda'} \delta(\omega - \omega') \delta^2(\mathbf{k}_\perp - \mathbf{k}'_\perp) \quad (3.144)$$

with $(i) = (\lambda, \omega, \mathbf{k}_\perp)$ and $(j) = (\lambda', \omega', \mathbf{k}'_\perp)$.

Now, by using the inner product (3.138) for the normal modes (3.134)–(3.137), we can verify the following orthogonality properties:

$$(A^{(\lambda, \omega, \mathbf{k}_\perp)}, A^{(\lambda', \omega', \mathbf{k}'_\perp)})_{\text{KG}} = 0, \quad \lambda = 1, 2, \quad \lambda' = 0, 3. \quad (3.145)$$

In other words, the physical modes are orthogonal to the *pure gauge* mode $\lambda = 3$ and to the *Lorenz condition violating* non-physical mode $\lambda = 0$ and to each other. Hence, it is sufficient to know the restriction of the matrix $M^{(i)(j)}$ to the physical subspace (i.e. to $\lambda = 1, 2$) in order to derive the commutators among the physical annihilation and creation operators according to Eq. (3.143). Thus, by requiring the commutators of annihilation and creation operators associated with the physical modes (i.e. with λ and λ' being 1 or 2) to be

$$[\hat{a}_{(\lambda,\omega,\mathbf{k}_\perp)}, \hat{a}_{(\lambda',\omega',\mathbf{k}'_\perp)}^\dagger] = \delta_{\lambda\lambda'} \delta(\omega - \omega') \delta^2(\mathbf{k}_\perp - \mathbf{k}'_\perp), \quad (3.146)$$

we find the normalization condition

$$(A^{(\lambda,\omega,\mathbf{k}_\perp)}, A^{(\lambda',\omega',\mathbf{k}'_\perp)})_{\text{KG}} = \delta^{\lambda\lambda'} \delta(\omega - \omega') \delta^2(\mathbf{k}_\perp - \mathbf{k}'_\perp) \quad (3.147)$$

for $\lambda, \lambda' = 1, 2$. For these modes we find

$$(A^{(\lambda,\omega,\mathbf{k}_\perp)}, A^{(\lambda',\omega',\mathbf{k}'_\perp)})_{\text{KG}} = \delta^{\lambda\lambda'} k_\perp^2 |C^{(\lambda,\omega,\mathbf{k}_\perp)}|^2 \times (\phi^{(\omega,\mathbf{k}_\perp)}, \phi^{(\omega',\mathbf{k}'_\perp)})_{\text{KG}}, \quad (3.148)$$

where

$$(\phi^{(\omega,\mathbf{k}_\perp)}, \phi^{(\omega',\mathbf{k}'_\perp)})_{\text{KG}} = i \int_\Sigma d\xi d^2\mathbf{x}_\perp \phi^{(\omega,\mathbf{k}_\perp)*} \overleftrightarrow{\partial}_\tau \phi^{(\omega',\mathbf{k}'_\perp)} \quad (3.149)$$

is the Klein-Gordon inner product for the scalar field defined by Eq. (2.12) and where $\phi^{(\omega,\mathbf{k}_\perp)}$ is given by Eq. (3.133). Since the solutions $\phi^{(\omega,\mathbf{k}_\perp)}$ are normalized as scalar mode functions, we have

$$(\phi^{(\omega,\mathbf{k}_\perp)}, \phi^{(\omega',\mathbf{k}'_\perp)})_{\text{KG}} = \delta(\omega - \omega') \delta^2(\mathbf{k}_\perp - \mathbf{k}'_\perp). \quad (3.150)$$

Substituting this equation in Eq. (3.148) and comparing the result with Eq. (3.147), we find $|C^{(\lambda,\omega,\mathbf{k}_\perp)}| = k_\perp^{-1}$ for $\lambda = 1, 2$. Thus, the physical modes with $\lambda = 2$ [see Eq. (3.136)] are

$$A_\mu^{(2,\omega,\mathbf{k}_\perp)} = \frac{1}{2\pi^2 k_\perp} \left[\frac{\sinh(\pi\omega/a)}{a} \right]^{1/2} (\partial_\xi \phi, -i\omega\phi, 0, 0), \quad (3.151)$$

up to a constant phase factor. In fact we only need these modes because the current (3.128)–(3.130) will excite neither the physical modes with $\lambda = 1$ [see Eq. (3.135)] nor the modes with $\lambda = 0$ or $\lambda = 3$ via the interaction Lagrangian density

$$\mathcal{L}_{int} = \sqrt{-g} j^\mu \hat{A}_\mu. \quad (3.152)$$

Now, to lowest order in perturbation, the amplitude $\mathcal{A}_{(\lambda,\omega,\mathbf{k}_\perp)}^{\text{em}}$ of emission of a Rindler photon with quantum numbers $(\lambda, \omega, \mathbf{k}_\perp)$ into the Rindler vacuum state $|0_{\text{R}}\rangle$, which is defined by $\hat{a}_{(\lambda,\omega,\mathbf{k}_\perp)}|0_{\text{R}}\rangle = 0$ for all $(\lambda, \omega, \mathbf{k}_\perp)$, is given by

$$\mathcal{A}_{(\lambda,\omega,\mathbf{k}_\perp)}^{\text{em}} = \langle \lambda, \omega, \mathbf{k}_\perp |_{\text{R}} | i \int d^4x \sqrt{-g} j^\mu(x) \hat{A}_\mu(x) | 0_{\text{R}} \rangle, \quad (3.153)$$

where $|\lambda, \omega, \mathbf{k}_\perp |_{\text{R}} \equiv \hat{a}_{(\lambda,\omega,\mathbf{k}_\perp)}^\dagger | 0_{\text{R}} \rangle$. It is straightforward to compute $\mathcal{A}_{(2,\omega,k_\perp)}^{\text{em}}$, which is the only non-vanishing amplitude, for the current (3.128)–(3.130) using Eqs. (3.132) and (3.146) with Eq. (3.151). We obtain

$$\begin{aligned} \mathcal{A}_{(2,\omega,k_\perp)}^{\text{em}} &= iq \left[\frac{\sinh(\pi E/a)}{a} \right]^{1/2} \delta(E - \omega) \\ &\times \left\{ K'_{iE/a}(k_\perp/a) \right. \\ &\left. - \frac{E^2}{ak_\perp} \int_{k_\perp/a}^\infty \frac{dz}{z} K_{iE/a}(z) \right\}, \quad (3.154) \end{aligned}$$

where the derivative with respect to the argument is denoted by a prime.

We are interested in the differential probability of emission per unit time and unit area in the transverse-momentum space given by

$$dW_0^{\text{em}}(\omega, k_\perp) = \sum_{\lambda=1}^2 |\mathcal{A}_{(\lambda,\omega,k_\perp)}^{\text{em}}|^2 d\omega/T, \quad (3.155)$$

where T is the time interval while the interaction remains turned on. We thus obtain

$$\begin{aligned} dW_0^{\text{em}}(\omega, k_\perp) &= \frac{q^2}{4\pi^3 a} \sinh(\pi E/a) \delta(E - \omega) \\ &\times \left| K'_{iE/a}(k_\perp/a) - \frac{E^2}{ak_\perp} \int_{k_\perp/a}^\infty \frac{dz}{z} K_{iE/a}(z) \right|^2 d\omega, \quad (3.156) \end{aligned}$$

where we have used $\delta(0) = T/2\pi$.

The total differential rate (per unit area in the transverse-momentum space) of emission of photons with given transverse momentum \mathbf{k}_\perp into the thermal bath can be written as [see Eq. (3.21)]

$$R_{k_\perp}^{\text{em}} = \int_0^\infty dW_0^{\text{em}}(\omega, k_\perp) \left(\frac{1}{e^{2\pi\omega/a} - 1} + 1 \right). \quad (3.157)$$

The two terms inside the parentheses are associated with the induced and spontaneous emissions, respectively. Evaluating the integral in Eq. (3.157) and taking the limit $E \rightarrow 0$ (thus removing the regulator), we obtain

$$R_{k_\perp}^{\text{em}} d^2\mathbf{k}_\perp = \frac{q^2}{8\pi^3 a} |K_1(k_\perp/a)|^2 d^2\mathbf{k}_\perp. \quad (3.158)$$

Similarly, the total absorption rate of photons per unit area in the transverse-momentum space is

$$R_{k_\perp}^{\text{abs}} = \int_0^\infty dW_0^{\text{abs}}(\omega, k_\perp) \frac{1}{e^{2\pi\omega/a} - 1}. \quad (3.159)$$

On unitarity grounds we have

$$dW_0^{\text{abs}}(\omega, k_\perp) = dW_0^{\text{em}}(\omega, k_\perp), \quad (3.160)$$

and one can evaluate Eq. (3.159) using Eq. (3.156). We obtain in the limit $E \rightarrow 0$

$$R_{k_{\perp}}^{\text{abs}} d^2 \mathbf{k}_{\perp} = \frac{q^2}{8\pi^3 a} |K_1(k_{\perp}/a)|^2 d^2 \mathbf{k}_{\perp}. \quad (3.161)$$

The reason for the equality of $R_{k_{\perp}}^{\text{em}}$ and $R_{k_{\perp}}^{\text{abs}}$ is that the spontaneous emission becomes negligible in comparison to the induced emission as E approaches zero. It is also interesting to note that it is the existence of an infinite number of zero-energy Rindler photons in the thermal bath that prevents $R_{k_{\perp}}^{\text{em}}$ and $R_{k_{\perp}}^{\text{abs}}$ from vanishing. In the absence of the thermal bath, the emission and absorption rates would vanish.

Next, we recall that since there is no interference between the processes of emission and absorption of Rindler photons at the tree level, the total response rate will be given by adding Eqs. (3.158) and (3.161). We find, thus,

$${}^{\text{ac}}R_{k_{\perp}}^{\text{tot}} d^2 \mathbf{k}_{\perp} = \frac{q^2}{4\pi^3 a} |K_1(k_{\perp}/a)|^2 d^2 \mathbf{k}_{\perp}. \quad (3.162)$$

By comparing this equation and Eq. (3.126) we find

$${}^{\text{ac}}R_{k_{\perp}}^{\text{tot}} = {}^{\text{in}}R_{k_{\perp}}^{\text{tot}}. \quad (3.163)$$

Thus, we have established by explicit calculations that the rate of photon emission from a uniformly accelerated charge can be reproduced by summing the rates of emission and absorption of zero-energy Rindler photons in the Unruh thermal bath.³⁷ This also answers one of a series of questions concerning the Equivalence Principle and the radiation concept [see Ginzburg (1969); Rohrlich (1961) and references therein]. From our discussion in Sec. III.A.3 it should be clear that zero-energy Rindler photons are not detectable since they concentrate on the horizon. As a consequence, Rindler observers do not find emission of classical radiation from uniformly accelerated charges although inertial observers do.³⁸ This is in agreement with conclusions obtained in the context of classical electromagnetism (Boulware, 1980; Eriksen and Grøn, 2004).

A related question raised in this context is whether or not static charges in gravitational fields should radiate. The quantization of the electromagnetic field outside black holes can be found in Cognola and Lecca (1998)

and Crispino *et al.* (2001). This was used to analyze the response of static charges coupled to the Hawking radiation (Crispino *et al.*, 1998). Because these charges lie at rest with respect to the observers following the integral curve of the Killing vector generating the global timelike isometry with respect to whom the particle content of the field theory is extracted, the response is solely associated with the emission and absorption of zero-energy Boulware photons (Boulware, 1975a,b). As a result, no classical radiation is emitted by the static charges as seen by the static observer (Eriksen and Grøn, 2004).³⁹

IV. EXPERIMENTAL PROPOSALS

This section will be mainly concerned with reviewing two complementary aspects, namely, “proposed experimental tests of the Unruh effect” and “the possible contributions of the Unruh effect for the explanation of experimental data”. [For an extensive reference list of experiments related to the Unruh and Hawking effects see Rosu (2001).] We have already stressed that the Unruh effect does not need experimental confirmation any more than free Quantum Field Theory does. This fact does not invalidate, however, explanations of laboratory phenomena from the point of view of Rindler observers in terms of the Unruh effect. On the contrary, such explanations are interesting, and looking at some problems from the point of view of Rindler observers also can bring new insights. This is how we shall understand here the experimental proposals of “testing” the Unruh effect.

A. Electrons in particle accelerators

Among the first attempts to explain experimental data in terms of the Unruh effect is the one due to Bell and Leinaas (1983). The fact that the transverse polarization of electrons and positrons in particle storage rings is not perfect has been observed for some time. The “transverse polarization” here means the polarization perpendicular to both space velocity and acceleration, i.e. along the direction of the magnetic field responsible for the bending. Positrons and electrons are polarized in the directions paral-

³⁷ The analogous situation where the electric charge coupled to the Maxwell field is replaced by a scalar source coupled to a massless Klein-Gordon field has also been investigated in free space (Díaz and Stephany, 2002; Ren and Weinberg, 1994) and in the presence of boundaries (Alves and Crispino, 2004). An equality analogous to Eq. (3.163) is satisfied in these cases as well.

³⁸ A discussion on how one can account for the change in the energy-momentum content of the radiation field in spite of the fact that uniformly accelerated charges are in *equilibrium* with the undetectable zero-energy Rindler photons of the Unruh thermal bath can be found in Peña *et al.* (2005).

³⁹ A surprising coincidence appears as one considers the response of static scalar sources interacting with a massless Klein-Gordon field outside a Schwarzschild black hole with the Unruh vacuum. Such a source behaves as if it were moving with the same proper acceleration in the inertial vacuum of Minkowski spacetime (Higuchi *et al.*, 1997). This equivalence was expected when the source is close to the horizon (Grishchuk *et al.*, 1987) but not everywhere. Indeed, by considering other vacua (Higuchi *et al.*, 1998) as in Hartle and Hawking (1976), other spacetimes (Castiñeiras and Matsas, 2000), fields (Castiñeiras *et al.*, 2003; Crispino *et al.*, 1998) or spacetime dimensionalities (Crispino *et al.*, 2004) the equivalence is broken.

lel and antiparallel to the magnetic field, respectively. Sokolov and Ternov (1963) studied the electron-positron polarization in storage rings first assuming a homogeneous magnetic field. Next, Baier and Katkov (1967) generalized this result to inhomogeneous magnetic fields. A more comprehensive analysis was performed further by Derbenev and Kondratenko (1973). The polarization is built up gradually in time according to the formula $P(t) = P_0(1 - e^{-t/t_{\text{build up}}})$, where the maximum polarization achieved in ideal conditions is $P_0 = 8/(5\sqrt{3}) \approx 92.38\%$ and the characteristic build-up time in the laboratory frame is

$$t_{\text{build up}} = \frac{8}{5\sqrt{3}} \frac{m_e^2 \rho^3}{e^2 \gamma^5}.$$

Here m_e and e are the electron mass and charge, respectively, ρ is the curvature radius of the orbit and $\gamma = 1/\sqrt{1-v^2}$ is the usual relativistic factor. For circular orbits ρ coincides with the circle radius; otherwise

$$\rho^{-3} = \oint \rho(s)^{-3} ds / \oint ds,$$

where $\rho(s)$ is the radius of curvature at each point on the orbit and s is the spatial distance of the corresponding point from some arbitrary origin defined on the orbit. The photon power radiated due to the spin flip, $I_{\text{spin flip}}$, can be compared with the one due to synchrotron radiation, $I_{\text{synchrotron}}$, by

$$\frac{I_{\text{spin flip}}}{I_{\text{synchrotron}}} = 3 \left(\frac{\gamma^2}{m_e \rho} \right)^2 \left(1 \pm \frac{35\sqrt{3}}{64} \right)^2,$$

where the positive and negative signs should be used when initially the spin state is excited and deexcited, respectively [see Jackson (1976) and Montague (1984) for comprehensive reviews on the spin-flip synchrotron radiation and the polarization of electrons in storage rings].

Although theoretical investigations adapted to *inertial observers* were already performed, Bell and Leinaas posed the question whether or not it would be possible to use the spin as a sensitive thermometer and interpret the depolarization of accelerated electrons from the point of view of comoving observers through the Unruh effect. The coupling between the electron spin and a background magnetic field induces an energy gap ΔE between the “spin up” and “spin down” states, making it a two-level system. If the distribution of spin-up and spin-down states of the accelerated electrons satisfied the detailed balance relation, one could easily interpret the observed depolarization in terms of the Unruh effect (see Sec. III.A). If this was the case, the polarization

$$P \equiv \frac{\text{deexc}R - \text{exc}R}{\text{deexc}R + \text{exc}R} \quad (4.1)$$

would be given by

$$P = \frac{1 - e^{-\beta\Delta E}}{1 + e^{-\beta\Delta E}}, \quad (4.2)$$

where we have used Eq. (3.40).

For *linear accelerators*, Bell and Leinaas obtained for the excitation and deexcitation transition rates, $^{\text{exc}}R$ and $^{\text{deexc}}R$, (here denoted by Γ_+ and Γ_- , respectively)

$$\Gamma_{\pm} = \mp \frac{8\mu^2}{3} \frac{\Delta E(\Delta E^2 + a^2)}{1 - \exp(\pm 2\pi\Delta E/a)},$$

where it is assumed for these machines that the magnetic field points to the acceleration direction, $\mu = ge/(4m_e)$ is the magnetic moment and $g \approx 2.0023$ is the electron gyromagnetic factor. As a result, in this case the electron polarization (4.1) would indeed lead to Eq. (4.2) if the actual machine specifications did not impose technical impediments. At the Stanford linac with an accelerating field of 10 MV/m, for example, the Unruh temperature associated with the corresponding proper acceleration of $2 \times 10^{16} g_{\oplus}$ ($g_{\oplus} \approx 9.8 \text{ m/s}^2$) would be about $\beta^{-1} = 0.7 \times 10^{-3} \text{ K}$. The fact that this temperature is much smaller than the ordinary background temperature of about 300 K does not cause a substantial problem since the influence of the background thermal bath is damped for relativistic electrons (Costa and Matsas, 1995; Guimarães *et al.*, 1998). This is so because the background photons are Doppler shifted in the electron proper frame and so most of them are pushed away from the absorbable band. The main problem here is related with the “thermalization” time. For instance, the polarization build-up time at the Stanford linac is much larger than the flight time (actually much larger than the lifetime of the Universe). As a result, no equilibrium polarization would be built up in linear accelerators.

In order to decrease the polarization build-up time, larger accelerations are necessary. Large enough accelerations are indeed achieved in storage rings (Barber, 1999). For instance, at the LEP/CERN, HERA/DESY and SPEAR/Stanford conditions, polarization equilibrium states could be achieved in a couple of hours, half an hour and 10 minutes, respectively.⁴⁰ However, some cautionary remarks are in order. Firstly, the *Thomas precession* plays a major role when electrons are in circular motion, in contrast to the case of linear acceleration, and cannot be disregarded. Secondly, if the electrons are not linearly (and uniformly) accelerated, the results concerning the Unruh effect are not guaranteed to be applicable to them. Thus, there is no compelling reason to expect that the detailed balance relation (3.40) and consequently Eq. (4.2) should hold here. The intrinsic difficulties in the attempt to derive a variant of the Unruh effect for circularly moving detectors was already discussed in Sec. III.A.7. Nevertheless,

⁴⁰ Experiments at SPEAR measuring the maximum polarization and corresponding build-up time have been reported by Camerini *et al.* (1975) and Johnson *et al.* (1983), while spin polarization at the HERA, and LEP electron storage-rings have been reported by Barber *et al.* (1994) and Assmann *et al.* (1995); Knudsen *et al.* (1991), respectively.

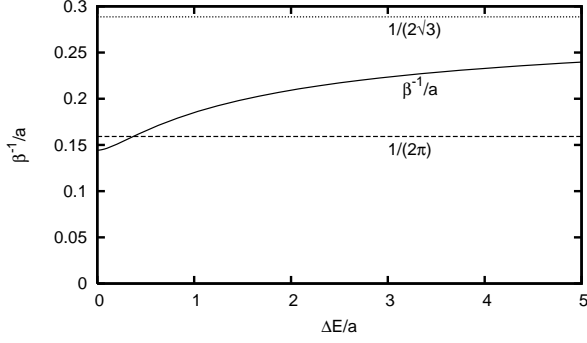

FIG. 10 The frequency-dependent temperature β^{-1}/a [see Eq. (4.3)] is plotted as a function of $\Delta E/a$ and compared with the corresponding one given by the Unruh effect: $1/(2\pi)$. For $\Delta E \gg a$, one obtains $\beta^{-1}/a = 1/(2\sqrt{3})$.

Letaw and Pfautsch (1980), Bell and Leinaas (1983) and Takagi (1986) have argued that the response of ultra-relativistic Unruh-DeWitt detectors in uniform circular motion [see Eq. (3.57)] and that for those linearly accelerated [see Eq. (3.28)] have some resemblance.⁴¹ Indeed, by calculating the excitation-to-deexcitation ratio $\text{exc}R_{\text{circ}}^{m=0}/\text{deexc}R_{\text{circ}}^{m=0}$ for circular motions, where $\text{exc}R_{\text{circ}}^{m=0}$ is given in Eq. (3.57) and

$$\text{deexc}R_{\text{circ}}^{m=0} = \frac{|q|^2 a (e^{-\sqrt{12}\Delta E/a} + 2\sqrt{12}\Delta E/a)}{2\pi \cdot 2\sqrt{12}},$$

and equating $\text{exc}R_{\text{circ}}^{m=0}/\text{deexc}R_{\text{circ}}^{m=0}$ to the detailed balance relation (3.40) satisfied by uniformly accelerated detectors, one is led to define the *frequency dependent* temperature⁴²

$$\frac{\beta^{-1}}{a} = \frac{\Delta E/a}{\ln[1 + 4\sqrt{3}(\Delta E/a) \exp(2\sqrt{3}\Delta E/a)]}. \quad (4.3)$$

Note that for $\Delta E \ll a$ and $\Delta E \gg a$, one gets

$$\beta^{-1}/a \approx 1/(2\sqrt{12}) \quad \text{and} \quad \beta^{-1}/a \approx 1/(2\sqrt{3}),$$

respectively (see Fig. 10). One should interpret β^{-1} in Eq. (4.3) as an effective temperature experienced by the detector in circular motion.⁴³

Now, at first sight it would not be unnatural to expect that ultra-relativistic electrons in storage rings had a polarization approximated by

$$P_1 = \frac{1 - e^{-\pi g}}{1 + e^{-\pi g}}, \quad (4.4)$$

where we have used Eq. (4.2) with $\Delta E = 2|\mu||\mathbf{B}'_0|$, $\mu = ge/4m_e$, $\beta^{-1} = a/(2\pi) = e|\mathbf{B}'_0|/(2\pi m_e)$ and we recall that $g \approx 2.0023$ is the electron gyromagnetic factor. Here \mathbf{B}'_0 is the magnetic field in the inertial frame instantaneously at rest with the electron. In this case a description of the depolarization in terms of Rindler observers could be discussed along the same lines as the excitation of accelerated detectors (see Sec. III.A). Clearly, this would be an “indirect” connection with the Unruh effect, since no real thermal bath of Rindler particles could be associated with observers comoving with the rotating electrons.

On the other hand, detailed inertial frame calculations (Derbenev and Kondratenko, 1973; Jackson, 1976) show that the polarization is actually given by

$$P_2 = F_2(\tilde{g})/[F_1(\tilde{g})e^{-\sqrt{12}|\tilde{g}|} + (\tilde{g}/|\tilde{g}|)F_2(\tilde{g})], \quad (4.5)$$

where $\tilde{g} = (g - 2)/2$,

$$F_1(\tilde{g}) = 1 + \frac{41\tilde{g}}{45} - \frac{23\tilde{g}^2}{18} - \frac{8\tilde{g}^3}{15} + \frac{14\tilde{g}^4}{15} - \frac{8\tilde{g}}{5\sqrt{3}|\tilde{g}|} \left(1 + \frac{11\tilde{g}}{12} - \frac{17\tilde{g}^2}{12} - \frac{13\tilde{g}^3}{24} + \tilde{g}^4 \right), \quad (4.6)$$

and

$$F_2(\tilde{g}) = \frac{8}{5\sqrt{3}} \left(1 + \frac{14\tilde{g}}{3} + 8\tilde{g}^2 + \frac{23\tilde{g}^3}{3} + \frac{10\tilde{g}^4}{3} + \frac{2\tilde{g}^5}{3} \right). \quad (4.7)$$

The fact that the polarizations (4.5) and (4.4) show substantial differences (see Fig. 11) [although some similarities can be also pointed out (Bell and Leinaas, 1983)] was discussed by Unruh (1998, 1999). The difficulty to understand the polarization in terms of electromagnetic vacuum fluctuations as experienced by the circularly moving observers stems from the fact that in this case the electron should be seen as a system composed of two field detectors coupled to each other. In addition to the spin, the vertical fluctuations in the orbit should be considered (Bell and Leinaas, 1987; Leinaas, 1999, 2002).⁴⁴ By analyzing the problem in the Fermi-Walker frame associated with the electron, it is concluded that the vertical oscillation responds in a thermal-like fashion with a frequency-dependent temperature similar (but not identical) to that associated with the spin alone. Nevertheless, the subtle coupling between the two systems makes the joint system to have a polarization (4.5) distinct from the simple thermal-like one (4.4).

⁴¹ Actually, Takagi (1984) found that the response of a Unruh-DeWitt detector with uniform circular motion and speed v is better approximated by the one of an Unruh-DeWitt detector with a combined motion made of linear acceleration and uniform translation with speed v in the direction perpendicular to the acceleration.

⁴² We recall that Eq. (3.57) was calculated assuming ultra-relativistic detectors and, thus, Eq. (4.3) should be seen as an approximation. See Letaw and Pfautsch (1982) and Obadia and Milgrom (2007) for more details.

⁴³ This temperature is “effective” because, due to the dependence of β^{-1} on ΔE , it cannot be considered as the temperature of a legitimate thermal bath in contrast to that for the Unruh thermal bath.

⁴⁴ See also Barber and Mane (1988) for a comparison of the procedures used by Bell and Leinaas (1987) and Derbenev and Kondratenko (1973).

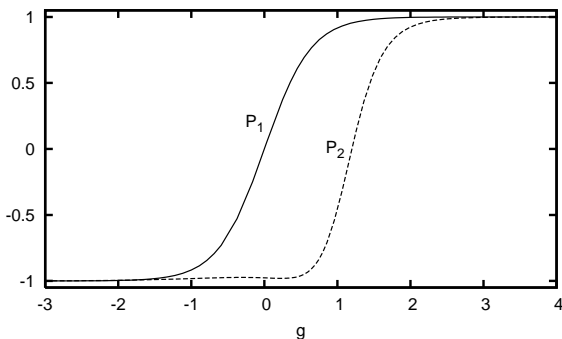

FIG. 11 The polarizations P_1 (solid line) and P_2 (dashed line) given in Eqs. (4.4) and (4.5), respectively, are plotted as functions of g . The two curves show substantial differences although some similarities can be also seen.

B. Electrons in Penning traps

The use of the degree of freedom associated with vertical fluctuations of a single electron in circular motion as a detector was investigated further by Rogers (1988). In this paper an experimental proposal is made in which an electron is bound radially by the laboratory magnetic field \mathbf{B}_0 and axially by superimposing an electrostatic restoring force given by a quadrupole potential (Brown and Gabrielse, 1986) $V = V_0(z^2 - \rho^2/2)/(2d^2)$, where $V_0, d = \text{const}$, and z and ρ are the *axial* and *radial* coordinates, respectively. Thus, the electron is in a *Penning trap*. As a result, an electron constrained to move in a circular cyclotron orbit around the trap axis with angular frequency $\omega_0 = e|\mathbf{B}_0|/(\gamma m_e)$ can oscillate axially with frequency $\omega_z = \sqrt{eV_0/(\gamma m_e d^2)}$. The excitation of this degree of freedom could be interpreted as due to the vacuum fluctuation experienced by the circularly moving electron. By surrounding the Penning trap with an electromagnetic cavity tuned to resonate at the electron axial oscillation frequency ω_z , the energy of the axial motion would be transferred to the cavity electromagnetic field where it would be measured. In general, electrons are captured by the trap in large orbits but their radii shrink rapidly due to the emission of synchrotron radiation. In order to replace the energy lost, Rogers (1988) suggests to irradiate the system with circularly polarized waves of frequency ω_0 . In the proposed experiment, an electron is assumed to have velocity $v = 0.6$ in a background magnetic field of $|\mathbf{B}| = 1.5 \times 10^5$ G. The axial and angular frequencies would be $\omega_z \approx 5 \times 10^{10} \text{ s}^{-1}$ and $\omega_0 \approx 2 \times 10^{12} \text{ s}^{-1}$, respectively, corresponding to a proper acceleration $a = \gamma^2 v \omega_0 \approx 6 \times 10^{19} g_\oplus$ with $a/2\pi \approx 2$ K.

C. Atoms in microwave cavities

Scully *et al.* (2003) and Belyanin *et al.* (2006) have considered a *gedanken* experiment assuming that a beam of two-level atoms are accelerated through a high-Q (i.e.

low power loss) “single mode” microwave cavity. They have noted that even with a large acceleration frequency (defined as the acceleration divided by the speed of light) $\alpha \approx 10^8 \text{ Hz}$, corresponding to the proper acceleration as large as $3 \times 10^{15} g_\oplus$, for an atom with energy gap of $\Delta E \approx 10^{10} \text{ Hz}$ ($\approx 4 \times 10^{-5} \text{ eV}$), the excitation-deexcitation ratio (3.40) of the atom would be

$$\text{exc}R/\text{deexc}R = e^{-2\pi\Delta E/\alpha} \sim 10^{-200}, \quad (4.8)$$

which is extremely small. The atoms are assumed to follow the world line

$$t(\tau) = t_0 + \alpha^{-1} \sinh(\alpha\tau), \quad z(\tau) = \alpha^{-1}(\cosh(\alpha\tau) - 1),$$

where $t_0 = t(\tau)|_{\tau=0}$ is the moment in the laboratory time when the atoms begin to accelerate. They enter the cavity at $\tau = \tau_i$ and exit it later at $\tau = \tau_e$ after staying in interaction for long enough, typically $\alpha(\tau_e - \tau_i) \gg 1$.

In spite of the minute value predicted by the Unruh effect for the situation described above, in a real experiment the ratio $\text{exc}R/\text{deexc}R$ can be much larger because the sharp boundaries of the cavity induce a nonadiabatic coupling of the form $g(\tau) = \mu E'$ between the atom and the electromagnetic field, where μ is the atomic dipole moment and E' is the electric field as measured in the inertial frame instantaneously at rest with the atom. This may be seen as a sort of laboratory implementation of the finite-time detectors discussed in Sec. III.A.6, where the scalar field is replaced by an electromagnetic one. For the case where the photon frequency ν associated with the single-mode cavity satisfies $\nu \gg \Delta E \gg \alpha$, the ratio of the excitation to deexcitation rates is found to be

$$\text{exc}R/\text{deexc}R = \alpha/(2\pi\Delta E), \quad (4.9)$$

which leads to a value enhanced by many orders of magnitude under the conditions given above: $\text{exc}R/\text{deexc}R \sim 10^{-3}$. We note that even when the atom enters the cavity with constant velocity, the sudden turning-on of the interaction induced by the sharp boundaries makes the atom excitation rate to be nonzero. (Note that a photon is *emitted* in this excitation process.) Nevertheless, acceleration still plays a role in the ratio $\text{exc}R/\text{deexc}R$ as seen in Eq. (4.9). The authors note that Eq. (4.8) is recovered when one considers the limit of adiabatically slow switching-off of the interaction at infinitely distant cavity boundaries. In this case

$$\begin{aligned} \text{exc}R &\propto \pi\Delta E[\alpha \sinh(\pi\Delta E/\alpha)]^{-1} e^{-\pi\Delta E/\alpha}, \\ \text{deexc}R &\propto \pi\Delta E[\alpha \sinh(\pi\Delta E/\alpha)]^{-1} e^{\pi\Delta E/\alpha}. \end{aligned}$$

Belyanin *et al.* (2006) also discuss the existence of photons and their number in the cavity as a result of the interaction with the beam of atoms (see discussion in Sec. III.A.6). Clearly, the physical origin of the simultaneous increase of the field energy and the internal energy of the atom is the work done by the external force, which drives the center-of-mass motion of the atom against the radiation reaction force.

Both the acceleration and boundary contributions to the photon emission from the ground state atom come from the *counterrotating term* $\propto \hat{a}^\dagger \hat{\sigma}^\dagger$ in the interaction Hamiltonian, where \hat{a}^\dagger is the photon creation operator and where the operator $\hat{\sigma}^\dagger \equiv |a\rangle\langle b|$ converts the ground state $|b\rangle$ of the atom to its excited state $|a\rangle$. In the single-mode cavity case, we could also *define* an *effective* temperature

$$\beta_{\text{eff}}^{-1} = \Delta E / \ln(2\pi\Delta E/\alpha) \quad (4.10)$$

by equating Eqs. (4.8) and (4.9). Nevertheless, the Unruh and boundary effects should not be put on the same footing (Obadia, 2007). We note that Eq. (4.10) is an effective temperature depending on the details of the atom through ΔE in contrast to the Unruh temperature which is associated with a legitimate thermal bath of Rindler particles.

Another possible physical implementation of a finite-time detector was also discussed recently. Alsing *et al.* (2005) have considered trapped ions prepared in the vibrational ground state with a laser cooling procedure. The internal electronic state of each ion would play the role of a phonon detector through the use of an external laser which would couple it to the ion vibrational motion. Thus, this phonon detector could be turned on and off at will by controlling the external laser. Another interesting feature of this detector is that it would be easy to vary its energy gap by tuning the frequency of the external laser. Alsing *et al.* (2005) also consider a *linear* ion trap to analyze particle creation in condensed matter analogues of expanding universes.

D. Backreaction radiation in ultraintense lasers and related topics

A different path pursued in the literature concerns the use of ultraintense lasers (Chen and Tajima, 1999; Schützhold *et al.*, 2006). It is known that the electric field of laser-driven waves of plasma can accelerate particles in just a few meters to energies as high as the ones obtained by large conventional radio-frequency accelerators [see Mourou *et al.* (2006) and references therein]. In *plasma wakefield accelerators*, a short pulse of laser light (or electrons) is responsible for a collective perturbation of the plasma confined in a cavity producing an electromagnetic wakefield in the laser propagation direction. This wakefield can be surfed by some electrons which acquire very high accelerations. However, the direct effect of the laser field on the electrons can induce even larger accelerations (and decelerations) along every laser cycle. Electric field pulses not too far below the Schwinger limit (about 10^{18}V/m) are expected in future facilities. (The Schwinger limit is associated with the electric field above which the spontaneous creation of electron-positron pairs becomes favorable. This is so when the work done by the electric field along the electron Compton wavelength is at least about the mass of the electron-positron pair.)

Electrons under the influence of fields with this magnitude could reach proper accelerations as high as $10^{28} g_\oplus$. Here, we shall be interested in interpreting the radiation emitted by such electrons in terms of the Unruh effect rather than in the behavior of internal degrees of freedom.

For the sake of simplicity, Chen and Tajima consider the case where two identical counterpropagating laser plane waves produce a standing wave. In this case, electrons can be treated as classical charges with well-defined trajectories. Let us consider linearly polarized lasers with angular frequency ω_0 , wave number k_0 and propagation in the $\pm z$ directions:

$$\begin{aligned} E_x &= E_0[\cos(\omega_0 t - k_0 z) + \cos(\omega_0 t + k_0 z)], \\ B_y &= E_0[\cos(\omega_0 t - k_0 z) - \cos(\omega_0 t + k_0 z)], \end{aligned}$$

where E_x and B_y are the electric and magnetic fields in the x and y directions, respectively, as measured in the laboratory frame. The equations of motion for an electron under the influence of this field can be written as

$$\begin{aligned} dp_x/dt &= -e(E_x - v_z B_y), \\ dp_z/dt &= -ev_x B_y, \end{aligned}$$

where $p_x = m_e \gamma v_x$ and $v_x \equiv dx/dt$. The largest electric field is found at the nodal points $k_0 z = 0, \pm 2\pi, \dots$ where $E_x = 2E_0 \cos(\omega_0 t)$ and $B_y = 0$. In particular, at $z = 0$, Chen and Tajima find

$$\gamma v_x = 2a_0 \sin \omega_0 t, \quad \gamma = \sqrt{1 + 4a_0^2 \sin^2 \omega_0 t},$$

where $a_0 = eE_0/(m_e \omega_0)$ is a dimensionless parameter, which characterizes the laser strength. The corresponding electron proper acceleration is, thus, given by

$$a = 2a_0 \omega_0 \cos \omega_0 t,$$

and the total Larmor radiation power $dI_L/dt = (2/3)e^2 a^2$ is

$$dI_L/dt = (8/3)e^2 a_0^2 \omega_0^2 \cos^2 \omega_0 t. \quad (4.11)$$

Hence, the total energy radiated during each laser half cycle is $\Delta I_L = (4\pi/3)e^2 a_0^2 \omega_0$.

We have shown in Sec. III.C how the radiation emitted by *uniformly accelerated charges* can be interpreted from the point of view of coaccelerated observers in terms of the *emission* and *absorption* of zero-energy Rindler photons *to* and *from* the Unruh thermal bath, respectively. In this calculation, the charge was assumed not to recoil in the emission/absorption process. This assumption is justified if the mass of the charge is much larger than the typical (Minkowski) energy of the photon emitted. In a real physical set-up, however, the electron backreacts to the Larmor radiation. Chen and Tajima claim that this backreaction triggers additional “quivering radiation”, which reflects the Unruh effect. They estimate

the power of this radiation, ΔI_U , in comparison to that of the Larmor radiation, ΔI_L , as

$$\frac{\Delta I_U}{\Delta I_L} \approx \frac{9}{\pi^2} \frac{\hbar \omega_0}{m_e c^2} a_0 \log(a_0/\pi) \approx 3 \times 10^{-4}, \quad (4.12)$$

where m_e is the electron mass, for $\omega_0 \approx 2 \times 10^{15} \text{ sec}^{-1}$ and $a_0 \approx 100$.

Schützhold *et al.* (2006) note that a Rindler photon seen to be scattered off a static charge by the Rindler observers should correspond to a pair of correlated Minkowski photons emitted from a uniformly accelerated charge as seen by the inertial observers. (Note that a Rindler photon with *nonzero* energy can cause this process in contrast to the Larmor radiation, i.e. the bremsstrahlung.) They propose this two-photon emission process as a distinct signal of the Unruh effect. they argue that, as long as the acceleration is not close to the Schwinger limit, where the Unruh temperature becomes comparable to the electron mass, Rindler observers can describe the electrons as pointlike (Thomson) scatterers of Rindler photons. (In this regime the electron spin is not supposed to play any major role.) They assert that the most promising strategy to observe a signal of this radiation above the background Larmor noise would be by probing the angular distribution of the photon emission; in contrast to the Larmor radiation, which has a well known blind spot along the motion direction, this two-photon radiation dominates inside small backward and forward cones.⁴⁵ They also note that another signal would be the direct detection of correlated photons.

Although the residual quivering radiation or correlated radiation of Minkowski photons could be explained and calculated by inertial observers using textbook quantum field theory⁴⁶, it is certainly interesting to understand these processes invoking the Unruh effect.

Finally, let us mention here some works concerning a detailed-balance relation obeyed by the transverse momentum of a uniformly accelerated electron. The differential probability of emission of a photon by an electron in a constant electric field E was obtained by Nikishov (1970) by means of an inertial frame calculation, where the electron and photon fields are quantized. The recoil causes the electron to change its momentum perpendicular to the background electric field, which accelerates the electron. Let $P(p_\perp \rightarrow p'_\perp)$ be the differential probability associated with the photon emission changing the modulus of the transverse momentum of the electron from p_\perp to p'_\perp . Nikishov and Ritus (1988) find

$$\frac{P(p_\perp \rightarrow p'_\perp)}{P(p'_\perp \rightarrow p_\perp)} = \exp(-\beta \Delta \mathcal{E}), \quad (4.13)$$

where $\beta^{-1} = a/2\pi$ with $a = eE/m_e$ and

$$\Delta \mathcal{E} = p'^2_\perp/2m_e - p^2_\perp/2m_e. \quad (4.14)$$

This expression for $\Delta \mathcal{E}$ is valid even if p_\perp and p'_\perp are comparable to m_e . If $p_\perp, p'_\perp \ll m_e$, then

$$\Delta \mathcal{E} \approx \sqrt{p'^2_\perp + m_e^2} - \sqrt{p^2_\perp + m_e^2}. \quad (4.15)$$

Myhrvold (1985) calls $\sqrt{p^2_\perp + m_e^2}$ the *transverse energy* of the electron with transverse momentum p_\perp and claims that the relation (4.13) reflects the Unruh effect for $p_\perp, p'_\perp \ll m_e$. Indeed Eq. (4.13) is similar to the detailed balance relation (3.40), which was derived assuming hyperbolic motion of the source.⁴⁷ Although the relation (4.13) may well be closely related to the Unruh effect, the former does not directly follow from the latter because the connection between the Rindler energy [in Eq. (3.40)] and the transverse energy [in Eq. (4.13)] is not entirely clear.

E. Thermal spectra in hadronic collisions

Now, let us turn our attention to insights that the Unruh effect can bring to explain some experimental data in hadronic physics. The Unruh effect has been considered as possibly helpful in explaining the puzzling thermal-like emission spectra observed in hadron collisions (Barshay *et al.*, 1980; Barshay and Troost, 1978; Kharzeev, 2006). The main idea is that in the collision process, hadrons would feel in their rest frame a large Unruh temperature, which would lead them to quiver and interact accordingly. It is conjectured, then, that the thermal-like emission of *Minkowski particles* observed in hadron processes would be a reflection of it. In some sense, it may be that a quivering-like radiation which we have discussed in Sec. IV.D in a quite different context becomes the explanation for this puzzling aspect of hadron collisions. As we have said, the Unruh thermal bath is not required for the investigation of accelerated systems from the point of view of inertial observers. For these observers, “plain” quantum field theory must suffice for a complete phenomenon description. Nevertheless, it would be certainly interesting if the Unruh effect could bring new insights to the understanding of this problem.

F. Unruh and Moore (dynamical Casimir) effects

There have also appeared some proposals of using the *Moore effect*, often called *dynamical Casimir effect*, as a

⁴⁵ Chen and Tajima (1999) also propose to exploit the blind spot of the Larmor radiation.

⁴⁶ We have favored the term “quivering” rather than “Unruh” radiation, as appears sometimes in the literature, to emphasize that this does not depend on the Unruh effect any more than the Larmor one does.

⁴⁷ Recent investigations also considering the backreaction on accelerated systems can be found in Parentani (1995), Parentani and Massar (1997), Gabriel *et al.* (1998) and Reznik (1998).

way to test the thermal bath observed by Rindler observers. Here we discuss why the connection between the Moore and Unruh effects is tenuous and comment briefly on some few selected proposals. We refer to Rosu (2001) for a more extensive list.

Moore (1970) and later DeWitt (1975) found independently that photons can be created by moving mirrors in the Minkowski vacuum. An interesting connection between the Moore effect and the Hawking radiation was established by Davies and Fulling (1977b) and more recently revisited by Calogeracos (2002a,b). These authors consider a massless scalar field in two-dimensional Minkowski spacetime equipped with a reflective boundary. At $t = 0$ the boundary begins to move to the left following the trajectory

$$z(t) = -\kappa^{-1} \ln(\cosh \kappa t), \quad (4.16)$$

where $\kappa = \text{const}$ and $x^\mu = (t, z)$ are the usual Cartesian coordinates.⁴⁸ We note that asymptotically the corresponding world line becomes lightlike. (Notice that the proper acceleration of the boundary is $\kappa \cosh \kappa t \neq \kappa$.) Eventually, the receding boundary induces a thermal flux of *Minkowski* particles to the right characterized by a temperature $\kappa/2\pi$. (This would not be so if the boundary were uniformly accelerated.) The *energy content* associated with the *particle emission* was also investigated (Fulling and Davies, 1976) [see also Calogeracos (2004)]. There is, thus, a similarity between the flux of Minkowski particles, which are emitted from the receding boundary and the Hawking radiation of *Boulware* particles produced in a black hole formation process.

Now, by approximating the line element of a black hole close to its horizon by that of the Rindler wedge as discussed in Sec. III.A.3, we can establish a correspondence between *static observers outside the horizon* and *Rindler observers*, where the former and latter observers are immersed in the Hawking radiation and Unruh thermal bath, respectively [see also Ginzburg and Frolov (1987)]. This leads to the following loose connection

Moore effect \leftrightarrow Hawking radiation \leftrightarrow Unruh effect,

where the Moore effect is seen as a flat spacetime analog of the Hawking effect and this is connected with the Unruh thermal bath close to the black hole horizon. It should be stressed, however, that although the observation of the Moore effect would be very interesting, this would not constitute an experimental verification of the Unruh effect. It is worthwhile to emphasize that the thermal flux associated with the Moore and Unruh effects are formed of Minkowski and Rindler particles, respectively, which are quite different. The Moore, Hawking and Unruh effects, although related, have features which make them distinct.

Despite the fact that the Moore and Unruh effects are only linked through the indirect reasoning above, we comment briefly on some experimental proposals, which are interesting in their own right. Yablonovitch (1989) [see also Yablonovitch *et al.* (1989)] has recently discussed the possibility of using media with varying index of refraction to observe a Moore-like effect. When a gas is suddenly photo-ionized, its index of refraction drops from about 1 to 0. This disturbs the vacuum in a way similar to what an accelerated mirror does. [For a comparative discussion between these two similar effects see, e.g., Johnston and Sarkar (1995).] Likewise, sudden creation of electron-hole pairs in a semiconductor slab can quickly reduce the refractive index from about 3.5 to 0. Considering a general medium with time-varying index of refraction $n = n(t)$ which instantaneously jumps from n_0 to n , Yablonovitch (1989) found an expectation number of created modes with wave vector k given by

$$N_k = \sum_{k'} |\beta_{kk'}|^2,$$

where $|\beta_{kk'}| = |n - n_0| \delta_{kk'} / (2\sqrt{nn_0})$. The experimental prospect of the laboratory verification of Moore-like effects in the near future seem very promising [see, e.g., (Kim *et al.*, 2006; Uhlmann *et al.*, 2004)].

V. RECENT DEVELOPMENTS

Recently, a number of issues connecting Quantum Mechanics, Relativity and Information Theory have been investigated [see Peres and Terno (2004) for a critical review]. Here we comment briefly on some of these issues and other topics that have the Unruh effect as the central theme. We refer the reader to our list of references for more details.

A. Entanglement and Rindler observers

As is well known, mixed states can be obtained from pure states by tracing out (i.e. ignoring) some of its degrees of freedom (Zurek, 1991). However, it was not obvious until recently that the “amount of mixing” could depend on the observer. For a spin-1/2 system Peres *et al.* (2002) found that, in general, different inertial observers will find distinct values for the corresponding von Neumann quantum entropy

$$S = -\text{Tr}(\rho^{\text{red}} \ln \rho^{\text{red}}).$$

Here ρ^{red} is the reduced density matrix associated with the spin-1/2 particle, which is obtained after the momentum degrees of freedom are traced out. Later on, for a *pair* of massive spin-1/2 particles Gingrich and Adami (2002) found that by tracing out the momentum degrees of freedom, different inertial observers will assign in general distinct entanglements between the particle

⁴⁸ Notice that by identifying t, z and κ with τ, ξ and a , respectively, we obtain Eq. (2.36) with $z = a^{-1}$.

spins. A similar conclusion was reached for the entanglement between the polarization of a pair of photon beams (Gingrich *et al.*, 2003).

Although the entanglement between some degrees of freedom can be transferred to others as shown above, all inertial observers will agree about the entanglement of the full state. This is not the case, however, when non-inertial observers are involved. Fuentes-Schuller and Mann (2005) investigated the entanglement between two modes of a free massless scalar field as seen by inertial and uniformly accelerated observers. They reached the conclusion that the existence of a horizon for the Rindler observer leads in general to loss of information. The entanglement which appears to be maximal for inertial observers is degraded according to the Rindler ones because of the Unruh effect. The authors suggest that analogous conclusions should be valid close to black holes when inertial and Rindler observers are replaced by free-falling and static ones, respectively. A thorough investigation of such questions in general curved spacetimes would be very interesting.

B. Decoherence of accelerated detectors

Discussions on the decoherence of accelerated detectors have been continuing since some years ago (Audretsch *et al.*, 1995). Kok and Yurtsever (2003) considered a qubit $|\psi\rangle$ represented by a (uniformly accelerated) Unruh-DeWitt detector with free Hamiltonian $H_0 = \Delta E \hat{b}^\dagger \hat{b}$, where ΔE is the energy gap between the two internal degrees of freedom $|0\rangle$ and $|1\rangle$ of the qubit, and \hat{b} and \hat{b}^\dagger denote the lowering and raising operators, respectively, acting on the corresponding two-dimensional Hilbert space:

$$\hat{b}|0\rangle = 0, \quad \hat{b}^\dagger|0\rangle = |1\rangle, \quad \hat{b}|1\rangle = |0\rangle, \quad \hat{b}^\dagger|1\rangle = 0.$$

The qubit is coupled to a real scalar field $\hat{\Phi}(\mathbf{x}, t)$ through the interaction Hamiltonian

$$H_I(t) = \epsilon(t) \int_{\Sigma} \hat{\Phi}(\mathbf{x}, t) (\psi(\mathbf{x}) \hat{b} + \bar{\psi}(\mathbf{x}) \hat{b}^\dagger) \sqrt{-g} d^3 \mathbf{x},$$

where $\psi(\mathbf{x})$ is a smooth function which vanishes outside a small volume around the qubit. The integration is over the global spacelike Cauchy surface Σ given by $t = \text{const}$ (with t being the usual Cartesian time coordinate) and $\epsilon(t)$ is a time dependent coupling constant, which vanishes everywhere except within a finite time interval Δt where $\epsilon(t) = \epsilon = \text{const}$. Before the acceleration takes place, the qubit is prepared in the state

$$|\psi\rangle = (|0\rangle + |1\rangle)/\sqrt{2},$$

which is combined with the field state described by the reduced density matrix (2.78). We recall that this is obtained when the degrees of freedom of the Minkowski

vacuum associated with one of the Rindler wedges are traced out. Then, the combined initial state

$$\hat{\rho}_{\text{in}} = \hat{\rho}_R \otimes |\psi\rangle\langle\psi| \quad (5.1)$$

must be evolved through the interaction Hamiltonian leading to $\hat{\rho}_{\text{out}}$. Kok and Yurtsever find the final reduced density matrix associated with the qubit by tracing out the field degrees of freedom as

$$\begin{aligned} \hat{\rho}_{q,\text{out}} &= \text{Tr}_{\Phi}(\hat{\rho}_{\text{out}}) \\ &= \frac{1}{2} \begin{pmatrix} S_0 + S_e & S_0 \\ S_0 & S_0 + S_a \end{pmatrix}, \end{aligned} \quad (5.2)$$

where

$$\begin{aligned} S_0 &= (1 - e^{-2\pi\Delta E/a}) \sum_n e^{-2\pi n\Delta E/a} / Q_n, \\ S_a &= (1 - e^{-2\pi\Delta E/a}) |\mu|^2 \sum_n n e^{-2\pi n\Delta E/a} / Q_n, \\ S_e &= (1 - e^{-2\pi\Delta E/a}) \nu^2 \sum_n (n+1) e^{-2\pi n\Delta E/a} / Q_n. \end{aligned}$$

Here, $Q_n = 1 + n|\mu|^2/2 + (n+1)\nu^2/2$, where

$$|\mu| \approx \frac{\epsilon\Delta t}{\sqrt{2\Delta E}} e^{-\kappa^2\Delta E^2/2}, \quad \nu \approx \frac{\epsilon\Delta t}{2(\sqrt{\pi}\kappa^3)^{1/2}} \quad (5.3)$$

and κ is a length scale setting the spatial range of the interaction. Then, they show that the *purity* $\text{Tr}(\hat{\rho}_{q,\text{out}}^2)$ decreases monotonically with the qubit proper acceleration a , as expected.

C. Generalized second law of thermodynamics and the “self-accelerating box paradox”

In a colloquium delivered at Princeton University in the early 1970's R. Geroch raised the possibility of violating the ordinary second law of thermodynamics with the help of classical black holes. The idea was to bring *slowly* from infinity a box with proper energy E_b over the event horizon and throw it eventually inside the hole. The cycle would be closed by lifting back the ideal rope characterized by an arbitrarily small mass. Because static asymptotic observers would assign zero energy to the box at the event horizon, the hole would remain the same after engulfing it. This would challenge the ordinary second law of thermodynamics, since eventually all entropy associated with the box would vanish from the Universe with no compensating entropy increase elsewhere.

As an objection to Geroch's process, Bekenstein argued that quantum mechanics would constrain the size and energy of the box accordingly. This constraint would make it impossible for all parts of the box to reach the event horizon at once and, thus, the black hole would necessarily gain mass after engulfing the box. Then, Bekenstein (1973) conjectured that black holes would have a nonzero entropy $S_{\text{bh}} = A/4$ proportional to the

event horizon area A and formulated the *generalized second law* (GSL), namely, that the total entropy of a closed system (including that associated with black holes) would never decrease. This opened a new whole subject called “black hole thermodynamics”.⁴⁹ Now, because the GSL would be violated if the entropy of the box S satisfied $S > 2\pi E_b R$, where R is the proper radius of the smallest sphere circumscribing the box, Bekenstein conjectured in addition the existence of a new thermodynamical law, namely, that every system should have an entropy-to-energy ratio satisfying $S/E_b \leq 2\pi R$.

Later, however, Unruh and Wald (1982) concluded⁵⁰ that by taking into account the buoyancy force induced by the Hawking radiation, the GSL would not be violated even without the imposition of the constraint $S/E_b \leq 2\pi R$. The thermal ambiance outside the hole would prevent the box from descending beyond the point after which the energy delivered to the black hole would be too small to guarantee $\delta S_{\text{bh}} \geq S$ as demanded by the GSL [see also Matsas and da Silva (2005)]. However, by accepting that the box floats due to the Hawking radiation, we are led to conclude that a box in the Minkowski vacuum would be able to self-accelerate because of the Unruh thermal bath.⁵¹

The “self-accelerating box paradox” was recently revisited by Marolf and Sorkin (2002). They concluded that the heat absorbed by the box walls would increase their masses preventing the box from floating outside the black hole and, thus, self-accelerating in Minkowski spacetime. Although this would solve the self-accelerating box paradox, the GSL seemed to be in danger again. However, Marolf and Sorkin (2002) presented a way out to save the GSL without the introduction of any extra entropy-bound law by assuming the existence of “box-antibox pairs” in the Hawking radiation. Further discussion can be found in Marolf and Sorkin (2004) and in the next section.

D. Entropy and Rindler observers

Even if the GSL is not violated in the thought experiment above, one could think of more extreme situations where objects with fixed energy and volume but carrying an arbitrary amount of entropy are beamed toward a black hole. In order to analyze these situations, Marolf *et al.* (2004) considered a large enough black hole to reduce the problem again to the corresponding one

with a Rindler horizon. They concluded that, although inertial observers assign an entropy equal to the logarithm of the number of internal states n to an arbitrary object, this would not be the case for Rindler observers. For bodies with a large number of internal states, $n \gg 1$, Rindler observers would assign an entropy of only $S_R \approx E_R \beta$, where E_R is the Killing energy associated with the Rindler observers and $\beta^{-1} = \kappa/2\pi$ is the corresponding temperature associated with the surface gravity κ . As a result, a falling object which crosses the horizon would respect the GSL according to the Rindler observers no matter how many internal states (i.e. how large entropy is according to the inertial observers) it might carry. The inertial observer, at the same time, should raise no doubt about the GSL since he/she would never lose sight of the object. This illustrates how subtle the entropy concept can be in General Relativity.

E. Einstein equations as an equation of state?

The four laws of black hole mechanics, which are closely connected with the four laws of black hole thermodynamics were derived by assuming the Einstein equations. Jacobson (1995) has put forward the intriguing idea of turning the logic around and deriving the Einstein equations by assuming (i) the proportionality of entropy and the horizon area and (ii) the fundamental relation $\delta Q = T dS$, where δQ and T would be interpreted as the energy flux and Unruh temperature, respectively, seen by an accelerated observer just outside the horizon. In this sense, Einstein equations could be seen as an “equation of state” of spacetime. Because of its importance to Thermodynamics, Relativity, Information Theory and Quantum Gravity, black hole thermodynamics will undoubtedly continue attracting a lot of attention in the near future, and the Unruh effect should keep being a useful tool in the investigation of these issues.

F. Miscellaneous topics

Several other issues connected with the Unruh effect have attracted attention recently. In parallel to the investigation of the decoherence of the internal state of single accelerated detectors as commented in Sec. V.B, studies of the entanglement between independent accelerated detectors coupled to a background field can be found in the literature [see, e.g., Benatti and Floreanini (2004); Massar and Spindel (2006); Pringle (1989); Reznik *et al.* (2005)]. Recently Alsing and Milburn (2003), Alsing *et al.* (2004) and Alsing *et al.* (2006) have considered the teleportation of a state between an inertial and a Rindler observer. Although the authors’ conclusion that the fidelity of the teleportation will be in general reduced due to the Unruh effect may be correct in the end, the details will probably depend on the particular experimental set-

⁴⁹ Recently there have been some works on how the laws of thermodynamics associated with black hole horizons can be extended to what Jacobson and Parentani (2003) call *causal horizons*, i.e. the boundary of the past of any timelike curve λ of infinite proper length in the future direction.

⁵⁰ See also Unruh and Wald (1983) in response to Bekenstein (1983).

⁵¹ This would be so because of the Unruh temperature gradient along the box in the acceleration direction.

up. For instance, ideal uniformly accelerated *rigid* cavities prepared in the Rindler vacuum would keep thermal fluctuations out (Levin *et al.*, 1992) and the Unruh effect would not be responsible, in principle, for fidelity loss [see Schützhold and Unruh (2005) for further considerations]. More detailed investigations are expected in the near future when the Unruh effect should begin to be studied in connection with quantum communication (Brádlér, 2007). A different sort of question which one may pose is whether or not sufficiently accelerated Rindler observers would see broken symmetries being restored because of the high temperature of the Unruh thermal bath (Ebert and Zhukovsky, 2007; Hill, 1985; Kharzeev and Tuchin, 2005; Ohsaku, 2004). Finally, the Unruh effect has also gained importance in quantum gravity theories [see, e.g., Susskind and Uglum (1994)]⁵² and condensed matter physics (Unruh, 1981) because of its close relation with the Hawking effect.

VI. CONCLUDING REMARKS

The Unruh effect has played a crucial role in our understanding that the particle content of a field theory is observer dependent. It expresses the fact that *uniformly accelerated observers* in Minkowski spacetime associate a thermal bath of *Rindler particles* to the *no-particle state of inertial observers*. As a Quantum Field Theory effect, it does *not* depend on extra structures such as particle detectors or other measuring apparatus. By the same token, the Unruh effect does *not* require experimental confirmation any more than free quantum field theory does, although some observables can be more easily computed and interpreted from the point of view of uniformly accelerated observers using the Unruh effect. This is a matter of convenience and not of principle. We have dedicated Sec. III to discuss in detail some physical phenomena using plain quantum field theory adapted to inertial observers and shown how the same observables can be recalculated from the point of view of Rindler observers with the help of the Unruh effect.

The Unruh effect is also useful as a *theoretical laboratory* to investigate phenomena such as the thermal emission of particles from black holes and cosmological horizons because it retains many essential features of these phenomena while reducing their technical complexity. Because of the importance of the Hawking (and Hawking-like) effect(s) to Thermodynamics, Information Theory, Quantum Gravity and Cosmology, the Unruh effect should continue being a valuable tool in the future to those who intend to investigate these issues.

⁵² See also, e.g., Parentani and Potting (1989), who have considered uniformly accelerated observers in the vacuum of free strings.

Acknowledgments

We would like to thank C. Fewster, S. Fulling, B. Kay, J. Louko, W. Unruh, D. Vanzella and R. Wald for useful conversations. L. C. and G. M. are also thankful to Conselho Nacional de Desenvolvimento Científico e Tecnológico for partial support. G. M. is also thankful to Fundação de Amparo à Pesquisa do Estado de São Paulo for partial support.

APPENDIX A: Derivation of the positive-frequency solutions in the right Rindler wedge

In this Appendix we present a derivation of the normalized positive-frequency modes in the right Rindler wedge. First let us show that the normalization condition (2.87) leads to the δ -function normalization (2.88) of the function $g_{\omega k_{\perp}}(\xi)$. Define

$$S_A(\omega, \omega') \equiv \int_{-A}^{\infty} d\xi g_{\omega k_{\perp}}^*(\xi) g_{\omega' k_{\perp}}(\xi). \quad (\text{A1})$$

By the differential equation (2.86) satisfied by $g_{\omega k_{\perp}}$ and the condition (2.87) we find

$$\begin{aligned} & (\omega^2 - \omega'^2) S_A(\omega, \omega') \\ &= \left[g_{\omega' k_{\perp}}(\xi) \frac{d}{d\xi} g_{\omega k_{\perp}}^*(\xi) - g_{\omega k_{\perp}}^*(\xi) \frac{d}{d\xi} g_{\omega' k_{\perp}}(\xi) \right]_{\xi=-A} \\ &\approx \frac{1}{\pi} \{ (\omega - \omega') \sin [(\omega + \omega')A - \gamma(\omega) - \gamma(\omega')] \\ &\quad + (\omega + \omega') \sin [(\omega - \omega')A - \gamma(\omega) + \gamma(\omega')] \} \end{aligned} \quad (\text{A2})$$

for $\xi < 0$, $|\xi| \gg 1$. Then, using the formula

$$\lim_{A \rightarrow \infty} [\sin(xA)]/x = \pi \delta(x), \quad (\text{A3})$$

we find

$$\begin{aligned} \int_{-\infty}^{+\infty} d\xi g_{\omega k_{\perp}}^*(\xi) g_{\omega' k_{\perp}}(\xi) &= \lim_{A \rightarrow \infty} S_A(\omega, \omega') \\ &= \delta(\omega - \omega'), \end{aligned} \quad (\text{A4})$$

identifying bounded terms oscillating with frequency $\sim A$ with zero.

Now, by changing the variable in the differential equation (2.86) as

$$\chi \equiv \frac{\sqrt{k_{\perp}^2 + m^2}}{a} e^{a\xi}, \quad (\text{A5})$$

we find that this equation becomes

$$\left(\frac{d^2}{d\chi^2} + \frac{1}{\chi} \frac{d}{d\chi} - 1 + \frac{(\omega/a)^2}{\chi^2} \right) g_{\omega k_{\perp}} = 0. \quad (\text{A6})$$

This is a modified Bessel equation with index $i\omega/a$ (or $-i\omega/a$). Hence, together with the requirement that $|g_{\omega k_{\perp}}(\xi)|$ should not tend to infinity as $\xi \rightarrow \infty$, we find

$$g_{\omega k_{\perp}}(\xi) = C_{\omega k_{\perp}} K_{i\omega/a}[(\kappa/a)e^{a\xi}], \quad (\text{A7})$$

where $\kappa \equiv \sqrt{k_{\perp}^2 + m^2}$ and $C_{\omega k_{\perp}}$ is a constant. Now, the modified Bessel function $K_{\nu}(x)$ is defined by

$$K_{\nu}(x) \equiv -\frac{\pi}{2} \frac{i^{-\nu} J_{\nu}(ix) - i^{\nu} J_{-\nu}(ix)}{\sin \nu \pi}, \quad (\text{A8})$$

and the Bessel function $J_{\nu}(x)$ for small $|x|$ is approximated as

$$J_{\nu}(x) \approx [\Gamma(\nu + 1)]^{-1} (x/2)^{\nu}. \quad (\text{A9})$$

[See Gradshteyn and Ryzhik (1980).] Hence,

$$K_{i\omega/a}(x) \approx \frac{i\pi}{2 \sinh(\pi\omega/a)} \left\{ \frac{(x/2)^{i\omega/a}}{\Gamma(1 + i\omega/a)} - \frac{(x/2)^{-i\omega/a}}{\Gamma(1 - i\omega/a)} \right\}. \quad (\text{A10})$$

Note also

$$\begin{aligned} |\Gamma(1 + i\omega/a)|^2 &= \Gamma(1 + i\omega/a)\Gamma(1 - i\omega/a) \\ &= \frac{i\omega}{a} \Gamma(i\omega/a)\Gamma(1 - i\omega/a) \\ &= \frac{\pi\omega}{a \sinh(\pi\omega/a)}. \end{aligned} \quad (\text{A11})$$

Hence

$$K_{i\omega/a}(x) \approx \sqrt{\frac{\pi a}{\omega \sinh(\pi\omega/a)}} \left[e^{i\alpha} (x/2)^{i\omega/a} + \text{c.c.} \right], \quad (\text{A12})$$

where α is a real constant. By comparing this formula with Eq. (2.87), we find that the function $g_{\omega k_{\perp}}(\xi)$ satisfying the differential equation (2.86) and the normalization condition (2.87) can be chosen as in Eq. (2.91).

References

- Abe, O., 1990, "Response function of accelerated monopole detector in $R \times T^3$ space-time," *Phys. Rev. D* **41**, 1897–1900.
- Abramowitz, M., and I. A. Stegun, 1965, *Handbook of Mathematical Functions* (Dover, New York).
- Alsing, P. M., J. P. Dowling, and G. J. Milburn, 2005, "Ion trap simulations of quantum fields in an expanding universe," *Phys. Rev. Lett.* **94**, 220401.
- Alsing, P. M., I. Fuentes-Schuller, R. B. Mann, and T. E. Tessier, 2006, "Entanglement of Dirac fields in non-inertial frames," *Phys. Rev. A* **74**, 032326.
- Alsing, P. M., D. McMahon, and G. J. Milburn, 2004, "Teleportation in a non-inertial frame," *J. Opt. B* **6**, S834–S843.
- Alsing, P. M., and G. J. Milburn, 2003, "Teleportation with a uniformly accelerated partner," *Phys. Rev. Lett.* **91**, 180404.
- Alves, D. T., and L. C. B. Crispino, 2004, "Response rate of a uniformly accelerated source in the presence of boundaries," *Phys. Rev. D* **70**, 107703.
- Arnowitt, R., S. Deser, and C. W. Misner, 1962, in *Gravitation: an introduction to current research*, edited by L. Witten (Wiley), 227–265.
- Ashtekar, A., and A. Magnon, 1975, "Quantum fields in curved space-times," *Proc. R. Soc. London Ser. A* **346**, 375–394.
- Assmann, R., A. Blondel, B. Dehning, A. Dress, P. Grosse-Wiesmann, H. Grote, R. Jacobsen, J.-P. Koutchouk, J. Miles, M. Placidi, R. Schmidt, F. Tecker, *et al.*, 1995, in *Proceedings of the 11th international symposium on high-energy spin physics (SPIN 94)*, edited by K. J. Heller and S. L. Smith (American Institute of Physics, Conf. Proceedings. No 343, New York), 219–229.
- Audretsch, J., M. Mensky, and R. Müller, 1995, "Continuous measurement and localization in the Unruh effect," *Phys. Rev. D* **51**, 1716–1727.
- Audretsch, J., and R. Müller, 1994a, "Radiation from a uniformly accelerated particle detector: Energy, particles, and the quantum measurement process," *Phys. Rev. D* **49**, 6566–6575.
- Audretsch, J., and R. Müller, 1994b, "Spontaneous excitation of an accelerated atom: The contributions of vacuum fluctuations and radiation reaction," *Phys. Rev. A* **50**, 1755–1763.
- Baier, V. N., and V. M. Katkov, 1967, "Radiative polarization of electrons in a magnetic field," *Zh. Eksp. Teor. Fiz.* **52**, 1422–1426 [*Sov. Phys. JETP* **25** 944–947 (1967)].
- Barber, D. P., 1999, in *Proceedings of the 13th international symposium on high-energy spin physics (SPIN 98)*, edited by N. E. Tyurin, V. L. Solovianov, S. M. Troshin, and A. G. Ufimtsev (World Scientific, Singapore), 246–254.
- Barber, D. P., M. Böge, H. Böttcher, H.-D. Bremer, R. Brinkmann, W. Brückner, M. Düren, E. Gianfelice-Wendt, R. Kaiser, R. Klanner, H.-C. Lewin, M. Lomperski, *et al.*, 1994, "High spin polarization at the HERA electron storage ring," *Nucl. Instrum. Methods* **338**, 166–184.
- Barber, D. P., and S. R. Mane, 1988, "Calculations of Bell and Leinaas and Derbenev and Kondratenko for radiative electron polarization," *Phys. Rev. A* **37**, 456–463.
- Barshay, S., H. Braun, J. P. Gerber, and G. Maurer, 1980, "Possible evidence for fluctuations in the hadronic temperature," *Phys. Rev. D* **21**, 1849–1853.
- Barshay, S., and W. Troost, 1978, "A possible origin for temperature in strong interactions," *Phys. Lett. B* **73**, 437–439.
- Barut, A. O., 1980, *Electrodynamics and Classical Theory of Fields and Particles* (Dover, New York).
- Barut, A. O., and J. P. Dowling, 1990, "Quantum electrodynamics based on self-fields: On the origin of thermal radiation detected by an accelerating observer," *Phys. Rev. A* **41**, 2277–2283.
- Bautista, E., 1993, "Acceleration through the Dirac-Pauli vacuum and effects of an external field," *Phys. Rev. D* **48**, 783–789.
- Bekenstein, J. D., 1973, "Black holes and entropy," *Phys. Rev. D* **7**, 2333–2346.
- Bekenstein, J. D., 1983, "Entropy bounds and the second law for black holes," *Phys. Rev. D* **27**, 2262–2270.
- Belinskii, V. A., B. M. Karnakov, V. D. Mur, and N. B. Narozhnyi, 1997, "Does the Unruh effect exist?," *Pis'ma Zh. Eksp. Teor. Fiz.* **65**, 861–866 [*JETP Lett.* **65**, 902 (1997)].
- Bell, J. S., and J. M. Leinaas, 1983, "Electrons as accelerated thermometers," *Nucl. Phys. B* **212**, 131–150.
- Bell, J. S., and J. M. Leinaas, 1987, "The Unruh effect and quantum fluctuations of electrons in storage rings," *Nucl. Phys. B* **284**, 488–508.
- Belyanin, A., V. V. Kocharovsky, F. Capasso, E. Fry, M. S. Zubairy, and M. O. Scully, 2006, "Quantum electrodynamics of accelerated atoms in free space and in cavities," *Phys. Rev. A* **74**, 023807.

- Benatti, F., and R. Floreanini, 2004, “Entangled generation in uniformly accelerating atoms: Reexamination of the Unruh effect,” *Phys. Rev. A* **70**, 012112.
- Bernard, C., 1974, “Feynman rules for gauge theories at finite temperature,” *Phys. Rev. D* **9**, 3312–3320.
- Bièvre, S. D., and M. Merkli, 2006, “The Unruh effect revisited,” *Class. Quantum Gravity* **23**, 6525–6541.
- Birrell, N. D., and P. C. W. Davies, 1982, *Quantum fields in curved space* (Cambridge University Press, Cambridge).
- Bisognano, J. J., and E. H. Wichmann, 1975, “On the duality condition for a Hermitian scalar field,” *J. Math. Phys. (N.Y.)* **16**, 985–1007.
- Bisognano, J. J., and E. H. Wichmann, 1976, “On the duality condition for quantum fields,” *J. Math. Phys. (N.Y.)* **17**, 303–321.
- Boulware, D. G., 1975a, “Quantum field theory in Schwarzschild and Rindler spaces,” *Phys. Rev. D* **11**, 1404–1423.
- Boulware, D. G., 1975b, “Spin-1/2 quantum field theory in Schwarzschild space,” *Phys. Rev. D* **12**, 350–367.
- Boulware, D. G., 1980, “Radiation from a uniformly accelerated charge,” *Ann. Phys. (N.Y.)* **124**, 169–188.
- Bousso, R., 2002, “The holographic principle,” *Rev. Mod. Phys.* **74**, 825–874.
- Boyer, R. H., 1969, “Geodesic Killing orbits and bifurcate Killing horizons,” *Proc. Roy. Soc. London* **A311**, 245–252.
- Boyer, T. H., 1980, “Thermal effects of acceleration through random classical radiation,” *Phys. Rev. D* **21**, 2137–2148.
- Boyer, T. H., 1984, “Thermal effects of acceleration for a classical dipole oscillator in classical electromagnetic zero-point radiation,” *Phys. Rev. D* **29**, 1089–1095.
- Brádrler, K., 2007, “Eavesdropping of quantum communication from a noninertial frame,” *Phys. Rev. A* **75**, 022311.
- Brout, B., S. Massar, R. Parentani, and P. Spindel, 1995, “A primer for black hole quantum physics,” *Phys. Rep.* **260**, 329–446.
- Brown, L. S., and G. Gabrielse, 1986, “Geonium theory, Physics of a single electron or ion in a Penning trap,” *Rev. Mod. Phys.* **58**, 233–311.
- Buchholz, D., and J. Schlemmer, 2007, “Local temperature in curved spacetime,” *Class. Quantum Gravity* **24**, F25–F31.
- Calogeracos, A., 2002a, “Radiation from accelerated mirrors following prescribed relativistic asymptotically inertial trajectories,” *J. Phys. A* **35**, 3415–3434.
- Calogeracos, A., 2002b, “Radiation from perfect mirrors starting from rest and accelerating forever and the black body spectrum,” *J. Phys. A* **35**, 3435–3445.
- Calogeracos, A., 2004, “Recalculation of the spectrum of the radiation emitted during gravitational collapse,” *Phys. Lett. A* **329**, 1–7.
- Camerini, U., D. Cline, J. Learned, A. K. Mann, and L. K. Resvanis, 1975, “Measurement of the radiative electron polarization in a 2.4-GeV storage ring,” *Phys. Rev. D* **12**, 1855–1858.
- Candelas, P., and D. Deutsch, 1977, “On the vacuum stress induced by uniform acceleration or supporting the ether,” *Proc. R. Soc. London Ser. A* **354**, 79–99.
- Candelas, P., and D. Deutsch, 1978, “Fermion fields in accelerated states,” *Proc. R. Soc. Lond. Ser. A* **362**, 251–262.
- Candelas, P., and J. S. Dowker, 1979, “Field theories on conformally related space-times: Some global considerations,” *Phys. Rev. D* **19**, 2902–2907.
- Castiñeiras, J., L. C. B. Crispino, G. E. A. Matsas, and D. A. T. Vanzella, 2002, “Free massive particles with total energy $E < mc^2$ in curved spacetimes,” *Phys. Rev. D* **65**, 104019.
- Castiñeiras, J., and G. E. A. Matsas, 2000, “Low-energy sector quantization of a massless scalar field outside a Reissner-Nordström black hole and static sources,” *Phys. Rev. D* **62**, 064001.
- Castiñeiras, J., I. P. C. e Silva, and G. E. A. Matsas, 2003, “Do static sources respond to massive scalar particles from the Hawking radiation as uniformly accelerated ones do in the inertial vacuum?,” *Phys. Rev. D* **67**, 067502.
- Chen, P., and T. Tajima, 1999, “Testing Unruh radiation with ultraintense lasers,” *Phys. Rev. Lett.* **83**, 256–259.
- Chmielowski, P., 1994, “States of scalar field on spacetimes with two isometries with timelike orbits,” *Phys. Rev. A* **11**, 41–56.
- Christensen, S. M., and S. A. Fulling, 1977, “Trace anomalies and the Hawking effect,” *Phys. Rev. D* **15**, 2088–2104.
- Cognola, G., and P. Lecca, 1998, “Electromagnetic fields in Schwarzschild and Reissner-Nordström geometry: Quantum corrections to the black hole entropy,” *Phys. Rev. D* **57**, 1108–1111.
- Cole, D. C., 1985, “Properties of a classical charged harmonic oscillator accelerated through classical electromagnetic zero-point radiation,” *Phys. Rev. D* **31**, 1972–1981.
- Coleman, S. R., 1973, “There are no Goldstone bosons in two dimensions,” *Commun. Math. Phys.* **31**, 259–264.
- Copeland, E. J., P. C. W. Davies, and K. Hinton, 1984, “Acceleration radiation in a compact space,” *Class. Quantum Gravity* **1**, 179–187.
- Costa, S. S., and G. E. A. Matsas, 1995, “Background thermal contributions in testing the Unruh effect,” *Phys. Rev. D* **52**, 3466–3471.
- Crispino, L. C. B., A. Higuchi, and G. E. A. Matsas, 1998, “Interaction of Hawking radiation and a static electric charge,” *Phys. Rev. D* **58**, 084027.
- Crispino, L. C. B., A. Higuchi, and G. E. A. Matsas, 2001, “Quantization of the electromagnetic field outside static black holes and its application to low-energy phenomena,” *Phys. Rev. D* **63**, 124008.
- Crispino, L. C. B., A. Higuchi, and G. E. A. Matsas, 2004, “Is the equivalence for the response of static scalar sources in the Schwarzschild and Rindler spacetimes valid only in four dimensions?,” *Phys. Rev. D* **70**, 127504.
- Davies, P. C. W., 1975, “Scalar particle production in Schwarzschild and Rindler metrics,” *J. Phys. A* **8**, 609–616.
- Davies, P. C. W., 1976, “On the origin of black hole evaporation radiation,” *Proc. Roy. Soc. London Ser. A* **351**, 129–139.
- Davies, P. C. W., T. Dray, and C. A. Manogue, 1996, “Detecting the rotating quantum vacuum,” *Phys. Rev. D* **53**, 4382–4387.
- Davies, P. C. W., and S. A. Fulling, 1977a, “Quantum vacuum energy in two dimensional space-times,” *Proc. Roy. Soc. London Ser. A* **354**, 59–77.
- Davies, P. C. W., and S. A. Fulling, 1977b, “Radiation from moving mirrors and from black holes,” *Proc. R. Soc. Lond. Ser. A* **356**, 237–257.
- Davies, P. C. W., S. A. Fulling, and W. G. Unruh, 1976, “Energy-momentum tensor near an evaporating black hole,” *Phys. Rev. D* **13**, 2720–2723.
- Davies, P. C. W., Z. X. Liu, and A. C. Ottewill, 1989, “Particle detectors in the presence of boundaries,” *Class. Quantum Gravity* **6**, 1041–1051.
- Derbenev, Y. S., and A. M. Kondratenko, 1973, “Polarization

- kinetics of particles in storage rings,” *Zh. Eksp. Teor. Fiz.* **64**, 1918–1929 [*Sov. Phys. JETP* **37** 968–973 (1973)].
- Deser, S., and O. Levin, 1997, “Accelerated detectors and temperature in (anti-)de Sitter spaces,” *Class. Quantum Gravity* **14**, L163–L168.
- DeWitt, B. S., 1975, “Quantum field theory in curved space-time,” *Phys. Rep.* **19**, 295–357.
- DeWitt, B. S., 1979, in *General relativity: An Einstein centenary survey*, edited by S. W. Hawking and W. Israel (Cambridge University Press, Cambridge), 680–745.
- Díaz, D. E., and J. Stephany, 2002, “Rindler particles and classical radiation,” *Class. Quantum Gravity* **19**, 3753–3759.
- Ebert, D., and V. C. Zhukovsky, 2007, “Restoration of dynamically broken chiral and color symmetries for an accelerated observer,” *Phys. Lett. B* **645**, 267–274.
- Eriksen, E., and Ø. Grøn, 2000a, “Electrodynamics of hyperbolically accelerated charges I. The electromagnetic field of a charged particle with hyperbolic motion,” *Ann. Phys. (N.Y.)* **286**, 320–342.
- Eriksen, E., and Ø. Grøn, 2000b, “Electrodynamics of hyperbolically accelerated charges II. Does a charged particle with hyperbolic motion radiate?,” *Ann. Phys. (N.Y.)* **286**, 343–372.
- Eriksen, E., and Ø. Grøn, 2000c, “Electrodynamics of hyperbolically accelerated charges III. Energy-momentum of the field of a hyperbolically moving charge,” *Ann. Phys. (N.Y.)* **286**, 373–399.
- Eriksen, E., and Ø. Grøn, 2002, “Electrodynamics of hyperbolically accelerated charges IV. Energy-momentum conservation of radiating charged particles,” *Ann. Phys. (N.Y.)* **297**, 243–294.
- Eriksen, E., and Ø. Grøn, 2004, “Electrodynamics of hyperbolically accelerated charges V. The field of a charge in the Rindler space and the Milne space,” *Ann. Phys. (N.Y.)* **313**, 147–196.
- Fedotov, A. M., V. D. Mur, N. B. Narozhny, V. A. Belinskii, and B. M. Karnakov, 1999, “Quantum field aspect of the Unruh problem,” *Phys. Lett. A* **254**, 126–132.
- Ford, G. W., and R. F. O’Connell, 2006, “Is there Unruh radiation?,” *Phys. Lett. A* **350**, 17–26.
- Fregolente, D., G. E. A. Matsas, and D. Vanzella, 2006, “Semiclassical approach to the decay of protons in circular motion under the influence of gravitational fields,” *Phys. Rev. D* **74**, 045032.
- Friedman, J. L., 1978, “Generic instability of rotating relativistic stars,” *Commun. Math. Phys.* **62**, 247–278.
- Frolov, V. P., and V. L. Ginzburg, 1986, “Excitation and radiation of an accelerated detector and anomalous Doppler effect,” *Phys. Lett. A* **116**, 423–426.
- Fuentes-Schuller, I., and R. B. Mann, 2005, “Alice falls a black hole: entanglement in noninertial frames,” *Phys. Rev. Lett.* **95**, 120404.
- Fulling, S. A., 1973, “Nonuniqueness of canonical field quantization in Riemannian space-time,” *Phys. Rev. D* **7**, 2850–2862.
- Fulling, S. A., 1977, “Alternative vacuum states in static space-times with horizons,” *J. Phys. A* **10**, 917–951.
- Fulling, S. A., 1989, *Aspects of Quantum Field Theory in Curved Space-Time* (Cambridge University Press, Cambridge).
- Fulling, S. A., 2005, “Review of some recent work on acceleration radiation,” *J. Mod. Opt.* **52**, 2207–2213.
- Fulling, S. A., and P. C. W. Davies, 1976, “Radiation from a moving mirror in two dimensional space-time: Conformal anomaly,” *Proc. R. Soc. Lond. Ser. A* **348**, 393–414.
- Fulling, S. A., L. Parker, and B. L. Hu, 1974, “Conformal energy-momentum tensor in curved spacetime: Adiabatic regularization and renormalization,” *Phys. Rev. D* **10**, 3905–3924; **11**, 1714(E).
- Fulling, S. A., and S. N. M. Ruijsenaars, 1987, “Temperature, periodicity and horizons,” *Phys. Rep.* **152**, 135–176.
- Fulling, S. A., M. Sweeny, and R. M. Wald, 1978, “Singularity structure of the two-point function in quantum field theory in curved spacetime,” *Commun. Math. Phys.* **63**, 257–264.
- Fulling, S. A., and W. G. Unruh, 2004, “Comment on ‘Boundary conditions in the Unruh problem’,” *Phys. Rev. D* **70**, 048701.
- Fulton, T., and F. Rohrlich, 1960, “Classical radiation from a uniformly accelerated charge,” *Ann. Phys. (N.Y.)* **9**, 499–517.
- Gabriel, C., P. Spindel, S. Massar, and R. Parentani, 1998, “Interacting charged particles in an electric field and the Unruh effect,” *Phys. Rev. D* **57**, 6496–6510.
- Garbrecht, B., and T. Prokopec, 2004a, “Energy density in expanding universes as seen by an Unruh detector,” *Phys. Rev. D* **70**, 083529.
- Garbrecht, B., and T. Prokopec, 2004b, “Unruh response functions for scalar fields in de Sitter space,” *Class. Quantum Gravity* **21**, 4993–5004.
- Gerlach, U. H., 1983, “Absolute nature of the thermal ambience of accelerated observers,” *Phys. Rev. D* **27**, 2310–2315.
- Gerlach, U. H., 1988, “Minkowski Bessel modes,” *Phys. Rev. D* **38**, 514–521.
- Gibbons, G. W., and S. W. Hawking, 1977, “Cosmological event horizons, thermodynamics, and particle creation,” *Phys. Rev. D* **15**, 2738–2751.
- Gibbons, G. W., and M. J. Perry, 1976, “Black holes and thermal Green’s functions,” *Proc. R. Soc. London* **A358**, 467–494.
- Gingrich, R. M., and C. Adami, 2002, “Quantum entanglement of moving bodies,” *Phys. Rev. Lett.* **89**, 270402.
- Gingrich, R. M., A. J. Bergou, and C. Adami, 2003, “Entangled light in moving frames,” *Phys. Rev. A* **68**, 042102.
- Ginzburg, V. L., 1969, “Radiation and radiation friction force in uniformly accelerated motion of a charge,” *Usp. Fiz. Nauk* **98**, 569–585 [*Sov. Phys. Usp.* **12** 565–674 (1970)].
- Ginzburg, V. L., and V. P. Frolov, 1987, “Vacuum in a homogeneous gravitational field and excitation of a uniformly accelerated detector,” *Usp. Fiz. Nauk* **153**, 633–674 [*Sov. Phys. Usp.* **30** 1073–1095 (1987)].
- Ginzburg, V. L., and G. F. Zharkov, 1964, “Pion and beta-ray emission by protons moving in a magnetic field,” *Zh. Eksp. Teor. Fiz.* **47**, 2279–2284 [*Sov. Phys. JETP* **20**, 1525–1528 (1965)].
- Glauber, R. J., 1963, “The quantum theory of optical coherence,” *Phys. Rev.* **130**, 2529–2539.
- Gradshteyn, I. S., and I. M. Ryzhik, 1980, *Table of Integrals, Series and Products* (Academic Press, New York).
- Grishchuk, L. P., Y. B. Zel’dovich, and L. V. Rozhanskii, 1987, “Equivalence principle and the zero-point field fluctuation,” *Zh. Eksp. Teor. Fiz.* **92**, 20–27 [*Sov. Phys. JETP* **65** 11–14 (1987)].
- Grove, P. G., 1986, “On an inertial observer’s interpretation of the detection of radiation by linearly accelerated particle detectors,” *Class. Quantum Gravity* **3**, 801–809.
- Grove, P. G., and A. C. Ottewill, 1983, “Notes on ‘particle

- detectors,” *J. Phys. A* **16**, 3905–3920.
- Grove, P. G., and A. C. Ottewill, 1985, “Is acceleration radiation isotropic?,” *Class. Quantum Gravity* **2**, 373–380.
- Guimarães, A. C. C., G. E. A. Matsas, and D. A. T. Vanzella, 1998, “Background thermal depolarization of electrons in storage rings,” *Phys. Rev. D* **57**, 4461–4466.
- Haag, R., N. M. Hugenholtz, and M. Winnink, 1967, “On the equilibrium states in quantum statistical mechanics,” *Commun. Math. Phys.* **5**, 215–236.
- Hartle, J. B., and S. W. Hawking, 1976, “Path-integral derivation of black-hole radiance,” *Phys. Rev. D* **13**, 2188–2203.
- Hawking, S. W., 1974, “Black-hole explosions,” *Nature (London)* **248**, 30–31.
- Hawking, S. W., 1975, “Particle creation by black-holes,” *Comm. Math. Phys.* **43**, 199–220.
- Higuchi, A., 1987, “Quantisation of scalar and vector fields inside the cosmological event horizon and its application to the Hawking effect,” *Class. Quantum Gravity* **4**, 721–740.
- Higuchi, A., 1989, “Massive symmetric tensor field in spacetimes with a positive cosmological constant,” *Nucl. Phys. B* **325**, 745–765.
- Higuchi, A., 2002, “Radiation reaction in quantum field theory,” *Phys. Rev. D* **66**, 105004; **69**, 129903(E).
- Higuchi, A., and G. D. R. Martin, 2004, “Lorentz-Dirac force from QED for linear acceleration,” *Phys. Rev. D* **70**, 081701 (R).
- Higuchi, A., and G. D. R. Martin, 2005, “Classical and quantum radiation reaction for linear acceleration,” *Found. Phys.* **35**, 1149–1179.
- Higuchi, A., and G. E. A. Matsas, 1993, “Fulling-Davies-Unruh effect in classical field theory,” *Phys. Rev. D* **48**, 689–697.
- Higuchi, A., G. E. A. Matsas, and C. B. Peres, 1993, “Uniformly accelerated finite-time detectors,” *Phys. Rev. D* **48**, 3731–3734.
- Higuchi, A., G. E. A. Matsas, and D. Sudarsky, 1992a, “Bremsstrahlung and Fulling-Davies-Unruh thermal bath,” *Phys. Rev. D* **46**, 3450–3457.
- Higuchi, A., G. E. A. Matsas, and D. Sudarsky, 1992b, “Bremsstrahlung and zero-energy Rindler photons,” *Phys. Rev. D* **45**, R3308–R3311.
- Higuchi, A., G. E. A. Matsas, and D. Sudarsky, 1997, “Do static sources outside a Schwarzschild black hole radiate?,” *Phys. Rev. D* **56**, R6071–R6075.
- Higuchi, A., G. E. A. Matsas, and D. Sudarsky, 1998, “Interaction of Hawking radiation with static sources outside a Schwarzschild black hole,” *Phys. Rev. D* **58**, 104021.
- Hill, C. T., 1985, “Can the Hawking effect thaw a broken symmetry?,” *Phys. Lett. B* **155**, 343–346.
- Hinterleitner, F., 1993, “Inertial and accelerated particle detectors with back-reaction in flat space-time,” *Ann. Phys. (N.Y.)* **226**, 165–204.
- Hinton, K. J., 1983, “Particle detectors in Rindler and Schwarzschild space-times,” *J. Phys. A* **16**, 1937–1946.
- Hinton, K. J., P. C. W. Davies, and J. Pfautsch, 1983, “Accelerated observers do not detect isotropic thermal bath,” *Phys. Lett. B* **120**, 88–90.
- Hu, B. L., and A. Roura, 2004, “Comment on ‘Enhancing acceleration radiation from ground-state atoms via cavity quantum electrodynamics’,” *Phys. Rev. Lett.* **93**, 129301.
- Hu, B. L., A. Roura, and S. Shesta, 2004, “Vacuum fluctuations and moving atoms/detectors: from the Casimir Polder to the Unruh-Davies-DeWitt-Fulling effect,” *J. Opt. B* **6**, S698–S705.
- Israel, W., and J. M. Nester, 1983, “Is acceleration radiation isotropic,” *Phys. Lett. A* **98**, 329–331.
- Itzykson, C., and J.-B. Zuber, 1980, *Quantum Field Theory* (McGraw-Hill, New York).
- Iyer, B. R., and A. Kumar, 1980, “Detection of Dirac quanta in Rindler and black hole space-times and the ξ quantization scheme,” *J. Phys. A* **13**, 469–478.
- Jackson, J. D., 1976, “On understanding spin-flip synchrotron radiation and the transverse polarization of electrons in storage rings,” *Rev. Mod. Phys.* **48**, 417–433.
- Jackson, J. D., 1999, *Classical Electrodynamics* (John Wiley and Sons, New York), third edition.
- Jacobson, T., 1995, “Thermodynamics of spacetime: The Einstein equation of state,” *Phys. Rev. Lett.* **75**, 1260–1263.
- Jacobson, T., 1998, “Comment on accelerated detectors and temperature in (anti-)de Sitter spaces,” *Class. Quantum Gravity* **15**, 251–253.
- Jacobson, T., and R. Parentani, 2003, “Horizon entropy,” *Found. Phys.* **33**, 323–348.
- Járegui, R., M. Torres, and S. Hacyan, 1991, “Dirac vacuum: Acceleration and external-field effects,” *Phys. Rev. D* **43**, 3979–3989.
- Johnson, J. R., R. Prepost, D. E. Wiser, J. J. Murray, R. F. Schwitters, and C. K. Sinclair, 1983, “Beam polarization measurements at the spear storage ring,” *Nucl. Instrum. Methods* **204**, 261–268.
- Johnston, H., and S. Sarkar, 1995, “Moving mirrors and time-varying dielectrics,” *Phys. Rev. A* **51**, 4109–4115.
- Jost, R., 1965, *The general theory of quantized fields* (American Mathematical Society, Providence, R.I.).
- Kay, B. S., 1978, “Linear spin-zero quantum fields in external gravitational and scalar fields,” *Commun. Math. Phys.* **62**, 55–70.
- Kay, B. S., 1985, “The double-wedge algebra for quantum fields on Schwarzschild and Minkowski spacetimes,” *Commun. Math. Phys.* **100**, 57–81.
- Kay, B. S., 1993, “Sufficient conditions for quasifree states and an improved uniqueness theorem for quantum fields on space-times with horizons,” *J. Math. Phys.* **34**, 4519–4539.
- Kay, B. S., 2001, in *Journée Équations aux dérivées partielles, Nantes 5-9 juin, 2000 GDR 1151 (CNRS)*, IX–1–19.
- Kay, B. S., and R. M. Wald, 1991, “Theorems on the uniqueness and thermal properties of stationary, nonsingular, quasifree states on spacetimes with a bifurcate Killing horizon,” *Phys. Rep.* **207**, 49–136.
- Kharzeev, D., 2006, “Quantum black holes and thermalization in relativistic heavy ion collisions,” *Nucl. Phys. A* **774**, 315–324.
- Kharzeev, D., and K. Tuchin, 2005, “From color glass condensate to quark-gluon plasma through the event horizon,” *Nucl. Phys. A* **753**, 316–334.
- Kim, S. K., K. S. Soh, and J. H. Yee, 1987, “Zero-point field in a circular-motion frame,” *Phys. Rev. D* **35**, 557–561.
- Kim, W.-J., J. H. Brownell, and R. Onofrio, 2006, “Detectability of dissipative motion in quantum vacuum via superradiance,” *Phys. Rev. Lett.* **96**, 200402; **97**, 089902(E).
- Knudsen, L., J. P. Koutchouk, M. Placidi, R. Schmidt, M. Crozon, J. Badier, A. Blondel, and B. Dehning, 1991, “First observation of transverse beam polarization in LEP,” *Phys. Lett. B* **270**, 97–104.
- Kok, P., and U. Yurtsever, 2003, “Gravitational decoherence,” *Phys. Rev. D* **68**, 085006.
- Kolbenstvedt, H., 1987, “Anisotropy of thermal radiation by accelerated detectors; an aberration effect,” *Phys. Lett. A*

- 122**, 292 – 294.
- Kolbenstvedt, H., 1988, “Inertial interpretation of the Unruh effect,” *Phys. Rev. D* **38**, 1118 – 1121.
- Korsbakken, J. I., and J. M. Leinaas, 2004, “Fulling-Unruh effect in general stationary accelerated frames,” *Phys. Rev. D* **70**, 084016.
- Krivitskii, V. S., and V. N. Tsytovich, 1991, “Average radiation-reaction force in quantum electrodynamics,” *Usp. Fiz. Nauk* **161**, 125–141 [*Sov. Phys. Usp.* **34**, 250–258 (1991)].
- Kruskal, M. D., 1960, “Maximal extension of Schwarzschild metric,” *Phys. Rev.* **119**, 1743–1745.
- Kubo, R., 1957, “Statistical-mechanics theory of irreversible processes. I. General theory and simple application to magnetic and conduction problems,” *J. Phys. Soc. Jap.* **12**, 570–586.
- Langlois, P., 2005, “Imprints of spacetime topology in the Hawking-Unruh effect,” gr-qc/0510127, PhD thesis.
- Langlois, P., 2006, “Causal particle detectors and topology,” *Ann. Phys. (N.Y.)* **321**, 2027–2070.
- Leinaas, J. M., 1999, in *Proceedings of the 15th Advanced ICF Beam Dynamics Workshop on Quantum Aspects of Beam Physics*, edited by P. Chen (World Scientific, Singapore), 577–593.
- Leinaas, J. M., 2002, in *Proceedings of the 18th Advanced ICF Beam Dynamics Workshop on Quantum Aspects of Beam Physics*, edited by P. Chen (World Scientific, Singapore), 336–352.
- Letaw, J. R., 1981, “Stationary world lines and the vacuum excitation of noninertial detectors,” *Phys. Rev. D* **23**, 1709–1714.
- Letaw, J. R., and J. D. Pfatsch, 1982, “The stationary coordinate systems in flat spacetime,” *J. Math. Phys.* **23**, 425–431.
- Letaw, J. R., and J. D. Pfautsch, 1980, “Quantized scalar field in rotating coordinates,” *Phys. Rev. D* **22**, 1345–1351.
- Levin, O., Y. Peleg, and A. Peres, 1992, “Quantum detector in an accelerated cavity,” *J. Phys. A* **25**, 6471–6481.
- Levin, O., Y. Peleg, and A. Peres, 1993, “Unruh effect for circular motion in a cavity,” *J. Phys. A* **26**, 3001–3011.
- Lin, S.-Y., and B. L. Hu, 2006, “Accelerated detector-quantum field correlations: From vacuum fluctuations to radiation flux,” *Phys. Rev. D* **73**, 124018.
- Louko, J., and A. Satz, 2006, “How often does the Unruh-DeWitt detector click? Regularization by a spatial profile,” *Class. Quantum Gravity* **23**, 6321–6343.
- Marolf, D., D. Minic, and S. F. Ross, 2004, “Notes on spacetime thermodynamics and the observer dependence of entropy,” *Phys. Rev. D* **69**, 064006.
- Marolf, D., and R. D. Sorkin, 2002, “Perfect mirrors and the self-accelerating box paradox,” *Phys. Rev. D* **66**, 104004.
- Marolf, D., and R. D. Sorkin, 2004, “On the status of highly entropic objects,” *Phys. Rev. D* **69**, 024014.
- Martin, P. C., and J. Schwinger, 1959, “Theory of many-particle systems. I,” *Phys. Rev.* **115**, 1342–1373.
- Martinetti, P., and C. Rovelli, 2003, “Diamond’s temperature: Unruh effect for bounded trajectories and thermal time hypothesis,” *Class. Quantum Gravity* **20**, 4919–4931.
- Massar, S., and R. Parentani, 1996, “From vacuum fluctuation to radiation. I. Accelerated detectors,” *Phys. Rev. D* **54**, 7426–7443.
- Massar, S., R. Parentani, and R. Brout, 1993, “On the problem of the uniformly accelerated oscillator,” *Class. Quantum Gravity* **10**, 385–395.
- Massar, S., and P. Spindel, 2006, “Einstein-Podolsky-Rosen correlations between two uniformly accelerated oscillators,” *Phys. Rev. D* **74**, 085031.
- Matsas, G. E. A., 1996, “Rindler and Minkowski particles relationship revisited,” *Phys. Lett. B* **380**, 24–28.
- Matsas, G. E. A., and A. R. R. da Silva, 2005, “New thought experiment to test the generalized second law of thermodynamics,” *Phys. Rev. D* **71**, 107501.
- Matsas, G. E. A., and D. A. T. Vanzella, 1999, “Decay of protons and neutrons induced by acceleration,” *Phys. Rev. D* **59**, 094004.
- Montague, B. W., 1984, “Polarized beams in high energy storage rings,” *Phys. Rep.* **113**, 1–96.
- Moore, G. T., 1970, “Quantum theory of the electromagnetic field in a variable-length one-dimensional cavity,” *J. Math. Phys. (N.Y.)* **11**, 2679–2691.
- Mourou, G. A., T. Tajima, and S. V. Bulanov, 2006, “Optics in the relativistic regime,” *Rev. Mod. Phys.* **78**, 309–371.
- Müller, R., 1997, “Decay of accelerated particles,” *Phys. Rev. D* **56**, 953–960.
- Myhrvold, N. P., 1985, “Thermal radiation from accelerated electrons,” *Ann. Phys. (N.Y.)* **160**, 102–113.
- Narnhofer, H., I. Peter, and W. Thirring, 1996, “How hot is the de Sitter space?,” *Int. J. Mod. Phys. B* **10**, 1507–1520.
- Narozhny, N. B., A. M. Fedotov, B. M. Karnakov, V. D. Mur, and V. A. Belinskii, 2002, “Boundary conditions in the Unruh problem,” *Phys. Rev. D* **65**, 025004.
- Narozhny, N. B., A. M. Fedotov, B. M. Karnakov, V. D. Mur, and V. A. Belinskii, 2004, “Reply to ‘Comment on ‘Boundary conditions in the Unruh problem’ ’,” *Phys. Rev. D* **70**, 048702.
- Nikishov, A. I., 1970, “Quantum processes in a constant electric field,” *Zh. Eksp. Teor. Fiz.* **59**, 1262–1272 [*Sov. Phys. JETP* **32** 690–694 (1971)].
- Nikishov, A. I., and V. I. Ritus, 1964a, “Quantum processes in the field of a plane electromagnetic wave and in a constant field,” *Zh. Eksp. Teor. Fiz.* **46**, 1768–1781 [*Sov. Phys. JETP* **19**, 1191–1199 (1964)].
- Nikishov, A. I., and V. I. Ritus, 1964b, “Quantum processes in the field of a plane electromagnetic wave and in a constant field. I,” *Zh. Eksp. Teor. Fiz.* **46**, 776–796 [*Sov. Phys. JETP* **19** 529–541 (1964)].
- Nikishov, A. I., and V. I. Ritus, 1988, “Processes induced by a charged particle in an electric field and the Unruh heat-bath concept,” *Zh. Eksp. Teor. Fiz.* **94**, 31–47 [*Sov. Phys. JETP* **68** 1313–1321 (1988)].
- Obadia, N., 2007, “Moving detectors in cavities,” *Phys. Rev. D* **76**, 045013.
- Obadia, N., and M. Milgrom, 2007, “Unruh effect for general trajectories,” *Phys. Rev. D* **75**, 065006.
- Ohsaku, T., 2004, “Dynamical chiral symmetry breaking and its restoration for an accelerated observer,” *Phys. Lett. B* **599**, 102–110.
- Oriti, D., 2000, “The spinor field in Rindler spacetime: an analysis of the Unruh effect,” *Nuovo Cim.* **B115**, 1005–1024.
- Padmanabhan, T., 1985, “Why does an accelerated detector click?,” *Class. Quantum Gravity* **2**, 117–126.
- Parentani, R., 1995, “The recoils of the accelerated detector and the decoherence of its fluxes,” *Nucl. Phys. B* **454**, 227–249.
- Parentani, R., and S. Massar, 1997, “Schwinger mechanism, Unruh effect, and production of accelerated black holes,” *Phys. Rev. D* **55**, 3603–3613.

- Parentani, R., and R. Potting, 1989, “Accelerating observer and the Hagedorn temperature,” *Phys. Rev. Lett.* **63**, 945–948.
- Parker, L., 1968, “Particle creation in expanding universes,” *Phys. Rev. Lett.* **21**, 562–564.
- Peña, I., C. Chryssomalakos, A. Corichi, and D. Sudarsky, 2005, “On a puzzle about bremsstrahlung as described by coaccelerated observers,” *Phys. Rev. D* **72**, 084018.
- Peres, A., P. F. Scudo, and D. R. Terno, 2002, “Quantum entropy and Special Relativity,” *Phys. Rev. Lett.* **88**, 230402.
- Peres, A., and D. R. Terno, 2004, “Quantum information and relativity theory,” *Rev. Mod. Phys.* **76**, 93–123.
- Pringle, L. N., 1989, “Rindler observers, correlated states, boundary conditions, and the meaning of the thermal spectrum,” *Phys. Rev. D* **39**, 2178–2186.
- Raine, D. J., D. W. Sciama, and P. G. Grove, 1991, “Does a uniformly accelerated quantum oscillator radiate?,” *Proc. Roy. Soc. London Ser. A* **435**, 205–215.
- Reeh, H., and Schlieder, 1961, “Bemerkungen zur Unitäräquivalenz von Lorentzinvarianten Feldern,” *Nuovo Cim.* **22**, 1051–1068.
- Ren, H., and E. J. Weinberg, 1994, “Radiation from a moving scalar source,” *Phys. Rev. D* **49**, 6526–6533.
- Reznik, B., 1998, “Unruh effect with back reaction – A first quantized system,” *Phys. Rev. D* **57**, 2403–2409.
- Reznik, B., A. Retzker, and J. Silman, 2005, “Violating Bell’s inequality in vacuum,” *Phys. Rev. D* **71**, 042104.
- Rindler, W., 1966, “Kruskal space and the uniformly accelerated frame,” *Am. J. Phys.* **34**, 1174–1178.
- Ritus, V. I., 1969, “Effect of an electromagnetic field on decays of elementary particles,” *Zh. Eksp. Teor. Fiz.* **56**, 986–1005 [*Sov. Phys. JETP* **29**, 532–541 (1969)].
- Rogers, J., 1988, “Detector for the temperaturelike effect of acceleration,” *Phys. Rev. Lett.* **61**, 2113–2116.
- Rohrlich, F., 1961, “The definition of electromagnetic radiation,” *Nuovo Cimento* **21**, 811–822.
- Rosu, H. C., 2001, “Hawking-like and Unruh-like effects: Toward experiments?,” *Gravitation Cosmol.* **7**, 1–17.
- Sanchez, N., 1981, “Quantum detection on the vacuum by non-uniformly accelerated observers,” *Phys. Lett. B* **105**, 375–380.
- Sanchez, N., 1985, “Comments on quantum detection and the anisotropy of thermal radiation by accelerated observers,” *Phys. Lett. A* **112**, 133 – 137.
- Satz, A., 2007, “Then again, how often does the Unruh-DeWitt detector click if we switch it carefully?,” *Class. Quantum Gravity* **24**, 1719–1731.
- Schlicht, S., 2004, “Considerations on the Unruh effect: Causality and regularization,” *Class. Quantum Gravity* **21**, 4647–4660.
- Schützhold, R., G. Schaller, and D. Habs, 2006, “Signatures of the Unruh effect from electrons accelerated by ultrastrong laser fields,” *Phys. Rev. Lett.* **97**, 121302.
- Schützhold, R., and W. G. Unruh, 2005, “Comment on ‘Teleportation with a uniformly accelerated partner’,”, *quant-ph/0506028*.
- Sciama, D. W., P. Candelas, and D. Deutsch, 1981, “Quantum field theory, horizon and thermodynamics,” *Adv. Phys.* **30**, 327–366.
- Scully, M. O., V. Kocharovsky, A. Belyanin, E. Fry, and F. Capasso, 2004, “Scully et al Reply to Comment on ‘Enhancing acceleration radiation from ground-state atoms via cavity quantum electrodynamics’,” *Phys. Rev. Lett.* **93**, 129302.
- Scully, M. O., V. V. Kocharovsky, A. Belyanin, E. Fry, and F. Capasso, 2003, “Enhancing acceleration radiation from ground-state atoms via cavity quantum electrodynamics,” *Phys. Rev. Lett.* **91**, 243004.
- Sewell, G. L., 1982, “Quantum fields on manifolds: PCT and gravitationally induced thermal states,” *Ann. Phys. (N.Y.)* **141**, 201–224.
- Sextl, R. U., and H. K. Urbantke, 1969, “Production of particles by gravitational fields,” *Phys. Rev.* **179**, 1247–1250.
- Soffel, M., B. Muller, and W. Greiner, 1980, “Dirac particles in Rindler space,” *Phys. Rev. D* **22**, 1935–1937.
- Sokolov, A. A., and I. M. Ternov, 1963, “On polarization and spin effects in the theory of synchrotron radiation,” *Dokl. Akad. Nauk. SSSR* **153**, 1052–1054 [*Sov. Phys. Dokl.* **7** 1203–1205 (1964)].
- Sriramkumar, L., and T. Padmanabhan, 1996, “Finite-time response of inertial and uniformly accelerated Unruh-DeWitt detectors,” *Class. Quantum Gravity* **13**, 2061–2079.
- Streater, R. F., and A. S. Wightman, 1964, *PCT, spin and statistics, and all that* (Benjamin, New York).
- Susskind, L., and J. Uglum, 1994, “Black hole entropy in canonical quantum gravity and superstring theory,” *Phys. Rev. D* **50**, 2700–2711.
- Suzuki, H., and K. Yamada, 2003, “Analytic evaluation of the decay rate for an accelerated proton,” *Phys. Rev. D* **67**, 065002.
- Svaiter, B. F., and N. F. Svaiter, 1992, “Inertial and noninertial particle detectors and vacuum fluctuations,” *Phys. Rev. D* **46**, 5267–5277.
- Takagi, S., 1984, “On the response of a particle detector in a circular motion,” *Prog. Theor. Phys.* **72**, 1270–1272.
- Takagi, S., 1986, “Vacuum noise and stress induced by uniform acceleration – Hawking-Unruh effect in Rindler manifold of arbitrary dimension,” *Prog. Theor. Phys. Suppl.* **88**, 1–142.
- Tolman, R. C., 1934, *Relativity, Thermodynamics and Cosmology* (Oxford University Press, Oxford).
- Uhlmann, M., G. Plunien, R. Schützhold, and G. Soff, 2004, “Resonant cavity photon creation via the dynamical Casimir effect,” *Phys. Rev. Lett.* **96**, 193601.
- Unruh, W. G., 1976, “Notes on black-hole evaporation,” *Phys. Rev. D* **14**, 870–892.
- Unruh, W. G., 1977, in *Proceedings of the 1st Marcel Grossmann Meeting on General Relativity*, edited by R. Ruffini (North-Holland, Amsterdam), 527–536.
- Unruh, W. G., 1981, “Experimental black-hole evaporation?,” *Phys. Rev. Lett.* **46**, 1351–1353.
- Unruh, W. G., 1992, “Thermal bath and decoherence of Rindler spacetimes,” *Phys. Rev. D* **46**, 3271–3277.
- Unruh, W. G., 1998, “Acceleration radiation for orbiting electrons,” *Phys. Rep.* **307**, 163–171.
- Unruh, W. G., 1999, in *Proc. Quantum Aspects of Beam Physics Conf.*, edited by P. Chen (World Scientific, Singapore).
- Unruh, W. G., and R. M. Wald, 1982, “Acceleration radiation and the generalized second law of thermodynamics,” *Phys. Rev. D* **25**, 942–958.
- Unruh, W. G., and R. M. Wald, 1983, “Entropy bounds, acceleration radiation, and the generalized second law,” *Phys. Rev. D* **27**, 2271–2276.
- Unruh, W. G., and R. M. Wald, 1984, “What happens when an accelerating observer detects a Rindler particle,” *Phys. Rev. D* **29**, 1047–1056.

- Unruh, W. G., and N. Weiss, 1984, “Acceleration radiation in interacting field theories,” *Phys. Rev. D* **29**, 1656–1662.
- Vanzella, D. A. T., and G. E. A. Matsas, 2000, “Weak decay of uniformly accelerated protons and related processes,” *Phys. Rev. D* **63**, 014010.
- Vanzella, D. A. T., and G. E. A. Matsas, 2001, “Decay of accelerated protons and the existence of the Fulling-Davies-Unruh effect,” *Phys. Rev. Lett.* **87**, 151301.
- Wald, R. M., 1978, “Trace anomaly of a conformally invariant quantum field in curved spacetime,” *Phys. Rev. D* **17**, 1477–1484.
- Wald, R. M., 1984, *General Relativity* (University of Chicago Press, Chicago).
- Wald, R. M., 1994, *Quantum Field Theory in Curved Spacetime and Black Hole Thermodynamics (Chicago Lectures in Physics)* (University of Chicago Press, Chicago).
- Wald, R. M., 2001, “The thermodynamics of black holes,” *Liv. Rev. Relativity* **4**, Irr-2001-6.
- Wightman, A. S., 1956, “Quantum field theory in terms of vacuum expectation values,” *Phys. Rev.* **101**, 860–866.
- Yablonovitch, E., 1989, “Accelerating reference frame for electromagnetic waves in a rapidly growing plasma: Unruh-Davies-Fulling-DeWitt radiation and the nonadiabatic Casimir effect,” *Phys. Rev. Lett.* **62**, 1742–1745.
- Yablonovitch, E., J. P. Heritage, D. E. Aspnes, and Y. Yafet, 1989, “Virtual photoconductivity,” *Phys. Rev. Lett.* **63**, 976–979.
- Yao, W.-M., C. Amsler, D. Asner, R. M. Barnett, J. Beringer, P. R. Burchat, C. D. Carone, C. Caso, O. Dahl, G. D’Ambrosio, A. D. Gouvea, M. Doser, *et al.*, 2006, “Review of particle physics,” *J. Phys. G* **33**, 1–1232.
- Zharkov, G. F., 1965, “Pion emission and beta decay of a proton moving in a magnetic field,” *Yad. Fiz.* **1**, 173–182 [*Sov. J. Nucl. Phys.* **1**, 120–126 (1965)].
- Zhu, Z., and H. Yu, 2007, “Fulling-Davies-Unruh effect and spontaneous excitation of an accelerated atom interacting with a quantum scalar field,” *Phys. Lett. B* **645**, 459–465.
- Zurek, W. H., 1991, “Decoherence and the transition from quantum to classical,” *Phys. Today* **44**, 36–44.