

MAPK Cascades as Feedback Amplifiers

Herbert M Sauro¹³ and Brian Ingalls²³

¹ Corresponding Author: Department of Bioengineering,
University of Washington, Seattle, WA, 98195

²Department of Applied Mathematics, University of Waterloo,
Waterloo, Ontario, Canada N2L 3G1

³ This work was largely carried out while employed at the
California Institute of Technology during 2002.

Running Head: Biological Feedback Amplifiers

Abstract

Interconvertible enzyme cascades, exemplified by the mitogen activated protein kinase (MAPK) cascade, are a frequent mechanism in signal transduction pathways. There has been much speculation as to the role of these pathways, and how their structure is related to their function. A common conclusion is that the cascades serve to amplify biochemical signals so that a single bound ligand molecule might produce a multitude of second messengers. Some recent work has focused on a particular feature present in some MAPK pathways – a negative feedback loop which spans the length of the cascade. This is a feature that is shared by a man-made engineering device, the feedback amplifier. We propose a novel interpretation: that by wrapping a feedback loop around an amplifier, these cascades may be acting as biochemical feedback amplifiers which imparts i) increased robustness with respect to internal perturbations; ii) a linear graded response over an extended operating range; iii) insulation from external perturbation, resulting in functional modularization. We also report on the growing list of experimental evidence which supports a graded response of MAPK with respect to Epidermal Growth Factor. This evidence supports our hypothesis that in these circumstances MAPK cascade, may be acting as a feedback amplifier.

Introduction

The ability of biological cells to receive and respond to signals, such as environmental conditions, mating potential or developmental cues is considered a fundamental characteristic of life. In multicellular organisms, cells will often receive a flood of signals aimed at regulating their behavior. It is not surprising therefore to discover that cells have evolved highly elaborate and complex networks of ‘signaling’ pathways whose role is to coordinate and integrate this information and to elicit a suitable response. One of the most surprising results to have come to light in the study of these signaling pathways is the remarkable degree of evolutionary conservation that exists among widely different organisms (Marshall, 1994). The family of MAPK (mitogen-activated protein kinase) pathways, in particular, is highly conserved.

The MAPK pathways, besides being highly conserved, are common components in signal transduction pathways (Chang & Karin, 2001). Virtually all eukaryotic cells that have been examined (ranging from yeast to man) possess multiple MAPK pathways each of which responds to multiple inputs. In mammalian systems MAPK pathways are activated by a wide range of input signals including a variety of growth factors and environmental stresses such as osmotic shock and ischemic injury (Kyriakis & Avruch, 2002; Gomperts *et al.*, 2002). Once the MAPK pathways have integrated these signals, they coordinately activate gene transcription with resulting changes in protein expression leading to cell cycling, cell death and cell differentiation.

Modern methods of genetic manipulation have allowed extensive investigation of MAPK pathways in budding yeast. Through this work (Marshall, 1994) the notion of multiple parallel MAPK signaling pathways was developed. At least six *S. cerevisiae* MAPK cascades have been identified (Banuett, 1998). Many of these pathways receive multiple signals, some of which are shared with other MAPK cascades. This signalling architecture allows for cross-talk between the input stages of the MAPK pathways. The emerging picture is that of signal transduction pathways consisting of least two functional layers: a decision-making layer responsible for receiving and integrating the inputs, which are then channeled to one or more MAPK stages in a second layer for final delivery to the target, in this case transcriptional modulation (see Figure 1).

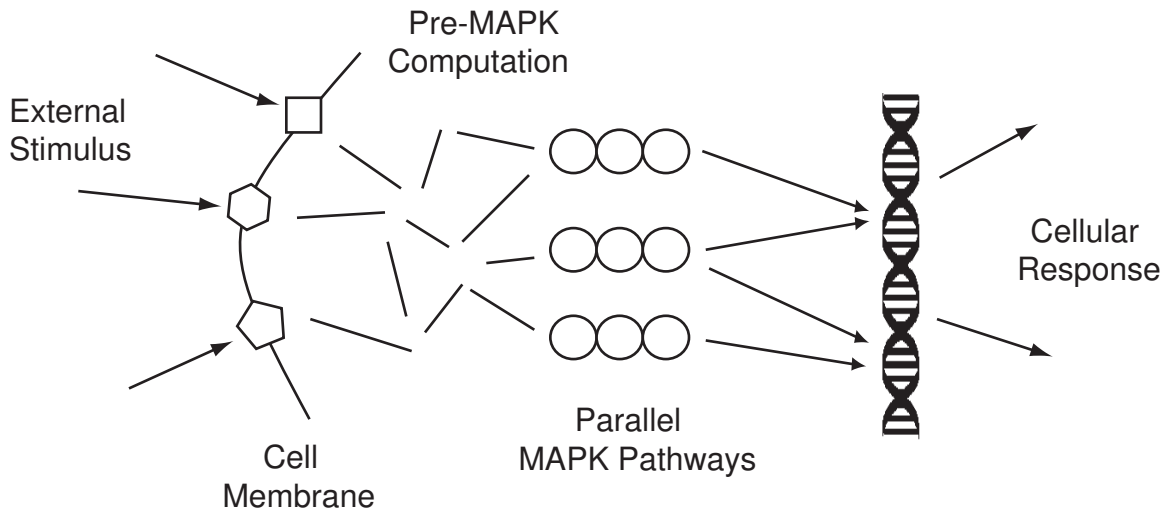

Figure 1: MAPK Pathways

In this paper we address the functional nature of the MAPK pathway stage. What properties do MAPK pathways possess which might suggest their role in this biochemical computation? There are a number of characteristics which are common to all MAPK families and have a bearing on how we should answer this question. Firstly, the structure of these pathways can give rise to extremely high gains on the input/output response, of the order of hundreds of thousands in some cases. Secondly, MAPK cascades always appear as the final stage of a signal transduction pathway. To our knowledge there has never been reported any further networks between the last stage of a MAPK cascade and transcriptional modulation. Finally, these cascades appear to have little interaction with the rest of the system beyond their basic input/output behavior (Widmann *et al.*, 1999). In fact, this functional separation may be achieved in part by a physical separation, as some evidence suggests that the components of MAPK cascades are held together by scaffolding proteins which may provide a spatial separation from the rest of the signal transduction network (Widmann *et al.*, 1999; Garrington & Johnson, 1999).

These observations lead to a satisfying interpretation of MAPK cascades as modular components of signal transduction pathways which act to amplify their inputs. Others have also noted the possibility that MAPK cascades can act as switch devices (Huang & Ferrell, 1996), or even delay systems (Nelson *et al.*, 2004; Ihekwaba *et al.*, 2005). In this paper we wish to investigate the hypothesis that MAPK pathways, may in some circumstances be acting as feedback amplifiers.

The paper is organized as follows. The structure and function of MAPK cascades is considered first. The concept of Feedback amplifiers is introduced next, where the analysis is kept simple by considering linear systems. The benefits of feedback in the MAPK cascade are illustrated in the next section, both by simulation results and by analysis of the linearization of the model. A discussion of experimental evidence is included in the last section.

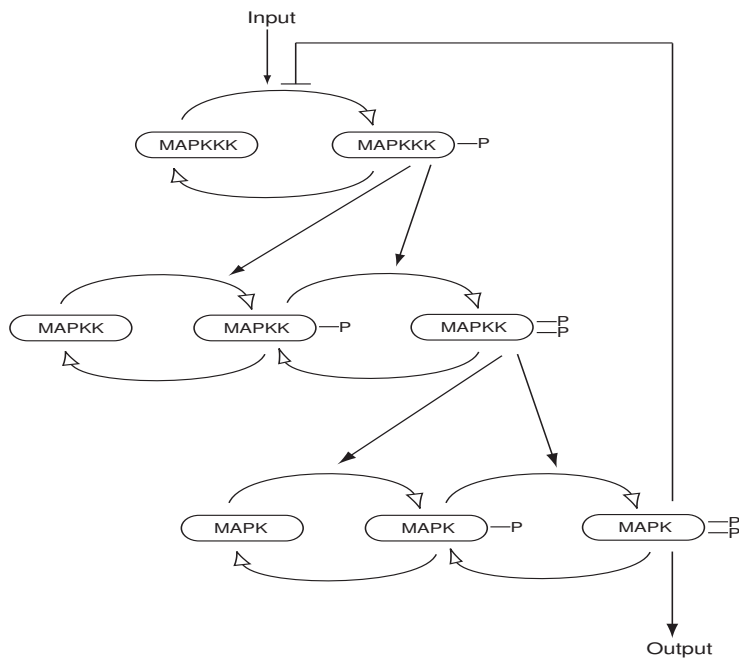

Figure 2: Schematic of a Generic MAPK Pathway

Structure and Properties of Cascades As discussed in the introduction, MAPK cascades are common components of extracellular signal-regulated pathways. Experimental results suggest that these cascades are highly conserved across a wide spectrum of organisms (Marshall, 1994). In addition, the basic structure of the pathway in each MAPK family is essentially the same. This implies that the functional roles played by each family is the same, or very similar. The architecture involves three protein kinases (see Figure 2), each of which activates the kinase below only after being phosphorylated from above.

A compelling explanation of the function of these cascades is that they provide a switch-like response (Chock & Stadtman, 1977; Goldbeter & Koshland, 1984) which may be used in decision making, for example in development. It has been appreciated for many years that even a single cycle can elicit switch-like behavior under conditions in which the cycle reactions are operating near saturation (Goldbeter & Koshland, 1981). A more general analysis was made by Small and Fell (Fell & Small, 1986; Small & Fell, 1990) and Cardenas and Cornish-Bowden (Cárdenas & Cornish-Bowden, 1989) using metabolic control analysis and subsequently extended by Kahn and Westerhoff (Kahn & Westerhoff, 1991) and Kholodenko et al. (Kholodenko *et al.*, 1997). Arguments for switch-like behavior are supported by experimental evidence that some MAPK cascades may exhibit positive feedbacks leading to bistable behavior. (Ferrell, 2002; Bhalla *et al.*, 2002)

During a switching action, the ‘output’ of the system (the concentration of activated kinase at the end of the cascade MAPK-PP) is switched from its basal (non-stimulated) level to saturation (i.e. 100% activation), as the ‘input’ (e.g. ligand level) crosses a threshold value (Huang & Ferrell, 1996). This behavior is often described by the analogy to a cooperative enzyme – the cascade acts as a single enzyme with a large Hill coefficient. Along with its function as a memoryless switch, the cascade also amplifies the input signal, since the pool of MAPK typically has a concentration orders of magnitude higher than the ligand levels which activate the response.

In addition studies have indicated the presence of one or more negative feedback loops surrounding the MAPK cascade (Downward, 1996). This feedback is mediated by phosphorylation of SOS by ERKPP which in turn results in dissociation of the ShcGS complex thus interfering with Ras activation of the ERK pathway.

In this paper we suggest a novel interpretation of the role of negative feedback in a MAPK cascade, inspired by analogous situations in electrical engineering. Amplifiers are some of the most ubiquitous components in electrical circuits. All amplifiers necessarily saturate above and below certain input levels. They are designed so that their ‘active range’ covers the levels of input of interest. When this active range is small, the result is switch-like behavior, suggesting an analogy with MAPK pathways.

While amplification of signals is a common function of electrical circuits, amplifiers are rarely used in isolation. Rather, negative feedback is introduced from output to input, resulting in a *feedback amplifier*. These devices represent the key component of all (electrical) analog computation, since they allow the construction of functional *operational amplifiers*. The benefits of wrapping feedback around an amplifier may not be intuitively obvious, and indeed came as a surprise to many people when the idea was introduced. The primary improvements achieved with feedback are i) increased robustness with respect to internal perturbations; ii) a linear graded response over an extended operating range; iii) insulation from external perturbation, resulting in functional modularization.

In the electronics industry these properties are exploited in the manufacture of amplifiers. Cheap, low tolerance, high-gain amplifier components are mass produced. These amplifiers are not suitable for use alone, but rather are coupled with high tolerance passive resistor components

which implement feedback and thus significantly improve the characteristics of the amplifier.

We present the hypothesis that evolution may have hit upon the benefits of the feedback amplifier, and is implementing it in the MAPK cascade. In doing so we build on the work of others who have suggested that negative feedback may serve to improve the function of biochemical amplifiers (Bhalla *et al.*, 2002; Cinquin & Demongeot, 2002; Savageau, 1976).

In its active range, the cascade would act solely as an amplifier – providing a faithful amplification of the input presented to it from the mechanisms upstream. To these upstream mechanisms (which we do not address) would then be relegated the all-important task of integrating the myriad extracellular signals received by the cell. The MAPK cascade then plays the role of amplifying the results of those biochemical calculations to the point where they can produce a response in the cell. This is an obvious strategy, again exemplified in electrical engineering. Analog computers perform their calculations on tiny currents and voltages then, when finished, amplify the results so that they may be useful. The same energy-conserving principle may be used in the cell. Signals may be processed at small concentrations (with correspondingly low needs for biosynthesis of enzymes). Only after the computation is complete and the appropriate response has been determined is it necessary to amplify concentrations to the point where they will affect the activity of the cell.

That the MAPK pathway serves as the tail-end for wide variety of different signaling pathways indicates that it may be an example of *modular* design. This design principle produces component which can play their role in a number of different situations. It may be that the MAPK cascade serves as a “plug-and-play” amplifier with specificity determined by inclusion of the appropriate “adapter”, serving to connect the cascade to its input and output. This interpretation is supported by the finding that the “internal” mechanism of the MAPK cascade (i.e. the phosphorylation of MAPKK and MAPK) are highly conserved while the “connectors” (phosphorylation of MAPKKK and the target of MAPK-PP) vary according to the role of the cascade (Marshall, 1994; Garrington & Johnson, 1999)

This conservation of structure and mechanism is a great boon to the modeler. Based on this evidence we can have some confidence that analysis of a model of the cascade may provide insight into the biochemistry of a wide variety of signal transduction pathways. With that hope in mind, we present an analysis of a model of the Raf/Ras/MEK/ERK pathway presented in (Kholodenko, 2000) and based on work in (Huang & Ferrell, 1996). The model does not include the important mechanisms which occur upstream from the cascade.

Despite the evidence for conservation of the cascade, there are variations in structure and mechanism which may or may not correspond to differences in pathway response. Common variants are cascades which are longer or shorter than three kinases, or in which the kinases are phosphorylated at only one site. Previous work suggests that such differences may not have much of an effect on the function of the pathway (Brightman & Fell, 2000; Goldbeter & Koshland, 1984). A more extreme variation is a cascade in which the activation is not performed by kinases, but rather by methylation or acetylation. There are fewer experimental results in such cases, but work by modelers suggests that an analogous functionality would be expected. In particular, in this paper we are concerned primarily with the cascade’s qualitative role as an amplifier, which will likely be maintained over a wide variety of biochemical implementations.

Feedback Amplifiers Rather than species concentrations, the amplifiers used by electrical engineers are designed to amplify current or voltage in an electrical circuit. A simple example is the voltage amplifier (i.e. voltage controlled voltage source) which samples the voltage in one part of a circuit and produces a proportional voltage in another.

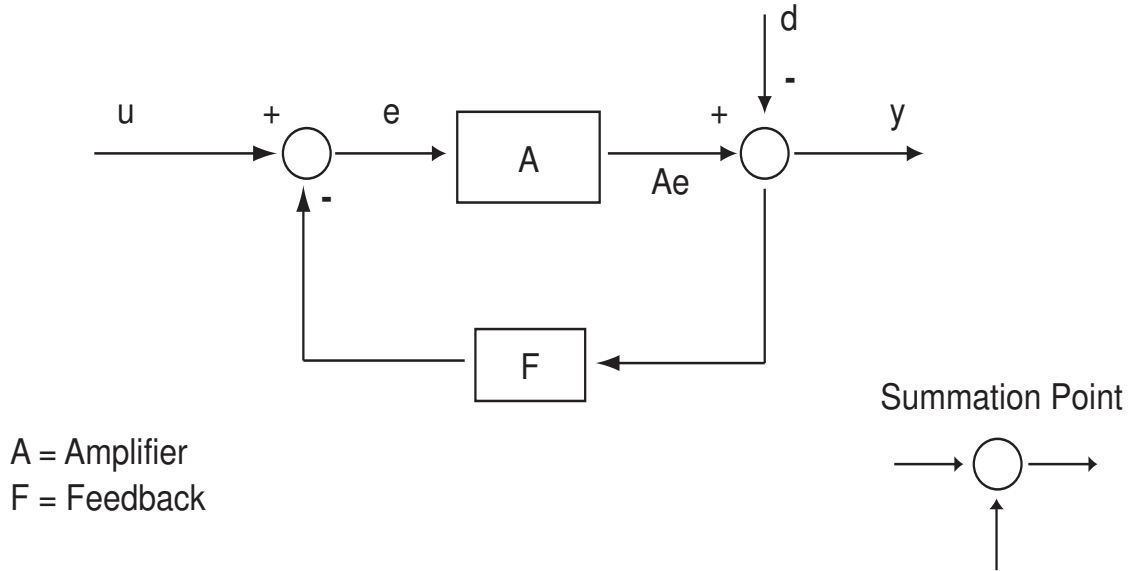

Figure 3: Linear Feedback System: d = disturbance; u = input; y = output

Amplification is one of the most fundamental tasks one can demand of an electrical circuit. One of the challenges facing engineers in the 1920's was how to design amplifiers whose performance was robust with respect to the internal parameters of the system and which could overcome inherent nonlinearities of their implementation. This problem was especially critical to the effort to implement long distance telephone lines across the U.S.A.

These difficulties were overcome by the introduction of the *feedback amplifier*, designed in 1927 by Harold S. Black (Mindell, 2000), who was an engineer for Western Electric (the forerunner of Bell Labs). The basic idea was to introduce a negative feedback loop from the output of the amplifier to its input. At first sight, the addition of negative feedback to an amplifier might seem counterproductive*. Indeed Black had to contend with just such opinions when introducing the concept – his director at Western Electric dissuaded him from following up on the idea, and his patent applications were at first dismissed. In his own words, “our patent application was treated in the same manner as one for a perpetual motion machine” (Black, 1977).

While Black's detractors were correct in insisting that the negative feedback would reduce the gain of the amplifier, they failed to appreciate his key insight – that the reduction in gain is accompanied by increased robustness of the amplifier and improved fidelity of signal transfer. This trade-off between gain and system performance can be elegantly demonstrated by considering linear systems, to which we now turn.

Results

Consider the block diagram in Figure 3. We will consider only the steady-state behavior of the system, so we take the input u , the output y , the error e , and the disturbance d to be constants.

*As Horowitz and Hill put it in (Horowitz & Winfield, 1990) ‘Negative feedback is the process of coupling the output back in such a way as to cancel some of the input. You might think that this would only have the effect of reducing the amplifier’s gain and would be a pretty stupid thing to do.’

To begin, consider the case of no disturbance ($d = 0$). Assume that both the amplifier A and the feedback F act by multiplication. Without feedback (i.e. with $F = 0$), the system behavior is described by $y = Au$, which is an amplifier with (open loop) gain A .

Introducing feedback, the behavior of the system is as follows. From the diagram

$$y = Ae \quad \text{and} \quad e = u - Fy.$$

Eliminating e , we find

$$y = \frac{Au}{1 + AF} \tag{1}$$

Calling $G = \frac{A}{1+AF}$ the *system* (or *closed loop*) *gain*, we have simply $y = Gu$. Comparing G with A , it is immediate that the feedback does indeed reduce the gain of the amplifier. Further, if the *loop gain* AF is large ($AF \gg 1$), then

$$G \approx \frac{A}{AF} = \frac{1}{F}.$$

That is, as the gain AF increases, the system behavior becomes more dependent on the feedback loop and less dependent on the amplifier itself. We next indicate three specific consequences of this key insight.

Sensitivity to internal parameter variation Since the closed loop gain G depends on the amplifier gain A , a small change ΔA in the gain A will produce a change ΔG in G . Considering the ratio of relative changes we find

$$\frac{\partial G}{\partial A} \frac{A}{G} = \frac{1}{1 + AF} \quad \text{so} \quad \frac{\Delta G}{G} \approx \frac{1}{1 + AF} \frac{\Delta A}{A} \tag{2}$$

provided ΔA is small. That is, a 1% change in the open loop gain A leads to a roughly $\frac{1}{1+AF}$ % change in the system gain. We see that as the loop gain AF is increased the system becomes less sensitive to perturbations in its internal structure. In electrical circuit design this might alleviate the problems caused by temperature fluctuations or aging components. In a biochemical network the result will be a system whose function is not sensitive to fluctuations in enzyme concentrations. It should be noted that this reduction in sensitivity comes at a price – as the loop gain is increased the relative sensitivity to changes in F grows to unity. As mentioned, this performance constraint can be met by coupling low tolerance amplifiers to carefully tuned feedback elements. At this point we can only speculate as to whether nature has hit upon the same design strategy

Sensitivity to disturbances in the output Suppose now that a constant disturbance d affects the output as in Figure 3. The system behavior is then described by

$$y = Ae - d \quad \text{where} \quad e = u - Fy.$$

Eliminating e , we find

$$y = \frac{Au - d}{1 + AF}.$$

The sensitivity of the output to the disturbance is then

$$\frac{\partial y}{\partial d} = -\frac{1}{1 + AF}.$$

Again, we see that the sensitivity decreases as the loop gain AF is increased. Such a disturbance could be caused by an increased load in a downstream part of an electrical circuit or removal of end product from a biochemical pathway.

This property is of particular interest because the last stage of MAPK, that is MAPK-PP (see Figure 2) has to migrate to the nucleus in order to elicit a response. This diffusion is effectively a load on the MAPK circuit. Without feedback such a load would have a deleterious effect on the functioning of the MAPK pathway. As long as there is a pool of unphosphorylated MAPK, the feedback is able to compensate for this increased load. It is only when that pool dries up (as the amplifier is saturated) that the feedback is unable to provide any benefit. This property also has the natural benefit of automatically modularizing the network into, effectively, a single functional unit.

Improved linearity of response over extended operating range Consider now the case where the response of the amplifier is a nonlinear function of the input signal, so the open loop response is $y = A(u)$, e.g. $y = 10\frac{u}{1+u}$. Taking the feedback again to act simply by multiplication, the behavior of the system G (now also a function of u) is described by

$$y = G(u) = A(e) \quad \text{where} \quad e = u - Fy = u - FG(u).$$

Differentiating we find

$$G'(u) = A'(e) \frac{de}{du} = A'(e)(1 - FG'(u)).$$

Solving for $G'(u)$ we find

$$G'(u) = \frac{A'(e)}{1 + A'(e)F}.$$

We find then, that if $A'(e)F$ is large ($A'(e)F \gg 1$), then

$$G'(u) \approx \frac{1}{F},$$

so, in particular, G is approximately linear, as its derivative is approximately constant. In this case, the linear feedback compensates for the nonlinearities in the amplifier $A(\cdot)$. Another feature of this analysis is that the slope of $G(\cdot)$ is less than that of $A(\cdot)$, i.e. the response is “stretched out”. For instance, if $A(\cdot)$ is saturated by inputs above and below a certain “active range”, then $G(\cdot)$ will exhibit the same saturation, but with a broader active range.

A natural objection to the implementation of feedback as described above is that the system sensitivity is not actually reduced, but rather is shifted so that the response is more sensitive to the feedback F and less sensitive to the amplifier A . However, in each of the cases described above, we see that it is the nature of the loop gain AF (and not just the feedback F) which determines the extent to which the feedback affects the nature of the system. This suggests an obvious strategy. By designing a system which has a small “clean” feedback gain and a large “sloppy” amplifier, one ensures that the loop gain is large and the behavior of the system

is satisfactory. Engineers employ precisely this strategy in the design of electrical feedback amplifiers, regularly making use of amplifiers with gains several orders of magnitude larger than the feedback gain (and the gain of the resulting system).

In summary a feedback amplifier provides the following desirable characteristics:

1. Increased robustness with respect to internal perturbations.
2. Insulation from external perturbation, resulting in functional modularization.
3. A linear graded response over an extended operating range.

It is hard to overstate the importance of the feedback amplifier in circuit design. One of the most important components in analog electronics is the operational amplifier, or op-amp. The original concept of the op-amp came from the field of analog computers in the 1940s where extremely high-gain DC amplifiers were employed to carry out analog computations such as addition, multiplication, differentiation and most important of all, integration. The operating characteristics of a particular op-amp were determined by the feedback elements. By changing the arrangements and types of feedback elements different analog operations could be implemented. Thus the same amplifier was able to perform a variety of operations with only small changes to the feedback elements.

One of the key characteristics of an op-amp is the extremely high gain between the input and output signals. By analogy we can see that the basic MAPK cascade pathway, without the feedback loop, has the same high gain characteristic. In the next section we shall illustrate how a high gain MAPK cascade with negative feedback will act in an exactly analogous manner to the feedback amplifier.

Interconvertible Enzyme Cascades as Feedback Amplifiers Having described the utility of negative feedback in electrical amplifiers, we now demonstrate that the same benefits can be reaped when feedback is wrapped around a biochemical amplifier such as the MAPK cascade. Our analysis is based on a model from Ferrell and Kholodenko (Huang & Ferrell, 1996; Kholodenko, 2000), with a negative feedback of the form described in previous work incorporating similar mechanisms (Asthagiri & Lauffenburger, 2001; Kholodenko, 2000; Brightman & Fell, 2000). Note that our conclusions do not depend explicitly on this particular model but instead is a function of the high gain achieved by the cascade of cycles and the presence of the negative feedback. The model simply serves as a means to illustrate the concept. The network is shown in Figure 2. We begin by describing some simulations which show that this nonlinear system exhibits behavior similar to that described above for feedback amplifiers.

At the basal level of no feedback, the steady state behavior of the pathway is shown in Figure 4. As discussed above, the cascade acts as a switch – the concentration of activated MAPK climbs quickly from its basal level to saturation (i.e. complete activation) at a particular “threshold” concentration of signal (Goldbeter & Koshland, 1984; Huang & Ferrell, 1996). For inputs near the threshold level, the pathway acts as an amplifier, with the output level of activated MAPK far exceeding the signal concentration. (This is a feature which is strongly dependent on the increasing concentrations of kinases at successive levels of the cascade (Goldbeter & Koshland, 1984; Asthagiri & Lauffenburger, 2001).)

Figure 5 shows the input/output (Sig to MAPK-PP) behavior of the system as the feedback gain ($1/K_i$) is increased. Here we see, as noted in (Bhalla *et al.*, 2002) the ‘S’-shaped response curve is stretched and straightened. As the feedback is increased, the operating range of the

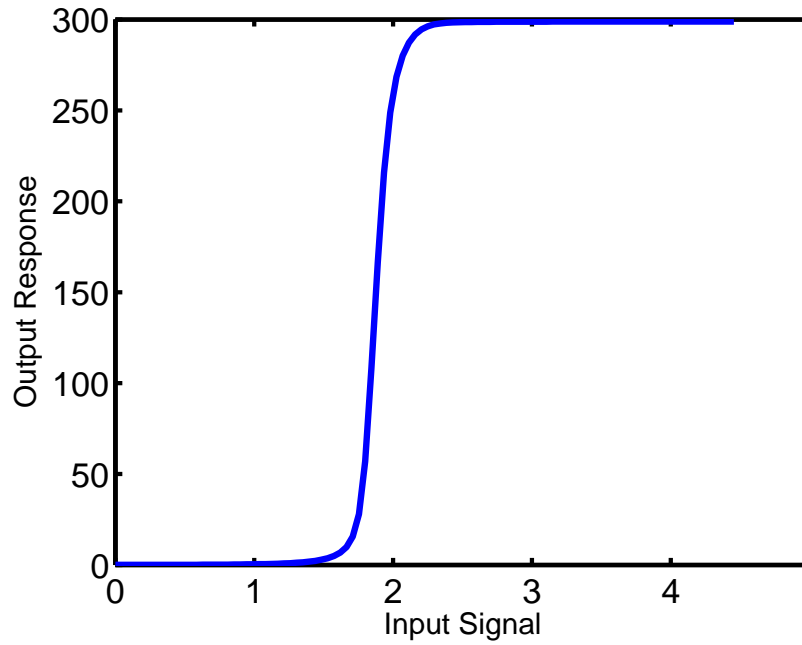

Figure 4: Response of MAPK model in the case of no negative feedback

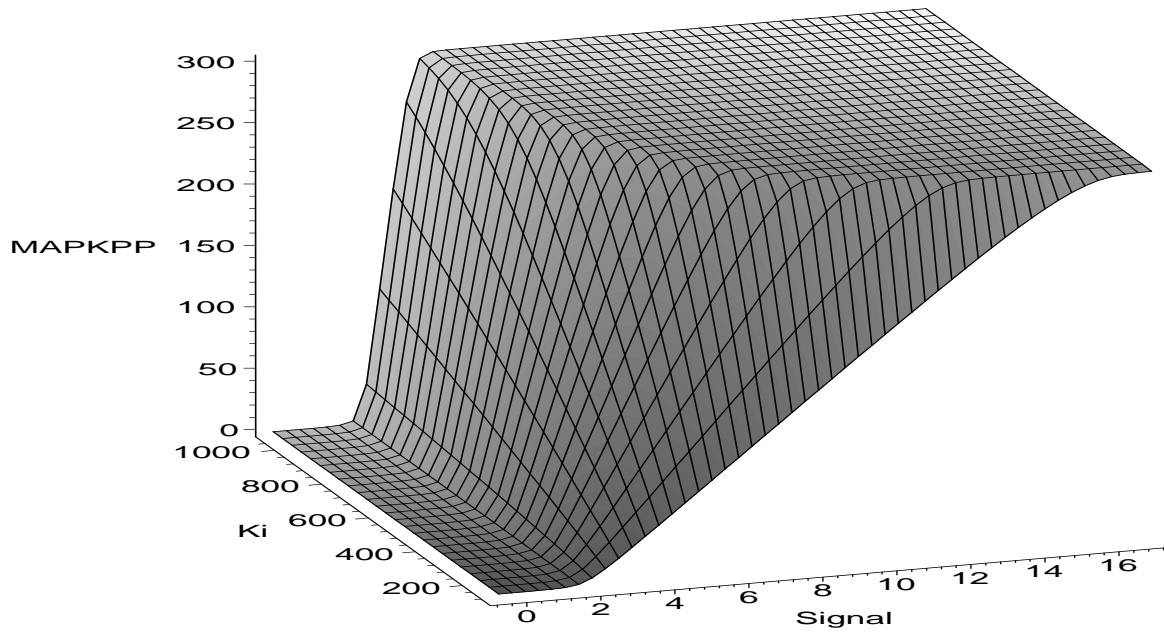

Figure 5: Response for various levels of feedback gain

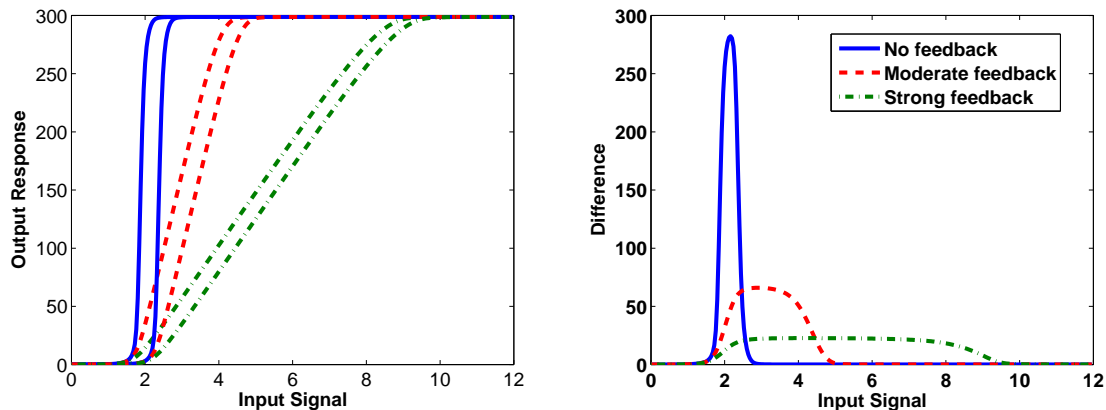

Figure 6: Effect on response on a change in V_1 (See equation (4)). In the first panel, pairs of graphs are shown, each pair represents a wild type and a perturbation to V_1 . Individual pairs are measured under differing feedback strengths (Solid: no feedback ($K_i = 10000$), Dash: moderate level of feedback ($K_i = 600$), Dash-Dot: strong feedback ($K_i = 200$)). The second panel shows the difference in response between each pair. Note that as the feedback increases, the difference becomes more linear.

amplifier is increased and the response is more linear over that range. It is also clear that the overall gain is decreasing, since the response for each particular input level diminishes as the feedback gain increases. It is argued in (Bhalla *et al.*, 2002) that this behavior allows the cascades to be bi-functional, acting as a switch when the feedback is low and as an amplifier when the feedback is high. From the point of view of the amplifier characteristics, a switch can be thought of as an amplifier with very short operating range. An increase in the feedback gain increases the range over which the cascade acts as an amplifier.

Figure 6 shows the effect of parameter variation on the system at various levels of feedback intensity. The response of the system is plotted against signal level for three different levels of feedback gain. In each case, the response is also shown after a perturbation in the kinetic parameter V_1 (a 20% decrease). Also shown is a plot of the *difference* in response between the nominal and perturbed systems. The feedback is again having a “stretching” effect. While the “total” error is not appreciably diminished, the effect of the feedback is to spread that error out across the increased operating range of the amplifier. The result is a significant decrease in the change in response for each particular input level within the active range. Similar result hold for perturbations in the other model parameters.

Linearized model In addition to simulations of the complete model, analysis of a linearization is also useful in drawing analogy to the linear feedback amplifier described above. The model was linearized about a nominal operating point (steady state) with moderate feedback gain ($K_i = 600$) and an input level in the operating range of the amplifier ($\text{Sig} = 3$). The linearization takes the form

$$\dot{x} = Ax + Bu - F(K_i)x$$

where the state variables x and the input u describe the deviation of the enzyme concen-

trations and signal level from their nominal values. This is a slightly different form than the linear amplifier discussed above since the feedback acts on the system rather than directly on the input (i.e. the feedback influences the effect of Sig on MAPKKK rather than having a direct effect on Sig itself). In this case we expect the closed loop gain to have the form

$$y = \frac{A_1 u}{1 + A_2 F}$$

where A_1 is the gain from input to MAPKKK-P, and A_2 is the gain from MAPKKK-P to MAPK-PP. In this case the feedback is described as

$$F(K_i) = \frac{4.87}{(1 + \frac{164}{K_i})^2 K_i}$$

so that

$$\frac{A_1 u}{1 + A_2 F(K_i)} = A_1 u \frac{K_i^2 + 328K_i + 26900}{K_i^2 + (328 + 4.87A_2)K_i + 26900} \quad (3)$$

The linear (steady state) relationship between input and output (i.e. signal level and MAPK-PP) is given by

$$[\text{MAPK-PP}] - [\text{MAPK-PP}]_0 = ([\text{Sig}] - [\text{Sig}]_0) 2180 \frac{K_i^2 + 329K_i + 27000}{K_i^2 + 15600K_i + 27000},$$

where $[\text{MAPK-PP}]_0$ and $[\text{Sig}]_0$ are the nominal levels. This matches (3) with $A_1 = 2180$, $A_2 = 3140$.

Another way of characterizing the linear system is through its frequency response. Graphs of the response versus frequency (i.e. magnitude Bode plots) are shown in Figure 7 for various levels of feedback. This is the familiar response of a feedback amplifier – as the feedback increases, the gain of the system decreases, but the range of frequencies over which that gain is maintained is increased. This highlights another feature of adding negative feedback to an amplifier: an increase not just in the range of constant signals that are amplified, but a corresponding increase in the range of sinusoidal signals that are amplified. Although this amplification of oscillatory signals has not been seen as biologically significant, one cannot rule out that some cells may be using the MAPK cascade for this purpose, especially in light of the number of oscillatory signals which have been identified.

Computational Model The model network is shown in Figure 2. The eight species concentrations of interest are MAPKKK, MAPKKK-P, MAPKK, MAPKK-P, MAPKK-PP, MAPK, MAPK-P, MAPK-PP. Moiety conservation allows us to treat three of these as dependent variables through

$$\begin{aligned} [\text{MAPKKK}] &= T_1 - [\text{MAPKKK-P}] \\ [\text{MAPKK}] &= T_2 - [\text{MAPKK-P}] - [\text{MAPKK-PP}] \\ [\text{MAPK}] &= T_3 - [\text{MAPK-P}] - [\text{MAPK-PP}]. \end{aligned}$$

The reactions are described by Michaelis-Menten rate laws:

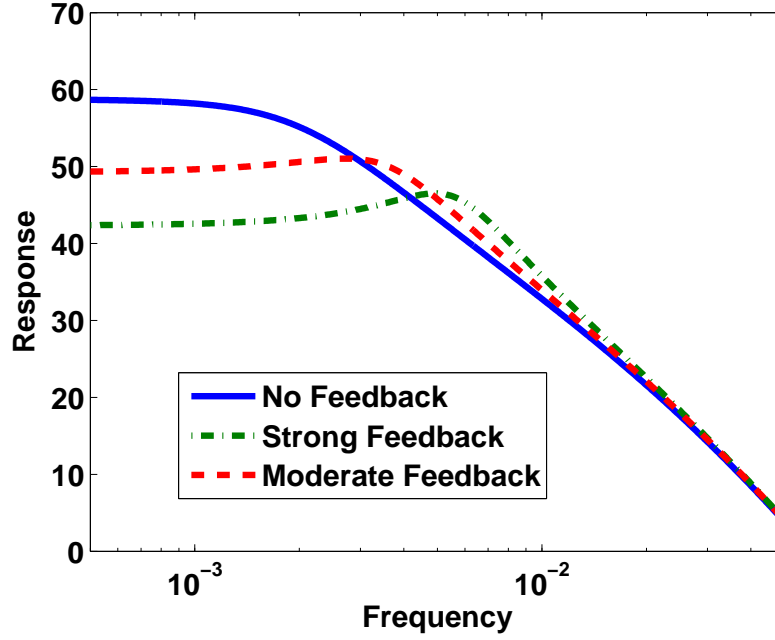

Figure 7: Frequency response of linearized model for various feedback gains

$$\begin{aligned}
 v_1 &= \frac{(V_1 + [\text{Sig}])[\text{MAPKKK}]}{(K_{m1} + [\text{MAPKKK}]) \left(1 + \frac{[\text{MAPK-PP}]}{K_i}\right)} \\
 v_2 &= \frac{V_2 [\text{MAPKKK-P}]}{K_{m2} + [\text{MAPKKK-P}]} \\
 v_3 &= \frac{V_3 [\text{MAPKK}] [\text{MAPKKK-P}]}{K_{m3} + [\text{MAPKK}]} \\
 v_4 &= \frac{V_4 [\text{MAPKK-P}]}{K_{m6} + [\text{MAPKK-P}]} \\
 v_5 &= \frac{V_5 [\text{MAPKK-P}] [\text{MAPKKK-P}]}{K_{m5} + [\text{MAPKK-P}]} \\
 v_6 &= \frac{V_6 [\text{MAPKK-PP}]}{K_{m4} + [\text{MAPKK-PP}]} \\
 v_7 &= \frac{V_7 [\text{MAPK}] [\text{MAPKK-PP}]}{K_{m7} + [\text{MAPK}]} \\
 v_8 &= \frac{V_8 [\text{MAPK-P}]}{K_{m10} + [\text{MAPK-P}]} \\
 v_9 &= \frac{V_9 [\text{MAPK-P}] [\text{MAPKK-PP}]}{K_{m8} + [\text{MAPK-P}]} \\
 v_{10} &= \frac{V_{10} [\text{MAPK-PP}]}{K_{m9} + [\text{MAPK-PP}]}
 \end{aligned} \tag{4}$$

Nominal parameter values are chosen as

$$\begin{aligned}
K_{m_1} &= 10 & K_{m_2} &= 8 & K_{m_3} &= 15 & K_{m_4} &= 15 & K_{m_5} &= 15 \\
K_{m_6} &= 15 & K_{m_7} &= 15 & K_{m_8} &= 15 & K_{m_9} &= 15 & K_{m_{10}} &= 15 \\
V_1 &= 2.5 & V_2 &= 5.1 & V_3 &= 0.025 & V_4 &= 0.75 & V_5 &= 0.025 \\
V_6 &= 0.75 & V_7 &= 0.025 & V_8 &= 0.5 & V_9 &= 0.025 & V_{10} &= 0.5 \\
T_1 &= 100 & T_2 &= 300 & T_3 &= 300
\end{aligned}$$

The units for concentration and Michaelis constants are given in nM, maximum rates are expressed as nM s^{-1} and rate constants in s^{-1} . To investigate the behavior of the system under a load on the output, sequestration of MAPKK-PP in the nucleus is included in the model by the inclusion of an additional state variable nucMAPK-PP, described by

$$[\text{MAPK}] = T_3 - [\text{MAPK-P}] - [\text{MAPK-PP}] - \text{nucMAPK-PP}$$

$$\begin{aligned}
v_{11} &= k_{11}[\text{MAPK-PP}] & v_{12} &= k_{12}[\text{nucMAPK-PP}] \\
k_{11} &= 0.003 & k_{12} &= 0.01
\end{aligned}$$

The model was linearized about a nominal steady state with moderate feedback level ($K_i = 600$) and a signal level in the amplifier range ($\text{Sig} = 3$). The nominal values of the state variables are

$$\begin{aligned}
[\text{MAPKKK-P}]_0 &= 23.8 & [\text{MAPKK-P}]_0 &= 43.9 & [\text{MAPKK-PP}]_0 &= 21.7 \\
[\text{MAPK-P}]_0 &= 82.3 & [\text{MAPK-PP}]_0 &= 164
\end{aligned}$$

The linearized model takes the form

$$\dot{x} = Ax + Bu - F(K_i)x$$

where

$$\begin{aligned}
x &= \begin{pmatrix} [\text{MAPKKK-P}] - [\text{MAPKKK-P}]_0 \\ [\text{MAPKK-P}] - [\text{MAPKK-P}]_0 \\ [\text{MAPKK-PP}] - [\text{MAPKK-PP}]_0 \\ [\text{MAPK-P}] - [\text{MAPK-P}]_0 \\ [\text{MAPK-PP}] - [\text{MAPK-PP}]_0 \end{pmatrix} & u &= [\text{Sig}] - [\text{Sig}]_0 \\
A &= \begin{pmatrix} -0.0462 & 0 & 0 & 0 & 0 \\ 0.00487 & -0.00596 & 0.00822 & 0 & 0 \\ 0.0186 & 0.00257 & -0.00837 & 0 & 0 \\ 0 & 0 & -0.00163 & -0.00339 & -0.00151 \\ 0 & 0 & 0.0211 & 0.000859 & -0.000233 \end{pmatrix} \\
B &= \begin{pmatrix} 0.694 \\ 0 \\ 0 \\ 0 \\ 0 \end{pmatrix}
\end{aligned}$$

$$F(K_i) = \begin{pmatrix} 0 & 0 & 0 & 0 & \frac{4.87}{(1+\frac{164}{K_i})^2 K_i} \\ 0 & 0 & 0 & 0 & 0 \\ 0 & 0 & 0 & 0 & 0 \\ 0 & 0 & 0 & 0 & 0 \\ 0 & 0 & 0 & 0 & 0 \end{pmatrix}$$

Discussion

In this paper we have discussed an alternative hypothesis on the functional role of the MAPK pathway. In particular, we have discussed the possibility that MAPK is acting as a classic feedback amplifier so beloved of engineers.

Experimental Evidence Although the previous theoretical and computational arguments offer a novel view of how the MAPK pathway may be operating, the popularly held view is that MAPK pathways are in fact operating as switch devices rather than generating a graded response as we have suggested here. Indeed in some cases a switch response makes a very satisfactory explanation, for example, oocyte maturation presumably requires an all-or-none response to progesterone (Huang & Ferrell, 1996). However in other cases, the situation is not so easily decided. Hazzaline and Mahadevan (Hazzalin & Mahadevan, 2002) have discussed at length the case for a graded response over a switch like response. They provide evidence for the graded regulation of immediate-early genes in cell culture which are controlled via MAPK pathways. Furthermore, there is now clear evidence to support graded responses in the yeast mating pheromone pathway (Poritz *et al.*, 2001; Ferrell, 2002) which is again based on a MAPK cascade.

There are also a growing number of papers which report a graded response of ERK (Mitogen activated protein kinase) with respect to EGF (Epidermal Growth Factor) stimulation. The first paper (Bhalla *et al.*, 2002) describes a cell population study where the response was investigated using Platelet-Derived Growth Factor (PDGF), they observed a proportional response over a 10-fold concentration range of PDGF. This effect was explained in terms of the action of the negative feedback modulator, MKP (MAPK Phosphatase). Although this feedback only operates on one level of the three cascade structure, it still induces the property of linearization due to negative feedback as described in this paper.

Much more convincing however is recent work carried out on single cell studies. It is becoming increasingly apparent that population level studies give only a rough indication of cellular dynamics, this is due to heterogeneity in the population. A striking example of this effect are the oscillations recently observed in p53 in response to DNA damage (Lahav *et al.*, 2004). In population studies the oscillations appear damped (due to each oscillator being out of phase), while in single cell studies the oscillations are of fixed amplitude. It is therefore of interest to note two papers (Whitehurst *et al.*, 2004; Mackeigan *et al.*, 2005) which focus on single cell studies. In both cases they observed a clear graded response of ERK stimulation with respect to EGF. In the first paper (Whitehurst *et al.*, 2004) the concentration of dually phosphorylated ERK in individual HeLa cells was correlated with activation as a result of EGF and PMA stimulation. In both cases a clear linear response was observed. The second paper (Mackeigan *et al.*, 2005) investigated the response of Swiss 3T3 fibroblasts to EGF and PDGF. The work used a FACS (Fluorescence Activated Cell Sorting) based approach to investigate the distribution of activation in the cell population. If the cascade operated in an ultrasensitivity

mode then the authors expected to see two cell populations corresponding to an off an on state. Instead the experiments showed intermediate activation of ERK in response to EGF.

Although these experiments indicate that ERK responds linearly to stimulations they do not suggest how the linearity originates. We postulate in this paper that such a response would originate from ultrasensitivity coupled with negative feedback. To determine whether this is the case further studies would need to be undertaken, one possibility would be to remove the feedback loop and to remeasure the response. Further evidence of the role of the negative feedback could be obtained by investigating the robustness of the response to changes in proteins levels inside the loop. If the feedback loop is operating then such changes should have little effect on the network response. While such experiments would not prove conclusively that the cascade is acting as a feedback amplifier, they would certainly lend weight to that alternative.

Network Versatility The MAPK unit appears to be a very versatile unit (Bhalla *et al.*, 2002). Without any feedback, MAPK can act as a very high gain amplifier, so high that it behaves in a switch like manner (Huang & Ferrell, 1996; Bagowski *et al.*, 2003). With the addition of feedback a number of new behaviors can emerge. With positive feedback, MAPK can act as a bistable switch, with negative feedback MAPK can act as a classic feedback amplifier. Moreover, with sufficient negative feedback the MAPK pathway can be made to oscillate (Kholodenko, 2000). Many of these behaviors have now been observed experimentally (Huang & Ferrell, 1996; Bhalla *et al.*, 2002; Whitehurst *et al.*, 2004; Mackeigan *et al.*, 2005).

One of the great challenges in modern molecular biology (or systems biology) is to understand the functioning of large complex networks. Such networks are composed of thousands of reactions and without some way to simplify their description we will find them almost impossible to understand. In electrical engineering, it is now almost routine to design complex circuits composed of millions of components, for example the latest Pentium 4 from Intel is reportedly composed of forty three million transistors. How, one may ask, do engineers cope with such enormous complexity? A large part of the answer like in modularization, that is, the network is broken down into smaller function units which have distinct and well defined behaviors. These in turn are modularized further, as appropriate, down to the level of the discrete transistor. Thus a hierarchy of function is described. By modularizing, each module becomes manageable in terms of design and understanding. In reaction networks, we need to take the same approach. Although the concept of modularization (Lauffenburger, 2000) in cellular networks has, in recent years, received much attention, most studies have concentrated on topological modularization (Milo *et al.*, 2002; Ravasz *et al.*, 2002; Lee *et al.*, 2002).

However we have one major problem which the engineers do not have. Whereas man-made devices are designed, natural systems are clearly not. Thus we need to be able to reverse engineer the modules. This is obviously no easy task, for example we do not even know whether natural selection would automatically generate a module based structure. Experiments on artificially evolved systems (Koza *et al.*, 1999; A & Sauro, 2004) suggest that both modular and non-modular ‘designs’ can evolve, with modularity being the most common outcome. If this is the case for natural systems then we will be able to make progress.

In this paper we describe the properties of one possible module, that is the MAPK module. Many other modules most probably exist. We are currently investigating other potentially functional units from both prokaryotic and eukaryotic systems. Others have already started using this approach (Smolen *et al.*, 1998, 2000*a,b*) and two excellent reviews in this area by Wolf and Arkin (Wolf & Arkin, 2003) and Tyson *et al.* (Tyson *et al.*, 2003) are well worth reading. This area of research would probably gain much from looking at the sorts of devices

that electronic engineers employ, including devices such as switches, amplifiers, oscillators, frequency filters amplitude filters, noise filters and amplifiers, combinatorial logic, homeostats, rheostats, logic gates and memory elements (list taken from (Wolf & Arkin, 2003)). For Systems Biology to succeed, knowledge and experience from different disciplines clearly needs to come together and electrical engineering has probably a significant contribution to make in allowing us to understand complex biological networks.

Materials and Methods

All simulations were carried out using a combination of Matlab (<http://www.mathworks.com/>) and the Systems Biology Workbench (Sauro *et al.*, 2003). Graphs were generated using Matlab.

Acknowledgements

We are grateful to John Doyle, Hana El-Samad and Mustafa Khammash for very useful discussions. HMS acknowledges the support of the Japan Science and Technology Corporations ERATO Kitano Systems Biology Project; BI acknowledges Air Force Research Laboratory Cooperative Agreement No. F30602-01-2-558. We would also like to acknowledge Prahlad Ram for bringing to our attention their paper.

Author Contributions

The work described in this paper was carried out equally by both authors, HMS and BI.

References

- A, D. & Sauro, H. M. (2004). Preliminary studies on the in silico evolution of biochemical networks. *Chembiochem*, **5**, 1423–31.
- Asthagiri, A. R. & Lauffenburger, D. A. (2001). A computational study of feedback effects on signal dynamics in a mitogen-activated protein kinase (mapk) pathway model. *Biotechnology Progress*, **17**, 227–239.
- Bagowski, C. P., Besser, J., Frey, C. R. & Ferrell, J. E. (2003). The jnk cascade as a biochemical switch in mammalian cells. ultrasensitive and all-or-none responses. *Current Biology*, **13**, 315–20.
- Banuett, F. (1998). Signaling in the yeasts: an informational cascade with links to the filamentous fungi. *Microbiology and Molecular Biology Reviews*, **62**, 249–274.
- Bhalla, U., Ram, P. & Iyengar, R. (2002). Map kinase phosphatase as a locus of flexibility in a mitogen-activated protein kinase signaling network. *Science*, **297**, 1018–23.
- Black, H. S. (1977). Inventing the negative feedback amplifier. *IEEE spectrum*, December, **14**, 55–60.

- Brightman, F. A. & Fell, D. A. (2000). Differential feedback regulation of the mapk cascade underlies the quantitative differences in egf and ngf signaling in pc12 cells. *FEBS Letters*, **482**, 169–174.
- Cárdenas, M. L. & Cornish-Bowden, A. (1989). Characteristics necessary for an interconvertible enzyme cascade to generate a highly sensitive response to an effector. *Biochem J*, **257**, 339–345.
- Chang, L. & Karin, M. (2001). Mammalian map kinase signaling cascades. *Nature*, **410**, 37–40.
- Chock, P. B. & Stadtman, E. R. (1977). Superiority of interconvertible enzyme cascades in metabolic regulation: analysis of monocyclic systems. *Proc. Natl. Acad. Sci. U.S.A.* **74**, 2761–2765.
- Cinquin, O. & Demongeot, J. (2002). Roles of positive and negative feedback in biological systems. *C R Biol.* **325**, 1085–1095.
- Downward, J. (1996). Control of ras activation. *Cancer Surveys*, **27**, 87–100.
- Fell, D. & Small, J. (1986). Theoretical aspects of covalent modification in metabolic control. *Biochem. Soc. Trans.* **14**, 623–624.
- Ferrell, J. E. (2002). Self-perpetuating states in signal transduction: positive feedback, double-negative feedback and bistability. *Current Opinion in Cell Biology*, **14**, 140–148.
- Garrington, T. P. & Johnson, G. L. (1999). Organization and regulation of mitogen-activated protein kinase signaling pathways. *Curr Opin Cell Biol.* **11**, 211–8.
- Goldbeter, A. & Koshland, D. E. (1981). An amplified sensitivity arising from covalent modification in biological systems. *Proc. Natl. Acad. Sci.*, **78**, 6840–6844.
- Goldbeter, A. & Koshland, D. E. (1984). Ultrasensitivity in biochemical systems controlled by covalent modification. interplay between zero-order and multistep effects. *J. Biol. Chem.* **259**, 14441–7.
- Gomperts, B. D., Mramer, I. M. & Tatham, P. E. R. (2002). *Signal Transduction*. Academic Press.
- Hazzalin, C. & Mahadevan, L. C. (2002). Mapk-regulated transcription: a continuously variable gene switch? *Nature Reviews: Molecular Cell Biology*, **3**, 30–40.
- Horowitz, P. & Winfield, H. (1990). *The Art of Electronics*. Cambridge University Press.
- Huang, C. F. & Ferrell, J. E. (1996). Ultrasensitivity in the mitogen-activated protein kinase cascade. *Proc. Natl. Acad. Sci.*, **93**, 10078–10083.
- Ihekwa, A. E. C., Broomhead, D. S., Grimley, R., Benson, N., White, M. R. H. & Kell, D. B. (2005). Synergistic control of oscillations in the nf- kb signalling pathway. *IEE Proc.-Syst. Biol.* **152**, 153–160.
- Kahn, D. & Westerhoff, H. V. (1991). Control theory of regulatory cascades. *J. Theor. Biol.* **153**, 255–285.

- Kholodenko, B. N. (2000). Negative feedback and ultrasensitivity can bring about oscillations in the mitogen-activated protein kinase cascades. *Eur. J. Biochem*, **267**, 1583–1588.
- Kholodenko, B. N., Hoek, J. B., Westerhoff, H. V. & Brown, G. C. (1997). Quantification of information transfer via cellular signal transduction pathways. *FEBS Letters*, **414**, 430–434.
- Koza, J. R., III, F. H. B., Bennett, H. F. & Andre, D. (1999). *Genetic Programming III: Automatic Programming and Automatic Circuit Synthesis*. Morgan Kaufmann.
- Kyriakis, J. M. & Avruch, J. (2002). Mammalian mitogen-activated protein kinase signal transduction pathways activated by stress and inflammation. *Physiological Reviews*, **81**, 807–869.
- Lahav, G., Rosenfeld, N., Sigal, A., Geva-Zatorsky, N., Levine, A. J., Elowitz, M. B. & Alon, U. (2004). Dynamics of the p53-mdm2 feedback loop in individual cells. *Nature, Genetics*, **36(2)**, 147–150.
- Lauffenburger, D. A. (2000). Cell signaling pathways as control modules: complexity for simplicity? *Proc Natl Acad Sci U S A*. **97**, 5031–3.
- Lee, T. I., Rinaldi, N. J., Robert, F., Odom, D. T., Bar-Joseph, Z., Gerber, G. K., Hannett, N. M., Harbison, C. T., Thompson, C. M., Simon, I., Zeitlinger, J., Jennings, E. G., Murray, H. L., Gordon, D. B., Ren, B., Wyrick, J. J., Tagne, J. B., Volkert, T. L., Fraenkel, E., Gifford, D. K. & Young, R. A. (2002). Transcriptional regulatory networks in *saccharomyces cerevisiae*. *Science*, **298**, 799–804.
- Mackeigan, J. P., Murphy, L. O., Dimitri, C. A. & Blenis, J. (2005). Graded mitogen-activated protein kinase activity precedes switch-like c-fos induction in mammalian cells. *Molecular and Cellular Biology*, **25**, 4676–4682.
- Marshall, C. J. (1994). Map kinase kinase kinase, map kinase kinase and map kinase. *Curr. Opin. Genet. Dev.* **4**, 82–9.
- Milo, R., Shen-Orr, S., Itzkovitz, S., Kashtan, N., Chklovskii, D. & Alon, U. (2002). Network motifs: simple building blocks of complex networks. *Science*, **298**, 824–7.
- Mindell, D. (2000). Opening black's box. *Technology and Culture*, **14**, 405–434.
- Nelson, D. E., Ihekweaba, A. E., Elliott, M., Johnson, J. R., Gibney, C. A., Foreman, B. E., Nelson, G., See, V., Horton, C. A., Spiller, D. G., Edwards, S. W., McDowell, H. P., Unitt, J. F., Sullivan, E., Grimley, R., Benson, N., Broomhead, D., Kell, D. B. & White, M. R. (2004). Oscillations in nf-kappab signaling control the dynamics of gene expression. *Science*, **306**, 704–8.
- Poritz, M. A., Malmstrom, S., Kim, M.-H., Rossmeyssl, P. J. & Kamb, A. (2001). Graded mode of transcriptional induction in yeast pheromone signaling revealed by single-cell analysis. *Yeast*, **18**, 1331–1338.
- Ravasz, E., Somera, A. L., Mongru, D. A., Oltvai, Z. N. & Barabasi, A.-L. (2002). Hierarchical organization of modularity in metabolic networks. *Science*, **297**, 1551–1555.
- Sauro, H. M., Hucka, M., Finney, A., Wellock, C., Bolouri, H., Doyle, J., & Kitano, H. (2003). Next generation simulation tools: the systems biology workbench and biospice integration. *OMICS*, **7(4)**, 355–372.

- Savageau, M. A. (1976). *Biochemical systems analysis: a study of function and design in molecular biology*. Addison-Wesley, Reading, Mass.
- Small, J. R. & Fell, D. A. (1990). Covalent modification and metabolic control analysis: modification to the theorems and their application to metabolic systems containing covalently-modified enzymes. *Eur. J. Biochem.* **191**, 405–411.
- Smolen, P., Baxter, D. A. & Byrne, J. H. (1998). Frequency selectivity, multistability, and oscillations emerge from models of genetic regulatory systems. *Am J Physiol.* **274**, C531–42.
- Smolen, P., Baxter, D. A. & Byrne, J. H. (2000a). Mathematical modeling of gene networks. *Neuron*, **26**, 567–80.
- Smolen, P., Baxter, D. A. & J, H. B. (2000b). Modeling transcriptional control in gene networksmethods. *Bulletin of Mathematical Biology*, **62**, 247–292.
- Tyson, J. J., Chen, K. C. & Novak, B. (2003). Sniffers, buzzers, toggles and blinkers: dynamics of regulatory and signaling pathways in the cell. *Current Opinion in Cell Biology*, **15**, 221–231.
- Whitehurst, A., Cobb, M. H. & White, M. A. (2004). Stimulus-coupled spatial restriction of extracellular signal-regulated kinase 1/2 activity contributes to the specificity of signal-response pathways. *Molecular and Cellular Biology*, **24**, 10145–10150.
- Widmann, C., Gibson, S., Jarpe, M. B. & Johnson, G. L. (1999). Mitogen-activated protein kinase: conservation of a three-kinase module from yeast to human. *Physiol Rev.* **79**, 143–80.
- Wolf, D. M. & Arkin, A. P. (2003). Motifs, modules and games in bacteria. *Current Opinion in Microbiology*, **6**, 125–34.