

# COMBINATORIAL FIBER BUNDLES AND FRAGMENTATION OF A FIBERWISE PL-HOMEOMORPHISM

N. Mnëv

St. Petersburg Department of the  
Steklov Mathematical Institute,  
St. Petersburg, Russia.  
mnev@pdmi.ras.ru

ABSTRACT. With a compact PL manifold  $X$  we associate a category  $\mathfrak{T}(X)$ . The objects of  $\mathfrak{T}(X)$  are all combinatorial manifolds of type  $X$ , and morphisms are combinatorial assemblies. We prove that the homotopy equivalence

$$B\mathfrak{T}(X) \approx BPL(X)$$

holds, where  $PL(X)$  is the simplicial group of PL-homeomorphisms. Thus the space  $B\mathfrak{T}(X)$  is a canonical countable (as a CW-complex) model of  $BPL(X)$ . As a result, we obtain functorial pure combinatorial models for PL fiber bundles with fiber  $X$  and a PL polyhedron  $B$  as the base. Such a model looks like a  $\mathfrak{T}(X)$ -coloring of some triangulation  $K$  of  $B$ . The vertices of  $K$  are colored by objects of  $\mathfrak{T}(X)$  and the arcs are colored by morphisms in such a way that the diagram arising from the 2-skeleton of  $K$  is commutative. Comparing with the classical results of geometric topology, we obtain combinatorial models of the real Grassmannian in small dimensions:  $B\mathfrak{T}(S^{n-1}) \approx BO(n)$  for  $n = 1, 2, 3, 4$ . The result is proved in a sequence of results on similar models of  $BPL(X)$ . Special attention is paid to the main noncompact case  $X = \mathbb{R}^n$  and to the tangent bundle and Gauss functor of a combinatorial manifold. The trick that makes the proof possible is a collection of lemmas on “fragmentation of a fiberwise homeomorphism,” a generalization of the folklore lemma on fragmentation of an isotopy.



## CONTENTS

1. Introduction	4
2. Assemblies of ball complexes, the poset $\mathbf{R}(X)$ , and the category $\mathfrak{R}(X)$	15
3. Prismatic homeomorphisms, reduction of Theorem A to the lemma on prismatic trivialization	19
4. Reduction of the lemma on prismatic trivialization to the lemma on a common $\mathbf{R}(X)$ -triangulation of fiberwise homeomorphisms	35
5. A plan of the proof of the lemma on a common $\mathbf{R}(X)$ -triangulation of fiberwise homeomorphisms	40
6. Alexandroff spaces (or “preordered sets”)	42
7. Generalized prismatic homeomorphisms	53
8. Ball complexes compatible with disjoint configurations of balls	61
9. Nonfiberwise deformations of fiberwise homeomorphisms	69
10. Graph systems	71
11. Homotopies of fiberwise homeomorphisms associated with graph systems	79
12. Hudson functions and their graphs	84
13. Small balls, separation of small balls	86
14. Lemma on prismatic fragmentation of fiberwise homeomorphisms over the cube	90
15. The proof of the lemma on a common $\mathbf{R}(X)$ -triangulation of fiberwise homeomorphisms	93
16. The case of combinatorial manifolds, Theorem B	100
17. Combinatorial models for $PL_n$ fiber bundles, the tangent bundle and Gauss map of combinatorial manifolds	100
References	103

1. INTRODUCTION

1.1. Let  $X$  be a compact PL manifold. There is a natural generalization of piecewise linear triangulations of  $X$ , namely, the structures of piecewise linear regular cell (or “ball”) complexes<sup>1</sup> on  $X$ . The set of all regular PL ball complexes on  $X$  is partially ordered by subdivision. We denote this poset by  $\mathbf{R}(X)$ . It is convenient to consider a subdivision  $\mathbf{Q}_0 \leq \mathbf{Q}_1$  of ball complexes as a morphism of “geometric assembly” with source  $\mathbf{Q}_0$  and target  $\mathbf{Q}_1$ . By forgetting the geometry, to a geometric PL ball complex  $\mathbf{Q}$  we can associate an abstract PL ball complex  $\mathbf{P}(\mathbf{Q})$  (an “abstract PL ball complex” is a natural generalization of the notion of an abstract simplicial complex). The correspondence  $\mathbf{P}$  sends the poset  $\mathbf{R}(X)$  to some new category  $\mathfrak{R}(X)$  whose objects are abstract PL ball complexes and morphisms are “abstract assemblies.” One may imagine an abstract assembly  $\mathfrak{Q}_0 \rightsquigarrow \mathfrak{Q}_1$  of abstract ball complexes as a way of gluing together the abstract balls of  $\mathfrak{Q}_0$  into larger balls so as to obtain the complex  $\mathfrak{Q}_1$ . This way of gluing may be not unique. Figure 1 should give an idea of a unique geometric assembly of two particular geometric ball complexes, and Fig. 2 should give an idea of three possible combinatorial assemblies

$$\mathbf{P}(\mathbf{Q}_0) = \mathfrak{Q}_0 \rightsquigarrow \mathfrak{Q}_1 = \mathbf{P}(\mathbf{Q}_1).$$

With the functor  $\mathbf{P}$  we associate a cellular map of classifying spaces

$$B\mathbf{R}(X) \xrightarrow{B\mathbf{P}} B\mathfrak{R}(X).$$

The map  $B\mathbf{P}$  has a description in terms of an action of the group of PL homeomorphisms on PL ball complexes on  $X$ . Namely, the natural action of PL homeomorphisms on the set  $\mathbf{R}(X)$  can be extended to a cellular action of a discrete group  $\text{PL}^\delta(X)$  on  $B\mathbf{R}(X)$ :

$$(1) \quad \text{PL}(X)^\delta \times B\mathbf{R}(X) \rightarrow B\mathbf{R}(X).$$

---

<sup>1</sup>For exact definitions, see Sec. 2 on page 15. One may imagine something like the boundary complex of a convex 3-polytope as a “ball complex” and a planar 3-connected graph as an “abstract ball complex.” Or one may simply think about geometric triangulations instead of “ball complexes” and about combinatorial manifolds instead of “abstract ball complexes.”

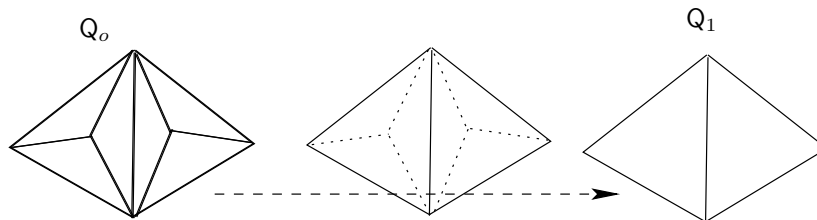

FIGURE 1.

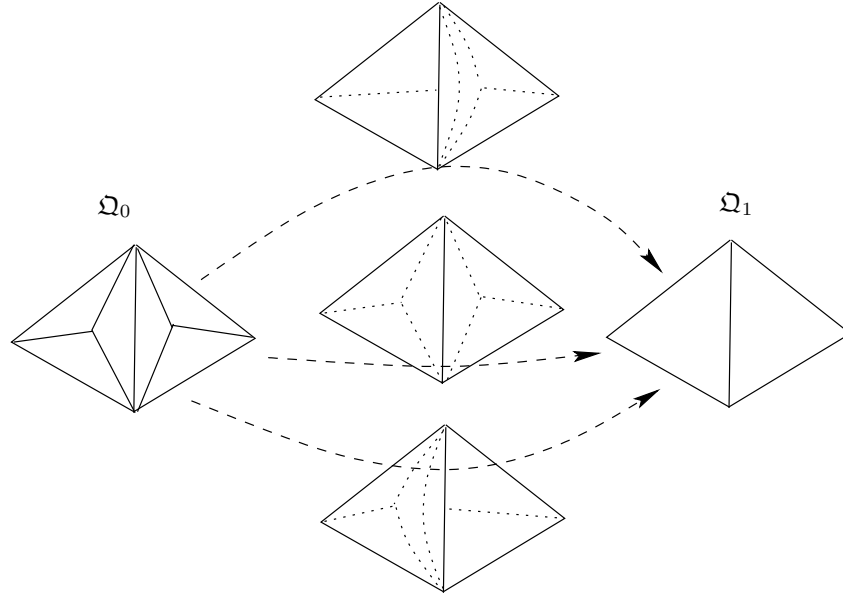

FIGURE 2.

Then the cellular space of orbits  $BR(X)/PL(X)^\delta$  coincides with  $B\mathfrak{A}(X)$ , and  $BR(X) \xrightarrow{BP} B\mathfrak{A}(X)$  is a projection to the space of orbits. We should mention that the action (1) is highly nonfree.

The category  $\mathfrak{A}(X)$  is an object of the classical combinatorial topology of the manifold  $X$ . For example, Alexander’s theorem on combinatorial manifolds [2] is the assertion that the space  $B\mathfrak{A}(X)$  will remain connected if we restrict the class of all morphisms to the more tame class of “stellar assemblies.”

Denote by  $PL(X)$  the simplicial group of PL homeomorphisms of  $X$ . Denote by  $|PL(X)|$  the cellular topological group that is the geometric realization of  $PL(X)$ . In statistical models of topological quantum field theory, the simple fact is known that

$$(2) \quad \pi_1 B\mathfrak{A}(X) \approx \pi_0 |PL(X)|.$$

The group  $\pi_0 |PL(X)|$  is the mapping class group of the manifold  $X$ . We prove the following generalization of (2).

**Theorem A.** *The spaces  $B\mathfrak{A}(X)$  and  $BPL(X)$  are homotopy equivalent.*

Thus the category  $\mathfrak{A}(X)$  is a discrete category that represents a delooping of the simplicial group  $PL(X)$ . Generally, for any topological (or simplicial) group there exists a delooping using a discrete category or even a discrete monoid [24]. The source of problems about discrete categories representing deloopings of classical spaces is

the algebraic K-theory of topological spaces, starting with the famous Hatcher's paper [12]. The closest assertion to our theorems is probably Steinberger's theorem [32, Theorem 1, p. 12], which is a refinement of Hatcher's conjecture [12, Proposition 2.5, p. 109]. Steinberger's theorem says that the discrete category of ordered simplicial complexes whose morphisms are monotone maps with contractible preimages of simplices classifies Serre PL bundles.

Let  $EPL(X)$  be the contractible total space of the universal principal bundle for the group  $|\mathrm{PL}(X)|$ , let

$$(3) \quad |\mathrm{PL}(X)| \times EPL(X) \rightarrow EPL(X)$$

be the canonical free action, and let  $EPL(X) \rightarrow BPL(X)$  be the projection to the space of orbits. Informally speaking, we prove that the nonfree action (1) of the discrete group  $\mathrm{PL}^\delta(X)$  on the contractible space  $B\mathbf{R}(X)$  can be deformed to the canonical free action (3) by a homotopy. In this form, our results are relatives of Levitt's models for  $BPL$  (see [19]) presenting  $BPL$  as orbit spaces. But in our case we are able to eliminate geometry completely.

The first situations where Theorem A can be regarded as already known appear when  $\dim X = 1$  and  $X$  is the interval  $I$  or the circle  $S^1$ . Here  $\mathfrak{R}(I)^{\mathrm{op}}$  is the category whose objects are all finite ordinals and morphisms are generated by injective monotone maps and the additional map of inverting the order;  $\mathfrak{R}(S^1)^{\mathrm{op}}$  is the category whose objects are all cyclically ordered finite sets and morphisms are generated by injective monotone maps and the additional map of inverting the order. The category  $\mathfrak{R}(S^1)^{\mathrm{op}}$  is closely related to Connes' cyclic category. In these cases,

$$B\mathfrak{R}(I) \approx BPL(I) \approx BO(1)$$

and

$$B\mathfrak{R}(S^1) \approx BPL(S^1) \approx BO(2).$$

The last assertion is a close relative of the theorem on the homotopy type of the cyclic category (see [20]).

The assertion that  $B\mathfrak{R}(X) \approx BPL(X)$  can be rephrased with the help of the theory of representable homotopy functors. An equivalent theorem states that there is a one-to-one correspondence between isomorphism classes of PL fiber bundles with fiber  $X$  on a polyhedron  $B$  and concordance classes of  $\mathfrak{R}(X)$ -colored triangulations of  $B$  (the vertices of triangulations are colored by objects and the 1-simplices are colored by morphisms in such a way that the 2-skeleton turns into a commutative diagram). Thus a functorial combinatorics of PL fiber bundle shows up, and it is natural to pose a question about generalizations of the known combinatorial formulas for characteristic classes to PL fiber bundles.

We prove an analog of Theorem A for the subcategory  $\mathfrak{T}(X)$  of  $\mathfrak{R}(X)$ . The subcategory  $\mathfrak{T}(X)$  is formed by abstract simplicial complexes (i.e., combinatorial manifolds of type  $X$ ) and their abstract assemblies.

**Theorem B.** *The spaces  $B\mathfrak{T}(X)$  and  $BPL(X)$  are homotopy equivalent.*

We may hope that there exist interesting subcategories of  $\mathfrak{T}(X)$  for which the theorem is still valid. Probably, it is possible to refine our constructions so that they will work for the category of Brouwer manifolds and linear representable assemblies. In the original project (see [4]) it was supposed that the minimal subcategory of  $\mathfrak{T}(X)$  modeling  $PL(X)$  is the category of locally stellar manifolds and stellar assemblies. This would be true in the case of the positive solution of the famous problem (see [15, p. 14]) of the existence of a common geometric stellar subdivision for any two linear triangulations of the simplex. The positive solution of this problem would follow from the “strong Oda conjecture” on decomposition of a birational isomorphism of smooth toric varieties. However, a serious flaw was discovered in the proof [28] of the strong Oda conjecture (see [1]), and now the situation with the problem of the existence of a common stellar subdivision looks pessimistic. But in fact we need the following weaker assertion, for which we still have a hope.

**Conjecture.** *The poset of all linear triangulations of the simplex ordered by stellar subdivision is homotopy trivial.*

Probably, with some cosmetic changes in the proofs, analogs of Theorems A, B hold for any compact stratified polyhedron. We analyze only the most important case of this kind: that of the sphere with a fixed point:  $X = (S^n, \{*\})$ .

According to Kuiper and Lashof [17], there is a one-to-one correspondence between isomorphism classes of PL Milnor  $n$ -microbundles, PL fiber bundles with fiber  $\mathbb{R}^n$ , and PL fiber bundles whose fiber is the pair  $(S^n, \{*\})$ . This correspondence produces the homotopy equivalences  $BPL_n \approx BPL(\mathbb{R}^n) \approx BPL(S^n, \{*\})$ . We apply our scheme to  $BPL(S^n, \{*\})$ . As a result, we are able to build a combinatorial model of  $BPL_n$  that has a remarkable property: the tangent bundle and the Gauss map of a combinatorial manifold obtain a canonical combinatorial form. Let  $\mathfrak{R}_n$  be the category whose objects are abstract  $n$ -dimensional spherical PL ball complexes with a marked  $n$ -ball and morphisms are combinatorial assemblies sending a marked ball to a marked ball (see Fig. 3).

**Theorem C.** *The spaces  $B\mathfrak{R}_n$  and  $BPL_n$  are homotopy equivalent.*

Let  $M^n$  be a combinatorial manifold. Let  $(\mathbf{PM}^n)^{\text{op}}$  be the poset of simplices of  $M^n$  with the reversed order. There is a functor  $(\mathbf{PM}^n)^{\text{op}} \xrightarrow{\mathbf{G}} \mathfrak{R}_n$ . The value of  $\mathbf{G}$  at a

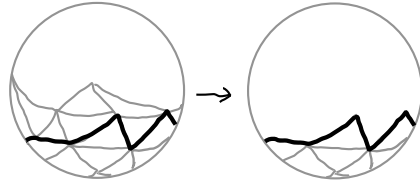

FIGURE 3.

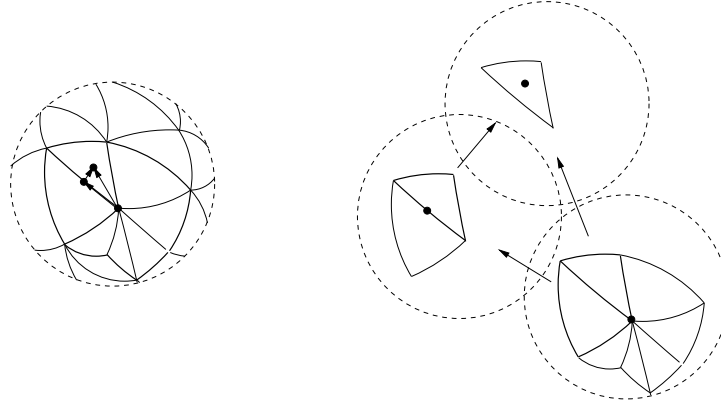

FIGURE 4.

simplex of  $M^n$  is the star of this simplex with an extra  $n$ -ball attached by the link of the simplex so as to obtain an  $n$ -sphere. This ball is the marked ball.

It is easy to imagine  $\mathbf{G}$  for the combinatorial sphere  $S^n$ . For a simplex  $s \in S^n$ , the sphere  $\mathbf{G}(s)$  is the  $n$ -dimensional abstract ball complex that is the result of assembling all the simplices of  $S^n$  that are not in the star of  $s$  into one marked  $n$ -ball. If  $s_0 \subset s_1 \in S^n$ , then  $\text{star } s_0 \supset \text{star } s_1$  and all the extra simplices of  $\mathbf{G}(s_0)$  are dissolved in the marked ball of  $\mathbf{G}(s_1)$ . This defines the assembly morphism  $\mathbf{G}(s_0 \subset s_1)$  (see Fig. 4).

The space  $B(\mathbf{P}M^n)^{\text{op}}$  is homeomorphic to  $|M^n|$ .

**Theorem D.** *Two maps  $|M^n| \rightarrow BPL_n$  are homotopy equivalent: the Gauss map for the tangent bundle of the manifold  $|M^n|$  and the map  $|M^n| \xrightarrow{B\mathbf{G}} B\mathfrak{A}_n \approx BPL_n$ .*

The construction has the following remarkable property. The simplicial bundle  $\text{hocolim } \mathbf{G} \rightarrow \mathcal{N}PM^n$  is a spherical bundle with zero and infinity sections. It is the Kuiper–Lashof model of the tangent bundle  $T|M^n|$ . The simplicial complex  $\text{hocolim } \mathbf{G}$  is again a combinatorial manifold, and we can iterate the construction. Already in the case of convex polytopes, this situation looks interesting. Figure 5



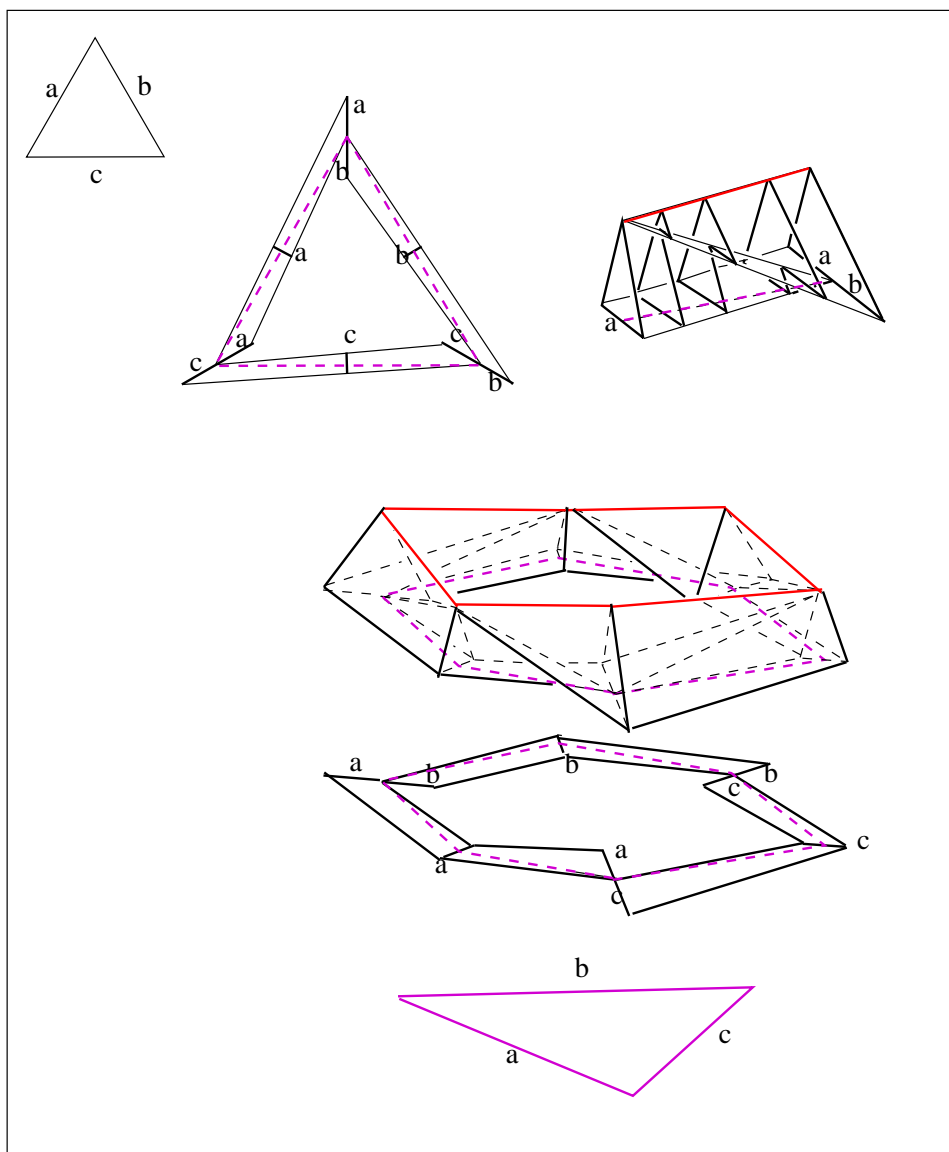

FIGURE 5.

is our attempt to draw the canonical cellular structure on the tangent bundle of a triangle.

1.2. The main technical result of the paper is the proof of Theorem A. Let us describe how we would like to, but cannot, prove such a theorem. This speculation is borrowed from [32].

There are two simple functorial constructions, which are probably originated from [33]. We will denote these constructions by  $\text{hocolim}$  and  $\text{hocolim}^{-1}$ .

- The construction  $\text{hocolim}$  takes an  $\mathfrak{R}(X)$ -coloring of a triangulation of a polyhedron  $B$  and produces a PL fiber bundle on  $B$ .
- The construction  $\text{hocolim}^{-1}$  takes a PL fiber bundle on  $B$  with fiber  $X$  and produces an  $\mathfrak{R}(X)$ -coloring of some triangulation of  $B$ .

The construction  $\text{hocolim}$  has many different names: “iterated mapping cone” [10], “homotopy colimit,” “Grothendieck construction” [11], “double bar-construction” [22, § 12]. The inverse construction,  $\text{hocolim}^{-1}$ , appears explicitly in [12] and uses triangulations of bundles. One can triangulate a bundle. Let us fix such a triangulation. We obtain a diagram of combinatorial morphisms of the ball structures on  $X$  in the fibers over the vertices of the first barycentric subdivision of the base. Then the dual morphisms form an  $\mathfrak{R}(X)$ -coloring of the base. The composite  $\text{hocolim} \circ \text{hocolim}^{-1}$ , given a bundle, produces an isomorphic bundle. We will obtain a short proof of Theorem A if we present a construction of a canonical concordance between an  $\mathfrak{R}(X)$ -coloring  $\xi$  of a simplicial complex  $K$  and the coloring  $\text{hocolim}^{-1} \circ \text{hocolim} \xi$  of the complex  $\text{sd } K$ . Unfortunately, there is no guarantee of the existence of such a canonical construction. For the case of Serre bundles, Steinberger [32] constructed such a functorial concordance, but his construction does not work for fiber bundles. It follows from our results that  $\xi$  and  $\text{hocolim}^{-1} \circ \text{hocolim} \xi$  are nevertheless concordant, but our concordance is absolutely transcendental.

1.3. The core of our proof of Theorem A is Lemma 12 on page 90 “on simultaneous fragmentation of fiberwise PL homeomorphisms of the trivial fiber bundle over the cube.” This lemma is a straightforward generalization of the lemma on fragmentation of an isotopy. Let us roughly describe our scheme of reasoning.

Assume that we wish to prove the fact of the homotopy equivalence  $B\mathfrak{R}(X) \approx B\text{PL}(X)$  in its reformulation in terms of Brown’s theory of representable homotopy functors. Thus we wish to find a functorial way to relate a fiber bundle with an  $\mathfrak{R}(X)$ -coloring of a polyhedron  $B$ , and *vice versa*. Let us describe some process of constructing a bundle from a coloring. We are unable to fight with the combinatorics of the  $\text{hocolim}$ -construction, so we will replace it by the traditional construction of pasting trivializations with the help of structure homeomorphisms.

Let  $K$  be an  $\mathfrak{R}(X)$ -colored simplicial complex. The coloring of  $K$  induces a coloring of each  $k$ -simplex of  $K$  by a chain

$$\Omega_0 \rightsquigarrow \Omega_1 \rightsquigarrow \dots \rightsquigarrow \Omega_k$$

FIGURE 6.

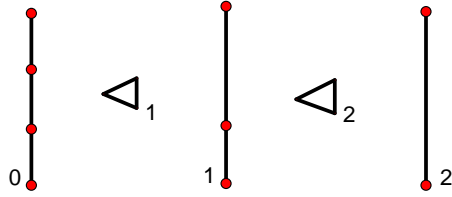
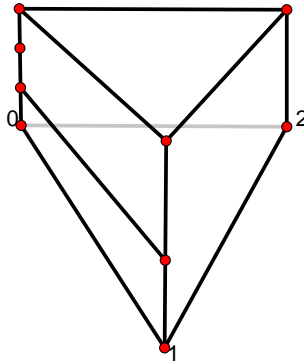

FIGURE 7.



of abstract assemblies. This chain can be realized by a chain

$$(4) \quad Q = (Q_0 \trianglelefteq Q_1 \trianglelefteq \dots \trianglelefteq Q_k)$$

of geometric assemblies of geometric PL ball complexes. With the chain  $Q$  we can associate the ball decomposition of the trivial bundle  $X \times \Delta^k \xrightarrow{\pi} \Delta^k$  into the horizontal “prisms,” i.e., the trivial subbundles whose fiber is a ball. Figures 6 and 7 illustrate the construction of the prismatic decomposition of  $\pi$  from a chain of geometric assemblies.

The combinatorics of the coloring associates to any pair of simplices  $s_0 \subset s_1$  in  $K$  a combinatorial isomorphism of two prismatic structures on the trivial bundle over  $s$ . By Alexander’s trick, all these combinatorial isomorphisms can be represented by fiberwise structure PL homeomorphisms of the fiber bundle with base  $L$  and fiber  $X$ . All these structure homeomorphisms map prisms to prisms. As a result, from the

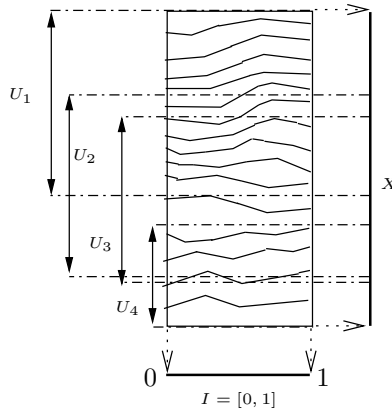

FIGURE 8.

$\mathfrak{R}(X)$ -colorings we obtain the class of fiber bundles with unusual, “prismatic,” structure homeomorphisms. In this setup, the inverse problem is to learn how to deform the structure homeomorphisms of an arbitrary PL fiber bundle into the “prismatic” form and construct a consistent coloring of the base in a controllable way. At this point it is useful to recall the proof of the lemma on fragmentation of an isotopy. In the PL case, this lemma was proved by Hudson [15]. It states that for any cover  $U = \{U_i\}_i$  of a manifold  $X$  by open balls and for any PL homeomorphism  $X \xrightarrow{f} X$  isotopic to the identity there exists a finite decomposition  $f = f_1 \circ \dots \circ f_m$  such that for every  $i$  there exists  $j$  with  $\text{supp } f_i \subset U_j$ . The proof of the fragmentation lemma contains more information than its statement. In the proof we pick an arbitrary PL isotopy  $F$  connecting  $f$  and the identity. Then we deform  $F$  in the class of isotopies with fixed ends to an isotopy  $F'$  of a special form. The isotopy  $F'$  corresponds to a chain of isotopies that are fixed on the complements of the open balls from  $U$ . The isotopy  $F$  is a fiberwise homeomorphism

$$\begin{array}{ccc}
 X \times [0, 1] & \xrightarrow{F} & X \times [0, 1] \\
 \searrow \pi_2 & & \swarrow \pi_2 \\
 & [0, 1] &
 \end{array}$$

such that  $F_0 = \text{id}$  and  $F_1 = f$ . The homeomorphism  $F$  is in turn the same thing as a one-dimensional foliation  $\mathcal{F}$  on  $X \times [0, 1]$  transversal to the fibers of the projection  $\pi_2$  (see Fig. 8). The homeomorphism  $F'$  corresponds to a foliation  $\mathcal{F}'$  with the following property: for any point  $b \in [0, 1]$ , all points  $x \in X$  such that the leaf of  $\mathcal{F}$  “is not horizontal” at  $(x, b)$  are contained in an element of  $U$  (see 9). Inspecting

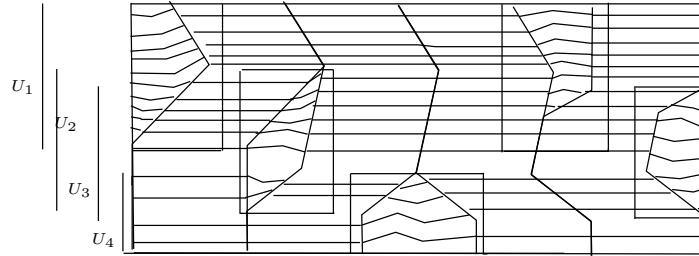

FIGURE 9.

the figure of  $\mathcal{F}'$ , it is easy to see that we can subdivide the base  $[0, 1]$  into intervals  $u_1, \dots, u_m$  and introduce a prismatic structure on all subbundles  $X \times u_i \xrightarrow{\pi_2} u_i$  such that the induced homeomorphisms  $F'|_{u_i}$  are prismatic. Thus the construction of the fragmentation lemma allows us to deform a fiberwise homeomorphism of the trivial bundle over the interval into a system of prismatic homeomorphisms over a subdivision of the interval. The deformation  $F \rightsquigarrow F'$  has a canonical form; it has a coordinate generalization to homeomorphisms of the trivial bundle over the cube. Our main task is to formulate and analyze this generalization.

**1.4. The plan of the paper.** Section 2 contains a detailed definition of combinatorial assemblies of abstract ball complexes.

Section 3 contains a universal construction of the tautological  $\text{PL}(X)$  fiber bundle on  $B\mathfrak{A}(X)$ . We emphasize the special role of “prismatic” homeomorphisms, which are used for constructing the classifying map

$$(5) \quad B\mathfrak{A}(X) \rightarrow B\text{PL}(X).$$

We introduce the simplicial groupoid of prismatic homeomorphisms  $\text{Prism}(X)$  and then construct a map of simplicial sets  $\overline{\mathcal{W}}\text{Prism}(X) \rightarrow \mathcal{W}\text{Prism}(X)$  that is a formal analog of the  $\mathcal{W}$ -construction for the universal principal bundle. It is easy to compare the  $\mathcal{W}$ -construction for  $\text{Prism}(X)$  with the standard  $\mathcal{W}$ -construction for  $\text{PL}(X)$  and with the map  $B\mathbf{R}(X) \xrightarrow{BP} B\mathfrak{A}(X)$ . Thus Theorem A is reduced to Lemma 4 on page 33 “on prismatic trivialization.”

In Sec. 4 we reduce Lemma 4 “on prismatic trivialization” to the pure geometric Lemma 5 on page 35 “on a common  $\mathbf{R}(X)$ -triangulation of a family of fiberwise homeomorphisms.” A descriptive formulation of Lemma 5 is as follows. Consider the simplicial set  $\underline{\text{Prism}}^m(X)$  whose typical  $k$ -simplex is a collection  $\langle \mathbf{Q}, G_1, \dots, G_m \rangle$ , where  $\mathbf{Q}$  is a chain of geometric assemblies (4) and  $G_i \in \text{PL}_k(X)$ ,  $i = 1, \dots, m$ , are  $\mathbf{Q}$ -prismatic homeomorphisms. That is, the homeomorphisms  $G_i^{-1}$  send the prisms

of  $\mathbb{T}(\mathbb{Q})$  to prisms. The set  $\underline{\text{Prism}}^{m+1}(X)$  is naturally embedded into  $\underline{\text{Prism}}^m(X) \times \text{PL}(X)$ . Lemma 5 states that

*the pair  $(|\underline{\text{Prism}}^m(X) \times \text{PL}(X)|, |\underline{\text{Prism}}^{m+1}(X)|)$  is homotopy trivial.*

The translation of this assertion into the common language reads as follows:

*one can deform any new nonprismatic homeomorphism to the prismatic form jointly with some family of homeomorphisms in such a way that all prismatic homeomorphisms in the family will remain prismatic.*

This fact is the central technical result of the paper. The plan of the proof of Lemma 5 is contained in Sec. 5, and the proof itself occupies Secs. 6–15. We introduce the general notions of “Alexandroff presheaf” and “prismaticity of a fiberwise homeomorphism with respect to an Alexandroff presheaf.” For these generalized prismatic homeomorphisms we develop some surgery centered around a generalized Hudson’s construction of fragmentation for a PL isotopy.

In Sec. 16 we describe how to tweak the general scheme in order to obtain a proof of Theorem B.

In Sec. 17 we describe how to tweak the general scheme in order to obtain a proof of Theorem C. Then we demonstrate that our combinatorial construction of the tangent bundle represents the Milnor tangent microbundle. This proves Theorem D.

1.5. Our theorems appear as an answer to the natural question about relations between geometric and abstract triangulations of a manifold. This question arose at A. M. Vershik’s seminar in the author’s student years. It was converted into conjectures during the joint work with Peter Mani-Levitska and Laura Anderson. The conjecture on a combinatorial model of  $B\text{PL}_n$  (which is now Theorem C) was a PL analog of the conjectures on the MacPhersonian<sup>2</sup> (a hypothetical combinatorial model for  $BO(n)$  [27]). We can mention that our theorems combined with the classical knowledge on the relations between  $\text{PL}(S^n)$ ,  $\text{Diff}(S^n)$ , and  $O(n+1)$  (see [13]) produce the following combinatorial models of the Grassmannians  $BO(n)$ ,  $n = 1, 2, 3, 4$ :

$$B\mathfrak{A}(S^{n-1}) \approx B\mathfrak{Z}(S^{n-1}) \approx B\mathfrak{A}_n \approx BO(n).$$

As mentioned above, the first project [4] of proving our theorems was based on the proof [28] of the strong Oda’s conjecture. This proof appears to be wrong (see [1]). Our current proofs are independent from Oda’s conjecture.

---

<sup>2</sup>The proof of these conjectures in [6] contains a very serious flaw (see [26]).

The author is grateful to A. M. Vershik for permanent support and wise advices, to the St. Petersburg Department of Steklov Institute of Mathematics for financial support and wonderful atmosphere, to Peter Mani and Laura Anderson for countless stimulative talks and fantastic hospitality at Bern and College Station during the initial stage of the project.

## 2. ASSEMBLIES OF BALL COMPLEXES, THE POSET $\mathbf{R}(X)$ , AND THE CATEGORY $\mathfrak{R}(X)$

In this section we define geometric and combinatorial assemblies of ball complexes.

2.1. Our principal category is the category PL of piecewise linear Euclidean polyhedra and piecewise linear maps. The foundations of PL topology can be found in the books [31, 15] and the notes of Zeeman’s seminar [34].

**Warning:** *in this paper, all polyhedra, manifolds, maps, etc. are assumed to be piecewise linear unless another category is specified.*

2.2. **Ball complexes.** For general information on topological ball complexes, see the book [21]. PL ball complexes appeared in PL geometric topology (e.g., in [9]). We recall the standard definition of a “topological ball complex” or, equivalently, a “finite regular *CW*-complex.”

A **topological ball complex** is a finite cover  $S$  of a Hausdorff space  $X$  by closed topological balls such that

- (i) the relative interiors of the balls from  $S$  form a partition of  $X$ ;
- (ii) the boundary of every ball from  $S$  is the union of balls of smaller dimension.

A PL **ball complex** on a Euclidean polyhedron  $X$  is a finite cover  $S$  of  $X$  by closed PL balls such that the conditions (i), (ii) are satisfied. The main example of a PL ball complex is a finite geometrical simplicial complex. *In what follows, a “ball complex” means a “PL ball complex.”*

2.3. **The category PLball.** The category **PLball** is the category whose objects are ball complexes and morphisms are maps that send the relative interiors of balls into (not necessarily *onto*) the relative interiors of balls. To be more precise, a morphism  $(X_0, S_0) \rightarrow (X_1, S_1)$  is a pair  $(h, \xi)$ , where  $X_0 \xrightarrow{h} X_1$  is a PL map and  $S_0 \xrightarrow{\xi} S_1$  is a map of ball sets such that for every  $s \in S_0$  the inclusion  $h(\text{relint } s) \subseteq \text{relint } \xi(s)$  holds. The category **PLball** is not very interesting, it merely contains our working subcategories.

**2.4. Abstract ball complexes.** For every ball complex  $(X, S)$ , the polyhedron  $X$  is determined up to homeomorphism by pure combinatorial data, namely, by the combinatorics of the adjacency of balls of  $S$ . Let us formulate this assertion in detail.

Let  $\mathbf{D} = (X, S)$  be a ball complex. Denote by  $\mathbf{P}(\mathbf{D})$  the partial order by inclusion on  $S$ . Consider the abstract simplicial complex  $\text{Ord } \mathbf{P}(\mathbf{D})$ , the order complex of the poset  $\mathbf{P}(\mathbf{D})$ . Let  $|\text{Ord } \mathbf{P}(\mathbf{D})|$  be the geometric realization of  $\text{Ord } \mathbf{P}(\mathbf{D})$ . Let us introduce the standard notation. Given a poset  $\mathcal{P}$  and an element  $p \in \mathcal{P}$ , denote by  $p_{\leq}$  the subposet of  $\mathcal{P}$  formed by all elements that are less or equal to  $p$  (the “lower principal ideal generated by  $p$ ”). Denote by  $p_{<}$  the ideal formed by all elements that are strictly less than  $p$ . The following theorem holds (see [21]).

**Theorem 1.** *For every ball complex  $\mathbf{D} = (X, S)$  there is a cellular homeomorphism*

$$(X, S) \approx (|\text{Ord } \mathbf{P}(\mathbf{D})|, \{|\text{Ord } p_{\leq}|\}_{p \in \mathbf{P}(\mathbf{D})}).$$

The polyhedra  $\{|\text{Ord } p_{\leq}|\}_{p \in \mathbf{P}(\mathbf{D})}$  from Theorem 1 are automatically the boundary spheres of cells. The last property allows us to define an abstract ball complex. The following theorem holds (see [7]).

**Theorem 2.** *Let  $\mathcal{P}$  be a finite poset satisfying the following property: if  $p \in \mathcal{P}$  and the rank of  $p$  is equal to  $k$ , then  $|\text{Ord } p_{\leq}| \approx S^{k-1}$ . Then*

$$(|\text{Ord } \mathcal{P}|, \{|\text{Ord } p_{\leq}|\}_{p \in \mathcal{P}})$$

*is a ball complex.*

A poset that satisfies the conditions of Theorem 2 is called an **abstract ball complex**. Theorems 1 and 2 were originally formulated for topological ball complexes, but the proofs work in the PL category without any changes. Thus by an **abstract PL ball complex** (in this paper, it will be called an “abstract ball complex”) we mean a finite poset  $\mathcal{P}$  such that  $|\text{Ord } p_{\leq}| \underset{\text{PL}}{\approx} S^{k-1}$  for every  $p \in \mathcal{P}$  of rank  $k$ . The PL version of Theorem 2 states that in this case  $(|\text{Ord } \mathcal{P}|, \{|\text{Ord } p_{\leq}|\}_{p \in \mathcal{P}})$  is a PL ball complex.

**2.5. The functor  $\text{PLball} \xrightarrow{\mathbf{P}} \text{Posets}$ .** Consider a **PLball**-morphism  $(X_0, S_0) \xrightarrow{(h, \xi)} (X_1, S_1)$ . From the definition of a ball complex it follows that  $\xi$  is a morphism of the posets of balls. Therefore the correspondence  $\mathbf{D} \mapsto \mathbf{P}(\mathbf{D})$  is a functor with values in the category of posets.



**2.6. Geometric assemblies of ball complexes, the poset  $\mathbf{R}(X)$ .** A *geometric assembly* of ball complexes on  $X$  is a **PLball**-morphism  $(X, S_0) \xrightarrow{(h, \xi)} (X, S_1)$  such that  $h$  is the identity map. Such a situation is possible only when the relative interior of every ball  $s \in S_0$  is contained in the relative interior of the ball  $\xi(s) \in S_1$ . This means that the partition of  $X$  into the relative interiors of balls from  $S_1$  is subdivided by the partition into the relative interiors of balls from  $S_0$ . Therefore a geometric assembly morphism  $(X, S_0) \rightarrow (X, S_1)$  is unique if it exists. Thus the geometric assemblies form a poset  $\mathbf{R}(X) \hookrightarrow \mathbf{PLball}$  on the set of all ball complexes with the underlying polyhedron  $X$ . We denote a geometric assembly  $Q_0 \rightarrow Q_1$  by  $Q_0 \trianglelefteq Q_1$ .

**2.7. The category  $\mathcal{R}(X)$ .** Consider the subcategory  $\mathcal{R}(X) \hookrightarrow \mathbf{PLball}$  whose objects are regular ball complexes on  $X$  and morphisms are of the form  $(X, S_0) \xrightarrow{(h, \xi)} (X, S_1)$ , where  $X \xrightarrow{h} X$  is a homeomorphism. The poset  $\mathbf{R}(X)$  sits in  $\mathcal{R}(X)$  as a subcategory. The morphisms of  $\mathcal{R}(X)$  are generated by two classes:

- (i) assemblies  $\trianglelefteq$ ,
- (ii) cellular homeomorphisms (i.e., homeomorphisms sending every ball onto a ball).

Obviously, the following proposition holds.

**Proposition 1.** *Every morphism  $Q_0 \xrightarrow{f} Q_1$  of  $\mathcal{R}(X)$  has two canonical decompositions*

$$(6) \quad \begin{array}{ccc} & Q'_0 & \\ \trianglelefteq_1 \nearrow & & \searrow h_1 \\ Q_0 & \xrightarrow{f} & Q_1 \\ h_2 \searrow & & \nearrow \trianglelefteq_2 \\ & Q'_1 & \end{array}$$

*into a homeomorphism and an assembly, i.e., an assembly in the source and a homeomorphism in the target or an assembly in the target and a homeomorphism in the source.*

**2.8. The category  $\tilde{\mathfrak{R}}(X)$  of combinatorial assemblies of geometric ball complexes and the category  $\mathfrak{R}(X)$ .** Consider the category  $\tilde{\mathfrak{R}}(X)$  whose objects are ball complexes on  $X$  and an  $\tilde{\mathfrak{R}}(X)$ -morphism  $Q_0 \xrightarrow{\mathfrak{f}} Q_1$  is a morphism of posets  $\mathbf{P}Q_0 \xrightarrow{\mathfrak{f}} \mathbf{P}Q_1$  that is representable by some  $\mathcal{R}(X)$ -morphism. That is,  $\mathfrak{f}$  is a poset morphism such that there is a morphism  $Q_0 \xrightarrow{f} Q_1$  for which  $\mathbf{P}(f) = \mathfrak{f}$ . Such poset

morphisms will be called **abstract assemblies**. Using the decomposition from Proposition 1, we can easily establish the following fact.

**Proposition 2.** *The composition of abstract assemblies is an abstract assembly.*

Therefore  $\tilde{\mathfrak{R}}(X)$  is a well-defined category; there is a forgetful functor  $\mathfrak{R}(X) \xrightarrow{\mathbf{A}} \tilde{\mathfrak{R}}(X)$ , which is identical on objects and sends a morphism of  $\mathfrak{R}(X)$  to the corresponding abstract assembly. The poset  $\mathbf{R}(X)$  is a subcategory of  $\mathfrak{R}(X)$ . Denote by  $\mathbf{A}$  the composite

$$\mathbf{A} = (\mathbf{R}(X) \hookrightarrow \mathfrak{R}(X) \xrightarrow{\mathbf{A}} \tilde{\mathfrak{R}}(X)).$$

Note that it is easy to give a transcendental but “pure combinatorial” definition of an abstract assembly of abstract ball complexes. Namely, the following proposition holds.

**Proposition 3.** *A morphism  $Q_0 \xrightarrow{f} Q_1$  is an abstract assembly if and only if for every  $b \in \mathbf{P}Q_1$  of rank  $k$  the poset  $f^{-1}(b_{\leq}) \subseteq \mathbf{P}Q_0$  is an abstract ball complex representing a  $k$ -dimensional PL ball.*

From the PL variant of Theorem 1 on page 16 we know that any two combinatorially isomorphic geometric ball complexes are isomorphic in  $\mathfrak{R}(X)$ . This allows us to identify, up to *equivalence of categories*, the category  $\tilde{\mathfrak{R}}(X)$  with the category  $\mathfrak{R}(X)$  whose objects are all abstract ball complexes representing  $X$  by geometric realizations and morphisms are abstract assemblies of abstract ball complexes, i.e., poset morphisms  $\mathcal{P}_0 \xrightarrow{\mu} \mathcal{P}_1$ ,  $\mathcal{P}_0, \mathcal{P}_1 \in \text{Ob } \mathfrak{R}(X)$ , representable by  $\mathfrak{R}(X)$ -morphisms of geometric realizations. Thus we obtain the commutative triangle of functors

$$(7) \quad \begin{array}{ccc} & \mathbf{R}(X) & \\ & \swarrow \mathbf{A} & \downarrow \mathbf{P} \\ \tilde{\mathfrak{R}}(X) & \xrightarrow{\mathbf{F}} & \mathfrak{R}(X), \end{array}$$

where  $\mathbf{F}$  is the forgetful functor inducing an equivalence of the categories  $\tilde{\mathfrak{R}}(X)$  and  $\mathfrak{R}(X)$ .

**2.9.  $\mathcal{N}\mathfrak{R}(X)$  as the orbit space of an action of  $\text{PL}^\delta(X)$  on a contractible space.** Now we switch to a more scientific point of view on the functor  $\mathbf{R}(X) \xrightarrow{\mathbf{P}} \mathfrak{R}(X)$ . Let us pass to the nerve  $\mathcal{N}\mathbf{R}(X) \xrightarrow{\mathcal{N}\mathbf{P}} \mathcal{N}\mathfrak{R}(X)$  of this functor. There is an action of a discrete simplicial group  $\text{PL}^\delta(X)$  on  $\mathcal{N}\mathbf{R}(X)$ . A typical  $k$ -simplex

of  $\text{PL}^\delta(X)$  is an ordered set  $g = (g_0, \dots, g_k)$ ,  $g_i \in \text{PL}(X)$ ,  $i = 1, \dots, k$ ,  $g_i = g_j$ . If  $\mathbf{Q} \in \mathcal{N}_k \mathbf{R}(X)$ ,  $\mathbf{Q} = (\mathbf{Q}_0 \trianglelefteq \dots \trianglelefteq \mathbf{Q}_k)$ , then we set

$$g\mathbf{Q} = (g_0\mathbf{Q}_0 \trianglelefteq g_1\mathbf{Q}_1 \trianglelefteq \dots \trianglelefteq g_k\mathbf{Q}_k) \in \mathcal{N}\mathbf{R}(X).$$

This defines an action

$$\text{PL}^\delta(X) \times \mathcal{N}\mathbf{R}(X) \rightarrow \mathcal{N}\mathbf{R}(X).$$

**Lemma 1.**  $\mathcal{N}\mathfrak{A}(X) = \mathcal{N}\mathbf{R}(X)/\text{PL}^\delta(X)$ , and  $\mathcal{N}\mathbf{R}(X) \xrightarrow{\mathcal{N}\mathbf{P}} \mathcal{N}\mathfrak{A}(X)$  is a projection to the space of orbits.

*Proof.* By definition (see, for example, [14, p. 303]), the  $k$ -simplices of  $\mathcal{N}\mathbf{R}(X)/\text{PL}^\delta(X)$  are the orbits of the action of  $\text{PL}_k^\delta(X)$  on  $\mathcal{N}_k \mathbf{R}(X)$  with the induced simplicial structure: for  $\mathbf{Q} \in \mathcal{N}_k \mathbf{R}(X)$ , the orbits of  $d_i\mathbf{Q}$  and  $s_i\mathbf{Q}$  are determined by the orbit of  $\mathbf{Q}$ . This exactly identifies  $\mathcal{N}\mathbf{R}(X)/\text{PL}^\delta(X)$  and  $\mathcal{N}\mathfrak{A}(X)$ .  $\square$

Let us also mention the following fundamental fact.

**Lemma 2.** The space  $|\mathcal{N}\mathbf{R}(X)|$  is contractible.

*Proof.* This easily follows from the fact that  $\mathbf{R}(X)$  is a poset and for every pair  $\mathbf{Q}_0, \mathbf{Q}_1 \in \mathbf{R}(X)$  there exists a common subdivision, i.e., there is  $\mathbf{Q}_3$  such that  $\mathbf{Q}_3 \trianglelefteq \mathbf{Q}_0$ ,  $\mathbf{Q}_3 \trianglelefteq \mathbf{Q}_1$  (see [29]).  $\square$

We wish to emphasize that only in the category PL there exists a common subdivision of ball complexes. Due to this fact, in other categories the existence of analogs of Lemma 2 is problematic.

### 3. PRISMATIC HOMEOMORPHISMS, REDUCTION OF THEOREM A TO THE LEMMA ON PRISMATIC TRIVIALIZATION

In this section, we present a construction of a bundle with base  $B$  and fiber  $X$  from an  $\mathfrak{A}(X)$ -coloring of a triangulation of  $B$ . This construction is described universally, as a simplicial morphism  $\mathcal{N}\mathfrak{A}(X) \rightarrow \overline{\mathcal{W}}\text{PL}(X)$  from the nerve  $\mathfrak{A}(X)$  to the  $\overline{\mathcal{W}}$ -construction of  $B\text{PL}(X)$ .

**3.1. Prismatic decompositions of trivial fiber bundles.** Let  $\mathbf{m}$  be the totally ordered set  $\{0 < 1 < \dots < m\}$ , a “finite ordinal.” Let  $\mathbf{N}$  be the category of all finite ordinals and monotone maps. Consider a chain of geometric assemblies of ball complexes  $\mathbf{m} \xrightarrow{\mathbf{Q}} \mathbf{R}(X)$ . In this subsection, with the chain  $\mathbf{Q} = (\mathbf{Q}_0 \trianglelefteq_1 \dots \trianglelefteq_m \mathbf{Q}_m)$  we will associate the structure of a ball complex  $\mathbb{T}(\mathbf{Q})$  on the polyhedron  $X \times \Delta^m$  and a **PLball**-morphism  $\mathbb{T}(\mathbf{Q}) \xrightarrow{e(\mathbf{Q})} [\Delta^m]$ . We denote by  $[\Delta^m]$  the *standard “ball simplex,”* the ball complex formed by all faces of the standard simplex  $\Delta^m$ . Let  $\mathbf{n} \xrightarrow{\theta} \mathbf{m}$  be an  $\mathbf{N}$ -morphism, and let

$$\Delta^n \xrightarrow{\Delta(\theta)} \Delta^m$$

be the corresponding cosimplicial morphism. By  $[\Delta^n] \xrightarrow{[\Delta(\theta)]} [\Delta^m]$  we denote the induced **PLBall**-morphism of the ball complexes of the standard simplices. By  $[d^i], [s^i]$  we denote the standard *cellular* cofaces and codegenerations.

Note that in the category **PLball** there exist *induced assemblies*, i.e., if a ball complex  $\mathbf{B}_0$  is a subcomplex of  $\mathbf{B}_1$  and  $\overline{\mathbf{B}}_0 \trianglelefteq \mathbf{B}_0$ , then there exists a universal dashed arrow in the diagram

$$(8) \quad \begin{array}{ccc} \overline{\mathbf{B}}_0 & \xrightarrow{\quad \subset \quad} & \overline{\mathbf{B}}_1 \\ \downarrow \trianglelefteq & & \downarrow \trianglelefteq \\ \mathbf{B}_0 & \xrightarrow{\quad \subset \quad} & \mathbf{B}_1. \end{array}$$

The set of balls of the complex  $\overline{\mathbf{B}}_1$  is the set of all balls of the complex  $\mathbf{B}_1$  with all the balls of  $\mathbf{B}_0$  deleted and all the balls of  $\overline{\mathbf{B}}_0$  added.

Consider the flag of faces of the simplex

$$\Delta^0 \xrightarrow{d^1} \Delta^1 \xrightarrow{d^2} \dots \xrightarrow{d^m} \Delta^m.$$

Consider the induced flag of trivial fiber bundles

$$(9) \quad \begin{array}{ccccccc} X \times \Delta^0 & \xrightarrow{\text{id} \times d^1} & X \times \Delta^1 & \xrightarrow{\text{id} \times d^2} & \dots & \xrightarrow{\text{id} \times d^m} & X \times \Delta^m \\ \downarrow & & \downarrow & & & & \downarrow \\ \Delta^0 & \xrightarrow{d^1} & \Delta^1 & \xrightarrow{d^2} & \dots & \xrightarrow{d^m} & \Delta^m. \end{array}$$

Consider the following construction on the total space of the flag (9). Consider the staircase of ball assemblies and embeddings

(10)

$$\begin{array}{ccccccc}
 \mathbb{Q}_0 \times [\Delta_0] \hookrightarrow & \bullet & \hookrightarrow & \bullet & \hookrightarrow & \dots & \hookrightarrow \mathbb{T}(\mathbb{Q}) \\
 \downarrow \triangleleft \times \text{id} & \downarrow \triangleleft & & \downarrow \triangleleft & & & \downarrow \triangleleft \\
 \mathbb{Q}_1 \times [\Delta^0] \xrightarrow{\text{id} \times [d^1]} & \mathbb{Q}_1 \times [\Delta^1] & \hookrightarrow & \bullet & \hookrightarrow & \dots & \hookrightarrow \bullet \\
 \downarrow \triangleleft \times \text{id} & \downarrow \triangleleft & & \downarrow \triangleleft & & & \downarrow \triangleleft \\
 & \mathbb{Q}_2 \times [\Delta^1] \xrightarrow{\text{id} \times [d^2]} & \mathbb{Q}_2 \times [\Delta^2] & \hookrightarrow & \dots & \hookrightarrow & \bullet \\
 & \downarrow \triangleleft \times \text{id} & & & & & \downarrow \triangleleft \\
 & \vdots & & & & & \vdots \\
 & & & & \downarrow \triangleleft \times \text{id} & & \downarrow \triangleleft \\
 & & & & \mathbb{Q}_m \times [\Delta^{m-1}] \xrightarrow{\text{id} \times [d^m]} & \mathbb{Q}_m \times [\Delta^m] & \bullet
 \end{array}$$

By applying (8) we can fill the north-east corner of (10). Thus  $\mathbb{T}(\mathbb{Q}) \triangleleft \mathbb{Q}_m \times [\Delta^m]$ . In our situation, the construction of the induced assembly commutes with the projection to the base. Thus we obtain a nontrivial cellular structure  $\mathbb{T}(\mathbb{Q}) \xrightarrow{e(\mathbb{Q})} [\Delta^m]$  on the trivial fiber bundle  $X \times \Delta^k \xrightarrow{\pi_2} \Delta^k$ . Figure 6 on page 11 presents an example of a 3-chain of geometric assemblies on an interval. Figure 7 on page 11 presents the corresponding ball structure on  $[0, 1] \times \Delta^2$ .

We can explicitly describe the ball structure  $\mathbb{T}(\mathbb{Q}) \xrightarrow{e(\mathbb{Q})} [\Delta^m]$ . Let  $S_i$  be the set of balls of  $\mathbb{Q}_i$ . For any subset  $\mathbf{k}$  of the set  $\mathbf{m}$ , we denote by  $\Delta^{\mathbf{k}} \subseteq \Delta^m = \Delta^{\mathbf{m}}$  the face of  $\Delta^m$  generated by vertices with numbers from  $\mathbf{k}$ . Then the ball complex  $[\Delta^m]$  has the form  $(\Delta^m, \{\Delta^{\mathbf{k}}\}_{\mathbf{k} \in 2^{\mathbf{m}}})$ . For any  $\mathbf{k} \in 2^{\mathbf{m}}$ , denote by  $\max(\mathbf{k}) \in \mathbf{m}$  the maximal element of  $\mathbf{k}$ .

**Proposition 4.** *The balls of  $\mathbb{T}(\mathbb{Q})$  are indexed by the pairs*

$$(\mathbf{k}, B) \text{ such that } \mathbf{k} \in 2^{\mathbf{m}} \text{ and } B \in S_{\max(\mathbf{k})}$$

and have the form  $T_{(\mathbf{k}, B)} = B \times \Delta^{\mathbf{k}} \subset X \times \Delta^m$ . The adjacency of balls is as follows:

$$T_{(\mathbf{k}_0, B_0)} \underset{X \times \Delta^m}{\subseteq} T_{(\mathbf{k}_1, B_1)}$$

if and only if

$$\mathbf{k}_0 \underset{\mathbf{m}}{\subseteq} \mathbf{k}_1 \quad \text{and} \quad B_0 \underset{X}{\subseteq} B_1.$$

The cellular morphism  $e(\mathbb{Q})$  projects the ball  $T_{(\mathbf{k}, B)}$  onto the ball  $\Delta^{\mathbf{k}}$  of the base.

The balls of  $\mathbb{T}(\mathbb{Q})$  will be called *prisms*. The construction  $\mathbb{T}(-)$  is functorial with respect to morphisms of faces and degenerations of simplices of  $\mathcal{NR}(X)$ . Obviously, the correspondence  $\mathbb{Q} \mapsto \mathbf{e}(\mathbb{Q})$  is a contravariant functor from the category  $C\mathcal{NR}(X)$  of simplices of the simplicial set  $\mathcal{NR}(X)$  to the category of cellular fiber bundles.

### 3.2. The simplicial groupoid of prismatic homeomorphisms $\text{Prism}(X)$ .

3.2.1. Let us fix some conventions and notations. Let  $B$  be a polyhedron. We will denote by  $\text{PL}_B(X)$  the group of fiberwise homeomorphisms of the trivial bundle  $X \times B \xrightarrow{\pi_2} B$ . If  $A \xrightarrow{h} B$  and  $f \in \text{PL}_B(X)$ , then we denote by  $f|_h \in \text{PL}_A(X)$  the homeomorphism induced by  $h$ . If  $h$  is an embedding, then we simply write  $f|_A$ . We regard the group  $\text{PL}(X)$  of PL homeomorphisms of  $X$  as a simplicial group with the group of  $m$ -simplices  $\text{PL}_m(X) = \text{PL}_{\Delta^m}(X)$ .

3.2.2. As above, let  $\mathbb{Q} = (\mathbb{Q}_0 \leq_1 \dots \leq_m \mathbb{Q}_m)$ , and let  $\mathbb{T}(\mathbb{Q}) \xrightarrow{\mathbf{e}(\mathbb{Q})} [\Delta^m]$  be the corresponding prismatic decomposition of the trivial fiber bundle. We say that a homeomorphism  $f \in \text{PL}_m(X)$  is  **$\mathbb{Q}$ -prismatic** if for every ball  $T_{\mathbf{k},B}$  of the complex  $\mathbb{T}(\mathbb{Q})$

$$(11) \quad f^{-1}(T_{(\mathbf{k},B)}) = f^{-1}|_{\max \mathbf{k}}(B) \times \Delta^{\mathbf{k}},$$

where by  $X \xrightarrow{f^{-1}|_i} X$  we denote the fiber of the homeomorphism  $f^{-1}$  over the  $i$ th vertex of  $\Delta^m$ . Put

$$(12) \quad f^{-1}\mathbb{Q} = (f^{-1}|_0(\mathbb{Q}_0) \leq f^{-1}|_0(\mathbb{Q}_1) \leq \dots \leq f^{-1}|_0(\mathbb{Q}_m)).$$

**Proposition 5.** *A  $\mathbb{Q}$ -prismatic homeomorphism  $f$  induces a fiberwise cellular homeomorphism of the cellular bundles:*

$$\begin{array}{ccc} \mathbb{T}(f^{-1}\mathbb{Q}) & \xrightarrow{f} & \mathbb{T}(\mathbb{Q}) \\ & \searrow \mathbf{e}(f^{-1}\mathbb{Q}) & \swarrow \mathbf{e}(\mathbb{Q}) \\ & & [\Delta^m]. \end{array}$$

*Proof.* From condition (11) it follows that for every  $i = 0, \dots, m$ ,  $B \in \mathbb{Q}_i$ ,

$$f^{-1}|_i(B) = f^{-1}|_0(B).$$

Indeed,  $f^{-1}(T_{(\{0,i\},B)}) = B \times \Delta^{\{0,i\}} = f^{-1}|_i(B) \times \Delta^{\{0,i\}} \equiv f^{-1}|_0(B) \times \Delta^{\{0,i\}}$ , where the last identity is coordinatewise. Therefore

$$f^{-1}|_i(\mathbb{Q}_i) = f^{-1}|_0(\mathbb{Q}_i)$$

and

$$f^{-1}|_i(\mathbf{Q}_i) = f^{-1}|_0(\mathbf{Q}_i) \trianglelefteq f^{-1}|_0(\mathbf{Q}_j) = f^{-1}|_j(\mathbf{Q}_j) \text{ for } i \leq j.$$

Thus condition (11) can be rewritten as

$$f^{-1}(T_{(B,\mathbf{k})}(\mathbf{Q})) = T_{(f^{-1}|_0(B),\mathbf{k})}(f^{-1}\mathbf{Q}),$$

i.e., as the assertion that  $f^{-1}(T_{(B,\mathbf{k})}(\mathbf{Q}))$  is a prism of  $\mathbb{T}(f^{-1}\mathbf{Q})$ .  $\square$

3.2.3. Now we can define a simplicial groupoid

$$\mathbf{N}^{\text{op}} \xrightarrow{\text{Prism}(X)} \mathbf{Groupoids}.$$

The set  $\text{Ob}_m \text{Prism}(X)$  of  $m$ -objects of this groupoid is the set of all  $m$ -simplices from  $\mathcal{NR}(X)$ . The set of  $m$ -morphisms

$$(\text{Prism}(X))(\mathbf{Q}^0, \mathbf{Q}^1)$$

is the set of all prismatic homeomorphisms sending  $\mathbb{T}(\mathbf{Q}^0)$  to  $\mathbb{T}(\mathbf{Q}^1)$  according to construction from Proposition 5. The faces and degenerations are defined in a natural way and agree with the faces and degenerations in  $\mathcal{NR}(X)$ . The simplicial “space” of the groupoid  $\text{Prism}(X)$  is the simplicial set  $\text{Mor Prism}(X)$  of all morphisms of the groupoid  $\text{Prism}(X)$ . Thus the topological space of the groupoid is the space  $|\text{Mor Prism}(X)|$ .

**Lemma 3 (On extension of a prismatic homeomorphism).**

(a) Let  $\mathbf{Q}^0, \mathbf{Q}^1 \in (\mathcal{NR}(X))_0$ , and let  $\mathbf{P}(\mathbf{Q}^0) \xrightarrow{\mu} \mathbf{P}(\mathbf{Q}^1)$  be an isomorphism. Then there exists a cellular isomorphism  $\mathbf{Q}^0 \xrightarrow{f} \mathbf{Q}^1$  such that  $\mathbf{P}(f) = \mu$ .

(b) Let  $\mathbf{Q}^0, \mathbf{Q}^1 \in (\mathcal{NR}(X))_1$ , and let  $\mathbf{Q}_0^0 \xrightarrow{f_0} \mathbf{Q}_0^1$  and  $\mathbf{Q}_1^0 \xrightarrow{f_1} \mathbf{Q}_1^1$  be cellular homeomorphisms such that the diagram

$$\begin{array}{ccc} \mathbf{P}(\mathbf{Q}_0^0) & \xrightarrow{\mathbf{P}(\trianglelefteq)} & \mathbf{P}(\mathbf{Q}_1^0) \\ \mathbf{P}(f_0) \downarrow & & \downarrow \mathbf{P}(f_1) \\ \mathbf{P}(\mathbf{Q}_1^0) & \xrightarrow{\mathbf{P}(\trianglelefteq)} & \mathbf{P}(\mathbf{Q}_1^1) \end{array}$$

is commutative. Then there exists  $f \in \text{Mor}_2 \text{Prism}(X)$ ,  $\mathbf{Q}^0 \xrightarrow{f} \mathbf{Q}^1$ , such that  $d_0 f = f_1$ ,  $d_1 f = f_2$ .

(c) Let  $\mathbf{Q}^0, \mathbf{Q}^1 \in (\mathcal{NR}(X))_m$  with  $m \geq 2$ . Let  $f_0, \dots, f_m \in \text{Mor}_{m-1} \text{Prism}(X)$ ,  $d_i \mathbf{Q}^0 \xrightarrow{f_i} d_i \mathbf{Q}^1$ , be a collection of prismatic homeomorphisms such that  $d_i f_j = d_{j-1} f_i$

whenever  $i < j$ . Then there exists  $f \in \text{Mor}_m \text{Prism}(X)$ ,  $\mathbb{Q}^0 \xrightarrow{f} \mathbb{Q}^1$ , such that  $d_i f = f_i$  for  $i = 0, \dots, m$ .

*Proof.* This lemma is a form of Alexander's trick. We will present a detailed proof, because this lemma is important for our further constructions.

1. We need the following observation, which is standard in the theory of PL fiber bundles.

Consider the space  $\mathbb{R}^k \times \mathbb{R}^l$ , the projection  $\mathbb{R}^k \times \mathbb{R}^l \xrightarrow{\pi_2} \mathbb{R}^l$ , and two geometric  $d$ -dimensional simplices  $S^0, S^1$  in  $\mathbb{R}^k \times \mathbb{R}^l$ :  $S^0 = \text{conv}(s_0^0, \dots, s_d^0)$ ,  $S^1 = \text{conv}(s_0^1, \dots, s_d^1)$ . Assume that  $\pi_2(s_i^0) = \pi_2(s_i^1)$ ,  $i = 0, \dots, d$ . Let  $S^0 \xrightarrow{A} S^1$  be an affine map such that  $A(s_i^0) = s_i^1$ ,  $i = 0, \dots, d$ . Then  $A$  is a  $\pi_2$ -fiberwise map, i.e., the diagram

$$\begin{array}{ccc} S^0 & \xrightarrow{A} & S^1 \\ & \searrow \pi_2 & \swarrow \pi_2 \\ & & \mathbb{R}^l \end{array}$$

is commutative.

This follows from the fact that the map  $A$  sends a point  $x \in S^0$ ,  $x = \sum_{i=0}^d t_i s_i^0$ , to the point  $A(x) = \sum_{i=0}^d t_i s_i^1 \in S^1$  and the calculation

$$\pi_2(A(x)) = \sum_{i=0}^d t_i \pi_2(s_i^1) = \sum_{i=0}^d t_i \pi_2(s_i^0) = \pi_2(x).$$

2. (Parametric PL Alexander's trick.) Consider the projection  $\Delta^k \times \Delta^l \xrightarrow{\pi_2} \Delta^l$ . Consider the  $(k + l - 1)$ -sphere

$$\partial(\Delta^k \times \Delta^l) = (\partial\Delta^k \times \Delta^l) \cup (\Delta^k \times \partial\Delta^l).$$

Assume that a fiberwise homeomorphism

$$\begin{array}{ccc} \partial(\Delta^k \times \Delta^l) & \xrightarrow{F} & \partial(\Delta^k \times \Delta^l) \\ & \searrow \pi_2 & \swarrow \pi_2 \\ & & \Delta^l \end{array}$$



is fixed. Then there is a fiberwise homeomorphism

$$\begin{array}{ccc}
 \Delta^k \times \Delta^l & \xrightarrow{G} & \Delta^k \times \Delta^l \\
 \searrow \pi_2 & & \swarrow \pi^2 \\
 & \Delta^l &
 \end{array}$$

such that  $G|_{\partial(\Delta^k \times \Delta^l)} = F$ .

First, we should triangulate the homeomorphism  $F$ . Second, using the convexity (*sic!*) of the prism  $\Delta^k \times \Delta^l$ , we can find stellar extensions of the triangulations in the preimage and image to combinatorially isomorphic triangulations of  $\Delta^k \times \Delta^l$ . Such a stellar extension determines a fiberwise extension of  $G$  by Step 1 of the proof.

3. Step 2 of the proof implies a more general fact. Assume that we have two balls  $B^k, B^l$ . Consider the projection  $B^k \times B^l \xrightarrow{\pi_2} B^l$ . Consider the  $(k + l - 1)$ -sphere

$$\partial(B^k \times B^l) = (\partial B^k \times B^l) \cup (B^k \times \partial B^l).$$

Assume that a fiberwise homeomorphism

$$\begin{array}{ccc}
 \partial(B^k \times B^l) & \xrightarrow{F} & \partial(B^k \times B^l) \\
 \searrow \pi_2 & & \swarrow \pi^2 \\
 & B^l &
 \end{array}$$

is fixed. Then there exists a fiberwise homeomorphism

$$\begin{array}{ccc}
 B^k \times B^l & \xrightarrow{G} & B^k \times B^l \\
 \searrow \pi_2 & & \swarrow \pi^2 \\
 & B^l &
 \end{array}$$

such that  $G|_{\partial(B^k \times B^l)} = F$ .

For the proof, we choose two homeomorphisms  $B^k \xrightarrow{H_1} \Delta^k$  and  $B^l \xrightarrow{H_2} \Delta^l$ , then apply a homeomorphism  $B^k \times B^l \xrightarrow{H_1 \times H_2} \Delta^k \times \Delta^l$  to  $B^k \times B^l$ , and refer to Step 2 of the proof.

4. Let  $\partial[\Delta^m]$  be the ball complex of the boundary of the standard simplex. For  $(\mathbf{m} \xrightarrow{\mathbf{Q}} \mathbf{R}(X)) \in (\mathcal{NR}(X))_m$ , denote by  $\theta_{(-1)}(\mathbf{Q})$  the cellular fiber bundle on  $\partial[\Delta^m]$

induced from  $e(Q)$  by the embedding  $\partial[\Delta^m] \hookrightarrow [\Delta^m]$ :

$$\begin{array}{ccc} \Theta_{(-1)}(Q) & \hookrightarrow & T(Q) \\ \theta_{(-1)}(Q) \downarrow \text{dotted} & & \downarrow e(Q) \\ \partial[\Delta^m] & \hookrightarrow & [\Delta^m]. \end{array}$$

The balls of  $\Theta_{(-1)}$  are of the form  $T_{(\mathbf{k},B)} \in T(Q)$ ,  $\mathbf{k} \neq \mathbf{m}$ . Denote by  $\Theta_{(i)}(Q)$  the subcomplex of  $T(Q)$  that consists of the balls  $\Theta_{(-1)}(Q)$  together with all balls of the form  $T_{(\mathbf{m},B)}$ ,  $B \in Q_m$ ,  $\dim B \leq i$ . Recall that  $n = \dim X$ . We obtain the filtration

$$\begin{array}{ccccccc} \Theta_{(-1)}(Q) & \hookrightarrow & \Theta_{(0)}(Q) & \hookrightarrow & \dots & \hookrightarrow & \Theta_{(n)}(Q) = T(Q) \\ \theta_{(-1)}(Q) \downarrow & & \theta_{(0)}(Q) \downarrow & & \swarrow \text{dotted} & & \searrow \theta_{(n)}(Q) = e(Q) \\ \partial[\Delta^m] & \hookrightarrow & [\Delta^m] & & & & \end{array}$$

The restriction of  $e(Q)$  to  $\Theta_{(i)}(Q)$  will be denoted by  $\theta_{(i)}(Q)$ .

5. Now, using Step 3 of the proof, we can build  $f$  inductively. The maps  $f_0, \dots, f_m$  are pasted together to form a homeomorphism  $F^{(-1)}$  that coincides with  $f_i$  restricted to the bundle over the  $i$ th face of the sphere  $\partial[\Delta^m]$ :

$$\begin{array}{ccc} \Theta_{(-1)}Q^0 & \xrightarrow{F^{(-1)}} & \Theta_{(-1)}Q^1 \\ \theta_{(-1)}(Q^0) \searrow & & \swarrow \theta_{(-1)}e(Q^1) \\ & \partial[\Delta^m] & \end{array}$$

Then necessarily  $f_i|_0 = f_j|_0 = F^{(-1)}|_0$  for  $i, j = 1, \dots, m$  and  $Q_i^1 = F^{(-1)}|_0(Q_i^0)$ . The homeomorphism  $F^{(-1)}$  sends a ball  $T_{(B,\mathbf{k})}$  of the complex  $\Theta_{(-1)}Q^0$  to the ball  $T_{(F^{(-1)}|_0(B),\mathbf{k})}$  of the complex  $\Theta_{(-1)}Q^1$ .

*Inductive step.* Assume that we have a prismatic homeomorphism  $\Theta_{i-1}(Q^0) \xrightarrow{F^{(i-1)}} \Theta_{i-1}(Q^1)$  sending a ball  $T_{(B,\mathbf{k})}$  of the complex  $\Theta_{(i-1)}Q^0$  to the ball  $T_{(F^{(i-1)}|_0(B),\mathbf{k})}$  of the complex  $\Theta_{(i-1)}Q^1$ . Let us extend this homeomorphism to a fiberwise cellular

homeomorphism

$$\begin{array}{ccc}
 \Theta_i \mathbb{Q}^0 & \xrightarrow{F^i} & \Theta_i \mathbb{Q}^1 \\
 \searrow \theta_i(\mathbb{Q}^0) & & \swarrow \theta_i e(\mathbb{Q}^1) \\
 & & [\Delta^m].
 \end{array}$$

To achieve this aim, we must extend  $F^{(i-1)}$  to the balls of the form  $T_{(\mathbf{m}, B)}$  with  $\dim B = i$ . Such an extension exists, because  $\partial T_{(\mathbf{m}, B)} \subset \Theta_{(i-1)}(\mathbb{Q}^0)$  and  $F^{(i-1)}|_{\partial T_{(\mathbf{m}, B)}}$  satisfies the conditions of Alexander's trick in the form given in Step 3 of the proof.  $\square$

### 3.3. The simplicial sets $\mathcal{W}\text{Prism}(X)$ and $\overline{\mathcal{W}}\text{Prism}(X)$ .

3.3.1. We recall the so-called  $W$ -construction, i.e., the Eilenberg–MacLane construction of the principal simplicial bundle  $EG \xrightarrow{u_G} BG$  for a simplicial group  $G$ .

Put

$$(\overline{\mathcal{W}}G)_m = \begin{cases} G_{m-1} \times G_{m-2} \times \cdots \times G_0 & \text{for } m > 0, \\ \{*\} \text{ (one-element set)} & \text{for } m = 0. \end{cases}$$

For  $m > 0$ , denote an element of  $(\overline{\mathcal{W}}G)_m$  by  $[g_{m-1}, \dots, g_0]$ . We define the faces of one-dimensional simplices and the degeneracy of the 0-dimensional simplex as follows:

$$(13) \quad \begin{aligned} d_i([g_0]) &= * \quad \text{for } i = 0, 1, \\ s_0(*) &= [e_0] \quad (e_0 \text{ is the identity of the group } G_0). \end{aligned}$$

For  $m > 1$  the faces are defined as follows:

$$(14) \quad d_i[g_{m-1}, \dots, g_0] = \begin{cases} [g_{m-2}, \dots, g_0] & \text{for } i = 0, \\ [d_{i-1}g_{m-1}, \dots, d_1g_{m-i+1}, (g_{m-i-1} \circ_{m-i-1} d_0g_{m-i}), g_{m-i-2}, \dots, g_0] & \text{for } i = 1, \dots, m-1, \\ [d_{m-1}g_{m-1}, \dots, d_1g_1] & \text{for } i = m; \end{cases}$$

the degeneracies are defined by

$$s_i[g_{m-1}, \dots, g_0] = \begin{cases} [e_m, g_{m-1}, \dots, g_0] & \text{for } i = 0, \\ [s_{i-1}g_{m-1}, \dots, s_0g_{m-i}, e_{m-i}, g_{m-i-1}, \dots, g_0] & \text{for } i = 1, \dots, m, \end{cases}$$

where  $e_j$  is the identity of the group  $G_j$ .

Put  $(\mathcal{W}G)_m = G_m \times \cdots \times G_0$ . An element of  $(\mathcal{W}G)_m$  will be denoted by  $\langle g_m, \dots, g_0 \rangle$ . The faces are

$$d_i \langle g_m, \dots, g_0 \rangle = \begin{cases} \langle d_i g_m, \dots, d_1 g_{m-i+1}, (g_{m-i-1} \circ_{m-i-1} d_0 g_{m-i}), g_{m-i-2}, \dots, g_0 \rangle & \text{for } i = 0, \dots, m-1, \\ \langle d_m g_m, \dots, d_1 g_1 \rangle & \text{for } i = m. \end{cases}$$

The degeneracies are

$$s_i \langle g_m, \dots, g_0 \rangle = \langle s_i g_m, s_{i-1} g_{m-1}, \dots, s_0 g_{m-i}, e_{m-i}, g_{m-i-1}, \dots, g_0 \rangle.$$

On  $\mathcal{W}G$  we define a free action  $G \times \mathcal{W}G \rightarrow \mathcal{W}G$  of the group  $G$  by the rule  $(h_m, \langle g_m, \dots, g_0 \rangle) \mapsto \langle h_m g_m, g_{m-1}, \dots, g_0 \rangle$ . The principal fiber bundle

$$\mathcal{W}G \xrightarrow{u_G} \overline{\mathcal{W}G} : \langle g_m, \dots, g_0 \rangle \mapsto [g_{m-1}, \dots, g_0]$$

corresponding to this action is a universal principal  $G$ -bundle for  $G$ .

3.3.2. Let us develop a version of the  $\mathcal{W}$ -construction for the simplicial groupoid of prismatic homeomorphisms. Let  $g \in \text{Mor}_m \text{Prism}(X)$  be a prismatic homeomorphism. Denote by  $\text{dom}(g) \in \mathcal{N}_k \mathbf{R}(X)$  its image and by  $\text{codom}(g) \in \mathcal{N}_k \mathbf{R}(X)$  its preimage.

For  $m \geq 1$ , the set of  $m$ -simplices of  $\overline{\mathcal{W}Prism}(X)$  is the set of all pairs

$$(\mathbf{Q}, [g_{m-1}, \dots, g_0]),$$

where  $\mathbf{Q} \in \mathcal{N}_m \mathbf{R}(X)$  and  $[g_{m-1}, \dots, g_0]$  is a sequence of prismatic homeomorphisms such that  $g_i \in \text{Mor}_i \text{Prism}(X)$ ,  $i = 0, \dots, m-1$ ,  $d_0 \mathbf{Q} = \text{dom } g_{m-1}$ , and  $d_0 \text{codom } g_i = \text{dom } g_{i-1}$ . For  $m = 0$  the simplices are identified with the elements of  $\mathbf{R}(X)$ .

We define the faces of 1-simplices and the degeneracy of the 0-simplex in  $\overline{\mathcal{W}Prism}(X)$  by the formulas

$$(15) \quad \begin{aligned} d_0(\mathbf{Q}, [g_0]) &= \text{codom } g_0, \\ d_1(\mathbf{Q}, [g_0]) &= d_1 \mathbf{Q}, \\ s_0(\mathbf{Q}) &= (s_0 \mathbf{Q}, [e_0]) \quad (e_0 \text{ is the identity of the group } G_0). \end{aligned}$$

For  $m > 1$  the faces and degeneracies are defined as follows:

$$(16) \quad \begin{aligned} & d_i(\mathbf{Q}, [g_{m-1}, \dots, g_0]) \\ &= \begin{cases} (\text{codom } g_{m-1}, [g_{m-2}, \dots, g_0]) & \text{for } i = 0, \\ (d_i \mathbf{Q}, [d_{i-1} g_{m-1}, \dots, d_1 g_{m-i+1}, (g_{m-i-1} \circ_{m-i-1} d_0 g_{m-i}), g_{m-i-2}, \dots, g_0]) & \text{for } i = 1, \dots, m-1, \\ (d_m \mathbf{Q}, [d_{m-1} g_{m-1}, \dots, d_1 g_1]) & \text{for } i = m \end{cases} \end{aligned}$$

and

$$(17) \quad s_i(\mathbf{Q}, [g_{m-1}, \dots, g_0]) \\ = \begin{cases} (s_0\mathbf{Q}, [e_m, g_{m-1}, \dots, g_0]) & \text{for } i = 0, \\ (s_i\mathbf{Q}, [s_{i-1}g_{m-1}, \dots, s_0g_{m-i}, e_{m-i}, g_{m-i-1}, \dots, g_0]) & \text{for } i = 1, \dots, m, \end{cases}$$

where  $e_j$  is the identity of the group  $G_j$ .

Now we define a simplicial set  $\mathcal{W}\text{Prism}(X)$ .

The elements of  $(\mathcal{W}\text{Prism}(X))_m$  are all pairs  $(\mathbf{Q}, \langle g_m, \dots, g_0 \rangle)$ , where  $\mathbf{Q} \in \mathcal{N}_m\mathbf{R}(X)$ ,  $\text{codom } g_m = \mathbf{Q}$ ,  $d_0\mathbf{Q} = \text{dom } g_{m-1}$ ,  $d_0 \text{ codom } g_i = \text{dom } g_{i-1}$  for  $i = 1, \dots, m-1$ .

The faces are

$$d_i(\mathbf{Q}, \langle g_m, \dots, g_0 \rangle) \\ = \begin{cases} (\text{codom } g_{m-1}, \langle g_{m-1}d_0g_m, g_{m-2}, \dots, g_0 \rangle) & \text{for } i = 0, \\ (d_i\mathbf{Q}, \langle d_i g_m, \dots, d_1 g_{m-i+1}, (g_{m-i-1} \circ_{m-i-1} d_0 g_{m-i}), g_{m-i-2}, \dots, g_0 \rangle) & \text{for } i = 0, \dots, m-1, \\ (d_m\mathbf{Q}, \langle d_m g_m, \dots, d_1 g_1 \rangle) & \text{for } i = m. \end{cases}$$

The degeneracies are

$$s_i(\mathbf{Q}, \langle g_m, \dots, g_0 \rangle) = (s_i\mathbf{Q}, \langle s_i g_m, s_{i-1}g_{m-1}, \dots, s_0g_{m-i}, e_{m-i}, g_{m-i-1}, \dots, g_0 \rangle).$$

Define a morphism of simplicial sets

$$\mathcal{W}\text{Prism}(X) \xrightarrow{u_{\text{Prism}(X)}} \overline{\mathcal{W}\text{Prism}(X)}$$

by the formula  $(\mathbf{Q}, \langle g_m, \dots, g_0 \rangle) \mapsto (\mathbf{Q}, [g_{m-1}, \dots, g_0])$ .

The following simple fact is important for us.

**Proposition 6.** *We have the following commutative square of maps of simplicial sets:*

$$\begin{array}{ccc} \mathcal{W}\text{Prism}(X) & \xrightarrow{\Pi'} & \mathcal{W}\text{PL}(X) \\ \downarrow u_{\text{Prism}(X)} & & \downarrow u_{\text{PL}(X)} \\ \overline{\mathcal{W}\text{Prism}(X)} & \xrightarrow{\Pi} & \overline{\mathcal{W}\text{PL}(X)}, \end{array}$$

where the horizontal arrows forget the combinatorics of objects of the groupoid:

$$\begin{aligned} (\mathbf{Q}, \langle g_m, \dots, g_0 \rangle) &\xrightarrow{\Pi'} \langle g_m, \dots, g_0 \rangle, \\ (\mathbf{Q}, [g_{m-1}, \dots, g_0]) &\xrightarrow{\Pi} [g_{m-1}, \dots, g_0]. \end{aligned}$$

Formulas ( 13 on page 27) and ( 14 on page 27), which define the  $\mathcal{W}$ -construction, express the faces of  $\overline{\mathcal{W}G}$  via the faces of  $G$  and the degeneracies of  $\overline{\mathcal{W}G}$  via the degeneracies of  $G$ . We need to mention the existence of the inverse expressions. Let  $w = (\mathbf{Q}(w), [g_{m-1}(w), \dots, g_0(w)])$  be an  $m$ -simplex of  $\mathcal{W}\text{Prism}(X)$ . We can deduce the following expressions.

**Proposition 7.**

$$\begin{aligned} g_i(w) &= g_i(d_0w) && \text{for } i = 1, \dots, m-2, \\ d_j g_{m-1}(w) &= g_{m-2}(d_j w) && \text{for } j = 1, \dots, m-1, \\ d_0 g_{m-1}(w) &= (g_{m-2}(d_0 w))^{-1} \circ g_{m-2}(d_1 w), \end{aligned}$$

where  $d_*$  on the left is a face in  $G$  and  $d_*$  on the right is a face in  $\overline{\mathcal{W}Prism}(X)$ .

**3.4. The embedding  $\mathcal{N}\tilde{\mathfrak{A}}(X) \xrightarrow{\Psi} \overline{\mathcal{W}Prism}(X)$  and the projection  $\overline{\mathcal{W}Prism}(X) \xrightarrow{\Psi^*} \mathcal{N}\tilde{\mathfrak{A}}(X)$ .** We will build an embedding  $\mathcal{N}\tilde{\mathfrak{A}}(X) \xrightarrow{\Psi} \overline{\mathcal{W}Prism}(X)$  by induction on the skeletons of the simplicial set  $\mathcal{N}\tilde{\mathfrak{A}}(X)$ , using a sequential choice of prismatic homeomorphisms. The skeletons of simplicial sets are discussed in detail, for example, in [11, Chap. V. 1]. The skeleton  $\text{sk}_m X \subset X$  is the simplicial subset generated by all nondegenerate simplices of dimension at most  $m$ .

3.4.1. First, for each  $m$ -simplex

$$\Omega = (\mathbf{Q}_0 \xrightarrow{\mu_1} \dots \xrightarrow{\mu_m} \mathbf{Q}_m) \in (\mathcal{N}\tilde{\mathfrak{A}}(X))_m$$

we prepare its linearization

$$\mathbf{L}\Omega = (\mathbf{L}_0\Omega \trianglelefteq \dots \trianglelefteq \mathbf{L}_m\Omega) \in (\mathcal{N}\mathfrak{R}(X))_m.$$

By the definition of an abstract assembly (Sec. 2.8 on page 17), any abstract assembly  $\mathbf{Q}_{i-1} \xrightarrow{\mu_i} \mathbf{Q}_i$  of the chain  $\Omega$  is representable by some  $\mathfrak{R}(X)$ -morphism  $\mathbf{Q}_{i-1} \xrightarrow{f_i} \mathbf{Q}_i$ . Let us fix these representatives for all  $i$ . We obtain a chain

$$Q = (\mathbf{Q}_0 \xrightarrow{f_1} \dots \xrightarrow{f_m} \mathbf{Q}_m) \in (\mathcal{N}\mathfrak{R}(X))_m$$

such that  $\mathcal{A}(Q) = \Omega$ . Applying the decomposition (6 on page 17), we obtain the following commutative diagram in  $\mathcal{R}(X)$ :

$$(18) \quad \begin{array}{ccccccc} \Omega_0 = L_0\Omega & \xrightarrow{\triangleleft} & L_1\Omega & \xrightarrow{\triangleleft} & L_2\Omega & \xrightarrow{\triangleleft} & \cdots \xrightarrow{\triangleleft} & L_m\Omega \\ & \searrow f_1 & \downarrow & & \downarrow & & & \downarrow \\ & & Q_1 = L_0d_0\Omega & \xrightarrow{\triangleleft} & L_1d_0\Omega & \xrightarrow{\triangleleft} & \cdots \xrightarrow{\triangleleft} & L_{m-1}d_0\Omega \\ & & & \searrow f_2 & \downarrow & & & \downarrow \\ & & & & Q_2 = L_0d_0^2\Omega & \xrightarrow{\triangleleft} & \cdots \xrightarrow{\triangleleft} & L_{m-2}d_0^2\Omega \\ & & & & & \searrow f_2 & & \downarrow \\ & & & & & & \cdots & \vdots \\ & & & & & & & \downarrow \\ & & & & & & & Q_m = L_0d_0^m\Omega, \end{array}$$

where the rows are chains of geometric assemblies starting from  $Q_0, \dots, Q_m$ . The vertical morphisms are cellular homeomorphisms. The rows are independent from the choice of morphisms  $f_i$  representing  $\mu_i$ , they depend only on  $Q_i$ . The upper row is the chain  $L\Omega$  canonically associated to  $\Omega$ . Note that if  $i > 0$ , then  $Ld_i\Omega = d_iL\Omega$ .

3.4.2. Pick  $\Omega \in (\mathcal{N}\tilde{\mathfrak{A}}(X))_m$ . We will look for  $\Psi(\Omega) \in (\mathcal{W}\text{Prism}(X))$  in the form  $(L\Omega, [g_{m-1}(\Omega), \dots, g_0(\Omega)])$ , where the homeomorphisms  $g_i(\Omega)$  are constructed by induction on the skeletons  $\text{sk}_m\mathcal{N}\tilde{\mathfrak{A}}(X) \xrightarrow{\Psi_m} \text{sk}_m\text{Prism}(X)$ . A nondegenerate simplex in  $\mathcal{N}\tilde{\mathfrak{A}}(X)$  is a chain of abstract assemblies that has no identity assemblies. The simplices of  $\text{sk}_m\mathcal{N}\tilde{\mathfrak{A}}(X)$  are all chains of abstract assemblies that have at most  $m$  nonidentities. Thus  $\text{sk}_0\mathcal{N}\tilde{\mathfrak{A}}(X)$  is the simplicial set whose typical  $k$ -simplex is a chain

$$\underbrace{Q \overset{\text{id}}{\rightsquigarrow} Q \overset{\text{id}}{\rightsquigarrow} \cdots \overset{\text{id}}{\rightsquigarrow} Q}_k$$

consisting of  $k$  identical abstract assemblies of a ball complex  $Q \in \mathcal{R}(X)$ . To this simplex we assign the degenerate simplex

$$(Q, [e_{m-1}, \dots, e_0]) \in \overline{\mathcal{W}\text{Prism}(X)}.$$

Assume that  $\Psi_{m-1}$  is already constructed. Let us construct a map  $\Psi_m$  extending  $\Psi_{m-1}$ . Let  $\Omega \in (\text{sk}_m\mathcal{N}\tilde{\mathfrak{A}}(X))_m$  be a nondegenerate simplex. Then  $d_i\Omega \in \text{sk}_{m-1}\mathcal{N}\tilde{\mathfrak{A}}(X)$  and  $\Psi d_i\Omega$  are already constructed. We search for  $\Psi(\Omega)$  in the form  $(L\Omega, [g_{m-1}(\Omega), \dots, g_0(\Omega)])$ . The equalities  $g_i(\Omega) = g_i(d_0\Omega)$ ,  $i = m-2, \dots, 0$  are

already satisfied. Therefore  $g_i$  are already constructed for  $i = 0, \dots, m - 2$ . We must define  $g_{m-1}(\mathfrak{Q})$ . According to Proposition 7 on page 30, the maps  $d_i g_{m-1}(\mathfrak{Q})$ ,  $i = 1, \dots, m - 1$ , are already constructed and satisfy the requirements of Proposition 3 on page 23. Therefore there exists a prismatic homeomorphism  $g_{m-1}(\mathfrak{Q})$  that is an extension of  $d_i g_{m-1}(\mathfrak{Q})$ ,  $i = 1, \dots, m - 1$ . For the degenerate simplex  $\mathfrak{Q}$ , we can construct  $(\mathbf{L}\mathfrak{Q}, [g_{m-1}(\mathfrak{Q}), \dots, g_0(\mathfrak{Q})])$  according to formulas (17 on page 29) with the help of the unique reduction to a nondegenerate simplex:  $\mathfrak{Q} = s_{i_1} s_{i_2} \dots \mathfrak{Q}'$ , where  $\mathfrak{Q}'$  is a nondegenerate simplex of dimension at most  $m$ .

3.4.3. Let us build a projection  $\overline{\mathcal{W}}\text{Prism}(X) \xrightarrow{\Psi^*} \mathcal{N}\widetilde{\mathfrak{R}}(X)$ . For a fiberwise homeomorphism  $f \in \text{PL}_m(X)$ , we denote by  $f|_i$  its fiber over the  $i$ th vertex of the base. To a simplex  $w = (\mathbf{Q}, [g_{m-1}, \dots, g_0]) \in (\overline{\mathcal{W}}\text{Prism}(X))_m$  we associate the sequence of maps  $\widehat{g}_i(w) = g_i|_{i \in \text{PL}_0(X)}$ ,  $i = 0, \dots, m - 1$ . Consider the sequence of ball complexes

$$\mathbf{Q}_0 = \widehat{\mathbf{Q}}_0(w), \quad \widehat{\mathbf{Q}}_i(w) = \widehat{g}_{m-i} \circ \widehat{g}_{m-i+1} \circ \dots \circ \widehat{g}_{m-1}(w)(\mathbf{Q}_i), \quad i = 1, \dots, m.$$

Due to the prismaticity of the homeomorphisms  $g_i$ , we obtain a chain  $\widehat{\Psi}^*(w) \in (\mathcal{N}\mathbf{R}(X))_m$ :

$$\widehat{\Psi}^*(w) = \widehat{\mathbf{Q}}_0(w) \xrightarrow{\widehat{g}_{m-1}(w)} \widehat{\mathbf{Q}}_1(w) \xrightarrow{\widehat{g}_{m-2}(w)} \dots \xrightarrow{\widehat{g}_0(w)} \widehat{\mathbf{Q}}_m(w).$$

Set the value  $\Psi^*(w) \in (\mathcal{N}\widetilde{\mathfrak{R}}(X))_m$  to be the image of the chain  $\widehat{\Psi}^*(w)$  under the functor  $\mathcal{A} : \mathcal{R}(X) \rightarrow \widetilde{\mathfrak{R}}(X)$ . One can verify that the definition is correct,  $\Psi^*(w)$  is a map of simplicial sets,  $\Psi^*\Psi = \text{id}$ , and the following proposition holds.

**Proposition 8.** *The map  $\Psi\Psi^*$  is simplicially homotopic to the identity.*

*Proof.* A simplicial homotopy is constructed by induction on the skeletons using Lemma 3 on page 23.  $\square$

3.5. **The maps  $\Phi, \Phi^*$ .** We define an embedding  $\mathcal{N}\mathbf{R}(X) \xrightarrow{\Phi} \mathcal{W}\text{Prism}(X)$  by a correspondence on simplices: to an  $m$ -chain  $\mathbf{Q} = (\mathbf{Q}_0 \trianglelefteq \dots \trianglelefteq \mathbf{Q}_m)$  we associate the  $m$ -simplex  $\Phi(\mathbf{Q}) = (\mathbf{Q}, [e_m, \dots, e_0])$ . We define a map  $\mathcal{W}\text{Prism}(X) \xrightarrow{\Phi^*} \mathcal{N}\mathbf{R}(X)$  by a correspondence on simplices: to an  $m$ -simplex  $w = (\mathbf{Q}, [g_m, \dots, g_0])$  we associate the  $m$ -chain  $\Phi^*(w) = g_m^{-1}\mathbf{Q} = (g_m^{-1}|_0\mathbf{Q}_0 \trianglelefteq \dots \trianglelefteq g_m^{-1}|_m\mathbf{Q}_m)$ .

**Proposition 9.** *The composition  $\Phi^*\Phi$  is the identity, the map  $\Phi\Phi^*$  is simplicially homotopic to the identity.*

*Proof.* The first assertion follows from the construction, the second one can be proved by induction on the skeletons using Lemma 3 on page 23.  $\square$



As a result of the constructions of this section, we obtain the following commutative diagram:

$$\begin{array}{ccc} \mathcal{NR}(X) & \xrightarrow{\Phi} & \mathcal{WPrism}(X) \\ \mathcal{NA} \downarrow & & \downarrow u_{\mathcal{Prism}(X)} \\ \mathcal{N}\tilde{\mathfrak{R}}(X) & \xrightarrow{\Psi} & \overline{\mathcal{WPrism}}(X), \end{array}$$

where  $\Phi, \Psi$  are simplicial homotopy equivalences.

### 3.6. Reduction of Theorem A to the lemma on prismatic trivialization.

According to Proposition 6 on page 29, we have the commutative square

$$\begin{array}{ccc} \mathcal{WPrism}(X) & \xrightarrow{\Pi'} & \mathcal{WPL}(X) \\ u_{\mathcal{Prism}(X)} \downarrow & & \downarrow u_{\mathcal{PL}(X)} \\ \overline{\mathcal{WPrism}}(X) & \xrightarrow{\Pi} & \overline{\mathcal{WPL}}(X). \end{array}$$

Consider the principal PL bundle

$$\widetilde{\mathcal{WPrism}}(X) \rightarrow \overline{\mathcal{WPrism}}(X)$$

induced by the map  $\Pi$ . We obtain the commutative diagram

$$(19) \quad \begin{array}{ccccccc} \mathcal{NR}(X) & \xrightarrow{\Phi} & \mathcal{WPrism}(X) & \xrightarrow{i} & \widetilde{\mathcal{WPrism}}(X) & \xrightarrow{\tilde{\Pi}} & \mathcal{WPL}(X) \\ \swarrow \mathcal{NP} & & \downarrow \mathcal{NA} & & \downarrow & & \downarrow \\ \mathcal{N}\tilde{\mathfrak{R}} & \xleftarrow{\mathcal{NF}} & \mathcal{N}\tilde{\mathfrak{R}}(X) & \xrightarrow{\Psi} & \overline{\mathcal{WPrism}}(X) & \xrightarrow{\Pi} & \overline{\mathcal{WPL}}(X), \end{array}$$

where  $\tilde{\Pi}$  is the pullback of  $\Pi$ ,  $\Pi' = \tilde{\Pi} \circ i$ , and the left triangle is the nerve of the triangle (7 on page 18).

**Lemma 4 (On prismatic trivialization).** *The embedding*

$$|\mathcal{WPrism}(X)| \xrightarrow{|i|} |\widetilde{\mathcal{WPrism}}(X)|$$

*is a homotopy equivalence.*

In Sec. 4 Lemma 4 will be deduced from Lemma 5. And all that follows will be mainly devoted to the proof of Lemma 5.

**3.7. Proof of Theorem A.** The homotopy equivalence  $B\mathfrak{R}(X) \approx BPL(X)$  will be a geometric realization of the bottom chain of simplicial maps in the diagram (19). By definition,  $B\mathfrak{R}(X) \approx |\mathcal{N}\mathfrak{R}(X)|$  at the left end of the chain; by the Eilenberg–MacLane theorem,  $BPL(X) \approx |\widetilde{W}PL(X)|$  at the right end of the chain. We must check that all intermediate elements of the chain are homotopy equivalences.

1. The following assertion is a standard fact of the theory of simplicial principal bundles.

Let  $X \xrightarrow{f} BG$  be a simplicial map, and assume that  $EG_f \xrightarrow{u_{Gf}} X$  is the induced principal bundle, i.e., the following square is Cartesian:

$$\begin{array}{ccc} EG_f & \xrightarrow{\tilde{f}} & EG \\ u_{Gf} \downarrow & & \downarrow u_G \\ X & \xrightarrow{f} & BG. \end{array}$$

In this situation, if the space  $|EG_f|$  is contractible, then in the square

$$\begin{array}{ccc} |EG_f| & \xrightarrow{|\tilde{f}|} & |EG| \\ |u_{Gf}| \downarrow & & \downarrow |u_G| \\ |X| & \xrightarrow{|f|} & |BG| \end{array}$$

the maps  $|f|, |\tilde{f}|$  are homotopy equivalences.

This fact follows from the equivariance of  $\tilde{f}$ , the possibility to extend the square to a morphism of the exact homotopy sequences of fibrations, the Whitehead theorem, and the 5-lemma.

2. By Proposition 9 on page 32, the map  $\Phi$  is a homotopy equivalence. Therefore, by Lemma 2 on page 19, the space  $|\mathcal{W}Prism(X)|$  is contractible. By Lemma 4, the space  $|\widetilde{W}Prism(X)|$  is contractible. Thus we find ourselves in the situation of Step 1 of the proof. Therefore  $|\Pi|$  is a homotopy equivalence. By Proposition 8 on page 32, the map  $|\Psi|$  is a homotopy equivalence; and  $|\mathcal{N}\mathbf{F}|$  is a homotopy equivalence because  $\mathbf{F}$  is an equivalence of categories by definition. This completes the proof of Theorem A.  $\square$

4. REDUCTION OF THE LEMMA ON PRISMATIC TRIVIALIZATION TO THE LEMMA ON A COMMON  $\mathbf{R}(X)$ -TRIANGULATION OF FIBERWISE HOMEOMORPHISMS

In this section, we will deduce Lemma 4 “on prismatic trivialization” from Lemma 5 “on a common  $\mathbf{R}(X)$ -triangulation of fiberwise homeomorphisms,” which we will formulate now.

Let  $N \geq 0$ . We define a simplicial set  $\underline{\text{Prism}}^N(X)$ . For  $N \geq 1$ , the  $k$ -simplices of  $\underline{\text{Prism}}^N(X)$  are the data sets  $\langle \mathbf{Q}, \{g_i\}_{i=1}^N \rangle$ , where  $\mathbf{Q} \in \mathcal{N}_k \mathbf{R}(X)$  and for every  $i = 1, \dots, N$

$$g_i \in \text{Mor}_k \text{Prism}(X), \quad \text{codom} g_i = \mathbf{Q}.$$

For  $N = 0$ , we assume that  $\underline{\text{Prism}}^0(X)$  coincides with  $\mathcal{N} \mathbf{R}(X)$ . For  $N \geq 1$ , by forgetting the prismaticity of  $g_N$ , we obtain an embedding  $\underline{\text{Prism}}^N(X) \xrightarrow{j} \underline{\text{Prism}}^{N-1}(X) \times \text{PL}(X)$ .

**Lemma 5** (On a common  $\mathbf{R}(X)$ -triangulation of fiberwise homeomorphisms). *The embedding  $|\underline{\text{Prism}}^N(X)| \xrightarrow{|j|} |\underline{\text{Prism}}^{N-1}(X) \times \text{PL}(X)|$  is a homotopy equivalence.*

We will prove Lemma 5 in the subsequent sections. In this section, after some preparations, we will prove the implication Lemma 5  $\Rightarrow$  Lemma 4 (in Sec. 4.4 on page 39).

**4.1. Injective simplicial sets (or “ $\Delta$ -sets”).** Let  $\mathbf{iN}$  be the subcategory of the category  $\mathbf{N}$  of finite ordinals that has the same objects but only injective monotone maps as morphisms. The morphisms of  $\mathbf{iN}$  are generated by the cofaces. An *injective simplicial set* is a functor  $\mathbf{iN}^{\text{op}} \rightarrow \mathbf{Sets}$ . (This is the same as a “ $\Delta$ -set” of Rourke and Sanderson [30]; we just wish to avoid another use of the overloaded symbol  $\Delta$ .) The embedding  $\mathbf{iN} \xrightarrow{i} \mathbf{N}$  generates a forgetful functor

$$\mathbf{Sets}^{\mathbf{N}^{\text{op}}} \xrightarrow{d} \mathbf{Sets}^{\mathbf{iN}^{\text{op}}},$$

which assigns to a simplicial set its injective part.

A simplicial complex  $K$  is *locally ordered* if there is a partial order on the vertices of  $K$  such that the vertices of every simplex of  $K$  are totally ordered. Denote by  $i(K)$  the natural structure of an injective simplicial set on the simplices of  $K$ .

**4.2. Colorings of polyhedra by simplicial sets and Brown’s theorem on representable functors.** A triangulation  $|K| \xrightarrow{t} N$  of a polyhedron  $N$  is *locally ordered* if the complex  $K$  is locally ordered. Let  $Y$  be a simplicial set and  $N$  be a polyhedron. A *coloring of  $N$  by  $Y$*  (or an  *$Y$ -coloring of  $N$* ) is a pair  $\langle t, f \rangle$ , where  $K \xrightarrow{t} N$  is a locally ordered triangulation and  $i(K) \xrightarrow{f} \mathbf{d}(Y)$  is a morphism of

injective simplicial sets. Two  $Y$ -colorings  $\langle t_0, f_0 \rangle$  and  $\langle t_1, f_1 \rangle$  of a polyhedron  $N$  are **concordant** if there is an  $Y$ -coloring of  $N \times [0, 1]$  that coincides with  $\langle t_j, f_j \rangle$  on the face  $N \times \{j\}$ . Let

$$\mathbf{PL}^{\text{op}} \xrightarrow{\mathbf{Co}Y} \mathbf{Sets}$$

be the functor that associates to a polyhedron  $N$  the set of all concordance classes of  $Y$ -colorings of  $N$ . Let  $\mathbf{PL}^{\text{op}} \xrightarrow{\mathbf{Ho}(-, |Y|)} \mathbf{Sets}$  be the functor that associates to a polyhedron  $N$  the set  $\mathbf{Ho}(N, |Y|)$  of all homotopy classes of maps from  $N$  to  $|Y|$ .

The relative Zeeman theorem on simplicial approximation [35] guarantees that there is a natural isomorphism of functors  $\mathbf{Co}Y \approx \mathbf{Ho}(-, |Y|)$ . If  $|Y|$  is connected and has countable homotopy groups, then Brown’s theorem [8, p. 469] on representability of homotopy functors on polyhedra guarantees that  $Y$  is determined by  $\mathbf{Ho}(-, |Y|)$  (and hence also by  $\mathbf{Co}Y$ ) in a homotopy unique way.

Colorings of polyhedra by simplicial sets is a natural tool for proving the homotopy triviality of pairs for non-Kan simplicial sets, since simplicial homotopy works poorly in this case.

**4.3. The “ $\frown$ -lemma” and “ $\sqcap$ -lemma”.** Let  $(X, Y)$  be a pair of simplicial sets, i.e.,  $Y \subseteq X$ . We always suppose that  $X$  is connected. Consider the embedding  $|Y| \xrightarrow{f} |X|$ . We need to fix two different ways to say that  $f$  is a homotopy equivalence in terms of  $(X, Y)$ -colorings of pairs of polyhedra. The difference between these two ways will be pure combinatorial. The corresponding assertions will be called the “ $\frown$ -lemma” and the “ $\sqcap$ -lemma.”

Colorings of a polyhedron by a simplicial set were discussed in Sec.4.2 4.2. A **coloring of a pair of polyhedra  $(P, Q)$  by a pair of simplicial sets  $(X, Y)$**  is a locally ordered triangulation  $p$  of  $P$  inducing a triangulation  $q$  of  $Q$  together with an  $X$ -coloring of  $p$  inducing an  $Y$ -coloring of  $q$ .

4.3.1. Let  $D^{k+1}$  be a  $(k + 1)$ -ball and  $S^k = \partial D^{k+1}$  be its boundary sphere. Let  $S_e^{k-1} \subset S^k$  be an equator specified in  $S^k$ , and let  $D_+^k, D_-^k \subset S^k$ ,  $D_+^k \cap D_-^k = S_e^{k-1}$ , be the two closed hemispheres determined by this equator. Consider the embedding of

pairs  $(D_+^k, S_e^{k-1}) \hookrightarrow (D^{k+1}, D_-^k)$ , which is illustrated in the following figure:

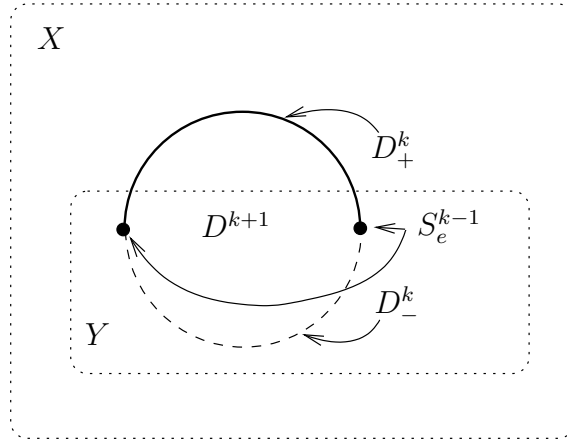

By the  $\frown$ -**lemma for**  $(X, Y)$  we mean the following assertion.

$\frown$ -*Lemma.* For any  $k$  any  $(X, Y)$ -coloring of the pair  $(D_+^k, S_e^{k-1})$  can be extended to an  $(X, Y)$ -coloring of the pair  $(D^{k+1}, D_-^k)$ .

**Proposition 10.** *The embedding  $|Y| \hookrightarrow |X|$  is a homotopy equivalence if and only if the  $\frown$ -lemma is valid for  $(X, Y)$ .*

*Proof.* By the Whitehead theorem, a necessary and sufficient condition for the homotopy equivalence is the triviality of the relative homotopy classes of the spheres. By the Zeeman theorem on relative simplicial approximation, the triviality of the relative homotopy classes of the spheres has the form of the  $\frown$ -lemma.  $\square$

4.3.2. Let  $A \xrightarrow{f} B$  be a map of  $\mathbf{iN}$ -sets. The map  $f$  is a **Kan fibration-equivalence** if the following sequence of axioms is satisfied:

KF-E(0): the map  $f_0 : A_0 \rightarrow B_0$  is an epimorphism;

.....  
 KF-E(k): for any  $b \in (b)_k, a_0, \dots, a_k \in A_{k-1}$  such that  $f(a_i) = d_i b$  and  $d_i(a_j) = d_{j-1} a_i$  for  $i < j$ , there exists  $a \in A_k$  such that  $d_i a = a_i$  and  $f(a) = b$ .  
 .....

Let  $(A^0, A^1)$  and  $(B^0, B^1)$  be pairs of  $\mathbf{iN}$ -sets. A pair of maps

$$(A^0, A^1) \xrightarrow{f^0, f^1} (B^0, B^1)$$

is a Kan fibration-equivalence of pairs if both maps  $f^0$  and  $f^1$  are Kan fibration-equivalences.

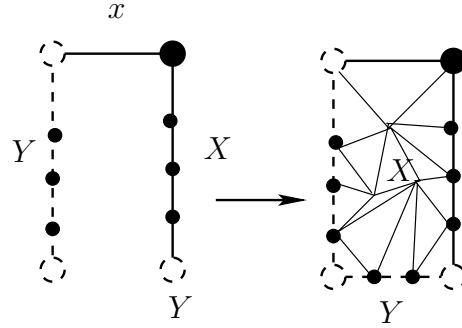

FIGURE 10.

4.3.3. Consider the following injective simplicial sets:

- the  $\mathbf{iN}$ -set  $\overline{X}$  whose  $k$ -simplices are locally ordered,  $X$ -colored triangulations of  $\Delta^k$  that subdivide the ball complex  $[\Delta^k]$ ,
- the  $\mathbf{iN}$ -set  $\overline{X}_{\times[0,1]}$  whose  $k$ -simplices are locally ordered,  $X$ -colored triangulations of  $\Delta^k \times \Delta^1$  that subdivide the ball complex  $[\Delta^k] \times [\Delta^1]$ .

There are two maps

$$\overline{X}_{\times[0,1]} \xrightarrow{h_0, h_1} \overline{X},$$

corresponding to the two maps

$$\Delta^k \xrightarrow{\text{id} \times d^0, \text{id} \times d^1} \Delta^k \times \Delta^1.$$

There is a tautological embedding of pairs  $(\mathbf{d}X, \mathbf{d}Y) \subset (\overline{X}, \overline{Y})$ . Here a  $k$ -simplex of  $X$  is regarded as  $\Delta^k$  colored by  $x$ . Consider the pair of  $\mathbf{iN}$ -subsets  $(\tilde{X}_{\times[0,1]}, \tilde{Y}_{\times[0,1]}) \subset (\overline{X}_{\times[0,1]}, \overline{Y}_{\times[0,1]})$  defined as follows:  $\tilde{x} \in (\tilde{X}_{\times[0,1]})_k$  if and only if

- (i)  $h_0(\tilde{x}) \in \mathbf{d}X_k$ ,
- (ii)  $h_0(\tilde{x}) \in \mathbf{d}Y_k \Rightarrow \tilde{x} \in (\tilde{Y}_{\times[0,1]})_k$ ,
- (iii)  $h_1\tilde{x} \in \overline{Y}_k$ .

The  $\Pi$ -*lemma for*  $(X, Y)$  is the following assertion.

$\Pi$ -*Lemma.* The projection

$$(\tilde{X}_{\times[0,1]}, \tilde{Y}_{\times[0,1]}) \xrightarrow{h_0, h_1} (\mathbf{d}X, \mathbf{d}Y)$$

is a Kan fibration-equivalence.

4.3.4. Geometrically, one can imagine the assertion of the  $\sqcap$ -lemma for  $(X, Y)$  as follows. Consider the simplicial bucket  $\Delta^k \cup \partial\Delta^k \times [0, 1]$  (see Fig. 10, on the left) with a locally ordered triangulation  $K$  subdividing the ball complex  $[\Delta^k] \cup \partial[\Delta^k] \times [0, 1]$ . On the bottom of the bucket, the triangulation  $K$  coincides with the standard ordered triangulation  $[\Delta^k]$ . The triangulation  $K$  is colored by  $X$  in such a way that the rim  $K|_{\Delta^k \times \{1\}}$  of the bucket is colored by  $Y$ . If the face  $d_i K|_{\Delta^k}$  is colored by  $Y$ , then the whole wall  $K|_{d_i \Delta^k \times [0, 1]}$  is also colored by  $Y$ . The  $\sqcap$ -lemma states that every such  $(X, Y)$ -coloring of the bucket can be extended to an  $(X, Y)$ -coloring of the pair  $(\Delta^k \times [0, 1], \Delta^k \times \{1\})$ .

**Proposition 11.** *The embedding  $|X| \hookrightarrow |Y|$  is a homotopy equivalence if and only if the  $\sqcap$ -lemma is valid for the pair  $(X, Y)$ .*

*Proof.* The  $\sqcap$ -lemma follows from the  $\frown$ -lemma, because, in terms of the interpretation of Sec. 4.3.4, the  $\frown$ -lemma allows us to fill the bucket in a required way.

Conversely, the  $\frown$ -lemma follows from the  $\sqcap$ -lemma. By induction on the skeletons of a triangulation  $(K, L)$  of  $(D^{k+1}, S^k)$ , we construct and fill  $(X, Y)$ -colored buckets.  $\square$

4.4. **Derivation of Lemma 4 from Lemma 5.** By Propositions 10 and 11, in order to derive 4 from 5, it suffices to prove the following assertion.

**Proposition 12.** *The  $\frown$ -lemma for the pair  $(\widetilde{\mathcal{W}}\text{Prism}(X), \mathcal{W}\text{Prism}(X))$  follows from the  $\sqcap$ -lemma for all pairs*

$$(\underline{\text{Prism}}^{N-1}(X) \times \text{PL}(X), \underline{\text{Prism}}^N(X))$$

for all finite  $N \geq 1$ .

*Proof.* Assume that we have a pair  $(D^{k+1}, S^k)$  endowed with a pair of triangulations  $(K, L)$  colored by

$$(\widetilde{\mathcal{W}}\text{Prism}(X), \mathcal{W}\text{Prism}(X)),$$

i.e., a fixed morphism

$$(\mathbf{i}K, \mathbf{i}L) \xrightarrow{(\alpha, \beta)} (\mathbf{d}\widetilde{\mathcal{W}}\text{Prism}(X), \mathbf{d}\mathcal{W}\text{Prism}(X)).$$

Consider the pair of polyhedra

$$(D^k \times [0, 1], S^{k-1} \times [0, 1] \cup D^k \times \{1\})$$

and the pair of ball complexes on these polyhedra

$$(K \times [0, 1], L \times [0, 1] \cup K \times \{1\}).$$

We will search for an extension of  $(K, L)$  to a locally ordered triangulation

$$(K', L') \trianglelefteq (K \times [0, 1], L \times [0, 1] \cup K \times \{1\}),$$

and an extension of  $(\alpha, \beta)$  to a coloring

$$(\mathbf{i}K', \mathbf{i}L') \xrightarrow{(\alpha', \beta')} (\mathbf{d}\widetilde{\mathcal{W}}\text{Prism}(X), \mathbf{d}\mathcal{W}\text{Prism}(X)).$$

In order to find an extension of the coloring, we use induction on the filtration

$$(\Xi_l, \Upsilon_l) = (K \cup (K_{l-1} \times [0, 1]), L \cup (L_{l-1} \times [0, 1]) \cup (K_{l-1} \times \{1\})),$$

$$(\Xi_0, \Upsilon_0) = (K, L) \hookrightarrow \dots \hookrightarrow (\Xi_k, \Upsilon_k) = (K \times [0, 1], L \times [0, 1] \cup K \times \{1\}).$$

Let  $(\widetilde{\mathcal{W}}\text{Prism}(X), \mathcal{W}\text{Prism}(X))$  be a coloring of  $(\Xi_l, \Upsilon_l)$  extending  $(\alpha, \beta)$ . Then the condition for the existence of its extension onto  $(\Xi_{l+1}, \Upsilon_{l+1})$  is equivalent to the  $\square$ -lemma for

$$(\underline{\text{Prism}}^{k-l}(X) \times \text{PL}(X), \underline{\text{Prism}}^{k-l+1}(X)).$$

□

## 5. A PLAN OF THE PROOF OF THE LEMMA ON A COMMON $\mathbf{R}(X)$ -TRIANGULATION OF FIBERWISE HOMEOMORPHISMS

Our project of proving Lemma 5 is to prove the  $\curvearrowright$ -lemma (see Sec. 4.3.1) for the pair  $(|\underline{\text{Prism}}^{m-1}(X) \times \text{PL}(X)|, |\underline{\text{Prism}}^m(X)|)$ . This means that we wish to prove the following. Let  $K$  be a triangulation of the disk  $D_+^k$ . Let  $\mathcal{Q}$  be a coloring of  $K$  by the poset  $\mathbf{R}(X)$ . Let  $G_1, \dots, G_m, U \in \text{PL}_{D_+^k}$  be a family of fiberwise homeomorphisms such that  $G_1, \dots, G_m$  are  $\mathcal{Q}$ -prismatic and  $U|_{S_e^{k-1}}$  is prismatic with respect to the coloring  $\mathcal{Q}|_{S_e^{k-1}}$  of the triangulation  $K|_{S_e^{k-1}}$  of the sphere  $S_e^{k-1} = \partial D_+^k$ . The claim is that in this situation  $K$  can be extended to a triangulation  $\widetilde{K}$  of  $D^{k+1}$ , the coloring  $\mathcal{Q}$  can be extended to an  $\mathbf{R}(X)$ -coloring  $\widetilde{\mathcal{Q}}$  of  $\widetilde{K}$ , the homeomorphisms  $G_1, \dots, G_m, U$  can be extended to homeomorphisms  $\widetilde{G}_1, \dots, \widetilde{G}_m, \widetilde{U} \in \text{PL}_{D^{k+1}}(X)$  in such a way that  $\widetilde{G}_1, \dots, \widetilde{G}_m$  will remain  $\widetilde{\mathcal{Q}}$ -prismatic and  $\widetilde{U}|_{D_-^k}$  will become  $\widetilde{\mathcal{Q}}|_{D_-^k}$ -prismatic.

The homotopy of a family of homeomorphisms to a “more prismatic” form is available with the help of a multi-dimensional generalization of Hudson’s construction of fragmentation of a PL isotopy. To describe the generalized Hudson fragmentation and its influence on the prismaticity, we introduce a universal notion of prismaticity, the *prismaticity of a homeomorphism with respect to an Alexandroff presheaf*.

We start with Sec. 6 devoted to Alexandroff topologies on polyhedra. The set  $\mathbf{AI}(X)$  of all Alexandroff topologies on a polyhedron  $X$  is partially ordered by strengthening. Any poset is a  $T^0$  Alexandroff space. Therefore, for any Alexandroff topology  $\mathcal{T}$  on some other polyhedron  $P$ , we can consider “Alexandroff presheaves”



with values in  $\mathbf{AI}(X)$ , i.e., continuous maps of Alexandroff spaces  $(B, \mathcal{T}) \rightarrow \mathbf{AI}(X)$ . We learn elementary surgery and homotopy of Alexandroff presheaves.

In Sec. 7 we introduce the notion of prismaticity of a homeomorphism  $G \in \text{PL}_B(X)$  with respect to an Alexandroff presheaf  $(B, \mathcal{T}) \rightarrow \mathbf{AI}(X)$ . This notion generalizes the prismaticity of  $G$  with respect to  $\mathbf{R}(X)$ -colorings of triangulations of  $B$ . We study how to deform an Alexandroff presheaf preserving the prismaticity of a homeomorphism.

Our constructions distinguish the case of Alexandroff presheaves with values in  $\mathbf{D}_c^\infty(K) \subseteq \mathbf{AI}(X)$ . The topologies from  $\mathbf{D}_c^\infty(K)$  are discrete everywhere except a disjoint set of open (in the standard topology) balls that are conic with respect to some triangulation  $K$  of the manifold  $X$ . The point is that, on the one hand, homeomorphisms that are prismatic with respect to presheaves with values in  $\mathbf{D}_c^\infty(K)$  are the output of the generalized fragmentation, and, on the other hand, they possess an  $\mathbf{R}(X)$ -triangulation.

In Sec. 8, we describe the process of  $\mathbf{R}(X)$ -triangulating  $\mathbf{D}_c^\infty(K)$ -prismatic homeomorphisms.

Then we approach the multistage construction of the generalized Hudson fragmentation of a fiberwise homeomorphism.

In Sec. 9, we introduce a general nonfiberwise deformation of a fiberwise homeomorphism  $G \in \text{PL}_B(X)$  in the class of fiberwise maps. The deformation is controlled by a map  $X \times C \xrightarrow{F} X \times B$  that is fiberwise with respect to the projection to  $X$ . The output of the deformation is a new map  $X \times C \xrightarrow{F \rtimes G} X \times C$  that is fiberwise with respect to the projection to  $C$ . We prove the important Proposition 40, which states that if  $F \rtimes G$  happens to be a fiberwise homeomorphism, then, under some conditions on  $F$ , the homeomorphism  $F \rtimes G$  “preserves” the prismaticity of  $G$ .

In Sec. 10, we define “graph systems” in the space  $X \times I^k$  (where  $I^k$  is a  $k$ -dimensional cube). With a graph system  $\Gamma$  we associate a remarkable map  $X \times T^k \xrightarrow{F_\Gamma} X \times I^k$ , which is fiberwise with respect to the projection to  $X$ . The polyhedron  $T^k$  is a  $(k + 1)$ -trapezoid with cubic base  $I^k$ .

A “graph system”  $\Gamma$  is a collection of subpolyhedra in  $X \times I^k$  that are the graphs of functions  $X \times I^{k-1} \rightarrow I$  embedded along various coordinates. We need some consistency conditions (**gf1**, **gf2**) on graphs. The meaning of these conditions is that all the graphs can be simultaneously blown up to wide strips without spoiling the overall picture. Into  $X \times T^k$  the polyhedra are embedded that are the traces of blowing up the graphs from  $\Gamma$  with constant speed. The map  $X \times T^k \xrightarrow{F_\Gamma} X \times I^k$  sends a point to its preimage under the blowing up of  $\Gamma$ .

In Sec. 11, we study the deformations  $F_\Gamma \rtimes G$ . In this situation, the general deformations  $\rtimes$  are turned into homotopies between the initial homeomorphism  $G = (F_\Gamma \rtimes G)^0$  and a fiberwise map  $(F_\Gamma \rtimes G)^1$  in the fiber bundle over the upper base  $(T^k)^1$  of the trapezoid  $T^k$ . Lemma 9 states that if  $G^{-1}(\Gamma)$  is also a graph system, then  $F_\Gamma \rtimes G$  is a fiberwise homeomorphism and hence  $F_\Gamma \rtimes G$  is a homotopy of  $G$ .

Then we observe (see Lemma 10) that, under an additional condition **gf4** on  $\Gamma$ , the homeomorphism  $(F_\Gamma \rtimes G)^1$  becomes prismatic with respect to a remarkable Alexandroff presheaf  $\mathbf{J}_\Gamma$  on  $(T^k)^1$ .

In Sec. 12, to any triangulation  $L$  of a manifold  $X$  and any compact family of homeomorphisms  $\mathcal{G} \subset \text{PL}_{T^k}(X)$  we associate a ‘‘Hudson graph system’’ in  $\text{H}(L, \mathcal{G})$ . The Hudson graph system is consistent with any homeomorphism  $G \in \mathcal{G}$  and has the property that the image of the Alexandroff presheaf  $\mathbf{J}_{\text{H}(L, \mathcal{G})}$  belongs to  $\mathbf{S}^k(L) \subset \mathbf{AI}(X)$ . The topologies in  $\mathbf{S}^k(L)$  are discrete everywhere except the union of at most  $k$  open stars of  $L$ . Lemma 11 guarantees that Hudson graph systems do exist for every  $L$  and  $\mathcal{G}$ .

In Sec. 13, we exploit the freedom in the choice of a triangulation when constructing a Hudson graph system. In Proposition 57 we show that for any triangulation  $K$  of a manifold  $X$ , we can choose a sufficiently large number  $n$  such that the Alexandroff presheaf  $\mathbf{J}_{\text{H}(\text{sd}_n K, \mathcal{G})}$  can be weakened to a presheaf  $\mathbf{J}'$  with values in  $\mathbf{D}_c^\infty(K)$ . The weakening preserves the prismaticity of homeomorphisms; therefore for any  $G \in \mathcal{G}$  the homeomorphism  $(F_{\text{H}(\text{sd}_n K, \mathcal{G})} \rtimes G)^1$  is prismatic with respect to the Alexandroff presheaf  $\mathbf{J}'$  with values in  $\mathbf{D}_c^\infty(K)$ .

In Sec. 14 we assemble the material accumulated in Secs. 9–13 into Lemma 12 ‘‘on prismatic fragmentation of fiberwise homeomorphisms over the cube.’’ This lemma guarantees that a finite family of homeomorphisms in  $\text{PL}_{T^k}(X)$  can be deformed to a  $\mathbf{D}_c^\infty(K)$ -prismatic form by a simultaneous homotopy.

In Sec. 15, Lemmas 13 and 14 perform the final assembly of the  $\mathbf{D}_c^\infty(K)$ -fragmentation of homeomorphisms and the  $\mathbf{R}(X)$ -triangulation of  $\mathbf{D}_c^\infty(K)$ -prismatic homeomorphisms into the  $\frown$ -lemma for the pair

$$(|\underline{\text{Prism}}^{m-1}(X) \times \text{PL}(X)|, |\underline{\text{Prism}}^m(X)|).$$

## 6. ALEXANDROFF SPACES (OR ‘‘PREORDERED SETS’’)

In this section, we present some useful constructions involving Alexandroff spaces and maps of Alexandroff spaces. We begin by recalling the definition and standard properties of Alexandroff spaces [3] (see also [23, 5]).

6.1. An **Alexandroff topology**  $\mathcal{T}$  on a set  $Y$  is a topology in which every point  $y \in Y$  has a minimal open neighborhood  $o(y)$ . The pair  $(Y, \mathcal{T})$  is called an Alexandroff space. An Alexandroff topology on  $Y$  is equivalent to the structure of a preorder on  $Y$ .

A **preorder** on a set  $Y$  is a transitive and reflective relation  $\preceq$  on  $Y$ . If, additionally,  $\preceq$  is antisymmetric, i.e.,  $(a \preceq b) \wedge (b \preceq a) \Rightarrow a = b$ , then it is just a partial order. Sets endowed with preorders are called **preordered sets**.

An Alexandroff topology  $\mathcal{T}$  gives rise to the following preorder on  $Y$ :  $y_0 \preceq_{\mathcal{T}} y_1 \Leftrightarrow o(y_0) \subseteq o(y_1)$ . Conversely, the lower ideals of a preorder on  $Y$  form an Alexandroff topology on  $Y$ . This correspondence is an isomorphism between the category all Alexandroff spaces and continuous maps and the category of preordered sets and monotone maps. We identify both categories by this isomorphism and regard an Alexandroff space  $(Y, \mathcal{T})$  also as a preordered set. The category of all Alexandroff spaces and continuous maps is denoted by **Al**. Posets are the same as  $T^0$  Alexandroff spaces. Thus the category **Posets** is a full subcategory in **Al**.

6.1.1. An Alexandroff topology  $\mathcal{T}$  on  $Y$  has a unique **minimal base**, which is formed by the minimal neighborhoods of points. We denote the minimal base of  $\mathcal{T}$  by  $\mathfrak{B}(Y, \mathcal{T})$  and regard it as a subset of the poset  $2^Y$ .

In terms of the preorder  $\preceq_{\mathcal{T}}$  on  $Y$ , the minimal base is formed by all principal ideals.

6.1.2. The Alexandroff theorem describes the minimal base as a cover.

**Theorem** (P. S. Alexandroff [2]). *A cover  $\mathcal{U}$  of a set  $Y$  is the minimal base of an Alexandroff topology if and only if*

- (i) *for every pair  $U_0, U_1 \in \mathcal{U}$ , the equality  $U_0 \cap U_1 = \cup_{W \in \mathcal{W}} W$  holds for some  $\mathcal{W} \subseteq \mathcal{U}$ ;*
- (ii) *if for  $\mathcal{W} \subseteq \mathcal{U}$  and  $U \in \mathcal{U}$  the equality  $\cup_{W \in \mathcal{W}} W = U$  holds, then  $U \in \mathcal{W}$ .*

The first condition of the Alexandroff theorem says that  $\mathcal{U}$  is a base of some topology  $\mathcal{T}$ ; the second one guarantees that the sets  $U \in \mathcal{U}$  are indeed the minimal neighborhoods in  $\mathcal{T}$ .

6.1.3. The correspondence  $A \mapsto \mathfrak{B}(A)$  on the objects of **Al** has a natural extension to a functor  $\mathbf{Al} \xrightarrow{\mathfrak{B}} \mathbf{Posets}$ . The map  $y \mapsto o(y)$  is a morphism of preordered sets  $(Y, \mathcal{T}) \xrightarrow{o} \mathfrak{B}(Y, \mathcal{T})$ . In terms of **Al**, the map  $o$  is a universal map from an Alexandroff space to a  $T^0$  Alexandroff space, in the sense that for any map  $A \xrightarrow{b} P$  in **Al** such

that  $P$  is a  $T^0$ -space, there exists a unique map  $b'$  such that the following triangle is commutative:

$$(20) \quad \begin{array}{ccc} A & \xrightarrow{b} & P \\ & \searrow o & \nearrow b' \\ & \mathfrak{B}(A) & \end{array}$$

Thus the maps  $A \xrightarrow{o} \mathfrak{B}(A)$  form a natural transformation of the identity functor into  $\mathfrak{B}$ .

6.1.4. The intersection of any family of open sets in an Alexandroff topology is open. Therefore the set  $\mathcal{T}^c$  of all closed subsets in  $(Y, \mathcal{T})$  is also an Alexandroff topology. The minimal neighborhoods in  $\mathcal{T}^c$  are the minimal closed neighborhoods of points in  $(Y, \mathcal{T})$ . We denote by  $c(y)$  the minimal closed neighborhood of  $y \in Y$ . The minimal base of  $\mathcal{T}^c$  is formed by all upper principal ideals of the preordered set  $(Y, \mathcal{T})$ :  $(Y, \mathcal{T}^c) = (Y, \mathcal{T})^{\text{op}}$ . Thus passing to the dual topology is an involution in **Al**. The equivalence classes  $\underset{\mathcal{T}}{\sim}$  of the preorder  $\underset{\mathcal{T}}{\leq}$  are the sets  $s(y) = c(y) \cap o(y)$ .

They form a partition  $\Sigma(Y, \mathcal{T})$  of  $Y$ . There is a one-to-one map  $\mathfrak{B}(Y, \mathcal{T}) \xrightarrow{\text{ns}} \Sigma(Y, \mathcal{T})$ , which associates to a principal ideal the equivalence class of its maximal elements: for every  $y \in Y$ ,

$$\text{ns}(o(y)) = s(y).$$

6.1.5. **Weakening of Alexandroff topologies.** Let  $\mathcal{R}$  and  $\mathcal{T}$  be two Alexandroff topologies on  $Y$ . The identity map of  $Y$  induces an **Al**-morphism (continuous map)  $(Y, \mathcal{R}) \xrightarrow{w} (Y, \mathcal{T})$  if and only if  $\mathcal{T}$  is weaker than  $\mathcal{R}$ . Therefore we obtain a partial order on  $Y$ . We denote this partial order by the same symbol  $\leq$  as the order by subdivision. We regard the poset of all topologies on  $Y$  ordered by weakening as a subcategory **Al**( $X$ ) of **Al**. Simultaneously, **Al**( $X$ ) is a poset, so that it is represented by some object in **Posets**  $\leftrightarrow$  **Al**. The poset **Al**( $X$ ) has a maximal element, the **trivial topology**  $X^{\text{triv}}$ , which has the unique open set  $X$ . The poset **Al**( $X$ ) has a minimal element, the **discrete topology**  $X^\delta$ , in which all the points of  $X$  are simultaneously open and closed.

6.2. **Example.** Let  $\mathbf{Q} \in \mathbf{R}(X)$  be a ball complex on  $X$ . To  $\mathbf{Q}$  we can associate the Alexandroff topology  $\mathcal{A}(\mathbf{Q})$  on  $X$  whose minimal base consists of the open (in the standard topology) stars of balls. In the dual topology  $\mathcal{A}^c(\mathbf{Q})$ , the minimal base consists of the closed (in the standard topology) balls of  $\mathbf{Q}$ . The elements of

$\Sigma(Y, \mathcal{A}^c(Q))$  are the relative interiors (in the standard topology) of the balls from  $Q$ . Consider two ball complexes  $Q_0, Q_1 \in \mathbf{R}(X)$ .

**Proposition 13.**  $(Q_0 \leq_{\mathbf{R}(X)} Q_1) \Leftrightarrow (\mathcal{A}(Q_0) \leq_{\mathbf{AI}(X)} \mathcal{A}(Q_1)) \Leftrightarrow (\mathcal{A}^c(Q_0) \leq_{\mathbf{AI}(X)} \mathcal{A}^c(Q_1)).$

*Proof.* Follows tautologically from definitions. □

Thus the correspondence  $Q \mapsto \mathcal{A}^c Q$  is an embedding  $\mathbf{R}(X) \xrightarrow{\mathcal{A}^c} \mathbf{AI}(X)$ . Note that the following diagram is commutative:

$$\begin{array}{ccc}
 \mathbf{R}(X) & \xrightarrow{\mathcal{A}^c} & \mathbf{AI}(X) \\
 \searrow \mathbf{P} & & \swarrow \mathfrak{B} \\
 & \mathbf{Posets.} & 
 \end{array}$$

**6.3. Alexandroff topologies and covers.** We will associate an Alexandroff topology  $\mathcal{A}(\mathcal{U})$  to a finite cover  $\mathcal{U}$  of a set  $Y$ . Define the minimal open neighborhood of  $y \in Y$  in  $\mathcal{A}(\mathcal{U})$  by the equality

$$o(y) = \bigcap_{\{U \mid U \in \mathcal{U}, y \in U\}} U.$$

Then the minimal closed neighborhood looks as

$$c(y) = \bigcap_{\{U \mid U \in \mathcal{U}, y \in \overline{U}\}} \overline{U},$$

where  $\overline{U} = Y \setminus U$ .

**Proposition 14.** *The topology  $\mathcal{A}(\mathcal{U})$  on  $Y$  is the weakest topology on  $Y$  in which all elements of  $\mathcal{U}$  are open.*

*Proof.* Follows directly from the construction. □

**6.4. Inscribing topologies.** A cover  $\mathcal{W}_0$  of  $Y$  is *inscribed* into a cover  $\mathcal{W}_1$  (we denote this fact by  $W_0 \triangleleft W_1$ ) if for every  $W_0 \in \mathcal{W}_0$  there exists  $W_1 \in \mathcal{W}_1$  such that  $W_0 \subset W_1$ . We say that an Alexandroff topology  $\mathcal{R}$  on  $Y$  is *inscribed* into an Alexandroff topology  $\mathcal{T}$  if the cover  $\mathfrak{B}(Y, \mathcal{R})$  is inscribed into the cover  $\mathfrak{B}(Y, \mathcal{T})$ . An Alexandroff topology  $\mathcal{T}$  is *dense* if  $\mathfrak{B}(X, \mathcal{T})$  is a lower subsemilattice in  $2^Y$  (i.e.,  $U_0, U_1 \in \mathfrak{B}(X, \mathcal{T})$  implies  $U_0 \cap U_1 \in \mathfrak{B}(X, \mathcal{T})$ ). In the case where  $\mathcal{T}$  is dense, inscribing can be made functorial.

**Proposition 15.** *If an Alexandroff topology  $\mathcal{R}$  on  $Y$  is inscribed into an Alexandroff topology  $\mathcal{T}$  and  $\mathcal{T}$  is dense, then there is a poset morphism  $\mathfrak{B}(Y, \mathcal{R}) \xrightarrow{\phi} \mathfrak{B}(Y, \mathcal{T})$  such that for every  $R \in B(Y, \mathcal{R})$  the inclusion  $R \subset \phi(R)$  holds.*

*Proof.* Set  $\phi(R) = \bigcap_{R \subseteq T \in \mathfrak{A}(Y, \mathcal{T})} T$ . The left-hand side of this equality belongs to  $\mathfrak{A}(Y, \mathcal{T})$  by the definition of a dense topology, and our definition is obviously functorial.  $\square$

**6.5. Limits in  $\mathbf{Al}$ .** Here we will observe the existence of some limits in  $\mathbf{Al}$ . The following propositions are obvious after switching to the language of preordered sets.

**Proposition 16.** *The category  $\mathbf{Al}$  contains Cartesian squares. To fix the notation, we will formulate this fact explicitly: the diagram*

$$\begin{array}{ccc} A \times B & \xrightarrow{j^*} & A \\ \downarrow i, j & & \downarrow i \\ B & \xrightarrow{j} & C \\ \downarrow i^* & & \\ Y & & \end{array}$$

*formed by morphisms  $i, j$  can be extended to a Cartesian square by morphisms  $i^*, j^*$ .*

**Proposition 17.** *The category  $\mathbf{Al}$  contains some co-Cartesian squares, namely, “pastings,” i.e., the diagram*

$$\begin{array}{ccc} A \sqcup B & \xleftarrow{j^*} & A \\ \downarrow i, j & & \downarrow i \\ B & \xleftarrow{j} & C \\ \downarrow i^* & & \end{array}$$

*formed by embeddings  $i, j$  can be extended to a co-Cartesian square.*

Let us mention a special case of Cartesian square. Assume that we have two Alexandroff topologies  $\mathcal{R}, \mathcal{T}$  on a set  $Y$ . Consider the morphisms

$$(21) \quad (Y, \mathcal{R}) \rightarrow (Y, Y^{\text{triv}}) \leftarrow (Y, \mathcal{T})$$

of weakening the topologies  $\mathcal{R}, \mathcal{T}$  to the trivial topology  $Y^{\text{triv}}$ . The co-Cartesian square generated by the diagram (21) is the following square in **A1**:

$$\begin{array}{ccc} (Y, \mathcal{R} \vee \mathcal{T}) & \dashrightarrow & (Y, \mathcal{R}) \\ \downarrow & & \downarrow \\ (Y, \mathcal{T}) & \longrightarrow & (Y, Y^{\text{triv}}), \end{array}$$

where  $\mathcal{R} \vee \mathcal{T}$  is the minimal common strengthening of  $\mathcal{R}$  and  $\mathcal{T}$ . We can describe the minimal base for  $\mathcal{R} \vee \mathcal{T}$ .

**Proposition 18.** *For every  $V \in \mathfrak{B}(Y, \mathcal{R} \vee \mathcal{T})$  there is a unique pair  $(R, T)$ ,  $R \in \mathfrak{B}(Y, \mathcal{R})$ ,  $T \in \mathfrak{B}(Y, \mathcal{T})$ , such that  $Y = R \cap T$  and  $\text{ns}(R) \cap \text{ns}(T) \neq \emptyset$ . Conversely, for every pair  $(R, T)$ ,  $R \in \mathfrak{B}(Y, \mathcal{R})$ ,  $T \in \mathfrak{B}(Y, \mathcal{T})$ , such that  $\text{ns}(R) \cap \text{ns}(T) \neq \emptyset$  there is a unique element  $R \cap T \in \mathfrak{B}(Y, \mathcal{R} \vee \mathcal{T})$ .*

6.5.1. Let  $A \xrightarrow{\phi} B$  be a map of Alexandroff spaces. Consider all possible extensions of  $\phi$  to diagrams of the form

$$(22) \quad \begin{array}{ccc} & C & \\ \alpha \nearrow & & \nwarrow \beta \\ A & \xrightarrow{\phi} & B \end{array}$$

such that

$$(23) \quad \alpha \geq \beta \circ \phi.$$

**Proposition 19.** *There exists a diagram*

$$(24) \quad \begin{array}{ccc} & \overrightarrow{\text{cyl}}_{\phi} & \\ i_0 \nearrow & & \nwarrow i_1 \\ A & \xrightarrow{\phi} & B \end{array}$$

such that  $i_0 \geq i_1 \circ \phi$  and for every diagram of the form 22 such that the condition (23) is satisfied, there is a unique map  $\overrightarrow{\text{cyl}}_{\phi} \xrightarrow{\overrightarrow{\text{cyl}}_{\phi}(\alpha, \beta)} C$  such that

$$u \circ i_0 = \alpha, \quad u \circ i_1 = \beta.$$

*Proof.* The construction  $\overrightarrow{\text{cyl}}_\phi$  coincides with the construction of “homotopy colimit.” Let  $\leq_A$  be the preorder on  $A$  and  $\leq_B$  be the preorder on  $B$ . Then we define  $\overrightarrow{\text{cyl}}_\phi$  as the disjoint union  $\{(a, 0)\}_{a \in A} \cup \{(b, 1)\}_{b \in B}$  of  $A$  and  $B$  endowed with the preorder

$$(x, i) \underset{\overrightarrow{\text{cyl}}_\phi}{\geq} (y, j) \Leftrightarrow \begin{cases} x \geq_A y & \text{for } i = j = 0, \text{ or} \\ x \geq_B y & \text{for } i = j = 1, \text{ or} \\ \phi(x) \geq_B y & \text{for } i = 0, j = 1. \end{cases}$$

Embeddings  $A \xrightarrow{i_0} \overrightarrow{\text{cyl}}_\phi$  and  $B \xrightarrow{i_1} \overrightarrow{\text{cyl}}_\phi$  are defined as  $i_0(a) = (a, 0)$  and  $i_1(b) = (b, 1)$ . By construction,  $i_0(a) \underset{\overrightarrow{\text{cyl}}_\phi}{\geq} i_1 \circ \phi(a)$ , and the universality property can be checked tautologically.  $\square$

Given a morphism  $A \xrightarrow{\phi} B$ , again consider all diagrams of the form (22 on the previous page), but such that inequality (22 on the preceding page) is reversed, i.e.,

$$(25) \quad \alpha \leq \beta \circ \phi.$$

**Proposition 20.** *There is a diagram*

$$\begin{array}{ccc} & \overrightarrow{\text{cyl}}_\phi & \\ & \nearrow^{i_0} & \nwarrow_{i_1} \\ A & \xrightarrow{\phi} & B \end{array}$$

such that  $i_0 \leq i_1 \circ \phi$  and for every diagram of the form (22) such that (25) is satisfied, there is a map  $\overrightarrow{\text{cyl}}_\phi \xrightarrow{\overrightarrow{\text{cyl}}_\phi(\alpha, \beta)} C$  such that  $u \circ i_0 = \alpha$ ,  $u \circ i_1 = \beta$ .

*Proof.* We can use the duality and observe that after passing to the dual spaces and maps we find ourselves in the conditions of Proposition 19. Thus we can put  $\overrightarrow{\text{cyl}}_\phi = (\overrightarrow{\text{cyl}}_{\phi^{\text{op}}})^{\text{op}}$ . Therefore  $\overrightarrow{\text{cyl}}_\phi$  is the disjoint union  $\{(a, 0)\}_{a \in A} \cup \{(b, 1)\}_{b \in B}$  of  $A$  and  $B$  with the preorder

$$(x, i) \underset{\overrightarrow{\text{cyl}}_\phi}{\leq} (y, j) \Leftrightarrow \begin{cases} x \leq_A y & \text{for } i = j = 0, \text{ or} \\ x \leq_B y & \text{for } i = j = 1, \text{ or} \\ \phi(x) \leq_B y & \text{for } i = 0, j = 1. \end{cases}$$



Embeddings  $A \xrightarrow{i_0} \underline{\text{cyl}}_\phi$  and  $B \xrightarrow{i_1} \underline{\text{cyl}}_\phi$  are defined as  $i_0(a) = (a, 0)$  and  $i_1(b) = (b, 0)$ .  $\square$

**6.6. Piecewise linear Alexandroff topologies.** Now let  $Y$  be a closed compact PL polyhedron.

An OPL *Alexandroff topology* on the polyhedron  $Y$  is an Alexandroff topology  $\mathcal{T}$  on  $Y$  such that all subsets closed in  $\mathcal{T}$  are closed PL subpolyhedra in  $Y$ .

A CPL *Alexandroff topology* on the polyhedron  $Y$  is an Alexandroff topology  $\mathcal{T}$  on  $Y$  such that all subsets open in  $\mathcal{T}$  are closed PL subpolyhedra in  $Y$ .

The duality  $\mathcal{T} \leftrightarrow \mathcal{T}^c$  sends an OPL topology to a CPL topology and *vice versa*.

**6.6.1. PL Alexandroff topologies associated with triangulations.** Let  $K$  be a finite simplicial complex. The cover of  $|K|$  by the closed simplices of  $K$  is the minimal base of the CPL Alexandroff topology  $\mathcal{A}^c(K)$  (see Sec. 6.2 on page 44). The minimal base of the dual OPL topology  $\mathcal{A}(K)$  is the set of all open stars of the simplices from  $K$ .

The following observation essentially belongs to the PL category.

**Proposition 21.** *Any finite cover  $\mathcal{U}$  of a compact polyhedron  $Y$  by closed subpolyhedra has a triangulation, i.e., there is a triangulation  $K$  of  $Y$  such that  $K$  refines  $Y$  as a closed cover.*

*Proof.* One can triangulate any  $U \in \mathcal{U}$  and find a common triangulation of all these triangulated subpolyhedra.  $\square$

An immediate corollary is as follows.

**Proposition 22.**

1. *For every CPL Alexandroff topology  $\mathcal{T}$  on a compact polyhedron  $Y$  there exists a linear triangulation  $K$  of  $Y$  such that  $\mathcal{A}^c(K) \trianglelefteq \mathcal{T}$ .*
2. *For every OPL Alexandroff topology  $\mathcal{R}$  on a compact polyhedron  $Y$  there exists a linear triangulation  $K$  of  $Y$  such that  $\mathcal{A}(K) \trianglelefteq \mathcal{R}$ .*

*Proof.* 1. From the minimality, compactness, and consideration of the dual OPL topology it follows that the minimal base of  $\mathcal{T}$  is finite. By Proposition 21, we can choose a triangulation  $K_{\mathcal{T}}$  of the minimal base of  $\mathcal{T}$ . Then  $\mathcal{A}^c(K_{\mathcal{T}}) \trianglelefteq \mathcal{T}$ .

2. Switch to the dual CPL topology  $\mathcal{R}^c$ . Choose  $K_{\mathcal{R}^c}$ . Then  $\mathcal{A}(K_{\mathcal{R}^c}) \trianglelefteq \mathcal{R}$ .  $\square$

In Sec. 6.4 on page 45 we have introduced the notion of a dense Alexandroff topology. Not every Alexandroff topology is dense, but for any simplicial complex  $K$  the topologies  $\mathcal{A}K$  and  $\mathcal{A}^cK$  are dense for obvious reasons. Therefore Proposition 22 has the following corollary.

**Proposition 23.** *Any OPL[CPL] Alexandroff topology on a compact polyhedron has a dense OPL[CPL] strengthening.*

**6.7. Some properties of CPL Alexandroff topologies.** Here we observe that maps of CPL Alexandroff spaces to  $T^0$  Alexandroff spaces can be regarded as generalized colorings of a polyhedron by the nerve of a poset (see Sec. 4.2 on page 35).

6.7.1. Let  $Y$  be a polyhedron,  $P$  be a poset, and  $f$  be a coloring of  $Y$  by the nerve  $\mathcal{N}P$  of  $P$ . Without loss of generality this means that we have a locally ordered simplicial complex  $K$  such that  $|K| = Y$  and a morphism of injective simplicial sets (see Sec. 4.1 on page 35)  $iK \xrightarrow{f} \mathbf{d}\mathcal{N}P$ . Consider the CPL Alexandroff topology  $\mathcal{A}(K)$ . The coloring  $f$  gives rise to a map  $\text{Max}f$  of the space  $(Y, \mathcal{A}^c(K))$  to the poset  $P$ . The map  $\text{Max}f$  is defined by the following commutative triangle:

$$(26) \quad \begin{array}{ccc} (Y, \mathcal{A}^c(K)) & \xrightarrow{\text{Max}f} & P \\ & \searrow o & \nearrow \text{max} f \\ & \mathfrak{B}(Y, \mathcal{A}(K)), & \end{array}$$

where  $K = \mathfrak{B}(Y, \mathcal{A}^c(K)) \xrightarrow{\text{max} f} P$  is the map if posets that sends a simplex  $\delta \in K$  to the value of  $f$  at the maximal (in the local order) vertex of the simplex.

6.7.2. Assume that we have a CPL Alexandroff topology  $\mathcal{T}$  on  $Y$ . Let  $P$  be a poset, and let a map  $(Y, \mathcal{T}) \xrightarrow{\xi} P$  be fixed. A **triangulation of the map**  $\xi$  is a coloring  $iK \xrightarrow{f} \mathbf{d}\mathcal{N}P$  of  $Y = |K|$  by the nerve of  $P$  such that the topology  $\mathcal{A}^c(K)$  is stronger than  $\mathcal{T}$  and the diagram

$$(27) \quad \begin{array}{ccc} & & P \\ & \nearrow \text{Max}f & \uparrow \xi \\ (Y, \mathcal{A}^c(K)) & \longrightarrow & (Y, \mathcal{T}) \end{array}$$

is commutative. The lower arrow in the diagram is the morphism of weakening the topology.

**Proposition 24.** *Assume that*

- $(Y, Z)$  is a pair of compact polyhedra,
- $\mathcal{T}$  is a CPL Alexandroff topology on  $Y$ ,
- $\mathcal{T}|_Z$  is the induced topology on  $Z$ ,
- $P$  is a poset,
- $(X, \mathcal{T}) \xrightarrow{\xi} P$  is a map,
- $\xi_Z = \xi|_{(Z, \mathcal{T}_Z)}$  is the restriction of  $\xi$ .

Let  $f_Z$  be a triangulation of  $\xi_Z$ . Then there exists a triangulation  $f$  of  $\xi$  extending  $f_Z$ .

*Proof.* This is a standard PL-theorem on the extension of a triangulation from a closed subpolyhedron to the entire polyhedron.  $\square$

6.7.3. We will need a slightly stronger assertion than Proposition 24 in the case  $Z = \emptyset$ . Consider a finite poset  $R$  and the geometric realization  $|\text{Ord}(R)|$  of its order complex. On  $|\text{Ord}(R)|$  we have the CPL Alexandroff topology  $\mathcal{A}^c(\text{Ord}(R))$ . The vertices of simplices of  $\text{Ord}(R)$  are canonically ordered and indexed by the elements of  $R$ . Therefore we have the tautological coloring  $\text{Ord}(R) \xrightarrow{f(R)} \mathbf{dNR}$  and the canonical map  $(|\text{Ord}(P)|, \mathcal{A}^c(\text{Ord}(R))) \xrightarrow{\varkappa(R)} R$  sending a point  $x \in |\text{Ord}(P)|$  to the maximal vertex of the simplex that contains  $x$  in the relative interior. In this situation,  $\text{Max}f(R) = \varkappa(R)$  and the coloring  $f(R)$  can be recovered from  $\varkappa(P)$  in a unique way. That is, if  $\text{Max}g = \varkappa(P)$  for some other coloring of  $|\text{Ord}R|$ , then  $g = f(R)$ .

**Proposition 25.** *Let  $\mathcal{T}$  be a CPL Alexandroff topology on  $Y$ . Consider a map  $(Y, \mathcal{T}) \xrightarrow{\xi} P$ , where  $P$  is a poset. Then there is a finite poset  $O$  such that  $\text{Ord}(O)$  triangulates  $Y$ ,  $|\text{Ord}(O)| = Y$ , the topology  $\mathcal{T}$  is weaker than  $\mathcal{A}^c(\text{Ord}(O))$ , and the commutative diagram of solid arrows*

$$\begin{array}{ccc}
 O & \xrightarrow{\quad \quad \quad} & P \\
 \varkappa(O) \uparrow & & \uparrow \xi \\
 (Y, \mathcal{A}^c(\text{Ord}(O))) & \longrightarrow & (Y, \mathcal{T})
 \end{array}$$

can be uniquely completed by a dashed arrow. Here the lower arrow is the morphism of weakening the topology.

*Proof.* It is sufficient to find a common triangulation  $K$  of all the elements from  $\mathfrak{B}(Y, \mathcal{T})$ . Then  $O$  is the flag poset of this triangulation and its order complex is the first barycentric subdivision of  $K$ .  $\square$

6.7.4. We need to record a standard fact. Let  $O$  be a finite poset and  $P$  be an arbitrary poset. Assume that we have two maps  $O \xrightarrow{f_0, f_1} P$ . Let  $f_1 \geq f_0$ . Then there is a canonical homotopy between  $f_0$  and  $f_1$ , a poset map  $O \times \mathbf{1} \xrightarrow{F} P$ , where  $\mathbf{1} = (0 < 1)$  is the total order on two elements. The map  $F$  is defined as follows:  $F(x, 0) = f_0(x)$ ,  $F(y, 1) = f_1(y)$ . We will specify the properties of this homotopy in the language of CPL Alexandroff spaces. Put

$$(|\text{Ord}O|, \mathcal{A}^c \text{Ord}O) \xrightarrow{\xi_0=f_0 \circ \varkappa(O), \xi_1=f_1 \circ \varkappa(O)} P$$

and

$$(|\text{Ord}(O \times \mathbf{1})|, \mathcal{A}^c(\text{Ord}(O \times \mathbf{1}))) \xrightarrow{\Xi=F \circ \varkappa((O \times \mathbf{1}))} P.$$

We have the commutative diagram

(28)

$$\begin{array}{ccccc} & & P & & \\ & \nearrow \xi_0 & \uparrow \Xi & \nwarrow \xi_1 & \\ (|\text{Ord}O|, \mathcal{A}^c \text{Ord}O) & \xrightarrow{h_0} & (|\text{Ord}(O \times \mathbf{1})|, \mathcal{A}^c(\text{Ord}(O \times \mathbf{1}))) & \xleftarrow{h_1} & (|\text{Ord}O|, \mathcal{A}^c \text{Ord}O), \end{array}$$

where  $h_0, h_1$  are the natural embeddings into the 0, 1 faces, which are also embeddings in the Alexandroff topology. There is a homeomorphism  $|\text{Ord}O \times \mathbf{1}| \xrightarrow{g} |\text{Ord}O| \times ([0, 1] = |\mathbf{1}|)$ . The homeomorphism  $g^{-1}$  sends the product of simplices  $|s| \times [0, 1]$  to  $|s \times \mathbf{1}| \subseteq |\text{Ord}O \times \mathbf{1}|$  with the help of the standard geometric triangulation of the product of ordered simplices. We have the Alexandroff topology  $\mathcal{A}^c \text{Ord}O \times \mathcal{A}^c \text{Ord}\mathbf{1}$  on  $|\text{Ord}O| \times [0, 1] = |\mathbf{1}|$ . The minimal base of this CPL topology (see [5]) is formed by all products of elements of the minimal bases of the factors. That is,

$$\begin{aligned} (29) \quad \mathfrak{B}(|\text{Ord}O| \times [0, 1], \mathcal{A}^c \text{Ord}O \times \mathcal{A}^c \text{Ord}\mathbf{1}) \\ = \{\delta \times \{0\}\}_{\delta \in \text{Ord}O} \cup \{\delta \times [0, 1]\}_{\delta \in \text{Ord}O} \cup \{\delta \times \{1\}\}_{\delta \in \text{Ord}O}. \end{aligned}$$

Therefore the PL homeomorphism  $g$  induces the weakening morphism for CPL Alexandroff topologies:

$$(30) \quad (|\text{Ord}O| \times [0, 1], \mathcal{A}^c \text{Ord}(O \times \mathbf{1})) \xrightarrow{\tilde{g}} (|\text{Ord}O| \times [0, 1], \mathcal{A}^c \text{Ord}O \times \mathcal{A}^c \text{Ord}\mathbf{1}).$$

The following diagrams are commutative for  $i = 0, 1$ :

$$(31) \quad \begin{array}{ccc} (|\text{Ord}O| \times [0, 1], \mathcal{A}^c\text{Ord}(O \times \mathbf{1})) & \xrightarrow{\tilde{g}} & (|\text{Ord}O| \times [0, 1], \mathcal{A}^c\text{Ord}O \times \mathcal{A}^c\text{Ord}\mathbf{1}) \\ & \swarrow h_i \quad \searrow h_i & \\ & (|\text{Ord}O|, \mathcal{A}^c\text{Ord}O). & \end{array}$$

Define a morphism

$$\Psi' : \mathfrak{B}(|\text{Ord}O| \times [0, 1], \mathcal{A}^c\text{Ord}O \times \mathcal{A}^c\text{Ord}\mathbf{1}) \rightarrow P$$

by the rule

$$\begin{aligned} \Psi'(\delta \times [0, 1]) &= \Psi'(\delta \times \{1\}) = \max f_1(\delta), \\ \Psi'(\delta \times \{0\}) &= \max f_0(\delta). \end{aligned}$$

This is a well-defined map, and the following diagram is commutative:

$$(32) \quad \begin{array}{ccc} & P & \\ \Psi \nearrow & & \nwarrow \Xi \\ (|\text{Ord}O| \times [0, 1], \mathcal{A}^c\text{Ord}O \times \mathcal{A}^c\text{Ord}\mathbf{1}) & \xleftarrow{\tilde{g}} & (\text{Ord}(O \times \mathbf{1}), \mathcal{A}^c\text{Ord}(O \times \mathbf{1})). \end{array}$$

**6.8. Approximation of an OPL Alexandroff topology by a CPL Alexandroff topology.** Assume that we have an OPL Alexandroff topology  $\mathcal{T}$  on a compact polyhedron  $Y$ . We say that a CPL Alexandroff topology  $\mathcal{C}$  **strictly approximates**  $\mathcal{T}$  if the following is true: there exists a map  $\mathfrak{B}(Y, \mathcal{C}) \xrightarrow{\xi} \mathfrak{B}(Y, \mathcal{T})$  such that  $C \subseteq \xi(C)$  for every  $C \in \mathfrak{B}(Y, \mathcal{C})$ .

**Proposition 26.** *For any OPL Alexandroff topology  $\mathcal{T}$  on a compact polyhedron  $Y$  there is a CPL Alexandroff topology that strictly approximates  $\mathcal{T}$ .*

*Proof.* This follows from the theory of regular neighborhoods. In some sufficiently fine common triangulation of the closed compliments to the elements of the minimal base of  $\mathcal{T}$  we choose open regular neighborhoods to all these compliments. Switching again to the compliments, we obtain a required approximating CPL topology.  $\square$

## 7. GENERALIZED PRISMATIC HOMEOMORPHISMS

7.0.1. Let  $(B, \mathcal{T})$  be an Alexandroff space. Let  $A \xrightarrow{f} B$  be a map. Denote by  $\mathcal{T}|_f$  the weakest topology on  $A$  in which  $f$  is continuous. The topology  $\mathcal{T}|_f$  is again an Alexandroff topology. Let  $(B, \mathcal{T}) \xrightarrow{\xi} (D, \mathcal{U})$  be an **AI**-morphism, and let  $A \xrightarrow{f} B$  be a map of sets. We denote by  $\xi|_f$  the map  $(A, \mathcal{T}|_f) \rightarrow (D, \mathcal{U})$  such that  $\xi|_f = \xi \circ f$ .

7.0.2. *Alexandroff presheaves and generalized prismatic homeomorphisms.* Let  $X \times B \xrightarrow{\pi_2} B$  be the trivial bundle, and let  $G \in \text{PL}_B(X)$  be a fiberwise homeomorphism. Let  $\mathcal{T}$  be an Alexandroff topology on  $B$ . The poset  $\mathbf{Al}(X)$  is a poset, therefore it is an Alexandroff space. Thus we are allowed to consider a continuous map

$$(33) \quad (B, \mathcal{T}) \xrightarrow{\xi} \mathbf{Al}(X).$$

A continuous map of the form (33) will be called an **Alexandroff presheaf** on  $B$ .

We say that the fiberwise homeomorphism  $G$  is  **$\xi$ -prismatic** if for every  $U \in \mathfrak{B}(B, \mathcal{T})$ , every pair of points  $b_1, b_2 \in U$ , every  $V \in \mathfrak{B}(X, \xi'(U))$ , the following condition holds:  $G^{-1}|_{b_1}(V) = G^{-1}|_{b_2}(V)$ . (For the definition of  $\xi'$ , see (20 on page 44).)

Generally, we do not assume any connection between the topologies of the polyhedra  $B, X$  and the Alexandroff topologies from the definition of a prismatic homeomorphism. If  $\mathcal{T}$  is the discrete topology  $B^\delta$  on  $B$ , then any  $G$  is  $\xi$ -prismatic for any  $\xi$ . Similarly, any  $G$  is  $\xi$ -prismatic if  $\xi$  sends the whole  $(B, \mathcal{T})$  to the trivial topology  $X^{\text{triv}}$ . Note also the following fact.

**Proposition 27.** *In the definition of the  $\xi$ -prismaticity of  $G$ , all occurrences of  $\mathfrak{B}$  can be replaced by  $\Sigma$ .*

Piecewise linear homeomorphisms of  $X$  act on Alexandroff topologies on  $X$ . If a homeomorphism  $G$  is  $\xi$ -prismatic, then the correspondence  $b \mapsto G^{-1}\xi(b)$  is a new Alexandroff presheaf  $(B, \mathcal{T}) \xrightarrow{G^{-1}\xi} \mathbf{Al}(X)$ . Therefore if some other homeomorphism is  $G^{-1}\xi$ -prismatic, then the composition  $F \circ G$  is  $\xi$ -prismatic. We obtain a groupoid  $\mathbf{GPrism}_B(X)$  whose objects are the Alexandroff presheaves on  $B$  with values in  $\mathbf{Al}(X)$ . A  $\mathbf{GPrism}_B(X)$ -morphism  $\phi \rightarrow \xi$  is a  $\xi$ -prismatic homeomorphism such that  $G^{-1}\xi = \phi$ . The groupoid  $\mathbf{GPrism}_B(X)$  is the groupoid of **generalized prismatic homeomorphisms** of the trivial bundle  $X \times B \xrightarrow{\pi_2} B$ .

Let  $A \xrightarrow{f} B$  be a PL map and  $\phi \xrightarrow{G} \xi \in \text{Mor } \mathbf{GPrism}_B(X)$ . Then

$$f^*(G) = (\phi|_f \xrightarrow{G|_f} \xi|_f) \in \text{Mor } \mathbf{GPrism}_A(X).$$

The correspondence  $G \mapsto G|_f$  is a morphism of groupoids

$$\mathbf{GPrism}_B(X) \xrightarrow{f^*} \mathbf{GPrism}_A(X).$$

Therefore  $\mathbf{GPrism}(X)$  is a contravariant functor

$$\text{PL} \xrightarrow{\mathbf{GPrism}} \mathbf{Groupoids}.$$

There are three maps associated with every Alexandroff presheaf  $(B, \mathcal{T}) \xrightarrow{\xi} \mathbf{Al}(X)$ :

$$(34) \quad (B, \mathcal{T}) \xrightarrow{\mathfrak{B}\xi} \mathbf{Posets}, \quad \mathfrak{B}(B, \mathcal{T}) \xrightarrow{\tilde{\xi}} \mathbf{Posets}, \quad \mathfrak{B}(B, \mathcal{T}) \xrightarrow{\tilde{\xi}'} \mathbf{Al}.$$

The following tetrahedral diagram of functors is commutative:

$$(35) \quad \begin{array}{ccc} \mathbf{AI} & \xrightarrow{\mathfrak{B}} & \mathbf{Posets} \\ \xi \uparrow & \swarrow \mathfrak{B}\xi & \nearrow \tilde{\xi}' \\ (B, \mathcal{T}) & \xrightarrow{o} & \mathfrak{B}(B, \mathcal{T}) \end{array} \quad \begin{array}{c} \uparrow \tilde{\xi} \\ \mathfrak{B}(B, \mathcal{T}) \end{array}$$

By the definition of prismaticity, the homeomorphism  $\phi \xrightarrow{G} \xi$  induces some isomorphism of functors  $\tilde{\phi} \xrightarrow{\tilde{G}} \tilde{\xi}$ .

7.0.3. *Example.* Let us show in what sense the notion of a generalized prismatic homeomorphism contains the notion of a  $\mathbf{Q}$ -prismatic homeomorphism (see Sec. 3.2.2 on page 22) with a simplex as the base. It was mentioned in Sec. 6.2 on page 44 that identifying a ball complex  $\mathbf{Q}$  with the Alexandroff topology  $A^c(\mathbf{Q})$  yields an embedding  $\mathbf{R}(X) \rightarrow \mathbf{AI}(X)$ . Let  $Q = \mathbf{Q}_0, \dots, \mathbf{Q}_k$  be a coloring of  $[\Delta^k]$  by  $\mathbf{R}(X)$ . Let  $(\Delta^k, \mathcal{A}^c([\Delta^k])) \xrightarrow{\text{Max } Q} \mathbf{R}(X)$  be the map of Alexandroff spaces defined in (26) on page 50. Comparing the definitions, we obtain the following proposition.

**Proposition 28.** *A homeomorphism  $G \in \text{PL}_k$  is  $Q$ -prismatic in the sense of Sec. 3.2.2 if and only if  $G$  is Max  $Q$ -prismatic in the generalized sense.*

Thus the PL groupoid **GPrizm** contains the simplicial groupoid **Prism**.

We will usually omit the adjective “generalized.”

### 7.1. Operations on prismatic homeomorphisms.

7.1.1. *Pasting prismatic homeomorphisms.* Let  $A \xrightarrow{i_0} B_0$ ,  $A \xrightarrow{i_1} B_1$  be embeddings of polyhedra. Fix  $\langle G_0, \alpha \rangle \in \mathbf{GPrizm}_{B_0}(X)$ ,  $\langle G_1, \beta \rangle \in \mathbf{GPrizm}_{B_1}(X)$  such that  $\langle G_0, \alpha \rangle|_{i_0} = \langle G_1, \beta \rangle|_{i_1} \in \mathbf{GPrizm}_A(X)$ . Consider the following co-Cartesian square in PL:

$$\begin{array}{ccc} B_0 \sqcup_{i_0, i_1} B_1 & \xleftarrow{i'_0} & B_0 \\ \uparrow i'_1 & & \uparrow i_0 \\ B_1 & \xleftarrow{i_1} & A \end{array}$$

**Proposition 29.** *There is a unique prismatic homeomorphism*

$$F = \langle G_0 \sqcup_{i_0, i_1} G_1, \alpha \sqcup_{i_0, i_1} \beta \rangle \in \mathbf{GPrizm}_{B_0 \sqcup_{i_0, i_1} B_1}(X)$$

such that  $F|_{i'_0} = \langle G_0, \alpha \rangle$ ,  $F|_{i'_1} = \langle G_1, \beta \rangle$ .

*Proof.* By Proposition 17 on page 46, the Alexandroff presheaf  $\alpha \sqcup_{i_0, i_1} \beta$  is uniquely defined. The homeomorphism  $G_0 \sqcup_{i_0, i_1} G_1$  can be defined pointwise. Its prismaticity with respect to  $\alpha \sqcup_{i_0, i_1} \beta$  can easily be checked.  $\square$

7.1.2. *Manipulations with different prismatic structures on a fixed fiberwise homeomorphism.* A homeomorphism  $G \in \text{PL}_B(X)$  can be prismatic with respect to different Alexandroff presheaves. Here we will describe some useful manipulations with such presheaves.

Let  $(B, \mathcal{R}) \xrightarrow{\alpha} \mathbf{AI}(X)$  and  $(B, \mathcal{T}) \xrightarrow{\beta} \mathbf{AI}(X)$  be Alexandroff presheaves. We write  $\alpha \leq \beta$  if  $\mathcal{R} \leq \mathcal{T}$  and  $\alpha \geq \beta \circ w$ , where  $(B, \mathcal{R}) \xrightarrow{w} (B, \mathcal{T})$  is the morphism of weakening the topology. The definition of prismaticity implies the following proposition.

**Proposition 30.** *If a homeomorphism  $G$  is  $\beta$ -prismatic and  $\alpha \leq \beta$ , then  $G$  is  $\alpha$ -prismatic.*

Therefore all Alexandroff presheaves  $\xi$  such that  $G$  is  $\xi$ -prismatic form a poset whose minimal element is the constant Alexandroff presheaf sending the discrete topology on  $B$  to the trivial topology on  $X$ .

Consider the coordinate embeddings  $B \xrightarrow{h_0, h_1} B \times [0, 1]$  of a polyhedron  $B$  into the “faces” of the polyhedron  $B \times [0, 1]$ , where  $h_i = \text{id} \times d^i$ .

**Proposition 31.** *Let  $\mathcal{R}, \mathcal{T}$  be two Alexandroff topologies on  $B$  and  $\mathcal{R} \leq \mathcal{T}$ . Let  $(B, \mathcal{R}) \xrightarrow{w} (B, \mathcal{T})$  be the morphism of weakening the topology. Let  $\mathbf{C}$  be a subposet in  $\mathbf{AI}(X)$ . Let  $(B, \mathcal{R}) \xrightarrow{\alpha} \mathbf{C}$ ,  $(B, \mathcal{T}) \xrightarrow{\beta} \mathbf{C}$  be two Alexandroff presheaves such that  $\alpha \geq \beta \circ w$ . Let  $G \in \text{PL}_B(X)$  be  $\beta$ -prismatic. Then*

- A. *The homeomorphism  $G$  is  $\alpha$ -prismatic.*
- B. *There exist an Alexandroff topology  $\overline{\text{Cyl}}_w$  on  $B \times [0, 1]$  and an Alexandroff presheaf  $(B \times [0, 1] \overline{\text{Cyl}}_w) \xrightarrow{\overline{\text{Cyl}}_w(\alpha, \beta)} \mathbf{C}$  such that the homeomorphism  $G \times \text{id} \in \text{PL}_{B \times [0, 1]}$  is  $\overline{\text{Cyl}}_w(\alpha, \beta)$ -prismatic,  $h_0^*(G \times \text{id}, \overline{\text{Cyl}}_w(\alpha, \beta)) = (G, \alpha)$ , and  $h_1^*(G \times \text{id}, \overline{\text{Cyl}}_w(\alpha, \beta)) = (G, \beta)$ .*

*Proof.* Assertion A coincides with Proposition 30. Assertion B must be proved.

B1. We will construct the minimal base of a topology  $\overline{\text{Cyl}}_w$  on  $B \times [0, 1]$ . Define  $\mathfrak{B}(B \times [0, 1], \overline{\text{Cyl}}_w)$  as follows:

$$(36) \quad \{R \times \{0\} \cup \mathfrak{B}(w)(R) \times (0, 1]\}_{R \in B(B, \mathcal{R})} \cup \{T \times (0, 1]\}_{T \in N(B, \mathcal{T})}.$$



Using the Alexandroff theorem (see Sec. 6.1.2 on page 43), it is easy to check that  $\mathfrak{B}(B \times [0, 1], \overline{\text{Cyl}}_w)$  is indeed a minimal base. According to the construction,

$$(B \times [0, 1], \overline{\text{Cyl}}_w)|_{h_0} = (B, \mathcal{R}),$$

$$(B \times [0, 1], \overline{\text{Cyl}}_w)|_{h_1} = (B, \mathcal{T}).$$

B2. Consider the morphism  $\mathfrak{B}(w)$  defined by

$$\begin{array}{ccc} \mathfrak{B}(B, \mathcal{R}) & \xrightarrow{\mathfrak{B}(w)} & \mathfrak{B}(B, \mathcal{T}) \\ \uparrow \circ & & \uparrow \circ \\ (B, \mathcal{R}) & \xrightarrow{w} & (B, \mathcal{T}). \end{array}$$

There is a canonical isomorphism  $\mathfrak{B}(\overline{\text{Cyl}}_w) \approx \overline{\text{cyl}}_{\mathfrak{B}(w)}$ . We will present a construction of this isomorphism.

According to the construction from Proposition 19 on page 47, the Alexandroff space  $\overline{\text{cyl}}_{\mathfrak{B}(w)}$  is defined as the disjoint union

$$\{(R, 0)\}_{R \in \mathfrak{B}(B, \mathcal{R})} \cup \{(T, 1)\}_{T \in \mathfrak{B}(B, \mathcal{T})}$$

of  $\mathfrak{B}(B, \mathcal{R})$  and  $\mathfrak{B}(B, \mathcal{T})$  with the preorder

$$(U, i) \underset{\overline{\text{cyl}}_{\mathfrak{B}(w)}}{\geq} (V, j) \Leftrightarrow \begin{cases} U \supseteq V & \text{for } i = j = 0, \\ U \supseteq V & \text{for } i = j = 1, \\ \mathfrak{B}(w)(U) \supseteq V & \text{for } i = 0, j = 1. \end{cases}$$

Consider the correspondence defined by the rules  $(R, 0) \mapsto R \times \{0\} \cup \mathfrak{B}(w)(R) \times (0, 1]$  for  $R \in \mathfrak{B}(B, \mathcal{R})$ , and  $(T, 1) \mapsto T \times (0, 1]$  for  $T \in \mathfrak{B}(B, \mathcal{T})$ . One can check that this correspondence yields a required isomorphism, the diagram

$$\begin{array}{ccccc} \mathfrak{N}(B, \mathcal{R}) & \xrightarrow{\mathfrak{B}(h_0)} & \overline{\text{cyl}}_{\mathfrak{B}(w)} & \xleftarrow{\mathfrak{B}(h_1)} & \mathfrak{B}(B, \mathcal{T}) \\ \uparrow \circ & & \uparrow \circ & & \uparrow \circ \\ (B, \mathcal{R}) & \xrightarrow{h_0} & (B \times [0, 1], \overline{\text{Cyl}}_w) & \xleftarrow{h_1} & (B, \mathcal{T}) \end{array}$$

is commutative, and the diagram

$$\begin{array}{ccc}
 & \overline{\text{cyl}}_{\mathfrak{B}(w)} & \\
 \mathfrak{B}(h_0) \nearrow & & \nwarrow \mathfrak{B}(h_1) \\
 \mathfrak{B}(B, \mathcal{R}) & \xrightarrow{\mathfrak{B}(w)} & \mathfrak{B}(B, \mathcal{T})
 \end{array}$$

is exactly the universal diagram ( 24 on page 47).

B3. By the universality of the “ $o$ ” morphisms ( 20 on page 44), we can replace  $\alpha$  and  $\beta$  by unique poset morphisms

$$\mathfrak{B}(B, \mathcal{R}) \xrightarrow{\alpha'} \mathbf{C}, \quad \mathfrak{B}(B, \mathcal{T}) \xrightarrow{\beta'} \mathbf{C}$$

such that  $\alpha = \alpha' \circ o$ ,  $\beta = \beta' \circ o$ . We can verify that  $\alpha' \geq \beta' \circ \mathfrak{B}(w)$ . Next, applying Proposition 19 on page 47, we construct a morphism  $\overline{\text{cyl}}_{\mathfrak{B}(w)} \xrightarrow{\overline{\text{cyl}}_{\mathfrak{B}(w)}(\alpha', \beta')} \mathbf{C}$  and define an Alexandroff presheaf by

$$\overline{\text{Cyl}}_w(\alpha, \beta) = \overline{\text{cyl}}_{\mathfrak{B}(w)}(\alpha', \beta') \circ o.$$

B4. We must verify the  $\overline{\text{Cyl}}_w(\alpha, \beta)$ -prismaticity of the homeomorphism  $G \times \text{id}$ . It follows from the description (36) of elements of the minimal base of  $\overline{\text{Cyl}}_w$ . Proposition 19 on page 47 and the universality of  $o$ -maps guarantee that with this definition of  $\overline{\text{Cyl}}_w(\alpha, \beta)$  we have

$$h_0^*(G \times \text{id}, \overline{\text{Cyl}}_w(\alpha, \beta)) = (G, \alpha) \quad \text{and} \quad h_1^*(G \times \text{id}, \overline{\text{Cyl}}_w(\alpha, \beta)) = (G, \beta).$$

□

The following proposition can be proved similarly, with the  $\overline{\text{cyl}}$ -construction replaced by the  $\underline{\text{cyl}}$ -construction.

**Proposition 32.** *Let  $\mathcal{R}, \mathcal{T}$  be two Alexandroff topologies on  $B$  and  $\mathcal{R} \trianglelefteq \mathcal{T}$ . Let  $(B, \mathcal{R}) \xrightarrow{w} (B, \mathcal{T})$  be the morphism of weakening the topology. Let  $\mathbf{C}$  be a subset of  $\mathbf{Al}(X)$ . Let  $(B, \mathcal{R}) \xrightarrow{\alpha} \mathbf{C}$ ,  $(B, \mathcal{T}) \xrightarrow{\beta} \mathbf{C}$  be two Alexandroff presheaves and  $\alpha \trianglelefteq \beta \circ w$ . Let a homeomorphism  $G \in \text{PL}_B(X)$  be both  $\alpha$ -prismatic and  $\beta$ -prismatic.*

*Then there exist an Alexandroff topology  $\underline{\text{Cyl}}_w$  on  $B \times [0, 1]$  and an Alexandroff presheaf*

$$(B \times [0, 1] \underline{\text{Cyl}}_w) \xrightarrow{\underline{\text{Cyl}}_w(\alpha, \beta)} \mathbf{C}$$

such that the homeomorphism  $G \times \text{id} \in \text{PL}_{B \times [0,1]}$  is  $\underline{\text{Cyl}}_w(\alpha, \beta)$ -prismatic and

$$\begin{aligned} h_0^*(G \times \text{id}, \underline{\text{Cyl}}_w(\alpha, \beta)) &= (G, \alpha), \\ h_1^*(G \times \text{id}, \underline{\text{Cyl}}_w(\alpha, \beta)) &= (G, \beta). \end{aligned}$$

**Proposition 33.** *Let  $\mathcal{R}, \mathcal{T}$  be two Alexandroff topologies on  $B$ . Let  $\mathfrak{B}(B, \mathcal{R}) \xrightarrow{\phi} \mathfrak{B}(B, \mathcal{T})$  be a map such that for every  $R \in \mathfrak{B}(B, \mathcal{R})$  the inclusion  $R \subset \phi(R)$  holds. Let  $\mathbf{C} \subseteq \mathbf{Al}(X)$ , and let  $(B, \mathcal{T}) \xrightarrow{\beta} \mathbf{C}$  and  $(B, \mathcal{R}) \xrightarrow{\alpha} \mathbf{C}$  be two Alexandroff presheaves such that  $\alpha \geq \beta' \circ \phi \circ o$ . Let a homeomorphism  $G \in \text{PL}_B(X)$  be  $\beta$ -prismatic. Then*

A. *The homeomorphism  $G$  is  $\alpha$ -prismatic.*

B. *There exist an Alexandroff topology  $\widetilde{\text{Cyl}}_\phi$  on  $B \times [0, 1]$  and an Alexandroff presheaf*

$$(B \times [0, 1], \widetilde{\text{Cyl}}_\phi) \xrightarrow{\widetilde{\text{Cyl}}_\phi(\alpha, \beta)} \mathbf{C}$$

*such that the homeomorphism  $G \times \text{id} \in \text{PL}_{B \times [0,1]}$  is  $\widetilde{\text{Cyl}}_\phi(\alpha, \beta)$ -prismatic and*

$$\begin{aligned} \langle G \times \text{id}, \widetilde{\text{Cyl}}_\phi(\alpha, \beta) \rangle|_{h_0} &= \langle G, \alpha \rangle, \\ \langle G \times \text{id}, \widetilde{\text{Cyl}}_\phi(\alpha, \beta) \rangle|_{h_1} &= \langle G, \beta \rangle. \end{aligned}$$

*Proof.* A. This is obvious.

B1. Consider the common strengthening  $\mathcal{R} \vee \mathcal{T}$  of the topologies  $\mathcal{R}$  and  $\mathcal{T}$  on  $B$ . Let

$$(B, \mathcal{R}) \xleftarrow{w_0} (B, \mathcal{R} \vee \mathcal{T}) \xrightarrow{w_1} (B, \mathcal{T})$$

be the morphisms of weakening the topology.

B2.1. Consider the Alexandroff presheaves  $(B, \mathcal{R} \vee \mathcal{T}) \xrightarrow{\alpha \circ w_0} \mathbf{C}$  and  $(B, \mathcal{R} \vee \mathcal{T}) \xrightarrow{\gamma = \beta \circ w_1} \mathbf{C}$ . The homeomorphism  $G$  is both  $\alpha$ -prismatic and  $\gamma$ -prismatic. We will show that the data set  $\langle w_0, \gamma, \alpha, G \rangle$  satisfies the conditions of Proposition 32 on the preceding page. Namely, we will show that  $\gamma \leq \alpha \circ w_0$ .

B2.2. By Proposition 18 on page 47, an element  $S \in \mathfrak{B}(B, \mathcal{R} \vee \mathcal{T})$  is identified with a unique pair  $R_S \in \mathfrak{B}(B, \mathcal{R})$ ,  $T_S \in \mathfrak{B}(B, \mathcal{T})$  such that  $s(R_S) \cap s(T_S) \neq \emptyset$ ,  $R_S \cap T_S = S$ ,  $w_0(S) = R_S$ ,  $w_1(S) = T_S$ . Note that  $\phi(R_S) \supseteq T_S$ . Indeed,  $\phi(R_S) \supseteq R_S$  and  $s(T_S) \cap R_S \neq \emptyset$ , whence  $s(T_S) \cap \phi(R_S) \neq \emptyset$ . By the duality between Alexandroff topologies and preorders, this is possible only if  $\phi(R_S) \supseteq T_S$ .

B2.3. Thus  $\gamma(S) = \beta(T_S) \leq \beta(\phi(R_S)) \leq \alpha(R_S) = \alpha \circ w_0(S)$ . Therefore the data set  $\langle w_0, \gamma, \alpha, G \rangle$  satisfies the conditions of Proposition 32.

B3. By construction, the data set  $\langle w_1, \gamma, \beta, G \rangle$  satisfies the conditions of Proposition 31.

B4. We apply Proposition 32 on page 58 and construct an Alexandroff presheaf

$$(B \times [0, 1], \underline{\text{Cyl}}_{w_0}) \xrightarrow{\text{Cyl}_{w_0}(\gamma, \alpha)} \mathbf{C}.$$

We apply Proposition 31 on page 56 and construct an Alexandroff presheaf

$$(B \times [0, 1], \overline{\text{Cyl}}_{w_1}) \xrightarrow{\overline{\text{Cyl}}_{w_1}(\gamma, \beta)} \mathbf{C}.$$

Consider the following diagram of embeddings in PL:

$$B \times [0, 1] \xleftarrow{h_0} B \xrightarrow{h_0} B \times [0, 1].$$

We obtain a condition on prismatic homeomorphisms:

$$\langle G \times \text{id}, \underline{\text{Cyl}}_{w_0}(\gamma, \alpha) \rangle|_{h_0} = \langle G, \gamma \rangle = \langle G \times \text{id}, \overline{\text{Cyl}}_{w_1}(\gamma, \beta) \rangle|_{h_0}.$$

By Propositions 17 on page 46 and 29 on page 55, the pastings are defined. We put

$$\begin{aligned} \widetilde{\text{Cyl}}_\phi &= \underline{\text{Cyl}}_{w_0} \sqcup_{h_0, h_0} \overline{\text{Cyl}}_{w_1}, \\ \widetilde{\text{Cyl}}_\phi(\alpha, \beta) &= \underline{\text{Cyl}}_{w_0}(\gamma, \alpha) \sqcup_{h_0, h_0} \overline{\text{Cyl}}_{w_1}(\gamma, \beta). \end{aligned}$$

The pasted homeomorphism  $G \times [0, 1] \sqcup_{h_0, h_0} G \times [0, 1]$  is automatically  $\widetilde{\text{Cyl}}_\phi(\alpha, \beta)$ -prismatic.  $\square$

**7.2. Triangulation of a fiberwise homeomorphism.** Let  $G \in \text{PL}_B(X)$  and  $\mathbf{C} \subset \mathbf{Al}(X)$ . Let  $f$  be a  $\mathbf{C}$ -coloring of  $B$ . We call  $f$  a  **$\mathbf{C}$ -triangulation of  $G$**  if  $G$  is Max  $f$ -prismatic (see ( 26 on page 50)). In particular, according to the remark from Sec. 7.0.3 on page 55, for a  $\mathbf{Q}$ -prismatic homeomorphism  $G \in \text{PL}_k(X)$ , the chain  $\mathbf{Q}$  is a special case of an  $\mathbf{R}(X)$ -triangulation of  $G$ . If  $|K| = B$  and  $K \xrightarrow{\mathcal{Q}} \mathcal{NR}(X)$  is an  $\mathbf{R}(X)$ -triangulation of  $G$ , then for every simplex  $s \in K$  the homeomorphism  $G|_s$  is  $\mathcal{Q}|_s$ -prismatic in the sense of the definition from Sec. 3.2.2.

**Proposition 34.** *Assume that  $(Y, Z)$  is a pair of closed polyhedra,  $G \in \text{PL}_Y(X)$ ,  $\mathcal{T}$  is a CPL Alexandroff topology on  $Y$ ,  $\mathcal{T}|_Z$  is the induced topology on  $Z$ ,  $\mathbf{C} \subset \mathbf{Al}(X)$ , and  $(X, \mathcal{T}) \xrightarrow{\xi} \mathbf{C}$  is an Alexandroff presheaf such that  $G$  is  $\xi$ -prismatic. Let  $f_Z$  be a triangulation of  $\xi|_Z$  that is a triangulation of  $G|_Z$ . Then there is a triangulation  $f$  of  $\xi$  that extends  $f_Z$  and triangulates  $G$ .*

*Proof.* This is a corollary of Proposition 24 on page 51 and Proposition 31(A), on page 56.  $\square$

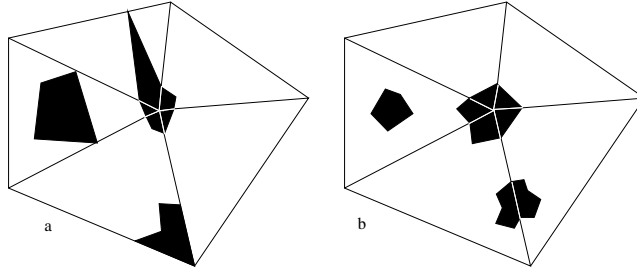

FIGURE 11.

8. BALL COMPLEXES COMPATIBLE WITH DISJOINT CONFIGURATIONS OF BALLS

8.1. We need to introduce some general definitions and notations. Let  $A$  be a subset of a set  $S$ . With  $A$  we associate the Alexandroff topology  $\mathcal{D}_A$  on  $S$  with the minimal base  $\{A\} \cup \{s\}_{s \in S \setminus A}$ . Obviously, if  $A, B \subseteq S$  and  $A \subseteq B$ , then  $\mathcal{D}_A \leq \mathcal{D}_B$ . Therefore

$$(37) \quad 2^S \xrightarrow{\mathcal{D}} \mathbf{Al}(S)$$

is an embedding of posets.

Denote by  $\mathbf{D}(X)$  the poset of all balls of full dimension on a manifold  $X$ . The order is defined as follows:

$$D_0 \underset{\mathbf{D}(X)}{<} D_1 \Leftrightarrow D_0 \subset \text{int } D_1.$$

Denote by  $\mathbf{D}^\infty(X)$  the poset of all finite sets of disjoint closed full-dimensional balls on  $X$ . The order is defined as follows:

$$A_0 \underset{\mathbf{D}^\infty(X)}{<} A_1 \Leftrightarrow \cup_{D \in A_0} D \subset \cup_{D \in A_1} \text{int } D.$$

Let  $K$  be a simplicial manifold. The simplicial structure generates a locally conic structure on  $|K|$  (see [31]). We say that a closed ball  $B \subset |K|$  is **consistent** with  $K$  if and only if

- (i) it is full-dimensional and conic,
- (ii) it has the following property: if  $B \cap s \neq \emptyset$  for some  $s \in K$ , then  $\text{int } B \cap s \neq \emptyset$ .

The balls shown in Fig. 11 (a) are conic with respect to the triangulation, but condition (ii) is violated. The balls shown in Fig. 11 (b) satisfy condition (ii).

By  $\mathbf{D}_c^\infty(K)$  we denote the subposet of  $\mathbf{D}^\infty(|K|)$  formed by all configurations of disjoint closed balls consistent with  $K$ . The functor  $\mathcal{D}$  identifies the posets  $\mathbf{D}(X)$ ,  $\mathbf{D}^\infty(X)$ ,  $\mathbf{D}_c^\infty(K)$  with subposets of  $\mathbf{Al}(X)$ .

8.2. We will need the following proposition.

**Proposition 35.** *Let  $P$  be a finite poset, and let  $P \xrightarrow{\phi} \mathbf{D}_c^\infty(K)$  be a poset morphism. Then there exists a morphism  $P \xrightarrow{\xi} \mathbf{D}_c^\infty(K)$  such that  $\xi(p) > \phi(p)$  for every  $p \in P$ , i.e., for every  $p$ , every ball from  $\phi(p)$  belongs to the interior of some ball from  $\xi(p)$ .*

*Proof.* We use the finiteness of  $P$ . By induction on decreasing ranks, we can replace configurations of conic balls with configurations of small conic neighborhoods of these balls.  $\square$

8.3. As usual, let  $X$  be an  $n$ -dimensional compact manifold. Let  $\mathbf{Q} \in \mathbf{R}(X)$  be a ball complex on  $X$ . Let  $K$  be a triangulation of  $X$ ,  $K \trianglelefteq \mathbf{Q}$ , and  $\mathbf{D} \in \mathbf{D}_c^\infty(K)$ . We say that the configuration of balls  $\mathbf{D}$  **is inscribed into**  $\mathbf{Q}$  if the interior of any ball from  $\mathbf{D}$  is contained in the interior of an  $n$ -ball from  $\mathbf{Q}$ . We say that a subdivision  $\mathbf{Q}_0 \trianglelefteq \mathbf{Q}$  **does not touch**  $\mathbf{D}$  if for every ball  $D \in \mathbf{D}$  the equality  $\mathbf{Q}_0|_{\text{int } D} = \mathbf{Q}|_{\text{int } D}$  holds.

**Proposition 36.** *Let  $\mathbf{Q} \in \mathbf{R}(X)$  be a ball complex and  $K \trianglelefteq \text{sd}_1 \mathbf{Q}$ . Let  $B$  be a ball consistent with  $K$  with conic vertex  $b$ . Then there exists a structure of a ball complex  $\mathbf{C}(B)$  on  $B$  such that the set of all balls of  $\mathbf{C}(B)$  is the union of two disjoint sets  $\text{IC}(B)$  and  $\text{SC}(B)$  and the following properties are satisfied:*

- the balls from  $\text{SC}(B)$  form a ball complex on  $\partial B$ ;
- the balls from  $\text{IC}(B)$  are the balls touching  $\text{int } B$ ; and
- for every ball  $D \in \text{IC}(B)$  there exists a ball  $D' \in \mathbf{Q}$  such that  $D \cap \text{int } B = D' \cap \text{int } B$ .

*Proof.* 1. By the consistency condition, for every ball  $Q \in \mathbf{Q}$  the intersection  $Q \cap B$  is empty if  $b \notin Q$ .

2. Consider the set  $\widetilde{\text{star}}_{\mathbf{Q}} b$  of all balls of  $\mathbf{Q}$  containing the point  $b$ . In the set  $\widetilde{\text{star}}_{\mathbf{Q}} b$  there is a unique ball  $A$  such that  $b \in \text{relint } A$ . By the theorem on invariance of PL stars, the following is true: for every  $D \in \widetilde{\text{star}}_{\mathbf{Q}} b$  the intersection  $D \cap B$  is a ball that is a cone over  $S(D) = \partial B \cap D$ . Here  $S(D)$  is a ball when  $D \neq A$ , and a sphere when  $D = A$ . For every  $Q \in \widetilde{\text{star}}_{\mathbf{Q}} b$  put  $I(Q) = B \cap Q$ ,  $S(Q) = \partial B \cap Q$ .

3. Put  $\text{IW}(B) = \{I(Q)\}_{Q \in \widetilde{\text{star}}_{\mathbf{Q}} b}$ . Put  $\text{SW}(B) = \{S(Q)\}_{Q \in \widetilde{\text{star}}_{\mathbf{Q}} b}$ . Consider the collection of closed subsets  $\mathbf{W}(B) = \text{IW}(B) \cup \text{SW}(B)$ . It has the following properties. The collection  $\mathbf{W}(B)$  is a cover of  $B$  by closed subsets. The interiors of the elements of  $\mathbf{W}(B)$  form a partition of  $B$ . The boundary of every element of  $\mathbf{W}(B)$  is formed by elements of the cover. All the elements except  $S(A)$  are balls. If we remove  $S(A)$  from  $\mathbf{W}(B)$  and replace it by the set  $\text{TS}(A)$  of simplices of any triangulation of  $S(A)$ ,

then we will obtain a ball complex  $C(B)$  on  $B$ . By construction, the decomposition  $IC(B) = IW(B)$ ,  $SC(B) = (SW(B) \setminus S(A)) \cup TS(A)$  is what was promised in the statement of the proposition.  $\square$

**Lemma 6** (Functorially inscribing disjoint configurations of balls into ball complexes). *Let  $\Lambda$  be a finite poset. Consider a poset morphism  $\Lambda \xrightarrow{\mathcal{Q}} \mathbf{R}(X)$ . Choose a triangulation  $K$  of the common subdivision of all  $\mathcal{Q}_\lambda: K \trianglelefteq \mathcal{Q}_\lambda$  for every  $\lambda \in \Lambda$ . Let  $\Lambda \xrightarrow{\xi} \mathbf{D}_c^\infty(K)$  be a morphism. Then there exist a pair of morphisms  $\Lambda \xrightarrow{\mathcal{Q}_0, \mathcal{Q}_1} \mathbf{R}(X)$  and a pair of natural transformations  $\mathcal{Q} \xleftarrow[\trianglelefteq]{\alpha} \mathcal{Q}_0 \xrightarrow[\trianglelefteq]{\beta} \mathcal{Q}_1$  such that for every  $\lambda \in \Lambda$  the subdivisions  $\alpha_\lambda$  do not touch the balls from  $\xi(\lambda)$  and the configuration of balls  $\xi(\lambda)$  is inscribed into  $\mathcal{Q}_1(\lambda)$ .*

*Proof.* 1. First note the following fact. Let  $L$  be a ball complex on the manifold  $X^n$ . Let  $B \subseteq L$  be a cellular embedded ball complex on an  $n$ -ball. Let us do the following: delete from  $L$  all balls that touch the interior of  $|B|$  and then add the ball  $|B|$  itself. This operation gives a new ball complex on  $X^n$ . Denote it by  $L/B$ . By definition, there is a canonical subdivision  $L \trianglelefteq L/B$ . Similarly, if in  $L$  we have a configuration of subcomplexes on disjoint  $n$ -balls  $\{B_1, \dots, B_l\}$ , then the ball complex  $L/\{B_1, \dots, B_l\}$  is well-defined:

$$L \trianglelefteq L/\{B_1, \dots, B_l\} = (\dots((L/B_1)/B_2)/B_3 \dots)/B_l.$$

2. Assume that the poset  $\Lambda$  is of rank  $r$ . Let

$$\Lambda^r \hookrightarrow \Lambda^{r-1} \hookrightarrow \dots \hookrightarrow \Lambda^0 = \Lambda$$

be a filtration of  $\Lambda$  by subposets, where the subposet  $\Lambda^k$  is formed by all elements of  $\Lambda$  of rank at least  $k$ . Denote by  $\mathcal{Q}^k$  the restriction  $\mathcal{Q}|_{\Lambda^k}$ .

We construct natural transformations  $\mathcal{Q} \xleftarrow[\triangleright]{\alpha} \mathcal{Q}_0 \xrightarrow[\triangleleft]{\beta} \mathcal{Q}_1$  inductively on the inverse rank filtration

$$\begin{array}{ccccc}
 \mathcal{Q}^r & \xleftarrow[\triangleright]{\alpha^r} & \mathcal{Q}_0^r & \xrightarrow[\triangleleft]{\beta^r} & \mathcal{Q}_1^r \\
 \uparrow & & \uparrow & & \uparrow \\
 \mathcal{Q}^{r-1} & \xleftarrow[\triangleright]{\alpha^{r-1}} & \mathcal{Q}_0^{r-1} & \xrightarrow[\triangleleft]{\beta^{r-1}} & \mathcal{Q}_1^{r-1} \\
 \vdots & & \vdots & & \vdots \\
 \mathcal{Q}^0 & \xleftarrow[\triangleright]{\alpha^0} & \mathcal{Q}_0^0 & \xrightarrow[\triangleleft]{\beta^0} & \mathcal{Q}_1^0 \\
 \parallel & & \parallel & & \parallel \\
 \mathcal{Q} & \xleftarrow[\triangleright]{\alpha} & \mathcal{Q}_0 & \xrightarrow[\triangleleft]{\beta} & \mathcal{Q}_1.
 \end{array}$$

3. Let  $\lambda \in \Lambda^r$ . For  $\mathcal{Q}(\lambda)$  we construct a diagram

$$\mathcal{Q}(\lambda) \triangleright \mathcal{Q}_0(\lambda) \triangleleft \mathcal{Q}_1(\lambda),$$

which will provide the  $\alpha^r(\lambda), \beta^r(\lambda)$ -components of required natural transformations. Pick linear triangulations of the spherical ball complexes  $\partial\mathcal{C}_{\mathcal{Q}(\lambda)}(D)$ ,  $D \in \xi(\lambda)$ , where  $\mathcal{C}_{\mathcal{Q}(\lambda)}(D)$  are constructed by Proposition 36. As a result, we obtain some subdivisions of the ball complexes  $\mathbb{T}(D) \triangleleft \mathcal{C}_{\mathcal{Q}(\lambda)}(D)$ ,  $D \in \xi(\lambda)$ , affecting only the boundary spheres. Then we extend the geometric simplicial complexes  $\partial\mathbb{T}(D)$ ,  $D \in \xi(\lambda)$ , to a triangulation of  $X \setminus \cup_{D \in \xi(\lambda)} \text{int } D$  subdividing all subpolyhedra  $B \setminus \cup_{D \in \xi(\lambda)} \text{int } D$ ,  $B \in \mathcal{Q}(\lambda)$ . We obtain a subdivision  $\mathcal{Q} \triangleright \mathcal{Q}_0(\lambda)$  that does not touch the balls of  $\xi(\lambda)$ . Here  $\mathbb{T}(D)$ ,  $D \in \xi(\lambda)$ , are balls embedded into  $\mathcal{Q}_0(\lambda)$ . By Step 1 of the proof, we set

$$\mathcal{Q}_0(\lambda) \triangleleft \mathcal{Q}_0(\lambda) / \{\mathbb{T}(D)\}_{D \in \xi(\lambda)} = \mathcal{Q}_1(\lambda).$$

By construction, the balls of  $\xi(\lambda)$  are inscribed into  $\mathcal{Q}_1(\lambda)$ . Constructing

$$\mathcal{Q}(\lambda) \triangleright \mathcal{Q}_0(\lambda) \triangleleft \mathcal{Q}_1(\lambda)$$

for all  $\lambda \in \Lambda^r$ , we obtain  $\mathcal{Q}^r \xleftarrow[\triangleright]{\alpha^r} \mathcal{Q}_0^r \xrightarrow[\triangleleft]{\beta^r} \mathcal{Q}_1^r$ .

4. *Inductive step.* Assume that  $\mathcal{Q}^{k+1} \xleftarrow[\triangleright]{\alpha^{k+1}} \mathcal{Q}_0^{k+1} \xrightarrow[\triangleleft]{\beta^{k+1}} \mathcal{Q}_1^{k+1}$  is constructed. Let us extend the construction to  $\Lambda^k$ . Let  $\lambda \in \Lambda$ ,  $\text{rank } \lambda = k$ . Consider the upper ideal  $\lambda^{\leq} = \{\mu \in \Lambda \mid \lambda \leq \mu\}$ .



Choose some linear triangulations of the spherical simplicial complexes  $\partial\mathcal{C}_{\mathcal{Q}(\lambda)}(D)$ ,  $D \in \xi(\lambda)$ . Thus we obtain some subdivisions  $\mathbb{T}(D) \trianglelefteq \mathcal{C}_{\mathcal{Q}(\lambda)}(D)$ ,  $D \in \xi(\lambda)$ , affecting only the boundary spheres. Extend the geometric simplicial complexes  $\partial\mathbb{T}(D)$ ,  $D \in \xi(\lambda)$ , to a triangulation  $X \setminus \cup_{D \in \xi(\lambda)} \text{int } D$  subdividing all subpolyhedra  $B \setminus \cup_{D \in \xi(\lambda)} \text{int } D$ , where  $B \in \mathcal{Q}_0(\mu)$ ,  $\mu \in \lambda^{\leq}$ . We obtain a subdivision  $\mathcal{Q}(\lambda) \trianglelefteq \mathcal{Q}_0(\lambda)$  that does not touch the balls of  $\xi(\lambda)$ . Here  $\mathbb{T}(D)$ ,  $D \in \xi(\lambda)$ , are balls embedded into  $\mathcal{Q}_0(\lambda)$ . By Step 1 of the proof, we set

$$\mathcal{Q}_0(\lambda) \trianglelefteq \mathcal{Q}_0(\lambda) / \{\mathbb{T}(D)\}_{D \in \xi(\lambda)} = \mathcal{Q}_1(\lambda).$$

By construction, the balls of  $\xi(\lambda)$  are inscribed into  $\mathcal{Q}_1(\lambda)$ . We need to verify that for every  $\lambda \leq \mu$ , the following commutative diagram of subdivisions of ball complexes holds:

$$\begin{array}{ccccc} \mathcal{Q}(\mu) & \xleftarrow{\trianglelefteq} & \mathcal{Q}_0(\mu) & \xrightarrow{\trianglelefteq} & \mathcal{Q}_1(\mu) \\ \trianglelefteq \uparrow & & \trianglelefteq \uparrow & & \trianglelefteq \uparrow \\ \mathcal{Q}(\lambda) & \xleftarrow{\trianglelefteq} & \mathcal{Q}_0(\lambda) & \xrightarrow{\trianglelefteq} & \mathcal{Q}_1(\lambda). \end{array}$$

It suffices to check that  $\mathcal{Q}_0(\lambda)$  indeed subdivides  $\mathcal{Q}_0(\mu)$  and  $\mathcal{Q}_1(\lambda)$  indeed subdivides  $\mathcal{Q}_1(\mu)$ . Here it helps that  $\xi(\mu) \geq \xi(\lambda)$  in the sense of the order on  $\mathbf{D}_c^\infty(K)$ . Thus  $\mathcal{Q}_0(\mu)|_{\text{int } B} = \mathcal{Q}(\mu)|_{\text{int } B}$  for  $B \in \xi(\lambda)$ , because  $\alpha(\mu)$  does not touch balls from  $\xi(\mu)$ , and hence it does not touch balls from  $\xi(\lambda)$ . Therefore  $\mathcal{Q}_0(\lambda)|_B \trianglelefteq \mathcal{Q}_0(\mu)|_B$  for  $B \in \xi(\lambda)$ . By construction, on the complements of balls from  $\text{int } \xi(\lambda)$  we also have a subdivision. Therefore the whole  $\mathcal{Q}_0(\lambda)$  indeed subdivides  $\mathcal{Q}_0(\mu)$ . Similar arguments show that  $\mathcal{Q}_1(\lambda)$  subdivides  $\mathcal{Q}_1(\mu)$ .  $\square$

We can develop a slightly more refined version of Proposition 36 for the case of triangulations rather than general ball complexes.

**Proposition 37.** *Let  $\mathcal{Q} \in \mathbf{T}(X)$ ,  $K \trianglelefteq \text{sd}_1 \mathcal{Q}$ . Let  $B$  be a closed  $K$ -consistent  $n$ -ball with conic vertex  $b$ . Let  $B_0, B_1$  be two other closed  $K$ -consistent balls with conic vertex  $b$  such that  $B \subset \text{int } B_1$ ,  $B_1 \subset \text{int } B_0$ .*

*Under these conditions, there exist two PL triangulations  $\mathbf{E}_0 B_0, \mathbf{E}_1 B_0$  of  $B_0$  such that*

- (a)  $\mathbf{E}_0 B_0 \trianglelefteq \mathcal{C}_{\mathcal{Q}} B_0$ , where  $\mathcal{C}_{\mathcal{Q}} B_0$  is constructed by Proposition 36,
- (b)  $\mathbf{E}_0 B_0|_{\text{int } B} = \mathcal{Q}|_{\text{int } B}$ ,
- (c)  $\mathbf{E}_0 B_0 \trianglelefteq \mathbf{E}_1 B_0$ ,  $\partial \mathbf{E}_0 B_0 = \partial \mathbf{E}_1 B_0$ ,
- (d)  $\mathbf{E}_1 B_0|_{B_1} \underset{\text{PL}}{\approx} [\Delta^n]$ .

*Proof.* See Fig. 12.

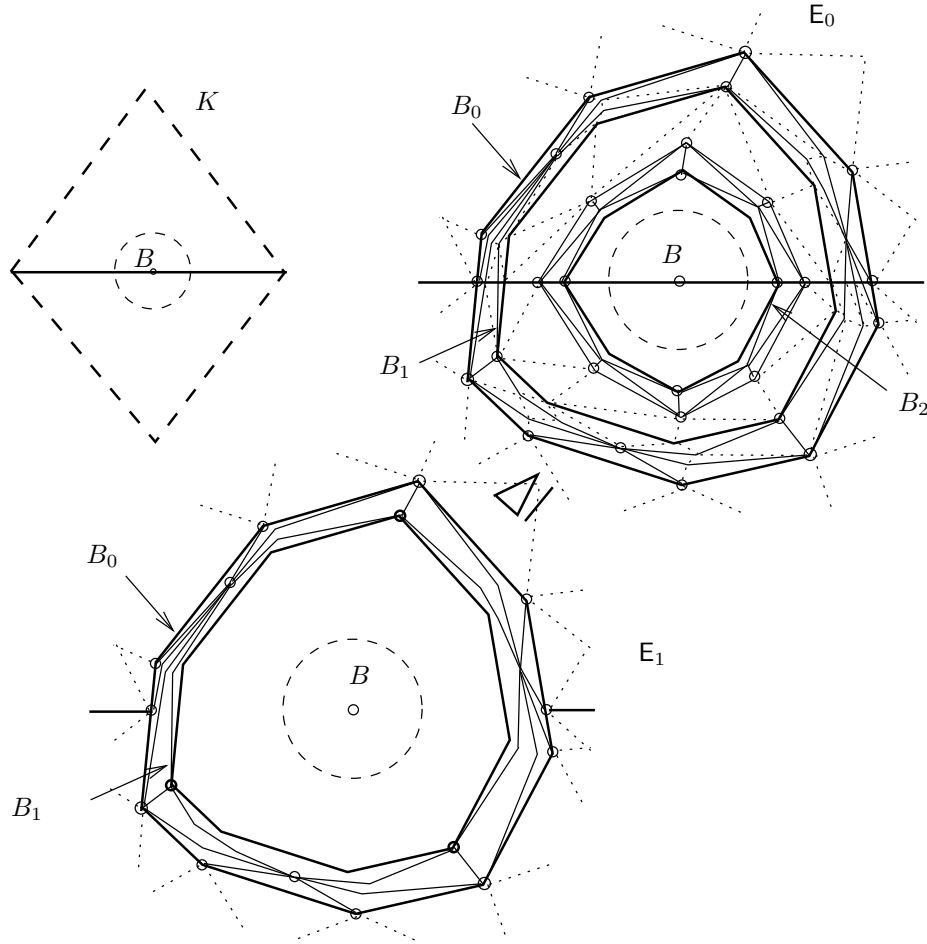

FIGURE 12.

1. First, by Proposition 36, we construct a ball complex  $C_Q B_0$  and linearly triangulate its boundary. This will be the linear triangulation  $T_0 = \partial E_0 B_0 = \partial E_1 B_0$ . Next we map  $[\Delta^n]$  onto  $B_1$  piecewise linearly. Denote by  $T_1$  the resulting triangulation of  $B_1$  by the simplex. Construct a PL triangulation of the annulus  $B^0 \setminus \text{int } B^1$  extending  $T_0$  and  $\partial T_1$  on the borders. Thus we obtain  $E_1 B_0$  satisfying (d).

2. Now we construct  $E_0 B_0$  satisfying (a), (b), (c). We need one more  $\mathcal{K}$ -consistent ball  $B_2$  with conic vertex  $b$  such that  $B \subset \text{int } B_2$ ,  $B_2 \subset \text{int } B_1$ . Using the pseudoradial projection with center at  $b$  in  $\mathbb{Q}$  both onto  $B$  and onto  $B_2$ . Thus we obtain two triangulations  $T_2 B_2$  and  $T B$  such that  $T|_{\text{int } B} = Q|_{\text{int } B}$  and  $T_2|_{\text{int } B_2} = Q|_{\text{int } B}$ . Then we take an arbitrary PL triangulation of  $B_0 \setminus \text{int } B_2$  that coincides with  $T_0$  on  $\partial B_0$  and subdivides  $E_1$  and  $D \cap B_0 \setminus \text{int } B_2$  for all  $D \in \mathcal{Q}$ .

We obtain a triangulation  $T_{0,2}$  on  $B_0 \setminus \text{int } B_2$ . Further, we can extend  $T_{0,2}$  to a triangulation  $T'_2$  of  $B_2$  such that  $\partial T'_2 = T_{0,2}|_{\partial B_2}$ ,  $T'_2|_{B_0} = T$ , and  $T'_2 \trianglelefteq T^2$ . Pasting  $T_{0,2}$  and  $T_2$  by the common part, we obtain  $E_0 B_0$ .  $\square$

**Lemma 7** (Functorially inscribing disjoint configurations of balls into combinatorial manifolds). *Let  $\Lambda$  be a finite poset. Consider a poset map  $\Lambda \xrightarrow{\mathcal{K}} \mathbf{T}(X)$ . Choose a triangulation  $K$  of the common subdivision of all  $\mathcal{K}_\lambda$ :  $K \trianglelefteq \mathcal{K}_\lambda$  for all  $\lambda \in \Lambda$ . Let  $\Lambda \xrightarrow{\xi} \mathbf{D}_c^\infty(K)$  be a morphism. Then there exist a pair of morphisms  $\Lambda \xrightarrow{\mathcal{K}_0, \mathcal{K}_1} \mathbf{T}(X)$  and a pair of natural transformations  $\mathcal{K} \xleftarrow[\trianglelefteq]{\alpha} \mathcal{K}_0 \xrightarrow[\trianglelefteq]{\beta} \mathcal{K}_1$  such that for every  $\lambda \in \Lambda$  the subdivisions  $\alpha_\lambda$  do not touch the balls from  $\xi(\lambda)$  and the configuration of balls  $\xi(\lambda)$  is inscribed into  $\mathcal{K}_1(\lambda)$ .*

*Proof.* The proof repeats the proof of Lemma 6, with the construction from Proposition 36 replaced by the construction from Proposition 37.  $\square$

8.4. Now we are able to formulate and prove one of our key lemmas on surgery of prismatic homeomorphisms.

**Lemma 8.** *Let  $Y$  be a finite simplicial complex,  $Y = |Y|$ . Let  $Z \subseteq Y$  be a subcomplex of  $Y$ ,  $Z = |Z|$ .*

*Let  $G_1, \dots, G_m, U \in \text{PL}_Y(X)$ . Let  $\mathcal{Q}$  be an  $\mathbf{R}(X)$ -coloring of  $Y$ , which induces a coloring  $\mathcal{Q}_Z$  of  $Z$ .*

*Let  $K$  be a common triangulation of all complexes  $\{\mathcal{Q}\}_{\mathcal{Q} \in \text{Max } \mathcal{Q}(y), y \in Y}$ .*

*Let  $\mathcal{T}$  be an OPL Alexandroff topology on  $Y$ . Let  $(Y, \mathcal{T}) \xrightarrow{\xi} \mathbf{D}_c^\infty(K)$  be an Alexandroff presheaf.*

*Assume that the coloring  $\mathcal{Q}$  is an  $\mathbf{R}(X)$ -triangulation of  $G_1, \dots, G_m$  and the coloring  $\mathcal{Q}_Z$  is an  $\mathbf{R}(X)$ -triangulation of  $U|_Z$ .*

*Assume that the homeomorphisms  $G_1, \dots, G_m, U$  are also  $\xi$ -prismatic.*

*Consider the ball complex  $Y \times [I]$  and its subcomplex  $\Pi = Z \times [I] \cup Y \times \{1\}$ .*

*Under these conditions, there exist a triangulation  $U \trianglelefteq Y \times I$  and an  $\mathbf{R}(X)$ -coloring  $\tilde{\mathcal{Q}}$  of this triangulation such that*

- $\tilde{\mathcal{Q}}|_{Y \times \{0\}} \trianglelefteq \mathcal{Q}$ ,
- $\tilde{\mathcal{Q}}$  triangulates  $\tilde{G}_1, \dots, \tilde{G}_m$ , where  $\tilde{G}_i = G_i \times \text{id} \in \text{PL}_{Y \times I}(X)$ ,
- $\tilde{\mathcal{Q}}|_\Pi$  triangulates  $\tilde{U}|_\Pi$ , where  $\tilde{G}_i = G \times \text{id} \in \text{PL}_{Y \times I}(X)$ ,  $\tilde{U} = U \times \text{id} \in \text{PL}_{Y \times I}(X)$ .

*Proof.* 1. First we mention a general fact: if a CPL Alexandroff topology  $\mathcal{T}'$  on  $Y$  strictly approximates (see Sec. 6.8 on page 53) an OPL Alexandroff topology  $\mathcal{T}$  and  $(Y, \mathcal{T}') \xrightarrow{\xi'} \mathbf{D}_c^\infty(K)$  is the induced morphism, then any  $\xi$ -prismatic homeomorphism  $f \in \text{PL}_Y(X)$  is  $\xi'$ -prismatic. By Proposition 26 on page 53, there always exists a strict approximation  $\mathcal{T}'$  for  $\mathcal{T}$ . Let us fix such an approximation.

2. Now pick the common strengthening  $\mathcal{A}^c(\mathbf{Y}) \vee \mathcal{T}'$  of the CPL topologies  $\mathcal{A}^c(\mathbf{Y})$  and  $\mathcal{T}'$ . The canonic weakening morphisms are

$$(Y, \mathcal{A}^c(\mathbf{Y})) \xleftarrow{\varphi_{\mathcal{A}^c(\mathbf{Y})}} (Y, \mathcal{A}^c(\mathbf{Y}) \vee \mathcal{T}') \xrightarrow{\varphi_{\mathcal{T}'}} (Y, \mathcal{T}').$$

Consider the map

$$(Y, \mathcal{A}^c(\mathbf{Y}) \vee \mathcal{T}') \xrightarrow{\gamma = (\text{MaxQ} \circ \varphi_{\mathcal{A}^c(\mathbf{Y})}) \times (\xi' \circ \varphi_{\mathcal{T}'})} \mathbf{R}(X) \times \mathbf{D}_c^\infty(K).$$

In this situation, by Proposition 25 on page 51, there is a finite poset  $O$  such that  $\text{Ord}(O)$  linearly triangulates  $Y$ ,  $|\text{Ord}(O)| = Y$ , the topology  $\mathcal{A}^c(\mathbf{Y}) \vee \mathcal{T}'$  is weaker than  $\mathcal{A}^c(\text{Ord}(O))$ , and the commutative diagram of solid arrows

$$\begin{array}{ccc} (Y, \mathcal{A}^c(\text{Ord}(O))) & \longrightarrow & (Y, \mathcal{A}^c(\mathbf{Y}) \vee \mathcal{T}') \\ \downarrow \varkappa(O) & & \downarrow \gamma \\ O & \xrightarrow{P_R \times P_D} & \mathbf{R}(X) \times \mathbf{D}_c^\infty(K) \end{array}$$

can be uniquely completed by a dashed arrow. (Here the top arrow

$$(Y, \mathcal{A}^c(\text{Ord}(O))) \longrightarrow (Y, \mathcal{A}^c(\mathbf{Y}) \vee \mathcal{T}')$$

is the morphism of weakening the topology.)

3. Now, by Lemma 6 on page 63, we can build a pair of functors  $O \xrightarrow{P_0, P_1} \mathbf{R}(X)$  and a pair of natural transformations  $P_R \xleftarrow[\geq]{\alpha} P_0 \xrightarrow[\leq]{\beta} P_1$  such that for every  $o \in O$ , the subdivision  $\alpha_o$  does not touch the balls from  $P_D(o)$  and the configuration  $P_D(o)$  is inscribed into  $P_1(o)$ .

4. Now for  $\alpha$  and  $\beta$  we can use the arguments from Sec. 6.7.4 on page 52. By pasting together the two colorings  $[\text{ord}O \times \mathbf{1}] \xrightarrow{\Xi(\alpha)} \mathbf{R}(X)$  and  $[\text{ord}O \times \mathbf{1}] \xrightarrow{\Xi(\beta)} \mathbf{R}(X)$  on  $Y \times [0, \frac{1}{2}, 1]$ , we obtain the required  $\mathbf{U}$  and  $\tilde{\mathbf{Q}}$ .  $\square$

9. NONFIBERWISE DEFORMATIONS OF FIBERWISE HOMEOMORPHISMS

Our key tool is a set of lemmas on fragmentation of fiberwise homeomorphisms of the trivial fiber bundle over the cube.

9.1. **The operation  $\rtimes$ .** Let  $H \in \text{PL}_B(X)$  be a fiberwise homeomorphism of the trivial bundle with fiber  $X$  and base  $B$ :  $H(x, b) = (H|_b(x), b)$ . Consider a map  $X \times C \xrightarrow{F} X \times B$  that is fiberwise with respect to the projection to  $X$ :  $F(x, c) = (x, F|_x(c))$ . With the pair

$$\begin{array}{ccc} X \times C & \xrightarrow{F} & X \times B, \\ \pi_1 \searrow & & \swarrow \pi_1 \\ & X & \end{array} \quad \begin{array}{ccc} X \times B & \xrightarrow{H} & X \times B \\ \pi_1 \searrow & & \swarrow \pi_1 \\ & B & \end{array}$$

we associate a map

$$\begin{array}{ccc} X \times C & \xrightarrow{F \rtimes H} & X \times C \\ \pi_1 \searrow & & \swarrow \pi_1 \\ & C & \end{array}$$

that is fiberwise with respect to the projection to  $C$ . The map  $F \rtimes H$  is defined by the following correspondence:

$$(38) \quad (x, c) \xrightarrow{F \rtimes H} (H|_{(F|_x(c))}(x), c).$$

Generally,  $F \rtimes H$  is only a fiberwise map, but not a homeomorphism.

9.2. Consider a special case of the construction  $\rtimes$ . Consider the following embedding:

$$X \times B \xrightarrow{i^0 = \text{id} \times \text{id} \times d^0} X \times B \times I.$$

Let  $X \times B \times I \xrightarrow{F} X \times B$  be a map that is fiberwise with respect to the projection to  $X$  and such that  $F \circ i^0 = \text{id}$ . Let  $H \in \text{PL}_B(X)$ . Let  $h_t$  be the embedding  $B \xrightarrow{h_t} B \times I$  defined by  $h_t(b) = (b, t)$ . The map  $(F \rtimes H)|_{h_t}: X \times B \rightarrow X \times B$  induced by  $h_t$  is fiberwise with respect to the projection to  $B$ . Generally, this is not a homeomorphism when  $t \neq 0$ . But if  $t = 0$ , it follows from the construction that  $(F \rtimes H)|_{h_0} \equiv H$ . In this situation,  $F \rtimes H$  is a one-parameter deformation of  $H$  in the class of fiberwise maps.

**9.3. Prismaticity properties of the operation  $\rtimes$ .** Let  $(B, B^{\text{triv}}) \xrightarrow{\delta_{\mathcal{L}}} \mathbf{Al}(X)$  be the Alexandroff presheaf that sends the whole  $B$  to the Alexandroff topology  $\mathcal{L}$  on  $X$ . Let  $H$  be a homeomorphism that is prismatic with respect to  $\delta_{\mathcal{L}}$ . By the definition from Sec. 7.0.2 on page 54, we have the topology  $\mathcal{L}' = H^{-1}\mathcal{L}$  and the morphism  $(B, B^{\text{triv}}) \xrightarrow{H^{-1}\delta'_{\mathcal{L}}} \mathbf{Al}(X)$  that sends the whole  $B$  to  $\mathcal{L}'$ . In this situation, for every  $b \in B$  the map  $(X, \mathcal{L}) \xrightarrow{H^{-1}|_b} (X, \mathcal{L}')$  is a homeomorphism of Alexandroff spaces that induces a constant (independent of  $b$ ) isomorphism  $\mathfrak{B}(X, \mathcal{L}) \xrightarrow{\tilde{H}^{-1}} \mathfrak{B}(X, \mathcal{L}')$ .

**Proposition 38.** *Let  $\mathcal{L}$  be an Alexandroff topology on  $X$ . Let  $H$  be prismatic with respect to the constant Alexandroff presheaf  $(B, B^{\text{triv}}) \xrightarrow{\delta_{\mathcal{L}}} \mathbf{Al}(X)$  that sends the whole  $B$  to  $\mathcal{L}$ .*

*Then  $F \rtimes H^{-1}$  has the following property: for every  $L \in \mathfrak{B}(X, \mathcal{L})$ , for every  $c \in C$ , the inclusion  $(F \rtimes H^{-1})|_c(L) \subseteq \tilde{H}^{-1}(L)$  holds.*

*Proof.* By the definition ( 38 on the previous page),

$$(39) \quad (F \rtimes H^{-1})|_c(x) = H^{-1}|_{(F|_{x(c)})}(x).$$

The right-hand side of ( 39) is contained in  $\tilde{H}^{-1}(L)$  for  $x \in L$ . □

Therefore, under the conditions of Proposition 38, if  $F \rtimes H^{-1}$  is a fiberwise homeomorphism, then  $(F \rtimes H^{-1})^{-1}$  is a prismatic homeomorphism with respect to  $(C, C^{\text{triv}}) \xrightarrow{\delta_{\mathcal{L}}} \mathbf{Al}(X)$ .

**Proposition 39.** *Let  $\mathcal{L}$  be an Alexandroff topology on  $X$ . Let  $H$  be prismatic with respect to  $(B, B^{\text{triv}}) \xrightarrow{\delta_{\mathcal{L}}} \mathbf{Al}(X)$ . Let  $F \rtimes H^{-1}$  be a fiberwise homeomorphism. Then the inverse fiberwise homeomorphism is prismatic with respect to the Alexandroff presheaf  $(C, C^{\text{triv}}) \xrightarrow{\delta_{\mathcal{L}}} \mathbf{Al}(X)$  and  $(F \rtimes H^{-1})\mathcal{L} \equiv H^{-1}\mathcal{L}$ ,  $\widetilde{(F \rtimes H^{-1})^{-1}} \equiv \tilde{H}^{-1}$ .*

*Proof.* The assertion of Proposition 38 is equivalent to the same assertion with  $\mathfrak{B}(X, \mathcal{L})$  replaced by the partition  $\Sigma(X, \mathcal{L})$  (see Sec. 6.1.3 on page 43). Under our conditions, the maps  $F \rtimes H^{-1}|_c$  are one-to-one, so the elements of the partitions are mapped “onto.” Therefore the elements of the minimal bases are also mapped “onto.” This provides the required assertion for  $(F \rtimes H^{-1})^{-1}$ . □

Now we will slightly generalize the previous arguments.

**Proposition 40.** *Let  $\mathcal{T}$  be an Alexandroff topology on  $C$  and  $\mathcal{R}$  be an Alexandroff topology on  $B$ . Let  $\mathfrak{B}(C, \mathcal{T}) \xrightarrow{\phi} \mathfrak{B}(B, \mathcal{R})$  be a map of Alexandroff spaces. Let*

$(B, \mathcal{R}) \xrightarrow{\xi} \mathbf{Al}(X)$  be an Alexandroff presheaf. Let  $H \in \text{PL}_B(X)$  be a  $\xi$ -prismatic homeomorphism. Assume that the map  $F$  defined by the commutative triangle

$$\begin{array}{ccc} X \times C & \xrightarrow{F} & X \times B \\ & \searrow \pi_1 & \swarrow \pi_1 \\ & X & \end{array}$$

has the following “block” property: for every  $T \in \mathfrak{B}(C, \mathcal{T})$ , the equality  $F(X \times T) = X \times \phi(T)$  holds. Let  $F \rtimes H^{-1}$  be a fiberwise homeomorphism.

Then the homeomorphism  $(F \rtimes H^{-1})^{-1}$  is  $(\xi' \circ \phi)$ -prismatic.

*Proof.* On each separate block of  $X \times T$ , we are under the conditions of Proposition 39. Pasting the conclusion of Proposition 39 over all  $T \in \mathfrak{B}(C, \mathcal{T})$  provides the conclusion of the current proposition.  $\square$

## 10. GRAPH SYSTEMS

10.1. Let  $\mathbf{k}$  be a finite set of indices. The cube  $I^{\mathbf{k}}$  is a coordinate cube in  $\mathbb{R}^{\mathbf{k}}$  with coordinate functions  $t_k$ ,  $k \in \mathbf{k}$ . For a subset  $\mathbf{s} \subseteq \mathbf{k}$  and  $\epsilon \in \{0, 1\}^{\mathbf{k} \setminus \mathbf{s}}$ , denote by  $I^{\mathbf{s}, \epsilon}$  the face of  $I^{\mathbf{k}}$  defined by the equality  $t_i = \epsilon_i$  for coordinates with indices from  $\mathbf{k} \setminus \mathbf{s}$ . The “coordinate” faces  $I^{\mathbf{s}, \mathbf{0}}$  are denoted by  $I^{\mathbf{s}}$ . Let  $\mathbf{s} \subseteq \mathbf{k}$  be fixed. Let  $\Gamma = \{\Gamma_i\}_{i \in \mathbf{s}}$  be a collection of subpolyhedra in  $X \times I^{\mathbf{k}}$ . Consider the following condition on  $\Gamma$ :

**gf:** For every subset  $\mathbf{l} \subseteq \mathbf{s}$  there exists a map  $X \times I^{\mathbf{k} \setminus \mathbf{l}} \xrightarrow{f_{\mathbf{l}}} I^{\mathbf{l}}$  such that  $\Gamma_{\mathbf{l}} = \bigcap_{i \in \mathbf{l}} \Gamma_i = \Gamma f_{\mathbf{l}}$ . Here  $\Gamma f_{\mathbf{l}}$  is the graph of the map  $f_{\mathbf{l}}$  in  $X \times I^{\mathbf{k}}$ .

If the condition **gf** is satisfied, then the maps  $\{f_{\mathbf{l}}\}_{\mathbf{l} \subseteq \mathbf{s}}$  can be recovered from  $\Gamma$  in a unique way. Let  $N$  be a positive integer. Denote by  $\{\{N\}\}$  the set  $\{0, \dots, N\}$ . Define a set  $\mathbf{GF}(X, \mathbf{k}, N)$  as follows. An element  $\Gamma \in \mathbf{GF}(X, \mathbf{k}, N)$  is a collection  $\Gamma = \{\Gamma_i^j\}_{i \in \mathbf{k}, j \in \{\{N\}\}}$  of subpolyhedra in  $X \times I^{\mathbf{k}}$  for which the following conditions **gf1**, **gf2** are satisfied.

**gf1:** For every set  $\mathbf{s} \subseteq \mathbf{k}$  and every map  $\mathbf{s} \xrightarrow{b} \{\{N\}\}$ , the condition **gf** is satisfied for the collection  $\{\Gamma_i^{b(i)}\}_{i \in \mathbf{s}}$ .

This means that there exists a map  $X \times I^{\mathbf{k} \setminus \mathbf{s}} \xrightarrow{f^b} I^{\mathbf{s}}$  such that  $\Gamma^b = \bigcap_{i \in \mathbf{s}} \Gamma_i^{b_i} = \Gamma f^b$ , where  $\Gamma f^b$  is the graph of the map  $f^b$  in  $X \times I^{\mathbf{k}}$ .

The maps  $f^b$  are uniquely determined by  $\Gamma$ . If **gf1** is satisfied, then  $\Gamma_i^j = \Gamma f^{i \rightarrow j}$  for a unique map  $X \times I^{\mathbf{k} \setminus \{i\}} \xrightarrow{f^{i \rightarrow j}} I^{\{i\}}$ . These special maps  $f^{i \rightarrow j}$  will be denoted by  $f_i^j$ . Further, we assume that for  $\{f_i^j\}$  the following condition is satisfied:

**gf2:**  $0 \equiv f_i^0 \leq f_i^1 \leq \dots \leq f_i^{N-1} \leq f_i^N \equiv 1$  for all  $i \in \mathbf{k}$ .

10.2. We need to use indices that are maps of finite sets into  $\mathbb{N}$ . Let us introduce some notations and agreements.

Let  $\mathbf{r}, \mathbf{s}$  be subsets of  $\mathbf{k}$ . Let  $\mathbf{s} \xrightarrow{c} \mathbb{N}$ ,  $\mathbf{r} \xrightarrow{d} \mathbb{N}$  be two maps such that  $c|_{\mathbf{s} \cap \mathbf{r}} \equiv d|_{\mathbf{s} \cap \mathbf{r}}$ . Denote by  $c \sqcup d$  the map  $\mathbf{s} \cup \mathbf{r} \xrightarrow{c \sqcup d} \mathbb{N}$  such that  $c \sqcup d|_{\mathbf{s}} \equiv c$ ,  $c \sqcup d|_{\mathbf{r}} \equiv d$ . For a numerical function  $\mathbb{N} \xrightarrow{p} \mathbb{N}$  and  $a \in \mathbb{N}^{\mathbf{k}}$ , we denote by  $p(a) \in \mathbb{N}^{\mathbf{r}}$  the result of the componentwise application of  $p$  to  $a$ .

10.3. To every subset  $\mathbf{s} \subset \mathbf{k}$  and a map  $\mathbf{s} \xrightarrow{b} \{\{N\}\}$  we can associate a map

$$\mathbf{GF}(X, \mathbf{k}, N) \xrightarrow{\delta_b} \mathbf{GF}(X, \mathbf{k} \setminus \mathbf{s}, N)$$

as follows. For  $i \in \mathbf{k} \setminus \mathbf{s}$ ,  $j \in \{\{N\}\}$ , we put

$$(40) \quad (\delta^b \Gamma)_i^j = \pi_{x, t_{\mathbf{k} \setminus \mathbf{s}}}(\Gamma^{b \sqcup (i \rightarrow j)}) = \Gamma f_i^{b \sqcup (i \rightarrow j)},$$

where  $\pi_{x, t_{\mathbf{k} \setminus \mathbf{s}}} : X \times I^{\mathbf{k}} \rightarrow X \times I^{\mathbf{k} \setminus \mathbf{s}}$  is the coordinate projection.

10.4. Consider a map  $\mathbf{k} \xrightarrow{a} \{\{2N - 2\}\}$ . Define a polyhedron  $\Omega_a^0(\Gamma) \subset X \times I^{\mathbf{k}}$  as follows. Put

$$(\Omega_a^0)^o = \{(x, t_{\mathbf{k}}) \mid \forall i \text{ with } a_i = 2l_i - 1 : t_i = f_i^{l_i}(x, t_{\mathbf{k} \setminus \{i\}})\} = \bigcap_{a_i=2l_i-1} \Gamma_i^{l_i},$$

$$\begin{aligned} (\Omega_a^0)^e &= \{(x, t_{\mathbf{k}}) \mid \forall i \text{ with } a_i = 2l_i : f_i^{l_i}(x, t_{\mathbf{k} \setminus \{i\}}) \leq t_i \leq f_i^{l_i+1}(x, t_{\mathbf{k} \setminus \{i\}})\} \\ &= \bigcap_{a_i=2l_i} ((\Gamma_i^{l_i+1})^{\leq} \cap (\Gamma_i^{l_i})^{\geq}). \end{aligned}$$

(Here  $(\Gamma_i^j)^{\geq}$  and  $(\Gamma_i^j)^{\leq}$  are the closed supergraph and the subgraph of  $\Gamma_i^j$ , respectively). Put

$$(41) \quad \Omega_a^0 = (\Omega_a^0)^o \cap (\Omega_a^0)^e$$

and

$$\Omega^0(\Gamma) = \{\Omega_a^0\}_{a \in \{\{2N-2\}\}}.$$



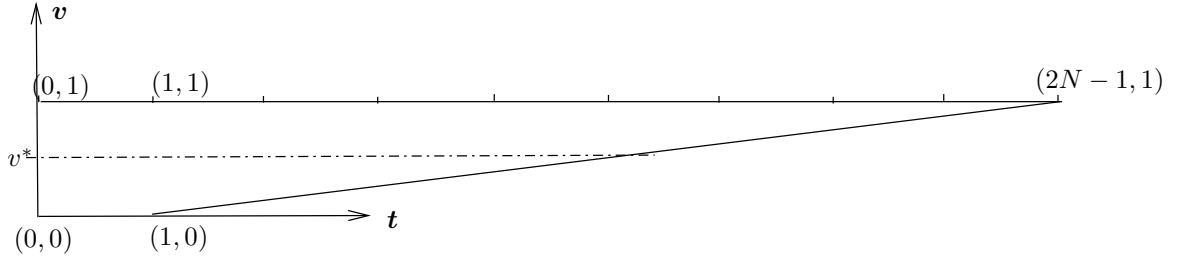

FIGURE 13.

10.5. Fix the following data:  $\mathbf{s} \subset \mathbf{k}$ ,  $\mathbf{s} \xrightarrow{b} \{\{N\}\}$ ,  $\Gamma \in \mathbf{GF}(X, \mathbf{k}, N)$ . According to Sec. 10.3,  $\delta^b \Gamma \in \mathbf{GF}(X, \mathbf{k} \setminus \mathbf{s}, N)$  is defined. Let us study the relations between  $\Omega^0(\Gamma)$  and  $\Omega^0(\delta^b \Gamma)$ . Let  $\mathbf{k} \setminus \mathbf{s} \xrightarrow{c} \{\{2N-1\}\}$ . According to (40), there are canonical mutually inverse homeomorphisms

$$(42) \quad \Omega_c^0(\delta^b \Gamma) \xrightleftharpoons[f^b]{\pi_{x, t_{\mathbf{k} \setminus \mathbf{s}}}} \Omega_{c \sqcup 2b-1}^0(\Gamma).$$

10.6. Construct a trapezoid  $T^{\mathbf{k}}(N) \subset \mathbb{R}^{\mathbf{k}} \times \mathbb{R}^{\{v\}}$ , where  $\mathbb{R}^{\{v\}}$  is a copy of  $\mathbb{R}$  with coordinate function  $v$ . By  $e_v$  we denote the corresponding basis vector.

Denote by  $\llbracket 2N-1 \rrbracket$  the interval  $[0, 2N-1] \subset \mathbb{R}$ . Denote by  $T^{\mathbf{k}}$  the trapezoid in  $\mathbb{R}^{\mathbf{k}} \times \mathbb{R}^{\{v\}}$  that is the convex hull of two embedded cubes:  $T^{\mathbf{k}} = \text{conv}(I^{\mathbf{k}}, e_v + \llbracket 2N-1 \rrbracket^{\mathbf{k}})$ . Figure 13 presents the trapezoid  $T^1$ .

The trapezoid  $T^{\mathbf{k}}$  is the product of  $\mathbf{k}$  copies of  $T^1$  fibered by  $v$ . We have the embeddings

$$I^{\mathbf{k}} \xrightarrow{h_0} T^{\mathbf{k}} \xleftarrow{h_1} \llbracket 2N-1 \rrbracket^{\mathbf{k}},$$

where  $h_0(t_{\mathbf{k}}) = (t_{\mathbf{k}}, 0_v)$ ,  $h_1(t_{\mathbf{k}}) = (t_{\mathbf{k}}, 1_v)$ . We denote the images of  $h_0$  and  $h_1$  by  $H_0^{\mathbf{k}}$  and  $H_1^{\mathbf{k}}$ , respectively. For each face  $I^{\mathbf{k} \setminus \mathbf{s}, \epsilon} \subset I^{\mathbf{k}}$  of the cube, we have a map  $T^{\mathbf{k} \setminus \mathbf{s}} \xrightarrow{d_{\mathbf{s}, \epsilon}} T^{\mathbf{k}}$ , which is defined as follows:

$$(t_{\mathbf{s}}, v) \mapsto (t_{\mathbf{s}}, g_{\mathbf{k} \setminus \mathbf{s}}^{\epsilon}(t_{\mathbf{s}}, v)),$$

where

$$g_i^{\epsilon}(t_{\mathbf{s}}, v) = \begin{cases} 1 + 2(N-1)v & \text{for } \epsilon_i = 1, \\ 0 & \text{for } \epsilon_i = 0. \end{cases}$$

Denote the image of  $d_{\mathbf{s}, \epsilon}$  by  $T^{\mathbf{s}, \epsilon} \subseteq T^{\mathbf{k}}$ . Denote the union  $\cup_{i \in \mathbf{k}, \epsilon_i=0,1} T^{\mathbf{k} \setminus \{i\}, \epsilon_i}$  of all polyhedra by  $W^{\mathbf{k}}$ . Denote the faces of  $W^{\mathbf{k}}$  that correspond to  $v = 0$  and  $v = 1$  by  $h^0(W^{\mathbf{k}})$  and  $h^1(W^{\mathbf{k}})$ , respectively.

**Proposition 41.** *There exists a noncanonical cellular PL homeomorphism  $[I^{\mathbf{k}} \times I^v] \rightarrow [T^{\mathbf{k}}]$  that sends  $I^{\mathbf{k}} \times 0$  to  $H_0^{\mathbf{k}}$  and  $I^{\mathbf{k}} \times 1$  to  $H_1^{\mathbf{k}}$ . Under this homeomorphism, the face  $I^{\mathbf{s},\epsilon} \times I^{\{v\}}$  goes to  $T^{\mathbf{s},\epsilon}$ , and  $W^{\mathbf{k}}$  goes to  $\partial I^{\mathbf{k}} \times I^{\{v\}}$ .*

*Proof.* This is a standard assertion for PL topology. The required homeomorphism can be built using Alexander's trick.  $\square$

10.7. Now we will construct a family  $\Omega(\Gamma) = \{\Omega_a\}_{a \in \llbracket 2N-2 \rrbracket^{\mathbf{k}}}$  of closed subpolyhedra in  $X \times T^{\mathbf{k}}$ . Let  $x^* \in X$ . Put  $\Omega_a^0(x^*) = \{(t_{\mathbf{k}}) \mid (x^*, t_{\mathbf{k}}) \in \Omega_a^0\} \subset I^{\mathbf{k}}$ . Define

$$(43) \quad \Omega_a(x, v) = \Omega_a^0(x) \oplus 2vI^{o(a)} + 2\left[\frac{a}{2}\right]v \subset \mathbb{R}^{\mathbf{k}},$$

where  $[\cdot]$  is the integral part. By the agreement in Sec. 10.2, we regard  $2\left[\frac{a}{2}\right]$  as an integer vector. The symbol  $\oplus$  means the Minkowski sum, and

$$o(a) = \{i \in \mathbf{k} \mid a_i \text{ is odd}\}.$$

Define a map

$$(44) \quad \Omega_a(x, v) \xrightarrow{F_a|_{x,v}} \Omega_a^0(x)$$

as follows:

$$(45) \quad F_a|_{x,v}(t_{\mathbf{k}}) = (t_{e(a)}, f^{\frac{O(a)-1}{2}}(x, t_{e(a)})),$$

where

$$e(a) = \{i \in \mathbf{k} \mid a_i \text{ is even}\}$$

and  $O(a) = a|_{o(a)} : o(a) \rightarrow \mathbb{N}$ . Define

$$(46) \quad \Omega_a = \{(x, t_{\mathbf{k}}, v) \mid t_{\mathbf{k}} \in \Omega_a(x, v)\}.$$

Put

$$(47) \quad \Omega_a \xrightarrow{F_a} \Omega_a^0 : F_a(x, t_{\mathbf{k}}, v) = F_a|_{x,v}(t_{\mathbf{k}}).$$

(According to (42), the image of  $F_a$  belongs to  $\Omega_a^0$ .)

10.8. Consider the sets  $\Omega_a^1(x) = \Omega_a(x, 1) \subset \llbracket 2N-1 \rrbracket^{\mathbf{k}}$ . For  $a \in \llbracket 2N-2 \rrbracket$ , define an interval  $\Lambda_a$  in  $\llbracket 2N-1 \rrbracket$  by

$$\Lambda_a = \begin{cases} [2l, 2l+1] & \text{for } a = 2l, \\ [2l-1, 2l+1] & \text{for } a = 2l-1. \end{cases}$$

For  $a \in \llbracket 2N-2 \rrbracket^{\mathbf{k}}$ , define a parallelepiped  $\Lambda_a$  by the formula  $\Lambda_a = \prod_{i \in \mathbf{k}} \Lambda_{a_i}$ . The set  $\{\Lambda_a\}_{a \in \llbracket 2N-2 \rrbracket^{\mathbf{k}}}$  of closed parallelepipeds is the base of some CPL Alexandroff topology  $\Lambda(N, \mathbf{k})$  on  $\llbracket 2N-1 \rrbracket^{\mathbf{k}}$ .

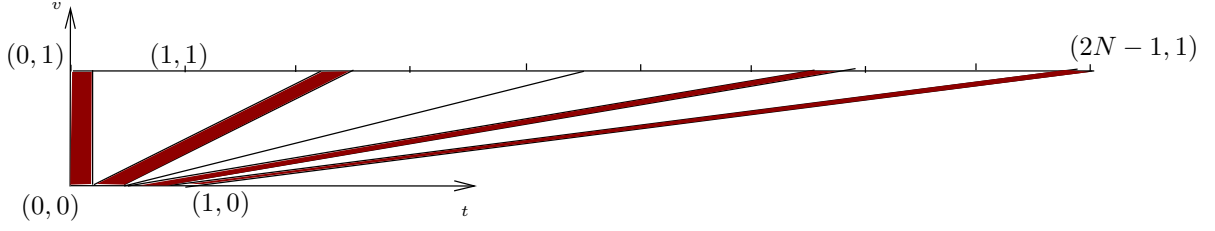

FIGURE 14.

**Proposition 42.** *For any  $a \in \{\{2N - 2\}\}^{\mathbf{k}}$ ,  $x \in X$ , the inclusion  $\Omega_a^1(x) \subset \Lambda_a$  holds.*

*Proof.* This follows immediately from (43). □

10.9. Here we will proof the following proposition.

**Proposition 43.**

1. *The set  $\Omega(\Gamma)$  of polyhedra is a cover of  $X \times T^{\mathbf{k}}$ .*
2. *Setting  $F_\Gamma|_{\Omega_a} = F_a$ , we obtain a well-defined map  $X \times T^{\mathbf{k}} \xrightarrow{F_\Gamma} X \times I^{\mathbf{k}}$  that is fiberwise with respect to the projection to  $X$ .*

*Proof.* The proof proceeds by induction on the number of elements in  $\mathbf{k}$ .

1. Let  $\#\mathbf{k} = 1$ . In this case, we are in the classical situation of Hudson's proof [15, Theorem 6.2, p. 130]. For  $x^* \in X$ , the sets  $\Omega_j(x^*)$  form a cover of  $T^1$  by parallelograms and triangles (see Fig. 14). Sets of the type  $\Omega_{2l}(x^*)$  are parallelograms, sets of the type  $\Omega_{2l-1}(x^*)$  are triangles. Under the maps  $F_a$ , a parallelogram is projected to its base along the side edge, and a triangle is projected into one of its vertices. All these maps are automatically pasted into a global map  $F_\Gamma$ .

2. Inductive step.

2.1 We can build  $2N$  new functions  $T^{\mathbf{k} \setminus \{i\}} \xrightarrow{\bar{f}_i^j} \mathbb{R}^{\{i\}}$  with indices from  $\{\{2N - 1\}\}$  as follows:

$$(48) \quad \begin{aligned} \bar{f}_i^{2l}(\Gamma) &= f_i^l \circ F_{\delta_i^l \Gamma}(x, t_{\mathbf{k} \setminus \{i\}}, v) + 2lv && \text{for } l = 0, \dots, N - 1, \\ \bar{f}_i^{2l-1}(\Gamma) &= f_i^l \circ F_{\delta_i^l \Gamma}(x, t_{\mathbf{k} \setminus \{i\}}, v) + (2l - 2)v && \text{for } l = 1, \dots, N. \end{aligned}$$

By the inductive assumption, these functions are well-defined. Put

$$\bar{\Gamma}_i^j = \{(x, t_{\mathbf{k}}, v) \mid t_i = \bar{f}_i^j(x, t_{\mathbf{k} \setminus \{i\}}, v)\}.$$

By construction,

$$(49) \quad \bar{f}_i^{2l} \equiv \bar{f}_i^{2l-1} + 2v.$$

The collections  $\overline{f}_i^j$  are monotone for every  $i \in \mathbf{k}$ :

$$0 \equiv \overline{f}_i^0 \leq \overline{f}_i^1 \leq \dots \leq \overline{f}_i^{2N-1} \equiv 1 + 2(N-1)v.$$

For  $\mathbf{s} \xrightarrow{c} \{\{2N-1\}\}$ , define a map  $X \times T^{\mathbf{k} \setminus \mathbf{s}} \xrightarrow{\overline{f}^c} \mathbb{R}^{\mathbf{s}}$  by the following rule:

$$(50) \quad \overline{f}^c(x, t_{\mathbf{k} \setminus \mathbf{s}}, v) = f^{\lfloor \frac{c+1}{2} \rfloor} \circ F_{\delta^{\lfloor \frac{c+1}{2} \rfloor} \Gamma}(x, t_{\mathbf{k} \setminus \mathbf{s}}, v) + 2\lfloor \frac{c}{2} \rfloor v.$$

We obtain

$$(51) \quad \Gamma \overline{f}^c = \bigcap_{i \in \mathbf{s}} \overline{\Gamma}_i^{c(i)}.$$

2.2. We must verify that the definition (46) has the following property: for every  $a \in \{\{2N-2\}\}$ ,

$$(52) \quad \Omega_a = \{(x, t_{\mathbf{k}}, v) \mid \overline{f}_i^{a_i}(x, t_{\mathbf{k} \setminus \{i\}}, v) \leq t_i \leq \overline{f}_i^{a_i+1}(x, t_{\mathbf{k} \setminus \{i\}}, v)\}.$$

Thus  $\Omega_a$  is a cover of  $X \times T^{\mathbf{k}}$ .

2.3. Let us construct a map

$$X \times T^{\mathbf{k}} \supset \bigcup_{i \in \mathbf{k}, j \in \{\{2N-1\}\}} \overline{\Gamma}_i^j \xrightarrow{\tilde{F}} \bigcup_{i \in \mathbf{k}, j \in \{\{N\}\}} \Gamma_i^j \subset X \times I^{\mathbf{k}}.$$

We define  $\tilde{F}|_{\overline{\Gamma}_i^j}$  by the following rule:

$$(53) \quad (x, t_{\mathbf{k}}, v) \mapsto f^{\lfloor \frac{i+1}{2} \rfloor} \circ F_{\delta_i^{\lfloor \frac{i+1}{2} \rfloor} \Gamma}(x, t_{\mathbf{k} \setminus \{i\}}, v).$$

We must verify that the map  $\tilde{F}|_{\overline{\Gamma}_i^j}$  is well-defined. To this end, we must check that the rule (53) has the following property: if  $(x^*, t_{\mathbf{k}}^*, v^*) \in \overline{\Gamma}_{i_1}^{j_1} \cap \overline{\Gamma}_{i_2}^{j_2}$ , then  $\tilde{F}|_{\overline{\Gamma}_{i_1}^{j_1}}(x^*, t_{\mathbf{k}}^*, v^*) = \tilde{F}|_{\overline{\Gamma}_{i_2}^{j_2}}(x^*, t_{\mathbf{k}}^*, v^*)$ . There are two cases:  $i_1 \neq i_2$  and  $i_1 = i_2$ . If  $i_1 \neq i_2$ , then we use (51), (50). If  $i_1 = i_2$ , then we should directly unfold (53).

2.3. From (52) it follows that for any polyhedron  $\Omega_a$  its boundary  $\partial\Omega_a$  is contained in  $\bigcup_{i \in \mathbf{k}, j \in \{\{2N-1\}\}} \overline{\Gamma}_i^j$ , and for any boundary point  $(x, t_{\mathbf{k}}, v) \in \partial\Omega_a$  we have  $F_a(x, t_{\mathbf{k}}, v) = \tilde{F}(x, t_{\mathbf{k}}, v)$ . This observation completes the inductive step.  $\square$

10.10. We will separately mention some facts about the map  $F_\Gamma$ . Let  $(x^*, t_{\mathbf{k}}^*, v^*) \in T^{\mathbf{k}}$ ,  $v^* > 0$ . Fix  $i \in \mathbf{k}$ ,  $\varepsilon > 0$  and consider the set of points

$$V_\varepsilon^i = \{(x^*, t_{\mathbf{k} \setminus \{i\}}^*, t_i, v^*) \mid \text{mod } (t_i - t_i^*) < \varepsilon\}.$$

**Proposition 44.** *If any of the conditions*

- (a)  $(x^*, t_{\mathbf{k}}^*, v^*) \in \text{int } \Omega_a$  and  $a_i = 2l - 1$ ; or
- (b)  $(x^*, t_{\mathbf{k}}^*, v^*) \in \Omega_a$ ,  $a_i = 2l$ , and  $\overline{f}^{a_i+1}(x^*, t_{\mathbf{k}}^*, v^*) = \overline{f}^{a_i}(x^*, t_{\mathbf{k}}^*, v^*)$

*is satisfied, then there exists  $\varepsilon$  such that  $F_\Gamma|_{V_\varepsilon^i} \equiv \text{const}$ .*

*Proof.* 1. Assume that  $a \in \{2N - 2\}$  and  $a_i$  is odd. Consider the line  $L_i(x^*, t_{\mathbf{k}}^*, v^*)$  passing through  $(x^*, t_{\mathbf{k}}^*, v^*)$  and parallel to the  $t_i$ -th coordinate axis. By the definition of  $\Omega_a$ , we have

$$L_i(x^*, t_{\mathbf{k}}^*, v^*) \cap \Omega_a = \{(x^*, t_{\mathbf{k} \setminus \{i\}}^*, t_i, v^*) \mid \overline{f}_i^{a_i}(x^*, t_{\mathbf{k} \setminus \{i\}}^*, v^*) \leq t_i \leq \overline{f}^{a_i+1}(x^*, t_{\mathbf{k} \setminus \{i\}}^*, v^*)\}.$$

By the definition of  $F_a$ , we have  $F_a|_{L_i(x^*, t_{\mathbf{k}}^*, v^*) \cap \Omega_a} \equiv \text{const}$ .

2. According to (49 on page 75), the length of  $L_i(x^*, t_{\mathbf{k}}^*, v^*) \cap \Omega_a$  is equal to  $2v^*$ .

3.1. If (a) is true, then the conclusion of the proposition is true by Steps 1 and 2 of the proof.

3.2. If (b) is true, then, by (49), the point  $(x^*, t_{\mathbf{k}}^*, v^*)$  lies in  $\Omega_b \cap \Omega_c$ , where

$$b_j = \begin{cases} a_i - 1 & \text{for } j = i, \\ a_i & \text{for } j \neq i \end{cases} \quad \text{and} \quad c_j = \begin{cases} a_i + 1 & \text{for } j = i, \\ a_i & \text{for } j \neq i. \end{cases}$$

According to Steps 1 and 2 of the proof, the map  $F_\Gamma$  is constant on both intervals  $L_i(x^*, t_{\mathbf{k}}^*, v^*)$  of length  $2v^*$  starting at the point  $(x^*, t_{\mathbf{k}}^*, v^*)$ . Therefore the conclusion of the proposition is true.  $\square$

10.11. Here we will consider the case where the map  $F_\Gamma$  has a block structure (see Sec. 9.3 on page 70). We introduce the following assumption on graph systems  $\Gamma \in \mathbf{GF}(X, \mathbf{k}, N)$ :

**gf3:** Let  $M$  be a positive integer. We assume that  $N$  is a multiple of  $M$ :  $N = MN'$ . Further, we assume that the graphs  $\Gamma_i^{lN'}$  in the system  $\Gamma$  are the graphs of constant functions  $f_i^{lN'} \equiv \frac{l}{M}$  for  $i \in \mathbf{k}$ ,  $l = 0, \dots, M$ .

Denote by  $\mathbf{GF}(X, \mathbf{k}, N, M)$  the set of all graph systems satisfying **gf3**. On the unit interval  $I$ , consider the structure of the ball complex  $\frac{1}{M}[I] = (I, \overline{\Psi})$ . Recall that we identify a ball complex with the CPL Alexandroff space whose minimal base is

the set of balls. We parameterize the set of balls  $\mathfrak{B}(\overline{\Psi})$  by the set  $\{\widetilde{2M-1}\} = \{-1, \dots, 2M-1\}$ . Put

$$\begin{aligned} \overline{\Psi}_{2l} &= [\frac{l}{M}, \frac{l+1}{M}] \subset I, \quad l = 0, \dots, M-1, \\ \overline{\Psi}_{2l-1} &= \{\frac{l}{M}\} \in I, \quad l = 0, \dots, M. \end{aligned}$$

Now extend  $\frac{1}{M}[I]$  to a CPL Alexandroff topology  $\overline{\Theta}$  on  $T^1$ . The elements of the minimal base  $\mathfrak{B}(\overline{\Theta})$  are indexed by the same set  $\{\widetilde{2M-1}\}$ . Put

$$(54) \quad \begin{aligned} \overline{\Theta}_{2l} &= \begin{cases} \text{conv}((\frac{l}{M}, 0), (\frac{l+1}{M}, 0)(2lN', 1), (2(l+1)N', 1)) \text{ for } l = 0, \dots, M-2, \\ \text{conv}((\frac{M-1}{M}, 0), (1, 0), (2(M-1)N', 1)(2N-1)) \text{ for } l = M-1; \end{cases} \\ \overline{\Theta}_{2l-1} &= \begin{cases} \text{conv}((\frac{l}{M}, 0), (2lN', 1)) \text{ for } l = 0, \dots, M-1, \\ \text{conv}((0, 1), (2N-1)) \text{ for } l = M. \end{cases} \end{aligned}$$

Here is an illustration of these ugly formulas:

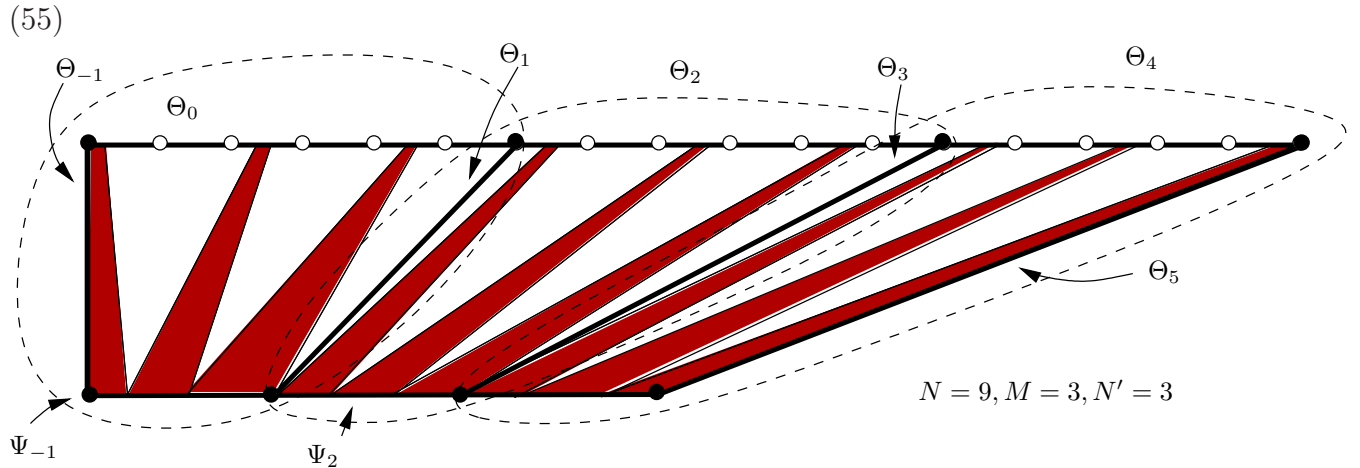

Consider the poset morphism  $\mathfrak{B}(\overline{\Theta}) \xrightarrow{\zeta} \mathfrak{B}(\overline{\Psi})$  that sends  $\overline{\Theta}_a$  to  $\overline{\Psi}_a$ , where  $a \in \{\widetilde{2M-1}\}$ .

**Proposition 45.** *Let  $\Gamma \in \mathbf{GF}(X, \mathbf{1}, N, M)$ . Then  $F_\Gamma(X \times \overline{\Theta}_a) = X \times \zeta(\overline{\Theta}_a) = X \times \overline{\Psi}_a$ .*

*Proof.* Consider the triangles  $\Omega_{2jN'-1}(x) \subset T^1$ ,  $j = 1, \dots, M-1$ . According to **gf3**, we have  $f^{jN'} \equiv \frac{j}{M}$ . From this fact and (52 on page 76) it follows that for every

$x \in X$

$$\begin{aligned} \pi_{v,t}(\Omega_{2jN'-1}(x)) &\equiv \Omega_{2jN'-1}(x_2) \\ &= \left\{ (t, v) \mid \frac{j}{M} \leq t + 2(jN' - 1)v \leq \frac{j}{M} + 2jN'v \right\} \supset \overline{\Theta}_{2j-1}. \end{aligned}$$

Comparing this equation with the definition of  $F_\Gamma$ , we obtain the required assertion.  $\square$

In the case of a general  $\mathbf{k}$ , we consider the complex  $\frac{1}{M}[I^{\mathbf{k}}] = (\frac{1}{M}[I])^{\mathbf{k}} = (I^{\mathbf{k}}, \overline{\Psi})$ , where  $\mathfrak{B}(\overline{\Psi}) = \{\overline{\Psi}_a\}_{a \in \{\widetilde{\{2M-1\}}^{\mathbf{k}}\}}$ ,  $\overline{\Psi}_a = \overline{\Psi}_{a_1} \times \dots \times \overline{\Psi}_{a_k}$ . Define an Alexandroff space  $(T^{\mathbf{k}}, \overline{\Theta})$  as a product fibered by  $v$ :  $\mathfrak{B}(\overline{\Theta}) = \{\overline{\Theta}_a\}_{a \in \{\widetilde{\{2M-1\}}^{\mathbf{k}}\}}$ ,

$$\overline{\Theta}_a = \{(t_{\mathbf{k}}, v) \mid (t_i, v) \in \overline{\Theta}_{a_i}, i = 1, \dots, k\}.$$

Define a morphism  $\mathfrak{B}(\overline{\Theta}) \xrightarrow{\zeta} \mathfrak{B}(\overline{\Psi})$  by the rule  $\zeta \overline{\Theta}_a = \overline{\Psi}_a$ . Applying Proposition 45 to the components of the fibered product, we obtain the following proposition.

**Proposition 46.** *Let  $\Gamma \in \mathbf{GF}(X, \mathbf{k}, N, M)$ . Then for every  $a \in \{\widetilde{\{2M-1\}}^{\mathbf{k}}\}$ ,*

$$F_\Gamma(X \times \overline{\Theta}_a) = X \times \zeta(\overline{\Theta}_a) = X \times \overline{\Psi}_a.$$

The elements of the minimal bases  $\mathfrak{B}(\Theta) = \{\Theta_a\}$  and  $\mathfrak{B}(\Psi) = \{\Psi_a\}$  of the dual OPL Alexandroff topologies  $\Theta = \overline{\Theta}^c$  on  $T^{\mathbf{k}}$  and  $\Psi = \overline{\Psi}^c$  on  $I^{\mathbf{k}}$  are indexed by the same set  $\{\widetilde{\{2M-1\}}^{\mathbf{k}}\}$ . Consider the poset morphism  $\mathfrak{B}(\Theta) \xrightarrow{\zeta} \mathfrak{B}(\Psi)$  that sends  $\Theta_a$  to  $\Psi_a$ . By the duality and Proposition 46, we conclude that the following proposition holds.

**Proposition 47.** *Let  $\Gamma \in \mathbf{GF}(X, \mathbf{k}, N, M)$ . Then for every  $a \in \{\widetilde{\{2M-1\}}^{\mathbf{k}}\}$ ,*

$$F_\Gamma(X \times \Theta_a) = X \times \zeta(\Theta_a) = X \times \Psi_a.$$

## 11. HOMOTOPIES OF FIBERWISE HOMEOMORPHISMS ASSOCIATED WITH GRAPH SYSTEMS

Let  $G \in \text{PL}_{I^{\mathbf{k}}}X$  be a fiberwise homeomorphism. Let  $\Gamma \in \mathbf{GF}(X, \mathbf{k}, N)$  be a graph system. We say that  $G$  and  $\Gamma$  are **consistent** if  $G^{-1}(\Gamma) \in \mathbf{GF}(X, \mathbf{k}, N)$ .

**Lemma 9.** *If  $G$  and  $\Gamma$  are consistent, then  $(F_\Gamma \times G^{-1})^{-1}$  is a fiberwise homeomorphism and  $(F_\Gamma \times G^{-1})^{-1} = F_{G^{-1}(\Gamma)} \times G$ .*

*Proof.* The equality  $(F_\Gamma \times G^{-1})^{-1} = F_{G^{-1}(\Gamma)} \times G$  is a direct corollary of the construction of  $F_\Gamma$  (see Proposition 43 on page 75).  $\square$

11.1. We impose an additional assumption on graph systems from  $\Gamma \in \mathbf{GF}(X, \mathbf{k}, N)$ .

**gf4:** The functions  $f_i^j(x, t_{\mathbf{k} \setminus \{i\}})$  are independent both from  $t_{\mathbf{k} \setminus \{i\}}$  and the index  $i$ . That is, for every  $j \in \{\{N\}\}$  there exists a function  $X \xrightarrow{f^j} I$  such that for every  $i \in \mathbf{k}$  the equality  $f_i^j(x, t_{\mathbf{k} \setminus \{i\}}) = f^j(x)$  holds.

Denote by  $\mathbf{HGF}(X, \mathbf{k}, N)$  the set of all  $\Gamma \in \mathbf{GF}(X, \mathbf{k}, N)$  satisfying **gf4**. Denote by  $\mathbf{HGF}(X, \mathbf{k}, N, M)$  the set of all  $\Gamma \in \mathbf{GF}(X, \mathbf{k}, N, M)$  satisfying **gf4**.

11.2. **Flat points of a fiberwise homeomorphism.** We will need some general facts about “flat points” of a fiberwise homeomorphism. Let  $G \in \text{PL}_B(X)$  and  $(x, b) \in X \times B$ .

We say that  $(x, b)$  is a **flat point of  $G$**  if for some open neighborhood  $V \subset B$  of the point  $b$  the following is true: for any  $b' \in V$  the equality  $G^{-1}|_{b'}(x) = G^{-1}|_b(x)$  holds.

We can rephrase the definition of a flat point in prismatic terms. Consider the Alexandroff topology  $\delta_x$  on  $X$  with minimal base  $\mathfrak{B}(X, \delta_x) = \{\{X\}, \{x\}\}$  consisting of two elements. Consider the constant Alexandroff presheaf  $\zeta_{V,x}$  that sends  $(V, V^{\text{triv}})$  to  $(X, \delta_x)$ .

**Proposition 48.** *The point  $(x, b)$  is a flat point of  $G$  if and only if for some neighborhood  $V \subset B$  of the point  $b$  the homeomorphism  $G^{-1}|_V$  is  $\zeta_{v,x}$ -prismatic.*

Let  $\mathbf{k} = \{1, \dots, k\}$ . Pick  $G \in \text{PL}_{\mathbb{R}^{\mathbf{k}}}(X)$ ,  $(x, b) \in X \times \mathbb{R}^{\mathbf{k}}$ , and  $i \in \mathbf{k}$ . Let  $e_1, \dots, e_k$  be a basis in  $\mathbb{R}^{\mathbf{k}}$ . Consider the line  $l_i(b) = \{b + e_i t \mid t \in \mathbb{R}\}$ . Thus  $l_i(b)$  is the line passing through the point  $b$  parallel to  $e_i$ .

We say that  $G$  is **horizontal in the direction  $i$  at the point  $(x, b)$**  if there exists a neighborhood  $V \subset \mathbb{R}^{\mathbf{k}}$  of the point  $b$  such that for every  $b' \in V$  the homeomorphism  $G|_{l_i(b')}$  is flat at  $(x, b')$ .

**Proposition 49.** *If  $G \in \text{PL}_{\mathbb{R}^{\mathbf{k}}}(X)$  and  $(x, b) \in X \times \mathbb{R}^{\mathbf{k}}$  are such that  $G$  is horizontal for all directions  $i \in \mathbf{k}$ , then  $(x, b)$  is a flat point of  $G$ .*

*Proof.* We may assume that there is a small cube  $Q \subset \mathbb{R}^{\mathbf{k}}$  with edges parallel to the basis vectors and barycenter  $b$  such that for every  $b' \in Q$  the homeomorphism  $\text{PL}|_{l_i(b')}$  is horizontal at  $(x, b')$  in any direction  $i \in \mathbf{k}$ . We can approach any point  $b' \in Q$  by a finite polygonal line lying inside  $Q$  and formed by intervals parallel to the coordinate axes. From this fact and the conditions of the proposition it follows that  $G^{-1}|_{b'}(x) = G^{-1}|_b(x)$ .  $\square$



11.3. Denote by  $(T^{\mathbf{k}})^{v^*}$  the set  $\{(t_{\mathbf{k}}, v) \in T^{\mathbf{k}} \mid v = v^*\}$ .

**Proposition 50.** *Let  $\Gamma \in \mathbf{HGF}(X, \mathbf{k}, N)$  be a graph system. Let  $G \in \mathbf{PL}_{\Gamma^{\mathbf{k}}}$  be a fiberwise homeomorphism consistent with  $\Gamma$ . Assume that  $(x^*, t_{\mathbf{k}}^*, v^*) \in X \times T^{\mathbf{k}}$ ,  $v^* > 0$ . Then the following is true.*

*If the fiberwise homeomorphism  $F_{\Gamma} \times G^{-1}|_{(T^{\mathbf{k}})^{v^*}}$  is not horizontal in the direction  $i$  at the point  $(x^*, t_{\mathbf{k}}^*, v^*)$ , then there exists an index  $a \in \{\{2N - 1\}\}$  such that  $a_i = 2l$ ,  $(x^*, t_{\mathbf{k}}^*, v^*) \in \Omega_a$ , and  $x^* \in \text{supp}(f_i^{l+1} - f_i^l)$ .*

*Proof.* We consider two cases.

1. Assume that for every  $a$  such that  $(x^*, t_{\mathbf{k}}^*, v^*) \in \Omega_a$  it is true that  $a_i$  is odd. This means that  $(x^*, t_{\mathbf{k}}^*, v^*)$  belongs to the complement of the closed set  $\cup_{a \in \{\{2N - 2\}\}, i \in e(a)} \Omega_a$ . By the proof of Proposition 43 on page 75, we can conclude that  $a$  belongs to the interior of some  $\Omega_a$  such that  $i \in o(a)$ . Then from the definition of  $F_a$ , the definition of  $F_{\Gamma} \times G^{-1}$ , and Proposition 44 on page 77 (a) it follows that  $F_{\Gamma} \times G^{-1}$  is horizontal at the point  $(x^*, t_{\mathbf{k}}^*, v^*)$  in the direction  $i$ .

2. Let  $a \in \{\{2N - 1\}\}$  be such that  $a_i = 2l$  and  $x^* \notin \text{supp}(f_i^{l+1} - f_i^l)$ . In this case, by the proof of Proposition 43 on page 75, the point  $t_{\mathbf{k}}^*$  belongs to  $\Omega_i^{2l-1}(x^*, v^*) \cap \Omega_i^{2l+1}$ , where

$$\Omega_i^j(x^*, v^*) = \{t_{\mathbf{k}} \mid \bar{f}_i^j(x^*, t_{\mathbf{k} \setminus \{i\}}, v^*) \leq t_i \leq \bar{f}_i^{j+1}(x^*, t_{\mathbf{k} \setminus \{i\}}, v^*)\}.$$

The special feature of the condition **gf4** is that in this case

$$\bar{f}_i^j = f_i^{\lfloor \frac{j+1}{2} \rfloor}(x^*) + 2\lfloor \frac{j}{2} \rfloor v^* \equiv \text{const}.$$

Therefore in some neighborhood of the point  $(x^*, t_{\mathbf{k}}^*, v^*)$  in  $T^{\mathbf{k}}(x^*, v^*)$ , all the points satisfy the conditions of Proposition 44 on page 77. This completes the proof.  $\square$

11.4. Let  $G$  be consistent with  $\Gamma$ . We will describe the structure of the homeomorphism  $(F_{\Gamma} \times G^{-1})^1 \in \mathbf{PL}_{\llbracket 2N - 1 \rrbracket^{\mathbf{k}}}(X)$ .

Let us introduce an OPL Alexandroff topology  $\mathcal{E}(N, k)$  on the cube  $\llbracket 2N - 1 \rrbracket^{\mathbf{k}}$ . First, consider an Alexandroff topology  $\mathcal{E}(N, 1)$  on  $\llbracket 2N - 1 \rrbracket^1 = [0, 2N - 1]$ . The elements of the minimal base  $\mathfrak{B}(\llbracket 2N - 1 \rrbracket^1, \mathcal{E}(N, 1))$  are indexed by the elements of  $\{\{2N - 2\}\}^1 = \{0, 1, \dots, 2N - 2\}$ . Put

$$E_i = \begin{cases} (i - 1, i + 2) & \text{if } 2 \leq i \leq 2N - 4 \text{ and } i \text{ is even,} \\ (i, i + 1) & \text{if } 1 \leq i \leq 2N - 3 \text{ and } i \text{ is odd,} \\ (0, 2) & \text{if } i = 0, \\ (2N - 3, 2N - 1) & \text{if } i = 2N - 2. \end{cases}$$

Consider the partial order  $\leq_e$  on  $\{\{2N-2\}^1\}$  generated by the relation “an even number is larger than both neighboring odd numbers.” We can see that  $E_i \subseteq E_j$  if and only if  $i \leq_e j$ . Thus we obtain a canonical isomorphism of posets

$$(56) \quad \mathfrak{B}(\llbracket 2N-1 \rrbracket^1, \mathcal{E}(N, 1)) \approx \{\{2N-2\}^1_{\leq_e}\}.$$

Define

$$(57) \quad (\llbracket 2N-1 \rrbracket^{\mathbf{k}}, \mathcal{E}(N, \mathbf{k})) = (\llbracket 2N-1 \rrbracket^1, \mathcal{E}(N, 1))^{\mathbf{k}}.$$

Taking a power of the isomorphism (56), we obtain a canonical isomorphism

$$(58) \quad \mathfrak{B}(\llbracket 2N-1 \rrbracket^1, \mathcal{E}(N, \mathbf{k})) \approx \{\{2N-2\}^{\mathbf{k}}_{\leq_e}\}$$

(here we denote the power  $(\leq_e)^{\mathbf{k}}$  of the partial order  $\leq_e$  by the same symbol  $\leq_e$ ). Thus the elements of the minimal base  $\mathfrak{B}(\llbracket 2N-1 \rrbracket^{\mathbf{k}}, \mathcal{E}(N, \mathbf{k}))$  are indexed by the elements of  $\{\{2N-2\}^{\mathbf{k}}\}$ , and  $E_{a_{\mathbf{k}}} = \prod_{i \in \mathbf{k}} E_{a_i}$ ,  $E_a \subset E_b \Leftrightarrow a \leq_e b$ .

Let  $\Gamma \in \mathbf{GF}(X, \mathbf{k}, N)$  be a graph system and assume that the axiom **gf4** is satisfied. Pick  $a \in \{\{2N-2\}^{\mathbf{k}}\}$ . Consider the subset

$$(59) \quad \tilde{J}_{\Gamma}(a) \subset X, \quad \tilde{J}_{\Gamma}(a) = \bigcup_{i \in e(a), a_i = 2l_i} \text{supp}(f_i^{l_i+1} - f_i^{l_i}).$$

Put  $J_{\Gamma}(a) = \mathcal{D}_{\tilde{J}_{\Gamma}(a)}$  (the functor  $\mathcal{D}_{\star}$  is defined in Sec. 8.1 on page 61). We obtain a poset morphism

$$\{\{2N-2\}^{\mathbf{k}}_{\leq_e}\} \xrightarrow{J_{\Gamma}} \mathbf{Al}(X).$$

Using the isomorphism (58), we define a morphism

$$(\llbracket 2N-1 \rrbracket^{\mathbf{k}}, \mathcal{E}(N, \mathbf{k})) \xrightarrow{J_{\Gamma}} \mathbf{Al}(X)$$

as the composite

$$(\llbracket 2N-1 \rrbracket^{\mathbf{k}}, \mathcal{E}(N, \mathbf{k})) \xrightarrow{\circ} \mathfrak{B}(\llbracket 2N-1 \rrbracket^{\mathbf{k}}, \mathcal{E}(N, \mathbf{k})) \approx \{\{2N-2\}^{\mathbf{k}}_{\leq_e}\} \xrightarrow{J_{\Gamma}} \mathbf{Al}(X).$$

**11.5. The prismaticity of  $F_{\Gamma} \rtimes G^{-1}$ .** Here we will assemble the prismaticity properties of  $F_{\Gamma} \rtimes G^{-1}$  into a final lemma.

**Proposition 51.** *Let  $\Gamma \in \mathbf{GF}(X, \mathbf{k}, N)$  be a graph system satisfying **gf4**. If  $G$  is consistent with  $\Gamma$ , then the fiberwise homeomorphism  $(F_{\Gamma} \rtimes G^{-1})^1$  is  $\mathbf{J}_{\Gamma}$ -prismatic.*

*Proof.* Note that

$$\mathcal{E}(N, \mathbf{k}) = \Lambda(N, \mathbf{k})^c$$

(see Secs. 10.8 on page 74 and 6.1.4 on page 44). It follows from Proposition 42 on page 75 that for  $(x^*, t_{\mathbf{k}}^*) \in X \times \llbracket 2N - 1 \rrbracket^{\mathbf{k}}$  the following is true. If  $t_{\mathbf{k}}^* \in E_a$  and  $(x^*, t_{\mathbf{k}}^*) \in \Omega_c^1(\Gamma)$ , then  $c \leq_a^e$ . Comparing this fact with Propositions 42 on page 75 and 49 on page 80, we can see that the following assertion is true: if  $t_{\mathbf{k}}^* \in E_a$  and  $(F_{\Gamma} \rtimes G^{-1})^1$  is not horizontal at the point  $(x^*, t_{\mathbf{k}}^*)$ , then  $x^*$  is contained in  $\tilde{J}_{\Gamma}(a)$ . This means exactly the required  $\mathbf{J}_{\Gamma}$ -prismaticity of  $(F_{\Gamma} \rtimes G^{-1})^1$ .  $\square$

Thus the following objects are associated with a graph system  $\Gamma \in \mathbf{HGF}(X, \mathbf{k}, N, M)$ :

- an OPL Alexandroff topology  $\Theta = \Theta(M)$  on  $T^{\mathbf{k}}(N)$  and a morphism

$$\mathfrak{B}(\Theta) \xrightarrow{\zeta} \mathfrak{B}(\Psi) = \mathfrak{B}\left(\frac{1}{M}[I]^{\mathbf{k}}\right)^{\text{op}}$$

(see Sec. 10.11 on page 77);

- an OPL Alexandroff topology  $\mathcal{E} = \mathcal{E}(N)$  on  $T_1^{\mathbf{k}} = T_1^{\mathbf{k}}(N) \approx \llbracket 2N - 1 \rrbracket^{\mathbf{k}}$  and an Alexandroff presheaf  $(T_1^{\mathbf{k}}, \mathcal{E}) \xrightarrow{\mathbf{J}_{\Gamma}} \mathbf{AI}(\mathbf{X})$  (see Sec. 11.4 on page 81).

The topology  $\mathcal{E}$  on  $T_1^{\mathbf{k}}$  is inscribed into the topology  $\Theta^{\text{op}}|_{T_1^{\mathbf{k}}}$  on  $H_1^{\mathbf{k}}$ . The following lemma holds.

**Lemma 10.** *If a fiberwise homeomorphism  $G$  is consistent with  $\Gamma \in \mathbf{HGF}(X, \mathbf{k}, N, M)$ , then*

- $F_{\Gamma} \rtimes G^{-1}|_{H_1^{\mathbf{k}}}$  is  $\mathbf{J}_{\Gamma}$ -prismatic;
- if  $\mathcal{L} \in \mathbf{AI}(X)$  and  $G$  is  $\delta_{\mathcal{L}}$ -prismatic, then  $F_{\Gamma} \rtimes G^{-1}$  is  $\delta_{\mathcal{L}}$ -prismatic;
- if  $G|_{\partial I^{\mathbf{k}}}$  is prismatic with respect to an Alexandroff presheaf  $(\partial I^{\mathbf{k}}, \Psi|_{\partial I^{\mathbf{k}}}) \xrightarrow{\xi} \mathbf{AI}(X)$ , then  $F_{\Gamma} \rtimes G^{-1}|_{T_1^{\mathbf{k}}}$  is prismatic with respect to the Alexandroff presheaf

$$(60) \quad (T^{\mathbf{k}_1}, \Theta|_{T_1^{\mathbf{k}}}) \xrightarrow{\xi \circ \zeta|_{\mathfrak{B}(\Theta^{\text{op}}|_{T_1^{\mathbf{k}}})^{\text{op}}}} \mathbf{AI}(X).$$

*Proof.* Assertion (a) is a special case of Proposition 51 on the previous page. Assertion (b) follows from Proposition 39 on page 70. Assertion (c) follows from Propositions 50 on page 81 and 40 on page 70.  $\square$

12. HUDSON FUNCTIONS AND THEIR GRAPHS

Here we use a construction from [15, Theorem 6.2, p. 130, and its corollaries]. Hudson suggests especially simple functions needed for fragmentation.

Let  $K$  be a simplicial complex triangulating  $X$  and  $|K| \xrightarrow{t} X$  be a triangulation. Let  $f : |K| \rightarrow I$  be a function that is linear on all simplices of  $K$  (i.e.,  $f$  is determined by its values at the vertices of  $K$ ). We call such functions **Hudson functions on the simplicial complex  $K$** . A function  $X \xrightarrow{g} I$  that decomposes as

$$\begin{array}{ccc} X & \xrightarrow{g} & I \\ & \searrow^{t^{-1}} & \nearrow_f \\ & |K| & \end{array}$$

where  $f$  is a Hudson function on  $K$  will be called a **Hudson function on the triangulation  $t$  of  $X$** .

Denote by  $\text{Hud}(t)$  the set of all Hudson functions on  $t$ . **The diameter**  $\text{diam} f$  of a Hudson function  $f$  is defined as

$$\max_{\{x,y \in X\}} |f(x) - f(y)|.$$

The diameter measures the difference between  $f$  and a constant function. The set  $\text{Hud}_\delta(t)$  of all Hudson functions of diameter at most  $\delta$  is a compact finite-dimensional polyhedron (obviously, it is just a cube).

Let  $\mathcal{G}$  be a **compact family of homeomorphisms in  $\text{PL}_{I^k}(X)$** , i.e.,  $\mathcal{G} = \{G_b\}_{b \in B} \subset \text{PL}_{I^k}$ , where  $B$  is a compact polyhedron. The map  $B \times X \times I^k \xrightarrow{\mathcal{G}} X \times I^k$  defined by the correspondence  $(b, x, t_k) \mapsto G_b(x, t_k)$  is supposed to be piecewise linear.

Pick  $\mathbf{s} \subseteq \mathbf{k}$ . Consider a collection of functions  $f_{\mathbf{s}}, f_i \in \text{Hud}(t)$  indexed by  $\mathbf{s}$ . Consider the collection of subpolyhedra  $\Gamma_{\mathbf{s}}$ , where  $\Gamma_i = \{(x, t_k) \mid t_i = f_i(x)\}$ .

A homeomorphism  $G \in \text{PL}_{I^k}(X)$  is **consistent** with  $f_{\mathbf{s}}$  if both  $\Gamma_{\mathbf{s}}$  and  $G^{-1}(\Gamma_{\mathbf{s}})$  satisfy the condition **gf** from Sec. 10.1 on page 71.

**Proposition 52.** *Under our conditions, there exists  $\delta(\mathcal{G}) > 0$  such that if  $\text{diam} f_i \leq \delta$  for all  $i \in \mathbf{s}$ , then  $f_{\mathbf{s}}$  is consistent with all homeomorphisms from  $\mathcal{G}$ .*

*Proof.* We will apply Hudson’s arguments inductively by the number of functions in  $f_{\mathbf{s}}$ .

1. Let  $\#\{\mathbf{s}\} = 1$  and  $\mathbf{s} = \{i\}$ . We must prove that there exists  $\delta > 0$  such that if  $\text{diam} f_i \leq \delta$ , then every leaf

$$L_{(x^*, t_{\mathbf{k} \setminus \{i\}}^*)}(G) = \{(x, t_{\mathbf{k}}) \mid x = G(x^*)|_{t_{\mathbf{k}}}, t_{\mathbf{k} \setminus \{i\}} = t_{\mathbf{k} \setminus \{i\}}^*\}$$

of every  $G \in \mathcal{G}$  intersects  $\Gamma_i$  in a single point. Consider the projection  $X \times I^{\mathbf{k}} \xrightarrow{\pi_{\{i\}}} I^{\{i\}}$ . The homeomorphisms from  $\mathcal{G}$  are fiberwise with respect to  $\pi_i$ , therefore Hudson's arguments can be directly applied.

2. Assume that we can prove the assertion for  $\#\{\mathbf{s}\} \leq l - 1$ . Let  $\#\{\mathbf{s}\} = l$ .

Pick  $i \in \mathbf{s}$ . By the previous step, we can find  $\delta > 0$  such that if  $\text{diam}(f_i) \leq \delta$ , then  $f_i$  is consistent with  $\mathcal{G}$ . Given  $f_i$  and  $G$ , there is a homeomorphism  $W(f_i, G) \in \text{PL}_{I^{\mathbf{k} \setminus \{i\}}}(X)$  defined as follows. Denote by  $X \times I^{\mathbf{k} \setminus \{i\}} \xrightarrow{G^{-1}f_i} I^{\{i\}}$  the function with graph  $G^{-1}(\Gamma_i)$ . Set

$$W(f_i, G)|_{t_{\mathbf{k} \setminus \{i\}}}(x) = G|_{(t_{\mathbf{k} \setminus \{i\}}(x), t_i = G^{-1}f_i(x, t_{\mathbf{k} \setminus \{i\}}))}(x).$$

The set of homeomorphisms

$$\mathcal{W} = \{W(f_i, G)\}_{f_i \in \text{Hud}_\delta, G \in \mathcal{G}} \subset \text{PL}_{I^{\mathbf{k} \setminus \{i\}}}(X)$$

is a compact set of homeomorphisms from  $\text{PL}_{I^{\mathbf{k} \setminus \{i\}}}(X)$ . By the inductive assumption, for this set  $\delta$  exists for the set of Hudson functions  $f_{\mathbf{s} \setminus \{i\}}$ . It remains to observe that the set of Hudson functions  $f_{\mathbf{s} \setminus \{i\}}$ , which is consistent with  $\mathcal{W}$ , together with the Hudson function  $f_{\{i\}}$ , which is consistent with  $\mathcal{G}$ , forms a set  $f_{\mathbf{s}}$  consistent with  $\mathcal{G}$ .  $\square$

Let  $|K| \xrightarrow{t} X$  be a triangulation. Let  $\text{star}_v(t)$  be the cover of  $X$  by the open stars of  $t$ . Let  $\mathcal{G} \in \text{PL}_{I^{\mathbf{k}}}(X)$  be a compact family of homeomorphisms. Let  $N, M$  be positive integers. A **Hudson system** for the data  $\langle \mathcal{G}, N, M, t \rangle$  is a graph system  $\Gamma \in \mathbf{HGF}(X, \mathbf{k}, N, M)$  such that  $\Gamma$  is simultaneously consistent with all homeomorphisms from  $\mathcal{G}$  and  $\text{supp}(f_i^{j+1} - f_i^j) \in \text{star}_v(t)$  for all  $i, j$ .

As a result of the constructions of this section, we obtain the following assertion.

**Lemma 11.** *For any compact family of homeomorphisms  $\mathcal{G} \in \text{PL}_{I^{\mathbf{k}}}(X)$ , any triangulation  $|K| \xrightarrow{t} X$ , and any positive integer  $M$  there exist a positive integer  $N(\mathcal{G})$  and a Hudson system*

$$\mathbf{H}(\mathcal{G}, t, M) \in \mathbf{HGF}(X, \mathbf{k}, N(\mathcal{G}), M).$$

*Proof.* First, order the vertices of  $K$  in an arbitrary way:  $v_1, \dots, v_V$ . Choose a special sequence  $\{h_j\}_{j=0, \dots, V}$  of Hudson functions on  $K$ . Put  $h_0 \equiv 0$ ; for  $j = 1, \dots, V$ , define functions on the vertices by the following rule:

$$h_j(v_i) = \begin{cases} 1 & \text{for } i < j, \\ 0 & \text{for } i \geq j. \end{cases}$$

It is clear that  $0 = h_0 \leq h_1 \leq \dots \leq h_V$  and  $\text{supp}(h_{j+1} - h_j) = \text{star}(v_j)$ .

Further, choose  $\delta(\mathcal{G})$  by Proposition 52 on page 84 and choose a positive integer  $M$  such that  $\frac{1}{M} < \delta$ .

Now we can define the system of functions  $\{f_i^j\}_{i \in \mathbf{k}, j \in \{\{MV\}\}}$  that determines  $H(\mathcal{G}, t, M)$ . Put  $f_i^j = \frac{l}{M} + \frac{1}{M}h_{j'}$  for  $j = lV + j'$ ,  $0 < j' < V$ . □

12.1. Comparing Lemma 11 with Lemma 10, we can see that for a compact family of homeomorphisms  $\mathcal{G} \subset \text{PL}_{I^k}(X)$  and a Hudson system  $H(\mathcal{G}, t, M)$ , the image of the Alexandroff presheaf  $\mathbf{J}_{H(\mathcal{G}, t, M)}$  lies in the subposet  $\text{star}^k(t) \subset \mathbf{AI}(X)$  that is generated by the unions of at most  $k$  open stars of  $t$ .

### 13. SMALL BALLS, SEPARATION OF SMALL BALLS

We need a sequence of propositions on “separation” of configurations of balls on a simplicial manifold  $K$ . We say that a set of balls  $\{A_i\}_i \in \mathbf{D}^\infty(K)$  *separates* a (not necessarily disjoint) set of balls  $\{B_j\}_j$ ,  $B_j \subset |K|$ , if  $\cup_i B_j \subseteq_{\overline{X}} \cup_i A_i$ .

Consider a compact simplicial geometric  $n$ -dimensional PL manifold  $K$ . Denote by  $\text{star}(K)$  the cover of  $|K|$  by the closed stars of  $K$ . Denote by  $\text{sd}_i K$  the  $i$ th barycentric subdivision of  $K$ .

**Proposition 53.** *If  $i \geq j \geq 0$ , then  $\text{star}(\text{sd}_i K)$  is inscribed into  $\text{star}(\text{sd}_j K)$ .*

*Proof.* This is a general property of subdivisions of simplicial complexes:

$$K_0 \trianglelefteq K_1 \Rightarrow \text{star}(K_0) \text{ is inscribed into } \text{star}(K_1).$$

□

**Proposition 54.** *For any two balls  $a, b \in \text{star}(\text{sd}_2 K)$  such that  $a \cap b \neq \emptyset$  there exists  $c \in \text{star}(K)$  such that  $a \cup b \subseteq c$ .*

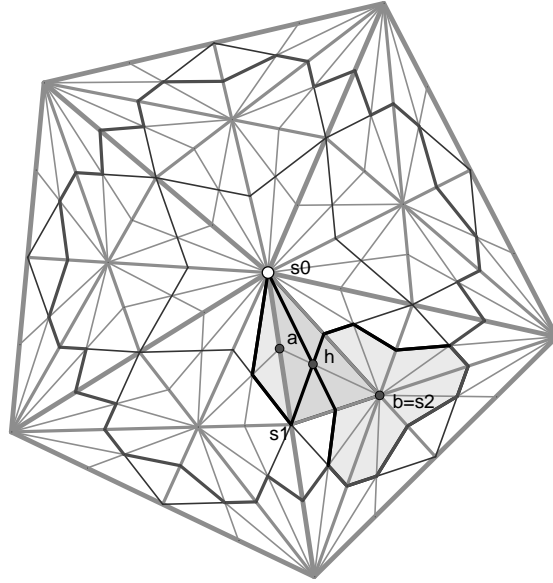

FIGURE 15.

*Proof.* Recall that the vertices of  $sd_1 K$  are indexed by the simplices of  $K$ , the edges of  $sd_1 K$  are indexed by the 2-flags of simplices of  $K$ ,  $\dots$ , the  $k$ -simplices of  $sd_1 K$  are indexed by the  $k$ -flags of  $K$ . Thus let  $a, b \in star\ sd_2 K$  and  $a \cap b \neq \emptyset$ . Let  $t$  be a vertex of  $sd_2 K$ ,  $t \in a \cap b$ . The complex  $sd_2 K$  is covered by  $sd_1 K$ , therefore the vertex  $t$  belongs to some complete flag  $s_0, \dots, s_n$ . We claim that the closed star  $|star_K(s_0)|$  contains  $|a \cup b|$  (see Fig. 15). This follows from two observations:

1. The simplicial ball  $sd_2 star_K(s_0)$  is a full subcomplex of  $sd_2 K$ . This means that if all vertices of some simplex from  $sd_2 K$  belong to  $sd_2 star_K(s_0)$ , then the simplex itself belongs to  $sd_2 star_K(s_0)$ .
2. The minimum length of a chain of edges connecting  $t$  with a vertex of  $sd_2 link_K(s_0)$  is at least 2. Therefore the minimum length of a chain of edges connecting  $t$  with a vertex that does not belong to  $sd_2 star_K(s_0)$  is at least 3. While the minimum length of a chain of edges connecting  $t$  with a vertex of  $a \cap b$  is at most 2.

It follows from the second observation that all vertices of  $a \cap b$  belong to  $sd_2 star_K(s_0)$ . Therefore, by the first observation, all simplices of  $a \cap b$  belong to  $sd_2 star_K(s_0)$ .  $\square$

It is easy to verify the following assertion.

**Proposition 55.** *If  $i \geq 2$ , then the star of a simplex from  $\text{sd}_i K$  either is itself a ball consistent with  $K$ , or is contained in a star of  $\text{sd}_{i-1} K$  consistent with  $K$ .*

Consider the set  $\mathbf{B}(X)$  of all closed PL balls embedded into  $X$ . Denote by  $\mathbf{B}^\infty(X)$  the set of all finite subsets in  $\mathbf{B}(X)$ . There are two partial orders on  $\mathbf{B}^\infty(X)$ :

- the order **by inclusion**:

$$\{B_i\}_i \sqsubseteq \{C_j\}_j \Leftrightarrow \{B_i\}_i \underset{\mathbf{B}(X)}{\subseteq} \{C_j\}_j,$$

- the order by **covering**:

$$\{B_i\}_i \preceq \{C_j\}_j \Leftrightarrow \cup_i B_i \underset{X}{\subseteq} \cup_j C_j.$$

Consider the infinite sequence

$$K = \text{sd}_0 K \supseteq \text{sd}_1 K \supseteq \text{sd}_2 K \supseteq \dots$$

Set  $\mathbf{S}_l K = \cup_{i \geq l} \text{star } \text{sd}_i K \subset \mathbf{B}(|K|)$ .

**Proposition 56** (On separation of small consistent balls). *Let us be given  $m$   $K$ -consistent balls from  $\mathbf{S}_i K$ ,  $i \geq 3m - 2$ . Then they can be separated by a collection of at most  $m$  disjoint  $K$ -consistent balls from  $\mathbf{S}_{i-3(m-1)} K$ .*

*Proof.* Induction by  $m$ . If  $m = 1$ , then the assertion is trivial. Assume that it is true for  $m = k - 1$ ,  $k \geq 2$ .

Let us be given a collection  $A = \{a_1, \dots, a_k\}$  of  $K$ -consistent balls from  $\mathbf{S}_i K$ . If the balls from  $A$  are disjoint, then the assertion is true. Otherwise  $a_i \cap a_j \neq \emptyset$  for some pair  $i, j \in \{1, \dots, k\}$ ,  $i \neq j$ . Applying Propositions 53 and 54 and using the fact that  $\text{sd}_i K = \text{sd}_2 \text{sd}_{(i-2)} K$ , we can find a ball  $c' \in \mathbf{S}_{i-2} K$  such that  $a_i \cup a_j \subset c'$ . By assumption,  $i \geq 3k - 2$  and  $k \geq 2$ . Therefore the inequality  $i - 2 \geq 3k - 4 \geq 2$  holds, and the conditions of Proposition 55 are satisfied for the ball  $c'$ . Therefore there exists a  $K$ -consistent ball  $c \in \mathbf{S}_{i-3} K$  that contains  $c'$ . Consider the new set of  $K$ -consistent balls  $B = \{c\} \cup (A \setminus \{a_i, a_j\})$ . By construction, the set  $B$  covers  $A$ , consists of  $k - 1$  elements, and belongs to  $\mathbf{S}_{i-3}$ . By the inductive assumption, for the set of balls  $B$  the assertion is true. By the transitivity of  $\preceq$ , the inductive step is proved.  $\square$

Denote by  $\mathbf{S}_j^i K \subset \mathbf{B}^\infty(|K|)$  the set of all unordered collections of at most  $i$  balls from  $\mathbf{S}_j K$ . Obviously, the order  $\sqsubseteq$  on  $\mathbf{B}^\infty(|K|)$  is stronger than  $\preceq$ , i.e.,  $(A \sqsubseteq B) \Rightarrow (A \preceq B)$ . Denote by  $\mathbf{B}^\infty(|K|)_{\sqsubseteq} \xrightarrow{\beta} \mathbf{B}^\infty(|K|)_{\preceq}$  the morphism of weakening the order. The poset  $(\mathbf{S}_j^i K)_{\preceq}$  will be denoted by  $\mathbf{T}_j^i K$ , and the poset  $(\mathbf{S}_j^i K)_{\sqsubseteq}$  will be denoted



by the same symbol  $\mathbf{S}_j^i K$ . Let  $\mathbf{D}_j^i K \hookrightarrow \mathbf{T}_j^i K$  be the subposet of  $\mathbf{T}_j^i K$  formed by all disjoint collections of  $K$ -consistent balls.

Obviously,  $\mathbf{S}_{j_0}^{i_0} K \hookrightarrow \mathbf{S}_{j_1}^{i_1} K$  and  $\mathbf{T}_{j_0}^{i_0} K \hookrightarrow \mathbf{T}_{j_1}^{i_1} K$  if  $i_0 \leq i_1$  and  $j_0 \geq j_1$ . That is,  $\mathbf{S}_\bullet K$  and  $\mathbf{T}_\bullet K$  are double filtrations of  $\mathbf{S}_0^\infty K$  and  $\mathbf{T}_0^\infty K$ , respectively.

13.1. We need a special notation: denote by  $\tilde{m}$  the number  $3(\sum_{j=1}^{j=m} l! - m)$ . It satisfies the recurrence  $\tilde{m} = \widetilde{m-1} + 3(m! - 1)$ . The composite

$$\mathbf{S}_i^m K \xrightarrow{\beta} \mathbf{T}_i^m K \hookrightarrow \mathbf{T}_{i-\tilde{m}-1}^{m!} K$$

will be denoted by  $\alpha_i^m$ .

**Proposition 57** (On functorial separation of small balls). *For any geometric simplicial manifold  $K$ , any positive integer  $m$ , and any  $i \geq \tilde{m} + 2$ , there exists a natural transformation  $\theta_i^m$  of the poset morphism  $\mathbf{S}_i^m K \xrightarrow{\alpha_i^m} \mathbf{T}_{i-\tilde{m}-1}^{m!} K$  into a poset morphism  $\mathbf{S}_i^m K \xrightarrow{\gamma_i^m} \mathbf{D}_{i-\tilde{m}-1}^{m!} K \hookrightarrow \mathbf{T}_{i-\tilde{m}-1}^{m!} K$ .*

*Proof.* Induction on  $m$ .

1. Let  $m = 1$ . Then  $m! = 1$ ,  $\tilde{m} = 0$ , and the poset structure on  $\mathbf{S}_i^m K$  is trivial. Set  $\mathbf{S}_i^m K \xrightarrow{\gamma_i^1} \mathbf{D}_{i-1}^1 K$ . According to Proposition 55, for every ball  $B \in \mathbf{S}_i^m$  we can choose a larger  $K$ -consistent ball  $\gamma_i^1(B)$  from  $\mathbf{D}_{i-1}^1 K$ . We have  $B \subseteq \gamma_i^1(B)$ , i.e.,  $\alpha_i^1(B) \preceq \gamma_i^1(B)$ , and  $\theta_i^1$  is defined.

2. Assume that  $\theta_i^{m-1}, \gamma_i^{m-1}$  are already constructed. Note that  $\mathbf{S}_j^i K, \mathbf{T}_j^i K$  are truncated upper semilattices (the supremum exists provided that there exists an upper bound). The semilattice  $\mathbf{S}_j^i K$  is free. Consider the diagram

$$(61) \quad \begin{array}{ccc} \mathbf{S}_i^m K & \xrightarrow{\delta_m} & \mathbf{T}_{i-\tilde{m}-1}^{m!} K \\ \uparrow & & \uparrow \\ \mathbf{S}_i^{m-1} K & \xrightarrow{\gamma_i^{m-1}} & \mathbf{D}_{i-\tilde{m}-1}^{(m-1)!} K \end{array}$$

Since  $\mathbf{S}_i^m K$  is free, the extension  $\delta_m$  is canonically defined on the set  $\{A_i\}_{i=1}^m \in \mathbf{S}_i^m K$  by the rule

$$\delta_m(\{A_i\}_{i=1}^m) = \vee_{i=1}^m \gamma_i^{m-1}(\{A_j\}_{j \in \{1, \dots, m\} \setminus \{i\}}).$$

Therefore  $\delta_m(\{A_i\}_{i=1}^m)$  has at most  $m!$  balls. Since  $\mathbf{S}_i^m$  is free, it follows that if we choose, according to Proposition 56 on the previous page, an arbitrary separating

cover  $\delta_m(\{A_i\}_{i=1}^m)$ , then we will obtain a natural transformation  $\delta_m \xrightarrow{\vartheta_m} \gamma_m$  of the functor  $\delta_m$  into some functor

$$\mathbf{S}_i^m K \xrightarrow{\gamma_m} \mathbf{D}_{i-\tilde{m}-1}^{m!} K.$$

Now we can put  $\theta_m = \vartheta_m \psi_m$ , where  $\psi_m$  is canonically defined by the commutativity of the square of natural transformations

$$\begin{array}{ccc} \alpha_i^m & \xrightarrow{\psi_m} & \delta_m \\ \uparrow & & \uparrow \\ \alpha_i^{m-1} & \xrightarrow{\theta_{m-1}} & \gamma_i^{m-1}. \end{array} \quad (61)$$

Here the left arrow is the canonical embedding as a subfunctor, and the right arrow is the embedding defined by diagram (61).  $\square$

#### 14. LEMMA ON PRISMATIC FRAGMENTATION OF FIBERWISE HOMEOMORPHISMS OVER THE CUBE

Here we assemble the knowledge collected in Secs. 9–13 into a lemma which is a multidimensional generalization of Hudson’s isotopy fragmentation.

**Lemma 12** (On prismatic fragmentation of fiberwise homeomorphisms over the cube). *Assume that the following data are fixed:  $\mathbf{Q} \in \mathbf{R}(X)$ , a set of homeomorphisms  $G_1, \dots, G_m, U \in \text{PL}_{I^k}(X)$ , a triangulation  $\mathbf{K} \trianglelefteq \mathbf{Q}$ , a positive integer  $M \geq 1$ , an Alexandroff presheaf*

$$\left(\partial \frac{1}{M}[I^k]\right)^{\text{op}} \xrightarrow{\xi} \mathbf{D}_c^\infty(K).$$

*Assume that the homeomorphisms  $G_1, \dots, G_m$  are  $\delta_{\mathbf{Q}}$ -prismatic and the homeomorphisms  $G_1|_{\partial I^k}, \dots, G_m|_{\partial I^k}, U|_{\partial I^k}$  are  $\xi$ -prismatic.*

*Then there exist*

- *homeomorphisms  $\tilde{G}_1, \dots, \tilde{G}_m, \tilde{U} \in \text{PL}_{I^k \times I}(X)$  such that  $\tilde{G}_i|_{I^k \times \{0\}} = G_i, \tilde{U}|_{I^k \times \{0\}} = U$ ,*
- *an OPL Alexandroff topology  $\mathcal{T}$  on the cubic bucket  $\Xi = \partial I^k \times I \cup I^k \times \{1\}$  such that  $\mathcal{T}|_{\partial I^k \times \{0\}} = \left(\partial \frac{1}{M}[I^k]\right)^{\text{op}}$ ,*
- *an Alexandroff presheaf  $(\Xi, \mathcal{T}) \xrightarrow{\tilde{\xi}} \mathbf{D}_c^\infty(K)$  extending  $\xi$  such that  $\tilde{G}_1, \dots, \tilde{G}_m$  are  $\delta_{\mathbf{Q}}$ -prismatic and  $\tilde{G}_1|_{\Xi}, \dots, \tilde{G}_m|_{\Xi}, \tilde{U}|_{\Xi}$  are  $\tilde{\xi}$ -prismatic. If the homeomorphism  $U$  is  $\delta_{\mathbf{Q}}$ -prismatic, then the homeomorphism  $\tilde{U}$  can be chosen to be  $\delta_{\mathbf{Q}}$ -prismatic.*

*Proof.* 0. In the proof we construct the following:

- six data sets  $\langle G_1^j, \dots, G_m^j, U^j, \mathcal{T}^j, \xi^j \rangle$ , where  $G_i^j, U^j \in PL_{I^k}$ ,  $j = 0, \dots, 5$ ,  $\mathcal{T}^j$  is an Alexandroff topology on  $\partial I^k$ ,  $(\partial I^k, \mathcal{T}^j) \xrightarrow{\xi^j} \mathbf{D}_c^\infty(K)$ ;
- five data sets  $\langle G_1^{j,j+1}, \dots, G_1^{j,j+1}, U^{j,j+1}, \mathcal{T}^{j,j+1}, \xi^{j,j+1} \rangle$ , where  $G_i^{j,j+1}, U^{j,j+1} \in PL_{I^k \times I}$ ,  $j = 0, \dots, 4$ ,  $(\partial I^k \times I, \mathcal{T}^{j,j+1}) \xrightarrow{\xi^{j,j+1}} \mathbf{D}_c^\infty(K)$ ;
- a topology  $\mathcal{E}$  on  $I^k$  and an Alexandroff presheaf  $(I^k, \mathcal{E}) \xrightarrow{\psi} \mathbf{D}_c^\infty(K)$  such that
  - $G_i^{j,j+1}|_{I^k \times 0} = G_i^j$ ,
  - $G_i^{j,j+1}|_{I \times 1} = G_i^{j+1}$ ,
  - $U^{j,j+1}|_{I \times \{0\}} = U^j$ ,
  - $U_i^{j,j+1}|_{I \times \{1\}} = U^{j+1}$ ,
  - $h^0 \xi^{j,j+1} = \xi^j$ ,  $h^1 \xi^{j,j+1} = \xi^{j+1}$ ,
  - $G_i^0 = G_i$ ,  $U_i^0 = U$ ,  $\xi^0 = \xi$ ,  $\partial \psi = \xi^5$ ,
  - $G_i^j|_{\partial I^k}$ ,  $U^j|_{\partial I^k}$  are  $\xi^j$ -prismatic,
  - $G_i^5, U^5$  are  $\psi$ -prismatic,  $G_i^{j,j+1}|_{\partial I^k}$ ,  $U^{j,j+1}|_{\partial I^k}$  are  $\xi^{j,j+1}$ -prismatic,
  - all  $G_i^j, G_i^{j,j+1}$  are  $Q$ -prismatic,
  - $U^j, U^{j,j+1}$  are  $Q$ -prismatic if  $U$  is  $Q$ -prismatic.

Having all these data, we can past them, according to Proposition 29 on page 55, into homeomorphisms on  $PL_{I^k \times [0,5]}$  using the scheme presented at the figure below.

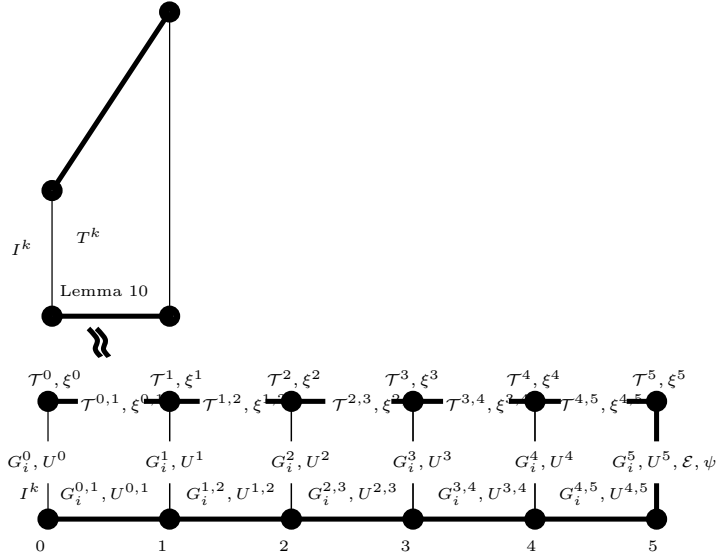

Then, making a linear change of coordinates in the base, we will obtain the required homeomorphisms from  $PL_{I^k \times I}$ .

- Using Proposition 35 on page 62, build some Alexandroff presheaf

$$(\partial I^k, \mathcal{A}(\frac{1}{M}\partial I^k)) \xrightarrow{\eta} \mathbf{D}_c^\infty(K)$$

such that  $\eta > \xi$ .

- Choose a simplicial subdivision  $K' \trianglelefteq K$  that simultaneously subdivides all balls in all configurations  $\eta(y)$ ,  $y \in \partial I^k$ , and in all configurations  $\xi(y)$ ,  $y \in \partial I^k$ . There are finitely many such balls, therefore  $K'$  exists.

- Using Lemma 11 on page 85, construct a number  $N$  and a Hudson graph system  $\mathcal{H} = \mathcal{H}(\{G_1, \dots, G_m, U\}, \text{sd}_{\bar{k}} K', M) \in \mathbf{HGF}(X, k, N, M)$ , where  $\text{sd}_{\bar{k}}$  is defined in Sec. 13.1 on page 89.

- Construct  $G^{0,1}, U^{0,1}, \mathcal{T}^{0,1}, \xi^{0,1}$ .

We apply Lemma 10 on page 83. Consider the following fiberwise homeomorphisms of the trivial bundle  $X \times T^k \xrightarrow{\pi_2} T^k$ :  $\overline{G}_i^{0,1} = F_{\mathcal{H}} \times G_i$ ,  $i = 1, \dots, m$ , and  $\overline{U}^{0,1} = F_{\mathcal{H}} \times U$ . On  $T^k$  we have the Alexandroff topology  $\Theta(M)$ . Proposition 11 on page 39 defines a PL homeomorphism  $\varphi$ , which is also a homeomorphism of Alexandroff spaces:

$$\begin{array}{ccc} (T^k, \Theta) & \xrightarrow{\varphi} & (\frac{1}{M}[I^k])^{\text{op}} \times I^{\text{triv}} \\ & \searrow & \swarrow \\ & I^{\text{triv}}; & \end{array}$$

besides,  $\varphi$  has the following properties:  $\varphi|_{H_0^k} = \text{id}$ ,  $\varphi(H_1^k) = I^k \times \{1\}$ ,  $\varphi(W^k) = (\partial I^k) \times I$ . Put  $G_i^{0,1} = \overline{G}_i^{0,1} \circ \varphi^{-1}$ ,  $i = 1, \dots, m$ , and  $U^{0,1} = \overline{U}^{0,1} \circ \varphi^{-1}$ .

According to assertion (b) of Lemma 10, the homeomorphisms  $G_i^{0,1}$  are  $\mathbf{Q}$ -prismatic and the homeomorphism  $U^{0,1}$  is  $\mathbf{Q}$ -prismatic if  $U$  is  $\mathbf{Q}$ -prismatic.

Define  $\mathcal{T}^{0,1}$  as  $\varphi^{-1}\Theta = \mathcal{A}^c(\partial \frac{1}{N}[I^k] \times I^{\text{triv}})$ . Define  $\overline{\xi}^{0,1}$  according to (60) and put  $\xi^{0,1} = \overline{\xi}^{0,1} \circ \varphi^{-1} : (\partial I^k \times I, \mathcal{T}^{0,1}) \rightarrow \mathbf{D}_c^\infty(K)$ . By assertion (c) of Lemma 10 on page 83, the homeomorphisms  $G_i^{0,1}|_{(\partial I^k) \times I}$  and  $U^{0,1}|_{(\partial I^k) \times I}$  are  $\xi^{0,1}$ -prismatic.

- Define  $G_i^j, U^j, G_i^{j,j+1}, U^{j,j+1}$  for  $j \geq 1$ .

Put  $G_i^1 = G_i^{0,1}|_{I^k \times \{1\}}$  and  $U^1 = U^{0,1}|_{I^k \times \{1\}}$ . For  $j \geq 1$ , put  $G_i^j \equiv G_i^1$  and  $G_i^{j,j+1} \equiv G_i^1 \times \text{id}$ . Put  $U^j \equiv U^1$  and  $U^{j,j+1} \equiv U^1 \times \text{id}$ .

- Define  $\mathcal{E}$  and  $\psi$ .

6.1. According to assertion (a) of Lemma 10, the homeomorphisms  $G_i^1$  are  $\mathbf{J}' (= \mathbf{J}_{\mathcal{H}} \circ \varphi^{-1})$ -prismatic, where  $(I^k, \mathcal{E} = \varphi^{-1}\mathcal{E}(N)) \xrightarrow{\mathbf{J}' } \mathbf{Al}(X)$  and the topology  $\mathcal{E}|_{\partial I^k}$  is inscribed into the topology  $\mathcal{A}(\frac{1}{M}\partial[I^k])$  on  $I^k$ .

6.2. We can apply Proposition 57 on page 89 to  $\mathbf{J}'$  and obtain an Alexandroff presheaf  $(I^k, \mathcal{E}) \xrightarrow{\psi} \mathbf{D}_c^{kl}(\text{sd}_1 K')$  such that  $G_i^1$  and  $U^1$  are  $\psi$ -prismatic.

7. Define  $\mathcal{T}^{1,2}, \xi^{1,2}, \mathcal{T}^2, \xi^2$ .

Note that the topology  $\mathcal{A}(\frac{1}{M}\partial[I^k])$  is dense (see Sec. 6.4 on page 45), therefore, by Proposition 15 on page 46, there exists a morphism  $\mathfrak{B}\partial(I^k, \mathcal{E}) \xrightarrow{\phi} \mathfrak{B}(\frac{1}{M}\partial[I^k])^{\text{op}}$  such that for every  $E \in \mathfrak{B}(I^k, \mathcal{E})$  the inclusion  $E \subset \phi(E)$  holds. Now we can apply Proposition 22 on page 49 to  $\xi^1 = \xi$  and  $\phi$ . Put  $\mathcal{T}^2 = \partial\mathcal{E}, \xi^2 = \xi^1 \circ \phi \circ \circ : (\partial I^k, \mathcal{E}^2) \rightarrow \mathbf{D}_c^\infty(K)$ . Put  $\mathcal{T}^{1,2} = \widetilde{\text{Cyl}}_\phi$  and  $\xi^{1,2} = \widetilde{\text{Cyl}}_\phi(\xi^1, \xi^2)$ . Proposition 22 on page 49 states that  $G_i^{1,2}, U^{1,2}$  are prismatic with respect to  $\xi^{1,2}$ .

Put  $\mathcal{T}^5 = \mathcal{T}^4 = \mathcal{T}^3 = \mathcal{T}^2 = \partial\mathcal{E}$ .

8. Define  $\xi^{2,3}$ .

Put  $\xi^3 = \eta \circ \phi \circ \circ : \partial(I^k, \mathcal{E}) \rightarrow \mathbf{D}_c^\infty(K)$ . We have  $\eta > \xi$ , therefore  $\xi^2 < \xi^3$ . Apply Proposition 32 on page 58 for  $\alpha = \xi^2, \beta = \xi_3, w = \text{id}$ . Define  $\mathcal{T}^{2,3} = \underline{\text{Cyl}}_{\text{id}}$ ,  $\xi^{2,3} = \underline{\text{Cyl}}_{\text{id}}(\xi^3, \xi^2)$ . By Proposition 32 on page 58, the homeomorphisms  $G_i^{2,3}, U^{2,3}$  are prismatic with respect to  $\xi^{2,3}$ .

9. Define  $\xi^{3,4}, \xi^{4,5}$ .

Build a morphism  $\partial(I^k, \mathcal{E}) \xrightarrow{\xi^4} \mathbf{D}_c^{kl} \text{sd}_1 K'$ . The morphism  $\xi^4$  is defined as follows:  $\xi^4(b) = \{\text{all the balls from } \psi(b) \text{ having a common point with a ball from } \xi^2(b)\}$ . The homeomorphisms  $G_i^3, U^3$  are  $\xi^2$ -prismatic and  $\psi$ -prismatic, therefore they are  $\xi^4$ -prismatic. By construction,  $\psi|_{\partial I^k} = \xi^5 > \xi^4 < \xi^3$ . Applying Proposition 31 on page 56 to  $\xi^3, \xi^4, \text{id}$ , we obtain  $\xi^{3,4} = \underline{\text{Cyl}}_{\text{id}}(\xi^3, \xi^4)$ . Applying Proposition 32 on page 58 to  $\xi^4, \xi^5, \text{id}$ , we obtain  $\xi^{4,5} = \underline{\text{Cyl}}_{\text{id}}(\xi^4, \xi^5)$ .  $\square$

## 15. THE PROOF OF THE LEMMA ON A COMMON $\mathbf{R}(X)$ -TRIANGULATION OF FIBERWISE HOMEOMORPHISMS

Here we will prove Lemmas 13 and 14. The latter is the  $\frown$ -lemma for the pair  $(\underline{\text{Prism}}^m(X) \times \text{PL}(X), \underline{\text{Prism}}^{m+1}(X))$ . This will complete the proof of Theorem A.

15.1. **Local lemma.** Here we prove that some data related to the prismaticity of a family of fiberwise homeomorphisms over a simplicial bucket can be extended to similar data over the filling of the bucket.

Fix the following data:

- $Q \in \mathcal{N}_k \mathbf{R}(X)$ ,  $Q = (Q_0 \leq Q_1 \leq \dots \leq Q_k)$ ,
- the standard  $Q$ -coloring of the ordered simplicial complex  $[\Delta^k]$  and the Alexandroff presheaf  $(\Delta^k, \mathcal{A}^c([\Delta^k])) \xrightarrow{\text{Max}Q} \mathbf{R}(X)$  generated by the coloring (see (26)),
- the prism  $\Delta^k \times I$  with the structure of the ball complex  $[\Delta^k] \times [0, 1]$ ,
- the Alexandroff presheaf

$$(\Delta^k \times I, \mathcal{A}^c([\Delta^k] \times [0, 1])) \xrightarrow{\alpha(Q)=\text{Max}Q|_{\pi}} \mathbf{R}(X)$$

induced by the projection  $[\Delta^k] \times [0, 1] \xrightarrow{\pi} [\Delta^k]$ ,

- the “lower simplicial bucket”

$$\underline{\Gamma}^k = \Delta^k \times \{0\} \cup \partial\Delta^k \times I \subset \Delta^k \times I$$

with the ball structure  $[\underline{\Gamma}^k]$  induced by the embedding,

- an OPL Alexandroff topology  $\mathcal{T}$  on the rim

$$\partial\Delta^k \xrightarrow{\text{id} \times \{1\}} \underline{\Gamma}^k$$

of the bucket,

- a common triangulation  $K \leq Q_i$ ,  $i = 0, \dots, k$ ,
- an Alexandroff presheaf  $(\partial\Delta^k \times \{1\}, \mathcal{T}) \xrightarrow{\xi} \mathbf{D}_c^\infty(K)$ ,
- a set of fiberwise homeomorphisms over the bucket:

$$G_1, \dots, G_m, U \in \text{PL}_{\underline{\Gamma}^k}(X).$$

**Lemma 13.** *Assume that our data satisfy the following conditions:*

- (1) *the homeomorphisms  $G_1, \dots, G_m$  are  $\alpha(Q)|_{\underline{\Gamma}^k}$ -prismatic,*
- (2) *the homeomorphisms  $G_1|_{\partial\Delta^k \times \{1\}}, \dots, G_m|_{\partial\Delta^k \times \{1\}}, U|_{\partial\Delta^k \times \{1\}}$  are  $\xi$ -prismatic,*
- (3) *if the homeomorphism  $U|_{d_i\Delta^k \times \{0\}}$  is  $\alpha(Q)|_{d_i\Delta^k \times \{0\}}$ -prismatic, then its extension  $U|_{d_i\Delta^k \times I}$  to the wall of the bucket is  $\alpha(Q)|_{d_i\Delta^k \times I}$ -prismatic.*

*Then there exist*

- *an OPL Alexandroff topology  $\tilde{\mathcal{T}}$  on  $\Delta^k \times \{1\}$ ,*
- *an Alexandroff presheaf  $(\Delta^k \times \{1\}, \tilde{\mathcal{T}}) \xrightarrow{\tilde{\xi}} \mathbf{D}_c^\infty(K)$ ,*
- *a set of fiberwise homeomorphisms  $\tilde{G}_1, \dots, \tilde{G}_m, \tilde{U} \in \text{PL}_{\Delta^k \times I}(X)$*

*such that*

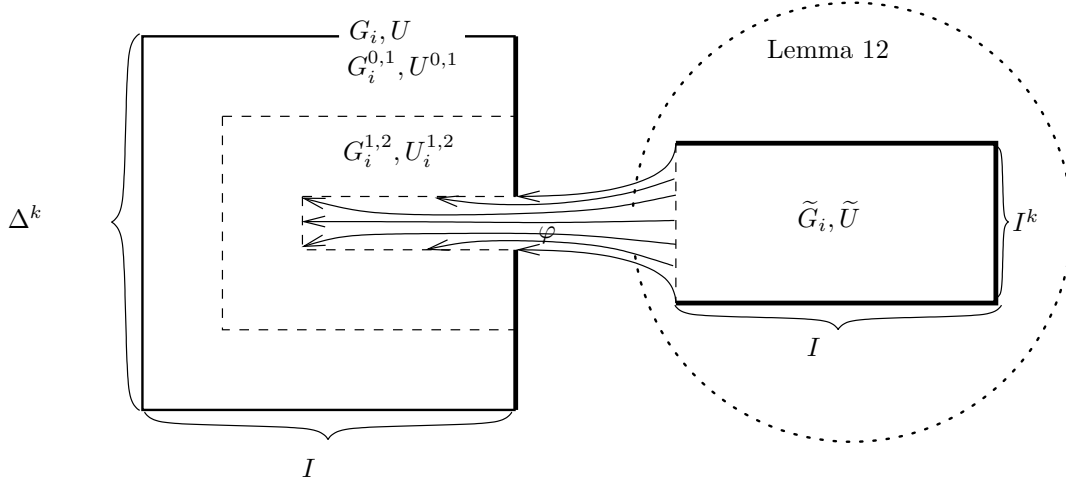

FIGURE 16.

- (1)  $\tilde{\mathcal{T}}_{[\partial\Delta^k \times \{1\}]} = \mathcal{T}$ ,  $\tilde{\xi}_{[\partial\Delta^k \times \{1\}]} = \xi$ ,
- (2)  $\tilde{G}_i|_{\Gamma^k} = G_i$ ,  $i = 1, \dots, m$ ,  $\tilde{U}|_{\Gamma^k} = U$ ,
- (3)  $\tilde{G}_i|_{\Delta^k \times \{1\}}$ ,  $i = 1, \dots, m$ , and  $\tilde{U}|_{\Delta^k \times \{1\}}$  are  $\tilde{\xi}$ -prismatic,
- (4)  $\tilde{G}_i$ ,  $i = 1, \dots, m$ , are  $\alpha(Q)$ -prismatic; if  $U|_{\Delta^k \times \{0\}}$  is  $Q$ -prismatic, then one can choose  $\tilde{U}$  to be  $\alpha(Q)$ -prismatic.

*Proof.* We construct a filling  $\tilde{\mathcal{T}}$ ,  $\tilde{\xi}$ ,  $\tilde{G}_i$ ,  $i = 1, \dots, m$ ,  $\tilde{U}$  of the bucket from three pieces (see Fig. 16). The last, principal, piece will be obtained from Lemma 12. The two first pieces are needed to adjust our data to take the form required for applying Lemma 12.

1. We need the following data:

- a homeomorphism  $I^k \xrightarrow{\varphi} \Delta^k$  of the cube onto the simplex,
- $G_i^{j,j+1} \in \text{PL}_{\Gamma^k \times I}(X)$ ,  $i = 1, \dots, m$ ,  $j = 0, 1$ ,  $U^j \in \text{PL}_{\Delta^k \times I}$ ,  $j = 0, 1$ ,
- $\hat{G}_i \in \text{PL}_{I^k \times I}(X)$ ,  $i = 1, \dots, m$ ,  $\hat{U} \in \text{PL}_{I^k \times I}(X)$ ,
- Alexandroff topologies  $\mathcal{T}^{j,j+1}$  on  $\partial\Delta^k \times I$  and an Alexandroff topology  $\hat{\mathcal{T}}$  on the upper cubic bucket  $\bar{\Xi}^k = \partial I^k \times I \cup I^k \times \{1\}$ ,
- morphisms  $(\partial\Delta^k \times I, \mathcal{T}^{j,j+1} \xrightarrow{\xi^{j,j+1}} \mathbf{D}_c^\infty(K))$  for  $j = 0, 1$  and a morphism  $(\bar{\Xi}^k, \hat{\mathcal{T}}) \xrightarrow{\hat{\xi}} \mathbf{D}_c^\infty(K)$ .

Assume that the following conditions are satisfied:

- (a)  $G_i^{0,1}|_{\Gamma^k \times \{0\}} = G_i$ ,  $i = 1, \dots, m$ ;  $U^{0,1}|_{\Gamma^k \times \{0\}} = U$ ;  $\xi^{0,1}|_{\partial\Delta \times \{0\}} = \xi$ ;
- (a1)  $G_i^{0,1}$ ,  $i = 1, \dots, m$ , are  $\delta_{Q_k}$ -prismatic;  $U^{0,1}$  is  $\delta_{Q_k}$ -prismatic if  $U$  is  $\alpha(Q)$ -prismatic;
- (a2)  $G_i^{0,1}|_{\partial\Delta^k \times \{1\} \times I}$  and  $U_i^{0,1}|_{\partial\Delta^k \times \{1\} \times I}$  are  $\xi^{0,1}$ -prismatic;
- (b)  $G_i^{1,2}|_{\Gamma^k \times \{0\}} = G_i^{0,1}|_{\Gamma^k \times \{1\}} = G_i^1$ ,  $i = 1, \dots, m$ ;  $U^{1,2}|_{\Gamma^k \times \{0\}} = U^{0,1}|_{\Gamma^k \times \{1\}} = U^1$ ;  $\xi^{1,2}|_{\partial\Delta \times \{0\}} = \xi^{0,1}|_{\partial\Delta \times \{1\}}$ ;
- (b1)  $G_i^{1,2}$ ,  $i = 1, \dots, m$ , are  $\delta_{Q_k}$ -prismatic;  $U^{1,2}$  is  $\delta_{Q_k}$ -prismatic if  $U^{0,1}|_{\Gamma^k \times \{1\}}$  is  $\delta_{Q_k}$ -prismatic;
- (b2)  $G_i^{1,2}|_{\partial\Delta^k \times \{1\} \times I}$  and  $U_i^{1,2}|_{\partial\Delta^k \times \{1\} \times I}$  are  $\xi^{1,2}$ -prismatic;
- (c)  $\widehat{G}_i|_{I^k \times \{0\}} = (G^{1,2}|_{\Gamma^k \times \{1\}})|_{\varphi} = G_i^2$ ,  $i = 1, \dots, m$ ;  $\widehat{U}|_{I^k \times \{0\}} = (U^{1,2}|_{\Gamma^k \times \{1\}})|_{\varphi} = U^2$ ;  $\widehat{\xi}|_{I^k \times \{0\}} = (\xi^{1,2}|_{\Gamma^k \times \{1\}})|_{\varphi}$ ;
- (c1)  $\widehat{G}_i$ ,  $i = 1, \dots, k$ , are  $\delta_{Q_k}$ -prismatic;  $\widehat{U}$  is  $\delta_{Q_k}$ -prismatic if  $\widehat{U}|_{I^k \times \{0\}}$  is  $\delta_{Q_k}$ -prismatic;
- (c2)  $\widehat{G}_i|_{\Xi^k}$ ,  $i = 1, \dots, k$ , and  $\widehat{U}|_{\Xi^k}$  are  $\widehat{\xi}$ -prismatic.

If we have data satisfying all these conditions, then we construct a  $(k+1)$ -dimensional PL ball  $P$  as the colimit of the following diagram of solid arrows:

$$\begin{array}{ccccc}
 & & P & & \\
 & \swarrow \text{---} & \uparrow \text{---} & \nwarrow \text{---} & \\
 \Gamma^k \times I & & \Gamma^k \times I & & I^k \times I. \\
 \swarrow \text{---} & \text{id} \times \{0\} & \swarrow \text{---} & \varphi \times \{1\} & \swarrow \text{---} \\
 \Gamma^k & & \Gamma^k & & I^k \\
 \swarrow \text{---} & \text{id} \times \{1\} & \swarrow \text{---} & \text{id} \times \{0\} & \swarrow \text{---} \\
 & & & & 
 \end{array}$$

The boundary of  $P$  is assembled from two  $k$ -dimensional balls  $\Gamma^k$  and  $S$ :

$$(62) \quad \begin{array}{ccccc}
 & & S & & \\
 & \swarrow \text{---} & \uparrow \text{---} & \nwarrow \text{---} & \\
 \partial\Delta^k \times I & & \partial\Delta^k \times I & & \Xi^k. \\
 \swarrow \text{---} & \text{id} \times \{0\} & \swarrow \text{---} & \varphi \times \{1\} & \swarrow \text{---} \\
 \partial\Delta^k & & \partial\Delta^k & & \partial I^k \\
 \swarrow \text{---} & \text{id} \times \{1\} & \swarrow \text{---} & \text{id} \times \{0\} & \swarrow \text{---} \\
 & & & & 
 \end{array}$$



We define  $\tilde{G}'_i, \tilde{U}' \in \text{PL}_P(X)$  as pastings (see Sec. 7.1.1 on page 55):

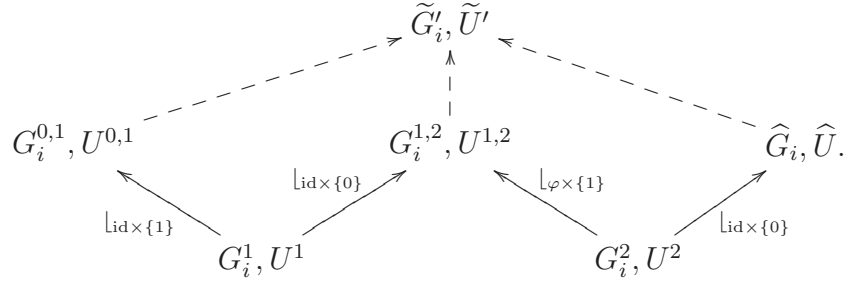

We define a topology  $\tilde{\mathcal{T}}'$  on the ball  $S$  and an Alexandroff presheaf  $(S, \tilde{\mathcal{T}}') \xrightarrow{\tilde{\xi}'} \mathbf{D}_c^\infty(K)$  as the natural pasting of the topologies and presheaves  $\mathcal{T}^{0,1}, \xi^{0,1}, \mathcal{T}^{1,2}, \xi^{1,2}$  and  $\hat{\mathcal{T}}, \hat{\xi}$  according to diagram (62). Pick a homeomorphism  $\Delta^k \times I \xrightarrow{\psi} P$  that is identical on  $\Gamma^k$  and sends  $\Delta^k \times \{1\}$  to  $S$ .

Now, if we put  $\tilde{G}_i = \tilde{G}'_i|_{\psi}$ ,  $\tilde{U} = \tilde{U}'|_{\psi}$ ,  $\tilde{\mathcal{T}} = \tilde{\mathcal{T}}'|_{\psi}$ , and  $\tilde{\xi} = \tilde{\xi}'|_{\psi}$ , then we will obtain data that satisfy conditions (1)–(4) due to conditions (a)–(c2) on the ingredients of our pasting.

2. Now we will present the ingredients required in Step 1.

2.A. Put  $G_i^{0,1} = G_i \times \text{id}$ ,  $U^{0,1} = U \times \text{id} \in \text{PL}(X)_{\Gamma^k \times I}$ . Build a dense Alexandroff topology  $\mathcal{T}^1$  on  $\partial\Delta^k$  that strengthens the topology  $\mathcal{T}$ . Such a strengthening always exists by Proposition 23 on page 50. Let  $(\partial\Delta^k, \mathcal{T}^1) \xrightarrow{w} (\partial\Delta^k, \mathcal{T})$  be the morphism of weakening the topology. Let  $I \xrightarrow{\text{inv}} I$  be the linear homeomorphism  $\text{inv}(t) = -t+1$ , so that  $\text{inv}(0) = 1$ ,  $\text{inv}(1) = 0$ . Using Proposition 31 on page 56, build a topology  $\overline{\text{Cyl}}_w$  on  $\partial\Delta^k \times I$ . Put  $\mathcal{T}^{0,1} = \overline{\text{Cyl}}_w|_{\text{inv}}$  (i.e., we change the orientation of the parameter in the construction from Proposition 31). Put  $\xi^1 = \xi \circ w$  and  $\xi^{0,1} = \overline{\text{Cyl}}_w(\xi^1 \circ w, \xi)|_{\text{inv}}$ . By Proposition 31, conditions (a), (a1), (a2) are satisfied for  $G_i^{0,1}, U^{0,1}, \xi^{0,1}$ .

2.B. Put  $G_i^{1,2} = G_i \times \text{id}$ ,  $U^{1,2} = U \times \text{id} \in \text{PL}(X)_{\Gamma^k \times I}$ . The Alexandroff topology  $\mathcal{T}^1|_{\varphi}$  is an OPL topology on  $\partial I^k$ . By the Lebesgue lemma (see [16]), there is a positive integer  $M$  such that the minimal base of the topology  $\mathcal{A}^c(\partial \frac{1}{M}[I^k])$  is inscribed into the minimal base of the topology  $\mathcal{T}^1|_{\varphi}$ . Therefore  $\mathfrak{B}(\mathcal{A}^c(\partial \frac{1}{M}[I^k])|_{\varphi^{-1}})$  is inscribed into  $\mathfrak{B}(\mathcal{T}^1)$ . Since the topology  $\mathcal{T}^1$  is dense, it follows by Proposition 15 on page 46 that there is a morphism  $\mathfrak{B}(\mathcal{A}^c(\partial \frac{1}{M}[I^k])|_{\varphi^{-1}}) \xrightarrow{\phi} \mathfrak{B}(\mathcal{T}^1)$  such that

for every  $U \in \mathfrak{B}(\mathcal{A}^c(\partial \frac{1}{M}[I^k])|_{\varphi^{-1}})$  the inclusion  $U \subset \phi(U)$  holds.

Put  $\mathcal{T}^2 = A^c(\partial \frac{1}{M}[I^k])|_{\varphi^{-1}}$ ,  $\xi^\cdot = \xi'^1 \circ \phi \circ o$ ,  $\mathcal{T}^{1,2} = \widetilde{\text{Cyl}}_\phi|_{\text{inv}}$ , and  $\xi^{1,2} = \widetilde{\text{Cyl}}_\phi(\xi^1, \xi^\cdot)|_{\text{inv}}$  (see Proposition 33 on page 59). Then, by Proposition 33, conditions (b), (b1), (b2) are satisfied for  $G_i^{1,2}, U^{1,2}, \xi^{1,2}$ .

2.C. Consider the homeomorphisms induced by  $\varphi$ :  $G^2 = G_i|_\varphi$ ,  $U^2 = U|_\varphi \in \text{PL}_{I^k}$ . We are in the conditions of Lemma 12 on page 90: the homeomorphisms  $\partial G_i^2, \partial U^2$  are prismatic with respect to the Alexandroff presheaf

$$\partial \frac{1}{M}[I^k]^{\text{op}} \xrightarrow{\xi^2 = \xi^\cdot|_\varphi} \mathbf{D}_c^\infty(K)$$

and  $(G^2)_i$  is  $\delta_{Q_k}$ -prismatic. Therefore there exists a topology  $\widehat{\mathcal{T}}$  on the upper cubic bucket  $\overline{\Xi}^k$  that extends  $\partial \mathcal{A}^c \frac{1}{M}[I^k]$ , there exists an Alexandroff presheaf  $(\overline{\Xi}^k, \widehat{\mathcal{T}}) \xrightarrow{\widehat{\xi}} \mathbf{D}_c^\infty(K)$  that extends  $\xi^2$ , there exist  $\delta_{Q_k}$ -prismatic homeomorphisms  $\widehat{G}_i, \widehat{U}$  such that  $\widehat{G}_i|_{\overline{\Xi}^k}, \widehat{U}|_{\overline{\Xi}^k}$  are  $(\widehat{\xi}^\cdot)^2$ -prismatic. If  $U^2$  is  $\delta_{Q_k}$ -prismatic, then  $\widehat{U}$  is  $\delta_{Q_k}$ -prismatic.

Therefore for  $\widehat{G}_i, \widehat{U}, \widehat{\xi}$  conditions (c), (c1), (c2) are satisfied.  $\square$

### 15.2. The proof of the lemma on common $\mathbf{R}(X)$ -triangulations of fiberwise homeomorphisms.

**Lemma 14** (The  $\frown$ -lemma for  $(\underline{\text{Prism}}^m(X) \times \text{PL}(X), \underline{\text{Prism}}^{m+1}(X))$ ). *Let  $\mathbf{B}$  be a finite simplicial ball,  $B = |\mathbf{B}|$ ,  $\mathbf{S} = \partial \mathbf{B}$ ,  $S = |\mathbf{S}|$ .*

*Let  $G_1, \dots, G_m, U \in \text{PL}_Y(X)$  be fixed. Let  $\mathcal{Q}$  be an  $\mathbf{R}(X)$ -coloring of  $\mathbf{B}$  and  $\mathcal{Q}_S$  be the induced coloring of  $\mathbf{S}$ .*

*Assume that the coloring  $\mathcal{Q}$  is an  $\mathbf{R}(X)$ -triangulation of the homeomorphisms  $G_1, \dots, G_m$ . Assume that the coloring  $\mathcal{Q}_S$  is an  $\mathbf{R}(X)$ -triangulation of  $\partial U$ .*

*Then there exist*

- a triangulation  $\mathbb{T}$  of  $B \times I$  such that  $h^0 \mathbb{T} = \mathbf{B}$ ;
- an  $\mathbf{R}(X)$ -coloring  $\widetilde{\mathcal{Q}}$  of the triangulation  $\mathbb{T}$  such that  $h^0 \widetilde{\mathcal{Q}} = \mathcal{Q}$ ;
- homeomorphisms  $\widetilde{G}_1, \dots, \widetilde{G}_m, \widetilde{U}$  such that  $h^0 \widetilde{G}_i = G_i$ ,  $h^0 \widetilde{U} = U$ ,  $\widetilde{\mathcal{Q}}$  triangulates  $\widetilde{G}_1, \dots, \widetilde{G}_m$ ,  $\widetilde{\mathcal{Q}}|_{\mathbb{T}_\Lambda}$  triangulates  $\widetilde{U}|_\Lambda$ .

Here  $\Lambda = S \times I \cup B \times \{1\}$  is the upper bucket and  $\mathbb{T}_\Lambda$  is the induced triangulation of  $\Lambda$ .

*Proof.* 1. Fix a subdivision  $\mathbf{K} \trianglelefteq \mathcal{Q}$ . Consider the ball complex  $\Xi = \mathbf{B} \times [I]$ . Define an Alexandroff presheaf  $(|\Xi|, \mathcal{A}(\Xi)) \xrightarrow{\mathcal{Q}' } \mathbf{R}(X)$  by  $\mathcal{Q}' = \text{Max} \mathcal{Q} \circ \pi_1$ .

We will define

- homeomorphisms  $G'_1, \dots, G'_m, U' \in \text{PL}_{|\Xi|}$ ;
- an OPL-topology  $\mathcal{T}$  on  $B \times \{1\}$ ;
- an Alexandroff presheaf  $(B, \mathcal{T}) \xrightarrow{\xi'} \mathbf{D}_c^\infty(K)$

such that

- $G'_1, \dots, G'_m, U'$  extend  $G_1, \dots, G_m$ ;
- $G'_1, \dots, G'_m$  are  $\mathcal{Q}'$ -prismatic;
- $U'|_{S \times I}$  are  $\mathcal{Q}'_{S \times I}$ -prismatic;
- $h_1 G'_i, h_1 U'$  are  $\xi$ -prismatic.

2. Consider the following ball subcomplexes of  $\Xi$ :  $\Xi_i = \mathbf{B}_i \cup \mathbf{B}_{i-1} \times [I]$  and  $\bar{\Xi}_i = \mathbf{B}_i \cup \mathbf{B}_i \times [I]$ , where  $\mathbf{B}_i$  is the  $i$ -skeleton. We can define  $G'_i$  and  $\xi_i$  inductively on  $\bar{\Xi}_i$ . On  $\bar{\Xi}_0$  the construction is trivial. Then we can fill the buckets of  $\bar{\Xi}_1$  using Lemma 13 and obtain required data on  $\bar{\Xi}_1$ ; continuing in this way, we construct the data announced in Step 1 of the proof.

Lemma 13

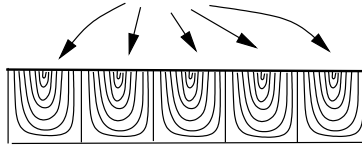

3. As a result of the constructions from Steps 1 and 2 of the proof, on  $h^1|\Xi|$  we have exactly the situation of Lemma 8 on page 67. Therefore there is a triangulation  $\mathcal{V} \triangleleft h^1\Xi$  such that the associated common triangulation of the homeomorphisms  $\mathcal{V}$  allows pasting the construction from Lemma 8. To complete the proof, it remains to use Proposition 34 on page 60 for extending the triangulation  $\mathcal{V}$  to a triangulation of  $G'_1, \dots, G'_m, U'$  that does not change the triangulation  $\mathcal{Q}$ .

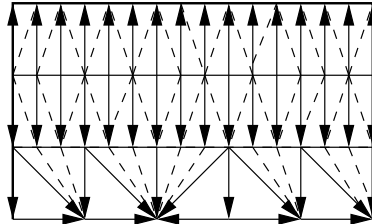

□

16. THE CASE OF COMBINATORIAL MANIFOLDS, THEOREM B

The proof of Theorem B comes from the fact that all our arguments remain valid if we replace the poset  $\mathbf{R}(X)$  by  $\mathbf{T}(X)$  and the category  $\mathfrak{R}(X)$  by  $\mathfrak{T}(X)$ . Only one place in the arguments should be specially tuned: the reference to Lemma 6 in Step 3 (p. 68) of the proof of Lemma 8 should be replaced by the reference to Lemma 7. That is, we should use the procedure of inscribing small balls into combinatorial manifolds, which is slightly more complicated than inscribing small balls into general ball complexes.

17. COMBINATORIAL MODELS FOR  $PL_n$  FIBER BUNDLES, THE TANGENT BUNDLE AND GAUSS MAP OF COMBINATORIAL MANIFOLDS

Milnor [25] defined the group  $PL_n$  as the simplicial group of germs at the zero section of PL homeomorphisms of  $\mathbb{R}^n$ . In this section, we use the Kuiper–Lashof models for  $PL_n$  fiber bundles [17, 18]. Denote by  $PL((\mathbb{R}^n, 0))$  the simplicial group of origin-preserving PL homeomorphisms of  $\mathbb{R}^n$ . Denote by  $PL(S^n, 0, \infty)$  the simplicial group of PL-homeomorphisms of the sphere  $S^n$  preserving two different points “0” and “ $\infty$ .” Denote by  $PL(S^n, \infty)$  the simplicial group of PL-homeomorphisms of  $S^n$  preserving a single point “ $\infty$ .” It is proved in [18] (Lemma 1.6 at p. 248 and Lemma 1.8 at p. 249) that in the row of natural homomorphisms of simplicial groups

$$(63) \quad PL((\mathbb{R}^n, 0)) \xrightarrow{\alpha} PL_n \xleftarrow{\beta} PL(S^n, 0, \infty) \xrightarrow{\gamma} PL((S^n, \infty)),$$

all homomorphisms are simplicial homotopy equivalences. In (63), the homomorphism  $\alpha$  sends a homeomorphism of  $(\mathbb{R}^n, 0)$  to its germ at 0, the homomorphism  $\beta$  sends a homeomorphism of  $(S^n, 0, \infty)$  to its germ at 0, and  $\gamma$  is the embedding. The simplicial groups of homeomorphisms

$$PL((\mathbb{R}^n, 0)), \quad PL(S^n, 0, \infty), \quad PL((S^n, \infty))$$

are the structure groups of PL fiber bundles with marked sections. The group  $PL(\mathbb{R}^n, 0)$  corresponds to fiber bundles with fiber  $\mathbb{R}^n$  and zero section, the group  $PL((S^n, \infty))$  corresponds to fiber bundles with fiber  $S^n$  and marked  $\infty$ -section, and the group  $PL((S^n, 0, \infty))$  corresponds to fiber bundles with fiber  $S^n$  and two sections 0 and  $\infty$  that have no common points. The group  $PL_n$  corresponds to germs of  $\mathbb{R}^n$ -bundles near the zero section. The chain (63) of simplicial homotopy equivalences generates a chain of homotopy equivalences of classifying spaces

$$(64) \quad BPL((\mathbb{R}^n, 0)) \approx BPL_n \approx BPL(S^n, 0, \infty) \approx BPL((S^n, \infty)).$$

**Theorem 3** (Kuiper–Lashof theorem on models of  $\text{PL}_n$  bundles). *There exist functorial one-to-one correspondences between isomorphism classes of Milnor PL microbundles and isomorphism classes of the following PL fiber bundles:*

- (i) *with fiber  $\mathbb{R}^n$  and zero section,*
- (ii) *with fiber  $S^n$  and a marked section,*
- (iii) *with fiber  $S^n$  and two marked sections that have no common points.*

**17.1. Proof of Theorem C.** By the Kuiper–Lashof theory, it suffices to prove that

$$(65) \quad B\mathfrak{R}_n \approx B\text{PL}(S^n, \infty).$$

We will indicate how we should tweak our general constructions to obtain the proof of (65).

Consider the  $n$ -dimensional PL sphere  $S^n$  with a fixed point marked by “ $\infty$ .” Consider the subposet  $\mathbf{R}_n$  of the poset  $\mathbf{R}(S^n)$  (see Sec. 2.6 on page 17) formed by all ball complexes having  $\infty$  in the interior of a maximal ball. This ball will be called “marked.” Consider the functor  $\mathbf{R}_n \xrightarrow{\mathbf{P}} \mathfrak{R}_n$  sending the marked ball to the marked combinatorial ball. Consider an  $m$ -simplex

$$\mathbf{Q} = \mathbf{Q}_0 \trianglelefteq \mathbf{Q}_1 \trianglelefteq \dots \trianglelefteq \mathbf{Q}_m$$

of the simplicial set  $\mathcal{N}\mathbf{R}_n$ . Build (see Sec. 3.1 on page 20) the structure of the cellular bundle  $\mathbf{T}(\mathbf{Q}) \xrightarrow{e(\mathbf{Q})} [\Delta^m]$  on the trivial fibration  $S^n \times \Delta^m \xrightarrow{\pi_2} \Delta^m$  and, additionally, mark the constant section  $\infty_m = \{\infty\} \times \Delta^m \subset S^n \times \Delta^m$ . Denote by  $e^\infty(\mathbf{Q})$  the pair  $\langle e(\mathbf{Q}), \infty_m \rangle$ . There exists one “marked” prism  $\mathbf{T}(\mathbf{Q})$  (see Sec. 4 on page 21) that contains the section  $\infty_m$ . A  $\mathbf{Q}$ -prismatic homeomorphism  $G \in \text{PL}(S^n, \infty)$  (see Sec. 3.2.2 on page 22) is naturally defined. By construction, a  $\mathbf{Q}$ -prismatic homeomorphism preserves  $\infty_m$  and sends the marked prism to the marked prism. We obtain the groupoid  $\text{Prism}(S^n, \infty)$  of prismatic homeomorphisms, which is a subgroupoid of  $\text{Prism}(S^n)$  (see Sec. 3.2.3). For  $\text{Prism}(S^n, \infty)$ -homeomorphisms, Lemma 3 is valid, with an additional observation that we can force the parametric Alexander trick to respect one fixed section (this is equivalent to the fact that  $\text{PL}(D^n, 0, \partial)$  is contractible, see [18, Lemma 1.4, p. 248]). Such a version of Lemma 3 is sufficient for the validity of all arguments concerning the  $\mathcal{W}$ -construction for  $\text{Prism}(S^n, \infty)$  and  $\text{PL}(S^n, \infty)$  from Secs. 3.3–3.7 and Sec. 4. Therefore the proof of (65) is reduced to the following wording of the geometric Lemma 5 on page 35:

*the pair*

$$|(\underline{\text{Prism}}^{N-1}(S^n, \infty) \times \text{PL}(S^n, \infty)|, |\underline{\text{Prism}}^N(S^n, \infty)|)$$

*is homotopy trivial.*

This lemma is automatically proved by all our constructions of fragmentation and surgery, since the scheme of fragmentation of fiberwise homeomorphisms from Secs. 8–14 and all surgery of generalized prismatic homeomorphisms from Sec. 6 respect all fixed sections. We should make two remarks on the choice of triangulations. In Lemma 12 on page 90 we should make sure that the triangulation  $K \trianglelefteq Q \in \mathbf{R}(S^n, \infty)$  contains the point  $\infty$  as a vertex. Then the configurations of small closed balls from Sec. 13 will involve either balls containing the point  $\infty$  in the interior or balls that do not touch this point at all. Therefore the construction of Lemma 6 on page 63 will not lead us out of  $\mathbf{R}_n$  provided that we take care of the following: all common triangulations that appear in the proof of Lemma 6 should be performed inside  $\mathbf{R}_n$ , which is always possible.

### 17.2. Theorem D.

17.2.1. *Milnor’s tangent microbundle.* Traditionally, the tangent bundle of a PL manifold  $M^n$  is defined as the tangent microbundle [25]. The tangent microbundle is constructed as follows.

Consider the square  $M^n \times M^n$  of the manifold, the projection  $M^n \times M^n \xrightarrow{t} M^n$  to the first argument, and the section  $M \xrightarrow{0_t} M^n \times M^n: 0_t(x) = (x, x)$ . The **tangent microbundle of  $M^n$**  is the germ of  $t$  at the section  $0_t$ . According to the Kuiper–Lashof theory, there is a unique, up to isomorphism,  $(S^n, 0, \infty)$ -bundle  $t_M^{0, \infty}$  on  $M^n$  such that its germ at the zero section is isomorphic to  $t$ . The fiber bundle  $t_M^{0, \infty}$  will be called the tangent  $(S^n, 0, \infty)$ -bundle of  $M^n$ . For the tangent  $(S^n, 0, \infty)$ -bundle, there is a unique, up to isomorphism,  $(S^n, \infty)$ -bundle  $t_M^\infty$  (just forget the 0-section). This fiber bundle will be called the tangent  $(S^n, \infty)$ -bundle of  $M^n$ . These correspondences are one-to-one correspondences of isomorphism classes. This means that the Gauss maps

$$(66) \quad M^n \xrightarrow{G} BPL_n, \quad M^n \xrightarrow{G^{0, \infty}} BPL(S^n, 0, \infty), \quad M^n \xrightarrow{G^\infty} BPL(S^n, \infty)$$

of the tangent bundles  $t_M, t_M^{0, \infty}, t_M^\infty$  coincide up to homotopy after the identification (64).

17.2.2. *The proof of Theorem D.* According to (65),  $B\mathfrak{R}_n \approx BPL(S^n \infty)$ . Therefore for any locally ordered simplicial complex  $K$  with an  $\mathfrak{R}_n$ -coloring  $iK \xrightarrow{\mathcal{Q}} \mathbf{dN}\mathfrak{R}_n$  (see Sec. 4.2 on page 35),  $|K| \xrightarrow{|\mathcal{Q}|} B\mathfrak{R}_n$  is the Gauss map for the  $(S^n, \infty)$ -bundle  $e^\infty(\mathcal{Q})$ , where  $e^\infty(\mathcal{Q})$  is pasted (Sec. 3.4.2 on page 31) from prismatic trivializations of  $e^\infty(\mathcal{Q})$  over the simplices of  $K$  (Sec. 17.1 on the previous page).

To prove Theorem D, it suffices to associate with the functor  $\mathbf{G}$  an  $(S^n, 0, \infty)$ -bundle  $e^{0,\infty}(\mathbf{G})$  such that

- (i) forgetting the 0-section  $e^{0,\infty}(\mathbf{G})$  yields the bundle  $e^\infty(\mathbf{G})$ ;
- (ii) the germ of  $e^{0,\infty}(\mathbf{G})$  at the zero section is isomorphic to  $t_M$ .

This can be achieved by the obvious special choice of prismatic trivializations associated with Milnor's diagonal construction during the construction of  $e^\infty(\mathbf{G})$ .

#### REFERENCES

- [1] D. Abramovich, K. Karu, K. Matsuki, and J. Włodarczyk. Torification and factorization of birational maps. *J. Amer. Math. Soc.*, **15**, No. 3, 531–572, 2002.
- [2] J. W. Alexander. The combinatorial theory of complexes. *Ann. of Math. (2)*, **31**, No. 2, 292–320, 1930.
- [3] P. S. Alexandroff. Discrete Räume. *Mat. Sb. (N.S.)*, **2**, 501–518, 1937.
- [4] L. Anderson and N. Mnev. Triangulations of manifolds and combinatorial bundle theory: an announcement. *Zap. Nauchn. Semin. POMI*, **267**, 46–52, 2000.
- [5] F. G. Arenas. Alexandroff spaces. *Acta Math. Univ. Comenian. (N.S.)*, **68**, No. 1, 17–25, 1999.
- [6] D. K. Biss. The homotopy type of the matroid Grassmannian. *Ann. of Math. (2)*, **158**, No. 3, 929–952, 2003.
- [7] A. Björner. Posets, regular CW complexes and Bruhat order. *European J. Combin.*, **5**, No. 1, 7–16, 1984.
- [8] E. H. Brown, Jr. Cohomology theories. *Ann. of Math. (2)*, **75**, 467–484, 1962.
- [9] A. J. Casson. Generalisations and applications of block bundles. In: *The Hauptvermutung book*. Kluwer Acad. Publ., Dordrecht, 1996, pp. 33–67.
- [10] M. M. Cohen. Simplicial structures and transverse cellularity. *Ann. of Math. (2)*, **85**, 218–245, 1967.
- [11] P. G. Goerss and J. F. Jardine. *Simplicial Homotopy Theory*. Birkhäuser Verlag, Basel, 1999.
- [12] A. E. Hatcher. Higher simple homotopy theory. *Ann. of Math. (2)*, **102**, No. 1, 101–137, 1975.
- [13] A. E. Hatcher. A proof of a Smale conjecture,  $\text{Diff}(S^3) \simeq \text{O}(4)$ . *Ann. of Math. (2)*, **117**, No. 3, 553–607, 1983.
- [14] A. Heller. Homotopy resolutions of semi-simplicial complexes. *Trans. Amer. Math. Soc.*, **80**, 299–344, 1955.
- [15] J. F. P. Hudson. *Piecewise Linear Topology*. W. A. Benjamin, Inc., New York–Amsterdam, 1969.
- [16] J. L. Kelley. *General Topology*. Van Nostrand Company, Inc., Toronto–New York–London, 1955.
- [17] N. H. Kuiper and R. K. Lashof. Microbundles and bundles. I. Elementary theory. *Invent. Math.*, **1**, 1–17, 1966.
- [18] N. H. Kuiper and R. K. Lashof. Microbundles and bundles. II. Semisimplicial theory. *Invent. Math.*, **1**, 243–259, 1966.
- [19] N. Levitt. *Grassmannians and Gauss Maps in Piecewise-Linear Topology*. Lecture Notes Math., Vol. 1366. Springer-Verlag, Berlin, 1989.
- [20] J.-L. Loday. *Cyclic Homology*, 2nd edition. Springer-Verlag, Berlin, 1998.

- [21] A. Lundell and S. Weingram. *The Topology of CW-Complexes*. Van Nostrand Reinhold, New York, 1969.
- [22] J. P. May. *Classifying Spaces and Fibrations*. Mem. Amer. Math. Soc., **1**, No. 155, 1975.
- [23] M. C. McCord. Singular homology groups and homotopy groups of finite topological spaces. *Duke Math. J.*, **33**, 465–474, 1966.
- [24] D. McDuff. On the classifying spaces of discrete monoids. *Topology*, **18**, No. 4, 313–320, 1979.
- [25] J. Milnor. *Microbundles and Differential Structures* (Mimeographed notes). Princeton University, September 1961.
- [26] N. Mněv. On D.K. Biss' papers "The homotopy type of the matroid Grassmannian" and "Oriented matroids, complex manifolds, and a combinatorial model for BU". arXiv:0709.1291 [math.CO], 2007.
- [27] N. E. Mněv and G. M. Ziegler. Combinatorial models for the finite-dimensional Grassmannians. *Discrete Comput. Geom.*, **10**, No. 3, 241–250, 1993.
- [28] R. Morelli. The birational geometry of toric varieties. *J. Algebraic Geom.*, **5**, No. 4, 751–782, 1996.
- [29] D. Quillen. Homotopy properties of the poset of nontrivial  $p$ -subgroups of a group. *Adv. Math.*, **28**, No. 2, 101–128, 1978.
- [30] C. M. Rourke and B. J. Sanderson.  $\Delta$ -sets I: Homotopy theory. *Quart. J. Math.*, **22**, 321–338, 1971.
- [31] C. P. Rourke and B. J. Sanderson. *Introduction to Piecewise-Linear Topology*. Springer-Verlag, New York, 1972.
- [32] M. Steinberger. The classification of PL fibrations. *Michigan Math. J.*, **33**, No. 1, 11–26, 1986.
- [33] J. H. C. Whitehead. Simplicial spaces, nuclei and  $m$ -groups. *Proc. London Math. Soc.*, **45**, 243–327, 1939.
- [34] E. C. Zeeman. *Seminar on Combinatorial Topology* (Mimeographed notes), I.H.E.S., Paris, 1963.
- [35] E. C. Zeeman. Relative simplicial approximation. *Proc. Cambridge Philos. Soc.*, **60**, 39–43, 1964.